

[MS-RDPRFX]: Remote Desktop Protocol: RemoteFX Codec Extension

Intellectual Property Rights Notice for Open Specifications Documentation

- **Technical Documentation.** Microsoft publishes Open Specifications documentation for protocols, file formats, languages, standards as well as overviews of the interaction among each of these technologies.
- **Copyrights.** This documentation is covered by Microsoft copyrights. Regardless of any other terms that are contained in the terms of use for the Microsoft website that hosts this documentation, you may make copies of it in order to develop implementations of the technologies described in the Open Specifications and may distribute portions of it in your implementations using these technologies or your documentation as necessary to properly document the implementation. You may also distribute in your implementation, with or without modification, any schema, IDL's, or code samples that are included in the documentation. This permission also applies to any documents that are referenced in the Open Specifications.
- **No Trade Secrets.** Microsoft does not claim any trade secret rights in this documentation.
- **Patents.** Microsoft has patents that may cover your implementations of the technologies described in the Open Specifications. Neither this notice nor Microsoft's delivery of the documentation grants any licenses under those or any other Microsoft patents. However, a given Open Specification may be covered by Microsoft [Open Specification Promise](#) or the [Community Promise](#). If you would prefer a written license, or if the technologies described in the Open Specifications are not covered by the Open Specifications Promise or Community Promise, as applicable, patent licenses are available by contacting iplg@microsoft.com.
- **Trademarks.** The names of companies and products contained in this documentation may be covered by trademarks or similar intellectual property rights. This notice does not grant any licenses under those rights. For a list of Microsoft trademarks, visit www.microsoft.com/trademarks.
- **Fictitious Names.** The example companies, organizations, products, domain names, email addresses, logos, people, places, and events depicted in this documentation are fictitious. No association with any real company, organization, product, domain name, email address, logo, person, place, or event is intended or should be inferred.

Reservation of Rights. All other rights are reserved, and this notice does not grant any rights other than specifically described above, whether by implication, estoppel, or otherwise.

Tools. The Open Specifications do not require the use of Microsoft programming tools or programming environments in order for you to develop an implementation. If you have access to Microsoft programming tools and environments you are free to take advantage of them. Certain Open Specifications are intended for use in conjunction with publicly available standard specifications and network programming art, and assumes that the reader either is familiar with the aforementioned material or has immediate access to it.

Revision Summary

Date	Revision History	Revision Class	Comments
04/23/2010	0.1	Major	First Release.
06/04/2010	1.0	Major	Updated and revised the technical content.
07/16/2010	1.0	No change	No changes to the meaning, language, or formatting of the technical content.
08/27/2010	2.0	Major	Significantly changed the technical content.
10/08/2010	3.0	Major	Significantly changed the technical content.
11/19/2010	4.0	Major	Significantly changed the technical content.
01/07/2011	5.0	Major	Significantly changed the technical content.
02/11/2011	6.0	Major	Significantly changed the technical content.
03/25/2011	7.0	Major	Significantly changed the technical content.
05/06/2011	8.0	Major	Significantly changed the technical content.
06/17/2011	9.0	Major	Significantly changed the technical content.
09/23/2011	10.0	Major	Significantly changed the technical content.
12/16/2011	11.0	Major	Significantly changed the technical content.
03/30/2012	12.0	Major	Significantly changed the technical content.
07/12/2012	13.0	Major	Significantly changed the technical content.
10/25/2012	14.0	Major	Significantly changed the technical content.
01/31/2013	15.0	Major	Significantly changed the technical content.
08/08/2013	15.0	No change	No changes to the meaning, language, or formatting of the technical content.
11/14/2013	15.0	No change	No changes to the meaning, language, or formatting of the technical content.
02/13/2014	16.0	Major	Significantly changed the technical content.
05/15/2014	16.0	No change	No changes to the meaning, language, or formatting of the technical content.

Contents

1 Introduction	6
1.1 Glossary	6
1.2 References	6
1.2.1 Normative References	6
1.2.2 Informative References	7
1.3 Protocol Overview (Synopsis)	7
1.3.1 RemoteFX Codec	7
1.3.1.1 Message Flows	8
1.4 Relationship to Other Protocols	10
1.5 Prerequisites/Preconditions	10
1.6 Applicability Statement	11
1.7 Versioning and Capability Negotiation	11
1.8 Vendor-Extensible Fields	11
1.9 Standards Assignments	11
2 Messages	12
2.1 Transport	12
2.2 Message Syntax	12
2.2.1 Capabilities Messages	12
2.2.1.1 TS_RFX_CLNT_CAPS_CONTAINER	12
2.2.1.1.1 TS_RFX_CAPS	13
2.2.1.1.1.1 TS_RFX_CAPSET	13
2.2.1.1.1.1.1 TS_RFX_ICAP	14
2.2.1.2 TS_RFX_SRVR_CAPS_CONTAINER	15
2.2.1.3 TS_FRAME_ACKNOWLEDGE_CAPABILITYSET	15
2.2.2 Encode Messages	16
2.2.2.1 Common Data Types	16
2.2.2.1.1 TS_RFX_BLOCKT	16
2.2.2.1.2 TS_RFX_CODECT_CHANNELT	17
2.2.2.1.3 TS_RFX_CHANNELT	18
2.2.2.1.4 TS_RFX_CODECT_VERSIONT	18
2.2.2.1.5 TS_RFX_CODECT_QUANT	18
2.2.2.1.6 TS_RFX_RECT	19
2.2.2.2 Encode Header Messages	20
2.2.2.2.1 TS_RFX_SYNC	20
2.2.2.2.2 TS_RFX_CODECT_VERSIONS	20
2.2.2.2.3 TS_RFX_CHANNELS	21
2.2.2.2.4 TS_RFX_CONTEXT	21
2.2.2.3 Encode Data Messages	22
2.2.2.3.1 TS_RFX_FRAME_BEGIN	22
2.2.2.3.2 TS_RFX_FRAME_END	23
2.2.2.3.3 TS_RFX_REGION	23
2.2.2.3.4 TS_RFX_TILESET	24
2.2.2.3.4.1 TS_RFX_TILE	26
2.2.3 Control Messages	27
2.2.3.1 TS_FRAME_ACKNOWLEDGE_PDU	27
3 Protocol Details	30
3.1 Common Details	30
3.1.1 Abstract Data Model	30

3.1.1.1	State Machine	30
3.1.2	Timers	32
3.1.3	Initialization	32
3.1.4	Higher-Layer Triggered Events.....	32
3.1.5	Processing Events and Sequencing Rules.....	32
3.1.5.1	Processing the TS_RFX_CLNT_CAPS_CONTAINER Message	33
3.1.6	Timer Events	33
3.1.7	Other Local Events	33
3.1.8	RemoteFX Algorithm.....	33
3.1.8.1	Encoding	33
3.1.8.1.1	Input Tiling.....	34
3.1.8.1.2	Differencing (Optional).....	34
3.1.8.1.3	Color Conversion (RGB to YCbCr)	34
3.1.8.1.4	DWT	35
3.1.8.1.5	Quantization.....	36
3.1.8.1.6	Linearization.....	37
3.1.8.1.7	RLGR Entropy Encoding	38
3.1.8.1.7.1	RLGR1	38
3.1.8.1.7.2	RLGR3	39
3.1.8.1.7.3	RLGR1/RLGR3 Pseudocode	39
3.1.8.1.7.3.1	RLGR1/RLGR3 Decode	39
3.1.8.1.7.3.2	RLGR1/RLGR3 Encode	43
3.1.8.2	Decoding	47
3.1.8.2.1	RLGR Entropy Decoding	47
3.1.8.2.2	Sub-Band Reconstruction	47
3.1.8.2.3	Dequantization	47
3.1.8.2.4	Inverse DWT	48
3.1.8.2.5	Color Conversion (YCbCr to RGB)	48
3.1.8.2.6	Reconstructed Frame.....	48
3.1.8.3	RemoteFX Stream.....	48
3.1.8.3.1	Encode Message Sequencing	48
4	Protocol Examples.....	51
4.1	Sample Use Case.....	51
4.2	Annotated RemoteFX Messages	52
4.2.1	Capabilities Messages	52
4.2.2	Encode Header Messages	53
4.2.3	Encode Data Messages.....	54
4.2.4	Sample Decode Data Flow Sequence.....	57
4.2.4.1	Input TS_RFX_TILESET Message	57
4.2.4.2	Entropy Decoded Data.....	61
4.2.4.2.1	Y Component Data	62
4.2.4.2.2	Cb Component Data	66
4.2.4.2.3	Cr Component Data.....	71
4.2.4.3	Inverse Quantization/DWT	75
4.2.4.3.1	Level 3 Sub-bands.....	75
4.2.4.3.1.1	LL3	75
4.2.4.3.1.2	HL3	76
4.2.4.3.1.3	LH3	76
4.2.4.3.1.4	HH3	76
4.2.4.3.1.5	Inverse DWT-X (LL3 - HL3).....	77
4.2.4.3.1.6	Inverse DWT-X (LH3 - HH3)	77
4.2.4.3.1.7	Inverse DWT-Y (L2 - H2)	77

4.2.4.3.2	Level 2 Sub-bands.....	78
4.2.4.3.2.1	LL2	78
4.2.4.3.2.2	HL2	78
4.2.4.3.2.3	LH2	79
4.2.4.3.2.4	HH2	80
4.2.4.3.2.5	Inverse DWT-X (LL2 - HL2)	80
4.2.4.3.2.6	Inverse DWT-X (LH2 - HH2).....	82
4.2.4.3.2.7	Inverse DWT-Y (L1 - H1)	83
4.2.4.3.3	Level 1 Sub-bands.....	85
4.2.4.3.3.1	LL1	85
4.2.4.3.3.2	HL1	85
4.2.4.3.3.3	LH1	88
4.2.4.3.3.4	HH1	90
4.2.4.3.3.5	Inverse DWT-X (LL1 - HL1).....	92
4.2.4.3.3.6	Inverse DWT-X (LH1 - HH1).....	97
4.2.4.3.3.7	Inverse DWT-Y (L0 - H0)	101
4.2.4.3.4	Reconstructed Y Component	110
4.2.4.3.5	Reconstructed Cb Component	110
4.2.4.3.6	Reconstructed Cr Component.....	119
4.2.4.4	Inverse Color Conversion.....	128
4.2.4.5	Decoded Image	137
5	Security.....	138
5.1	Security Considerations for Implementers.....	138
5.2	Index of Security Parameters	138
6	Appendix A: Product Behavior	139
7	Change Tracking.....	140
8	Index	141

1 Introduction

The Remote Desktop Protocol: RemoteFX Codec Extension is an extension to the Remote Desktop Protocol: Basic Connectivity and Graphics Remoting (as specified in [\[MS-RDPBCGR\]](#)). The RemoteFX Codec Extension specifies a lossy image codec that can be used to encode screen images by using efficient and effective compression.

Sections 1.8, 2, and 3 of this specification are normative and can contain the terms MAY, SHOULD, MUST, MUST NOT, and SHOULD NOT as defined in RFC 2119. Sections 1.5 and 1.9 are also normative but cannot contain those terms. All other sections and examples in this specification are informative.

1.1 Glossary

The following terms are defined in [\[MS-GLOS\]](#):

little-endian

The following terms are specific to this document:

blit: Also known as block image transfer. An operation in which a rectangular block of pixels in a source image is copied onto a destination image.

discrete wavelet transform (DWT): A discrete wavelet transform is a mathematical procedure that can be used to derive a discrete representation of a signal.

entropy coding: A lossless data compression scheme used to generate compression codes for input symbols based on their statistical properties.

quantization: A technique used to reduce a range of values to a single representative value.

tile-based transform: A transform technique in which an input image is segmented into a grid of disjoint tiles and the transform is then applied separately to each individual tile.

YCbCr color space: A color space where each color is represented as a triplet (Y,Cb,Cr), where Y stands for the Luma (brightness) component and Cb,Cr stand for the two Chroma (color) components.

MAY, SHOULD, MUST, SHOULD NOT, MUST NOT: These terms (in all caps) are used as described in [\[RFC2119\]](#). All statements of optional behavior use either MAY, SHOULD, or SHOULD NOT.

1.2 References

References to Microsoft Open Specifications documentation do not include a publishing year because links are to the latest version of the documents, which are updated frequently. References to other documents include a publishing year when one is available.

1.2.1 Normative References

We conduct frequent surveys of the normative references to assure their continued availability. If you have any issue with finding a normative reference, please contact dochelp@microsoft.com. We will assist you in finding the relevant information.

[ARLGR] Malvar, H.S., "Adaptive Run-Length / Golomb-Rice Encoding of Quantized Generalized Gaussian Sources with Unknown Statistics", Proceedings of the Data Compression Conference, 2006 (DCC 2006) pp. 23 - 32, March 2006, <http://ieeexplore.ieee.org/stamp/stamp.jsp?arnumber=1607237>

[MS-RDPBCGR] Microsoft Corporation, "[Remote Desktop Protocol: Basic Connectivity and Graphics Remoting](#)".

[RFC2119] Bradner, S., "Key words for use in RFCs to Indicate Requirement Levels", BCP 14, RFC 2119, March 1997, <http://www.rfc-editor.org/rfc/rfc2119.txt>

[T123] ITU-T, "Network-Specific Data Protocol Stacks for Multimedia Conferencing", Recommendation T.123, May 1999, <http://www.itu.int/rec/T-REC-T.123/en>

Note There is a charge to download the specification.

[T125] ITU-T, "Multipoint Communication Service Protocol Specification", Recommendation T.125, February 1998, <http://www.itu.int/rec/T-REC-T.125-199802-I/en>

Note There is a charge to download the specification.

[X224] ITU-T, "Information technology - Open Systems Interconnection - Protocol for Providing the Connection-Mode Transport Service", Recommendation X.224, November 1995, <http://www.itu.int/rec/T-REC-X.224-199511-I/en>

Note There is a charge to download the specification.

1.2.2 Informative References

[MS-GLOS] Microsoft Corporation, "[Windows Protocols Master Glossary](#)".

1.3 Protocol Overview (Synopsis)

The Remote Desktop Protocol: RemoteFX Codec Extension reduces the bandwidth associated with desktop remoting by efficiently compressing images. This is achieved by using the RemoteFX codec. The following sections provide an overview of this codec.

1.3.1 RemoteFX Codec

One of the core requirements of desktop remoting is the ability to efficiently compress server-side screen images so that they can be transported over a network and displayed on a client screen. Any codec used for this purpose needs to be able to deliver effective compression (to reduce network bandwidth requirements) and operate with low-latency (to enable efficient interactions with remoted content). A typical desktop screen contains textual content (synthetic images) along with video and photographic content (natural images). Given the sensitivity of the human eye to the sharp features present in textual content, any applied compression has to be visually lossless; otherwise the text will appear blurred.

The RemoteFX codec has been designed to achieve efficient compression, satisfying the goals of high quality and low latency while using a modest amount of computing resources. It is a **tile-based transform** codec. The transform chosen was a **discrete wavelet transform (DWT)** because it enables superior compression performance when compressing textual bitmap regions at high quality. The **entropy coding** is performed using the Run-Length Golomb-Rice Coder (RLGR) ([ARLGR] section 3), which yields compression gains at relatively low computing requirements. The core functional blocks of the RemoteFX codec are shown in the following diagram.

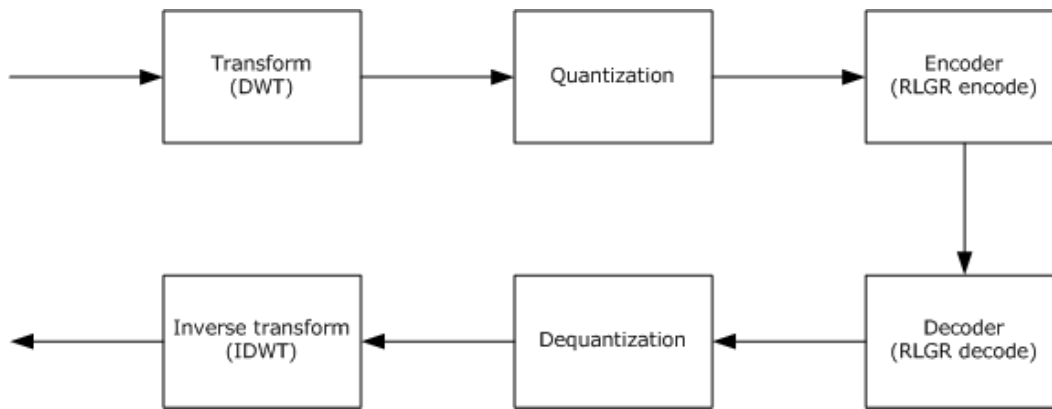

Figure 1: Core functional blocks of the RemoteFX codec

1.3.1.1 Message Flows

RemoteFX codec messages must be transported in order over a lossless transport such as TCP/IP. The message syntax has been designed with this prerequisite.

There are two types of messages: (1) capability messages sent from the client to the server; and (2) encode stream messages sent from the server to the client. The encode stream messages can be broadly categorized as header or data messages. The syntax of each message is described in detail in section 2. Processing events and sequencing rules are described in section 3.

The message sequence is depicted in the following diagram. Note that the messages in this diagram are encapsulated in RDP wire structures (described in [MS-RDPBCGR] section 2.2) when sent on the wire – for the sake of simplicity only the RemoteFX messages are shown. The encapsulating RDP structures are referenced in sections 2 and 3 when describing the structure and processing of the RemoteFX messages.

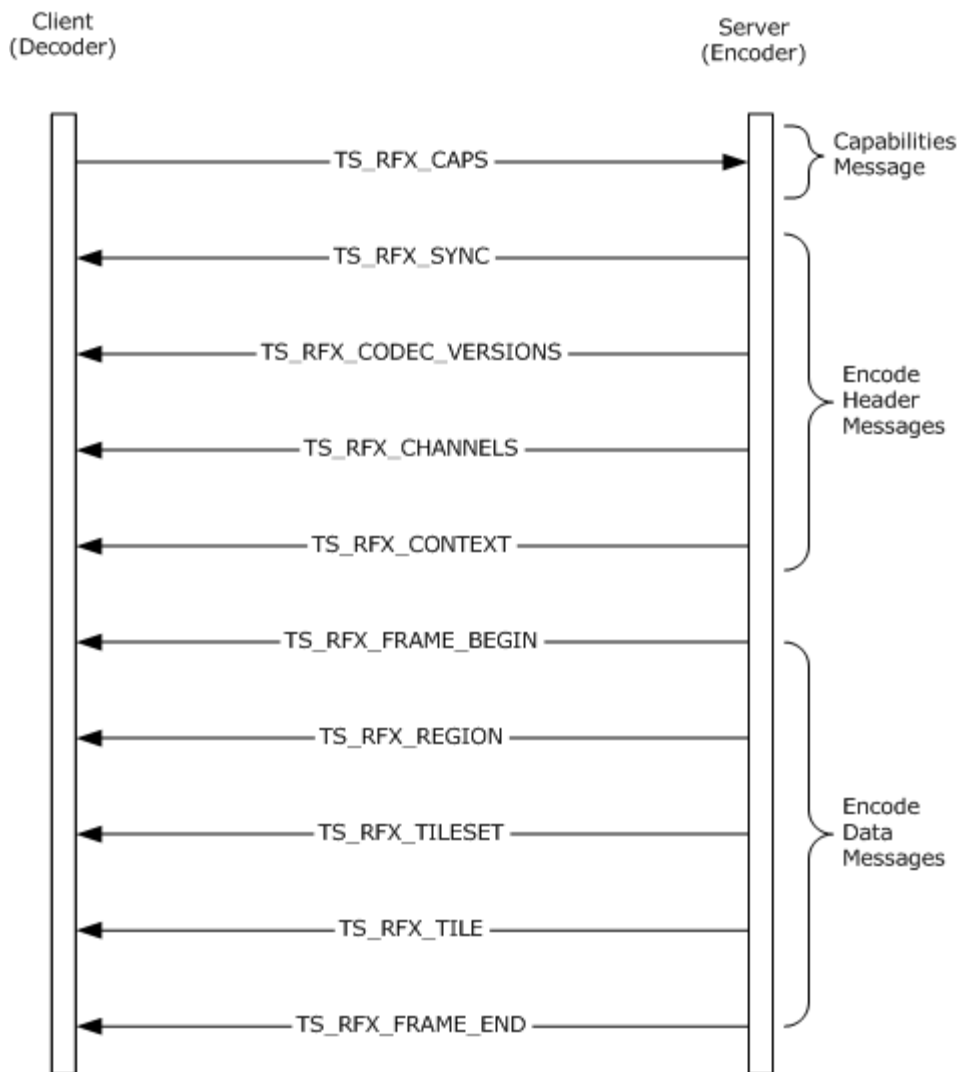

Figure 2: The RemoteFX message sequence

The client initiates the session by sending a TS_RFX_CAPS Capabilities message (section [2.2.1.1](#)). This is the only message sent from the client to the server; it lists the client-side support and preferences for various RemoteFX codec properties.

The server initializes its encoding state based on the client Capabilities message. It starts the encoding stream (section [2.2.2](#)) by sending a sequence of Header Messages (section [2.2.2.2](#)) that inform the client of the RemoteFX properties selected by the server:

1. The TS_RFX_SYNC message (section [2.2.2.2.1](#)) contains the RemoteFX magic number and the version of the wire format.
2. The TS_RFX_CODEEC_VERSIONS message (section [2.2.2.2.2](#)) contains the version of the RemoteFX codec.
3. The TS_RFX_CHANNELS message (section [2.2.2.2.3](#)) lists the channel or multi-monitor information.

4. The TS_RFX_CONTEXT message (section [2.2.2.4](#)) contains the encoding properties of the stream.

The header messages are followed by the Data messages (section [2.2.2.3](#)), which represent the sequence of encoded frames in the stream:

1. The TS_RFX_FRAME_BEGIN and TS_RFX_FRAME_END messages (sections [2.2.2.3.1](#) and [2.2.2.3.2](#) respectively) are used to demarcate an encoded frame.
2. The TS_RFX_REGION message (section [2.2.2.3.3](#)) contains the list of rectangles that have been encoded.
3. The TS_RFX_TILESET message (section [2.2.2.3.4](#)) encapsulates the list of tiles that have been encoded.

1.4 Relationship to Other Protocols

This protocol extends the Remote Desktop Protocol: Basic Connectivity and Graphics Remoting [[MS-RDPBCGR](#)] by adding advanced compression techniques.

1.5 Prerequisites/Preconditions

The following capabilities are mandatory when used with RemoteFX:

- The client MUST support fast-path graphics output ([\[MS-RDPBCGR\]](#) section 2.2.9.1.2) and acknowledge this support by specifying the FASTPATH_OUTPUT_SUPPORTED (0x0001) flag in the General Capability Set ([\[MS-RDPBCGR\]](#) section [2.2.7.1.1](#)).
- The client MUST send the [Multifragment Update Capability Set](#) ([\[MS-RDPBCGR\]](#) section 2.2.7.2.6). The **MaxRequestSize** field in the client-to-server [Multifragment Update Capability Set](#) MUST be set to a value greater than or equal to the value in the **MaxRequestSize** field of the server-to-client [Multifragment Update Capability Set](#). The client-to-server [Multifragment Update Capability Set](#) is transported in the [Confirm Active PDU](#) as specified in [\[MS-RDPBCGR\]](#) section 2.2.1.13.2, and the server-to-client [Multifragment Update Capability Set](#) is transported in the [Demand Active PDU](#) as specified in [\[MS-RDPBCGR\]](#) section 2.2.1.13.1.
- The client MUST send the [Large Pointer Capability Set](#) ([\[MS-RDPBCGR\]](#) section 2.2.7.2.7) and the LARGE_POINTER_FLAG_96x96 (0x00000001) MUST be present in the **largePointerSupportFlags** field.
- If the [Revision 2 Bitmap Cache Capability Set](#) ([\[MS-RDPBCGR\]](#) section 2.2.7.1.4.2) is sent by the client, then the ALLOW_CACHE_WAITING_LIST_FLAG (0x0002) MUST be present in the **CacheFlags** field.
- The client MUST support the Stream Surface Bits Surface Command ([\[MS-RDPBCGR\]](#) section [2.2.9.2.2](#)). Support for this surface command MUST be advertised in the Surface Commands Capability Set ([\[MS-RDPBCGR\]](#) section 2.2.7.2.9).
- The client MUST support a color depth of 32 bits per pixel. This means that the RNS_UD_32BPP_SUPPORT (0x0008) flag must be set in the **supportedColorDepths** field of the Client Core Data structure ([\[MS-RDPBCGR\]](#) section 2.2.1.3.2).

The [TS_FRAME_ACKNOWLEDGE_CAPABILITYSET](#) (section [2.2.1.3](#)) SHOULD<1> be sent by the client. Furthermore, if the **connectionType** field of the Client Core Data ([\[MS-RDPBCGR\]](#) section [2.2.1.3.2](#)) is set to any value other than CONNECTION_TYPE_LAN (0x06), then the RemoteFX server SHOULD NOT<2> indicate that the RemoteFX codec is supported, that is, none of the

[TS_BITMAPCODEC](#) ([\[MS-RDPBCGR\]](#) section 2.2.7.2.10.1.1) structures included in the **bitmapCodecArray** field of the [TS_BITMAPCODECS](#) ([\[MS-RDPBCGR\]](#) section 2.2.7.2.10) structure have the **codecGUID** field set to CODEC_GUID_REMOTEFX.

1.6 Applicability Statement

This protocol is applicable in situations in which it is necessary to optimize the bandwidth required for graphics remoting. The advanced compression techniques specified in this document enable the efficient transfer of server-side images and video.

1.7 Versioning and Capability Negotiation

This protocol builds on the basic Remote Desktop Protocol [\[MS-RDPBCGR\]](#). The features provided by this extension are negotiated during the capabilities negotiation phase of the RDP connection sequence (see [\[MS-RDPBCGR\]](#) section 1.3.1.1). In effect, this extension merely expands the set of capabilities used by the base RDP. (RDP versioning and capability negotiation is described in [\[MS-RDPBCGR\]](#) section 1.7.)

Some capabilities, which are specified as optional in [\[MS-RDPBCGR\]](#) section 2.2.7.2, are mandatory when used with RemoteFX. These capabilities are described in detail in section [2.1](#).

1.8 Vendor-Extensible Fields

None.

1.9 Standards Assignments

None.

2 Messages

2.1 Transport

This protocol is an extension to the [Remote Desktop Protocol: Basic Connectivity and Graphics Remoting Specification](#) and all packets are tunneled within the RDP transport ([\[MS-RDPBCGR\]](#) section 2.1).

2.2 Message Syntax

All multiple-byte fields within a message MUST be marshaled in **little-endian** byte order, unless otherwise specified.

2.2.1 Capabilities Messages

2.2.1.1 TS_RFX_CLNT_CAPS_CONTAINER

The TS_RFX_CLNT_CAPS_CONTAINER structure is the top-level client capability container that wraps a [TS_RFX_CAPS \(section 2.2.1.1.1\)](#) structure and is sent from the client to the server. It is encapsulated in the **codecProperties** field of the [Bitmap Codec \(\[MS-RDPBCGR\]](#) section 2.2.7.2.10.1.1) structure, which is ultimately encapsulated in the [Bitmap Codecs Capability Set \(\[MS-RDPBCGR\]](#) section 2.2.7.2.10), which is encapsulated in a client-to-server Confirm Active PDU ([\[MS-RDPBCGR\]](#) section 2.2.1.13.2).

0	1	2	3	4	5	6	7	8	9	10	11	12	13	14	15	16	17	18	19	20	21	22	23	24	25	26	27	28	29	30	31
length																															
captureFlags																															
capsLength																															
capsData (variable)																															
...																															

length (4 bytes): A 32-bit, unsigned integer. Specifies the combined size, in bytes, of the **length**, **captureFlags**, **capsLength**, and **capsData** fields.

captureFlags (4 bytes): A 32-bit, unsigned integer. A collection of flags that allow a client to control how data is captured and transmitted by the server.

Flag	Meaning
CARDP_CAPS_CAPTURE_NON_CAC 0x00000001	The client supports mixing RemoteFX data with data compressed by other codecs. The set of other codecs supported by the client will be negotiated using the Bitmap Codecs Capability Set ([MS-RDPBCGR] section 2.2.7.2.10).

capsLength (4 bytes): A 32-bit, unsigned integer. Specifies the size, in bytes, of the **capsData** field.

capsData (variable): A variable-sized field that contains a [TS_RFX_CAPS \(section 2.2.1.1.1\)](#) structure.

2.2.1.1.1 TS_RFX_CAPS

The TS_RFX_CAPS structure contains information about the decoder capabilities.

0	1	2	3	4	5	6	7	8	9	10	11	12	13	14	15	16	17	18	19	20	21	22	23	24	25	26	27	28	29	30	31
blockType																blockLen															
...																numCapsets															
capsetsData (variable)																															
...																															

blockType (2 bytes): A 16-bit, unsigned integer. Specifies the data block type. This field MUST be set to CBY_CAPS (0xCBC0).

blockLen (4 bytes): A 32-bit, unsigned integer. Specifies the combined size, in bytes, of the **blockType**, **blockLen**, and **numCapsets** fields. This field MUST be set to 0x0008.

numCapsets (2 bytes): A 16-bit, unsigned integer. Specifies the number of [TS_RFX_CAPSET \(section 2.2.1.1.1.1\)](#) structures contained in the **capsetsData** field. This field MUST be set to 0x0001.

capsetsData (variable): A variable-sized array of TS_RFX_CAPSET (section 2.2.1.1.1.1) structures. The structures in this array MUST be packed on byte boundaries. The **blockType** and **blockLen** fields of each TS_RFX_CAPSET structure identify the type and size of the structure.

2.2.1.1.1.1 TS_RFX_CAPSET

The TS_RFX_CAPSET structure contains the capability information specific to the RemoteFX codec. It contains a variable number of [TS_RFX_ICAP \(section 2.2.1.1.1.1.1\)](#) structures that are used to configure the encoder state.

0	1	2	3	4	5	6	7	8	9	10	11	12	13	14	15	16	17	18	19	20	21	22	23	24	25	26	27	28	29	30	31
blockType																blockLen															
...																codecId								capsetType							
...								numIcaps																icapLen							

...	icapsData (variable)
...	

blockType (2 bytes): A 16-bit, unsigned integer. Specifies the data block type. This field MUST be set to CBY_CAPSET (0xCBC1).

blockLen (4 bytes): A 32-bit, unsigned integer. Specifies the combined size, in bytes, of the **blockType**, **blockLen**, **codecId**, **capsetType**, **numIcaps**, **icapLen**, and **icapsData** fields.

codecId (1 byte): An 8-bit, unsigned integer. Specifies the codec ID. This field MUST be set to 0x01.

capsetType (2 bytes): A 16-bit, unsigned integer. This field MUST be set to CLY_CAPSET (0xCFC0).

numIcaps (2 bytes): A 16-bit, unsigned integer. The number of TS_RFX_ICAP structures contained in the **icapsData** field.

icapLen (2 bytes): A 16-bit, unsigned integer. Specifies the size, in bytes, of each TS_RFX_ICAP structure contained in the **icapsData** field.

icapsData (variable): A variable-length array of TS_RFX_ICAP (section 2.2.1.1.1.1.1) structures. Each structure MUST be packed on byte boundaries. The size of each TS_RFX_ICAP structure within the array is specified in the **icapLen** field.

2.2.1.1.1.1.1 TS_RFX_ICAP

The TS_RFX_ICAP structure specifies the set of codec properties that the decoder supports.

0	1	2	3	4	5	6	7	8	9	10	11	12	13	14	15	16	17	18	19	20	21	22	23	24	25	26	27	28	29	30	31
version																tileSize															
flags								colConvBits								transformBits								entropyBits							

version (2 bytes): A 16-bit, unsigned integer. Specifies the codec version. This field MUST be set to CLW_VERSION_1_0 (0x0100), to indicate protocol version 1.0.

tileSize (2 bytes): A 16-bit, signed integer. Specifies the width and height of a tile. This field MUST be set to CT_TILE_64x64 (0x0040), indicating that a tile is 64 x 64 pixels.

flags (1 byte): An 8-bit, unsigned integer. Specifies operational flags.

Flag	Meaning
CODEC_MODE 0x02	When this flag is set, it indicates that only image mode is supported by the decoder, and therefore, the codec MUST operate in image mode. When this flag is not set, it indicates that both the image mode and the video mode of the codec are supported by the decoder and the codec MUST operate in video mode.

When operating in image mode, the encode headers messages (section [2.2.2.2](#)) MUST always precede an encoded frame. When operating in video mode, the header messages MUST be present at the beginning of the stream and are optional elsewhere.

colConvBits (1 byte): An 8-bit, unsigned integer. Specifies the color conversion transform. This field MUST be set to CLW_COL_CONV_ICT (0x1), and the transformation is by the equations in sections [3.1.8.1.3](#) and [3.1.8.2.5](#).

transformBits (1 byte): An 8-bit, unsigned integer. Specifies the DWT. This field MUST be set to CLW_XFORM_DWT_53_A (0x1), the DWT transform given by the lifting equations for the DWT shown in section [3.1.8.1.4](#) and by the lifting equations for the inverse DWT shown in section [3.1.8.2.4](#).

entropyBits (1 byte): An 8-bit, unsigned integer. Specifies the entropy algorithm. This field MUST be set to one of the following values.

Value	Meaning
CLW_ENTROPY_RLGR1 0x01	RLGR algorithm as described in 3.1.8.1.7.1 .
CLW_ENTROPY_RLGR3 0x04	RLGR algorithm as described in section 3.1.8.1.7.2 .

2.2.1.2 TS_RFX_SRVR_CAPS_CONTAINER

The TS_RFX_SRVR_CAPS_CONTAINER structure is the top-level server capability container, which is sent from the server to the client. It is encapsulated in the **codecProperties** field of the Bitmap Codec structure ([\[MS-RDPBCGR\]](#) section 2.2.7.2.10.1.1), which is ultimately encapsulated in the Bitmap Codecs Capability Set ([\[MS-RDPBCGR\]](#) section 2.2.7.2.10). The Bitmap Codecs Capability Set is encapsulated in a server-to-client Demand Active PDU ([\[MS-RDPBCGR\]](#) section 2.2.1.13.1).

0	1	2	3	4	5	6	7	8	9	10	11	12	13	14	15	16	17	18	19	20	21	22	23	24	25	26	27	28	29	30	31
reserved (variable)																															
...																															

reserved (variable): A variable-sized array of bytes. All the bytes in this field MUST be set to 0. The size of the field is given by the corresponding **codecPropertiesLength** field of the parent [TS_BITMAPCODEC](#), as specified in [\[MS-RDPBCGR\]](#) section 2.2.7.2.10.1.1 Bitmap Codecs Capability Set.

2.2.1.3 TS_FRAME_ACKNOWLEDGE_CAPABILITYSET

The TS_FRAME_ACKNOWLEDGE_CAPABILITYSET structure advertises support for frame acknowledgment using the [TS_FRAME_ACKNOWLEDGE_PDU](#) (section [2.2.3.1](#)) structure. This capability is sent by both the client and the server and is encapsulated in a server-to-client [Demand Active PDU](#) ([\[MS-RDPBCGR\]](#) section 2.2.1.13.1) or a client-to-server [Confirm Active PDU](#) ([\[MS-RDPBCGR\]](#) section 2.2.1.13.2).

0	1	2	3	4	5	6	7	8	9	10	1	2	3	4	5	6	7	8	9	20	1	2	3	4	5	6	7	8	9	30	1
capabilitySetType																lengthCapability															
maxUnacknowledgedFrameCount																															

capabilitySetType (2 bytes): A 16-bit unsigned integer. The type of capability set. This field MUST be set to CAPSETTYPE_FRAME_ACKNOWLEDGE (0x001E).

lengthCapability (2 bytes): A 16-bit unsigned integer. The length, in bytes, of the capability data.

maxUnacknowledgedFrameCount (4 bytes): A 32-bit unsigned integer. When sent by the server, it MAY be set to 0, in which case it simply advertises the server's ability to receive and process the TS_FRAME_ACKNOWLEDGE_PDU (section 2.2.3.1). If it is not set to 0, it can be used by the client as a hint that indicates the number of in-flight TS_FRAME_ACKNOWLEDGE_PDUs that the server is prepared to accept. When sent by the client, it provides a hint to the server as to how many in-flight frames the client can buffer. Note that if the server chooses to have more in-flight frames than this number specifies, it is possible that the client could be overloaded with frame data. The client MAY set this field to 0, but this behavior SHOULD be avoided because it provides very little information to the server other than that the client acknowledges frames.

2.2.2 Encode Messages

An encoded RemoteFX stream comprises a sequence of encode messages. The sequencing and encapsulation of these messages are described in section 3.1.8.3.1.

2.2.2.1 Common Data Types

2.2.2.1.1 TS_RFX_BLOCKT

The TS_RFX_BLOCKT structure identifies the type of an encode message and specifies the size of the message.

0	1	2	3	4	5	6	7	8	9	10	1	2	3	4	5	6	7	8	9	20	1	2	3	4	5	6	7	8	9	30	1
blockType																blockLen															
...																															

blockType (2 bytes): A 16-bit, unsigned integer. Specifies the data block type. This field MUST be set to one of the following values.

Value	Meaning
CBT_TILE 0xCAC3	A TS_RFX_TILE (section 2.2.2.3.4.1) structure.
CBY_CAPS	A TS_RFX_CAPS (2.2.1.1.1) structure.

Value	Meaning
0xCBC0	
CBY_CAPSET 0xCBC1	A TS_RFX_CAPSET (2.2.1.1.1.1) structure.
WBT_SYNC 0xCCC0	A TS_RFX_SYNC (section 2.2.2.2.1) structure.
WBT_CODEEC_VERSIONS 0xCCC1	A TS_RFX_CODEEC_VERSIONS (section 2.2.2.2.2) structure.
WBT_CHANNELS 0xCCC2	A TS_RFX_CHANNELS (section 2.2.2.2.3) structure.

blockLen (4 bytes): A 32-bit, unsigned integer. Specifies the size, in bytes, of the data block. This size includes the size of the **blockType** and **blockLen** fields, as well as all trailing data.

2.2.2.1.2 TS_RFX_CODEEC_CHANNELT

The TS_RFX_CODEEC_CHANNELT structure is an extension of the TS_RFX_BLOCKT structure. It is present as the first field in messages that are targeted for a specific combination of codec and channel.

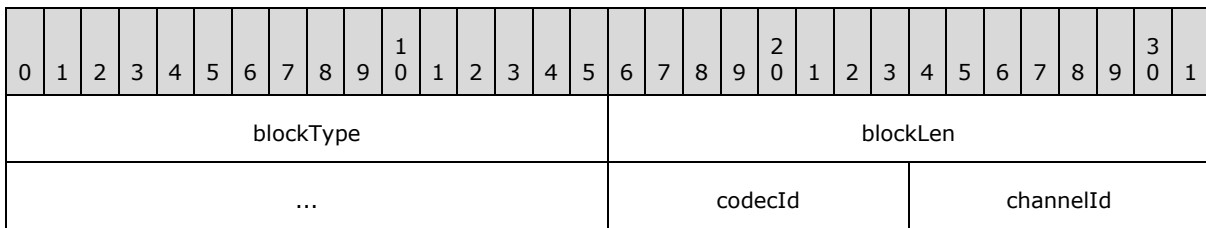

blockType (2 bytes): A 16-bit, unsigned integer. Specifies the data block type. This field MUST be set to one of the following values.

Value	Meaning
WBT_CONTEXT 0xCCC3	A TS_RFX_CONTEXT (section 2.2.2.2.4) structure.
WBT_FRAME_BEGIN 0xCCC4	A TS_RFX_FRAME_BEGIN (section 2.2.2.3.1) structure.
WBT_FRAME_END 0xCCC5	A TS_RFX_FRAME_END (section 2.2.2.3.2) structure.
WBT_REGION 0xCCC6	A TS_RFX_REGION (section 2.2.2.3.3) structure.
WBT_EXTENSION 0xCCC7	A TS_RFX_TILESET (section 2.2.2.3.4) structure.

blockLen (4 bytes): A 32-bit, unsigned integer. Specifies the size, in bytes, of the data block. This size includes the size of the **blockType**, **blockLen**, **codecId**, and **channelId** fields, as well as all trailing data.

codecId (1 byte): An 8-bit, unsigned integer. Specifies the codec ID. This field MUST be set to 0x01.

channelId (1 byte): An 8-bit, unsigned integer. Specifies the channel ID. If the **blockType** is set to WBT_CONTEXT (0xCCC3), then **channelId** MUST be set to 0xFF. For all other values of **blockType**, **channelId** MUST be set to 0x00.

2.2.2.1.3 TS_RFX_CHANNELT

The TS_RFX_CHANNELT structure is used to specify the screen resolution of a channel.

0	1	2	3	4	5	6	7	8	9	10	11	12	13	14	15	16	17	18	19	20	21	22	23	24	25	26	27	28	29	30	31
channelId								width																height							
...																															

channelId (1 byte): An 8-bit, unsigned integer. Specifies the identifier of the channel. This field MUST be set to 0x00.

width (2 bytes): A 16-bit, signed integer. Specifies the frame width of the channel. This field SHOULD <3> be within the range of 1 to 4096 (inclusive).

height (2 bytes): A 16-bit, signed integer. Specifies the frame height of the channel. This field SHOULD <4> be within the range of 1 to 2048 (inclusive).

2.2.2.1.4 TS_RFX_CODEC_VERSIONT

The TS_RFX_CODEC_VERSIONT structure is used to specify support for a specific version of the RemoteFX codec.

0	1	2	3	4	5	6	7	8	9	10	11	12	13	14	15	16	17	18	19	20	21	22	23	24	25	26	27	28	29	30	31
codecId								version																							

codecId (1 byte): An 8-bit, unsigned integer. Specifies the codec ID. This field MUST be set to 0x01. The decoder SHOULD ignore this field.

version (2 bytes): A 16-bit, signed integer. This field MUST be set to 0x0100. The decoder SHOULD ignore this field.

2.2.2.1.5 TS_RFX_CODEC_QUANT

The TS_RFX_CODEC_QUANT structure holds the scalar **quantization** values for the ten sub-bands in the 3-level DWT decomposition. Each field in this structure MUST have a value in the range of 6 to 15.

0	1	2	3	4	5	6	7	8	9	10	11	12	13	14	15	16	17	18	19	20	21	22	23	24	25	26	27	28	29	30	31				
LL3				LH3				HL3				HH3				LH2				HL2				HH2				LH1							
HL1				HH1																															

LL3 (4 bits): A 4-bit, unsigned integer. The LL quantization factor for the level-3 DWT sub-band.

LH3 (4 bits): A 4-bit, unsigned integer. The LH quantization factor for the level-3 DWT sub-band.

HL3 (4 bits): A 4-bit, unsigned integer. The HL quantization factors for the level-3 DWT sub-band.

HH3 (4 bits): A 4-bit, unsigned integer. The HH quantization factors for the level-3 DWT sub-band.

LH2 (4 bits): A 4-bit, unsigned integer. The LH quantization factor for the level-2 DWT sub-band.

HL2 (4 bits): A 4-bit, unsigned integer. The HL quantization factor for the level-2 DWT sub-band.

HH2 (4 bits): A 4-bit, unsigned integer. The HH quantization factor for the level-2 DWT sub-band.

LH1 (4 bits): A 4-bit, unsigned integer. The LH quantization factors for the level-1 DWT sub-band.

HL1 (4 bits): A 4-bit, unsigned integer. The HL quantization factors for the level-1 DWT sub-band.

HH1 (4 bits): A 4-bit, unsigned integer. The HH quantization factor for the level-1 DWT sub-band.

2.2.2.1.6 TS_RFX_RECT

The TS_RFX_RECT structure is used to specify a rectangle.

0	1	2	3	4	5	6	7	8	9	10	11	12	13	14	15	16	17	18	19	20	21	22	23	24	25	26	27	28	29	30	31
x																y															
width																height															

x (2 bytes): A 16-bit, unsigned integer. The X-coordinate of the rectangle.

y (2 bytes): A 16-bit, unsigned integer. The Y-coordinate of the rectangle.

width (2 bytes): A 16-bit, unsigned integer. The width of the rectangle.

height (2 bytes): A 16-bit, unsigned integer. The height of the rectangle.

2.2.2.2 Encode Header Messages

2.2.2.2.1 TS_RFX_SYNC

The TS_RFX_SYNC message MUST be the first message in any encoded stream. The decoder MUST examine this message to determine whether the protocol version is supported.

0	1	2	3	4	5	6	7	8	9	10	11	12	13	14	15	16	17	18	19	20	21	22	23	24	25	26	27	28	29	30	31
BlockT																															
...																magic															
...																version															

BlockT (6 bytes): A [TS_RFX_BLOCKT \(section 2.2.2.1.1\)](#) structure. The **blockType** field MUST be set to WBT_SYNC (0xCCCC).

magic (4 bytes): A 32-bit, unsigned integer. This field MUST be set to WF_MAGIC (0xCACCACCA).

version (2 bytes): A 16-bit, unsigned integer. Indicates the version number. This field MUST be set to WF_VERSION_1_0 (0x0100).

2.2.2.2.2 TS_RFX_CODECS_VERSIONS

The TS_RFX_CODECS_VERSIONS message indicates the version of the RemoteFX codec that is being used.

0	1	2	3	4	5	6	7	8	9	10	11	12	13	14	15	16	17	18	19	20	21	22	23	24	25	26	27	28	29	30	31
BlockT																															
...																numCodecs								codecs							
...																															

BlockT (6 bytes): A [TS_RFX_BLOCKT \(section 2.2.2.1.1\)](#) structure. The **blockType** field MUST be set to WBT_CODECS_VERSIONS (0xCCC1).

numCodecs (1 byte): An 8-bit, unsigned integer. Specifies the number of codec version data blocks in the **codecs** field. This field MUST be set to 0x01.

codecs (3 bytes): A [TS_RFX_CODECS_VERSIONT \(section 2.2.2.1.4\)](#) structure. The **codecId** field MUST be set to 0x01 and the **version** field MUST be set to WF_VERSION_1_0 (0x0100).

2.2.2.2.3 TS_RFX_CHANNELS

The TS_RFX_CHANNELS message contains the list of channels. Each active monitor on the server must correspond to an entry in this list. The list can have more entries than the number of active monitors. The decoder endpoint MUST be able to support channels with different frame dimensions.

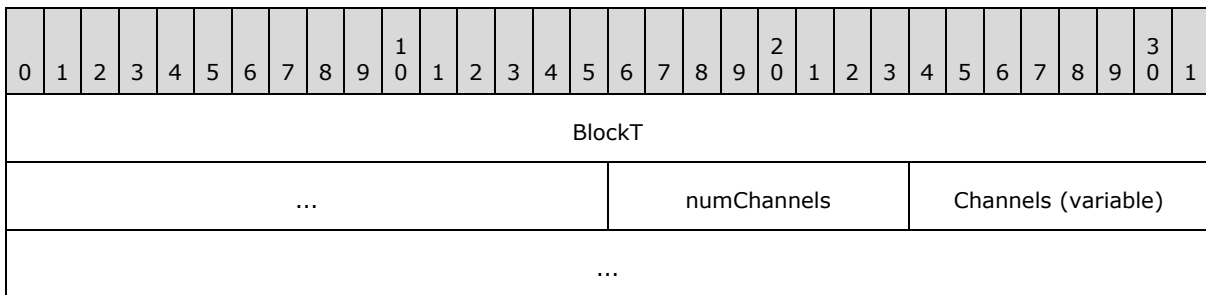

BlockT (6 bytes): A [TS_RFX_BLOCKT \(section 2.2.2.1.1\)](#) structure. The **blockType** field MUST be set to WBT_CHANNELS (0xCCC2).

numChannels (1 byte): An 8-bit, unsigned integer. Specifies the number of channel data blocks in the **channels** field.

Channels (variable): A variable-length array of [TS_RFX_CHANNELT \(section 2.2.2.1.3\)](#) structures. The number of elements in this array is specified in the **numChannels** field.

2.2.2.2.4 TS_RFX_CONTEXT

The TS_RFX_CONTEXT message contains information regarding the encoding properties being used.

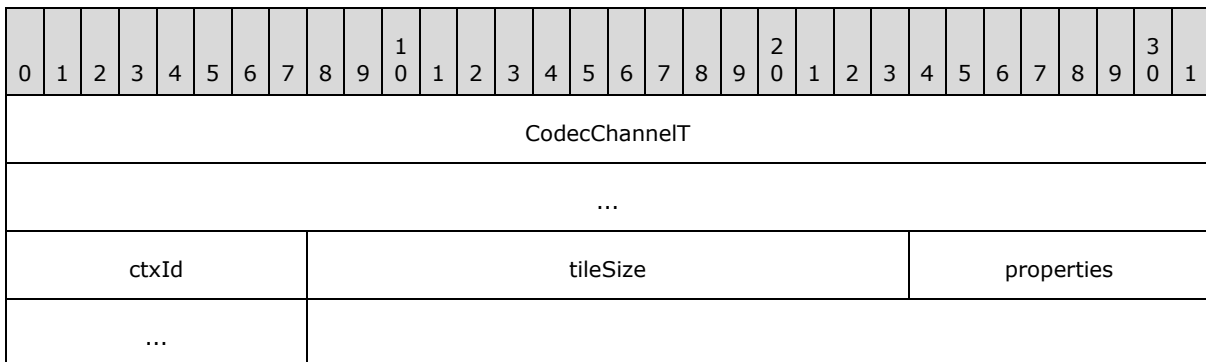

CodecChannelT (8 bytes): A [TS_RFX_CODEC_CHANNELT](#) structure. The **blockType** field MUST be set to WBT_CONTEXT (0xCCC3).

ctxId (1 byte): An 8-bit unsigned integer. Specifies an identifier for this context message. This field MUST be set to 0x00. The decoder SHOULD ignore this field.

tileSize (2 bytes): A 16-bit unsigned integer. Specifies the tile size used by the RemoteFX codec. This field MUST be set to CT_TILE_64x64 (0x0040), indicating that a tile is 64 x 64 pixels.

properties (2 bytes): A 16-bit unsigned integer. Contains a collection of bit-packed property fields. The format of this field is described by the following bitfield diagram.

0	1	2	3	4	5	6	7	8	9	0	1	2	3	4	5	6	7	8	9	0	1	2	3	4	5	6	7	8	9	0	1
flags			cct		xft				et				qt		r																

flags (3 bits): A 3-bit unsigned integer. Specifies operational flags.

Flag	Meaning
CODEC_MODE 0x02	The codec is operating in image mode. If this flag is not set, the codec is operating in video mode.

When operating in image mode, the Encode Headers messages (section [2.2.2.2](#)) MUST always precede an encoded frame. When operating in video mode, the header messages MUST be present at the beginning of the stream and MAY be present elsewhere.

cct (2 bits): A 2-bit unsigned integer. Specifies the color conversion transform. This field MUST be set to COL_CONV_ICT (0x1) to specify the transform defined by the equations in sections [3.1.8.1.3](#) and [3.1.8.2.5](#). The decoder SHOULD ignore this field.

xft (4 bits): A 4-bit unsigned integer. Specifies the DWT. This field MUST be set to CLW_XFORM_DWT_53_A (0x1), which indicates the DWT given by the equations in sections [3.1.8.1.4](#) and [3.1.8.2.4](#).

et (4 bits): A 4-bit unsigned integer. Specifies the entropy algorithm. This field MUST be set to one of the following values.

Value	Meaning
CLW_ENTROPY_RLGR1 0x01	RLGR algorithm as detailed in 3.1.8.1.7.1 .
CLW_ENTROPY_RLGR3 0x04	RLGR algorithm as detailed in 3.1.8.1.7.2 .

The decoder SHOULD ignore this value and use the value defined in the properties field of [TS_RFX_TILESET \(section 2.2.2.3.4\)](#) (section [2.2.2.3.4](#)).

qt (2 bits): A 2-bit unsigned integer. Specifies the quantization type. This field MUST be set to SCALAR_QUANTIZATION (0x1). The decoder SHOULD ignore this field.

r (1 bit): A 1-bit field reserved for future use. This field MUST be ignored when received.

2.2.2.3 Encode Data Messages

2.2.2.3.1 TS_RFX_FRAME_BEGIN

The TS_RFX_FRAME_BEGIN message indicates the start of a new frame for a specific channel in the encoded stream.

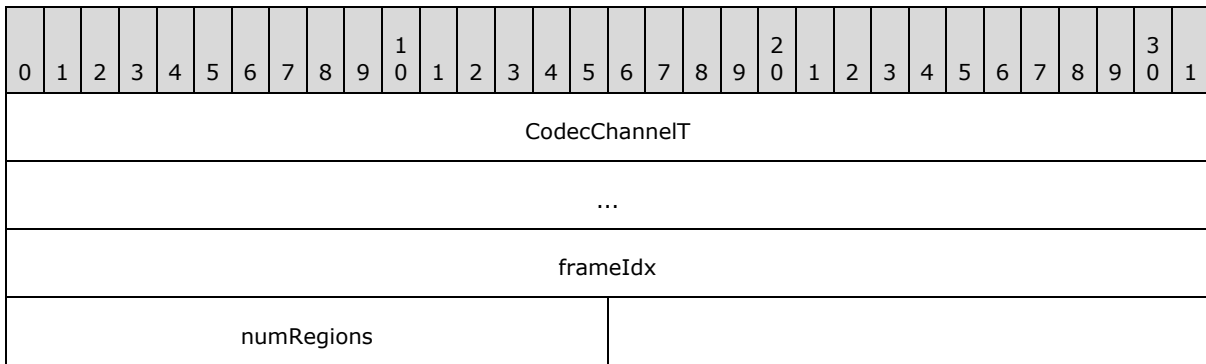

CodecChannelT (8 bytes): A [TS_RFX_CODEC_CHANNELT \(section 2.2.2.1.2\)](#) structure. The **blockType** field MUST be set to WBT_FRAME_BEGIN (0xCCC4).

frameIdx (4 bytes): A 32-bit unsigned integer. Specifies the index of the frame in the current video sequence. This field is used when the codec is operating in video mode, as specified using the **flags** field of the [TS_RFX_CONTEXT \(section 2.2.2.4\)](#) message. If the codec is operating in image mode, this field MUST be ignored. If the codec is operating in video mode, this field SHOULD be ignored.

numRegions (2 bytes): A 16-bit signed integer. Specifies the number of [TS_RFX_REGION \(section 2.2.2.3.3\)](#) messages following this TS_RFX_FRAME_BEGIN message. That is, the number of regions in the frame.

2.2.2.3.2 TS_RFX_FRAME_END

The TS_RFX_FRAME_END message specifies the end of a frame for a specific channel in the encoded stream.

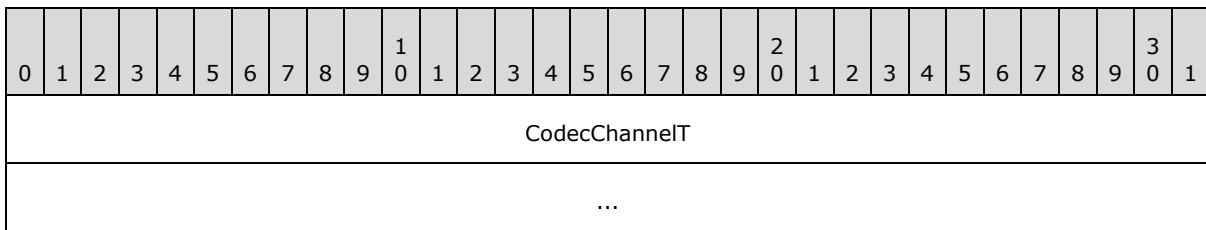

CodecChannelT (8 bytes): A [TS_RFX_CODEC_CHANNELT \(section 2.2.2.1.2\)](#) structure. The **blockType** field MUST be set to WBT_FRAME_END (0xCCC5).

2.2.2.3.3 TS_RFX_REGION

The TS_RFX_REGION message contains information about the list of change rectangles on the screen for a specific channel. It also specifies the number of trailing [TS_RFX_TILESET \(section 2.2.2.3.4\)](#) messages.

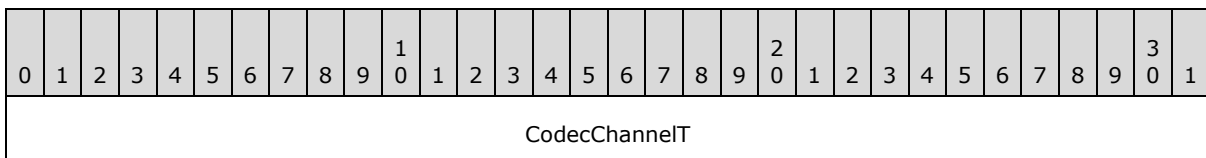

...		
regionFlags	numRecls	recls (variable)
...		
regionType	numTilesets	

CodecChannelT (8 bytes): A [TS_RFX_CODEC_CHANNELT \(section 2.2.2.1.2\)](#) structure. The **blockType** field MUST be set to WBT_REGION (0xCCC6).

regionFlags (1 byte): An 8-bit, unsigned integer. Contains a collection of bit-packed property fields. The format of this field is described by the following bitfield diagram.

0	1	2	3	4	5	6	7
lrf	reserved						

lrf (1 bit): A 1-bit unsigned integer. This field MUST be set to 0x1. The decoder SHOULD ignore this field.

reserved (7 bits): A 7-bit integer reserved for future use. This field MUST be ignored.

numRecls (2 bytes): A 16-bit, unsigned integer. Specifies the number of [TS_RFX_RECT \(section 2.2.2.1.6\)](#) structures present in the **recls** field.

recls (variable): A variable-length array of TS_RFX_RECT (section 2.2.2.1.6) structures. This array defines the region. The number of rectangles in the array is specified in the **numRecls** field. Processing rules for the rectangles in this array are specified in section [3.1.8.2.6](#).

regionType (2 bytes): A 16-bit, unsigned integer. Specifies the region type. This field MUST be set to CBT_REGION (0xCAC1).

numTilesets (2 bytes): A 16-bit, unsigned integer. Specifies the number of TS_RFX_TILESET (section 2.2.2.3.4) messages following this TS_RFX_REGION message. This field MUST be set to 0x0001.

2.2.2.3.4 TS_RFX_TILESET

The TS_RFX_TILESET message contains encoding parameters and data for an arbitrary number of encoded tiles.

0	1	2	3	4	5	6	7	8	9	10	11	12	13	14	15	16	17	18	19	20	21	22	23	24	25	26	27	28	29	30	31
CodecChannelT																															
...																															
subtype																idx															

properties	numQuant	tileSize
numTiles	tilesDataSize	
...	quantVals (variable)	
...		
tiles (variable)		
...		

CodecChannelT (8 bytes): A [TS_RFX_CODEC_CHANNELT \(section 2.2.2.1.2\)](#) structure. The **blockType** field MUST be set to WBT_EXTENSION (0xCCC7).

subtype (2 bytes): A 16-bit, unsigned integer. Specifies the message type. This field MUST be set to CBT_TILESET (0xCAC2).

idx (2 bytes): A 16-bit, unsigned integer. Specifies the identifier of the [TS_RFX_CONTEXT \(section 2.2.2.4\)](#) message referenced by this TileSet message. This field MUST be set to 0x0000. The decoder SHOULD ignore this field.

properties (2 bytes): A 16-bit unsigned integer. Contains a collection of bit-packed property fields. The format of this field is described by the following bitmask diagram.

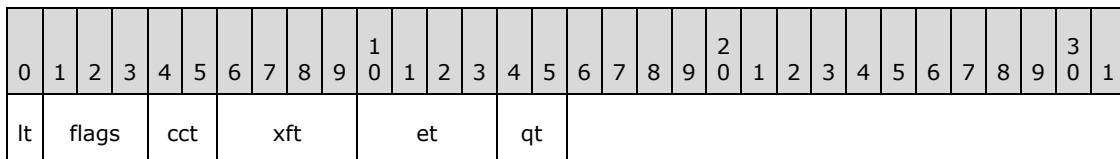

lt (1 bit): A 1-bit field that specifies whether this is the last TS_RFX_TILESET in the region. This field MUST be set to TRUE (0x1). The decoder SHOULD ignore this field.

flags (3 bits): A 3-bit unsigned integer. Specifies operational flags.

Flag	Meaning
CODEC_MODE 0x02	The codec is operating in image mode. If this flag is not set, the codec is operating in video mode.

The encoder MUST set this value to the value of flags that is set in the properties field of TS_RFX_CONTEXT. The decoder MUST ignore this flag and MUST use the flags specified in the **flags** field of the TS_RFX_CONTEXT.

cct (2 bits): A 2-bit unsigned integer. Specifies the color conversion transform. This field MUST be set to COL_CONV_ICT (0x1) to specify the transform defined by the equations in sections [3.1.8.1.3](#) and [3.1.8.2.5](#). The decoder SHOULD ignore this field.

xft (4 bits): A 4-bit unsigned integer. Specifies the DWT. This field MUST be set to CLW_XFORM_DWT_53_A (0x1), which indicates the DWT given by the equations in sections [3.1.8.1.4](#) and [3.1.8.2.4](#). The decoder SHOULD ignore this field.

et (4 bits): A 4-bit unsigned integer. Specifies the entropy algorithm. This field MUST be set to one of the following values.

Value	Meaning
CLW_ENTROPY_RLGR1 0x01	RLGR algorithm as detailed in 3.1.8.1.7.1 .
CLW_ENTROPY_RLGR3 0x04	RLGR algorithm as detailed in 3.1.8.1.7.2 .

qt (2 bits): A 2-bit unsigned integer. Specifies the quantization type. This field MUST be set to SCALAR_QUANTIZATION (0x1). The decoder SHOULD ignore this field.

numQuant (1 byte): An 8-bit, unsigned integer. Specifies the number of TS_RFX_CODEC_QUANT (section [2.2.2.1.5](#)) structures present in the **quantVals** field.

tileSize (1 byte): An 8-bit, unsigned integer. Specifies the width and height of a tile. This field MUST be set to 0x40. The decoder SHOULD ignore this field.

numTiles (2 bytes): A 16-bit, unsigned integer. Specifies the number of TS_RFX_TILE (section [2.2.2.3.4.1](#)) structures present in the **tiles** field.

tilesDataSize (4 bytes): A 32-bit, unsigned integer. Specifies the size, in bytes, of the **tiles** field. The **tiles** field contains encoded data for all of the tiles that have changed.

quantVals (variable): A variable-length array of TS_RFX_CODEC_QUANT (section [2.2.2.1.5](#)) structures. The number of structures present in the array is indicated in the **numQuant** field.

tiles (variable): A variable-length array of TS_RFX_TILE (section [2.2.2.3.4.1](#)) structures. The number of structures present in the array is indicated in the **numTiles** field, while the total size, in bytes, of this field is specified by the **tilesDataSize** field.

2.2.2.3.4.1 TS_RFX_TILE

The TS_RFX_TILE structure specifies the position of the tile on the frame and contains the encoded data for the three tile components of Y, Cb, and Cr.

0	1	2	3	4	5	6	7	8	9	10	11	12	13	14	15	16	17	18	19	20	21	22	23	24	25	26	27	28	29	30	31								
BlockT																																							
...																quantIdxY								quantIdxCb															
quantIdxCr																xIdx																yIdx							
...																YLen																CbLen							
...																CrLen																YData (variable)							
...																																							

CbData (variable)
...
CrData (variable)
...

BlockT (6 bytes): A [TS_RFX_BLOCKT \(section 2.2.2.1.1\)](#) structure. The **blockType** field MUST be set to CBT_TILE (0xCAC3).

quantIdxY (1 byte): An 8-bit, unsigned integer. Specifies an index into the TS_RFX_CODEEC_QUANT array provided in the TS_RFX_TILESET message. The specified **TS_RFX_CODEEC_QUANT** element MUST be used for de-quantization of the sub-bands for the Y-component.

quantIdxCb (1 byte): An 8-bit, unsigned integer. Specifies an index into the TS_RFX_CODEEC_QUANT array provided in the TS_RFX_TILESET message. The specified **TS_RFX_CODEEC_QUANT** element MUST be used for de-quantization of the sub-bands for the Cb-component.

quantIdxCr (1 byte): An 8-bit, unsigned integer. Specifies an index into the [TS_RFX_CODEEC_QUANT](#) array provided in the [TS_RFX_TILESET](#) message. The specified **TS_RFX_CODEEC_QUANT** element MUST be used for de-quantization of the sub-bands for the Cr-component.

xIdx (2 bytes): A 16-bit, unsigned integer. The X-index of the encoded tile in the screen tile grid.

yIdx (2 bytes): A 16-bit, unsigned integer. The Y-index of the encoded tile in the screen tile grid.

YLen (2 bytes): A 16-bit, unsigned integer. Specifies the size, in bytes, of the **YData** field.

CbLen (2 bytes): A 16-bit, unsigned integer. Specifies the size, in bytes, of the **CbData** field.

CrLen (2 bytes): A 16-bit, unsigned integer. Specifies the size, in bytes, of the **CrData** field.

YData (variable): A variable-length array. Contains the encoded data for the Y-component of the tile. The size, in bytes, of this field is specified by the **YLen** field.

CbData (variable): A variable-length array. Contains the encoded data for the Cb-component of the tile. The size, in bytes, of this field is specified by the **CbLen** field.

CrData (variable): A variable-length array. Contains the encoded data for the Cr-component of the tile. The size, in bytes, of this field is specified by the **CrLen** field.

2.2.3 Control Messages

2.2.3.1 TS_FRAME_ACKNOWLEDGE_PDU

The TS_FRAME_ACKNOWLEDGE_PDU structure is a client-to-server PDU sent to the server whenever the client receives a [Frame Marker Command](#) ([\[MS-RDPBCGR\]](#) section 2.2.9.2.3) with the **frameAction** field set to SURFACECMD_FRAMEACTION_END (0x0001) and it has finished

processing this particular frame (that is, the surface bits have been rendered on the screen). The server uses this acknowledgment to throttle the rate at which it generates frames of data to avoid overloading the client with too many updates. The server SHOULD NOT wait for an acknowledgment for each frame before sending the next frame. Instead, the server SHOULD have a "window" mechanism where it allows multiple frames to be unacknowledged before it slows down its frame rate (or stops completely).

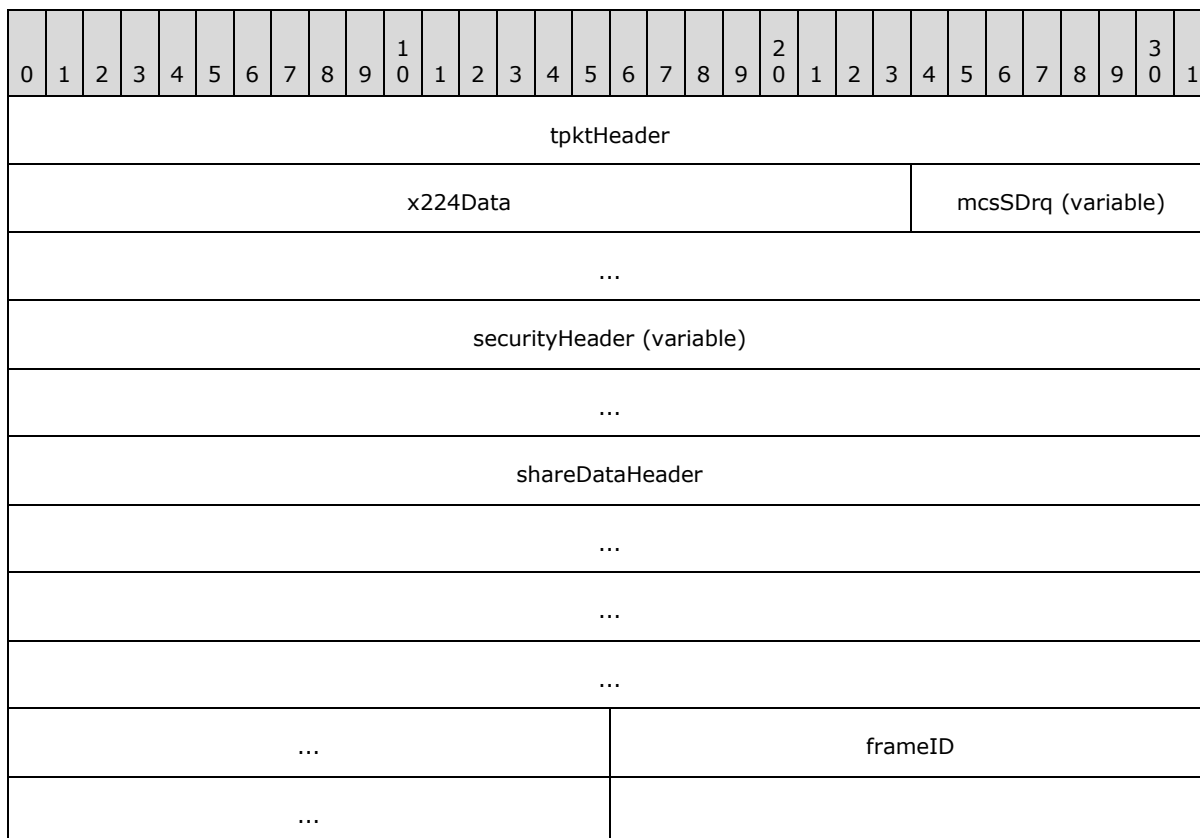

tpktHeader (4 bytes): A TPKT Header as specified in [\[T123\]](#) section 8.

x224Data (3 bytes): An X.224 Class 0 Data TPDU, as specified in [\[X224\]](#) section 13.7.

mcsSDrq (variable): Variable-length PER-encoded MCS Domain PDU (DomainMCSPDU) that encapsulates an MCS Send Data Request structure (SDrq, choice 25 from DomainMCSPDU). This is as specified in [\[T125\]](#) section 11.32, and the ASN.1 structure definitions are specified in [\[T125\]](#) section 7, parts 7 and 10. The **userData** field of the MCS Send Data Request PDU contains a Security Header, [Share Data Header](#), and a frame ID.

securityHeader (variable): Optional security header. The presence and format of the security header depend on the Encryption Level and Encryption Method selected by the server ([MS-RDPBCGR] sections [5.3.2](#) and [2.2.1.4.3](#)). If the Encryption Level selected by the server is greater than ENCRYPTION_LEVEL_NONE (0) and the Encryption Method selected by the server is greater than ENCRYPTION_METHOD_NONE (0), this field MUST contain one of the following headers:

- Non-FIPS Security Header ([\[MS-RDPBCGR\]](#) section 2.2.8.1.1.2.2) if the Encryption Method selected by the server is ENCRYPTION_METHOD_40BIT (0x00000001),

ENCRYPTION_METHOD_56BIT (0x00000008), or ENCRYPTION_METHOD_128BIT (0x00000002).

- FIPS Security Header ([\[MS-RDPBCGR\]](#) section 2.2.8.1.1.2.3) if the Encryption Level selected by the server is ENCRYPTION_METHOD_FIPS (0x00000010).

If the Encryption Level selected by the server is ENCRYPTION_LEVEL_NONE (0) and the Encryption Method selected by the server is ENCRYPTION_METHOD_NONE (0), this header MUST NOT be included in the PDU.

shareDataHeader (18 bytes): Share Data Header ([\[MS-RDPBCGR\]](#) section 2.2.8.1.1.1.2) containing information about the packet. The type subfield of the **pduType** field of the [Share Control Header](#) ([\[MS-RDPBCGR\]](#) section 2.2.8.1.1.1.1) within the Share Data Header MUST be set to PDUTYPE_DATAPDU (0x0007). The **pduType2** field of the Share Data Header MUST be set to PDUTYPE2_FRAME_ACKNOWLEDGE (0x38).

frameID (4 bytes): A 32-bit unsigned integer. This field specifies the 32-bit identifier of the frame that was sent to the client using a Frame Marker Command and is being acknowledged as delivered. The **frameID** field MUST be populated with the value of the **frameID** field that was specified in the Frame Marker Command associated with the frame being acknowledged. If the **frameID** field is set to the value 0xFFFFFFFF, the server SHOULD [<5>](#) assume that all in-flight frames have been acknowledged.

3 Protocol Details

3.1 Common Details

3.1.1 Abstract Data Model

This section describes a conceptual model of possible data organization that an implementation maintains to participate in this protocol. The described organization is provided to facilitate the explanation of how the protocol behaves. This document does not mandate that implementations adhere to this model, as long as their external behavior is consistent with that described in this document.

OperationalMode: Stores the operational mode currently in use. Operational modes include video mode, and image mode.

EntropyAlgorithm: Stores the entropy algorithm currently in use. Entropy algorithms include RLGR1 and RLGR3.

FrameIndex: A 32-bit integer variable. Used by the server to keep track of the current index of the encoded frame within an encoding session. This variable is used only when the **OperationalMode** is video mode. If the **OperationalMode** is image mode, the server does not need to maintain this variable.

In video mode, this variable should be initialized to 0 at the start of the session and then incremented by 1 after every encoded frame. The current value of this variable is stored in the **frameIdx** field of the [TS_RFX_FRAME_BEGIN](#) message (section [2.2.2.3.1](#)).

3.1.1.1 State Machine

The following figure and table describe the state machine of the codec at the server end.

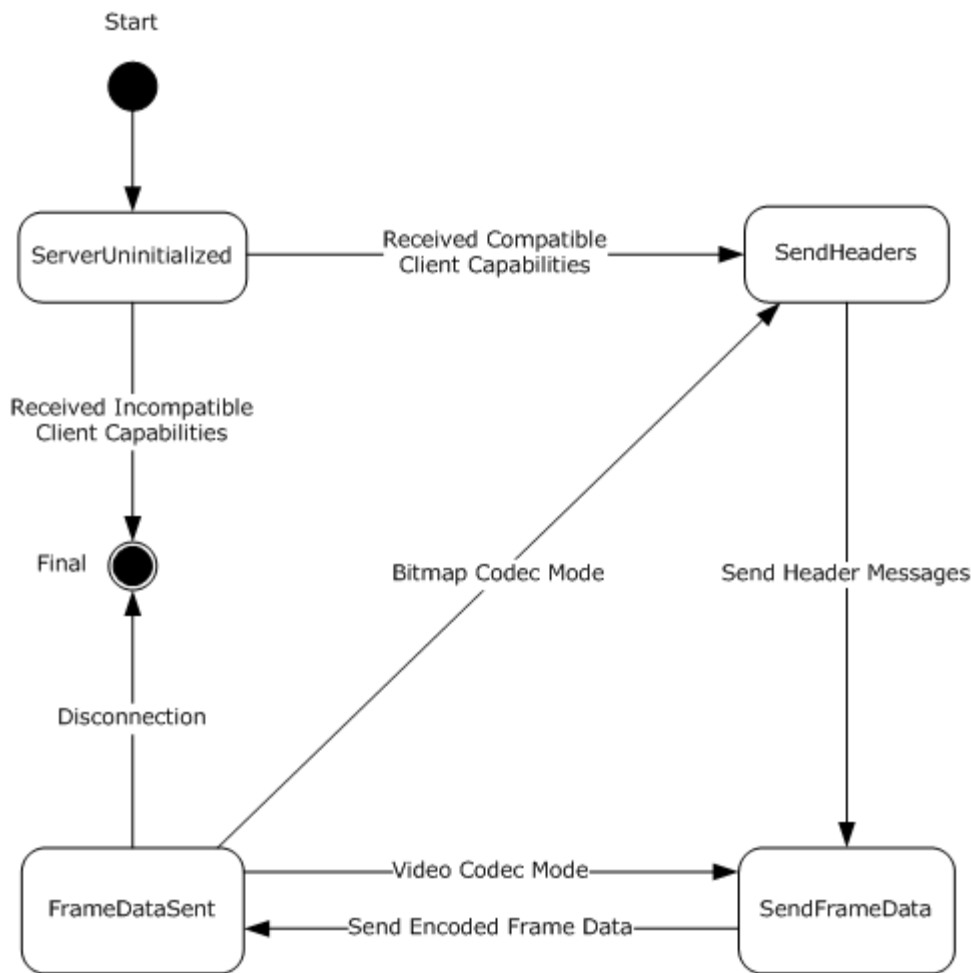

Figure 3: Server state diagram

State Name	Description
ServerUninitialized	This is the initial state of the server. In this state, the server waits for the TS_RFX_CLNT_CAPS_CONTAINER message from the client. On receiving this message, the server processes it as described in section 3.1.5.1 . If it finds a compatible TS_RFX_ICAP , it initializes itself and gets into the SendHeaders state. Otherwise, the connection is terminated (section 3.1.5.1).
SendHeaders	In this state, the server sends the Header message sequence as described in section 3.1.8.3.1 and shown in Figure 17. The server then transitions to the SendFrameData state.
SendFrameData	In this state, the server sends the encoded frame data messages as described in section 3.1.8.3.1 and shown in Figure 18. The server then transitions to the FrameDataSent state.
FrameDataSent	If the OperationalMode of the server is image mode, the server transitions to the SendHeaders state. If the OperationalMode is video mode, the server transitions to either the SendFrameData state or the SendHeaders state.

3.1.2 Timers

None.

3.1.3 Initialization

The [Bitmap Codecs Capability Set](#) message ([\[MS-RDPBCGR\]](#) section 2.2.7.2.10) MUST be processed by the server, as specified in section [3.1.5.1](#), before RemoteFX encoding begins. This establishes the encoding properties that will be used by the server when sending the encoded data stream.

The Bitmap Codecs Capability Set is sent by the client, encapsulating the [TS_RFX_CLNT_CAPS_CONTAINER](#) ([section 2.2.1.1](#)). The server ultimately processes the encapsulated [TS_RFX_CLNT_CAPS_CONTAINER](#) ([section 2.2.1.1](#)) message as specified in section [3.1.5.1](#), picking a [TS_RFX_ICAP](#) ([section 2.2.1.1.1.1](#)) element. From that point on, the server uses the capability properties listed in that element to encode RemoteFX data streams.

3.1.4 Higher-Layer Triggered Events

None.

3.1.5 Processing Events and Sequencing Rules

Establishing the connection: RemoteFX capabilities messages are exchanged to establish the encoding properties used by the server, as specified in sections [3.1.3](#) and [3.1.5.1](#). A compliant server MUST process the [TS_RFX_CLNT_CAPS_CONTAINER](#) message as specified in section [3.1.5.1](#) before RemoteFX encoding can begin.

Sending RemoteFX encoded data: RemoteFX encoded data is sent to the client as a sequence of the RemoteFX messages defined in section [2.2.2](#). A compliant server MUST always send the encoded messages in the correct order, as specified in section [3.1.8.3.1](#).

Header messages: The encoded message sequence MUST include header messages, as specified in section [3.1.8.3.1](#).

Header messages contain information about the encoding properties used for encoding data messages, and are used by the client to decode the message stream. Header messages MUST always specify the encoding properties initialized and stored in **OperationalMode** and **EntropyAlgorithm**. The encode header and data message sequences are shown in the figures [Generation of RemoteFX encode header messages](#) and [Generation of RemoteFX encode data messages](#) ([section 3.1.8.3.1](#)).

Header messages can appear multiple times within the message stream, depending on the **OperationalMode** property:

- If the encoder is initialized with **OperationalMode** set to video mode, then it MUST send the encode header message sequence at the start of the stream. The encode header message sequence is then followed by an arbitrary number of encode data message sequences.
- If the encoder is initialized with **OperationalMode** set to image mode, then it MUST send the encode header message sequence before every encode data message sequence.

Entropy Algorithm: The server MUST use the entropy algorithm, initialized and stored in **EntropyAlgorithm**, to encode every data message in the encoded data stream.

Error conditions: If the client receives an out-of-sequence, unspecified, or malformed message, then the client MUST treat this as an error and terminate the RDP connection.

3.1.5.1 Processing the TS_RFX_CLNT_CAPS_CONTAINER Message

The structure and fields of the [TS_RFX_CLNT_CAPS_CONTAINER](#), and its constituent members, are specified in section [2.2.1.1](#).

TS_RFX_CLNT_CAPS_CONTAINER has a [TS_RFX_CAPS](#) field. The TS_RFX_CAPS field contains a [TS_RFX_CAPSET](#) sub-field, which is composed of a variable number of [TS_RFX_ICAP](#) structures.

The encoder parses the TS_RFX_CLNT_CAPS_CONTAINER message to get to the array of TS_RFX_ICAP structures. It processes each element of this array to check whether it can support all the properties listed in that TS_RFX_ICAP element. From this set of supported elements, it will arbitrarily pick one element and use only the properties listed in that specific TS_RFX_ICAP to encode the data stream.

For example, if the decoder supports both RLGR1 and RLGR3, the client can specify support for both of them. This support is specified using two TS_RFX_ICAP elements in the TS_RFX_CAPSET message that the client sends to the server. If the encoder also supports both RLGR1 and RLGR3, it then arbitrarily picks one of the TS_RFX_CAPSET elements to use for encoding.

Once a TS_RFX_ICAP element has been picked, the **OperationalMode** and **EntropyAlgorithm** ADM elements are set as follows.

- If the TS_RFX_ICAP element's **flags** field is set to include the 0x02 flag, the **OperationalMode** is set to image mode; otherwise, the **OperationalMode** is set to video mode.
- When the TS_RFX_ICAP element's **entropyBits** field is set to 0x01, the **EntropyAlgorithm** is set to RLGR1; when **entropyBits** is set to 0x04, **EntropyAlgorithm** is set to RLGR3.

Error conditions: If the server cannot support any of the TS_RFX_ICAP elements, it MUST stop sending messages and consider the RDP connection terminated.

3.1.6 Timer Events

None.

3.1.7 Other Local Events

None.

3.1.8 RemoteFX Algorithm

RemoteFX is a tile-based transform codec. It has the same functional stages as those found in most structured compression systems (section [1.3.1](#)). At the encode endpoint, these stages are transform, quantization, and entropy encoding. The inverse of these operations (in the reverse order) takes place at the decode endpoint. RemoteFX uses DWTs and Run-Length Golomb-Rice Coding (RLGR) ([\[ARLGR\]](#) section 3) for transformation and entropy encoding respectively.

3.1.8.1 Encoding

The functional stages involved in the encoding path are illustrated in the following figure. Each of these stages is described in the subsections that follow.

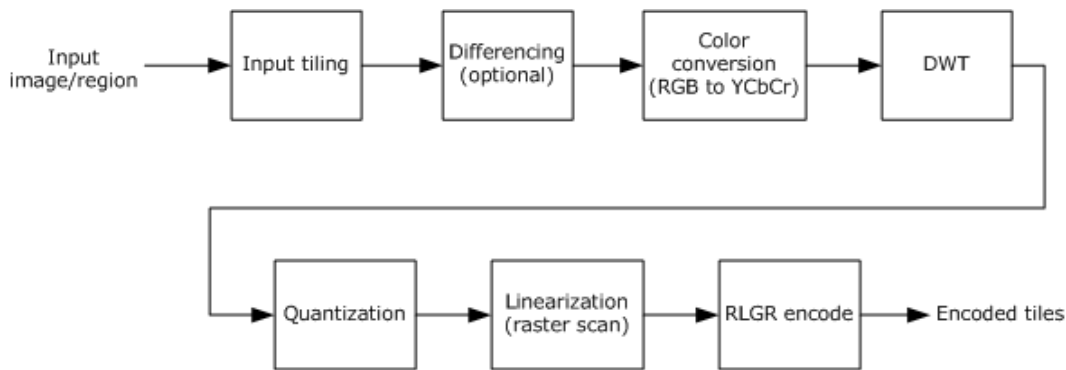

Figure 4: RemoteFX encoding stages

3.1.8.1.1 Input Tiling

The input to the encoder is an arbitrary region contained within an image to be encoded. The input image is overlaid with a tile grid anchored to the top left corner of the screen (0, 0) and aligned to the tile size (the tile size MUST be 64 x 64 pixels). The set of tiles that map to the input region are computed. These tiles are candidates for further processing, and each tile is processed independently of the others.

3.1.8.1.2 Differencing (Optional)

If the RemoteFX codec is to be used as a video codec, the encoder can, optionally, do differencing between current and previous frames to compute the smallest set of tiles that have changed. The differencing is done by comparing the set of input tiles in the current frame with collocated tiles from the previous frame to determine whether any pixels have changed. Only the input tiles with changed pixels in the current frame are processed for compression. Note that the input tile is compressed as is; this algorithm does not compress the tile of difference values formed by subtracting the input tile pixels of the current frame from the collocated tile pixels in the previous frame. This means that the decoder does not need to determine whether the encoder is doing differencing. The encoder can use differencing to reduce the number of tiles that it needs to encode, thereby reducing the bandwidth required to send the compressed tiles to the decoder. If the codec is to be used as an image codec, this stage MUST be skipped.

3.1.8.1.3 Color Conversion (RGB to YCbCr)

Each input tile is converted from the RGB color space to the **YCbCr color space**. The transform used takes an RGB input value with each component in the range [0-255] and transforms it into Y, Cb, and Cr, in the ranges [0.0, 255.0], [-128.0, 127.0], and [-128.0, 127.0], respectively. The Y-component is level-shifted down by 128, so that it also falls into the [-128.0, 127.0] range. The input tile in this level-shifted symmetric YCbCr color space is used as the input for the next stage of DWT. The matrix equation for this conversion is shown in the following figure.

$$\begin{bmatrix} Y & Cb & Cr \end{bmatrix} = \begin{bmatrix} R & G & B \end{bmatrix} \begin{bmatrix} 0.299 & -0.168935 & 0.499813 \\ 0.587 & -0.331665 & -0.418531 \\ 0.114 & 0.50059 & -0.081282 \end{bmatrix}$$

Figure 5: The RGB to YCbCr conversion matrix

3.1.8.1.4 DWT

Each tile component (Y, Cb, Cr) is individually transformed by a 2-D DWT using a 5/3 wavelet basis. The filter coefficients used for both of the lifting-based implementations are presented in the following figure.

$$H[n] = \left[\frac{X[2n+1] - \left\lfloor \frac{X[2n] + X[2n+2]}{2} \right\rfloor}{2} \right] \quad L[n] = X[2n] + \left\lfloor \frac{H[n-1] + H[n]}{2} \right\rfloor$$

a. High-pass coefficients b. Low-pass coefficients

Figure 6: Lifting equations for the DWT

Filtering at the boundary is done by mirroring the input coefficients. For example, if there are eight input coefficients:

[0, 1, 2, 3, 4, 5, 6, 7]

then, after mirroring, the coefficients get logically extended as follows:

[..., 7, 6, 5, 4, 3, 2, 1, 0, 1, 2, 3, 4, 5, 6, 7, 6, 5, 4, 3, 2, 1, 0, ...]

This logical extension should be used when filtering at boundaries where coefficients are required before or after the first and last available coefficient.

For each level of decomposition, we first perform the DWT in the vertical direction, followed by the DWT in the horizontal direction. After the first level of decomposition, there are 4 sub-bands: LL1, LH1, HL1, HH1. For each successive level of decomposition, the LL sub-band of the previous level is used as the input. Each tile component undergoes three levels of decomposition. This results in 10 sub-bands per component. LH1, HL1, and HH1 contain the highest frequency bands present in the image tile, while LL3 contains the lowest frequency band.

The three-level DWT decomposition is illustrated in the following figure.

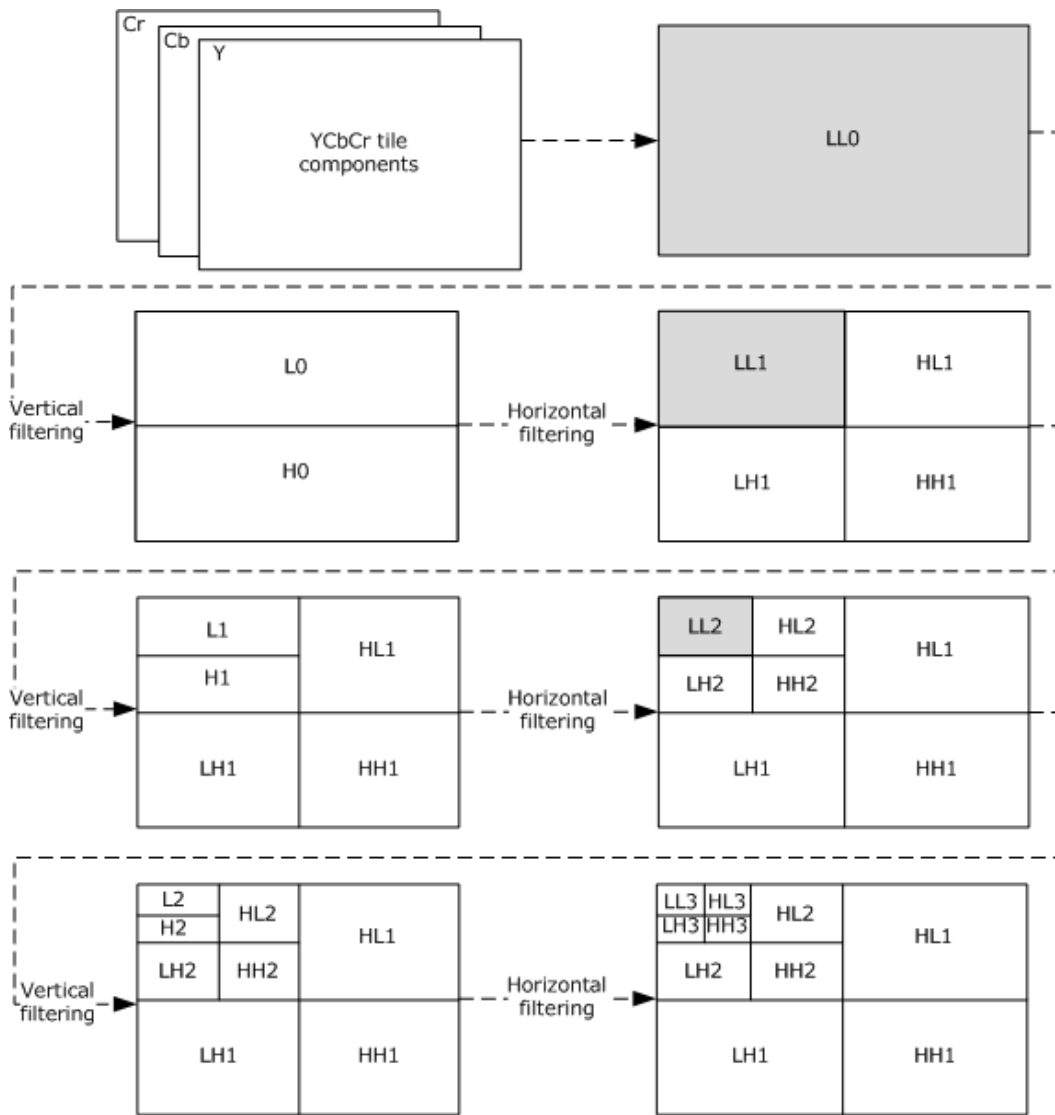

Figure 7: Three-level DWT decomposition

3.1.8.1.5 Quantization

The encoder determines a scale value for each sub-band and uses it to quantize all the coefficients in that sub-band, which is done by dividing each coefficient by the scale value and rounding it. These scale values are represented as quantization factors in a [TS_RFX_CODEC_QUANT](#) structure, which is embedded in a [TS_RFX_TILESET](#) message. The conversion between a scale value and a quantization factor is given by the following figure.

$$\text{Scale_value} = (1 \ll (\text{quantization_factor} - 6))$$

Figure 8: Quantization factor to scale value conversion

3.1.8.1.6 Linearization

The quantized tile components are linearized by raster scanning each of the sub-bands. The sub-band coefficient scan and traversal order is illustrated in the following figure.

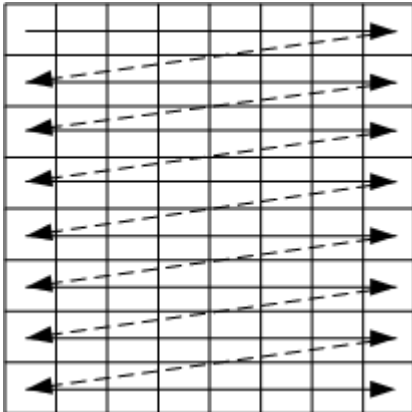

Figure 9: Raster scan of sub-band coefficients

Linearization of the sub-bands is conducted in the following sequence: HL1, LH1, HH1, HL2, LH2, HH2, HL3, LH3, HH3, and LL3, as shown in the following figure.

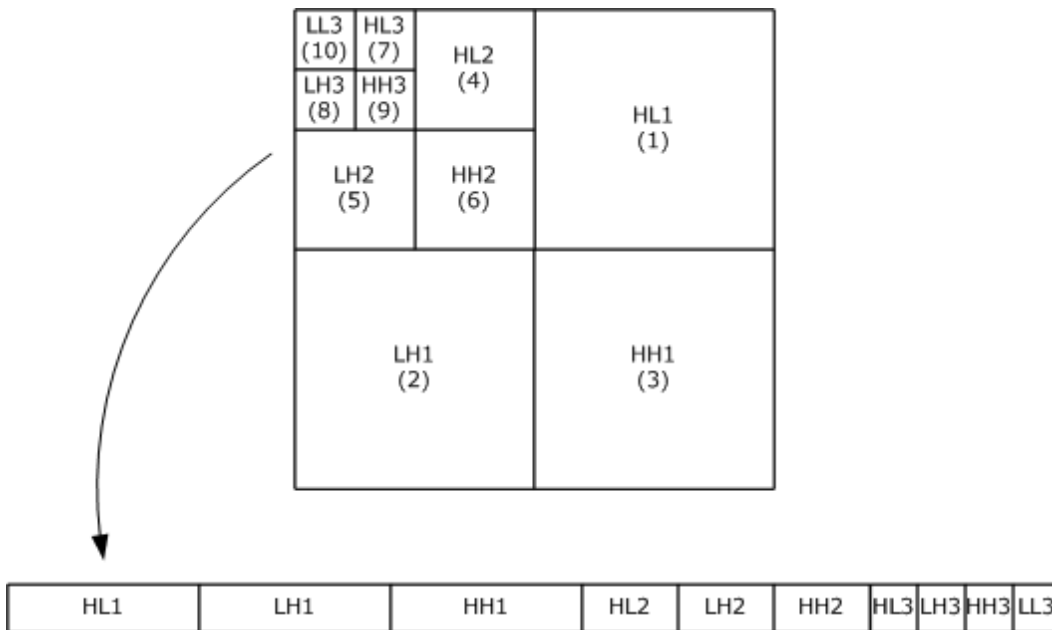

Figure 10: Sub-band traversal order

The coefficients from LL3 also undergo differential encoding. Except for the first coefficient, every raster-scanned LL3 coefficient is subtracted from its previous neighbor. For example, if the raster-scanned LL3 coefficients are

[64, 32, 42, 54, 50, 60, 40, 70]

Then, after differential encoding, they would get converted to

[64, -32, 10, 12, -4, -10, -20, 30]

3.1.8.1.7 RLGR Entropy Encoding

Each 64 x 64-pixel tile contains an array of 4,096 coefficients. This coefficient array is losslessly entropy-encoded using the RLGR algorithm ([\[ARLGR\]](#) section 3). The three tile components are assembled into an encoded tile packet (section [2.2.2.3.4.1](#)). RLGR is an algorithm that adaptively switches between Run-Length encoding of zeros and Golomb-Rice coding of nonzero coefficients. There are two variants of the RLGR algorithm that can be used, RLGR1 and RLGR3. The decoder endpoint specifies its preference through the capabilities negotiation (see the **entropyBits** field in section [2.2.1.1.1.1.1](#)). The pseudocode that describes the complete RLGR1/RLGR3 algorithm in detail is given in section [3.1.8.1.7.3](#).

3.1.8.1.7.1 RLGR1

The RLGR algorithm is described in [\[ARLGR\]](#). In this specification, the parameter adaptation rules, which are central to the algorithm, are detailed in section [\[ARLGR\]](#) section 3. The specific adaptation values used by RLGR1 are given in the following two tables.

$p = 0$	decrease k_R by setting $k_{RP} = k_{RP} - 2$
$p = 1$	no change in k_R
$p > 1$	increase k_R by setting $k_{RP} = k_{RP} + p$

Figure 11: Adaptation rule for RLGR1/RLGR3 parameter k_R

$k = 0$	$u = 0 : k_p = k_p + 3$	
	$u > 0 : k_p = k_p - 3$	
$k > 0$	complete run	$k_p = k_p + 4$
	partial run	$k_p = k_p - 6$

Figure 12: Adaptation rule for RLGR1/RLGR3 main parameter k

The initial value for the parameters k_{RP} and k_p is 8, and the value of L is 8. Both the parameters k_{RP} and k_p are clipped to the range [0, 80] after every update.

3.1.8.1.7.2 RLGR3

The core RLGR algorithm [ARLGR] switches between the Run-Length and the Golomb-Rice mode as a stream of data is encoded, based on the Run-Length parameter, k , as shown in figure "Adaptation rule for RLGR1/RLGR3 main parameter k " in section 3.1.8.1.7.2. The Golomb-Rice mode in the RLGR algorithm [ARLGR], operates by encoding one coefficient at a time and updating the Golomb-Rice parameter, kR , as shown in figure "Adaptation rule for RLGR1/RLGR3 parameter kR " in section 3.1.8.1.7.2. In RLGR3, the Run-Length mode parameter, k , and the Golomb-Rice parameter, kR , are updated exactly as in RLGR1, but the Golomb-Rice mode is processed differently. Once the algorithm enters into the Golomb-Rice mode, RLGR3 takes the sum of the next two coefficients and Golomb-Rice encodes the sum and updates the parameters k and kR as with RLGR1. After the sum is encoded, the value of the first coefficient is emitted as binary code in the exact number of bits it takes to represent the sum. Pseudocode for Golomb-Rice mode in RLGR3 encode follows.

```
ENCODER GOLOMB-RICE MODE:

SUM = COEFF[n] + COEFF[n+1] // sum of the next two coefficients in the input stream
GOLOMB_RICE_ENCODE(SUM)    // Golomb-Rice encode the value of SUM
BINARY_ENCODE(COEFF[n])    // using LOG2(SUM) bits
UPDATE_RLGR_PARAMETERS(SUM) // update RLGR parameters (k,kR) based on SUM
```

The decoder follows the same sequence of steps as the encoder, as it decodes the encoded data. The pseudocode for the decoder in Golomb-Rice mode is given below.

```
DECODER GOLOMB-RICE MODE:

SUM = GOLOMB_RICE_DECODE() // decode the next value from the encoded stream
NBS = LOG2(SUM)            // number of bits in binary representation of SUM
COEFF[n] = BINARY_DECODE(NBS) // read next NBS bits from input stream as COEFF[n]
COEFF[n+1] = SUM - COEFF[n] // compute COEFF[n+1]
UPDATE_RLGR_PARAMETERS(SUM) // update RLGR parameters (k,kR) based on SUM
```

In general, RLGR3 encodes faster than RLGR1 but is marginally worse in terms of compression ratio.

3.1.8.1.7.3 RLGR1/RLGR3 Pseudocode

3.1.8.1.7.3.1 RLGR1/RLGR3 Decode

The following pseudocode sample shows how to decode a stream of bits encoded using the RLGR1/RLGR3 algorithm.

```
// Constants used within the RLGR1/RLGR3 algorithm

#define KPMAX (80) // max value for kp or krp
#define LSGR (3) // shift count to convert kp to k
#define UP_GR (4) // increase in kp after a zero run in RL mode
#define DN_GR (6) // decrease in kp after a nonzero symbol in RL mode
#define UQ_GR (3) // increase in kp after nonzero symbol in GR mode
#define DQ_GR (3) // decrease in kp after zero symbol in GR mode

//
// Gets (returns) the next nBits from the bitstream
// The layout of N bits in the bitstream with regard to a byte array is:
```

```

//      [0..N] -> [0..7] (MSB..LSB), [8..15] (MSB..LSB) ...,
// where (MSB..LSB) denotes a byte.
//

UINT GetBits(
    UINT nBits
    );

//
// From current output pointer, write "value", check and update *termsToDecode
//
VOID
WriteValue(
    INT value,
    INT *termsToDecode
    );

//
// From current output pointer, write next nZeroes terms with value 0;
// check and update *termsToDecode
//
VOID
WriteZeroes(
    UINT nZeroes,
    INT *termsToDecode
    );

//
// Returns the least number of bits required to represent a given value
//
UINT
GetMinBits(
    UINT val// returns ceil(log2(val))
    );

//
// Converts from (2 * magnitude - sign) to integer
//
INT
GetIntFrom2MagSign(
    UINT twoMs
    );

//
// Update the passed parameter and clamp it to the range [0,KPMAX]
// Return the value of parameter right-shifted by LSGR
//
INT
UpdateParam(
    INT* param,    // parameter to update
    INT deltaP    // update delta
    )
{

```



```

    *param += deltaP; // adjust parameter
    if (*param > KPMAX) *param = KPMAX; // max clamp
    if (*param < 0) *param = 0; // min clamp
    return (*param >> LSGR);
}

//
// Outputs the Golomb/Rice encoding of a non-negative integer
//
UINT
GetGRCode(
    INT*   krp,
    INT*   kr
)
{
    INT vk;
    UINT mag;

    // chew up/count leading 1s and escape 0
    for (vk=0; GetBits(1)==1; ) {
        vk++;
    }

    // get next *kr bits, and combine with leading 1s
    mag = (vk<<*kr) | GetBits(*kr);

    // adjust kpr and kr based on vk
    if (!vk)
    {
        *kr = UpdateParam(kpr, -2);
    }
    else if (vk!=1) // at 1, no change!
    {
        *kr = UpdateParam(kpr, vk);
    }

    return (mag);
}

//
// Routine that reads and decodes stream of RLGR data
//
VOID
RLGR_Decode(
    RLGR_MODE rlgrMode, // RLGR1 || RLGR3
    INT termsToDecode
)
{
    // initialize the parameters
    INT k = 1;
    INT kp = k << LSGR;
    INT kr = 1;
    INT krp = kr << LSGR;
}

```

```

while (termsToDecode > 0)
{
    INT run;

    if (k)
    {
        // RL MODE
        while (GetBits(1) == 0)
        {
            // we have an RL escape "0", which translates to a run (1<<k) of zeros
            WriteZeroes(1<<k, &termsToDecode);
            k = UpdateParam(&kp,UpGR); // raise k and kp up because of zero run
        }

        if (termsToDecode > 0)
        {
            // next k bits will contain remaining run of zeros
            run = GetBits(k);
            WriteZeroes(run, &termsToDecode);
        }

        if (termsToDecode > 0)
        {
            // get nonzero value, starting with sign bit and
            // then GRCode for magnitude - 1
            UINT sign = GetBits(1);

            // magnitude - 1 was coded (because it was nonzero)
            INT mag = (INT)GetGRCode(&krp,&kr) + 1;

            WriteValue(sign ? -mag : mag, &termsToDecode);
            k = UpdateParam(&kp, -DnGR); // lower k and kp because of nonzero term
        }
    }
    else
    {
        // GR (GOLOMB-RICE) MODE
        UINT mag = GetGRCode(&krp, &kr); // values coded are 2*magnitude - sign

        if (rlgrMode == RLGR1)
        {
            if (!mag)
            {
                WriteValue(0, &termsToDecode);
                k = UpdateParam(&kp, UqGR); // raise k and kp due to zero
            }
            else
            {
                WriteValue(GetIntFrom2MagSign(mag), &termsToDecode);
                k = UpdateParam(&kp, -DqGR); // lower k and kp due to nonzero
            }
        }
        else // rlgrMode == RLGR3
        {
            // In GR mode FOR RLGR3, we have encoded the
            // sum of two (2*mag - sign) values

            // maximum possible bits for first term

```

```

        UINT nIdx = GetMinBits(mag);

        // decode val1 is first term's (2*mag - sign) value
        UINT val1 = GetBits(nIdx);

        // val2 is second term's (2*mag - sign) value
        UINT val2 = mag - val1;

        if (val1 && val2) {
            // raise k and kp if both terms nonzero
            k = UpdateParam(&kp, -2*DqGR);
        }
        else if (!val1 && !val2) {
            // lower k and kp if both terms zero
            k = UpdateParam(&kp, 2*UqGR);
        }

        WriteValue(GetIntFrom2MagSign(val1), &termsToDecode);
        WriteValue(GetIntFrom2MagSign(val2), &termsToDecode);
    }
}
}
}
}

```

3.1.8.1.7.3.2 RLGR1/RLGR3 Encode

The following pseudocode sample shows how to encode a stream of input symbols using the RLGR1/RLGR3 algorithm.

```

// Constants used within the RLGR1/RLGR3 algorithm

#define KPMAX    (80)    // max value for kp or krp
#define LSGR     (3)     // shift count to convert kp to k
#define UP_GR    (4)     // increase in kp after a zero run in RL mode
#define DN_GR    (6)     // decrease in kp after a nonzero symbol in RL mode
#define UQ_GR    (3)     // increase in kp after nonzero symbol in GR mode
#define DQ_GR    (3)     // decrease in kp after zero symbol in GR mode

//
// Returns the next coefficient (a signed int) to encode, from the input stream
//
INT
GetNextInput();

//
// Emit bitPattern to the output bitstream.
// The bitPattern value represents a bit sequence that is generated by shifting
// new bits in from the right. If we take the binary representation of bitPattern,
// with N(numBits-1) being the leftmost bit position and 0 being the rightmost bit position,
// the mapping of bitPattern to the output bytes is as follows:
//
//      bitPattern[N..0] -> byte[MSB..LSB] .. byte[MSB..LSB]
//
VOID

```

```

OutputBits(
    INT numBits,      // number of bits in bitPattern
    INT bitPattern    // bit pattern
);

//
// Emit a bit (0 or 1), count number of times, to the output bitstream
//
VOID
OutputBit(
    INT count,       // number of times to emit the bit
    INT bit          // 0 or 1
);

//
// Returns the least number of bits required to represent a given value
//
UINT
GetMinBits(
    INT val          // returns ceil(log2(val))
);

//
// Converts the input value to (2 * abs(input) - sign(input)),
// where sign(input) = (input < 0 ? 1 : 0) and returns it
//
UINT
Get2MagSign(
    INT input        // input value
);

//
// Update the passed parameter and clamp it to the range [0,KPMAX]
// Return the value of parameter right-shifted by LSGR
//
INT
UpdateParam(
    INT* param,     // parameter to update
    INT deltaP      // update delta
)
{
    *param += deltaP;
    if (*param > KPMAX) *param = KPMAX;
    if (*param < 0) *param = 0;
    return (*param >> LSGR);
}

//
// Outputs the Golomb/Rice encoding of a non-negative integer
//
VOID
CodeGR(
    INT* krp,       // GR parameter, used and updated based on the input value
    UINT val        // input non-negative value to be encoded
)
{
    INT kr = *krp >> LSGR;

```

```

// unary part of GR code

UINT vk = val >> kr;
OutputBit(vk, 1);
OutputBit(1, 0);

// remainder part of GR code, if needed
if (kr) {
    OutputBits(kr, val & ((1 << kr) - 1));
}

// update krp, only if it is not equal to 1
if (vk == 0) {
    UpdateParam(krp, -2);
}
else if (vk > 1) {
    UpdateParam(krp, vk);
}
}

//
// Routine that outputs a stream of RLGR1/RLGR3-encoded bits
//
VOID
RLGR_Encode(
    RLGR_MODE rlgrMode    // RLGR1 || RLGR3
)
{
    // initialize the parameters
    INT k = 1;
    INT kp = 1 << LSGR;
    INT kr = 1;
    INT krp = 1 << LSGR;

    // process all the input coefficients
    while (1)
    {
        INT input;

        if (k)
        {
            // RUN-LENGTH MODE

            // collect the run of zeros in the input stream
            INT numZeros = 0;
            while ((input = GetNextInput()) == 0) {
                ++ numZeros;
            }

            // emit output zeros
            INT runmax = 1 << k;
            while (numZeros >= runmax)
            {
                OutputBit(1, 0);          // output a zero bit
                numZeros -= runmax;
                k = UpdateParam(&kp, UpGR); // update kp, k
                runmax = 1 << k;
            }
        }
    }
}

```

```

    }

    // output a 1 to terminate runs
    OutputBit(1, 1);

    // output the remaining run length using k bits
    OutputBits(k, numZeros);

    // encode the nonzero value using GR coding

    INT mag = abs(input);           // absolute value of input coefficient
    INT sign = (input < 0 ? 1 : 0); // sign of input coefficient

    OutputBit(1, sign);           // output the sign bit
    CodeGR(&krp, mag - 1);       // output GR code for (mag - 1)

    k = UpdateParam(&kp, -DnGR);
}
else
{
    // GOLOMB-RICE MODE

    if (rlgrMode == RLGR1)
    {
        // RLGR1 variant

        // convert input to (2*magnitude - sign), encode using GR code
        UINT twoMs = Get2MagSign(GetNextInput());
        CodeGR(&krp, twoMs);

        // update k, kp
        if (!twoMs) {
            k = UpdateParam(&kp, UqGR);
        }
        else {
            k = UpdateParam(&kp, -DqGR);
        }
    }
    else // rlgrMode == RLGR3
    {
        // RLGR3 variant

        // convert the next two input values to (2*magnitude - sign) and
        // encode their sum using GR code

        UINT twoMs1 = Get2MagSign(GetNextInput());
        UINT twoMs2 = Get2MagSign(GetNextInput());
        UINT sum2Ms = twoMs1 + twoMs2;

        CodeGR(&krp, sum2Ms);

        // encode binary representation of the first input (twoMs1).
        OutputBits(GetMinBits(sum2Ms), twoMs1);

        // update k,kp for the two input values

        if (twoMs1 && twoMs2) {
            k = UpdateParam(&kp, -2*DqGR);
        }
    }
}

```

```

        else if (!twoMs1 && !twoMs2) {
            k = UpdateParam(&kp, 2*UqGR);
        }
    }
}
}
}
}

```

3.1.8.2 Decoding

The functional stages involved in the decoding path are illustrated in the following figure. Compared to the encoding stages, the decoding stage operations are the operations of the encoding stage in reverse order.

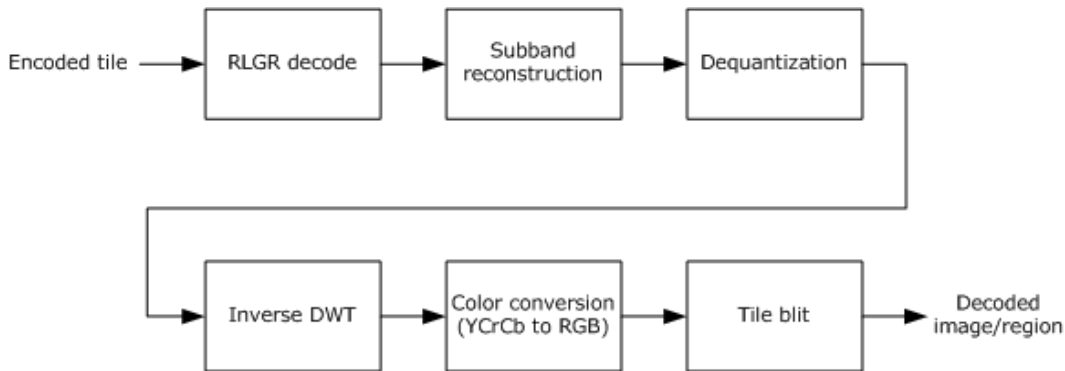

Figure 13: RemoteFX decoding stages

3.1.8.2.1 RLGR Entropy Decoding

The three encoded tile components (Y, Cb, and Cr) are entropy decoded independently. The algorithm used is either inverse RLGR1 or RLGR3, depending on which one was used for encoding. For details of the decoding process, refer to [\[ARLGR\]](#) (the encoding process is described in section [3.1.8.1.7](#)).

3.1.8.2.2 Sub-Band Reconstruction

The RLGR entropy decoding stage results in the generation of an array of 4096 coefficients per tile component. The last 64 coefficients (which correspond to the LL3 sub-band) are differentially decoded. After this step, the coefficients are rearranged to form the sub-band structure shown in the figure in section [3.1.8.1.6](#) that describes the sub-band traversal order.

3.1.8.2.3 Dequantization

The quantization factors used for each sub-band are specified in the TS_RFX_TILE (section [2.2.2.3.4.1](#)) structure. A scale value is computed from the quantization factor using the formula shown in the figure in section [3.1.8.1.5](#). Each coefficient in the appropriate sub-band is dequantized by multiplying it with this scale value and rounded.

3.1.8.2.4 Inverse DWT

Each tile component undergoes three levels of inverse discrete wavelet transformation (IDWT). The 5/3 lifting equations used for the IDWT are presented in the following figure.

$$X[2n] = L[n] - \left[\frac{H[n-1] + H[n] + 1}{2} \right] \quad X[2n+1] = 2 * H[n] + \left[\frac{X[2n] + X[2n+2]}{2} \right]$$

a. Even coefficients b. Odd coefficients

Figure 14: Lifting equations for inverse DWT

This stage results in the decoded Y, Cb, and Cr components for the tile.

3.1.8.2.5 Color Conversion (YCbCr to RGB)

The Y-component is first level shifted up by 128 so that it falls in the [0.0, 255.0] range. The three YCbCr components are then transformed to the RGB color space by using the following transform matrix.

$$\begin{bmatrix} R & G & B \end{bmatrix} = \begin{bmatrix} Y & Cb & Cr \end{bmatrix} \begin{bmatrix} 1.0 & 1.0 & 1.0 \\ 0.0 & -0.344 & 1.77 \\ 1.403 & -0.714 & 0.0 \end{bmatrix}$$

Figure 15: The YCbCr to RGB conversion matrix

3.1.8.2.6 Reconstructed Frame

Each decoded RGB tile is intersected and clipped against the set of rectangles from the **rects** field of the [TS_RFX_REGION \(section 2.2.2.3.3\)](#) message. This gives a set of clipped rectangles, which are blitted to the appropriate location on the screen. Doing this for all the tiles present in the [TS_RFX_TILESET \(section 2.2.2.3.4\)](#) message will result in the reconstructed frame.

There are two reasons for doing this tile-region intersection. One is that the changed region on the screen, which comprises a set of arbitrary-sized rectangles, is converted to 64x64 tiles (section [3.1.8.1.1](#)) and these tiles can extend beyond the boundary of the rectangles of the change region. The second reason is that the differencing operation (section [3.1.8.1.2](#)) could cull some of these tiles and the decoder will not receive these tiles within the TS_RFX_TILESET message.

3.1.8.3 RemoteFX Stream

A RemoteFX stream is defined to be the set of all of the codec messages, sent sequentially from an encoder endpoint to a decoder endpoint. There is no message to signify the end of a stream. If the RemoteFX codec is to be used as an image codec, the stream only contains messages pertaining to a single image. If the RemoteFX codec is to be used as a video codec, the stream can contain an arbitrary number of images.

3.1.8.3.1 Encode Message Sequencing

An encoded RemoteFX stream is composed of a sequence of encode messages that are described in section [2.2.2](#). The sequence of encode messages is encapsulated inside an Extended Bitmap Data structure ([\[MS-RDPBCGR\] section 2.2.9.2.1.1](#)), which is encapsulated in a Stream Surface Bits Surface Command ([\[MS-RDPBCGR\] section 2.2.9.2.2](#)).

All encode messages start with a TS_RFX_BLOCKT (section [2.2.2.1.1](#)) structure. When parsing the message blocks, the **blockLen** field of a TS_RFX_BLOCKT MUST be used to obtain the length of the data block. This length MUST NOT be less than the length based on the **blockType** field of the TS_RFX_BLOCKT.

The RemoteFX stream is structured as a set of header messages followed by encoded data messages. The header messages contain global information necessary to decompress the data messages. The header messages are described in section [2.2.2.2](#), and the data messages are described in section [2.2.2.3](#). The stream MUST start with the header messages and any of these headers can appear in the stream at a later stage. The header messages can be repeated.

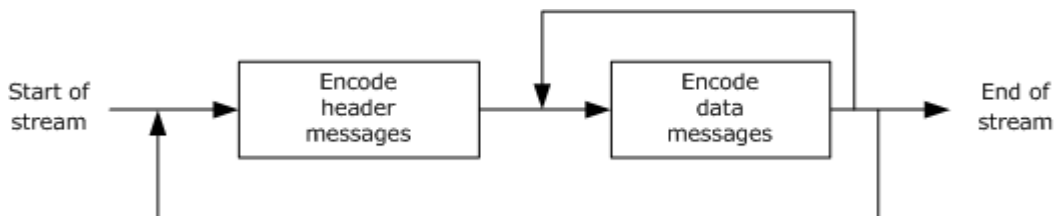

Figure 16: Message sequencing in the RemoteFX stream

The first message in a RemoteFX stream MUST be the TS_RFX_SYNC (section [2.2.2.2.1](#)) message. This message MUST be followed by the TS_RFX_CHANNELS (section [2.2.2.2.3](#)), TS_RFX_CODEC_VERSIONS (section [2.2.2.2.2](#)), and TS_RFX_CONTEXT (section [2.2.2.2.4](#)) messages, as shown in the figure that follows. It is permissible for these three messages to occur in any order. These three messages contain all of the information needed to initialize the decoder.

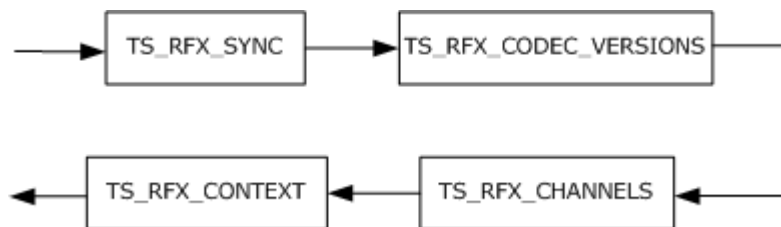

Figure 17: Generation of RemoteFX encode header messages

The TS_RFX_CHANNELS message MUST contain a single channel, and the frame dimensions of this channel are given by the **width** and **height** fields of the corresponding [TS_RFX_CHANNELT](#) structure (section [2.2.2.1.3](#)). The decoder MUST check the TS_RFX_CODEC_VERSIONS and TS_RFX_CONTEXT messages to determine whether it is compatible with the RemoteFX codec version and the encoding properties listed in these messages. If the decoder cannot support the codec version, the channel frame dimensions, or any of the listed encoding properties, it MUST reject the encoded stream.

The data associated with each encoded frame or image is always bracketed by the TS_RFX_FRAME_BEGIN (section [2.2.2.3.1](#)) and TS_RFX_FRAME_END (section [2.2.2.3.2](#)) messages. The sequence of blocks that comprise a frame are described in the figure that follows. There MUST only be one TS_RFX_REGION (section [2.2.2.3.3](#)) message per frame and one TS_RFX_TILESET (section [2.2.2.3.4](#)) message per TS_RFX_REGION. All of the messages corresponding to a frame associated with a given channel MUST occur consecutively within the codec byte-stream. The messages corresponding to frames from two different channels MUST NOT be interleaved.

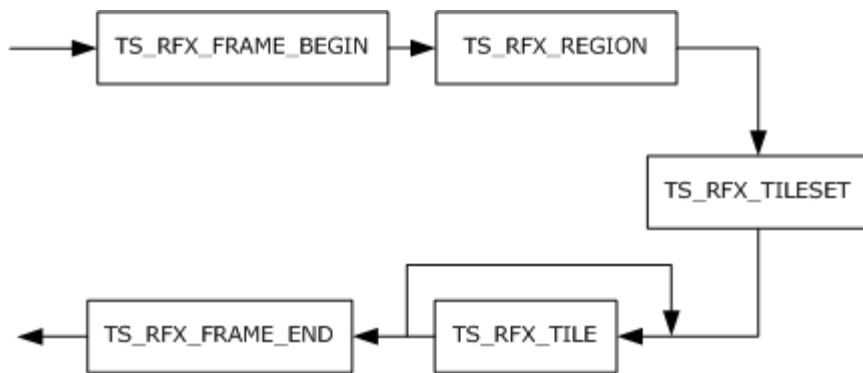

Figure 18: Generation of RemoteFX encode data messages

4 Protocol Examples

4.1 Sample Use Case

Consider the case of a remote endpoint system with one monitor configured to use a display resolution of 1280 x 1024 pixels. In this scenario, there is one instance of the RemoteFX encoder running on the remote system. The encoder is configured to use one channel with frame buffer dimensions of 1280 x 1024. As the contents of the screen are updated over time, the changes are captured, and the affected regions in the frame buffer corresponding to the bounding rectangles of the updated areas are fed as input to the encoder to compress.

The encoder examines the update regions and determines the set of tiles that correspond to those regions. The tile grid is anchored to the frame at (0, 0) and aligned to the tile size. This means that as an update region (for example, a window being dragged) moves around on the screen, the number of tiles corresponding to that update region can vary. In the figure that follows, the regions A and B are the same size (3 x 3) but they correspond to 9 and 16 tiles respectively due to their location on the screen. In the case of border tiles where the update region is not aligned to the tile grid, the area of the tile outside of the actual update region can contain arbitrary data and hence cannot be relied upon to contain valid image data. In the figure that follows, region B is not aligned to the tile grid and hence the perimeter tiles only contain a partial image.

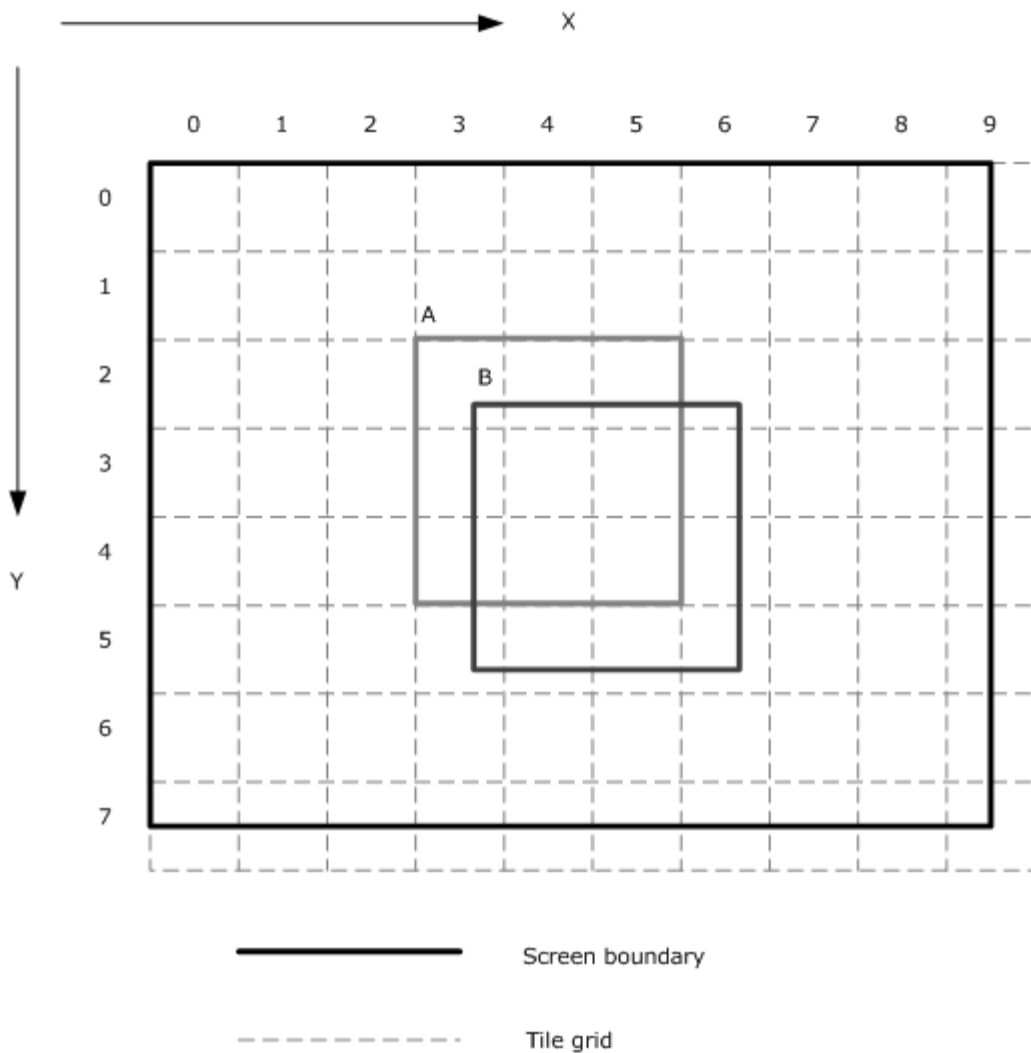

Figure 19: Update region to tile grid mapping

The single monitor configuration results in a `TS_RFX_CHANNELS` (section [2.2.2.2.3](#)) header message that specifies one channel set to 1280 x 1024. For every frame that is encoded due to region updates, the message sequence that results is described in the encode messages diagram in section [3.1.8.3.1](#). The `TS_RFX_REGION` (section [2.2.2.3.3](#)) message contains the list of updated rectangles, and the accompanying `TS_RFX_TILESET` (section [2.2.2.3.4](#)) message contains the corresponding set of tiles. The `TS_RFX_TILE` (section [2.2.2.3.4.1](#)) structure contains the location of the tile in the frame. Conceptually, the decoder can decode each tile, **blit** it to the proper location in a temporary frame buffer, and then blit all of the updated rectangles to an output frame buffer.

4.2 Annotated RemoteFX Messages

4.2.1 Capabilities Messages

The following is an annotated network capture of the `TS_RFX_CLNT_CAPS_CONTAINER` message (section [2.2.1.1](#)).

```
00000000 31 00 00 00 01 00 00 00 25 00 00 00 c0 cb 08 00
00000010 00 00 01 00 c1 cb 1d 00 00 00 01 c0 cf 02 00 08
00000020 00 00 01 40 00 00 01 01 01 00 01 40 00 00 01 01
00000030 04
```

[TS_RFX_CAPS](#) message (section [2.2.1.1.1](#)):

```
c0 cb -> TS_RFX_CAPS::blockType = CBY_CAPS
08 00 00 00 -> TS_RFX_CAPS::blockLen = 8
01 00 -> TS_RFX_CAPS::numCapsets = 1
```

[TS_RFX_CAPSET](#) message (section [2.2.1.1.1.1](#)):

```
c1 cb -> TS_RFX_CAPS::TS_RFX_CAPSET[0]::blockType = CBY_CAPSET
1d 00 00 00 -> TS_RFX_CAPS::TS_RFX_CAPSET[0]::blockLen = 29
01 -> TS_RFX_CAPS::TS_RFX_CAPSET[0]::codecId = 1
C0 cf -> TS_RFX_CAPS::TS_RFX_CAPSET[0]::capsetType = CLY_CAPSET
02 00 -> TS_RFX_CAPS::TS_RFX_CAPSET[0]::numIcaps = 2
08 00 -> TS_RFX_CAPS::TS_RFX_CAPSET[0]::icapLen = 8
```

[TS_RFX_ICAP](#) message (section [2.2.1.1.1.1.1](#)):

```
00 01 -> TS_RFX_CAPS::TS_RFX_CAPSET[0]::TS_RFX_ICAP[0]::version = CLW_VERSION_1_0
40 00 -> TS_RFX_CAPS::TS_RFX_CAPSET[0]::TS_RFX_ICAP[0]::tileSize = 64
00 -> TS_RFX_CAPS::TS_RFX_CAPSET[0]::TS_RFX_ICAP[0]::flags = VIDEO_MODE (0)
01 -> TS_RFX_CAPS::TS_RFX_CAPSET[0]::TS_RFX_ICAP[0]::colConvBits = CLW_COL_CONV_ICT
01 -> TS_RFX_CAPS::TS_RFX_CAPSET[0]::TS_RFX_ICAP[0]::transformBits = CLW_XFORM_DWT_53_A
01 -> TS_RFX_CAPS::TS_RFX_CAPSET[0]::TS_RFX_ICAP[0]::entropyBits = CLW_ENTROPY_RLGR1
00 01 -> TS_RFX_CAPS::TS_RFX_CAPSET[0]::TS_RFX_ICAP[1]::version = CLW_VERSION_1_0
40 00 -> TS_RFX_CAPS::TS_RFX_CAPSET[0]::TS_RFX_ICAP[1]::tileSize = 64
00 -> TS_RFX_CAPS::TS_RFX_CAPSET[0]::TS_RFX_ICAP[1]::flags = VIDEO_MODE (0)
01 -> TS_RFX_CAPS::TS_RFX_CAPSET[0]::TS_RFX_ICAP[1]::colConvBits = CLW_COL_CONV_ICT
01 -> TS_RFX_CAPS::TS_RFX_CAPSET[0]::TS_RFX_ICAP[1]::transformBits = CLW_XFORM_DWT_53_A
04 -> TS_RFX_CAPS::TS_RFX_CAPSET[0]::TS_RFX_ICAP[1]::entropyBits = CLW_ENTROPY_RLGR3
```

The client has specified support for both RLGR1 and RLGR3, by including two `TS_RFX_ICAP` elements. The server can pick either of the two and use the corresponding encoding properties, as described in section [3.1.5.1](#).

The following is an annotated dump of the [TS_RFX_SRVR_CAPS_CONTAINER](#) message (section [2.2.1.2](#)).

```
00000000 00 00 00 00 00 00 00 00 00 00 00 00 00 00 00 00
00000010 00 00 00 00 00 00 00 00 00 00 00 00 00 00 00 00
00000020 00 00 00 00 00 00 00 00 00 00 00 00 00 00 00 00
00000030 00 00 00 00 00 00 00 00 00 00 00 00 00 00 00 00
```

The server has sent an array of bytes set to zero as described in section [2.2.1.2](#).

4.2.2 Encode Header Messages

The following is an annotated network capture of the [Encode Header Messages \(section 2.2.2.2\)](#).

```
00000000 c0 cc 0c 00 00 00 ca ac cc ca 00 01 c3 cc 0d 00
00000010 00 00 01 ff 00 40 00 28 a8 c1 cc 0a 00 00 00 01
00000020 01 00 01 c2 cc 0c 00 00 00 01 00 40 00 40 00
```

[TS_RFX_SYNC](#) message (section [2.2.2.2.1](#)):

```
c0 cc -> TS_RFX_SYNC::BlockT::blockType = WBT_SYNC
0c 00 00 00 -> TS_RFX_SYNC::BlockT::blockLen = 12
ca ac cc ca -> TS_RFX_SYNC::magic = WF_MAGIC
00 01 -> TS_RFX_SYNC::version = 0x0100
```

[TS_RFX_CONTEXT](#) message (section [2.2.2.2.4](#)):

```
c3 cc -> TS_RFX_CONTEXT::CodecChannelT::BlockT::blockType = WBT_CONTEXT
0d 00 00 00 -> TS_RFX_CONTEXT::CodecChannelT::BlockT::blockLen = 13
01 -> TS_RFX_CONTEXT::CodecChannelT::codecId = 1
ff -> TS_RFX_CONTEXT::CodecChannelT::channelId = 255
00 -> TS_RFX_CONTEXT::ctxId = 0
40 00 -> TS_RFX_CONTEXT::tileSize = 64
28 a8 -> TS_RFX_CONTEXT::properties
TS_RFX_CONTEXT::properties::flags = VIDEO_MODE (0)
TS_RFX_CONTEXT::properties::cct = COL_CONV_ICT (1)
TS_RFX_CONTEXT::properties::xft = CLW_XFORM_DWT_53_A (1)
TS_RFX_CONTEXT::properties::et = CLW_ENTROPY_RLGR3 (4)
TS_RFX_CONTEXT::properties::qt = SCALAR_QUANTIZATION (1)
TS_RFX_CONTEXT::properties::r = RESERVED
```

[TS_RFX_CODEC_VERSIONS](#) message (section [2.2.2.2.2](#)):

```
c1 cc -> TS_RFX_CODEC_VERSIONS::BlockT::blockType = WBT_CODEC_VERSION
0a 00 00 00 -> TS_RFX_CODEC_VERSIONS::BlockT::blockLen = 10
01 -> TS_RFX_CODEC_VERSIONS::numCodecs = 1
01 -> TS_RFX_CODEC_VERSIONS::TS_RFX_CODEC_VERSIONT::codecId = 1
00 01 -> TS_RFX_CODEC_VERSIONS::TS_RFX_CODEC_VERSIONT::version 0x0100
```

[TS_RFX_CHANNELS](#) message (section [2.2.2.2.3](#)):

```
c2 cc -> TS_RFX_CHANNELS::BlockT::blockType = WBT_CHANNELS
0c 00 00 00 -> TS_RFX_CHANNELS::BlockT::blockLen = 12
01 -> TS_RFX_CHANNELS::numChannels = 1
00 -> TS_RFX_CHANNELS::TS_RFX_CHANNELT::channelId = 0
40 00 -> TS_RFX_CHANNELS::TS_RFX_CHANNELT::width = 64
40 00 -> TS_RFX_CHANNELS::TS_RFX_CHANNELT::height = 64
```

The server has chosen to encode using RLGR3 (TS_RFX_CONTEXT) and specified one channel with dimensions of 64x64 (TS_RFX_CHANNELS).

4.2.3 Encode Data Messages

The following is an annotated network capture of the [Encode Data Messages \(section 2.2.2.3\)](#).

```
00000000 c4 cc 0e 00 00 00 01 00 00 00 00 00 01 00 c6 cc
```

00000010 17 00 00 00 01 00 cd 01 00 00 00 00 00 40 00 40
00000020 00 c1 ca 01 00 c7 cc d9 03 00 00 01 00 c2 ca 00
00000030 00 51 50 01 40 01 00 be 03 00 00 66 66 77 88 98
00000040 c3 ca be 03 00 00 00 00 00 00 00 00 00 26 01 3d
00000050 01 48 01 19 82 1d 10 62 9d 28 85 2c a2 14 b2 88
00000060 52 ca 21 4b 28 85 2c a2 14 b2 88 52 ca 21 4b 28
00000070 85 2c a2 14 b2 88 52 ca 21 4b 28 85 2c a2 14 b2
00000080 88 52 ca 21 4b 28 85 2c a2 14 b2 88 52 ca 21 4b
00000090 28 85 2c a2 14 b2 88 52 ca 21 4b 28 85 2c a2 14
000000A0 b2 88 52 ca 21 4b 28 85 2c a2 14 b0 00 20 f4 40
000000B0 0c c1 1e 20 26 22 20 33 23 c4 23 88 86 50 f1 22
000000C0 68 4c 91 85 10 34 4c 84 78 a2 0d 13 21 1e 29 06
000000D0 89 90 8f 14 83 44 f4 23 c5 20 d1 3d 08 f1 48 34
000000E0 4f 42 3c 52 0d 13 d0 8f 14 83 44 f4 23 c5 20 d1
000000F0 3d 08 f1 48 34 4f 42 3c 52 0d 13 d0 8f 14 83 44
00000100 f4 23 c5 20 00 08 47 70 15 02 e0 7f e4 9d c2 51
00000110 71 f4 99 c9 57 ff 32 87 9d 17 d6 50 6e 06 2f ac
00000120 a0 9c 0c 5f 59 41 38 18 be b2 82 70 31 7d 65 00
00000130 00 10 ff 9c 33 41 f1 c4 b0 3c ff a2 15 bd 7b ea
00000140 86 9b 5f fc 78 8c f5 ed a8 68 da fd 3c 45 7a f4
00000150 d4 34 6d 7e 9e 22 bd 7a 6a 1a 36 bf 4f 11 5e bd
00000160 35 0d 1b 5f a7 88 af 5e 9a 86 8d af d3 c4 57 af
00000170 4d 43 46 d7 e9 e2 20 30 00 1b 04 7f 04 31 5f c2
00000180 94 af 05 29 5e 0a 52 bc 14 a5 78 29 25 78 29 25
00000190 78 29 25 68 52 4a f0 52 4a f0 52 4a d0 a4 95 e0
000001A0 a4 95 e0 a4 95 a1 49 2b c1 49 2b c1 49 2b 42 92
000001B0 57 82 92 57 82 92 56 85 24 af 05 24 af 05 24 ad
000001C0 0a 49 5e 0a 49 5e 0a 49 5a 14 92 bc 14 92 bc 14
000001D0 92 b4 29 25 78 29 25 78 00 02 0f 02 00 ac 13 fc
000001E0 c0 0a 20 10 2b 27 f9 80 b0 08 aa 3d 60 8c 0b 24
000001F0 ff 30 80 c0 aa 13 fc c2 03 05 90 9f e6 10 18 2c
00000200 84 ff 30 81 82 c8 4f f3 08 18 2c 84 ff 31 03 05
00000210 90 9f ff d8 40 60 59 09 fe 61 01 81 64 27 f9 84
00000220 06 0b 21 3f cc 20 30 59 09 fe 61 03 05 90 9f e6
00000230 10 30 59 09 fe 62 00 00 42 15 00 10 15 01 fe 20
00000240 84 d5 01 0a 8f f1 40 33 78 17 f9 c2 03 83 01 78
00000250 e1 01 c1 00 bc 70 80 e0 80 5e 38 40 70 40 2f 1c
00000260 20 38 20 17 8e 10 00 00 87 d5 08 70 ef 81 a2 d8
00000270 ff ff ff fb d1 2d 4e a6 ce 20 a4 ef 05 78 35 3a
00000280 9b 38 82 93 bc 15 e0 d4 ea 66 71 05 27 78 2b c1
00000290 29 d4 cc e2 0a 4e f0 57 82 53 a9 99 c4 14 9d e0
000002A0 af 04 a7 53 33 88 29 3b c1 5e 09 4e a6 67 10 52
000002B0 77 82 bc 00 18 00 1b fc 11 c1 0f 4a c1 4f 4a c1
000002C0 4f 4a a1 4d 95 42 9e 95 42 9e 95 42 9b 2a 85 3d
000002D0 2a 85 3d 2a 85 36 55 0a 7a 55 0a 7a 55 0a 6c aa
000002E0 14 f4 aa 14 f4 aa 14 d9 54 29 e9 54 29 e9 54 29
000002F0 b2 a8 53 d2 a8 53 d2 a8 53 65 50 a7 a5 50 a7 a5
00000300 50 a6 ca a1 4f 4a a1 4f 4a a1 4d 95 42 9e 95 42
00000310 9e 95 42 9b 2a 80 00 41 e3 80 3f e2 09 9c 00 22
00000320 07 03 e1 26 70 06 07 1f 04 67 00 61 df 02 67 00
00000330 0c 3b fe 01 33 80 06 1d ff 00 99 c0 03 0e ff 80
00000340 4c e0 01 87 7f c0 26 70 00 c3 bf e0 13 38 00 61
00000350 df f0 09 9c 00 30 ef f8 04 ce 00 18 77 fc 02 67
00000360 00 0c 3b fe 01 33 80 06 1d ff 00 99 c0 03 0e ff
00000370 80 4c e0 01 87 7f c0 26 70 00 00 08 3c 20 1f f1
00000380 00 f0 05 02 93 84 3d 20 f0 52 81 c7 ff ff ea 54
00000390 01 80 05 f5 4a 80 30 00 b6 a5 40 18 00 5f 54 a8
000003A0 03 00 0b ea 95 00 60 01 6d 4a 80 30 00 00 22 3f
000003B0 ba 08 10 2b 1f f2 20 3e 49 9c 1f 6e 0f 5a 0f fb

```
000003C0 18 46 ae 27 9b 83 cb 41 f3 18 46 ae 27 9b 83 c5
000003D0 a0 f9 8c 22 d7 13 8d c1 e2 d0 7c c6 11 6b 89 c6
000003E0 e0 f1 68 3e 63 08 b5 c4 e3 70 78 b4 1f 31 84 5a
000003F0 e2 71 b8 3c 5a 0f 98 c2 2d 71 30 83 c0 00 c5 cc
00000400 08 00 00 00 01 00
```

TS_RFX_FRAME_BEGIN message (section [2.2.2.3.1](#)):

```
c4 cc -> TS_RFX_FRAME_BEGIN::CodecChannelT::blockType = WBT_FRAME_BEGIN
0e 00 00 00 -> TS_RFX_FRAME_BEGIN::CodecChannelT::blockLen = 14
01 -> TS_RFX_FRAME_BEGIN::CodecChannelT::codecId = 1
00 -> TS_RFX_FRAME_BEGIN::CodecChannelT::channelId = 0
00 00 00 00 -> TS_RFX_FRAME_BEGIN::frameIdx = 0
01 00 -> TS_RFX_FRAME_BEGIN::numRegions = 1
```

TS_RFX_REGION message (section [2.2.2.3.3](#)):

```
c6 cc -> TS_RFX_REGION::CodecChannelT::blockType = WBT_REGION
17 00 00 00 -> TS_RFX_REGION::CodecChannelT::blockLen = 23
01 -> TS_RFX_REGION::CodecChannelT::codecId = 1
00 -> TS_RFX_REGION::CodecChannelT::channelId = 0
0d -> TS_RFX_REGION::regionFlags
TS_RFX_REGION::regionFlags::lrf = 1
01 00 -> TS_RFX_REGION::numRects = 1
00 00 -> TS_RFX_REGION::TS_RFX_RECT::x = 0
00 00 -> TS_RFX_REGION::TS_RFX_RECT::y = 0
40 00 -> TS_RFX_REGION::TS_RFX_RECT::width = 64
40 00 -> TS_RFX_REGION::TS_RFX_RECT::height = 64
c1 ca -> TS_RFX_REGION::regionType = CBT_REGION
01 00 -> TS_RFX_REGION::numTilesets = 1
```

TS_RFX_TILESET message (section [2.2.2.3.4](#)):

```
c7 cc -> TS_RFX_TILESET::CodecChannelT::blockType = WBT_EXTENSION
d9 03 00 00 -> TS_RFX_TILESET::CodecChannelT::blockLen = 985
01 -> TS_RFX_TILESET::codecId = 1
00 -> TS_RFX_TILESET::channelId = 0
c2 ca -> TS_RFX_TILESET::subtype = CBT_TILESET
00 00 -> TS_RFX_TILESET::idx = 0x00
51 50 -> TS_RFX_TILESET::properties
TS_RFX_TILESET::properties::lt = TRUE (1)
TS_RFX_TILESET::properties::flags = VIDEO_MODE (0)
TS_RFX_TILESET::properties::cct = COL_CONV_ICT (1)
TS_RFX_TILESET::properties::xft = CLW_XFORM_DWT_53_A (1)
TS_RFX_TILESET::properties::et = CLW_ENTROPY_RLGR3 (4)
TS_RFX_TILESET::properties::qt = SCALAR_QUANTIZATION (1)
01 -> TS_RFX_TILESET::numQuant = 1
40 -> TS_RFX_TILESET::tileSize = 64
01 00 -> TS_RFX_TILESET::numTiles = 1
df 03 00 00 -> TS_RFX_TILESET::tilesDataSize = 991
66 66 77 88 98 -> TS_RFX_TILESET::quantVals
TS_RFX_TILESET::quantVals::LL3 = 6
TS_RFX_TILESET::quantVals::LH3 = 6
TS_RFX_TILESET::quantVals::HL3 = 6
TS_RFX_TILESET::quantVals::HH3 = 6
```



```
TS_RFX_TILESET::quantVals::LH2 = 7
TS_RFX_TILESET::quantVals::HL2 = 7
TS_RFX_TILESET::quantVals::HH2 = 8
TS_RFX_TILESET::quantVals::LH1 = 8
TS_RFX_TILESET::quantVals::HL1 = 8
TS_RFX_TILESET::quantVals::HH1 = 9
```

[TS_RFX_TILE](#) message (section [2.2.2.3.4.1](#)):

```
c3 ca -> TS_RFX_TILE::BlockT::blockType = CBT_TILE
be 03 -> TS_RFX_TILE::BlockT::blockLen = 958
00 -> TS_RFX_TILE::quantIdxY = 0
00 -> TS_RFX_TILE::quantIdxCb = 0
00 -> TS_RFX_TILE::quantIdxCr = 0
00 00 -> TS_RFX_TILE::xIdx = 0
00 00 -> TS_RFX_TILE::yIdx = 0
26 01 -> TS_RFX_TILE::YLen = 294
3d 01 -> TS_RFX_TILE::CbLen = 317
48 01 -> TS_RFX_TILE::CrLen = 328
00000053:00000178 -> TS_RFX_TILE::YData
00000179:000002b5 -> TS_RFX_TILE::CbData
000002b6:000003fd -> TS_RFX_TILE::CrData
```

[TS_RFX_FRAME_END](#) message (section [2.2.2.3.2](#)):

```
c5 cc -> TS_RFX_FRAME_END::CodecChannelT::blockType = WBT_FRAME_END
08 00 00 00 -> TS_RFX_FRAME_END::CodecChannelT::blockLen = 14
01 -> TS_RFX_FRAME_END::CodecChannelT::codecId = 1
00 -> TS_RFX_FRAME_END::CodecChannelT::channelId = 0
```

The server has sent a frame that is delineated by `TS_RFX_FRAME_BEGIN` and `TS_RFX_FRAME_END` messages. The frame contains a single region, which has a single tileset. This tileset, in turn, consists of one 64x64 tile. The compressed sizes, in bytes, for the YCbCr components of this tile are (294, 317, 328).

4.2.4 Sample Decode Data Flow Sequence

The following sections present a sequence of annotated dumps of an encoded tile as it goes through the steps of the decoding algorithm. The sequence starts with the [TS_RFX_TILESET](#) (section [2.2.2.3.4](#)) message, which contains the encoded tile data, and ends with the resulting decoded 64x64 XRGB image.

4.2.4.1 Input `TS_RFX_TILESET` Message

The following is an annotated dump of a `TS_RFX_TILESET` (section [2.2.2.3.4](#)) message containing a single encoded 64x64 tile.

```
00000000 c7 cc 3e 0b 00 00 01 01 c2 ca 00 00 51 50 01 40
00000010 01 00 23 0b 00 00 66 66 77 88 98 c3 ca 23 0b 00
00000020 00 00 00 00 00 00 00 00 00 00 ae 03 cf 03 93 03 c0 01
00000030 01 15 48 99 c7 41 a1 12 68 11 dc 22 29 74 ef fd
00000040 20 92 e0 4e a8 69 3b fd 41 83 bf 28 53 0c 1f e2
00000050 54 0c 77 7c a3 05 7c 30 d0 9c e8 09 39 1a 5d ff
00000060 e2 01 22 13 80 90 87 d2 9f fd fd 50 09 0d 24 a0
```

00000070 8f ab fe 3c 04 84 c6 9c de f8 80 c3 22 50 af 4c
00000080 2a 7f fe e0 5c a9 52 8a 06 7d 3d 09 03 65 a3 af
00000090 d2 61 1f 72 04 50 8d 3e 16 4a 3f ff fd 41 42 87
000000A0 24 37 06 17 2e 56 05 9c 1c b3 84 6a ff fb 43 8b
000000B0 a3 7a 32 43 28 e1 1f 50 54 fc ca a5 df ff 08 04
000000C0 48 15 61 d9 76 43 f8 2a 07 e9 65 f7 c6 89 2d 40
000000D0 a1 c3 35 8d f5 ed f5 91 ae 2f cc 01 ce 03 48 c0
000000E0 8d 63 f4 fd 50 20 2d 0c 9b b0 8d 13 c0 8a 09 52
000000F0 1b 02 6e 42 3b d0 13 4e 84 01 26 88 6a 04 84 34
00000100 2a a5 00 ba 54 48 58 ea 54 02 b4 1d a7 fa 47 82
00000110 ec 7a 77 fd 00 92 66 62 04 a6 9b ff f6 80 c0 69
00000120 01 c2 3e 90 14 20 2f fc 40 96 59 58 0c b1 13 68
00000130 20 2e b5 f5 df ff f8 fc 56 88 60 24 53 b5 41 46
00000140 5f f8 f1 7e de 4a 08 97 e0 55 03 8f e5 75 61 03
00000150 f2 e1 90 01 a2 8e 88 04 98 05 93 6b ff ea c0 60
00000160 a1 88 04 49 bf f7 ff 8c b4 59 90 80 30 64 53 ff
00000170 f5 c4 48 da da cb 80 38 61 57 b2 af 00 e8 7b 46
00000180 e6 d8 02 03 8a 06 18 14 32 83 d0 8a ee bc 81 b4
00000190 28 c4 7f f9 a1 69 00 91 c5 51 ff fe 3f e9 f1 70
000001A0 30 24 10 a7 cb 1f 8a 24 93 ed 83 00 36 20 d1 50
000001B0 e7 d8 ad 58 20 09 22 80 d0 ca 5d 1a d7 f1 60 75
000001C0 2a f2 d7 f8 c0 32 45 86 00 43 01 fe 80 f7 42 81
000001D0 74 84 4c a1 60 4c cb 14 58 01 4d 18 a1 aa 47 0e
000001E0 11 1a 40 7d 41 02 e3 30 cd 33 81 34 06 46 83 a2
000001F0 47 1c 04 aa 20 12 a2 8b 81 c4 9c a0 2e 06 32 f8
00000200 86 85 01 e8 70 f9 46 09 6a bf e0 f5 a4 c8 78 e7
00000210 d2 97 0b bc 3c 97 ff d5 40 94 b2 c1 18 18 11 1f
00000220 43 c1 18 c3 83 7f 9a 31 c4 8e 70 56 da f6 17 de
00000230 d1 02 0d 42 21 13 dc 3a 3c 40 9e f4 01 43 ea 0c
00000240 46 73 a2 7b 0c 80 ff e4 ad 2e 09 b4 63 b0 8c 54
00000250 59 fa ac 76 36 10 05 f0 98 88 83 42 00 20 71 cc
00000260 c1 a9 97 3e 5a 0d 04 50 92 23 20 0d 0a 1c 57 d7
00000270 ff 10 f2 03 0f 58 1b a5 11 f8 f1 b4 12 db 1a 48
00000280 56 1f e3 c7 50 e9 16 b4 bc b0 40 93 ea b5 5b 2f
00000290 fc 50 0a 6f cc 25 e0 06 ab 5f 24 fe 8b cb 42 43
000002A0 7e 69 02 25 c7 38 00 6e e5 80 a8 a4 30 44 15 8f
000002B0 e9 0c d3 a6 c2 14 34 4a fe 03 7f 06 a5 91 02 54
000002C0 f1 a1 a1 53 bf 11 f2 8f 83 67 80 09 08 12 3f fd
000002D0 44 91 c2 83 30 50 07 02 82 4d 31 34 06 41 79 6f
000002E0 f0 cc 03 79 00 2c 05 24 ec 8d 29 15 af 44 c8 eb
000002F0 4f e1 fd f1 41 48 81 08 af fe 51 48 ce e7 f9 b6
00000300 0a 30 83 11 f0 0c 3b d2 a6 24 24 ef 25 fa 5a 3e
00000310 92 3e 79 0e 35 61 c8 aa 1c 2e 9a 27 7f ff f0 7d
00000320 30 5b bc 91 ff fe 43 24 28 66 a7 70 99 28 6e 2b
00000330 18 2b d4 a1 77 3b 96 9f f7 eb be 1f 04 34 75 84
00000340 31 42 4c 65 aa 09 50 a0 c4 51 31 d3 26 3a 1b f4
00000350 6e 4a 4e 17 25 84 78 7d 2c 3f 46 18 ca 5f f9 e5
00000360 38 2f d8 71 94 94 e2 cc a3 15 b0 da a9 cb 58 e4
00000370 18 77 93 8a 51 c6 23 c4 4e 6d d9 14 1e 9b 8d bc
00000380 cb 9d c4 18 05 f5 a9 29 f8 6d 29 38 c7 44 e5 3a
00000390 cd ba 61 98 4a 57 02 96 42 02 d9 37 11 de 2d d4
000003A0 3f fe 61 e7 33 d7 89 4a dd b0 34 47 f4 dc ad aa
000003B0 c9 9d 7e 6d 4b cc dc 17 89 57 fd bb 37 75 47 5a
000003C0 ec 2c 6e 3c 15 92 54 64 2c ab 9e ab 2b dd 3c 66
000003D0 a0 8f 47 5e 93 1a 37 16 f4 89 23 00 00 b0 33 56
000003E0 fa 14 1e ff 48 7a 7e 0f 10 1f f4 91 c8 10 56 84
000003F0 ff 08 ec b4 ac 0e 0f ff ad c5 e0 1a 2f 82 04 9f
00000400 91 c2 0e fe 48 36 79 01 42 14 ff fe 30 f0 08 18
00000410 f1 81 45 9a 60 c1 79 f0 14 12 10 ce ea 31 5a ff

00000420 fc 20 13 82 2f c9 02 1f 81 cb 00 e1 10 d2 b4 be
00000430 87 ff b0 1e 27 81 b7 04 06 3c c2 04 f6 06 0e 28
00000440 bc 40 bf 12 1e 86 d4 6a 7f 18 1b 96 85 4c 16 80
00000450 df 2c a5 8d 86 a3 4a 8a b4 1b a1 38 a9 d5 ff ff
00000460 ea 06 20 d2 95 1e f4 2f b2 12 0e 61 78 4a 17 52
00000470 5d e4 25 1f fe c0 b3 1f ff ff ec 02 82 80 90 41
00000480 88 de 48 2c 42 52 0b 2f 43 7e 50 78 f2 67 78 41
00000490 34 3d c8 0f 67 a1 eb 21 fe c0 1f 22 60 41 6c 00
000004A0 92 4b 60 10 d0 0d 01 35 05 0e 87 a2 a0 5d 1f a3
000004B0 af 7f f1 be 8f cd a5 00 1c 10 40 15 76 81 05 ef
000004C0 ee 00 60 84 00 99 40 4a 82 17 e9 fc c4 7f ff fd
000004D0 04 80 06 06 dc af a7 7e 94 75 74 01 00 e0 91 00
000004E0 85 7f 8e d6 0b 20 21 30 ca 62 8e 07 04 e9 45 40
000004F0 5f 47 4a 30 15 41 cb df ff fc bf c3 b4 46 6a 01
00000500 40 d0 a7 34 18 24 1c 2a 45 fe a8 05 08 61 fd a8
00000510 80 71 01 25 9c c1 47 17 37 02 7a 15 ff f3 01 45
00000520 7f d6 80 60 83 67 f8 9d 2f f4 dd 8c 30 01 51 42
00000530 bc 43 7a 6b 9f 84 1e 00 48 c1 e0 b7 e0 7e 99 f2
00000540 4a e9 40 02 81 c3 00 24 3a c5 52 0f 91 c8 68 25
00000550 40 99 a4 25 1a 04 d0 a2 91 dd eb 93 00 21 49 24
00000560 8b 40 75 38 14 a1 fd 3f 88 25 bf 32 00 e3 19 fc
00000570 b9 f8 6f 81 c0 01 b3 93 20 09 08 25 84 e1 34 d4
00000580 1b 48 88 11 a0 15 59 d7 07 81 81 3b a1 40 2e 2f
00000590 48 70 09 c4 76 49 0f 2e 50 2e 46 19 a4 16 a2 1b
000005A0 84 a2 89 58 fc 4f 3f 40 90 4c a3 01 32 09 02 80
000005B0 9c 91 13 2c ba de 5d 99 f2 ff ff 3d 5a 1f a9 02
000005C0 90 8f f3 08 bd 01 f8 d0 2a 95 41 0c 40 0a 20 c4
000005D0 d4 cc 6b 0f f0 80 b1 5d 28 3d 08 c2 f8 31 02 49
000005E0 88 14 28 ed e8 86 3b 00 9f 95 06 37 15 a4 59 c8
000005F0 80 b6 10 f0 e5 b8 18 00 56 1c ff 95 21 0e 7f 2b
00000600 c5 08 59 10 e1 46 31 8d ec e0 a1 99 bb 21 ff fe
00000610 30 10 d0 05 e3 08 50 fc f3 0e 00 8d 68 8e 07 a6
00000620 80 34 42 ed 1f 88 00 f0 8a 21 ae f7 fb 80 28 86
00000630 0f ff ff 82 ea 47 95 91 e0 04 01 44 0c 29 ff 0e
00000640 33 e8 c0 54 04 23 fc 81 5b f0 3c 07 10 70 30 d8
00000650 21 6f ef de 46 09 43 fa 5f ff 0d 72 30 dd 00 db
00000660 e4 48 24 97 08 46 b1 49 c4 4d 80 12 60 ff a4 a6
00000670 ff f6 8c 00 40 05 02 b4 0f f0 3e fc 84 38 81 94
00000680 8b fe 49 ef c0 10 49 88 28 a2 1c 2a 8b 64 d4 86
00000690 d7 ff ff ff eb 91 6b 11 10 00 69 4c bf b4 1c d8
000006A0 00 07 16 80 60 0a 1c 82 42 27 82 43 c9 0a 64 20
000006B0 5a 5f 4e bf 8c 38 82 36 02 07 72 79 07 23 b4 bb
000006C0 57 5f e8 04 dd 39 e9 07 95 be 04 2b dd 8e 22 dc
000006D0 14 2c 61 a3 a9 cd 4f 82 5d a0 44 df f4 96 ff f5
000006E0 2b ff fe 01 19 d2 a2 9e 43 a5 7f f0 4c 4c 2b 3c
000006F0 33 e2 55 ff 04 06 29 2c 0d 22 5d 7c 93 ba 18 af
00000700 f9 32 a6 c3 99 46 79 e3 06 a6 38 8b 92 22 4b db
00000710 1b 36 20 b0 6c 20 ce 37 42 e1 66 d4 49 34 42 8b
00000720 fa 9c 12 99 dc 06 87 fa 46 f8 2f 04 a9 d8 82 07
00000730 a6 30 0f c0 df 35 e8 90 f0 ff ff a8 e0 d7 02 60
00000740 1a c3 20 28 a2 31 29 3c eb 04 a5 dd 48 0e 82 a4
00000750 b6 56 22 06 57 e0 da 10 27 31 0e 11 77 fe 02 60
00000760 16 48 81 8c 0d 05 17 7f cb bb 7e 25 2a 41 fd 8a
00000770 7f c9 36 7c e0 98 7e 92 ef 7e 06 03 13 3e 20 3a
00000780 bf 4c c3 0f 2e 80 74 bf 39 3c f0 a6 b2 e9 3f 41
00000790 55 1f 2c f5 d2 7e 8c ae 4e aa 61 3c bc 3f c4 c7
000007A0 36 dc 23 c8 b8 52 e2 8a 80 18 00 00 b2 46 a2 56
000007B0 0d 12 94 aa bd 01 07 ff fa 34 0c 5f f8 0c 12 50
000007C0 af d6 d1 89 40 a4 ff e0 ce c4 49 25 9d c1 ff 7e

000007D0 60 24 5d cc 10 c0 be 5a 12 d3 c3 fe 2d 40 7c 28
000007E0 9e 71 01 d2 6e 86 0b c8 f2 9b 45 08 4c 04 52 7e
000007F0 f2 7e d9 cc 0b 1c 20 80 ae af fe b0 6d 23 f2 41
00000800 e3 2e 20 11 4b 74 89 dd ff a8 38 a3 95 82 15 f0
00000810 d0 d5 f1 92 8e ee c0 26 81 e9 47 ff ee 0d 20 34
00000820 31 3a ef 40 b2 29 47 19 7f 04 27 f1 90 85 09 86
00000830 7d 42 e2 54 5d 5f e8 0e d0 2c aa 16 bf 04 a7 f8
00000840 a2 46 0b 08 7a 79 e9 28 62 7c 33 f4 0b 14 82 fa
00000850 61 eb c1 ff 4c a4 11 7f 03 68 44 c1 1f 81 3a 6c
00000860 77 95 02 2b 53 80 e5 10 1e 90 e8 fd 1f a6 40 0b
00000870 13 ff 4e 4d 7f 52 e8 af 9a c1 80 0f 0a 14 02 3c
00000880 c0 09 13 e7 dc c0 1a 28 a0 e4 83 8e 03 88 d5 af
00000890 1a bd 91 00 b7 4e ba df f8 db cc 02 43 c4 14 2a
000008A0 3f c8 0d 09 1c 44 f4 01 3c ca 28 56 80 a6 85 00
000008B0 ea 3e 8f eb 9f fc 6e 07 c4 e0 30 78 a0 1e 6f 54
000008C0 78 51 ff 56 4a 01 47 02 4c 21 3b fb 90 0a cc 1d
000008D0 d2 47 ff fc 70 18 22 c0 b9 2f e9 7f 91 d3 66 2f
000008E0 80 2c 24 a7 fa 84 51 ab 6b 72 00 ab 33 04 cf 43
000008F0 ff 17 51 84 0c 01 50 10 8f 90 34 41 44 84 8e 08
00000900 19 04 48 50 84 38 3d 02 52 f9 7c d2 d0 1f 13 42
00000910 a0 21 41 c4 02 02 3d 09 c8 fd 60 7d 35 4f 7f ff
00000920 f9 97 6a d8 00 c3 83 00 09 50 4b 90 8a c7 94 4d
00000930 47 c1 62 32 28 24 09 52 2e 2e 1c 96 44 a0 09 c8
00000940 ce 64 a9 1c 19 0e 52 3e 3e 19 93 a0 36 26 22 08
00000950 9a 00 dd 66 3a 93 d5 89 d1 40 06 d4 a8 22 73 7b
00000960 3d 3f e3 04 94 ff ff ff ff 0c 56 77 ac e0 c4 06
00000970 1f b8 a5 80 fd 68 1c 32 16 03 de 71 2a 3d 14 19
00000980 be c2 88 d9 24 92 5f c5 90 0a 85 c2 3f 87 03 a8
00000990 26 17 c4 06 86 12 87 76 0a 48 16 ed 96 93 ec 1b
000009A0 30 73 e8 1a 3f ff 4d ce 40 f3 0c 51 4b 84 9e 67
000009B0 2b 15 40 1a a0 fc 10 0f d8 81 35 87 ff 98 0f 40
000009C0 00 ba c0 71 e2 00 18 28 b3 82 cc 80 6a a0 43 ff
000009D0 2d d6 04 8a 68 ff ff ff fc 1a f3 1a 2a 06 c0 01
000009E0 40 0c 30 c1 d0 d7 4f cb 74 1f 07 d3 b4 0d 88 98
000009F0 ea da 9f ce 2b 3c 55 b3 40 14 ff ff ff ea db 9b
00000A00 92 d8 68 08 0b 41 09 26 40 8c f1 b0 9a 98 c0 80
00000A10 8b f0 3d e7 ec 19 68 21 03 29 7f e1 6d 4c 0f 01
00000A20 d1 51 01 1a 50 2a 59 27 80 c1 6e 33 f1 80 e1 49
00000A30 08 e9 17 ff ff ff 80 5a 10 10 36 5e ca f8 3a 00
00000A40 1e b0 06 84 01 f3 07 1b 4a c0 1e 21 43 8e a5 55
00000A50 77 c7 65 7c c2 df 5e 0c 42 20 d2 48 61 c8 1c 65
00000A60 f8 fe 4c 88 71 1f 82 50 81 a3 54 09 13 28 52 f5
00000A70 e0 82 c3 06 7f fa 2c cf f8 f4 7f ff fd 01 49 a4
00000A80 b8 de 62 84 fe ed 65 1f 3c 3c b2 50 76 30 5b 03
00000A90 c0 08 a6 64 90 c8 cd 14 6e 69 46 7a c6 1c 87 d7
00000AA0 48 7b 49 05 2d 5e 7f cb 67 f0 d9 0d 1e 9e 53 b7
00000AB0 64 a5 a5 10 39 06 11 3f b1 a9 a6 e8 4d 47 77 da
00000AC0 43 76 89 45 09 70 c2 38 0f 09 6f e7 2d 82 35 07
00000AD0 fe 64 18 2e b8 04 42 54 80 43 12 6c 9a 55 c9 0a
00000AE0 a0 79 47 52 65 2a ff 50 11 c9 4e fe 5b 30 a4 e8
00000AF0 30 63 ff 21 12 1b dc 1c 01 41 51 1f ff fa c3 e3
00000B00 55 f1 66 e2 d5 78 5e fa 4d f2 61 01 26 15 a9 f9
00000B10 d9 32 41 90 36 4e ae e3 0b 16 56 8c 6e 42 5d d8
00000B20 1e fe 1d 40 3a 50 9f 09 14 eb 6e 48 7a 91 88 7b
00000B30 7d 8f 72 42 39 b0 1c 65 18 23 8b 60 30 00

TS_RFX_TILESET message (section [4.2.4.1](#)).

```

c7 cc -> TS_RFX_TILESET::CodecChannelT::blockType = WBT_EXTENSION
3e 0b 00 00 -> TS_RFX_TILESET::CodecChannelT::blockLen = 2878
01 -> TS_RFX_TILESET::codecId = 1
00 -> TS_RFX_TILESET::channelId = 0
c2 ca -> TS_RFX_TILESET::subtype = CBT_TILESET
00 00 -> TS_RFX_TILESET::idx = 0x00
51 50 -> TS_RFX_TILESET::properties
TS_RFX_TILESET::properties::lt = TRUE (1)
TS_RFX_TILESET::properties::flags = VIDEO_MODE (0)
TS_RFX_TILESET::properties::cct = COL_CONV_ICT (1)
TS_RFX_TILESET::properties::xft = CLW_XFORM_DWT_53_A (1)
TS_RFX_TILESET::properties::et = CLW_ENTROPY_RLGR3 (4)
TS_RFX_TILESET::properties::qt = SCALAR_QUANTIZATION (1)
01 -> TS_RFX_TILESET::numQuant = 1
40 -> TS_RFX_TILESET::tileSize = 64
01 00 -> TS_RFX_TILESET::numTiles = 1
23 0b 00 00 -> TS_RFX_TILESET::tilesDataSize = 2851
66 66 77 88 98 -> TS_RFX_TILESET::quantVals
TS_RFX_TILESET::quantVals::LL3 = 6
TS_RFX_TILESET::quantVals::LH3 = 6
TS_RFX_TILESET::quantVals::HL3 = 6
TS_RFX_TILESET::quantVals::HH3 = 6
TS_RFX_TILESET::quantVals::LH2 = 7
TS_RFX_TILESET::quantVals::HL2 = 7
TS_RFX_TILESET::quantVals::HH2 = 8
TS_RFX_TILESET::quantVals::LH1 = 8
TS_RFX_TILESET::quantVals::HL1 = 8
TS_RFX_TILESET::quantVals::HH1 = 9

```

TS_RFX_TILE message (section [2.2.2.3.4.1](#)).

```

c3 ca -> TS_RFX_TILE::BlockT::blockType = CBT_TILE
23 0b -> TS_RFX_TILE::BlockT::blockLen = 2851
00 -> TS_RFX_TILE::quantIdxY = 0
00 -> TS_RFX_TILE::quantIdxCb = 0
00 -> TS_RFX_TILE::quantIdxCr = 0
00 00 -> TS_RFX_TILE::xIdx = 0
00 00 -> TS_RFX_TILE::yIdx = 0
ae 03 -> TS_RFX_TILE::YLen = 942
cf 03 -> TS_RFX_TILE::CbLen = 975
93 03 -> TS_RFX_TILE::CrLen = 915
0000002e:000003db -> TS_RFX_TILE::YData
000003dc:000007aa -> TS_RFX_TILE::CbData
000007ab:00000b3d -> TS_RFX_TILE::CrData

```

4.2.4.2 Entropy Decoded Data

The following are dumps of the Y, Cb, and Cr components of the tile after they are decoded using the [RLGR3 \(section 3.1.8.1.7.2\)](#) algorithm. The decoded data for each component has 4,096 (64x64) coefficients, and they contain the quantized DWT sub-bands (see the figure illustrating three-level DWT decomposition in section [3.1.8.1.4](#)) at the following ranges.

```

00000000:000003FF -> HL1 (32x32 coefficients)
00000400:000007FF -> LH1 (32x32 coefficients)
00000800:00000BFF -> HH1 (32x32 coefficients)

```

```

00000C00:00000CFF -> HL2 (16x16 coefficients)
00000D00:00000DFF -> LH2 (16x16 coefficients)
00000E00:00000EFF -> HH2 (16x16 coefficients)
00000F00:00000F3F -> HL3 (8x8 coefficients)
00000F40:00000F7F -> LH3 (8x8 coefficients)
00000F80:00000FBF -> HH3 (8x8 coefficients)
00000FC0:00000FFF -> LL3 (8x8 coefficients)

```

4.2.4.2.1 Y Component Data

The following is a dump of the Y component data, as shown in the figure illustrating three-level DWT decomposition in section [3.1.8.1.4](#).

```

00000000 +0 +1 +0 +0 +0 +0 +0 +0 +0 +0 +0 +0 +0 +0 +0
00000010 +0 +0 +0 +0 +0 +0 +0 +0 +0 +0 +0 +0 +0 +0 +0
00000020 +0 +0 +0 +0 +0 +0 +0 +0 +0 +0 +0 +0 +0 +0 +0
00000030 +0 +0 +0 +0 +0 +0 +0 +0 +0 +0 +0 +0 +0 +0 +0
00000040 +0 +0 +0 +0 +0 +0 +0 +0 +0 +0 +0 +0 +0 +0 +0
00000050 +0 +0 +0 +0 +0 +0 +0 +0 +0 +0 +0 +0 +0 +0 +0
00000060 +1 +0 +2 +0 +0 +0 +0 +0 -1 +0 +0 +0 +0 +0 +0
00000070 +0 +0 +0 +0 +0 +0 +0 +0 +0 +0 +0 +1 +0 +0 +0
00000080 +0 +0 +1 +0 +0 +0 +2 +0 +0 +0 +0 +0 +0 +0 +0
00000090 +0 +0 +0 +0 +0 +0 +0 +0 +0 +0 +0 +0 +0 +0 +0
000000A0 +0 +0 +0 +0 +0 +0 +0 +0 +0 +1 +0 +0 +0 +0 +0
000000B0 +0 +0 -1 +0 +0 +0 +0 +0 +0 +0 +0 -1 +1 +0 +0
000000C0 +0 +0 +0 +0 +0 +0 -3 +0 +0 +0 +1 +0 +0 +0 +0
000000D0 +0 +2 +0 +0 +0 +0 +0 +0 +0 +1 +0 -2 +4 -5 -1 +0
000000E0 +0 +0 +0 +0 +0 -1 -3 +0 +0 +0 +0 +0 +0 +0 +0
000000F0 +0 -3 +0 +3 +0 +0 +0 +0 +0 +0 -1 +4 +4 -5 -1 +0
00000100 +0 +0 +0 +0 +0 -2 +5 +0 +0 +0 +0 +0 +0 +2 +1 +0
00000110 +2 -5 -4 +1 +0 +0 +0 +0 +0 +1 +3 -1 +5 +0 -1
00000120 +0 +0 +0 +0 +0 -2 -2 -3 +0 +0 +0 +0 +3 +0 +0
00000130 +7 +0 -4 +0 +0 +0 +0 +0 +0 +0 +0 -1 +0 -1 +2 -1
00000140 +0 +0 +0 +0 +0 -3 +1 +5 +0 +0 +0 +0 +0 +0 -1 +0
00000150 +0 +1 +7 +0 +0 +0 +0 +0 +0 +0 +0 +0 +0 -1 +0 +0
00000160 +0 +0 +0 +0 +2 +0 +0 +0 -2 +0 +0 +0 +0 +0 +1 +0
00000170 -9 -3 +5 +0 +0 +0 +0 +0 +0 +0 +0 +0 +0 -1 +0 +0
00000180 +0 +0 +0 +0 +0 +0 -1 -1 -1 +0 +0 +0 +0 +0 +0 +6
00000190 -2 -8 -1 +0 +0 +0 +0 +0 +0 +0 +0 +0 +0 -1 +0 +0
000001A0 +0 +0 +0 +0 -3 +0 +0 +0 +0 +0 +0 -1 +0 -1 +0 +5
000001B0 +2 +3 +0 +0 +0 +0 +0 +0 +0 +0 +1 +0 +2 +0 +0 +0
000001C0 +0 +0 +0 -1 +1 +0 +0 -1 +2 +0 +0 +1 +0 +0 -1 +0
000001D0 -1 +7 +0 +0 +0 +0 +0 +0 +0 +0 +0 -3 -2 +0 +0
000001E0 +0 +0 +0 +3 -1 +0 -1 +0 +1 +0 +0 +0 +1 +2 -1 +0
000001F0 -5 +1 +0 +0 +0 +0 +0 +0 +0 +0 +0 -3 -4 +0 +0 +0
00000200 +0 +0 -1 -6 +1 +0 -1 +0 +0 +0 +0 +0 +0 +0 +6 +0
00000210 -1 +0 +1 +0 +0 +1 -1 +0 +0 +0 +0 +0 +0 +0 +0 +0
00000220 +0 +0 +3 -5 +0 +0 +0 +0 +0 +0 +0 +0 +0 -1 -1 +1
00000230 +10 +0 +0 +0 -1 +1 +0 +0 +0 +0 -1 +1 +0 +0 +0 +0
00000240 +0 +0 +7 +0 +0 +0 +0 +0 +0 +0 +0 +0 +1 -5 -5
00000250 +3 +0 +0 +0 +0 +0 +0 +0 +0 +0 -1 +0 -1 +0 +0 +0
00000260 +0 -1 -2 +0 +0 +0 -1 +0 +0 +0 +0 +0 +0 +3 -1 -7
00000270 +0 +0 +0 +0 +0 +0 +0 +0 +0 +0 +1 -6 +0 +0 +0 +0
00000280 +0 +0 -8 +0 +0 +0 +0 +0 +0 +0 +0 +0 +3 +2 +4
00000290 +0 +0 +0 +0 +0 -1 +0 +0 +0 +0 +6 -1 +0 +0 +0 +0
000002A0 -1 +7 -1 +0 +0 +0 -1 -1 +0 +0 +0 +0 -3 -1 +6
000002B0 +0 +0 +0 +0 +0 +0 +0 +0 +0 +0 +3 +1 +0 +0 +0 +0

```

000002C0	+0	+4	+1	+2	-2	-2	+0	-1	+0	+0	+0	+0	+1	-1	-7	+1	
000002D0	+0	+0	+0	+0	+0	+0	+0	+0	+0	+0	-6	+0	+0	+0	+0	+0	
000002E0	-1	-10	+3	+1	+2	+0	-2	+1	+1	+0	+0	+0	+0	+0	-1	+0	
000002F0	+0	+0	-1	+0	+0	+0	+0	+0	+0	+3	-2	+0	+0	+0	+0	+0	
00000300	+6	-8	-2	+0	-2	+1	+0	+0	-1	-1	-1	+1	+1	+1	+6	+0	
00000310	+0	+0	+0	+0	+0	+0	+0	+0	+0	+4	+1	+0	+0	+0	+0	+0	
00000320	+3	+2	+0	+1	+0	+0	+1	+1	+0	+0	+1	-2	+5	-3	+2	+0	
00000330	+0	+0	+0	+1	+0	+0	+0	+0	+0	-2	+0	+0	+0	+0	+0	+0	
00000340	+0	+0	+0	+0	+0	+0	+0	+0	+0	+0	-1	+0	+0	-3	+0	+1	
00000350	+0	+0	+1	+1	+0	+0	+0	+0	+0	-4	+0	+0	+0	+0	+0	+0	
00000360	+0	+0	+0	+0	+0	+0	+0	+0	+0	+0	+0	+0	+0	+0	+0	-1	+1
00000370	-1	-1	+0	+0	+1	+0	+0	+0	+3	+0	+0	+0	+0	+0	+0	+0	+0
00000380	+0	+0	+0	+0	+0	+0	+0	+0	+0	+0	+0	+0	+0	+0	+0	-1	+0
00000390	+0	+0	+1	+1	+1	-2	+0	+1	+0	+0	+0	+0	+0	+0	+0	+0	+0
000003A0	+0	+0	+0	+0	+0	+0	+0	+0	+0	+0	+0	+0	+0	+0	+0	+0	+0
000003B0	-1	+0	-2	+1	+1	+0	+0	+0	+0	+0	+0	+0	+0	+0	+0	+0	+0
000003C0	+0	+0	+0	+0	+0	+0	+0	+0	+0	+0	+0	+0	+0	+0	+0	+0	+0
000003D0	+0	+0	+0	+3	-1	+0	+0	+0	+0	+0	+0	+0	+0	+0	+0	+0	+0
000003E0	+0	+0	+0	+0	+0	+0	+0	+0	+0	+0	+0	+0	+0	+0	+0	+0	+0
000003F0	+0	+0	+0	-1	+0	+0	+0	+0	+0	+0	+0	+0	+0	+0	+0	+0	+0
00000400	+0	+0	+0	+0	+0	+0	+0	+0	+0	+0	+0	+0	+0	+0	+0	+0	+0
00000410	+0	+0	+0	+0	+0	+0	+0	+0	+0	+0	+0	+0	+0	+0	+0	+0	+0
00000420	+0	+0	+0	+0	+0	+0	+0	+0	+0	+0	+0	+0	+0	+0	+0	+0	+0
00000430	+0	+0	+0	+0	+0	+0	+0	+0	+0	+0	+0	+0	+0	+0	+0	+0	+0
00000440	+0	+0	+0	+0	+0	+0	+0	+0	+1	+0	-1	-1	+0	+0	-1	-1	+0
00000450	+1	+0	+0	+0	+0	+0	+0	+0	+0	+0	+0	+0	+0	+0	+0	+0	+0
00000460	-1	-1	-1	+0	+0	+0	+0	-1	+0	+0	+0	+0	+0	+0	+0	+0	+0
00000470	+0	-1	+0	+0	+0	+0	+0	+0	+0	+0	+0	+0	+0	+0	+0	+0	+0
00000480	-1	-1	-1	+0	+0	+0	+0	+0	+0	+0	+0	+0	+0	+0	+0	+0	+0
00000490	+0	+0	+0	+0	+0	+0	+0	+0	+0	+0	+0	+0	+0	+0	+0	+0	+0
000004A0	+0	+0	+0	+0	+0	+0	+0	+0	+0	+0	+0	+0	+0	+0	+0	+0	+0
000004B0	+0	+0	+0	+0	-1	+1	+0	+0	+0	+0	+0	+0	-2	-8	+2	+0	+0
000004C0	+0	+0	+0	+0	+0	+0	-1	+0	+0	+0	+0	+0	+0	+0	+0	+0	+0
000004D0	+0	+0	+0	+0	+0	+0	-1	+0	+0	+1	+0	-2	+4	+4	-1	+0	+0
000004E0	+0	+0	+0	+0	+0	-1	+3	-1	+0	+0	+0	+0	+0	+0	+0	+1	+0
000004F0	+0	+1	+0	+0	+0	+0	+0	+0	+0	+0	-1	+3	+3	-7	-1	+0	+0
00000500	+0	+0	+0	+0	+0	+0	+0	+1	+0	+0	+0	+0	+0	+0	+0	+0	+0
00000510	+0	+0	-1	+1	+0	+0	+0	+0	+0	+0	+0	+1	+0	+0	+6	+3	+0
00000520	+0	+0	+0	+0	+0	+0	+0	+0	+0	+0	+0	+1	+0	+0	+0	+0	+0
00000530	+1	+0	+0	+0	+0	+0	+0	+0	+0	+0	+0	+0	+0	+0	-8	+0	+0
00000540	+0	+0	+0	+0	+0	+0	+0	+0	+0	+0	+0	+1	-2	-2	+2	-1	+0
00000550	+0	+0	-1	+0	+0	+0	+0	+0	+0	+0	+0	+0	+0	+0	+0	+0	+0
00000560	+0	+0	+0	+0	+0	-1	+0	+0	+1	+1	+3	+1	+0	+0	+0	+0	+0
00000570	+0	+0	+0	+0	+0	+0	+0	+1	+0	+0	+0	+0	+0	+0	+0	+0	+0
00000580	+0	+0	+0	+0	+0	-1	+0	-1	-5	-3	-4	-6	-6	+7	+1	+1	+0
00000590	-1	+0	+0	+0	+0	+0	+0	+0	-1	-2	-3	+0	+1	+0	+0	+0	+0
000005A0	+0	+0	+0	+0	+0	+1	+0	+2	-1	+0	-2	-3	+1	+1	-8	+6	+0
000005B0	+0	-1	+1	+0	+0	+0	+0	+1	+1	+0	+0	+6	-3	-1	+0	+0	+0
000005C0	+0	+0	+0	-1	+5	+2	-6	-2	+0	+0	+0	+2	+7	-6	-1	+0	+0
000005D0	+0	+1	+0	+0	+0	+0	+0	+0	+0	+0	-1	-1	+1	+6	+0	+0	+0
000005E0	+0	+0	+0	+0	-2	+1	+0	+0	+0	+0	+0	+0	+0	-1	+6	-1	+0
000005F0	+1	-6	+7	+0	+0	+0	+0	+0	+0	+0	+0	+1	-1	-1	+0	+0	+0
00000600	+0	+0	+0	+1	+0	+0	+0	+0	+0	+0	+0	+0	+0	+0	+0	+0	+0
00000610	-1	-2	+0	-8	+6	+6	+4	+3	+3	+4	-1	-2	+0	+0	+0	+0	+0
00000620	+0	+0	+0	+0	+0	+0	+0	+0	+0	+0	+0	+0	+0	+0	+2	-1	+0
00000630	-1	+7	-8	+0	+1	-2	-4	-3	-1	+1	-3	-4	+1	+0	+0	+0	+0
00000640	+0	+0	+0	+0	+0	+0	+0	+0	+0	+0	+1	+0	+1	-3	-5	+0	+0
00000650	+1	+0	+0	+8	-1	-7	-9	-7	-2	+6	+3	+0	+0	+0	+0	+0	+0
00000660	+0	+0	+1	+0	+0	+0	-1	-1	+0	+0	+0	+0	+0	+1	-1	+0	+0

00000670	+0	+0	+0	+0	+0	+0	+0	+0	+0	+0	+0	+0	+0	+0	+0	+0
00000680	+0	+0	+0	+0	+0	+0	+1	+0	+0	+0	+0	+0	+0	+0	+0	-1
00000690	+1	+0	+0	+0	+0	+0	-1	+1	+0	+0	+1	-1	+0	+0	+0	+0
000006A0	-1	+1	-1	+1	+1	+0	+0	+0	+0	+0	+0	+0	+0	+0	+0	+0
000006B0	+0	+0	+0	+0	+0	+0	+0	+0	-1	+1	-1	+0	+0	+0	+0	+0
000006C0	+0	+1	+1	+3	+3	+0	+1	+1	-1	+1	+0	+0	+0	+0	+0	+0
000006D0	+0	+0	+0	+0	+0	+0	+0	+0	+0	+0	+1	+0	+0	+0	+1	+0
000006E0	+0	+0	+2	+1	-4	-5	-8	-6	-4	+1	+0	+0	-1	+0	+0	+0
000006F0	+0	+0	+0	+0	+0	+0	+0	+0	+0	+0	+0	+1	+0	+0	+0	+0
00000700	+3	-9	-5	+10	+2	+2	+0	-1	+2	+6	-4	-1	+0	+0	+0	+0
00000710	+0	+0	+0	+0	+0	+0	+0	+0	+0	+0	+0	+0	+0	+0	+0	+0
00000720	-1	+2	-1	-1	+1	+0	+0	+0	+0	+0	-1	+4	-2	-1	+1	-1
00000730	+1	-1	+0	+0	+0	+0	+0	+0	+0	+1	+0	+0	+0	+0	+0	+0
00000740	+0	+0	+0	+0	+0	+0	+0	+0	+0	+0	+0	+0	+0	+0	+0	+1
00000750	-1	+1	+0	+0	+0	+0	+0	+0	+0	+0	+0	+0	+0	+0	+0	+0
00000760	+0	+1	+0	+0	+0	+0	+0	+0	+0	+0	+0	+0	+0	+0	-1	-1
00000770	+0	-1	+1	+1	+0	+1	+0	-1	+3	-1	+0	+0	+0	+0	+0	+0
00000780	+0	+0	+0	+0	+0	+0	+0	+0	+0	+0	+0	+0	+0	+0	+0	-1
00000790	-1	-1	+1	+1	+1	+0	-2	-3	+0	+0	+0	+0	+0	+0	+0	+0
000007A0	+0	+0	+0	+0	+0	+0	+0	+0	+0	+0	+0	+0	+0	+0	+0	+0
000007B0	+0	+0	-1	+4	+2	+1	+0	+0	+0	+0	+0	+0	+0	+0	+0	+0
000007C0	+0	+0	+0	+0	+0	+0	+0	+0	+0	+0	+0	+0	+0	+0	+0	+0
000007D0	+0	+0	+0	+0	-2	+0	+0	+0	+0	+0	+0	+0	+0	+0	+0	+0
000007E0	+0	+0	+0	+0	+0	+0	+0	+0	+0	+0	+0	+0	+0	+0	+0	+0
000007F0	+0	+0	+0	+0	+0	+0	+0	+0	+0	+0	+0	+0	+0	+0	+0	+0
00000800	+0	+0	+0	+0	+0	+0	+0	+0	+0	+0	+0	+0	+0	+0	+0	+0
00000810	+0	+0	+0	+0	+0	+0	+0	+0	+0	+0	+0	+0	+0	+0	+0	+0
00000820	+0	+0	+0	+0	+0	+0	+0	+0	+0	+0	+0	+0	+0	+0	+0	+0
00000830	+0	+0	+0	+0	+0	+0	+0	+0	+0	+0	+0	+0	+0	+0	+0	+0
00000840	+0	+0	+0	+0	+0	+0	+0	+0	+0	+0	+0	+0	+0	+0	+0	+0
00000850	+0	+0	+0	+0	+0	+0	+0	+0	+0	+0	+0	+0	+0	+0	+0	+0
00000860	+0	+0	+0	+0	+0	+0	+0	+0	+0	+0	+0	+0	+0	+0	+0	+0
00000870	+0	+0	+0	+0	+0	+0	+0	+0	+0	+0	+0	+0	+0	+0	+0	+0
00000880	+0	+0	+0	+0	+0	+0	+0	+0	+0	+0	+0	+0	+0	+0	+0	+0
00000890	+0	+0	+0	+0	+0	+0	+0	+0	+0	+0	+0	+0	+0	+0	+0	+0
000008A0	+0	+0	+0	+0	+0	+0	+0	+0	+0	+0	+0	+0	+0	+0	+0	+0
000008B0	+0	+0	+0	+0	+0	+0	+0	+0	+0	+0	+0	+0	-1	+1	+0	+0
000008C0	+0	+0	+0	+0	+0	+0	+0	+0	+0	+0	+0	+0	+0	+0	+0	+0
000008D0	+0	+0	+0	+0	+0	+0	+0	+0	+0	+0	+0	-2	-1	+1	+0	+0
000008E0	+0	+0	+0	+0	+0	-1	-1	+0	+0	+0	+0	+0	+0	+0	+0	+0
000008F0	+0	-1	+0	+0	+0	+0	+0	+0	+0	+0	-1	+1	-2	+0	+0	+0
00000900	+0	+0	+0	+0	+0	+0	+0	+0	+0	+0	+0	+0	+0	+0	+0	+0
00000910	+0	+0	-1	+0	+0	+0	+0	+0	+0	+0	+0	-1	+0	+0	+1	-1
00000920	+0	+0	+0	+0	+0	-1	+0	+0	+0	+0	+0	+0	+0	+0	+0	+0
00000930	+0	+0	+0	+0	+0	+0	+0	+0	+0	+0	+0	+0	+0	+0	+0	+0
00000940	+0	+0	+0	+0	+0	+0	+0	+0	+0	+0	+0	+0	+0	+0	+0	+0
00000950	+0	+0	+0	+0	+0	+0	+0	+0	+0	+0	+0	+0	+0	+0	+0	+0
00000960	+0	+0	+0	+0	+0	+0	+0	+0	+0	+0	+0	+0	+0	+0	+0	+0
00000970	+0	+0	+0	+0	+0	+0	+0	+0	+0	+0	+0	+0	+0	+0	+0	+0
00000980	+0	+0	+0	+0	+0	+0	+0	+0	+0	+0	+0	-1	+0	+0	+0	+1
00000990	+0	+0	+0	+0	+0	+0	+0	+0	+0	+0	+0	+0	+0	+0	+0	+0
000009A0	+0	+0	+0	+0	+1	+0	+0	+0	+0	+0	+0	+0	+0	+0	+0	-1
000009B0	+0	+1	+0	+0	+0	+0	+0	+0	+0	+0	+0	+0	+1	+0	+0	+0
000009C0	+0	+0	+0	+0	+1	+0	+0	+0	+0	+0	+0	+0	+0	-1	+0	+0
000009D0	+0	+0	+0	+0	+0	+0	+0	+0	+0	+0	+0	+1	+1	+0	+0	+0
000009E0	+0	+0	+0	+0	+0	+0	+0	+0	+0	+0	+0	+0	+0	+0	-1	+0
000009F0	+1	+0	+0	+0	+0	+0	+0	+0	+0	+0	+0	+1	+0	+0	+0	+0
00000A00	+0	+0	+0	-1	+0	+0	+0	+0	+0	+0	+0	+0	+0	+0	+0	+0
00000A10	-2	+0	+0	+0	+0	+0	+0	+0	+0	+0	+0	+0	+0	+0	+0	+0

0000A20	+0	+0	+0	+0	+0	+0	+0	+0	+0	+0	+0	+0	+0	+0	+0	-1	+0
0000A30	-1	+0	+0	+0	+0	+0	+0	+0	+0	+0	+0	+1	+0	+0	+0	+0	+0
0000A40	+0	+0	+0	+0	+0	+0	+0	+0	+0	+0	+0	+0	+0	-1	+1	+1	+0
0000A50	+0	+0	+0	+0	+0	+0	+0	+0	+0	+0	+0	-1	+0	+0	+0	+0	+0
0000A60	+0	+0	+0	+0	+0	+0	+0	+0	+0	+0	+0	+0	+0	+0	+1	+0	+0
0000A70	+0	+0	+0	+0	+0	+0	+0	+0	+0	+0	+0	+0	+0	+0	+0	+0	+0
0000A80	+0	+0	+0	+0	+0	+0	+0	+0	+0	+0	+0	+0	+0	+0	+0	+0	+1
0000A90	+0	+0	+0	+0	+0	+0	+0	+0	+0	+0	+1	+0	+0	+0	+0	+0	+0
0000AA0	+0	+1	+0	+0	+0	+1	+0	+0	+0	+0	+0	+0	+0	+0	+0	+0	+0
0000AB0	+0	+0	+0	+0	+0	+0	+0	+0	+0	+0	+0	+0	+0	+0	+0	+0	+0
0000AC0	+0	+0	-1	+0	+0	+1	+1	+0	+0	+0	+0	+0	+0	+0	+0	+0	+0
0000AD0	+0	+0	+0	+0	+0	+0	+0	+0	+0	+0	+0	+0	+0	+0	+0	+0	+0
0000AE0	+0	-1	-1	+2	+0	-1	+0	+0	+0	+0	+0	+0	+0	+0	+0	+0	+0
0000AF0	+0	+0	+0	+0	+0	+0	+0	+0	+0	+0	+0	+0	+0	+0	+0	+0	+0
0000B00	+1	-1	+0	+0	+0	+0	+0	+0	+0	+1	-1	+0	+0	+0	+0	+0	+0
0000B10	+0	+0	+0	+0	+0	+0	+0	+0	+0	+0	+0	+0	+0	+0	+0	+0	+0
0000B20	+0	+0	+0	+0	+0	+0	+0	+0	+0	+0	+0	+0	+0	+0	+0	+1	+0
0000B30	+0	+0	+0	+0	+0	+0	+0	+0	+0	+0	+0	+0	+0	+0	+0	+0	+0
0000B40	+0	+0	+0	+0	+0	+0	+0	+0	+0	+0	+0	+0	+0	+0	+0	+0	+0
0000B50	+0	+0	+0	+0	+0	+0	+0	+0	+0	+0	+0	+0	+0	+0	+0	+0	+0
0000B60	+0	+0	+0	+0	+0	+0	+0	+0	+0	+0	+0	+0	+0	+0	+0	+0	+0
0000B70	-1	+0	+0	+0	+0	+0	+0	+0	+0	+0	+0	+0	+0	+0	+0	+0	+0
0000B80	+0	+0	+0	+0	+0	+0	+0	+0	+0	+0	+0	+0	+0	+0	+0	+0	+0
0000B90	-1	+0	+0	+0	+0	+0	+0	+0	+0	+0	+0	+0	+0	+0	+0	+0	+0
0000BA0	+0	+0	+0	+0	+0	+0	+0	+0	+0	+0	+0	+0	+0	+0	+0	+0	+0
0000BB0	+0	+0	-1	-1	+1	+0	+0	+0	+0	+0	+0	+0	+0	+0	+0	+0	+0
0000BC0	+0	+0	+0	+0	+0	+0	+0	+0	+0	+0	+0	+0	+0	+0	+0	+0	+0
0000BD0	+0	+0	+0	-1	+0	+0	+0	+0	+0	+0	+0	+0	+0	+0	+0	+0	+0
0000BE0	+0	+0	+0	+0	+0	+0	+0	+0	+0	+0	+0	+0	+0	+0	+0	+0	+0
0000BF0	+0	+0	+0	+0	+0	+0	+0	+0	+0	+0	+0	+0	+0	+0	+0	+0	+0
0000C00	+1	+0	+0	+0	+0	+0	+0	+0	+0	+0	+0	+0	+0	+0	+0	+0	+0
0000C10	+1	+0	+0	+1	+0	+0	+1	+0	+0	+0	+0	+0	+0	+0	-1	+0	+0
0000C20	-1	-1	+0	-5	+3	-2	+1	+0	-1	+0	+0	+0	+0	+1	-4	-1	-1
0000C30	+0	+0	+1	-5	-2	+1	+1	+1	+6	-2	-1	+0	+1	-4	+21	+6	+6
0000C40	+0	+0	-5	-1	+1	+2	+4	+4	+3	+5	+0	+0	-1	+4	-8	-11	-11
0000C50	+0	+0	-2	+8	-1	+0	+3	+1	-18	+16	+1	-1	+2	+0	-4	-4	-4
0000C60	+0	+0	-6	+1	-3	-1	+1	+14	-23	+1	+0	+1	+0	+1	-3	-1	-1
0000C70	+0	+0	+0	-5	-2	+3	-1	+11	-8	-3	+0	+1	+0	-1	-3	+1	+1
0000C80	+0	+14	+1	+0	-1	+0	+0	-15	-2	+7	+1	-1	+1	-3	-1	-1	-1
0000C90	-2	-14	+0	+1	+0	+0	+5	-18	+14	-7	-1	-1	-2	+13	+1	-1	-1
0000CA0	+3	-14	+1	-2	+2	-1	+11	-16	-2	+2	-1	+1	+0	-9	+0	-1	-1
0000CB0	+19	+1	+1	+1	+0	+2	+2	+8	+0	+0	+0	+0	+1	-13	+0	+0	+0
0000CC0	-6	-3	-1	+0	-2	-2	+6	+13	+0	+0	+0	+1	+9	+1	+0	+0	+0
0000CD0	-1	+2	+0	+0	+1	+0	-5	+0	+0	-1	+0	+0	+1	+1	+0	+0	+0
0000CE0	+0	+0	+0	+0	+0	+0	+1	-2	-4	+1	+4	+4	-2	+0	+0	-1	-1
0000CF0	+0	+0	+0	+0	+0	+0	+0	+0	+1	+0	-4	-1	+0	+0	+0	+0	+0
0000D00	+0	+0	+0	+0	+0	+0	+0	+0	+0	+0	+0	+0	+0	+0	+0	+0	+0
0000D10	-2	-1	+1	+1	-1	-3	+0	-2	-3	+0	+0	+0	+0	+0	+0	+0	+0
0000D20	-2	-2	+0	+1	-1	+2	+0	+0	+0	+1	-1	+1	+0	+1	-8	-1	-1
0000D30	+0	+0	+1	-3	+0	+0	-1	+3	+0	+0	+1	-3	-3	-3	+3	-4	-4
0000D40	+0	+0	+0	+1	+0	+0	+3	-3	+3	-1	+1	+1	+0	+1	-5	+20	+20
0000D50	+0	+0	+0	-1	+2	+7	-1	+0	+3	-2	+1	+0	+4	-1	+0	+1	+1
0000D60	+0	+1	-3	+2	-9	-12	-19	+10	-1	+2	+0	-1	+1	+9	-13	+0	+0
0000D70	+0	+1	-4	-13	+0	+0	+16	-7	+0	+16	-3	+1	-2	-1	+2	-1	-1
0000D80	+0	+0	+0	+1	+1	+0	+0	+4	-3	-17	-14	+2	-4	-14	-1	+0	+0
0000D90	-1	+1	+0	-1	+0	+1	+1	-2	+1	+3	+17	+13	+15	+9	-2	+0	+0
0000DA0	+2	-3	+2	+2	-2	+2	+1	-1	+1	+0	+0	-2	+5	+7	-1	+0	+0
0000DB0	+1	+4	-7	-14	-7	+2	-2	+0	+0	+0	+0	+0	+0	-1	+1	+0	+0
0000DC0	-3	+17	+8	-1	+4	+8	-9	+6	+0	+1	+0	+0	+0	+0	+0	+0	+0

```

0000DD0 -1 +1 +0 +0 +0 +0 +0 +0 -2 -2 +2 +0 +0 +5 -1 +0 +0
0000DE0 -1 +0 +0 +0 +0 +0 +0 +0 +0 -5 -4 -2 -6 -1 +0 +0 +0
0000DF0 +0 +0 +0 +0 +0 +0 +0 +0 +0 +0 -7 +1 +0 +0 +0 +0 +0
0000E00 +0 +0 +0 +0 +0 +0 +0 +0 +0 +0 +0 +0 +0 +0 +0 +0
0000E10 +0 +0 +0 +1 +0 +0 +0 +0 +0 +0 +0 +0 +0 +0 +0 +0
0000E20 +0 +0 +0 +0 +0 +0 +0 +0 +0 +0 +0 +0 -1 +0 -4 -1
0000E30 +0 +0 +0 +0 +0 +0 -1 -1 +1 -1 +0 +0 +0 +0 +2 +2
0000E40 +0 +0 +0 +3 +0 +0 +1 +1 -1 +1 +0 +0 +0 +0 -4 -8
0000E50 +0 +0 +0 -1 +0 +0 -1 -1 -1 +0 +0 +0 +0 +0 +0 +0
0000E60 +0 +0 +0 +1 +1 -1 -3 +3 +0 +0 +0 -1 +1 +0 +0 +0
0000E70 +0 +1 -2 +0 +0 -1 +3 +1 +2 -1 +0 +0 +0 -2 -1 +0
0000E80 +0 +0 +0 +0 +0 +0 +0 +0 +1 +0 +1 +1 +0 -3 +0 +0
0000E90 +0 +0 +0 +0 +0 +0 +1 +0 -1 +2 +0 -1 +1 +0 +0 +0
0000EA0 +1 +1 +0 +0 +0 +0 +0 -1 +0 +0 +0 -1 +0 -2 +0 +0
0000EB0 +2 +2 +1 -1 +0 -1 +0 +0 +0 +0 +0 +0 +0 +0 +0 +0
0000EC0 -2 +2 +0 +0 +1 -2 +1 -1 -1 +0 +0 +0 +0 +0 +0 +0
0000ED0 +0 +0 +0 +0 +0 +0 +1 +0 +0 +0 +0 -1 -2 +0 +0 +0
0000EE0 +0 +0 +0 +0 +0 +0 +0 +0 +1 +1 -1 -1 +0 +0 +0 +0
0000EF0 +0 +0 +0 +0 +0 +0 +0 +0 +0 +0 +1 +0 +0 +0 +0 +0
0000F00 +0 +0 -2 -2 +1 +0 -1 -2 +0 -1 +8 +6 +3 +0 -1 -6
0000F10 +0 +4 +5 -13 -53 -3 -2 +0 -2 -15 -7 +25 +8 +3 +7 -25
0000F20 +26 -12 +5 +20 +6 +7 -5 -13 +2 -2 +5 -54 +10 -2 +30 +3
0000F30 -46 +11 -9 -1 -2 +1 -18 -2 +8 -3 +3 -5 -4 -1 -5 -2
0000F40 -3 +0 +1 -10 -3 +1 -1 +1 -5 -1 -3 +3 +7 -14 -13 +10
0000F50 +0 -1 +11 +2 +5 +2 +12 +0 -8 +24 -21 -49 -4 +10 +9 +31
0000F60 -1 +5 +10 +1 +13 -57 -52 +9 +12 -6 -18 +5 +1 -3 -4 -1
0000F70 +13 +21 +8 +11 +3 +7 +7 -2 -3 -1 +0 +2 -14 -19 -7 +1
0000F80 -1 -1 -3 -2 +0 +0 -1 -1 -1 -7 +3 +4 +7 -1 -6 -14
0000F90 -1 -7 +3 -12 -16 -2 +2 -1 -9 +1 +7 -21 +25 -4 -2 -23
0000FA0 +2 +2 +3 -4 +22 -4 +5 -4 -2 -2 +4 -7 +0 +0 +3 +2
0000FB0 +17 -6 +7 +5 +3 +1 -5 +0 +1 +0 +0 +6 +1 -4 +2 +0
0000FC0 -1 +1 -1 -14 +3 +0 -7 -4 +50 -13 -11 +34 -26 -23 -3 -1
0000FD0 +45 -4 +21 +57 -17 -43 -17 -15 +27 -7 +25 +30 -23 +65 -13 -88
0000FE0 +45 -103 +85 +71 -116 +88 -30 -57 +57 -101 +94 +25 +17 +5 +6 -107
0000FF0 +15 -31 +20 -26 +142 -18 -23 -95 +69 -7 -13 -9 +5 +18 -38 -18

```

4.2.4.2.2 Cb Component Data

The following is a dump of the Cb component data, as shown in the figure illustrating three-level DWT decomposition in section [3.1.8.1.4](#).

```

00000000 +0 +0 +0 +0 +0 +0 +0 +0 +0 +0 +0 +0 +0 +0 +0
00000010 +0 +0 +0 +0 +0 +0 +0 +0 +0 +0 +0 +0 +0 +0 +0
00000020 +0 +0 +0 +0 +0 +0 +0 +0 +0 +0 +0 +0 +0 +0 +0
00000030 +0 +0 +0 +0 +0 +0 +0 +0 +0 +0 +0 +0 +0 +0 +0
00000040 +0 +0 +0 +0 +0 +0 +0 +1 +0 +0 +0 +0 +0 +0 +0
00000050 +0 +0 +0 +0 +0 +0 +0 +0 +0 +0 +0 +0 +0 +0 +0
00000060 +0 +0 -1 +0 +0 +0 +0 -1 +0 +0 +0 +0 +0 +0 +0
00000070 -1 +1 -1 +0 +0 +0 +0 +0 +0 +0 +0 +0 +0 +0 +0
00000080 +0 +0 +0 +0 +0 +0 +9 -1 +0 +0 +0 +0 +0 +0 +0
00000090 +0 -1 +7 +0 +0 +0 +0 +0 +0 +0 +0 +0 +0 +0 +0
000000A0 +0 +0 +0 +0 +0 +0 +1 +1 +0 +0 +0 +0 +0 +0 +0
000000B0 +0 -6 +3 +2 +2 +0 +0 +0 +0 +0 +0 +1 -1 +1 +0
000000C0 +0 +0 +0 +0 +0 +0 -8 +0 +0 +0 +0 +0 +0 +0 +0
000000D0 +0 -6 -2 -1 -1 +1 +0 +1 +0 +0 +0 +3 -7 +7 -8 +1
000000E0 +0 +0 +0 +0 +0 +5 -4 +0 +0 +0 +0 +0 +0 +0 +0
000000F0 +1 +6 +0 -10 +0 +0 +0 -1 +0 +1 +0 +0 +0 -2 -5 -2

```

```

00000100 +0 +0 +0 +0 +0 +5 +4 +0 +0 +0 +0 +0 +0 +1 +1 +0
00000110 -2 +6 +9 -2 +0 +0 +0 +0 +0 +0 +0 +1 +0 +2 +6 +0
00000120 +0 +0 +0 +0 -1 -6 -2 -2 +0 +0 +0 +0 +0 +1 +0 +0
00000130 -7 +0 +5 +1 +0 +0 +0 +0 +0 +0 +0 +0 +0 -1 +0 +0
00000140 +0 +0 +0 +0 +2 -6 +0 +4 +0 +0 +0 +0 +0 +1 -1 +1
00000150 +0 -1 -7 +0 +0 +0 +0 +0 +0 +0 +0 +0 +0 -9 +0 +0
00000160 +0 +0 +0 +0 +8 +0 +0 +0 -2 +0 +0 +0 +0 +1 +1 +0
00000170 +6 +3 -4 +0 +0 +0 +0 +0 +0 +0 +0 +0 +1 +2 +0 +0
00000180 +0 +0 +0 +0 +0 +0 -1 -2 -1 +0 +0 +0 +0 +0 +0 -4
00000190 +1 +6 +0 +0 +0 +0 +0 +0 +0 +0 +0 +0 -1 +9 +0 +0
000001A0 +0 +0 +0 +0 -8 +1 +0 +1 +0 +0 +0 +0 +0 +1 +0 -3
000001B0 -1 -2 +0 +0 +0 +0 +0 +0 +0 +0 +0 +0 -8 +1 +0 +0
000001C0 +0 +0 +0 +0 +1 +0 +0 +0 -1 +0 +0 +0 +0 +0 +1 +0
000001D0 +0 -4 +0 +0 +0 +0 +1 +0 +0 +0 +0 +0 -5 +0 +0 +0
000001E0 +0 +0 +0 -1 +0 +0 +0 +0 +0 +0 +0 +0 +0 -1 +1 +0
000001F0 +3 -1 +0 +0 +0 +0 +0 +0 +0 +0 +0 -1 +8 +0 +0 +0
00000200 +0 +0 +0 +1 +0 +0 +0 +0 +0 +0 +0 +0 +0 +0 -3 +0
00000210 +0 +0 +0 +0 -1 +1 +0 +0 -1 +0 -1 +0 +1 +0 +0 +0
00000220 +0 +0 -1 +1 +0 +0 +0 +0 +0 +0 +0 +0 +0 +0 +0 +0
00000230 -5 +0 +0 +0 +0 +0 -1 +0 +0 +0 +1 -2 +0 +0 +0 +0
00000240 +0 +0 -2 +0 +0 +0 +0 +0 +0 +0 +0 +0 +0 -1 +3 +2
00000250 -1 +0 +0 +0 +0 +0 +0 +0 +0 +2 +0 +2 +0 +0 +0 +0
00000260 +0 +0 +0 +0 +0 +0 +0 +0 +0 +0 +0 +0 +0 -2 +1 +4
00000270 +0 +0 +0 +0 +0 +2 +0 +0 +0 -1 -1 +10 +0 +0 +0 +0
00000280 +0 +0 +2 +0 +0 +0 +0 +0 +0 +0 +0 +0 +0 -1 -1 -2
00000290 +0 +0 +0 +0 +0 -2 +2 +0 +0 +0 -10 +1 +0 +0 +0 +0
000002A0 +0 -1 +0 +0 +0 +0 +0 +0 +0 +0 +0 +0 +0 +2 +1 -4
000002B0 +0 +0 +0 +0 +0 +0 -1 +1 +0 +0 -3 -1 +0 +0 +0 +0
000002C0 +0 -1 +0 -1 +1 +1 +0 +0 +0 +0 +0 +0 -1 +1 +6 +0
000002D0 +0 +0 +0 +0 +0 +0 +0 -1 +0 +1 +12 +0 +0 +0 +0 +0
000002E0 +0 +1 -1 +0 -1 +0 +1 +0 -1 +0 +0 +0 +0 +0 +2 +0
000002F0 +0 +0 +0 +0 +0 +0 +0 +0 +0 -7 +5 +0 +0 +0 +0 +0
00000300 -1 +1 +1 +0 +1 +0 +0 +0 +0 +0 +0 +0 +0 -1 -8 +0
00000310 +0 +0 +0 +0 +0 +0 +0 +0 +0 -11 -1 +0 +0 +0 +0 +0
00000320 +0 +0 +0 +0 +0 +0 -1 +0 +0 +0 +0 -1 +5 -4 +0 +0
00000330 +0 +0 +0 +0 +0 +0 +0 +0 +1 +6 +0 +0 +0 +0 +0 +0
00000340 +0 +0 +0 +0 +0 +0 +0 +0 +0 +0 +0 +0 +0 +7 +1 +0
00000350 +0 +0 +0 +0 +0 +0 +0 +0 -2 +10 +0 +0 +0 +0 +0 +0
00000360 +0 +0 +0 +0 +0 +0 +0 +0 +0 +0 +0 +0 +0 +4 -1 +0
00000370 +0 +0 +0 +0 +0 +0 +0 +0 -10 +1 +0 +0 +0 +0 +0 +0
00000380 +0 +0 +0 +0 +0 +0 +0 +0 +0 +0 +0 +0 +0 -1 +3 +0
00000390 +1 +0 +0 +0 +0 +1 -2 +0 +1 +0 +0 +0 +0 +0 +0 +0
000003A0 +0 +0 +0 +0 +0 +0 +0 +0 +0 +0 +0 +0 +0 +0 +0 +0
000003B0 +1 +0 +1 +0 -1 +0 +1 +0 +0 +0 +0 +0 +0 +0 +0 +0
000003C0 +0 +0 +0 +0 +0 +0 +0 +0 +0 +0 +0 +0 +0 +0 +0 +0
000003D0 +0 +0 +0 -2 +1 +0 +0 +0 +0 +0 +0 +0 +0 +0 +0 +0
000003E0 +0 +0 +0 +0 +0 +0 +0 +0 +0 +0 +0 +0 +0 +0 +0 +0
000003F0 +0 +0 +0 +1 +0 +0 +0 +0 +0 +0 +0 +0 +0 +0 +0 +0
00000400 +0 +0 +0 +0 +0 +0 +0 +0 +0 +0 +0 +0 +0 +0 +0 +0
00000410 +0 +0 +0 +0 +0 +0 +0 +0 +0 +0 +0 +0 +0 +0 +0 +0
00000420 +0 +0 +0 +0 +0 +0 +0 +0 +0 +0 -1 +2 +4 +5 +2 -1
00000430 +0 +0 +0 +0 +0 +0 +0 +0 +0 +0 +0 +0 +0 +0 +0 +0
00000440 +0 +0 +0 +0 +0 +0 +0 -1 +7 +4 -8 -7 -4 -4 -6 -7
00000450 +7 +1 +0 +0 +0 +0 +0 +0 +0 +0 +0 +0 +0 +0 +0 +0
00000460 +1 +1 +1 +0 +0 +0 +0 -3 -3 +1 +0 +0 +0 +0 +0 +0
00000470 +1 -8 +6 -1 +0 +0 +0 +0 +0 +0 +0 +0 +0 +0 +0 +0
00000480 +1 +1 +1 +0 +0 +0 +0 +0 +0 +0 +0 +0 +0 +0 +0 +0
00000490 +0 +0 -1 +0 +1 +0 +0 +0 +0 +0 +0 +0 +0 +0 +0 +0
000004A0 +0 +0 +0 +0 +0 +0 +0 +0 +0 +0 +0 +0 +0 +0 +0 +0

```

```

000004B0 +0 -1 +1 +1 -6 +8 -1 +0 +0 +0 +0 +0 +2 +8 +2 +2
000004C0 +0 +0 +0 +0 +0 +0 +0 +0 +0 +0 +0 +0 +0 +0 +0
000004D0 +0 +0 +0 +1 +0 +0 -8 +7 +7 +4 +5 +8 +1 -1 -7 +0
000004E0 +0 +0 +0 +0 +0 +0 +1 +0 +0 +0 +0 +0 +0 +0 +1 +0
000004F0 +0 -1 +1 +0 +0 +0 +0 +1 -2 -4 -4 -1 +1 -1 +0 +0
00000500 +0 +0 +0 +0 +0 +0 -1 +1 +0 +0 +0 +0 +0 +0 +0 +0
00000510 +0 +0 +1 -2 +0 +0 +0 +0 +0 +0 +0 +0 +0 +0 +2 -2
00000520 +0 +0 +0 +0 +0 +1 +0 +0 +0 +0 +0 +1 +0 +0 +0 +0
00000530 +0 +0 +0 +0 +0 +0 +0 +0 +0 +0 +0 +0 +0 +0 +1 +0
00000540 +0 +0 +0 +0 +0 +0 +0 +0 +0 +0 +0 +0 -2 -1 +2 -1
00000550 +0 +0 +0 +0 +0 +0 +0 +0 +0 +0 +0 +0 +0 +0 +0 +0
00000560 +0 +0 +0 +0 +0 +0 +0 +0 +0 -3 -3 -1 +1 +0 +1 +0
00000570 +0 +0 +0 +0 +0 +0 +0 +0 +0 +0 +0 +0 +0 -1 +1 +0
00000580 +0 +0 +0 +0 +1 -4 -6 +4 +7 +5 +4 +6 +5 -5 +0 +0
00000590 +1 +0 +0 +0 +0 +0 +0 +0 -1 -4 -3 +0 +0 +0 +0 +0
000005A0 +0 +0 +0 +0 +1 +5 -1 +0 +1 +1 +1 +2 +0 -1 +5 -4
000005B0 +0 +0 +0 +0 +0 +0 +0 +1 +2 +0 +1 +5 -3 +2 +0 +0
000005C0 +0 +0 +0 +0 -1 +0 +1 +0 +0 +0 +0 -1 -3 +3 +0 +0
000005D0 +0 +0 +0 +0 +0 +0 +1 +0 -1 +0 -1 -1 +1 -2 +0 +0
000005E0 +0 +0 +0 +0 +0 +0 +0 +0 +0 +0 +0 +0 +0 -3 +1
000005F0 -1 +3 -4 +0 +0 +0 +0 +0 +0 +1 -2 -7 +2 +0 +0
00000600 +0 +0 +0 +0 +0 +0 +0 +0 +0 +0 +0 +0 +0 +0 +0
00000610 +1 +1 +0 +5 -5 -4 -3 -3 -7 -9 +3 +8 -1 +0 +0 +0
00000620 +0 +0 +0 +0 +0 +0 +0 +0 +0 +0 +0 +0 +0 +0 -1 +0
00000630 +1 -4 +4 +0 -1 +1 +3 +4 +2 -2 +4 +8 -2 +0 +0 +0
00000640 +0 +0 +0 +0 +0 +0 +0 +0 +0 +0 +0 +0 +0 +2 +2 +0
00000650 -1 +0 +0 -4 +0 +5 +6 +7 +2 -9 -7 +0 +1 +0 +0 +0
00000660 +0 +0 +0 +0 +0 +0 +0 +0 +0 +0 +0 +0 +0 +1 +0
00000670 +0 +0 +0 +0 +0 +0 +1 +0 +0 +1 +0 +0 +0 +0 +0 +0
00000680 +0 +0 +0 +0 +0 +0 +0 +0 +0 +0 +0 +0 +0 +0 +1
00000690 +0 +0 +0 +0 +0 +0 -2 +4 +0 +0 +0 +2 +0 +0 +0 +0
000006A0 +0 +0 +0 +0 +0 +0 +0 +0 +0 +0 +0 +0 +0 +0 +0
000006B0 +0 +0 +0 +0 +0 +0 +0 -1 -5 +2 -1 +0 +0 +0 +0 +0
000006C0 +0 +0 +0 -1 -1 +0 +0 +0 +0 +0 +0 +0 +0 +0 +0
000006D0 +0 +0 +0 +0 +0 +0 +0 +0 +0 -1 +0 +0 +0 +0 +0
000006E0 +0 +0 +0 +0 +1 +1 +2 +1 +1 +0 +0 +0 +0 +0 +0
000006F0 +0 +0 +0 +0 +0 +0 +0 +0 +0 -1 +1 -1 +0 +0 +0
00000700 +0 +1 +1 -2 +0 -1 +0 +1 -1 -1 +1 +0 +0 +1 +0
00000710 +0 +0 +0 +0 +0 +0 +0 +0 +0 +0 +0 +0 +0 +0 +0
00000720 +0 +0 +0 +0 +0 +0 +0 +0 +0 +0 +0 -1 +0 +1 -1 +0
00000730 +0 -1 +0 +0 +0 +0 +0 +0 +0 -1 +1 +0 +0 +0 +0
00000740 +0 +0 +0 +0 +0 +0 +0 +0 +0 +0 +0 +0 +0 -1 -3 +0
00000750 +0 +0 +0 +0 +0 +0 +0 +0 +0 +0 +0 +0 +0 +0 +0
00000760 +0 +0 +0 +0 +0 +0 +0 +0 +0 +0 +0 +0 -1 +8 -7
00000770 +0 +0 +0 +0 +0 +0 +1 -2 -11 +2 +0 +0 +0 +0 +0
00000780 +0 +0 +0 +0 +0 +0 +0 +0 +0 +0 +0 +0 +0 +0 +2
00000790 +5 +0 -9 -10 -7 -4 +7 +9 +0 +0 +0 +0 +0 +0 +0
000007A0 +0 +0 +0 +0 +0 +0 +0 +0 +0 +0 +0 +0 +0 +0 +0
000007B0 +0 +0 +0 -4 -2 -1 +0 +0 +0 +0 +0 +0 +0 +0 +0
000007C0 +0 +0 +0 +0 +0 +0 +0 +0 +0 +0 +0 +0 +0 +0 +0
000007D0 +0 +0 +0 +0 +2 +0 +0 +0 +0 +0 +0 +0 +0 +0 +0
000007E0 +0 +0 +0 +0 +0 +0 +0 +0 +0 +0 +0 +0 +0 +0 +0
000007F0 +0 +0 +0 +0 +0 +0 +0 +0 +0 +0 +0 +0 +0 +0 +0
00000800 +0 +0 +0 +0 +0 +0 +0 +0 +0 +0 +0 +0 +0 +0 +0
00000810 +0 +0 +0 +0 +0 +0 +0 +0 +0 +0 +0 +0 +0 +0 +0
00000820 +0 +0 +0 +0 +0 +0 +0 +0 +0 +0 +0 +0 +0 +0 +0
00000830 +0 +0 +0 +0 +0 +0 +0 +0 +0 +0 +0 +0 +0 +0 +0
00000840 +0 +0 +0 +0 +0 +0 +0 +0 +1 +0 +0 +0 +0 +0 +0
00000850 +1 +0 +0 +0 +0 +0 +0 +0 +0 +0 +0 +0 +0 +0 +0

```

00000860 +0 +0 +0 +0 +0 +0 +0 -1 +0 +0 +0 +0 +0 +0 +0 +0
00000870 +0 +0 -1 +0 +0 +0 +0 +0 +0 +0 +0 +0 +0 +0 +0 +0
00000880 +0 +0 +0 +0 +0 +0 +0 +0 +0 +0 +0 +0 +0 +0 +0 +0
00000890 +0 +0 +0 +0 +0 +0 +0 +0 +0 +0 +0 +0 +0 +0 +0 +0
000008A0 +0 +0 +0 +0 +0 +0 +0 +0 +0 +0 +0 +0 +0 +0 +0 +0
000008B0 +0 -1 +0 +1 +0 +0 +0 +0 +0 +0 +0 +0 +1 -2 +1 +0
000008C0 +0 +0 +0 +0 +0 +0 +0 +0 +0 +0 +0 +0 +0 +0 +0 +0
000008D0 +0 +0 +0 -1 +0 +0 +0 +1 +0 +0 +0 +2 +0 -1 +0 +0
000008E0 +0 +0 +0 +0 +0 +0 +0 +0 +0 +0 +0 +0 +0 +0 +0 +0
000008F0 +0 +1 +0 +0 +0 +0 +0 +0 +0 +0 +0 +0 +0 +0 +0 +0
00000900 +0 +0 +0 +0 +0 +0 +0 +0 +0 +0 +0 +0 +0 +0 +0 +0
00000910 +0 +0 +1 +0 +0 +0 +0 +0 +0 +0 +0 +0 +0 +0 -1 +0
00000920 +0 +0 +0 +0 +0 -1 +0 +0 +0 +0 +0 +0 +0 +0 +0 +0
00000930 +0 +0 +0 +0 +0 +0 +0 +0 +0 +0 +0 +0 +0 +0 +1 +0
00000940 +0 +0 +0 +0 +0 +0 +0 +0 +0 +0 +0 +0 +0 +0 +0 +0
00000950 +0 +0 +0 +0 +0 +0 +0 +0 +0 +0 +0 +0 +0 +0 +0 +0
00000960 +0 +0 +0 +0 +0 +0 +0 +0 +0 +0 +0 +0 +0 +0 +0 +0
00000970 +0 +0 +0 +0 +0 +0 +0 +0 +0 +0 +0 +0 +0 +1 +0 +0
00000980 +0 +0 +0 +0 +0 -1 +0 +1 +0 +0 +0 +0 +0 +0 +0 +0
00000990 +0 +0 +0 +0 +0 +0 +0 +0 +0 +0 +0 +0 +0 +0 +0 +0
000009A0 +0 +0 +0 +0 +1 +0 +0 +0 +0 +0 +0 +0 +0 +0 +0 +0
000009B0 +0 +0 +0 +0 +0 +0 +0 +0 +0 +0 +0 +0 +0 +0 +0 +0
000009C0 +0 +0 +0 +0 +0 +0 +0 +0 +0 +0 +0 +0 +0 +0 +0 +0
000009D0 +0 +0 +0 +0 +0 +0 +0 +0 +0 +0 +0 +0 +1 +0 +0 +0
000009E0 +0 +0 +0 +0 +0 +0 +0 +0 +0 +0 +0 +0 +0 +0 +0 +0
000009F0 -1 +0 +0 +0 +0 +0 +0 +0 +0 +0 +1 +0 +1 +0 +0 +0
00000A00 +0 +0 +0 +0 +0 +0 +0 +0 +0 +0 +0 +0 +0 +0 +0 +0
00000A10 +1 +0 +0 +0 -1 +0 +0 +0 +0 +1 +0 +0 +0 +0 +0 +0
00000A20 +0 +0 +0 +0 +0 +0 +0 +0 +0 +0 +0 +0 +0 +0 +0 +0
00000A30 +0 +0 +0 +0 +0 +0 +0 +0 +0 +0 +1 -2 +0 +0 +0 +0
00000A40 +0 +0 +0 +0 +0 +0 +0 +0 +0 +0 +0 +0 +0 +0 +0 +0
00000A50 +0 +0 +0 +0 +0 +0 +0 +0 +0 -1 +0 +1 +0 +0 +0 +0
00000A60 +0 +0 +0 +0 +0 +0 +0 +0 +0 +0 +0 +0 +0 +0 +0 +0
00000A70 +0 +0 +0 +0 +0 +0 -1 -1 +0 +0 +0 +0 +0 +0 +0 +0
00000A80 +0 +0 +0 +0 +0 +0 +0 +0 +0 +0 +0 +0 +0 +0 +0 +0
00000A90 +0 +0 +0 +0 +0 +0 +0 -1 +0 +0 +0 +0 +0 +0 +0 +0
00000AA0 +0 +0 +0 +0 +0 +0 +0 +0 +0 +0 +0 +0 +0 +0 +0 +0
00000AB0 +0 +0 +0 +0 +0 +0 +0 +0 +0 +0 -1 +0 +0 +0 +0 +0
00000AC0 +0 +0 +0 +0 +0 +0 +0 +0 +0 +0 +0 +0 +0 +0 +0 +0
00000AD0 +0 +0 +0 +0 +0 +0 +0 +0 +0 +0 +0 +0 +0 +0 +0 +0
00000AE0 +0 +0 +0 -1 +0 +0 +0 +0 +0 +0 +0 +0 +0 +0 +0 +0
00000AF0 +0 +0 +0 +0 +0 +0 +0 +0 +0 -1 +0 +0 +0 +0 +0 +0
00000B00 +0 +0 +0 +0 +0 +0 +0 +0 +0 +0 +0 +0 +0 +0 +0 +0
00000B10 +0 +0 +0 +0 +0 +0 +0 +0 +0 +0 +0 +0 +0 +0 +0 +0
00000B20 +0 +0 +0 +0 +0 +0 +0 +0 +0 +0 +0 +0 +0 +0 +0 +0
00000B30 +0 +0 +0 +0 +0 +0 +0 +0 +0 +1 +0 +0 +0 +0 +0 +0
00000B40 +0 +0 +0 +0 +0 +0 +0 +0 +0 +0 +0 +0 -2 +0 +0 +0
00000B50 +0 +0 +0 +0 +0 +0 +0 +0 +0 +0 +0 +0 +0 +0 +0 +0
00000B60 +0 +0 +0 +0 +0 +0 +0 +0 +0 +0 +0 +0 +0 -1 +1 +0
00000B70 +0 +0 +0 +0 +0 +0 +0 +0 +1 +0 +0 +0 +0 +0 +0 +0
00000B80 +0 +0 +0 +0 +0 +0 +0 +0 +0 +0 +0 +0 +0 +0 +0 +0
00000B90 +1 +0 +0 +1 +0 +0 +1 +0 +0 +0 +0 +0 +0 +0 +0 +0
00000BA0 +0 +0 +0 +0 +0 +0 +0 +0 +0 +0 +0 +0 +0 +0 +0 +0
00000BB0 +0 +0 +1 +1 -1 +0 +0 +0 +0 +0 +0 +0 +0 +0 +0 +0
00000BC0 +0 +0 +0 +0 +0 +0 +0 +0 +0 +0 +0 +0 +0 +0 +0 +0
00000BD0 +0 +0 +0 +1 +0 +0 +0 +0 +0 +0 +0 +0 +0 +0 +0 +0
00000BE0 +0 +0 +0 +0 +0 +0 +0 +0 +0 +0 +0 +0 +0 +0 +0 +0
00000BF0 +0 +0 +0 +0 +0 +0 +0 +0 +0 +0 +0 +0 +0 +0 +0 +0
00000C00 +0 +0 +0 +1 +0 +0 +1 -1 +0 +0 +0 +0 +0 +0 +0 +0

```

00000C10 -1 +0 +0 +2 +0 -1 -2 +1 +1 -2 +0 +0 +0 +0 +0 +0
00000C20 +1 +1 -2 -8 -1 +1 +0 -1 -5 +9 +2 +0 +0 -1 +2 +0
00000C30 +0 +0 +1 -17 +0 +0 -1 -1 -18 +20 -1 +1 +0 +5 -8 +8
00000C40 +0 +0 +17 +1 +0 +0 +2 +3 -6 -10 +3 -1 +1 +0 +3 +32
00000C50 +0 -1 +5 +5 -1 +0 +5 +4 +14 -16 +1 +0 +0 -1 -17 +2
00000C60 +0 -1 -17 -3 -2 +1 -1 -9 +15 -1 +0 +1 -1 -1 -8 -4
00000C70 +0 +1 +0 +3 +1 -1 +1 -6 +3 +2 +0 +2 -1 +2 +11 +0
00000C80 +0 -3 +0 +1 +1 +0 +0 +7 +1 -3 +0 -1 -4 +0 +4 +0
00000C90 +0 +3 +0 +0 +0 +0 -2 +10 -7 +4 +0 -1 +3 -24 -2 +0
00000CA0 -1 +4 +0 +2 -1 +0 -5 +10 +2 -1 -3 +4 -1 +11 -1 +0
00000CB0 -4 +1 +0 -1 +0 +0 -2 -6 +0 +0 +1 -2 +0 +24 +0 +0
00000CC0 +1 +2 +1 +0 +0 +0 -1 -17 +0 +0 +0 -1 -26 +0 +0 +0
00000CD0 +0 -1 +0 +0 +0 +0 +22 -2 -1 +0 +0 +2 -7 -3 +0 +0
00000CE0 +0 +0 +0 +0 +0 +0 -1 +2 +1 -1 -2 -4 +8 +0 +0 +0
00000CF0 +0 +0 +0 +0 +0 +0 -1 +0 +0 +3 +2 +0 +0 +0 +0 +0
00000D00 +0 +0 +0 +0 -2 +0 +10 +6 -2 +0 +0 +0 +0 +0 +0 +0
00000D10 +1 +1 +0 +2 -3 -19 -9 -13 -13 +14 -2 +0 +0 +0 +0 +0
00000D20 +1 +1 +0 +0 +1 -1 +0 +0 +0 -2 +14 +2 -2 -2 +6 +8
00000D30 +0 +0 +1 -2 +0 +0 +0 +1 +0 +1 +0 -17 -6 +1 -8 -9
00000D40 +0 +0 +1 -1 +0 +1 +1 -1 +0 +0 +0 -2 -1 +0 +0 -2
00000D50 +0 +0 +1 +1 -1 -8 +0 +3 -1 +0 +1 +1 +3 +1 +0 +0
00000D60 +0 +1 -7 +13 +13 +12 +14 -7 +0 +0 +0 -1 +1 +9 -7 +2
00000D70 +0 +0 -1 +2 +0 +0 -8 +4 +0 -9 +2 +2 +0 +1 -12 +3
00000D80 +0 +0 +0 +0 +0 +0 +0 -2 +1 +9 +10 -4 +2 +35 +4 +0
00000D90 +0 +0 +0 +1 +0 +0 -1 +1 +0 -1 -10 -8 -21 -13 +3 +0
00000DA0 -1 +1 -1 +0 +1 -1 +0 +1 +0 +1 +1 -5 +14 +14 -2 +0
00000DB0 +0 +0 +2 +3 +2 +0 +1 +1 +0 +1 +0 +0 +1 +1 -1 +0
00000DC0 +0 -3 -1 +0 +0 -2 +2 +0 -1 -1 +0 +0 -1 +1 +0 +0
00000DD0 +0 -1 +0 +0 +0 +0 +2 -12 -4 +1 +1 +2 -20 +4 +0 +0
00000DE0 +0 +0 +0 +0 +0 +0 +0 -3 +19 +16 +15 +24 +3 +0 +0 +0
00000DF0 +0 +0 +0 +0 +0 +0 +0 +0 +0 +0 +6 -1 +0 +0 +0 +0
00000E00 +0 +0 +0 +0 +0 +0 +1 +0 +0 +0 +0 +0 +0 +0 +0 +0
00000E10 +0 +0 +0 +4 -1 +0 +0 -1 +3 -2 +0 +0 +0 +0 +0 +0
00000E20 +0 +0 +0 -1 +0 +0 +0 +0 +0 -1 +3 +0 +0 -1 +2 +0
00000E30 +0 +0 +1 +0 +0 +0 +0 +0 -1 +2 +2 -1 +1 -1 +3 +4
00000E40 +0 +0 +1 +2 +0 +0 +0 +1 +2 -1 +0 +0 +0 +0 +1 +0
00000E50 +0 +0 -2 -1 -1 +0 +0 +1 +1 +0 +0 +0 +0 +0 -1 +0
00000E60 +0 +1 -2 +0 +0 +0 +2 -2 +0 +0 +0 -1 +1 -1 +4 +0
00000E70 +0 +0 +0 +0 +0 +0 -2 +0 -1 +0 -1 -1 +1 -1 +3 +0
00000E80 +0 +0 +0 +0 +0 +0 +0 +0 -1 +0 +0 -1 +0 +6 +0 +0
00000E90 +0 +0 +0 +0 +0 +0 +0 +0 +1 -1 +0 -2 -2 +0 +0 +0
00000EA0 +0 +0 +0 +0 +0 +0 +0 +1 +0 +0 +1 -2 +0 -2 +0 +0
00000EB0 +0 +0 -1 +0 +0 +0 +0 +0 +0 +0 +0 +0 -1 +0 +0 +0
00000EC0 +0 +0 +0 +0 +0 +1 +0 +0 +0 +0 +0 +0 -1 +0 +0 +0
00000ED0 +0 +0 +0 +0 +0 +0 +2 -3 +0 +0 +0 +2 +6 +0 +0 +0
00000EE0 +0 +0 +0 +0 +0 +0 -1 +0 -1 +0 +2 +0 +0 +0 +0 +0
00000EF0 +0 +0 +0 +0 +0 +0 +0 +0 +0 -1 +0 +0 +0 +0 +0 +0
00000F00 +0 -9 -1 -2 +5 +1 +1 +0 +1 +33 -2 -2 +5 +1 +2 -3
00000F10 -4 -14 -3 +2 +76 +4 +5 +17 +3 -37 +1 -15 -8 +3 -1 +80
00000F20 -5 +14 -2 -11 +2 +7 -16 +15 -2 +3 -2 +29 -2 +1 -51 -8
00000F30 +6 -4 +3 +4 +6 +4 +35 -1 -1 +1 -2 +8 -3 -7 +17 +1
00000F40 +1 -4 +35 -4 +34 -5 +2 -1 +3 +0 +0 +2 +3 -17 +46 +10
00000F50 -2 +4 -9 -5 -2 +3 +4 +0 +1 +4 +28 +33 +2 -3 +14 -6
00000F60 -1 +0 -4 -1 -7 +38 +60 -5 -3 +2 +6 +1 +4 +4 -3 +1
00000F70 -1 -3 -2 -7 -28 -5 -31 +8 +2 +0 +0 -8 +56 +85 +24 -3
00000F80 +0 -10 +3 -4 +4 +2 +1 +0 +1 +4 +2 +4 +15 +10 +6 -9
00000F90 -1 -1 -4 +1 +5 +2 +0 +4 +1 +13 -3 +10 -11 -4 +2 +7
00000FA0 -1 +0 -2 +1 -14 -3 +2 +2 +0 -1 -1 +3 +0 -5 -9 -4
00000FB0 -2 +2 -5 -28 +1 +7 +17 +1 +0 +0 +0 -18 +5 +15 -6 +0

```

```

00000FC0 +55 -4 +34 -14 +18 -33 +7 -1 -16 +19-109 -29 +19+123 +10 -6
00000FD0 -31 +13-129 +32 +31 -43 +7 +9 +83 -29 -34 +15 +32 -44 -12 -18
00000FE0 +79 +31 -21 -40 +58 -51 -33 +63 -8 +35 -31 -13 -10 -20 -44+102
00000FF0 -11 +9 +2 +17-136 +4 -58+208 -49 +6 +4 +11 -83 -38 +84 +54

```

4.2.4.2.3 Cr Component Data

The following is a dump of the Cr component data, as shown in the figure illustrating three-level DWT decomposition in section [3.1.8.1.4](#).

```

00000000 +0 +0 +0 +0 +0 +0 +0 +0 +0 +0 +0 +0 +0 +0 +0
00000010 +0 +0 +0 +0 +0 +0 +0 +0 +0 +0 +0 +0 +0 +0 +0
00000020 +0 +0 +0 +0 +0 +0 +0 +0 +0 +0 +0 +0 +0 +0 +0
00000030 +0 +0 +0 +0 +0 +0 +0 +0 +0 +0 +0 +0 +0 +0 +0
00000040 +0 +0 +0 +0 +0 +0 +0 +0 -1 +0 -1 +0 +0 +1 -1 +0
00000050 -1 +0 +0 +0 +0 +0 +0 +0 +0 +0 +0 +0 +0 +0 +0
00000060 +0 +0 +1 +0 +0 +0 +0 +0 +2 +0 +0 +0 +0 +0 +1 +0
00000070 +2 -1 +2 +0 +0 +0 +0 +0 +0 +0 +0 +0 +0 +0 +0 +0
00000080 +0 +0 +1 +0 +0 +0 -13 +2 -1 +0 +0 +0 +0 +0 +0 +0
00000090 +0 +1 -10 +0 +0 +0 +0 +0 +0 +0 +0 +0 +0 +0 +0 +0
000000A0 +0 +0 +0 +0 +0 +1 -1 -1 +0 +0 +0 +0 +0 +0 +0 +0
000000B0 +0 +7 -4 -1 -1 +0 +0 +0 +0 +0 +0 +0 -1 +1 +0 +0
000000C0 +0 +0 +0 +0 +0 +1 +12 +0 +0 +0 +0 +0 +0 +0 +0 +0
000000D0 +0 +8 +2 +0 +0 +0 +0 +0 +0 +0 +0 -1 +3 -3 +3 -1
000000E0 +0 +0 +0 +0 +0 -7 +6 +0 +0 +0 +0 +0 +0 +0 +0 +0
000000F0 -1 -6 +0 +4 +0 +0 +0 +0 +0 +0 +0 +0 +0 +2 +1
00000100 +0 +0 +0 +0 +0 -7 -4 +0 +0 +0 +0 +0 +0 -2 -1 +0
00000110 +2 -6 -4 +1 +0 +0 +0 +0 +0 +0 +0 +0 +0 +0 -3 +0
00000120 +0 +0 +0 +0 +1 +9 +1 +2 +0 +0 +0 +0 +0 -2 +0 +0
00000130 +6 +0 -3 -1 +0 +0 +0 +0 +0 +0 +0 +0 +0 +0 +0 +0
00000140 +0 +0 +0 +0 -3 +9 -1 -3 +0 +0 +0 +0 +0 +0 +1 +0
00000150 +0 +1 +5 +0 +0 +0 +0 +0 +0 +0 +0 +0 +0 +4 +0 +0
00000160 +0 +0 +0 +0 -12 +0 +0 +0 +2 +0 +0 +0 +0 +0 +0 +0
00000170 -6 -3 +3 +0 +0 +0 +0 +0 +0 +0 +0 +0 +0 -1 +0 +0
00000180 +0 +0 +0 +1 +0 +0 +1 +1 +0 +0 +0 +0 +0 +0 +0 +4
00000190 -1 -6 +0 +0 +0 +0 +0 +0 +0 +0 +0 +0 +0 -4 +0 +0
000001A0 +0 +0 +0 +0 +13 -1 +0 +0 +0 +0 +0 +0 -1 +0 +3
000001B0 +1 +2 +0 +0 +0 +0 +0 +0 +0 +0 +0 +0 +4 +0 +0 +0
000001C0 +0 +0 +0 +0 -2 +0 +0 -1 +2 +0 +0 +0 +0 +0 -1 +0
000001D0 -1 +5 +0 +0 +0 +0 +0 +0 +0 +0 +0 +0 +1 -1 +0 +0
000001E0 +0 +0 +0 -1 +0 +0 -1 +0 +1 +0 +0 +0 +0 +1 -1 +0
000001F0 -3 +1 +0 +0 +0 +0 +0 +0 +0 +0 -1 -5 +0 +0 +0
00000200 +0 +0 +0 +2 +0 +0 -1 +0 +0 +0 +0 +0 +0 +0 +4 +0
00000210 -1 +0 +1 +0 +0 +0 +0 +0 +0 +0 +0 +0 +0 +0 +0 +0
00000220 +0 +0 -1 +1 +0 +0 +0 +0 +0 +0 +0 +0 -1 -1 +1
00000230 +7 +0 +0 +0 +0 +0 +0 +0 +0 +0 -1 +1 +0 +0 +0 +0
00000240 +0 +0 -1 +0 +0 +0 +0 +0 +0 +0 +0 +0 +1 -3 -3
00000250 +2 +0 +0 +0 +0 +0 +0 +0 +0 -1 +1 -1 +0 +0 +0 +0
00000260 +0 +0 +1 +0 +0 +0 -1 +0 +0 +0 +0 +0 +0 +2 +0 -5
00000270 +0 +0 +0 +0 +0 +0 +0 +0 +0 +1 -7 +0 +0 +0 +0
00000280 +0 +0 +2 +0 +0 +0 +0 +0 +0 +0 +0 +0 +2 +1 +3
00000290 +0 +0 +0 +0 +0 +0 +0 +0 +0 +0 +6 -1 +0 +0 +0 +0
000002A0 +0 -2 +0 +0 +0 +0 -1 -1 +0 +0 +0 +0 +0 -2 -1 +4
000002B0 +0 +0 +0 +0 +0 +0 +0 +0 +0 +3 +1 +0 +0 +0 +0
000002C0 +0 -1 +0 +0 -1 -1 +0 +0 +0 +0 +0 +0 -1 -6 +0
000002D0 +0 +0 +0 +0 +0 +0 +0 +0 -1 -8 +0 +0 +0 +0 +0
000002E0 +1 +2 +0 +0 +0 +0 +0 +0 +1 +0 +0 +0 +0 -1 +0

```

```

000002F0 +0 +0 +0 +0 +0 +0 +0 +0 +0 +5 -4 +0 +0 +0 +0 +0
00000300 -1 +2 +0 +0 -1 +0 +0 +0 +0 +0 +0 +0 +0 +1 +6 +0
00000310 +0 +0 +0 +0 +0 +0 +0 +0 +0 +7 +1 +0 +0 +0 +0 +0
00000320 -1 +0 +0 +0 +0 +0 +1 +1 +0 +0 +0 +0 +0 -4 +3 +0
00000330 +0 +0 +0 +0 +0 +0 +0 +0 +0 -1 -4 +0 +0 +0 +0 +0
00000340 +0 +0 +0 +0 +0 +0 +0 +0 +0 +0 +0 +0 +0 -5 -2 +0
00000350 +0 +0 +1 +1 +0 +0 +0 +0 +1 -7 +0 +0 +0 +0 +0 +0
00000360 +0 +0 +0 +0 +0 +0 +0 +0 +0 +0 +0 +0 +0 -1 +1 +1
00000370 +0 -1 +0 +1 +0 +0 +0 +0 +7 +0 +0 +0 +0 +0 +0 +0
00000380 +0 +0 +0 +0 +0 +0 +0 +0 +0 +0 +0 +0 +0 +0 -2 +0
00000390 -1 +0 +0 +1 +0 -1 +1 +1 -1 +0 +0 +0 +0 +0 +0 +0
000003A0 +0 +0 +0 +0 +0 +0 +0 +0 +0 +0 +0 +0 +0 +0 +0
000003B0 -1 +0 -1 +0 +1 +0 -1 +0 +0 +0 +0 +0 +0 +0 +0 +0
000003C0 +0 +0 +0 +0 +0 +0 +0 +0 +0 +0 +0 +0 +0 +0 +0
000003D0 +0 +0 +0 +2 -1 +0 +0 +0 +0 +0 +0 +0 +0 +0 +0
000003E0 +0 +0 +0 +0 +0 +0 +0 +0 +0 +0 +0 +0 +0 +0 +0
000003F0 +0 +0 +0 +0 +0 +0 +0 +0 +0 +0 +0 +0 +0 +0 +0
00000400 +0 +0 +0 +0 +0 +0 +0 +0 +0 +0 +0 +0 +0 +0 +0
00000410 +0 +0 +0 +0 +0 +0 +0 +0 +0 +0 +0 +0 +0 +0 +0
00000420 +0 +0 +0 +0 +0 +0 +0 +0 +0 +0 +1 -3 -6 -6 -3 +1
00000430 +0 +0 +0 +0 +0 +0 +0 +0 +0 +0 +0 +0 +0 +0 +0
00000440 +0 +0 +0 +0 +0 +0 +0 +1 -10 -5 +11 +9 +6 +5 +9 +11
00000450 -11 -1 +0 +0 +0 +0 +0 +0 +0 +0 +0 +0 +0 +0 +0
00000460 -1 -1 -1 +0 +0 +0 +0 +4 +4 -1 +0 +0 +0 +0 +0 +0
00000470 -1 +11 -10 +2 +0 +0 +0 +0 +0 +0 +0 +0 +0 +0 +0
00000480 -1 -1 -1 +0 +0 +0 -1 +1 +0 +0 +0 +0 +0 +0 +0 +0
00000490 +0 +0 +1 +0 -1 +0 +0 +0 +0 +0 +0 +0 +0 +0 +0
000004A0 +0 +0 +0 +0 +0 +0 +0 +0 +0 +0 +0 +0 +0 +0 +0
000004B0 +0 +1 -2 +0 +3 -4 +0 +0 +0 +0 +0 +0 -1 -4 -1 -1
000004C0 +0 +0 +0 +0 +0 +0 +1 +0 +0 +0 +0 +0 +0 +0 +0
000004D0 +0 +0 +0 +0 +0 +0 +4 -3 -3 -2 -2 -4 -1 +1 +3 +0
000004E0 +0 +0 +0 +0 +0 +0 -1 +0 +0 +0 +0 +0 +0 +0 -1 +0
000004F0 +0 +1 -1 +0 +0 +0 +0 -1 +1 +2 +2 +0 +0 +0 +0 +0
00000500 +0 +0 +0 +0 +0 +0 +0 -1 +0 +0 +0 +0 +0 +0 +0
00000510 +0 +0 +0 +1 +0 +0 +0 +0 +0 +0 +0 +0 +0 +1 +2
00000520 +0 +0 +0 +0 +0 -1 +1 +0 +0 +0 +0 +0 +0 +0 +0 +0
00000530 +0 +0 +0 +0 +0 +0 +0 +0 +0 +0 +0 +0 +0 +0 -3 +0
00000540 +0 +0 +0 +0 +0 +0 +0 +0 +0 +0 +0 -1 +2 +1 -1 +1
00000550 +0 +0 +0 +0 +0 +0 +0 +0 +0 +0 +0 +0 +0 +0 +0
00000560 +0 +0 +0 +0 +0 +0 +0 +0 +0 +3 +2 +1 +0 +0 +0
00000570 +0 +0 +0 +0 +0 +0 +0 +0 +0 +0 +0 +0 +0 +0 +0
00000580 +0 +0 +0 +0 -1 +6 +8 -5 -7 -5 -4 -5 -4 +5 +0 +0
00000590 -1 +0 +0 +0 +0 +0 +0 +0 +0 -1 -1 +0 +0 +0 +0 +0
000005A0 +0 +0 +0 +0 -2 -8 +1 +0 -1 +0 -1 -2 +0 +1 -6 +4
000005B0 +0 -1 +1 +0 +0 +0 +0 +0 +0 +0 +0 +1 +0 -1 +0 +0
000005C0 +0 +0 +0 +0 -1 +0 +1 +0 +0 +0 +0 +1 +4 -4 +0 +0
000005D0 +0 +1 +0 +0 +0 +0 +0 +0 +0 +0 +0 +0 +3 +0 +0
000005E0 +0 +0 +0 +0 +1 +0 +0 +0 +0 +0 +0 +0 +0 +4 -1
000005F0 +1 -4 +5 +0 +0 +0 +0 +0 +0 +0 +0 +1 +2 -1 +0 +0
00000600 +0 +0 +0 +0 +0 +0 +0 +0 +0 +0 +0 +0 +0 +0 +0
00000610 -1 -1 +0 -5 +4 +4 +3 +3 +4 +4 -1 -4 +0 +0 +0 +0
00000620 +0 +0 +0 +0 +0 +0 +0 +0 +0 +0 +0 +0 +0 +1 -1
00000630 -1 +4 -5 +0 +1 -1 -3 -3 -1 +1 -3 -5 +1 +0 +0 +0
00000640 +0 +0 +0 +0 +0 +0 +0 +0 +0 +0 +0 +0 +0 -2 -3 +0
00000650 +1 +0 +0 +5 +0 -5 -6 -5 -1 +6 +4 +0 -1 +0 +0 +0
00000660 +0 +0 +0 +0 +0 +0 +0 +0 +0 +0 +0 +0 +0 +0 -1 +0
00000670 +0 +0 +0 +0 +0 +0 +0 +0 +0 +0 +0 +0 +0 +0 +0
00000680 +0 +0 +0 +0 +0 +0 +0 -1 +0 +0 +0 +0 +0 +0 -1
00000690 +1 +0 +0 +0 +0 +0 +0 -1 +0 +0 +1 -1 +0 +0 +0 +0

```



```

000006A0 -1 +0 +0 +0 +0 +0 +0 +0 +0 -1 +0 +0 +0 +0 +0
000006B0 +0 +0 +0 +0 +0 +0 +0 +0 +1 +0 +0 +0 +0 +0 +0
000006C0 +0 +1 +0 +0 +0 +0 +0 +0 +0 +0 -1 +0 +0 +0 +0
000006D0 +0 +0 +0 +0 +0 +0 +0 +0 +0 +0 +0 +0 +0 +0 +0
000006E0 +0 +0 +0 +0 +1 +2 +1 +1 +1 +0 +0 +0 -1 +0 +0
000006F0 +0 +0 +0 +0 +0 +0 +0 +0 +0 +0 -1 +1 +0 +0 +0
00000700 -1 +2 +1 -2 -2 +1 +0 -1 +0 -1 +1 +0 +0 +0 +0
00000710 +0 +0 +0 +0 +0 +0 +0 +0 +0 +0 +0 +0 +0 +0 +0
00000720 +0 -1 +0 +0 +0 +0 +0 +0 +0 +0 +0 -1 +1 -1 +1 +0
00000730 +0 +0 +0 +0 +0 +0 +0 +0 +0 +1 -1 +0 +0 +0 +0
00000740 +0 +0 +0 +0 +0 +0 +0 +0 +0 +0 +0 +0 +0 +1 +1
00000750 +0 +0 +0 +0 +0 +0 +0 +0 +0 +0 +0 +0 +0 +0 +0
00000760 +0 +1 +0 +0 +0 +0 +0 +0 +0 +0 +0 +0 +0 -4 +2
00000770 +0 +0 +0 +0 +0 +0 +0 +1 +7 -2 +0 +0 +0 +0 +0
00000780 +0 +0 +0 +0 +0 +0 +0 +0 +0 +0 +0 +0 +0 +0 -1
00000790 -2 -1 +5 +6 +4 +3 -5 -6 +1 +0 +0 +0 +0 +0 +0
000007A0 +0 +0 +0 +0 +0 +0 +0 +0 +0 +0 +0 +0 +0 +0 +0
000007B0 +0 +0 +0 +4 +2 +1 +0 +0 +0 +0 +0 +0 +0 +0 +0
000007C0 +0 +0 +0 +0 +0 +0 +0 +0 +0 +0 +0 +0 +0 +0 +0
000007D0 +0 +0 +0 +0 -2 +0 +0 +0 +0 +0 +0 +0 +0 +0 +0
000007E0 +0 +0 +0 +0 +0 +0 +0 +0 +0 +0 +0 +0 +0 +0 +0
000007F0 +0 +0 +0 +0 +0 +0 +0 +0 +0 +0 +0 +0 +0 +0 +0
00000800 +0 +0 +0 +0 +0 +0 +0 +0 +0 +0 +0 +0 +0 +0 +0
00000810 +0 +0 +0 +0 +0 +0 +0 +0 +0 +0 +0 +0 +0 +0 +0
00000820 +0 +0 +0 +0 +0 +0 +0 +0 +0 +0 +0 +0 +0 +0 +0
00000830 +0 +0 +0 +0 +0 +0 +0 +0 +0 +0 +0 +0 +0 +0 +0
00000840 +0 +0 +0 +0 +0 +0 +0 +0 -1 +0 +1 +0 +0 +0 +0
00000850 -1 +0 +0 +0 +0 +0 +0 +0 +0 +0 +0 +0 +0 +0 +0
00000860 +0 +0 +0 +0 +0 +0 +0 +2 -1 +0 +0 +0 +0 +0 +0
00000870 +0 +0 +2 +0 +0 +0 +0 +0 +0 +0 +0 +0 +0 +0 +0
00000880 +0 +0 +0 +0 +0 +0 -1 +0 +0 +0 +0 +0 +0 +0 +0
00000890 +0 +0 +0 +0 +0 +0 +0 +0 +0 +0 +0 +0 +0 +0 +0
000008A0 +0 +0 +0 +0 +0 +0 +0 +0 +0 +0 +0 +0 +0 +0 +0
000008B0 +0 +1 +0 -1 +0 +0 +0 +0 +0 +0 +0 -1 +1 -1 +0
000008C0 +0 +0 +0 +0 +0 +0 +0 +0 +0 +0 +0 +0 +0 +0 +0
000008D0 +0 +0 +0 +0 +0 +0 +0 +0 +0 +0 +0 -1 +0 +1 +0
000008E0 +0 +0 +0 +0 +0 -1 +0 +0 +0 +0 +0 +0 +0 +0 +0
000008F0 +0 -1 +0 +0 +0 +0 +0 +0 +0 +0 +0 +0 +0 +0 +0
00000900 +0 +0 +0 +0 +0 +0 +0 +0 +0 +0 +0 +0 +0 +0 +0
00000910 +0 +0 -1 +0 +0 +0 +0 +0 +0 +0 +0 +0 +0 +1 -1
00000920 +0 +0 +0 +0 +0 +1 +0 +0 +0 +0 +0 +0 +0 +0 +0
00000930 +0 +0 +0 +0 +0 +0 +0 +0 +0 +0 +0 +0 +0 +0 +0
00000940 +0 +0 +0 +0 +0 +0 +0 +0 +0 +0 +0 +0 +0 +0 +0
00000950 +0 +0 +0 +0 +0 +0 +0 +0 +0 +0 +0 +0 +0 +0 +0
00000960 +0 +0 +0 +0 +0 +0 +0 +0 +0 +0 +0 +0 +0 +0 +0
00000970 +0 +0 +0 +0 +0 +0 +0 +0 +0 +0 +0 +0 +0 +0 +0
00000980 +0 +0 +0 +0 +0 +1 +0 -1 +0 +0 +0 +0 +0 +0 +0
00000990 +0 +0 +0 +0 +0 +0 +0 +0 +0 +0 +0 +0 +0 +0 +0
000009A0 +0 +0 +0 +0 -2 +0 +0 +0 +0 +0 +0 +0 +0 +0 -1
000009B0 +0 +1 +0 +0 +0 +0 +0 +0 +0 +0 +0 +1 +0 +0 +0
000009C0 +0 +0 +0 +0 +0 +0 +0 +0 +0 +0 +0 +0 -1 +0 +0
000009D0 +0 +0 +0 +0 +0 +0 +0 +0 +0 +0 +0 +0 +0 +0 +0
000009E0 +0 +0 +0 +0 +0 +0 +0 +0 +0 +0 +0 +0 -1 +0 +0
000009F0 +1 +0 +0 +0 +0 +0 +0 +0 +0 +0 +0 -1 +0 +0 +0
00000A00 +0 +0 +0 +0 +0 +0 +0 +0 +0 +0 +0 +0 +0 +0 +0
00000A10 -1 +0 +0 +0 +0 +0 +0 +0 +0 +0 +0 +0 +0 +0 +0
00000A20 +0 +0 +0 +0 +0 +0 +0 +0 +0 +0 +0 +0 +0 -1 +0
00000A30 +0 +0 +0 +0 +0 +0 +0 +0 +0 +0 -1 +1 +0 +0 +0
00000A40 +0 +0 +0 +0 +0 +0 +0 +0 +0 +0 +0 +0 -1 +0 +0

```

```

0000A50 +0 +0 +0 +0 +0 +0 +0 +0 +0 +0 +0 -1 +0 +0 +0 +0
0000A60 +0 +0 +0 +0 +0 +0 +0 +0 +0 +0 +0 +0 +0 +0 +0 +0
0000A70 +0 +0 +0 +0 +0 +0 +0 +0 +0 +0 +0 +0 +0 +0 +0 +0
0000A80 +0 +0 +0 +0 +0 +0 +0 +0 +0 +0 +0 +0 +0 +0 +0 +1
0000A90 +0 +0 +0 +0 +0 +0 +0 +0 +0 +0 +0 +1 +0 +0 +0 +0 +0
0000AA0 +0 +0 +0 +0 +0 +0 +0 +0 +0 +0 +0 +0 +0 +0 +0 +0
0000AB0 +0 +0 +0 +0 +0 +0 +0 +0 +0 +0 +0 +0 +0 +0 +0 +0
0000AC0 +0 +0 +0 +0 +0 +0 +0 +0 +0 +0 +0 +0 +0 +0 +0 +0
0000AD0 +0 +0 +0 +0 +0 +0 +0 +0 +0 +0 +0 +0 +0 +0 +0 +0
0000AE0 +0 +0 +0 +0 +0 +0 +0 +0 +0 +0 +0 +0 +0 +0 +0 +0
0000AF0 +0 +0 +0 +0 +0 +0 +0 +0 +0 +0 +0 +0 +0 +0 +0 +0
0000B00 +0 +0 +0 +0 +0 +0 +0 +0 +0 +0 +0 +0 +0 +0 +0 +0
0000B10 +0 +0 +0 +0 +0 +0 +0 +0 +0 +0 +0 +0 +0 +0 +0 +0
0000B20 +0 +0 +0 +0 +0 +0 +0 +0 +0 +0 +0 +0 +0 +0 +0 +0
0000B30 +0 +0 +0 +0 +0 +0 +0 +0 +0 +0 -1 +0 +0 +0 +0 +0
0000B40 +0 +0 +0 +0 +0 +0 +0 +0 +0 +0 +0 +0 +0 +1 +0 +0
0000B50 +0 +0 +0 +0 +0 +0 +0 +0 +0 +0 +0 +0 +0 +0 +0 +0
0000B60 +0 +0 +0 +0 +0 +0 +0 +0 +0 +0 +0 +0 +0 +0 +0 +0
0000B70 +0 +0 +0 +0 +0 +0 +0 +0 -1 +0 +0 +0 +0 +0 +0 +0
0000B80 +0 +0 +0 +0 +0 +0 +0 +0 +0 +0 +0 +0 +0 +0 +0 +0
0000B90 -1 +0 +0 +0 +0 +0 -1 +0 +0 +0 +0 +0 +0 +0 +0 +0
0000BA0 +0 +0 +0 +0 +0 +0 +0 +0 +0 +0 +0 +0 +0 +0 +0 +0
0000BB0 +0 +0 -1 -1 +1 +0 +0 +0 +0 +0 +0 +0 +0 +0 +0 +0
0000BC0 +0 +0 +0 +0 +0 +0 +0 +0 +0 +0 +0 +0 +0 +0 +0 +0
0000BD0 +0 +0 +0 +0 +0 +0 +0 +0 +0 +0 +0 +0 +0 +0 +0 +0
0000BE0 +0 +0 +0 +0 +0 +0 +0 +0 +0 +0 +0 +0 +0 +0 +0 +0
0000BF0 +0 +0 +0 +0 +0 +0 +0 +0 +0 +0 +0 +0 +0 +0 +0 +0
0000C00 +0 +0 +0 -1 +0 +0 -1 +1 -1 +0 +0 +0 +0 +0 +0 +0
0000C10 +1 +0 +0 -4 +0 +1 +2 +0 -2 +3 +0 +0 +0 +0 +0 +0
0000C20 -1 -1 +3 +13 -2 +1 -2 +2 +7 -15 -1 +0 +0 +1 -1 +0
0000C30 +0 +0 -3 +25 +2 -1 +0 +0 +20 -7 +1 -1 +0 -2 +6 -3
0000C40 +0 +0 -20 +0 -1 -1 -2 -4 +5 +5 -1 +0 -1 +1 -3 -17
0000C50 +0 +1 -5 -7 +2 +0 -3 -3 -13 +12 +0 +0 +1 +0 +7 -2
0000C60 +0 +1 +28 +0 +1 -1 +2 +10 -16 +1 +0 +1 -1 +0 +3 +1
0000C70 +0 -1 +0 -3 -2 +2 +0 +7 -5 -2 +0 +0 +0 -1 -6 +0
0000C80 +0 -2 +1 -3 -1 -1 +0 -10 -2 +4 +0 +0 +1 -1 -2 +0
0000C90 +0 +3 -1 +0 +0 +1 +3 -12 +9 -5 +0 +0 -2 +16 +1 +0
0000CA0 -1 +2 +0 -4 +2 +0 +7 -11 -2 +1 +0 -1 +0 -7 +0 +0
0000CB0 -3 -1 +0 +1 -1 +0 +2 +6 +0 +0 +0 +0 +0 -16 +0 +0
0000CC0 +1 -1 -1 -1 +1 +0 +1 +12 +0 +0 +0 +0 +18 +0 +0 +0
0000CD0 +0 +0 +0 +0 +0 +0 -14 +1 +0 +0 -2 +4 +2 +0 +0 +0
0000CE0 +0 +0 +0 +0 +0 +0 +1 -1 -1 +3 +1 +3 -5 +0 +0 +0
0000CF0 +0 +0 +0 +0 +0 +0 +0 +0 +0 +0 -3 -1 +0 +0 +0 +0
0000D00 +0 +0 +0 +0 +2 +0 -13 -8 +3 +0 +0 +0 +0 +0 +0 +0
0000D10 -1 -1 +0 -3 +3 +27 +12 +19 +20 -21 +3 +0 +0 +0 +0 +0
0000D20 -1 -1 +0 -1 +0 -1 +0 +0 +0 +0 -5 -1 +1 +1 -3 -4
0000D30 +0 +0 -1 +5 -1 +0 +0 -2 +0 -1 -2 +7 +2 +0 +5 +3
0000D40 +0 +0 -1 +0 -1 +0 -2 +1 -1 -1 +1 +1 -1 +0 -2 +7
0000D50 +0 +0 -1 -1 +3 +5 +1 -2 +2 -1 +0 +0 +1 +0 +0 +0
0000D60 +0 -1 +11 -17 -14 -10 -14 +7 -1 +1 +0 +0 +0 +2 -3 +0
0000D70 +0 +0 +3 +2 +0 +0 +9 -5 +0 +11 -2 -1 -1 -2 +5 -1
0000D80 +0 +0 +0 +0 +1 +0 +0 +3 -2 -11 -10 +2 -2 -18 -3 +0
0000D90 +0 +0 -1 -2 +0 +0 -2 +1 +2 +11 +9 +12 +9 -2 +0
0000DA0 +0 +0 +1 -1 -3 +2 +0 -1 +0 +0 +0 +1 -3 -3 +0 +0
0000DB0 +0 -1 +1 +2 +1 -4 -2 +0 +0 +0 +0 +0 +0 +0 +0 +0
0000DC0 +1 -4 -2 -1 -1 +0 +3 +1 +0 +0 +0 +0 +0 -1 +0 +0
0000DD0 -1 +1 +0 +0 +0 +0 +0 +4 +3 +0 -1 +0 +14 -3 +0 +0
0000DE0 -1 +0 +0 +0 +0 +0 +0 +2 -11 -11 -9 -15 -2 +0 +0 +0
0000DF0 +0 +0 +0 +0 +0 +0 +0 +0 +0 +0 -6 +1 +0 +0 +0 +0

```

```

00000E00 +0 +0 +0 +0 +0 +0 -1 +1 +0 +0 +0 +0 +0 +0 +0
00000E10 +0 +0 +0 -6 +1 +0 -1 +2 -4 +3 +0 +0 +0 +0 +0
00000E20 +0 +0 +0 +0 +0 +0 +0 +0 -1 +1 -1 +0 +0 +0 -1 +0
00000E30 +0 +0 -1 -1 +0 +0 +0 +0 +0 -1 -1 +0 +0 +0 -1 -2
00000E40 +0 +0 -2 -2 +0 +0 +0 +0 -1 -2 +1 +0 +0 +0 -2 -3
00000E50 +0 +0 +3 +1 +1 +0 +0 -1 -1 +0 +0 +0 +0 +0 +0 +0
00000E60 +0 -1 +3 +0 +1 -1 -2 +2 +0 +0 +0 +0 +0 +0 -1 +0
00000E70 +0 +0 +1 -1 +0 -1 +2 +1 +2 -1 +0 +0 +0 -1 -1 +0
00000E80 +0 +0 +0 +0 +0 +0 +0 +0 +1 +0 +0 +1 +0 -4 +0 +0
00000E90 +0 +0 +0 +0 +0 +0 +0 +0 -1 +1 +0 +0 +1 +0 +0 +0
00000EA0 +0 +0 +0 +0 +0 +0 +0 +0 -1 +0 +0 +0 +0 +0 +0 +0
00000EB0 -1 +0 +1 +0 +0 +0 +0 +0 +0 +0 +0 +0 +0 +0 +0 +0
00000EC0 +1 +0 +0 +0 +0 +0 -1 +0 +0 +0 +0 +0 +1 +0 +0 +0
00000ED0 +0 +0 +0 +0 +0 +0 +0 +2 +0 +0 +0 -1 -4 +0 +0 +0
00000EE0 +0 +0 +0 +0 +0 +0 +0 +0 +0 +1 +0 -1 +0 +0 +0 +0
00000EF0 +0 +0 +0 +0 +0 +0 +0 +0 +0 +0 +1 +0 +0 +0 +0 +0
00000F00 +0 +13 +4 +5 -8 -2 +0 +1 -1 -43 -7 -3 -4 +1 -1 +1
00000F10 +5 +22 -1 -1 -54 -2 -2 -4 -4 +52 -5 +17 +7 +1 -3 -33
00000F20 -4 -25 +1 +15 +3 +2 +2 -11 +4 -14 +5 -34 +6 -1 +35 +6
00000F30 +11 +4 -2 -5 -4 -7 -21 +1 -2 +0 +1 -6 +1 +3 -11 +0
00000F40 -2 +6 -45 +14 -45 +4 -1 +1 -3 +1 +1 -7 -7 +5 -19 -4
00000F50 +2 -4 +8 +4 -1 +3 +0 +0 +2 -15 -27 -36 -2 +5 -1 +14
00000F60 +2 -5 +7 +0 +8 -39 -41 +6 +1 +4 -12 -6 +0 -2 -2 -1
00000F70 -4 -5 -3 +6 +14 -2 +22 -5 -2 -1 +0 +5 -33 -51 -15 +2
00000F80 +0 +14 -1 +8 -5 -1 +0 +0 -1 -2 -5 -5 -10 -5 -3 +2
00000F90 +2 +5 +5 -4 -8 -1 +0 -3 +2 -13 +5 -14 +15 -1 -1 -12
00000FA0 +1 -1 +2 -3 +15 -1 +3 -3 +1 +5 -4 -2 +0 +2 +6 +2
00000FB0 -4 +0 +2 +15 +0 -5 -12 +0 +0 +0 +0 +12 -3 -10 +4 +0
00000FC0 -68 +7 -44 +27 -28 +42 -3 +3 +1 -23+147 +12 +8-162 +6 +3
00000FD0 +10 -12+147 -60 -13 -24 -1 +1 -44 +40 +33 -24 -22 +48 -14 -22
00000FE0 -38 -3 -1 +61 -68 +60 -4 -37 +1 -18 +2 +29 +29 +8 +18 -74
00000FF0 +10 +5 -17 -22+108 -16 +33-124 +22 -7 +0 -4 +48 +26 -46 -33

```

4.2.4.3 Inverse Quantization/DWT

The following sections present the three-level inverse DWT of the Y component data. The inverse DWT process follows the steps shown in the figure illustrating three-level DWT decomposition in section [3.1.8.1.4](#), in reverse order. The inverse DWT steps for the Cb and Cr components are the same as for the Y component, so the intermediate data dumps for these two components have been omitted, but their final reconstructed data is presented in sections [4.2.4.4](#) and [4.2.4.5](#).

4.2.4.3.1 Level 3 Sub-bands

The following are annotated dumps of the four level 3 de-quantized sub-bands (LL3, LH3, HL3, and HH3). The LL3 sub-band first gives inverse differential encoding before being de-quantized (section [3.1.8.1.6](#)). The level 3 sub-bands have dimensions of 8x8.

All the coefficients are displayed in 11.5 fixed-point representation.

4.2.4.3.1.1 LL3

The following is a dump of the LL3 sub-band, as shown in the figure illustrating three-level DWT decomposition in section [3.1.8.1.4](#).

```

00000000      -32          +0          -32          -480          -384          -384          -608          -736
00000008      +864         +448         +96         +1184         +352          -384          -480          -512

```

00000010	+928	+800	+1472	+3296	+2752	+1376	+832	+352
00000018	+1216	+992	+1792	+2752	+2016	+4096	+3680	+864
00000020	+2304	-992	+1728	+4000	+288	+3104	+2144	+320
00000028	+2144	-1088	+1920	+2720	+3264	+3424	+3616	+192
00000030	+672	-320	+320	-512	+4032	+3456	+2720	-320
00000038	+1888	+1664	+1248	+960	+1120	+1696	+480	-96

4.2.4.3.1.2 HL3

The following is a dump of the HL3 sub-band, as shown in the figure illustrating three-level DWT decomposition in section [3.1.8.1.4](#).

00000000	+0	+0	-64	-64	+32	+0	-32	-64
00000008	+0	-32	+256	+192	+96	+0	-32	-192
00000010	+0	+128	+160	-416	-1696	-96	-64	+0
00000018	-64	-480	-224	+800	+256	+96	+224	-800
00000020	+832	-384	+160	+640	+192	+224	-160	-416
00000028	+64	-64	+160	-1728	+320	-64	+960	+96
00000030	-1472	+352	-288	-32	-64	+32	-576	-64
00000038	+256	-96	+96	-160	-128	-32	-160	-64

4.2.4.3.1.3 LH3

The following is a dump of the LH3 sub-band, as shown in the figure illustrating three-level DWT decomposition in section [3.1.8.1.4](#).

00000000	-96	+0	+32	-320	-96	+32	-32	+32
00000008	-160	-32	-96	+96	+224	-448	-416	+320
00000010	+0	-32	+352	+64	+160	+64	+384	+0
00000018	-256	+768	-672	-1568	-128	+320	+288	+992
00000020	-32	+160	+320	+32	+416	-1824	-1664	+288
00000028	+384	-192	-576	+160	+32	-96	-128	-32
00000030	+416	+672	+256	+352	+96	+224	+224	-64
00000038	-96	-32	+0	+64	-448	-608	-224	+32

4.2.4.3.1.4 HH3

The following is a dump of the HH3 sub-band, as shown in the figure illustrating three-level DWT decomposition in section [3.1.8.1.4](#).

00000000	-32	-32	-96	-64	+0	+0	-32	-32
00000008	-32	-224	+96	+128	+224	-32	-192	-448
00000010	-32	-224	+96	-384	-512	-64	+64	-32
00000018	-288	+32	+224	-672	+800	-128	-64	-736
00000020	+64	+64	+96	-128	+704	-128	+160	-128
00000028	-64	-64	+128	-224	+0	+0	+96	+64
00000030	+544	-192	+224	+160	+96	+32	-160	+0
00000038	+32	+0	+0	+192	+32	-128	+64	+0

4.2.4.3.1.5 Inverse DWT-X (LL3 - HL3)

The following is a dump of the L2 sub-band, as shown in the figure illustrating three-level DWT decomposition in section [3.1.8.1.4](#).

00000000	-32	-16	+0	+0	+0	-336	-416	-520
00000008	-368	-320	-400	-496	-592	-704	-688	-816
00000010	+864	+664	+464	+160	-16	+984	+960	+968
00000018	+208	+80	-432	-448	-464	-496	-400	-784
00000020	+928	+832	+736	+1288	+1328	+2696	+3424	+2784
00000028	+3808	-352	+2272	+1400	+912	+520	+384	+384
00000030	+1280	+1144	+1264	+744	+2144	+1856	+2464	+3576
00000038	+1488	+3216	+3920	+3912	+3520	+2784	+1152	-448
00000040	+1472	+1792	-1216	-456	+1840	+3040	+3600	+3016
00000048	-128	+1768	+2896	+2952	+2112	+1040	+608	-224
00000050	+2080	+624	-1088	+264	+1872	+3008	+3504	+280
00000058	+3968	+4272	+3296	+3104	+3168	+3336	-336	-144
00000060	+2144	-1752	+240	+968	+288	-608	-352	+1800
00000068	+4080	+3648	+3472	+3296	+2992	+344	+0	-128
00000070	+1632	+2120	+1584	+1224	+1248	+1312	+992	+808
00000078	+1264	+1264	+1776	+1112	+576	-24	+16	-112

4.2.4.3.1.6 Inverse DWT-X (LH3 - HH3)

The following is a dump of the H2 sub-band, as shown in the figure illustrating three-level DWT decomposition in section [3.1.8.1.4](#).

00000000	-64	-80	+32	+0	+96	-264	-240	-280
00000008	-64	-16	+32	+8	-16	-40	+64	+0
00000010	-128	-80	+96	-416	-32	+168	-16	+272
00000018	+48	+200	-544	-488	-304	-216	+640	-256
00000020	+32	+0	+96	-192	+416	+504	+208	-360
00000028	+608	-544	+352	+240	+384	+312	-16	-80
00000030	+32	-112	+896	+112	-800	-624	-1344	-2112
00000038	-192	+1496	-16	-72	+384	+760	+1392	-80
00000040	-96	+128	+96	+296	+240	+336	+48	-168
00000048	+128	+416	-2112	-2152	-1680	-384	+272	+16
00000050	+448	+32	-128	-496	-608	+56	+208	-272
00000058	+144	+24	-96	-136	-176	+48	-112	+16
00000060	-128	+1272	+496	-16	+240	+648	+160	+384
00000068	-32	+256	+160	+288	+288	-168	+16	+16
00000070	-128	-24	-48	-24	+0	-16	-32	+88
00000078	-560	-496	-560	-632	-192	+32	+0	+0

4.2.4.3.1.7 Inverse DWT-Y (L2 - H2)

The following is a dump of the LL2 sub-band, as shown in the figure illustrating three-level DWT decomposition in section [3.1.8.1.4](#).

00000000	+32	+64	-32	+0	-96	-72	-176	-240
00000008	-304	-304	-432	-504	-576	-664	-752	-816
00000010	+368	+244	+248	+184	+120	-48	-24	-194
00000018	-172	-190	-240	-340	-472	-596	-624	-736
00000020	+960	+744	+400	+368	-48	+1032	+1088	+972
00000028	+216	-12	-176	-208	-304	-368	-752	-656

00000030	+712	+648	+712	+148	+480	+2032	+2176	+2444
00000038	+1944	+304	+8	-318	-324	-380	+940	-564
00000040	+976	+872	+640	+1592	+1136	+2360	+3328	+2828
00000048	+3480	-180	+2368	+1524	+872	+472	+72	+552
00000050	+1176	+1036	+896	+804	+2568	+3146	+3596	+3100
00000058	+3596	+192	+3764	+3156	+2772	+1984	+236	-68
00000060	+1248	+1200	+768	+784	+2336	+1916	+3032	+4812
00000068	+1280	+2740	+3752	+3828	+3136	+2248	+464	-368
00000070	+1440	+1268	+1320	+286	+628	+1302	+952	+260
00000078	+208	+4768	+3824	+3802	+3716	+3070	+2904	-440
00000080	+1504	+1784	-1712	-660	+2120	+3184	+4248	+4156
00000088	-96	+812	+3960	+4064	+2760	+852	-224	-192
00000090	+1512	+1420	-1200	+444	+2568	+3670	+3908	+1992
00000098	+2124	+3264	-44	-148	+68	+1410	+224	-144
000000A0	+1904	+544	-1072	+364	+2056	+2812	+3376	+500
000000A8	+3832	+4052	+4400	+4248	+4096	+3504	-416	-160
000000B0	+2840	-866	-764	-198	+48	+1038	+1836	+578
000000B8	+4216	+3828	+3728	+3462	+3164	+2050	-408	-120
000000C0	+1984	-2404	+56	+1224	+472	-960	-536	+1744
000000C8	+4024	+3508	+3440	+3220	+2936	+404	+48	-144
000000D0	+1616	+2090	+1700	+1202	+1280	+1314	+516	+1926
000000D8	+2728	+2958	+3028	+2828	+2308	-112	+60	-100
000000E0	+1760	+1496	+1360	+1244	+1128	+996	+928	+572
000000E8	+1560	+1384	+1976	+1284	+528	+44	+8	-120
000000F0	+1504	+1448	+1264	+1196	+1128	+964	+864	+748
000000F8	+440	+392	+856	+20	+144	+108	+8	-120

4.2.4.3.2 Level 2 Sub-bands

The following are the dumps of the four level 2 de-quantized sub-bands (LL2, LH2, HL2, and HH2). LL2 is reconstructed from level 3 sub-bands. LH2, HL2, and HH2 are generated by de-quantizing the corresponding decoded sub-bands, as shown in sections [4.2.4.2](#) and [4.2.4.2.1](#).

All the coefficients are displayed in 11.5 fixed-point representation.

4.2.4.3.2.1 LL2

The LL2 sub-band is the same as that shown in section [4.2.4.3.1.7](#).

4.2.4.3.2.2 HL2

The following is a dump of the HL2 sub-band, as shown in the figure illustrating three-level DWT decomposition in section [3.1.8.1.4](#).

00000000	+64	+0	+0	+0	+0	+0	+0	+0
00000008	+0	+0	+0	+0	+0	+0	+0	+0
00000010	+64	+0	+0	+64	+0	+0	+64	+0
00000018	+0	+0	+0	+0	+0	-64	+0	+0
00000020	-64	-64	+0	-320	+192	-128	+64	+0
00000028	-64	+0	+0	+0	+0	+64	-256	-64
00000030	+0	+0	+64	-320	-128	+64	+64	+64
00000038	+384	-128	-64	+0	+64	-256	+1344	+384
00000040	+0	+0	-320	-64	+64	+128	+256	+256
00000048	+192	+320	+0	+0	-64	+256	-512	-704
00000050	+0	+0	-128	+512	-64	+0	+192	+64
00000058	-1152	+1024	+64	-64	+128	+0	-256	-256

00000060	+0	+0	-384	+64	-192	-64	+64	+896
00000068	-1472	+64	+0	+64	+0	+64	-192	-64
00000070	+0	+0	+0	-320	-128	+192	-64	+704
00000078	-512	-192	+0	+64	+0	-64	-192	+64
00000080	+0	+896	+64	+0	-64	+0	+0	-960
00000088	-128	+448	+64	-64	+64	-192	-64	-64
00000090	-128	-896	+0	+64	+0	+0	+320	-1152
00000098	+896	-448	-64	-64	-128	+832	+64	-64
000000A0	+192	-896	+64	-128	+128	-64	+704	-1024
000000A8	-128	+128	-64	+64	+0	-576	+0	-64
000000B0	+1216	+64	+64	+64	+0	+128	+128	+512
000000B8	+0	+0	+0	+0	+64	-832	+0	+0
000000C0	-384	-192	-64	+0	-128	-128	+384	+832
000000C8	+0	+0	+0	+64	+576	+64	+0	+0
000000D0	-64	+128	+0	+0	+64	+0	-320	+0
000000D8	+0	-64	+0	+0	+64	+64	+0	+0
000000E0	+0	+0	+0	+0	+0	+0	+64	-128
000000E8	-256	+64	+256	+256	-128	+0	+0	-64
000000F0	+0	+0	+0	+0	+0	+0	+0	+0
000000F8	+64	+0	-256	-64	+0	+0	+0	+0

4.2.4.3.2.3 LH2

The following is a dump of the HL2 sub-band, as shown in the figure illustrating three-level DWT decomposition in section [3.1.8.1.4](#).

00000000	+0	+0	+0	+0	+0	+0	+0	+0
00000008	+0	+0	+0	+0	+0	+0	+0	+0
00000010	-128	-64	+64	+64	-64	-192	+0	-128
00000018	-192	+0	+0	+0	+0	+0	+0	+0
00000020	-128	-128	+0	+64	-64	+128	+0	+0
00000028	+0	+64	-64	+64	+0	+64	-512	-64
00000030	+0	+0	+64	-192	+0	+0	-64	+192
00000038	+0	+0	+64	-192	-192	-192	+192	-256
00000040	+0	+0	+0	+64	+0	+0	+192	-192
00000048	+192	-64	+64	+64	+0	+64	-320	+1280
00000050	+0	+0	+0	-64	+128	+448	-64	+0
00000058	+192	-128	+64	+0	+256	-64	+0	+64
00000060	+0	+64	-192	+128	-576	-768	-1216	+640
00000068	-64	+128	+0	-64	+64	+576	-832	+0
00000070	+0	+64	-256	-832	+0	+0	+1024	-448
00000078	+0	+1024	-192	+64	-128	-64	+128	-64
00000080	+0	+0	+0	+64	+64	+0	+0	+256
00000088	-192	-1088	-896	+128	-256	-896	-64	+0
00000090	-64	+64	+0	-64	+0	+64	+64	-128
00000098	+64	+192	+1088	+832	+960	+576	-128	+0
000000A0	+128	-192	+128	+128	-128	+128	+64	-64
000000A8	+64	+0	+0	-128	+320	+448	-64	+0
000000B0	+64	+256	-448	-896	-448	+128	-128	+0
000000B8	+0	+0	+0	+0	+0	-64	+64	+0
000000C0	-192	+1088	+512	-64	+256	+512	-576	+384
000000C8	+0	+64	+0	+0	+0	+0	+0	+0
000000D0	-64	+64	+0	+0	+0	+0	+0	-128
000000D8	-128	+128	+0	+0	+320	-64	+0	+0
000000E0	-64	+0	+0	+0	+0	+0	+0	+0
000000E8	-320	-256	-128	-384	-64	+0	+0	+0
000000F0	+0	+0	+0	+0	+0	+0	+0	+0

```
000000F8      +0      +0     -448     +64      +0      +0      +0      +0
```

4.2.4.3.2.4 HH2

The following is a dump of the HH2 sub-band, as shown in figure illustrating three-level DWT decomposition in section [3.1.8.1.4](#).

```
00000000      +0      +0      +0      +0      +0      +0      +0      +0
00000008      +0      +0      +0      +0      +0      +0      +0      +0
00000010      +0      +0      +0     +128      +0      +0      +0      +0
00000018      +0      +0      +0      +0      +0      +0      +0      +0
00000020      +0      +0      +0      +0      +0      +0      +0      +0
00000028      +0      +0      +0      +0     -128      +0     -512     -128
00000030      +0      +0      +0      +0      +0      +0     -128     -128
00000038     +128     -128      +0      +0      +0      +0     +256     +256
00000040      +0      +0      +0     +384      +0      +0     +128     +128
00000048     -128     +128      +0      +0      +0      +0     -512    -1024
00000050      +0      +0      +0     -128      +0      +0     -128     -128
00000058     -128      +0      +0      +0      +0      +0      +0      +0
00000060      +0      +0      +0     +128     +128     -128     -384     +384
00000068      +0      +0      +0     -128     +128      +0      +0      +0
00000070      +0     +128     -256      +0      +0     -128     +384     +128
00000078     +256     -128      +0      +0      +0     -256     -128      +0
00000080      +0      +0      +0      +0      +0      +0      +0      +0
00000088     +128      +0     +128     +128      +0     -384      +0      +0
00000090      +0      +0      +0      +0      +0      +0     +128      +0
00000098     -128     +256      +0     -128     +128      +0      +0      +0
000000A0     +128     +128      +0      +0      +0      +0      +0     -128
000000A8      +0      +0      +0     -128      +0     -256      +0      +0
000000B0     +256     +256     +128     -128      +0     -128      +0      +0
000000B8      +0      +0      +0      +0      +0      +0      +0      +0
000000C0     -256     +256      +0      +0     +128     -256     +128     -128
000000C8     -128      +0      +0      +0      +0      +0      +0      +0
000000D0      +0      +0      +0      +0      +0      +0     +128      +0
000000D8      +0      +0      +0     -128     -256      +0      +0      +0
000000E0      +0      +0      +0      +0      +0      +0      +0      +0
000000E8     +128     +128     -128     -128      +0      +0      +0      +0
000000F0      +0      +0      +0      +0      +0      +0      +0      +0
000000F8      +0      +0     +128      +0      +0      +0      +0      +0
```

4.2.4.3.2.5 Inverse DWT-X (LL2 – HL2)

The following is a dump of the L1 sub-band, as shown in the figure illustrating three-level DWT decomposition in section [3.1.8.1.4](#).

```
00000000     -32     +128     +32      +0     -32     -16      +0     -48
00000008     -96     -84     -72     -124    -176    -208    -240    -272
00000010    -304    -304    -304    -368    -432    -468    -504    -540
00000018    -576    -620    -664    -708    -752    -784    -816    -816
00000020     +304     +386     +212     +230     +248     +200     +152     +248
00000028     +88      +20      -48      -52      -56      -13     -226     -199
00000030     -172     -181     -190     -215     -240     -290     -340     -406
00000038     -472     -518     -564     -706     -592     -664     -736     -736
00000040    +1024     +788     +808     +492     +432     +480     +528     -368
00000048      +16     +892    +1000     +804    +1120    +1158     +940     +594
```

00000050	+248	+6	+20	-78	-176	-192	-208	-256
00000058	-304	-352	-400	-400	-656	-1088	-496	-624
00000060	+712	+680	+648	+664	+680	+606	+276	-150
00000068	+704	+1128	+2064	+2216	+2112	+2374	+2380	+2178
00000070	+1720	+1716	+176	-116	+104	-219	-286	-321
00000078	-356	-192	-284	-456	+396	+2172	-1428	-660
00000080	+976	+924	+872	+836	+800	+652	+1784	+1332
00000088	+1136	+1828	+2264	+2956	+3136	+3366	+2572	+3426
00000090	+3256	+1794	-436	+1526	+2208	+1866	+1524	+1214
00000098	+904	+512	+376	+800	+200	-344	+1160	-248
000000A0	+1176	+1106	+1036	+998	+960	+530	+612	+2502
000000A8	+2344	+2633	+3178	+3339	+3500	+3620	+2972	+3684
000000B0	+4140	-106	+256	+3786	+3220	+3316	+3156	+2820
000000B8	+2740	+2586	+1920	+1142	+364	-236	+188	-324
000000C0	+1248	+1224	+1200	+1080	+960	+184	+944	+1800
000000C8	+2400	+1838	+2044	+2410	+3032	+3810	+4332	+4742
000000D0	+1568	-438	+3444	+3710	+3720	+3758	+3796	+3578
000000D8	+3104	+2660	+2216	+1500	+528	-240	-240	-368
000000E0	+1440	+1354	+1268	+1294	+1320	+883	+446	+9
000000E8	+852	+805	+1270	+1463	+888	+286	-60	+1434
000000F0	+112	+1592	+5120	+4136	+3920	+3845	+3770	+3855
000000F8	+3684	+3393	+3102	+2939	+3032	+944	-376	-248
00000100	+1504	+1420	+1336	+1364	-2192	-1314	-692	+730
00000108	+2152	+2556	+3216	+3732	+4248	+4442	+4636	+622
00000110	+448	+294	+652	+3074	+3704	+4012	+4064	+3284
00000118	+2760	+1966	+916	+26	-96	-240	-128	-256
00000120	+1640	+1530	+1932	-1202	-752	-170	+412	+1602
00000128	+2536	+3103	+3670	+3709	+3748	+3718	+2408	+26
00000130	+2252	+4438	+3040	+730	+212	-64	-84	-88
00000138	+164	+355	+1058	+2081	-224	-56	-144	-272
00000140	+1712	+1688	+896	-1672	-656	-2	+396	+970
00000148	+2056	+2674	+2780	+2790	+3056	+3266	+660	+486
00000150	+4408	+3974	+4052	+4466	+4368	+4180	+4248	+4284
00000158	+4064	+3928	+3792	+680	-128	-128	-128	-256
00000160	+1624	+2491	-1506	-1039	-828	-417	-262	+5
00000168	+16	+495	+974	+1597	+1708	+1239	+258	+3133
00000170	+3960	+3894	+3828	+3778	+3728	+3595	+3462	+3297
00000178	+3132	+2911	+2434	-443	+8	-56	-120	-120
00000180	+2368	-642	-2116	-1350	+184	+592	+1256	+896
00000188	+536	-404	-832	-1004	-664	+1004	+1136	+4036
00000190	+3608	+3558	+3508	+3474	+3440	+3314	+3188	+3030
00000198	+2616	+2502	+84	+178	+16	-64	-144	-144
000001A0	+1680	+1741	+2058	+2103	+1636	+1419	+1202	+1225
000001A8	+1248	+1393	+1282	+979	+676	+741	+2086	+2407
000001B0	+2728	+2859	+2990	+2897	+3060	+2944	+2828	+2552
000001B8	+2276	+1178	-176	+54	+28	-36	-100	-100
000001C0	+1760	+1628	+1496	+1428	+1360	+1302	+1244	+1186
000001C8	+1128	+1062	+996	+946	+896	+878	+604	+922
000001D0	+1752	+1104	+1480	+1776	+1816	+1934	+1028	+1258
000001D8	+464	+30	+108	+58	+8	-40	-88	-216
000001E0	+1504	+1476	+1448	+1356	+1264	+1230	+1196	+1162
000001E8	+1128	+1046	+964	+914	+864	+806	+748	+578
000001F0	+408	+512	+360	+672	+984	+70	+180	+50
000001F8	+176	+142	+108	+58	+8	-56	-120	-120

4.2.4.3.2.6 Inverse DWT-X (LH2 - HH2)

The following is a dump of the H1 sub-band, as shown in the figure illustrating three-level DWT decomposition in section [3.1.8.1.4](#).

00000000	+0	+0	+0	+0	+0	+0	+0	+0
00000008	+0	+0	+0	+0	+0	+0	+0	+0
00000010	+0	+0	+0	+0	+0	+0	+0	+0
00000018	+0	+0	+0	+0	+0	+0	+0	+0
00000020	-128	-96	-64	+0	+64	+32	+0	+192
00000028	-128	-160	-192	-96	+0	-64	-128	-160
00000030	-192	-96	+0	+0	+0	+0	+0	+0
00000038	+0	+0	+0	+0	+0	+0	+0	+0
00000040	-128	-128	-128	-64	+0	+32	+64	+0
00000048	-64	+32	+128	+64	+0	+0	+0	+0
00000050	+0	+32	+64	+0	-64	+0	+64	+64
00000058	+64	-160	+128	-64	-256	-1024	+256	+0
00000060	+0	+0	+0	+32	+64	-64	-192	-96
00000068	+0	+0	+0	+0	+0	-96	+320	-96
00000070	+0	+256	+0	-192	+128	-32	-192	-192
00000078	-192	-192	-192	-64	+64	+288	-512	+0
00000080	+0	+0	+0	+0	+0	-64	-128	+608
00000088	-192	-96	+0	+64	+128	+160	-320	+192
00000090	+192	-192	-64	+224	+0	+32	+64	+32
00000098	+0	+32	+64	+0	-64	-32	+2048	+0
000000A0	+0	+0	+0	+0	+0	+0	+0	-160
000000A8	+192	+320	+448	+224	+0	-192	+128	-32
000000B0	+320	-128	-64	+0	+64	+32	+0	+128
000000B8	+256	+96	-64	-32	+0	+32	+64	+64
000000C0	+0	+32	+64	-64	-192	-64	+64	-64
000000C8	-704	-480	-768	-1120	-960	-928	+640	+960
000000D0	-256	-64	+128	+64	+0	+0	+0	-224
000000D8	+64	+544	+512	-160	-832	-416	+0	+0
000000E0	+0	+0	+0	+160	-192	-960	-704	-352
000000E8	+0	+32	+64	+224	+896	+864	-704	-192
000000F0	-192	+896	+960	+160	-128	-32	+64	-32
000000F8	-128	-32	+64	-320	+320	-96	+0	+0
00000100	+0	+0	+0	+0	+0	+32	+64	+64
00000108	+64	+32	+0	+0	+0	+128	+256	+0
00000110	-256	-448	-1152	-1056	-960	-224	+0	+96
00000118	-320	-512	-704	-1056	+128	+64	+0	+0
00000120	-64	+0	+64	+32	+0	-32	-64	-32
00000128	+0	+32	+64	+32	+0	+160	-192	-32
00000130	+128	-128	+128	+1056	+960	+928	+896	+672
00000138	+960	+992	+512	+192	-128	-64	+0	+0
00000140	+0	+96	-320	+128	+64	+96	+128	+0
00000148	-128	+0	+128	+96	+64	+32	+0	-192
00000150	+128	+64	+0	+0	+0	-32	-64	-96
00000158	+384	+480	+576	-192	+64	+32	+0	+0
00000160	-192	+416	+0	+192	-640	-512	-896	-896
00000168	-384	-96	+192	-192	-64	-32	+0	+0
00000170	+0	+0	+0	+0	+0	+0	+0	+0
00000178	+0	-32	-64	+0	+64	+32	+0	+0
00000180	+64	+64	+1088	+1248	+384	+160	-64	+64
00000188	+192	+640	+576	-480	-512	+192	+384	+0
00000190	+128	-128	+128	+64	+0	+0	+0	+0
00000198	+0	+0	+0	+0	+0	+0	+0	+0
000001A0	-64	+0	+64	+32	+0	+0	+0	+0
000001A8	+0	+0	+0	-32	-64	+128	-192	-160

000001B0	-128	+0	+128	+64	+0	+32	+64	+32
000001B8	+512	-224	+64	+32	+0	+0	+0	+0
000001C0	-64	-32	+0	+0	+0	+0	+0	+0
000001C8	+0	+0	+0	+0	+0	+0	+0	-192
000001D0	-384	-128	-384	+0	-128	-448	-256	-384
000001D8	+0	+0	+0	+0	+0	+0	+0	+0
000001E0	+0	+0	+0	+0	+0	+0	+0	+0
000001E8	+0	+0	+0	+0	+0	+0	+0	+0
000001F0	+0	+0	+0	-256	-512	+0	+0	+0
000001F8	+0	+0	+0	+0	+0	+0	+0	+0

4.2.4.3.2.7 Inverse DWT-Y (L1 - H1)

The following is a dump of the LL1 sub-band, as shown in the figure illustrating three-level DWT decomposition in section [3.1.8.1.4](#).

00000000	-32	+128	+32	+0	-32	-16	+0	-48
00000008	-96	-84	-72	-124	-176	-208	-240	-272
00000010	-304	-304	-304	-368	-432	-468	-504	-540
00000018	-576	-620	-664	-708	-752	-784	-816	-816
00000020	+168	+281	+138	+115	+92	+84	+76	+52
00000028	+28	+8	-12	-64	-116	-95	-201	-195
00000030	-190	-218	-247	-291	-336	-379	-422	-473
00000038	-524	-569	-614	-707	-672	-724	-776	-776
00000040	+368	+434	+244	+230	+216	+184	+152	+152
00000048	+152	+100	+48	-4	-56	+19	-162	-119
00000050	-76	-133	-190	-215	-240	-290	-340	-406
00000058	-472	-518	-564	-706	-592	-664	-736	-736
00000060	+504	+475	+446	+377	+436	+380	+324	+228
00000068	-124	+208	+156	+216	+532	+476	+165	-42
00000070	-250	-239	-101	-146	-192	-241	-290	-347
00000078	-404	-395	-514	-537	-560	-620	-680	-680
00000080	+1152	+900	+904	+524	+400	+448	+496	+464
00000088	+112	+956	+1032	+820	+1120	+1190	+1004	+674
00000090	+344	+38	-12	-78	-144	-192	-240	-288
00000098	-336	-272	-464	-368	-528	-576	-624	-624
000000A0	+708	+566	+552	+474	+524	+599	+546	-283
000000A8	+296	+1098	+1772	+1630	+1616	+1806	+1612	+1450
000000B0	+1032	+869	+194	-49	-164	-197	-103	-144
000000B8	-186	-464	-102	-508	-530	-1066	-450	-642
000000C0	+776	+744	+712	+680	+648	+622	+340	-102
000000C8	+736	+1112	+2000	+2184	+2112	+2422	+2220	+2226
000000D0	+1720	+1572	+144	-20	+72	-203	-222	-257
000000D8	-292	-16	-252	-392	+492	+2540	-1300	-660
000000E0	+876	+834	+792	+814	+836	+541	+758	+295
000000E8	+984	+1494	+2132	+2554	+2592	+2686	+3036	+2610
000000F0	+2440	+2179	-130	+361	+1364	+768	+299	+135
000000F8	-30	-96	-290	+92	+474	+1610	-1478	-454
00000100	+976	+924	+872	+820	+768	+716	+1944	+1076
00000108	+1232	+1876	+2264	+2924	+3072	+3334	+2572	+3378
00000110	+3160	+1762	-404	+1510	+2144	+1866	+1588	+1294
00000118	+1000	+592	+440	+832	+200	-472	+392	-248
00000120	+1076	+1015	+954	+909	+864	+511	+1054	+2893
00000128	+1404	+2006	+2609	+3187	+3510	+3805	+2180	+3875
00000130	+3906	+524	-170	+3040	+2666	+2639	+2484	+2081
00000138	+1806	+1621	+1308	+995	+170	-418	+3858	-302
00000140	+1176	+1106	+1036	+998	+960	+562	+676	+2278

00000148	+2344	+2521	+2954	+3195	+3436	+3636	+3068	+3604
00000150	+3884	+54	+320	+3674	+3188	+3284	+3124	+2740
00000158	+2612	+2522	+1920	+1158	+396	-236	-868	-356
00000160	+1212	+1157	+1102	+1055	+1008	+389	+794	+1775
00000168	+2884	+2859	+3475	+3474	+3474	+3619	+3764	+3877
00000170	+3350	-400	+1738	+3676	+3566	+3577	+3460	+3439
00000178	+3290	+2623	+1828	+1313	+670	-78	-442	-250
00000180	+1248	+1208	+1168	+1112	+1056	+216	+912	+1912
00000188	+2656	+1918	+2204	+2858	+3512	+4370	+3948	+4278
00000190	+1536	-342	+3412	+3678	+3688	+3742	+3796	+3626
00000198	+2944	+2340	+1992	+1596	+944	-48	-272	-400
000001A0	+1344	+1337	+1330	+1051	+900	+677	+967	+936
000001A8	+522	+513	+377	+144	+296	+488	+3240	+4584
000001B0	+424	+289	+4250	+3979	+3836	+3801	+3767	+3356
000001B8	+3458	+3826	+3427	+2067	+452	-256	-324	-324
000001C0	+1440	+1338	+1236	+1246	+1512	+1395	+766	+217
000001C8	+1204	+1029	+1622	+1911	+920	+318	-28	+1050
000001D0	+336	+1176	+4576	+4024	+3984	+3861	+3738	+3983
000001D8	+3716	+3137	+2814	+3179	+3288	+1200	-376	-248
000001E0	+1472	+1379	+1286	+1585	-676	-1648	-1211	-159
000001E8	+1662	+1840	+2531	+3213	+4152	+3860	+1008	+500
000001F0	+120	+2415	+4582	+4093	+3860	+3936	+4013	+3553
000001F8	+3094	+2623	+2153	+1306	+2124	+296	-252	-252
00000200	+1504	+1420	+1336	+1284	-2096	-850	-372	+874
00000208	+2120	+2524	+3184	+3620	+3800	+3946	+4860	+718
00000210	+672	+70	+748	+3522	+4248	+4140	+4032	+3252
00000218	+2984	+2238	+1236	+714	-320	-224	-128	-256
00000220	+1588	+1475	+1618	+33	-1424	-446	+148	+1358
00000228	+2440	+2861	+3411	+3656	+3774	+4016	+4130	+380
00000230	+982	+1502	-154	+14	+310	+1414	+1750	+1582
00000238	+774	+152	-213	-499	-16	-12	-136	-264
00000240	+1672	+1530	+1900	-1218	-752	-170	+412	+1586
00000248	+2504	+3071	+3638	+3693	+3748	+3574	+2376	+42
00000250	+2316	+4726	+3552	+730	+212	-416	-532	-472
00000258	-156	+115	+1154	+2513	-224	-56	-144	-272
00000260	+1580	+1585	+1590	-1421	-720	-166	+260	+1222
00000268	+2312	+2928	+3289	+3273	+3386	+3692	+1182	+256
00000270	+3554	+4110	+4026	+4446	+3970	+3514	+3442	+3106
00000278	+3538	+3637	+3225	+1980	-416	-212	-136	-264
00000280	+1744	+1640	+1024	-1752	-688	-34	+364	+986
00000288	+2120	+2658	+2684	+2726	+3024	+3170	+756	+598
00000290	+4280	+4006	+3988	+3938	+3888	+3732	+3832	+3996
00000298	+3392	+3192	+3248	+680	-96	-112	-128	-256
000002A0	+1732	+2129	-801	-1219	-486	+71	+499	+719
000002A8	+940	+1600	+2005	+2377	+2494	+2268	+507	+1529
000002B0	+4344	+4062	+3908	+3858	+3808	+3607	+3535	+3478
000002B8	+3934	+3899	+3865	-217	+52	-36	-124	-188
000002C0	+1720	+2235	-1346	-1199	-540	-209	+122	+453
000002C8	+272	+543	+814	+1645	+1708	+1239	+258	+3229
000002D0	+3896	+3862	+3828	+3778	+3728	+3611	+3494	+3345
000002D8	+2940	+2687	+2178	-347	-56	-88	-120	-120
000002E0	+1692	+1508	-2003	-1250	-1394	-744	-863	-910
000002E8	-316	-259	+183	+104	+538	+1017	+601	+3632
000002F0	+3720	+3742	+3636	+3610	+3584	+3462	+3341	+3187
000002F8	+2778	+2538	+1019	-84	+92	-20	-132	-132
00000300	+2432	-882	-2660	-2070	+312	+768	+1736	+1312
00000308	+632	-676	-1216	-668	-376	+924	+944	+4036
00000310	+3544	+3622	+3444	+3442	+3440	+3314	+3188	+3030
00000318	+2616	+2518	+116	+178	-16	-80	-144	-144

00000320	+2184	+541	+1587	+2192	+1646	+1373	+1357	+1380
00000328	+1276	+1478	+1041	-677	-730	+1136	+2235	+3261
00000330	+3392	+3016	+3409	+3265	+3250	+3121	+2992	+2783
00000338	+2318	+1904	-46	+108	+6	-58	-122	-122
00000340	+1680	+1709	+1482	+1463	+1444	+1339	+1234	+1193
00000348	+1152	+1073	+994	+1235	+964	+581	+1990	+2487
00000350	+2728	+2923	+2862	+2833	+3060	+2928	+2796	+2536
00000358	+2020	+1290	-208	+38	+28	-36	-100	-100
00000360	+1624	+1676	+1601	+1501	+1402	+1320	+1239	+1189
00000368	+1140	+1067	+995	+1034	+818	+953	+961	+1472
00000370	+2112	+2045	+2491	+2416	+2470	+2599	+2088	+2049
00000378	+2138	+268	+62	+104	+18	-38	-94	-158
00000380	+1824	+1644	+1464	+1412	+1360	+1302	+1244	+1186
00000388	+1128	+1062	+996	+962	+928	+814	+700	+1098
00000390	+2008	+1168	+1608	+1744	+1880	+2142	+1124	+1434
00000398	+208	+142	+76	+42	+8	-40	-88	-216
000003A0	+1552	+1504	+1456	+1384	+1312	+1266	+1220	+1174
000003A8	+1128	+1054	+980	+938	+896	+810	+724	+502
000003B0	+536	+616	+312	+1272	+1336	+322	+204	+70
000003B8	+192	+142	+92	+50	+8	-48	-104	-168
000003C0	+1536	+1492	+1448	+1356	+1264	+1230	+1196	+1162
000003C8	+1128	+1046	+964	+914	+864	+806	+748	+674
000003D0	+600	+576	+552	+800	+1304	+294	+308	+242
000003D8	+176	+142	+108	+58	+8	-56	-120	-120
000003E0	+1536	+1492	+1448	+1356	+1264	+1230	+1196	+1162
000003E8	+1128	+1046	+964	+914	+864	+806	+748	+674
000003F0	+600	+576	+552	+288	+280	+294	+308	+242
000003F8	+176	+142	+108	+58	+8	-56	-120	-120
00000400	+0	+128	+0	+0	+0	+0	+0	+0
00000408	+0	+0	+0	+0	+0	+0	+0	+0

4.2.4.3.3 Level 1 Sub-bands

The following are the dumps of the four level 1 de-quantized sub-bands (LL1, LH1, HL1, and HH1). LL1 is reconstructed from level 2 sub-bands. LH1, HL1 and HH1 are generated by de-quantizing the corresponding decoded sub-bands, as shown in sections [4.2.4.2](#) and [4.2.4.2.1](#).

All the coefficients are displayed in 11.5 fixed-point representation.

4.2.4.3.3.1 LL1

The LL1 sub-band is the same as that shown in section [4.2.4.3.2.7](#).

4.2.4.3.3.2 HL1

The following is a dump of the HL1 sub-band, as shown in the figure illustrating three-level DWT decomposition in section [3.1.8.1.4](#).

00000000	+0	+128	+0	+0	+0	+0	+0	+0
00000008	+0	+0	+0	+0	+0	+0	+0	+0
00000010	+0	+0	+0	+0	+0	+0	+0	+0
00000018	+0	+0	+0	+0	+0	+0	+0	+0
00000020	+0	+0	+0	+0	+0	+0	+0	+0
00000028	+0	+0	+0	+0	+0	+0	+0	+0
00000030	+0	+0	+0	+0	+0	+0	+0	+0
00000038	+0	+0	+0	+0	+0	+0	+0	+0

00000040	+0	+0	+0	+0	+0	+0	+0	+0
00000048	+0	+0	+0	+0	+0	+0	+0	+0
00000050	+0	+0	+0	+0	+0	+0	+0	+0
00000058	+0	+0	+0	+0	+0	+0	+0	+0
00000060	+128	+0	+256	+0	+0	+0	+0	-128
00000068	+0	+0	+0	+0	+0	+0	+0	+0
00000070	+0	+0	+0	+0	+0	+0	+0	+0
00000078	+0	+0	+0	+128	+0	+0	+0	+0
00000080	+0	+0	+128	+0	+0	+0	+256	+0
00000088	+0	+0	+0	+0	+0	+0	+0	+0
00000090	+0	+0	+0	+0	+0	+0	+0	+0
00000098	+0	+0	+0	+0	+0	+0	+0	+0
000000A0	+0	+0	+0	+0	+0	+0	+0	+0
000000A8	+0	+128	+0	+0	+0	+0	+0	+0
000000B0	+0	+0	-128	+0	+0	+0	+0	+0
000000B8	+0	+0	+0	+0	-128	+128	+0	+0
000000C0	+0	+0	+0	+0	+0	+0	-384	+0
000000C8	+0	+0	+128	+0	+0	+0	+0	+0
000000D0	+0	+256	+0	+0	+0	+0	+0	+0
000000D8	+0	+128	+0	-256	+512	-640	-128	+0
000000E0	+0	+0	+0	+0	+0	-128	-384	+0
000000E8	+0	+0	+0	+0	+0	+0	+0	+0
000000F0	+0	-384	+0	+384	+0	+0	+0	+0
000000F8	+0	+0	-128	+512	+512	-640	-128	+0
00000100	+0	+0	+0	+0	+0	-256	+640	+0
00000108	+0	+0	+0	+0	+0	+256	+128	+0
00000110	+256	-640	-512	+128	+0	+0	+0	+0
00000118	+0	+0	+128	+384	-128	+640	+0	-128
00000120	+0	+0	+0	+0	+0	-256	-256	-384
00000128	+0	+0	+0	+0	+0	+384	+0	+0
00000130	+896	+0	-512	+0	+0	+0	+0	+0
00000138	+0	+0	+0	-128	+0	-128	+256	-128
00000140	+0	+0	+0	+0	+0	-384	+128	+640
00000148	+0	+0	+0	+0	+0	+0	-128	+0
00000150	+0	+128	+896	+0	+0	+0	+0	+0
00000158	+0	+0	+0	+0	+0	-128	+0	+0
00000160	+0	+0	+0	+0	+256	+0	+0	+0
00000168	-256	+0	+0	+0	+0	+0	+128	+0
00000170	-1152	-384	+640	+0	+0	+0	+0	+0
00000178	+0	+0	+0	+0	+0	-128	+0	+0
00000180	+0	+0	+0	+0	+0	+0	-128	-128
00000188	-128	+0	+0	+0	+0	+0	+0	+768
00000190	-256	-1024	-128	+0	+0	+0	+0	+0
00000198	+0	+0	+0	+0	+0	-128	+0	+0
000001A0	+0	+0	+0	+0	-384	+0	+0	+0
000001A8	+0	+0	+0	-128	+0	-128	+0	+640
000001B0	+256	+384	+0	+0	+0	+0	+0	+0
000001B8	+0	+0	+128	+0	+256	+0	+0	+0
000001C0	+0	+0	+0	-128	+128	+0	+0	-128
000001C8	+256	+0	+0	+128	+0	+0	-128	+0
000001D0	-128	+896	+0	+0	+0	+0	+0	+0
000001D8	+0	+0	+0	+0	-384	-256	+0	+0
000001E0	+0	+0	+0	+384	-128	+0	-128	+0
000001E8	+128	+0	+0	+0	+128	+256	-128	+0
000001F0	-640	+128	+0	+0	+0	+0	+0	+0
000001F8	+0	+0	+0	-384	-512	+0	+0	+0
00000200	+0	+0	-128	-768	+128	+0	-128	+0
00000208	+0	+0	+0	+0	+0	+0	+768	+0
00000210	-128	+0	+128	+0	+0	+128	-128	+0

00000218	+0	+0	+0	+0	+0	+0	+0	+0
00000220	+0	+0	+384	-640	+0	+0	+0	+0
00000228	+0	+0	+0	+0	+0	-128	-128	+128
00000230	+1280	+0	+0	+0	-128	+128	+0	+0
00000238	+0	+0	-128	+128	+0	+0	+0	+0
00000240	+0	+0	+896	+0	+0	+0	+0	+0
00000248	+0	+0	+0	+0	+0	+128	-640	-640
00000250	+384	+0	+0	+0	+0	+0	+0	+0
00000258	+0	-128	+0	-128	+0	+0	+0	+0
00000260	+0	-128	-256	+0	+0	+0	-128	+0
00000268	+0	+0	+0	+0	+0	+384	-128	-896
00000270	+0	+0	+0	+0	+0	+0	+0	+0
00000278	+0	+0	+128	-768	+0	+0	+0	+0
00000280	+0	+0	-1024	+0	+0	+0	+0	+0
00000288	+0	+0	+0	+0	+0	+384	+256	+512
00000290	+0	+0	+0	+0	+0	-128	+0	+0
00000298	+0	+0	+768	-128	+0	+0	+0	+0
000002A0	-128	+896	-128	+0	+0	+0	-128	-128
000002A8	+0	+0	+0	+0	+0	-384	-128	+768
000002B0	+0	+0	+0	+0	+0	+0	+0	+0
000002B8	+0	+0	+384	+128	+0	+0	+0	+0
000002C0	+0	+512	+128	+256	-256	-256	+0	-128
000002C8	+0	+0	+0	+0	+128	-128	-896	+128
000002D0	+0	+0	+0	+0	+0	+0	+0	+0
000002D8	+0	+0	-768	+0	+0	+0	+0	+0
000002E0	-128	-1280	+384	+128	+256	+0	-256	+128
000002E8	+128	+0	+0	+0	+0	+0	-128	+0
000002F0	+0	+0	-128	+0	+0	+0	+0	+0
000002F8	+0	+384	-256	+0	+0	+0	+0	+0
00000300	+768	-1024	-256	+0	-256	+128	+0	+0
00000308	-128	-128	-128	+128	+128	+128	+768	+0
00000310	+0	+0	+0	+0	+0	+0	+0	+0
00000318	+0	+512	+128	+0	+0	+0	+0	+0
00000320	+384	+256	+0	+128	+0	+0	+128	+128
00000328	+0	+0	+128	-256	+640	-384	+256	+0
00000330	+0	+0	+0	+128	+0	+0	+0	+0
00000338	+0	-256	+0	+0	+0	+0	+0	+0
00000340	+0	+0	+0	+0	+0	+0	+0	+0
00000348	+0	+0	-128	+0	+0	-384	+0	+128
00000350	+0	+0	+128	+128	+0	+0	+0	+0
00000358	+0	-512	+0	+0	+0	+0	+0	+0
00000360	+0	+0	+0	+0	+0	+0	+0	+0
00000368	+0	+0	+0	+0	+0	+0	-128	+128
00000370	-128	-128	+0	+0	+128	+0	+0	+0
00000378	+384	+0	+0	+0	+0	+0	+0	+0
00000380	+0	+0	+0	+0	+0	+0	+0	+0
00000388	+0	+0	+0	+0	+0	+0	-128	+0
00000390	+0	+0	+128	+128	+128	-256	+0	+128
00000398	+0	+0	+0	+0	+0	+0	+0	+0
000003A0	+0	+0	+0	+0	+0	+0	+0	+0
000003A8	+0	+0	+0	+0	+0	+0	+0	+0
000003B0	-128	+0	-256	+128	+128	+0	+0	+0
000003B8	+0	+0	+0	+0	+0	+0	+0	+0
000003C0	+0	+0	+0	+0	+0	+0	+0	+0
000003C8	+0	+0	+0	+0	+0	+0	+0	+0
000003D0	+0	+0	+0	+384	-128	+0	+0	+0
000003D8	+0	+0	+0	+0	+0	+0	+0	+0
000003E0	+0	+0	+0	+0	+0	+0	+0	+0
000003E8	+0	+0	+0	+0	+0	+0	+0	+0

000003F0	+0	+0	+0	-128	+0	+0	+0	+0
000003F8	+0	+0	+0	+0	+0	+0	+0	+0

4.2.4.3.3.3 LH1

The following is a dump of the LH1 sub-band, as shown in the figure illustrating three-level DWT decomposition in section [3.1.8.1.4](#).

00000000	+0	+0	+0	+0	+0	+0	+0	+0
00000008	+0	+0	+0	+0	+0	+0	+0	+0
00000010	+0	+0	+0	+0	+0	+0	+0	+0
00000018	+0	+0	+0	+0	+0	+0	+0	+0
00000020	+0	+0	+0	+0	+0	+0	+0	+0
00000028	+0	+0	+0	+0	+0	+0	+0	+0
00000030	+0	+0	+0	+0	+0	+0	+0	+0
00000038	+0	+0	+0	+0	+0	+0	+0	+0
00000040	+0	+0	+0	+0	+0	+0	+0	+0
00000048	+128	+0	-128	-128	+0	+0	-128	-128
00000050	+128	+0	+0	+0	+0	+0	+0	+0
00000058	+0	+0	+0	+0	+0	+0	+0	+0
00000060	-128	-128	-128	+0	+0	+0	+0	-128
00000068	+0	+0	+0	+0	+0	+0	+0	+0
00000070	+0	-128	+0	+0	+0	+0	+0	+0
00000078	+0	+0	+0	+0	+0	+0	+0	+0
00000080	-128	-128	-128	+0	+0	+0	+0	+0
00000088	+0	+0	+0	+0	+0	+0	+0	+0
00000090	+0	+0	+0	+0	+0	+0	+0	+0
00000098	+0	+0	+0	+0	+0	+0	+0	+0
000000A0	+0	+0	+0	+0	+0	+0	+0	+0
000000A8	+0	+0	+0	+0	+0	+0	+0	+0
000000B0	+0	+0	+0	+0	-128	+128	+0	+0
000000B8	+0	+0	+0	+0	-256	-1024	+256	+0
000000C0	+0	+0	+0	+0	+0	+0	-128	+0
000000C8	+0	+0	+0	+0	+0	+0	+0	+0
000000D0	+0	+0	+0	+0	+0	+0	-128	+0
000000D8	+0	+128	+0	-256	+512	+512	-128	+0
000000E0	+0	+0	+0	+0	+0	-128	+384	-128
000000E8	+0	+0	+0	+0	+0	+0	+128	+0
000000F0	+0	+128	+0	+0	+0	+0	+0	+0
000000F8	+0	+0	-128	+384	+384	-896	-128	+0
00000100	+0	+0	+0	+0	+0	+0	+0	+128
00000108	+0	+0	+0	+0	+0	+0	+0	+0
00000110	+0	+0	-128	+128	+0	+0	+0	+0
00000118	+0	+0	+0	+128	+0	+0	+768	+384
00000120	+0	+0	+0	+0	+0	+0	+0	+0
00000128	+0	+0	+0	+128	+0	+0	+0	+0
00000130	+128	+0	+0	+0	+0	+0	+0	+0
00000138	+0	+0	+0	+0	+0	+0	-1024	+0
00000140	+0	+0	+0	+0	+0	+0	+0	+0
00000148	+0	+0	+0	+128	-256	-256	+256	-128
00000150	+0	+0	-128	+0	+0	+0	+0	+0
00000158	+0	+0	+0	+0	+0	+0	+0	+0
00000160	+0	+0	+0	+0	+0	-128	+0	+0
00000168	+128	+128	+384	+128	+0	+0	+0	+0
00000170	+0	+0	+0	+0	+0	+0	+0	+128
00000178	+0	+0	+0	+0	+0	+0	+0	+0
00000180	+0	+0	+0	+0	+0	-128	+0	-128

00000188	-640	-384	-512	-768	-768	+896	+128	+128
00000190	-128	+0	+0	+0	+0	+0	+0	+0
00000198	-128	-256	-384	+0	+128	+0	+0	+0
000001A0	+0	+0	+0	+0	+0	+128	+0	+256
000001A8	-128	+0	-256	-384	+128	+128	-1024	+768
000001B0	+0	-128	+128	+0	+0	+0	+0	+128
000001B8	+128	+0	+0	+768	-384	-128	+0	+0
000001C0	+0	+0	+0	-128	+640	+256	-768	-256
000001C8	+0	+0	+0	+256	+896	-768	-128	+0
000001D0	+0	+128	+0	+0	+0	+0	+0	+0
000001D8	+0	+0	-128	-128	+128	+768	+0	+0
000001E0	+0	+0	+0	+0	-256	+128	+0	+0
000001E8	+0	+0	+0	+0	+0	-128	+768	-128
000001F0	+128	-768	+896	+0	+0	+0	+0	+0
000001F8	+0	+0	+0	+128	-128	-128	+0	+0
00000200	+0	+0	+0	+128	+0	+0	+0	+0
00000208	+0	+0	+0	+0	+0	+0	+0	+0
00000210	-128	-256	+0	-1024	+768	+768	+512	+384
00000218	+384	+512	-128	-256	+0	+0	+0	+0
00000220	+0	+0	+0	+0	+0	+0	+0	+0
00000228	+0	+0	+0	+0	+0	+0	+256	-128
00000230	-128	+896	-1024	+0	+128	-256	-512	-384
00000238	-128	+128	-384	-512	+128	+0	+0	+0
00000240	+0	+0	+0	+0	+0	+0	+0	+0
00000248	+0	+0	+128	+0	+128	-384	-640	+0
00000250	+128	+0	+0	+1024	-128	-896	-1152	-896
00000258	-256	+768	+384	+0	+0	+0	+0	+0
00000260	+0	+0	+128	+0	+0	+0	-128	-128
00000268	+0	+0	+0	+0	+0	+128	-128	+0
00000270	+0	+0	+0	+0	+0	+0	+0	+0
00000278	+0	+0	+0	+0	+0	+0	+0	+0
00000280	+0	+0	+0	+0	+0	+0	+128	+0
00000288	+0	+0	+0	+0	+0	+0	+0	-128
00000290	+128	+0	+0	+0	+0	+0	-128	+128
00000298	+0	+0	+128	-128	+0	+0	+0	+0
000002A0	-128	+128	-128	+128	+128	+0	+0	+0
000002A8	+0	+0	+0	+0	+0	+0	+0	+0
000002B0	+0	+0	+0	+0	+0	+0	+0	+0
000002B8	-128	+128	-128	+0	+0	+0	+0	+0
000002C0	+0	+128	+128	+384	+384	+0	+128	+128
000002C8	-128	+128	+0	+0	+0	+0	+0	+0
000002D0	+0	+0	+0	+0	+0	+0	+0	+0
000002D8	+0	+0	+128	+0	+0	+0	+128	+0
000002E0	+0	+0	+256	+128	-512	-640	-1024	-768
000002E8	-512	+128	+0	+0	-128	+0	+0	+0
000002F0	+0	+0	+0	+0	+0	+0	+0	+0
000002F8	+0	+0	+0	+128	+0	+0	+0	+0
00000300	+384	-1152	-640	+1280	+256	+256	+0	-128
00000308	+256	+768	-512	-128	+0	+0	+0	+0
00000310	+0	+0	+0	+0	+0	+0	+0	+0
00000318	+0	+0	+0	+0	+0	+0	+0	+0
00000320	-128	+256	-128	-128	+128	+0	+0	+0
00000328	+0	+0	-128	+512	-256	-128	+128	-128
00000330	+128	-128	+0	+0	+0	+0	+0	+0
00000338	+0	+128	+0	+0	+0	+0	+0	+0
00000340	+0	+0	+0	+0	+0	+0	+0	+0
00000348	+0	+0	+0	+0	+0	+0	+0	+128
00000350	-128	+128	+0	+0	+0	+0	+0	+0
00000358	+0	+0	+0	+0	+0	+0	+0	+0

00000360	+0	+128	+0	+0	+0	+0	+0	+0
00000368	+0	+0	+0	+0	+0	+0	-128	-128
00000370	+0	-128	+128	+128	+0	+128	+0	-128
00000378	+384	-128	+0	+0	+0	+0	+0	+0
00000380	+0	+0	+0	+0	+0	+0	+0	+0
00000388	+0	+0	+0	+0	+0	+0	+0	-128
00000390	-128	-128	+128	+128	+128	+0	-256	-384
00000398	+0	+0	+0	+0	+0	+0	+0	+0
000003A0	+0	+0	+0	+0	+0	+0	+0	+0
000003A8	+0	+0	+0	+0	+0	+0	+0	+0
000003B0	+0	+0	-128	+512	+256	+128	+0	+0
000003B8	+0	+0	+0	+0	+0	+0	+0	+0
000003C0	+0	+0	+0	+0	+0	+0	+0	+0
000003C8	+0	+0	+0	+0	+0	+0	+0	+0
000003D0	+0	+0	+0	+0	-256	+0	+0	+0
000003D8	+0	+0	+0	+0	+0	+0	+0	+0
000003E0	+0	+0	+0	+0	+0	+0	+0	+0
000003E8	+0	+0	+0	+0	+0	+0	+0	+0
000003F0	+0	+0	+0	+0	+0	+0	+0	+0
000003F8	+0	+0	+0	+0	+0	+0	+0	+0
00000400	+0	+0	+0	+0	+0	+0	+0	+0
00000408	+0	+0	+0	+0	+0	+0	+0	+0

4.2.4.3.3.4 HH1

The following is a dump of the HL1 sub-band, as shown in the figure illustrating three-level DWT decomposition in section [3.1.8.1.4](#).

00000000	+0	+0	+0	+0	+0	+0	+0	+0
00000008	+0	+0	+0	+0	+0	+0	+0	+0
00000010	+0	+0	+0	+0	+0	+0	+0	+0
00000018	+0	+0	+0	+0	+0	+0	+0	+0
00000020	+0	+0	+0	+0	+0	+0	+0	+0
00000028	+0	+0	+0	+0	+0	+0	+0	+0
00000030	+0	+0	+0	+0	+0	+0	+0	+0
00000038	+0	+0	+0	+0	+0	+0	+0	+0
00000040	+0	+0	+0	+0	+0	+0	+0	+0
00000048	+0	+0	+0	+0	+0	+0	+0	+0
00000050	+0	+0	+0	+0	+0	+0	+0	+0
00000058	+0	+0	+0	+0	+0	+0	+0	+0
00000060	+0	+0	+0	+0	+0	+0	+0	+0
00000068	+0	+0	+0	+0	+0	+0	+0	+0
00000070	+0	+0	+0	+0	+0	+0	+0	+0
00000078	+0	+0	+0	+0	+0	+0	+0	+0
00000080	+0	+0	+0	+0	+0	+0	+0	+0
00000088	+0	+0	+0	+0	+0	+0	+0	+0
00000090	+0	+0	+0	+0	+0	+0	+0	+0
00000098	+0	+0	+0	+0	+0	+0	+0	+0
000000A0	+0	+0	+0	+0	+0	+0	+0	+0
000000A8	+0	+0	+0	+0	+0	+0	+0	+0
000000B0	+0	+0	+0	+0	+0	+0	+0	+0
000000B8	+0	+0	+0	+0	-256	+256	+0	+0
000000C0	+0	+0	+0	+0	+0	+0	+0	+0
000000C8	+0	+0	+0	+0	+0	+0	+0	+0
000000D0	+0	+0	+0	+0	+0	+0	+0	+0
000000D8	+0	+0	+0	-512	-256	+256	+0	+0
000000E0	+0	+0	+0	+0	+0	-256	-256	+0

000000E8	+0	+0	+0	+0	+0	+0	+0	+0
000000F0	+0	-256	+0	+0	+0	+0	+0	+0
000000F8	+0	+0	-256	+256	-512	+0	+0	+0
00000100	+0	+0	+0	+0	+0	+0	+0	+0
00000108	+0	+0	+0	+0	+0	+0	+0	+0
00000110	+0	+0	-256	+0	+0	+0	+0	+0
00000118	+0	+0	+0	-256	+0	+0	+256	-256
00000120	+0	+0	+0	+0	+0	-256	+0	+0
00000128	+0	+0	+0	+0	+0	+0	+0	+0
00000130	+0	+0	+0	+0	+0	+0	+0	+0
00000138	+0	+0	+0	+0	+0	+0	+0	+0
00000140	+0	+0	+0	+0	+0	+0	+0	+0
00000148	+0	+0	+0	+0	+0	+0	+0	+0
00000150	+0	+0	+0	+0	+0	+0	+0	+0
00000158	+0	+0	+0	+0	+0	+0	+0	+0
00000160	+0	+0	+0	+0	+0	+0	+0	+0
00000168	+0	+0	+0	+0	+0	+0	+0	+0
00000170	+0	+0	+0	+0	+0	+0	+0	+0
00000178	+0	+0	+0	+0	+0	+0	+0	+0
00000180	+0	+0	+0	+0	+0	+0	+0	+0
00000188	+0	+0	+0	-256	+0	+0	+0	+256
00000190	+0	+0	+0	+0	+0	+0	+0	+0
00000198	+0	+0	+0	+0	+0	+0	+0	+0
000001A0	+0	+0	+0	+0	+256	+0	+0	+0
000001A8	+0	+0	+0	+0	+0	+0	+0	-256
000001B0	+0	+256	+0	+0	+0	+0	+0	+0
000001B8	+0	+0	+0	+0	+256	+0	+0	+0
000001C0	+0	+0	+0	+0	+256	+0	+0	+0
000001C8	+0	+0	+0	+0	+0	-256	+0	+0
000001D0	+0	+0	+0	+0	+0	+0	+0	+0
000001D8	+0	+0	+0	+256	+256	+0	+0	+0
000001E0	+0	+0	+0	+0	+0	+0	+0	+0
000001E8	+0	+0	+0	+0	+0	+0	-256	+0
000001F0	+256	+0	+0	+0	+0	+0	+0	+0
000001F8	+0	+0	+0	+256	+0	+0	+0	+0
00000200	+0	+0	+0	-256	+0	+0	+0	+0
00000208	+0	+0	+0	+0	+0	+0	+0	+0
00000210	-512	+0	+0	+0	+0	+0	+0	+0
00000218	+0	+0	+0	+0	+0	+0	+0	+0
00000220	+0	+0	+0	+0	+0	+0	+0	+0
00000228	+0	+0	+0	+0	+0	+0	-256	+0
00000230	-256	+0	+0	+0	+0	+0	+0	+0
00000238	+0	+0	+0	+256	+0	+0	+0	+0
00000240	+0	+0	+0	+0	+0	+0	+0	+0
00000248	+0	+0	+0	+0	+0	-256	+256	+0
00000250	+0	+0	+0	+0	+0	+0	+0	+0
00000258	+0	+0	+0	-256	+0	+0	+0	+0
00000260	+0	+0	+0	+0	+0	+0	+0	+0
00000268	+0	+0	+0	+0	+0	+256	+0	+0
00000270	+0	+0	+0	+0	+0	+0	+0	+0
00000278	+0	+0	+0	+0	+0	+0	+0	+0
00000280	+0	+0	+0	+0	+0	+0	+0	+0
00000288	+0	+0	+0	+0	+0	+0	+0	+256
00000290	+0	+0	+0	+0	+0	+0	+0	+0
00000298	+0	+0	+256	+0	+0	+0	+0	+0
000002A0	+0	+256	+0	+0	+0	+256	+0	+0
000002A8	+0	+0	+0	+0	+0	+0	+0	+0
000002B0	+0	+0	+0	+0	+0	+0	+0	+0
000002B8	+0	+0	+0	+0	+0	+0	+0	+0

000002C0	+0	+0	-256	+0	+0	+256	+256	+0
000002C8	+0	+0	+0	+0	+0	+0	+0	+0
000002D0	+0	+0	+0	+0	+0	+0	+0	+0
000002D8	+0	+0	+0	+0	+0	+0	+0	+0
000002E0	+0	-256	-256	+512	+0	-256	+0	+0
000002E8	+0	+0	+0	+0	+0	+0	+0	+0
000002F0	+0	+0	+0	+0	+0	+0	+0	+0
000002F8	+0	+0	+0	+0	+0	+0	+0	+0
00000300	+256	-256	+0	+0	+0	+0	+0	+0
00000308	+0	+256	-256	+0	+0	+0	+0	+0
00000310	+0	+0	+0	+0	+0	+0	+0	+0
00000318	+0	+0	+0	+0	+0	+0	+0	+0
00000320	+0	+0	+0	+0	+0	+0	+0	+0
00000328	+0	+0	+0	+0	+0	+0	+256	+0
00000330	+0	+0	+0	+0	+0	+0	+0	+0
00000338	+0	+0	+0	+0	+0	+0	+0	+0
00000340	+0	+0	+0	+0	+0	+0	+0	+0
00000348	+0	+0	+0	+0	+0	+0	+0	+0
00000350	+0	+0	+0	+0	+0	+0	+0	+0
00000358	+0	+0	+0	+0	+0	+0	+0	+0
00000360	+0	+0	+0	+0	+0	+0	+0	+0
00000368	+0	+0	+0	+0	+0	+0	+0	+0
00000370	-256	+0	+0	+0	+0	+0	+0	+0
00000378	+0	+0	+0	+0	+0	+0	+0	+0
00000380	+0	+0	+0	+0	+0	+0	+0	+0
00000388	+0	+0	+0	+0	+0	+0	+0	+0
00000390	-256	+0	+0	+0	+0	+0	+0	+0
00000398	+0	+0	+0	+0	+0	+0	+0	+0
000003A0	+0	+0	+0	+0	+0	+0	+0	+0
000003A8	+0	+0	+0	+0	+0	+0	+0	+0
000003B0	+0	+0	-256	-256	+256	+0	+0	+0
000003B8	+0	+0	+0	+0	+0	+0	+0	+0
000003C0	+0	+0	+0	+0	+0	+0	+0	+0
000003C8	+0	+0	+0	+0	+0	+0	+0	+0
000003D0	+0	+0	+0	-256	+0	+0	+0	+0
000003D8	+0	+0	+0	+0	+0	+0	+0	+0
000003E0	+0	+0	+0	+0	+0	+0	+0	+0
000003E8	+0	+0	+0	+0	+0	+0	+0	+0
000003F0	+0	+0	+0	+0	+0	+0	+0	+0
000003F8	+0	+0	+0	+0	+0	+0	+0	+0

4.2.4.3.3.5 Inverse DWT-X (LL1 - HL1)

The following is a dump of the L0 sub-band, as shown in the figure illustrating three-level DWT decomposition in section [3.1.8.1.4](#).

00000000	-32	+16	+64	+272	-32	-16	+0	-16
00000008	-32	-24	-16	-8	+0	-24	-48	-72
00000010	-96	-90	-84	-78	-72	-98	-124	-150
00000018	-176	-192	-208	-224	-240	-256	-272	-288
00000020	-304	-304	-304	-304	-304	-336	-368	-400
00000028	-432	-450	-468	-486	-504	-522	-540	-558
00000030	-576	-598	-620	-642	-664	-686	-708	-730
00000038	-752	-768	-784	-800	-816	-816	-816	-816
00000040	+168	+224	+281	+209	+138	+126	+115	+103
00000048	+92	+88	+84	+80	+76	+64	+52	+40
00000050	+28	+18	+8	-2	-12	-38	-64	-90

00000058	-116	-105	-95	-148	-201	-198	-195	-192
00000060	-190	-204	-218	-232	-247	-269	-291	-313
00000068	-336	-357	-379	-400	-422	-447	-473	-498
00000070	-524	-546	-569	-591	-614	-660	-707	-689
00000078	-672	-698	-724	-750	-776	-776	-776	-776
00000080	+368	+401	+434	+339	+244	+237	+230	+223
00000088	+216	+200	+184	+168	+152	+152	+152	+152
00000090	+152	+126	+100	+74	+48	+22	-4	-30
00000098	-56	-18	+19	-71	-162	-140	-119	-97
000000A0	-76	-104	-133	-161	-190	-202	-215	-227
000000A8	-240	-265	-290	-315	-340	-373	-406	-439
000000B0	-472	-495	-518	-541	-564	-635	-706	-649
000000B8	-592	-628	-664	-700	-736	-736	-736	-736
000000C0	+376	+649	+411	+364	+318	+795	+249	+342
000000C8	+436	+408	+380	+352	+324	+308	+292	-140
000000D0	-60	+74	+208	+182	+156	+186	+216	+374
000000D8	+532	+504	+476	+320	+165	+61	-42	-146
000000E0	-250	-244	-239	-170	-101	-123	-146	-169
000000E8	-192	-216	-241	-265	-290	-318	-347	-375
000000F0	-404	-399	-395	-454	-514	-557	-601	-356
000000F8	-624	-622	-620	-650	-680	-680	-680	-680
00000100	+1152	+1026	+900	+870	+840	+906	+460	+430
00000108	+400	+424	+448	+408	+368	+400	-592	-240
00000110	+112	+534	+956	+994	+1032	+926	+820	+970
00000118	+1120	+1155	+1190	+1097	+1004	+839	+674	+509
00000120	+344	+191	+38	+13	-12	-45	-78	-111
00000128	-144	-168	-192	-216	-240	-264	-288	-312
00000130	-336	-304	-272	-368	-464	-416	-368	-448
00000138	-528	-552	-576	-600	-624	-624	-624	-624
00000140	+708	+637	+566	+559	+552	+513	+474	+499
00000148	+524	+561	+599	+572	+546	+131	-283	+6
00000150	+296	+665	+1034	+1627	+1708	+1669	+1630	+1623
00000158	+1616	+1711	+1806	+1709	+1612	+1531	+1450	+1241
00000160	+1032	+950	+869	+563	+258	-120	+15	-74
00000168	-164	-180	-197	-150	-103	-123	-144	-165
00000170	-186	-325	-464	-283	-102	-305	-508	-487
00000178	-466	-1022	-1066	-534	-514	-578	-642	-642
00000180	+776	+760	+744	+728	+712	+696	+680	+664
00000188	+648	+635	+622	+577	+532	-457	+90	+413
00000190	+736	+924	+1112	+1524	+1936	+2284	+2120	+2116
00000198	+2112	+2267	+2422	+2321	+2220	+2223	+2226	+1973
000001A0	+1720	+1582	+1444	+1242	+16	-2	-20	+26
000001A8	+72	-65	-203	-212	-222	-239	-257	-274
000001B0	-292	-186	-80	+58	-316	-290	-264	-462
000001B8	+364	+2508	+2604	-436	-916	-1012	-596	-596
000001C0	+876	+855	+834	+813	+792	+803	+814	+825
000001C8	+836	+720	+605	+553	+1014	-18	+487	+735
000001D0	+984	+1239	+1494	+1813	+2132	+2343	+2554	+2573
000001D8	+2592	+2639	+2686	+2861	+3036	+2823	+2610	+2525
000001E0	+2440	+2405	+2371	+448	+62	+115	+169	+1438
000001E8	+1172	+970	+768	+533	+299	+217	+135	+52
000001F0	-30	-63	-96	-161	-226	-419	-100	+955
000001F8	-38	+1842	+1674	-990	-1094	-998	-390	-390
00000200	+976	+950	+924	+898	+872	+846	+820	+794
00000208	+768	+806	+844	+786	+1752	+2534	+756	+994
00000210	+1232	+1554	+1876	+2070	+2264	+2594	+2924	+2998
00000218	+3072	+3139	+3206	+3305	+2380	+3103	+3314	+3173
00000220	+3032	+3005	+1954	-217	+172	-87	+1702	+2147
00000228	+2080	+1973	+1866	+1727	+1588	+1441	+1294	+1147

00000230	+1000	+796	+592	+484	+376	+732	+576	+1092
00000238	+72	-584	-728	+952	+72	-56	-184	-440
00000240	+1076	+1045	+1015	+984	+954	+931	+909	+886
00000248	+864	+751	+639	+462	+1310	+1749	+3213	+1636
00000250	+1596	+1801	+2006	+2307	+2609	+2898	+3187	+3348
00000258	+3510	+3561	+3613	+3568	+1988	+2931	+3875	+3666
00000260	+3458	+3559	+76	+81	+86	+667	+3296	+2981
00000268	+2666	+2652	+2639	+2561	+2484	+2282	+2081	+1943
00000270	+1806	+1713	+1621	+1464	+1308	+1183	+1059	+390
00000278	+234	-60	-354	+1464	+3794	+2226	-366	-622
00000280	+1176	+1141	+1106	+1071	+1036	+1017	+998	+979
00000288	+960	+857	+754	+11	+804	+1605	+1894	+3239
00000290	+2024	+2272	+2521	+2737	+2954	+3074	+3195	+3315
00000298	+3436	+3536	+3636	+3384	+3132	+3144	+3668	+3776
000002A0	+3884	+1937	-10	+155	-192	+3309	+3226	+3207
000002A8	+3188	+3236	+3284	+3204	+3124	+2932	+2740	+2676
000002B0	+2612	+2567	+2522	+2221	+1920	+1539	+1158	+777
000002B8	+396	+112	-172	-744	-804	-580	-356	-356
000002C0	+1212	+1184	+1157	+1129	+1102	+1078	+1055	+967
000002C8	+880	+1082	+261	+527	+794	+1284	+1775	+2393
000002D0	+3012	+2487	+2987	+3231	+3475	+3474	+3474	+3474
000002D8	+3474	+3546	+3619	+3659	+3700	+4012	+3813	+3869
000002E0	+3926	-157	+368	+221	+1610	+3763	+3356	+3461
000002E8	+3566	+3571	+3577	+3518	+3460	+3449	+3439	+3364
000002F0	+3290	+2956	+2623	+2225	+1828	+1570	+1313	+991
000002F8	+670	+328	-14	-452	-378	-314	-250	-250
00000300	+1248	+1228	+1208	+1188	+1168	+1140	+1112	+1084
00000308	+1056	+636	+216	+596	+976	+1252	+2040	+2156
00000310	+2784	+2127	+1982	+2093	+2204	+2531	+2858	+3185
00000318	+3512	+3941	+4370	+4159	+3948	+3921	+3894	+4123
00000320	+1280	+277	+298	+95	+3988	+3609	+3742	+3715
00000328	+3688	+3715	+3742	+3769	+3796	+3711	+3626	+3285
00000330	+2944	+2642	+2340	+2166	+1992	+1794	+1596	+1270
00000338	+944	+480	+16	-352	-208	-304	-400	-400
00000340	+1344	+1340	+1337	+1333	+1330	+1190	+1051	+1071
00000348	+1092	+212	+869	+918	+967	+951	+936	+729
00000350	+522	+517	+513	+445	+377	+292	+208	+28
00000358	+360	+456	+552	+1672	+3304	+3784	+4264	+3400
00000360	-24	+485	-31	+2781	+4058	+4018	+3979	+3907
00000368	+3836	+3818	+3801	+3784	+3767	+3561	+3356	+3407
00000370	+3458	+3642	+3826	+3594	+3363	+2939	+2003	+1163
00000378	+324	+482	-384	-354	-324	-324	-324	-324
00000380	+1440	+1389	+1338	+1287	+1236	+1273	+1310	+1155
00000388	+1512	+1677	+1331	+1048	+766	+523	+281	+454
00000390	+1140	+1532	+901	+1261	+1622	+1734	+1847	+1607
00000398	+856	+587	+318	+177	+36	+319	+1114	+757
000003A0	+400	+340	+792	+4252	+4128	+4076	+4024	+4004
000003A8	+3984	+3922	+3861	+3799	+3738	+3860	+3983	+3849
000003B0	+3716	+3426	+3137	+2975	+2814	+2996	+3179	+3329
000003B8	+3480	+1732	+1520	+124	-248	-248	-248	-248
000003C0	+1472	+1425	+1379	+1332	+1286	+1339	+1393	+1062
000003C8	-804	-1450	-1584	-1365	-1147	-877	-95	+751
000003D0	+1598	+1943	+1776	+2153	+2531	+2872	+3213	+3650
000003D8	+4088	+4134	+3668	+2818	+944	+498	+564	+502
000003E0	+440	+275	+2671	+3850	+4518	+4305	+4093	+3976
000003E8	+3860	+3898	+3936	+3974	+4013	+3783	+3553	+3323
000003F0	+3094	+2858	+2623	+2388	+2153	+1825	+1498	+1267
000003F8	+2572	+538	+552	+150	-252	-252	-252	-252
00000400	+1504	+1462	+1420	+1410	+1400	+1310	+1732	-1558

00000408	-1776	-1089	-914	-611	-308	+59	+938	+1529
00000410	+2120	+2322	+2524	+2854	+3184	+3402	+3620	+3710
00000418	+3800	+3873	+3946	+4211	+4476	+3941	+334	+535
00000420	+736	+179	+134	+409	+684	+2327	+3458	+3853
00000428	+4248	+4162	+4076	+4310	+4032	+3418	+3316	+3150
00000430	+2984	+2611	+2238	+1737	+1236	+975	+714	+197
00000438	-320	-272	-224	-176	-128	-192	-256	-256
00000440	+1588	+1531	+1475	+1450	+1426	+1561	+161	-1751
00000448	-1104	-775	-446	-149	+148	+753	+1358	+1899
00000450	+2440	+2650	+2861	+3136	+3411	+3533	+3656	+3715
00000458	+3774	+3927	+4080	+3913	+4258	+2063	+380	+585
00000460	+278	+3130	+862	+354	-154	-70	+14	+194
00000468	+374	+638	+1414	+1806	+1686	+1634	+1582	+1178
00000470	+774	+463	+152	+1	-149	-580	-499	-33
00000478	-80	-46	-12	-74	-136	-200	-264	-264
00000480	+1672	+1601	+1530	+1491	+1452	+1685	-1666	-1209
00000488	-752	-461	-170	+121	+412	+999	+1586	+2045
00000490	+2504	+2787	+3071	+3354	+3638	+3665	+3693	+3720
00000498	+3748	+3629	+3510	+3327	+2632	+377	+682	+283
000004A0	+2444	+4257	+4534	+4043	+3552	+2141	+730	+471
000004A8	+212	-102	-416	-474	-532	-502	-472	-314
000004B0	-156	+11	+179	+442	+1218	+1897	+2577	+952
000004B8	-160	-108	-56	-100	-144	-208	-272	-272
000004C0	+1580	+1614	+1649	+1459	+1782	-268	-1293	-1006
000004C8	-720	-443	-166	+79	+324	+549	+1286	+1799
000004D0	+2312	+2620	+2928	+3108	+3289	+3281	+3273	+3329
000004D8	+3386	+3443	+3500	+3045	+1054	+655	+768	+593
000004E0	+4002	+4056	+4110	+4068	+4026	+4236	+4446	+4208
000004E8	+3970	+3742	+3514	+3478	+3442	+3274	+3106	+3322
000004F0	+3538	+3587	+3637	+3399	+3161	+2986	+2300	-402
000004F8	-32	-122	-212	-174	-136	-200	-264	-264
00000500	+1744	+1692	+1640	+1588	+1536	-1900	-1240	-964
00000508	-688	-361	-34	+165	+364	+675	+986	+1553
00000510	+2120	+2389	+2658	+2671	+2684	+2705	+2726	+2875
00000518	+3024	+3001	+2978	+2475	+436	+837	+214	+3143
00000520	+4024	+4015	+4006	+3997	+3988	+3963	+3938	+3913
00000528	+3888	+3842	+3796	+3590	+3896	+3946	+3996	+3694
00000530	+3392	+3292	+3192	+3028	+2864	+3148	+360	-92
00000538	-32	-72	-112	-120	-128	-192	-256	-256
00000540	+1860	+1546	+1745	+2072	-1185	-1426	-1155	-820
00000548	-486	-207	+71	+317	+563	+449	+847	+669
00000550	+1004	+1302	+1600	+1802	+2005	+2191	+2377	+2435
00000558	+2494	+2477	+2460	+843	+763	+730	+1209	+4120
00000560	+3960	+4011	+4062	+3985	+3908	+3883	+3858	+3833
00000568	+3808	+3707	+3607	+3571	+3535	+3506	+3478	+3706
00000570	+3934	+3916	+3899	+3786	+3673	+2368	-473	+14
00000578	-12	-24	-36	-80	-124	-156	-188	-188
00000580	+1720	+1849	+1979	+1180	-1666	-1272	-1391	-453
00000588	-540	-758	+47	-364	+250	+383	+517	+170
00000590	+336	+439	+543	+678	+814	+1229	+1645	+1644
00000598	+1644	+1697	+1239	+748	+770	+399	+3613	+3978
000005A0	+3832	+3847	+3862	+3845	+3828	+3803	+3778	+3753
000005A8	+3728	+3669	+3611	+3552	+3494	+3419	+3345	+3142
000005B0	+2940	+2813	+2687	+2624	+2562	-237	+37	-9
000005B8	-56	-72	-88	-104	-120	-120	-120	-120
000005C0	+1820	+1760	+2212	-2232	-1555	-762	-1506	-1290
000005C8	-1586	-717	-872	-803	-735	-1302	-846	-389
000005D0	-444	-127	-323	-70	+183	+143	+104	+321
000005D8	+538	+777	+1017	+841	+665	+1924	+3696	+3708

000005E0	+3720	+3731	+3742	+3721	+3700	+3431	+3674	+3629
000005E8	+3584	+3523	+3462	+3401	+3341	+3264	+3187	+2982
000005F0	+2778	+2562	+2346	+2418	+955	-13	+44	+68
000005F8	+92	+36	-20	-76	-132	-132	-132	-132
00000600	+1664	+1991	-754	-3435	-2020	-2493	-1942	-751
00000608	+440	+124	+832	+1508	+1672	+1492	+1312	+1004
00000610	+696	-182	-548	-1074	-1088	-1134	-668	-330
00000618	-504	+402	+796	+902	+496	+3610	+3652	+3598
00000620	+3544	+3583	+3622	+3533	+3444	+3443	+3442	+3441
00000628	+3440	+3377	+3314	+3251	+3188	+3109	+3030	+2823
00000630	+2616	+2439	+2262	+2053	-204	+211	+114	+49
00000638	-16	-48	-80	-112	-144	-144	-144	-144
00000640	+1800	+1778	+221	+1352	+1459	+1793	+2128	+2111
00000648	+1582	+1477	+1373	+1333	+1293	+1528	+1252	+1488
00000650	+1212	+1345	+1478	+1227	+977	+438	-613	-1279
00000658	-922	+1323	+1008	+885	+2299	+3228	+3133	+3262
00000660	+3392	+3204	+3016	+3212	+3409	+3305	+3201	+3449
00000668	+3186	+3153	+3121	+3056	+2992	+2887	+2783	+2550
00000670	+2318	+2175	+2032	+545	+82	+95	+108	+57
00000678	+6	-26	-58	-90	-122	-122	-122	-122
00000680	+1680	+1694	+1709	+1595	+1482	+1472	+1463	+1453
00000688	+1444	+1391	+1339	+1286	+1234	+1213	+1193	+1172
00000690	+1152	+1112	+1073	+1065	+1058	+922	+1299	+1131
00000698	+964	+868	+773	+709	+2182	+2302	+2423	+2799
000006A0	+2664	+2793	+2923	+2860	+2798	+3007	+2705	+3106
000006A8	+2996	+2962	+2928	+2862	+2796	+2666	+2536	+2278
000006B0	+2020	+1783	+1546	-227	+48	+43	+38	+33
000006B8	+28	-4	-36	-68	-100	-100	-100	-100
000006C0	+1624	+1650	+1676	+1638	+1601	+1551	+1501	+1451
000006C8	+1402	+1361	+1320	+1279	+1239	+1214	+1189	+1164
000006D0	+1140	+1103	+1067	+1031	+995	+1014	+1034	+926
000006D8	+818	+885	+953	+989	+1025	+992	+1472	+2048
000006E0	+2112	+1886	+2173	+2108	+2555	+2485	+2416	+2411
000006E8	+2406	+2726	+2535	+2311	+2088	+2068	+2049	+1997
000006F0	+1946	+1779	+76	+69	+62	+83	+104	+61
000006F8	+18	-10	-38	-66	-94	-126	-158	-158
00000700	+1824	+1734	+1644	+1554	+1464	+1438	+1412	+1386
00000708	+1360	+1331	+1302	+1273	+1244	+1215	+1186	+1157
00000710	+1128	+1095	+1062	+1029	+996	+979	+962	+945
00000718	+928	+871	+814	+789	+764	+707	+1162	+1585
00000720	+2008	+1588	+1168	+1356	+1544	+1836	+1616	+1940
00000728	+1752	+2235	+2206	+1217	+1252	+1311	+1370	+1013
00000730	+144	+143	+142	+109	+76	+59	+42	+25
00000738	+8	-16	-40	-64	-88	-152	-216	-216
00000740	+1552	+1528	+1504	+1480	+1456	+1420	+1384	+1348
00000748	+1312	+1289	+1266	+1243	+1220	+1197	+1174	+1151
00000750	+1128	+1091	+1054	+1017	+980	+959	+938	+917
00000758	+896	+853	+810	+767	+724	+613	+502	+551
00000760	+600	+384	+680	+560	+440	+376	+1336	+1528
00000768	+1208	+989	+258	+231	+204	+137	+70	+131
00000770	+192	+167	+142	+117	+92	+71	+50	+29
00000778	+8	-20	-48	-76	-104	-136	-168	-168
00000780	+1536	+1514	+1492	+1470	+1448	+1402	+1356	+1310
00000788	+1264	+1247	+1230	+1213	+1196	+1179	+1162	+1145
00000790	+1128	+1087	+1046	+1005	+964	+939	+914	+889
00000798	+864	+835	+806	+777	+748	+711	+674	+637
000007A0	+600	+588	+576	+564	+552	+580	+608	+1660
000007A8	+1176	+511	+358	+333	+308	+275	+242	+209
000007B0	+176	+159	+142	+125	+108	+83	+58	+33

000007B8	+8	-24	-56	-88	-120	-120	-120	-120
000007C0	+1536	+1514	+1492	+1470	+1448	+1402	+1356	+1310
000007C8	+1264	+1247	+1230	+1213	+1196	+1179	+1162	+1145
000007D0	+1128	+1087	+1046	+1005	+964	+939	+914	+889
000007D8	+864	+835	+806	+777	+748	+711	+674	+637
000007E0	+600	+588	+576	+564	+552	+452	+352	+92
000007E8	+344	+319	+294	+301	+308	+275	+242	+209
000007F0	+176	+159	+142	+125	+108	+83	+58	+33
000007F8	+8	-24	-56	-88	-120	-120	-120	-120

4.2.4.3.3.6 Inverse DWT-X (LH1 - HH1)

The following is a dump of the H0 sub-band, as shown in the figure illustrating three-level DWT decomposition in section [3.1.8.1.4](#).

00000000	+0	+0	+0	+0	+0	+0	+0	+0
00000008	+0	+0	+0	+0	+0	+0	+0	+0
00000010	+0	+0	+0	+0	+0	+0	+0	+0
00000018	+0	+0	+0	+0	+0	+0	+0	+0
00000020	+0	+0	+0	+0	+0	+0	+0	+0
00000028	+0	+0	+0	+0	+0	+0	+0	+0
00000030	+0	+0	+0	+0	+0	+0	+0	+0
00000038	+0	+0	+0	+0	+0	+0	+0	+0
00000040	+0	+0	+0	+0	+0	+0	+0	+0
00000048	+0	+0	+0	+0	+0	+0	+0	+0
00000050	+0	+0	+0	+0	+0	+0	+0	+0
00000058	+0	+0	+0	+0	+0	+0	+0	+0
00000060	+0	+0	+0	+0	+0	+0	+0	+0
00000068	+0	+0	+0	+0	+0	+0	+0	+0
00000070	+0	+0	+0	+0	+0	+0	+0	+0
00000078	+0	+0	+0	+0	+0	+0	+0	+0
00000080	+0	+0	+0	+0	+0	+0	+0	+0
00000088	+0	+0	+0	+0	+0	+0	+0	+64
00000090	+128	+64	+0	-64	-128	-128	-128	-64
00000098	+0	+0	+0	-64	-128	-128	-128	+0
000000A0	+128	+64	+0	+0	+0	+0	+0	+0
000000A8	+0	+0	+0	+0	+0	+0	+0	+0
000000B0	+0	+0	+0	+0	+0	+0	+0	+0
000000B8	+0	+0	+0	+0	+0	+0	+0	+0
000000C0	-128	-128	-128	-128	-128	-64	+0	+0
000000C8	+0	+0	+0	+0	+0	-64	-128	-64
000000D0	+0	+0	+0	+0	+0	+0	+0	+0
000000D8	+0	+0	+0	+0	+0	+0	+0	+0
000000E0	+0	-64	-128	-64	+0	+0	+0	+0
000000E8	+0	+0	+0	+0	+0	+0	+0	+0
000000F0	+0	+0	+0	+0	+0	+0	+0	+0
000000F8	+0	+0	+0	+0	+0	+0	+0	+0
00000100	-128	-128	-128	-128	-128	-64	+0	+0
00000108	+0	+0	+0	+0	+0	+0	+0	+0
00000110	+0	+0	+0	+0	+0	+0	+0	+0
00000118	+0	+0	+0	+0	+0	+0	+0	+0
00000120	+0	+0	+0	+0	+0	+0	+0	+0
00000128	+0	+0	+0	+0	+0	+0	+0	+0
00000130	+0	+0	+0	+0	+0	+0	+0	+0
00000138	+0	+0	+0	+0	+0	+0	+0	+0
00000140	+0	+0	+0	+0	+0	+0	+0	+0

00000148	+0	+0	+0	+0	+0	+0	+0	+0
00000150	+0	+0	+0	+0	+0	+0	+0	+0
00000158	+0	+0	+0	+0	+0	+0	+0	+0
00000160	+0	+0	+0	+0	+0	+0	+0	-64
00000168	-128	+0	+128	+64	+0	+0	+0	+0
00000170	+0	+0	+0	+0	+0	+0	+0	-64
00000178	-128	-1088	-1024	+64	+128	+64	+0	+0
00000180	+0	+0	+0	+0	+0	+0	+0	+0
00000188	+0	+0	+0	-64	-128	-64	+0	+0
00000190	+0	+0	+0	+0	+0	+0	+0	+0
00000198	+0	+0	+0	+0	+0	+0	+0	+0
000001A0	+0	+0	+0	+0	+0	+0	+0	+0
000001A8	+0	+0	+0	-64	-128	-64	+0	+0
000001B0	+0	+64	+128	+64	+0	+0	+0	-576
000001B8	+896	+192	+512	+640	-256	-128	+0	+0
000001C0	+0	+0	+0	+0	+0	+0	+0	+0
000001C8	+0	+0	+0	-192	+640	-192	+0	+0
000001D0	+0	+0	+0	+0	+0	+0	+0	+0
000001D8	+0	+0	+0	+64	+128	+64	+0	+0
000001E0	+0	+128	+256	-320	+128	+64	+0	+0
000001E8	+0	+0	+0	+0	+0	+0	+0	+0
000001F0	+0	+0	+0	+0	+0	-320	+384	+960
000001F8	+512	-1088	-640	-384	-128	-64	+0	+0
00000200	+0	+0	+0	+0	+0	+0	+0	+0
00000208	+0	+0	+0	+0	+0	+64	+128	+64
00000210	+0	+0	+0	+0	+0	+0	+0	+0
00000218	+0	+0	+0	+0	+0	+0	+0	+0
00000220	+0	+0	+0	+0	+0	-384	+256	+128
00000228	+0	+0	+0	+0	+0	+0	+0	+0
00000230	+0	+0	+0	+0	+0	+128	+256	-320
00000238	+128	+64	+0	+320	+640	+1024	+384	-128
00000240	+0	+0	+0	+0	+0	+0	+0	+0
00000248	+0	+64	+128	-384	+128	+64	+0	+0
00000250	+0	+0	+0	+0	+0	+64	+128	+64
00000258	+0	+0	+0	+0	+0	+0	+0	+64
00000260	+128	+64	+0	+0	+0	+0	+0	+0
00000268	+0	+0	+0	+0	+0	+0	+0	+0
00000270	+0	+0	+0	+0	+0	+0	+0	+0
00000278	+0	+0	+0	-512	-1024	-512	+0	+0
00000280	+0	+0	+0	+0	+0	+0	+0	+0
00000288	+0	+0	+0	+0	+0	+0	+0	+0
00000290	+0	+0	+0	+0	+0	+64	+128	-64
00000298	-256	-256	-256	+0	+256	+64	-128	-64
000002A0	+0	+0	+0	-64	-128	-64	+0	+0
000002A8	+0	+0	+0	+0	+0	+0	+0	+0
000002B0	+0	+0	+0	+0	+0	+0	+0	+0
000002B8	+0	+0	+0	+0	+0	+0	+0	+0
000002C0	+0	+0	+0	+0	+0	+0	+0	+0
000002C8	+0	-64	-128	-64	+0	+0	+0	+64
000002D0	+128	+128	+128	+256	+384	+256	+128	+64
000002D8	+0	+0	+0	+0	+0	+0	+0	+0
000002E0	+0	+0	+0	+0	+0	+0	+0	+0
000002E8	+0	+0	+0	+0	+0	+64	+128	+64
000002F0	+0	+0	+0	+0	+0	+0	+0	+0
000002F8	+0	+0	+0	+0	+0	+0	+0	+0
00000300	+0	+0	+0	+0	+0	+0	+0	+0
00000308	+0	-64	-128	-64	+0	-64	-128	-384
00000310	-640	-512	-384	-448	-512	-576	-640	-1152
00000318	-640	+128	+896	+512	+128	+64	+0	+384

00000320	-256	-128	+0	+0	+0	+0	+0	+0
00000328	+0	+0	+0	+0	+0	+0	+0	-64
00000330	-128	-192	-256	-320	-384	-192	+0	+64
00000338	+128	+64	+0	+0	+0	+0	+0	+0
00000340	+0	+0	+0	+0	+0	+0	+0	-64
00000348	-128	+448	+0	+0	+0	+128	+256	+64
00000350	-128	-64	+0	-128	-256	-320	-384	-128
00000358	+128	+128	+128	-448	-1024	-64	+896	+0
00000360	+128	-64	-256	+384	+0	+0	+0	+0
00000368	+0	+0	+0	+0	+0	+64	+128	+128
00000370	+128	+64	+0	+0	+0	+384	+768	+128
00000378	-512	+128	-256	-128	+0	+0	+0	+0
00000380	+0	+0	+0	+0	+0	-64	-128	+192
00000388	+512	+832	+128	-320	-768	-512	-256	-128
00000390	+0	+0	+0	+0	+0	+128	+256	+576
00000398	+896	+128	-640	-832	+0	+0	+0	+0
000003A0	+0	+64	+128	+64	+0	+0	+0	+0
000003A8	+0	+0	+0	+0	+0	+0	+0	+0
000003B0	+0	+0	+0	-64	-128	-192	-256	+320
000003B8	-128	+768	+640	+320	+0	+0	+0	+0
000003C0	+0	+0	+0	+0	+0	+0	+0	-128
000003C8	-256	-64	+128	+64	+0	+0	+0	+0
000003D0	+0	+0	+0	+0	+0	+0	+0	+0
000003D8	+0	-64	-128	+384	+896	-64	+0	+0
000003E0	+0	+64	-896	+0	+896	+448	+0	+0
000003E8	+0	+0	+0	+0	+0	+0	+0	+0
000003F0	+0	+0	+0	+0	+0	+0	+0	+384
000003F8	-256	-192	-128	-64	+0	+0	+0	+0
00000400	+0	+0	+0	+0	+0	+128	+256	-320
00000408	+128	+64	+0	+0	+0	+0	+0	+0
00000410	+0	+0	+0	+0	+0	+0	+0	+0
00000418	+0	+0	+0	+0	+0	+0	+0	+64
00000420	+128	-960	+0	+0	+0	-512	-1024	-128
00000428	+768	+768	+768	+640	+512	+448	+384	+384
00000430	+384	+448	+512	+192	-128	-192	-256	-128
00000438	+0	+0	+0	+0	+0	+0	+0	+0
00000440	+0	+0	+0	+0	+0	+0	+0	+0
00000448	+0	+0	+0	+0	+0	+0	+0	+0
00000450	+0	+0	+0	+0	+0	+0	+0	+0
00000458	+0	+0	+0	+192	+384	-320	+0	+0
00000460	+0	+0	+1024	+0	-1024	-512	+0	+64
00000468	+128	-64	-256	-384	-512	-448	-384	-256
00000470	-128	+0	+128	-128	-384	-512	-640	+192
00000478	+0	+0	+0	+0	+0	+0	+0	+0
00000480	+0	+0	+0	+0	+0	+0	+0	+0
00000488	+0	+0	+0	+0	+0	+0	+0	+0
00000490	+0	+0	+0	+64	+128	+64	+0	+64
00000498	+128	-64	-256	-960	-640	+128	-128	+0
000004A0	+128	+64	+0	+0	+0	+512	+1024	+448
000004A8	-128	-512	-896	-1024	-1152	-1024	-896	-576
000004B0	-256	+256	+768	+576	+384	+256	+128	-384
000004B8	+128	+64	+0	+0	+0	+0	+0	+0
000004C0	+0	+0	+0	+64	+128	+64	+0	+0
000004C8	+0	+0	+0	-64	-128	-128	-128	-64
000004D0	+0	+0	+0	+0	+0	+0	+0	+0
000004D8	+0	+0	+0	+384	-256	-128	+0	+0
000004E0	+0	+0	+0	+0	+0	+0	+0	+0
000004E8	+0	+0	+0	+0	+0	+0	+0	+0
000004F0	+0	+0	+0	+0	+0	+0	+0	+0

000004F8	+0	+0	+0	+0	+0	+0	+0	+0
00000500	+0	+0	+0	+0	+0	+0	+0	+0
00000508	+0	+0	+0	+64	+128	+64	+0	+0
00000510	+0	+0	+0	+0	+0	+0	+0	+0
00000518	+0	+0	+0	+0	+0	-128	-256	+384
00000520	+0	+0	+0	+0	+0	+0	+0	+0
00000528	+0	+0	+0	-64	-128	+0	+128	+64
00000530	+0	+0	+0	+0	+0	+384	-256	-128
00000538	+0	+0	+0	+0	+0	+0	+0	+0
00000540	-128	-64	+0	+384	-256	-64	+128	+128
00000548	+128	+0	-128	+384	-128	-64	+0	+0
00000550	+0	+0	+0	+0	+0	+0	+0	+0
00000558	+0	+0	+0	+0	+0	+0	+0	+0
00000560	+0	+0	+0	+0	+0	+0	+0	+0
00000568	+0	+0	+0	+0	+0	+0	+0	-64
00000570	-128	+0	+128	+0	-128	-64	+0	+0
00000578	+0	+0	+0	+0	+0	+0	+0	+0
00000580	+0	+64	+128	+192	+256	-128	+512	+448
00000588	+384	+128	-128	+384	-128	+448	+0	-64
00000590	-128	+0	+128	+64	+0	+0	+0	+0
00000598	+0	+0	+0	+0	+0	+0	+0	+0
000005A0	+0	+0	+0	+0	+0	+0	+0	+0
000005A8	+0	+0	+0	+0	+0	+0	+0	+0
000005B0	+0	+0	+0	+64	+128	+64	+0	+0
000005B8	+0	+0	+0	+64	+128	+64	+0	+0
000005C0	+0	+64	+128	-192	+512	-256	+0	+640
000005C8	-768	-640	-512	-1216	-896	-832	-768	-640
000005D0	-512	-192	+128	+64	+0	+0	+0	-64
000005D8	-128	-64	+0	+0	+0	+0	+0	+0
000005E0	+0	+0	+0	+0	+0	+0	+0	+0
000005E8	+0	+0	+0	+0	+0	+0	+0	+0
000005F0	+0	+0	+0	+0	+0	+64	+128	+64
000005F8	+0	+0	+0	+0	+0	+0	+0	+0
00000600	+128	+0	-1152	-1344	-512	+384	+1280	+768
00000608	+256	+256	+256	+128	+0	-64	-128	+64
00000610	+256	+448	+640	+576	-512	-768	+0	+0
00000618	+0	+0	+0	+0	+0	+0	+0	+0
00000620	+0	+0	+0	+0	+0	+0	+0	+0
00000628	+0	+0	+0	+0	+0	+0	+0	+0
00000630	+0	+0	+0	+0	+0	+0	+0	+0
00000638	+0	+0	+0	+0	+0	+0	+0	+0
00000640	-128	+64	+256	+64	-128	-128	-128	+0
00000648	+128	+64	+0	+0	+0	+0	+0	+0
00000650	+0	+0	+0	-64	-128	+192	+512	+128
00000658	-256	-192	-128	-64	+0	+384	-256	-64
00000660	+128	+0	-128	-64	+0	+0	+0	+0
00000668	+0	+0	+0	+0	+0	+0	+0	+0
00000670	+0	+64	+128	+64	+0	+0	+0	+0
00000678	+0	+0	+0	+0	+0	+0	+0	+0
00000680	+0	+0	+0	+0	+0	+0	+0	+0
00000688	+0	+0	+0	+0	+0	+0	+0	+0
00000690	+0	+0	+0	+0	+0	+0	+0	+0
00000698	+0	+0	+0	+0	+0	+64	+128	+0
000006A0	-128	+0	+128	+64	+0	+0	+0	+0
000006A8	+0	+0	+0	+0	+0	+0	+0	+0
000006B0	+0	+0	+0	+0	+0	+0	+0	+0
000006B8	+0	+0	+0	+0	+0	+0	+0	+0
000006C0	+0	+64	+128	+64	+0	+0	+0	+0
000006C8	+0	+0	+0	+0	+0	+0	+0	+0

000006D0	+0	+0	+0	+0	+0	+0	+0	+0
000006D8	+0	+0	+0	-64	-128	-128	-128	+0
000006E0	+128	-448	+0	+64	+128	+128	+128	+64
000006E8	+0	+64	+128	+64	+0	-64	-128	+128
000006F0	+384	+128	-128	-64	+0	+0	+0	+0
000006F8	+0	+0	+0	+0	+0	+0	+0	+0
00000700	+0	+0	+0	+0	+0	+0	+0	+0
00000708	+0	+0	+0	+0	+0	+0	+0	+0
00000710	+0	+0	+0	+0	+0	+0	+0	+0
00000718	+0	+0	+0	+0	+0	-64	-128	-64
00000720	+0	-512	+0	+64	+128	+128	+128	+128
00000728	+128	+64	+0	-128	-256	-320	-384	-192
00000730	+0	+0	+0	+0	+0	+0	+0	+0
00000738	+0	+0	+0	+0	+0	+0	+0	+0
00000740	+0	+0	+0	+0	+0	+0	+0	+0
00000748	+0	+0	+0	+0	+0	+0	+0	+0
00000750	+0	+0	+0	+0	+0	+0	+0	+0
00000758	+0	+0	+0	+0	+0	+0	+0	+0
00000760	+0	+0	+0	+0	+0	-128	+768	+0
00000768	+256	+640	+0	+0	+0	+0	+0	+0
00000770	+0	+0	+0	+0	+0	+0	+0	+0
00000778	+0	+0	+0	+0	+0	+0	+0	+0
00000780	+0	+0	+0	+0	+0	+0	+0	+0
00000788	+0	+0	+0	+0	+0	+0	+0	+0
00000790	+0	+0	+0	+0	+0	+0	+0	+0
00000798	+0	+0	+0	+0	+0	+0	+0	+0
000007A0	+0	+0	+0	+0	+0	+64	+128	-512
000007A8	-128	-64	+0	+0	+0	+0	+0	+0
000007B0	+0	+0	+0	+0	+0	+0	+0	+0
000007B8	+0	+0	+0	+0	+0	+0	+0	+0
000007C0	+0	+0	+0	+0	+0	+0	+0	+0
000007C8	+0	+0	+0	+0	+0	+0	+0	+0
000007D0	+0	+0	+0	+0	+0	+0	+0	+0
000007D8	+0	+0	+0	+0	+0	+0	+0	+0
000007E0	+0	+0	+0	+0	+0	+0	+0	+0
000007E8	+0	+0	+0	+0	+0	+0	+0	+0
000007F0	+0	+0	+0	+0	+0	+0	+0	+0
000007F8	+0	+0	+0	+0	+0	+0	+0	+0

4.2.4.3.3.7 Inverse DWT-Y (L0 – H0)

The following is a dump of the LL0 sub-band, as shown in the figure illustrating three-level DWT decomposition in section [3.1.8.1.4](#).

00000000	-32	+16	+64	+272	-32	-16	+0	-16
00000008	-32	-24	-16	-8	+0	-24	-48	-72
00000010	-96	-90	-84	-78	-72	-98	-124	-150
00000018	-176	-192	-208	-224	-240	-256	-272	-288
00000020	-304	-304	-304	-304	-304	-336	-368	-400
00000028	-432	-450	-468	-486	-504	-522	-540	-558
00000030	-576	-598	-620	-642	-664	-686	-708	-730
00000038	-752	-768	-784	-800	-816	-816	-816	-816
00000040	+68	+120	+172	+240	+53	+55	+57	+43
00000048	+30	+32	+34	+36	+38	+20	+2	-16
00000050	-34	-36	-38	-40	-42	-68	-94	-120
00000058	-146	-148	-151	-186	-220	-227	-233	-240
00000060	-247	-254	-261	-268	-275	-302	-329	-356

00000068	-384	-403	-423	-443	-463	-484	-506	-528
00000070	-550	-572	-594	-616	-639	-673	-707	-709
00000078	-712	-733	-754	-775	-796	-796	-796	-796
00000080	+168	+224	+281	+209	+138	+126	+115	+103
00000088	+92	+88	+84	+80	+76	+64	+52	+40
00000090	+28	+18	+8	-2	-12	-38	-64	-90
00000098	-116	-105	-95	-148	-201	-198	-195	-192
000000A0	-190	-204	-218	-232	-247	-269	-291	-313
000000A8	-336	-357	-379	-400	-422	-447	-473	-498
000000B0	-524	-546	-569	-591	-614	-660	-707	-689
000000B8	-672	-698	-724	-750	-776	-776	-776	-776
000000C0	+268	+312	+357	+273	+191	+181	+172	+162
000000C8	+154	+144	+134	+124	+114	+108	+102	+80
000000D0	+58	+56	+54	+52	+50	+24	-2	-44
000000D8	-86	-61	-38	-93	-149	-137	-124	-144
000000E0	-165	-170	-175	-196	-218	-235	-252	-269
000000E8	-288	-310	-334	-357	-381	-409	-439	-468
000000F0	-498	-520	-543	-565	-589	-647	-706	-668
000000F8	-632	-663	-694	-725	-756	-756	-756	-756
00000100	+368	+401	+434	+339	+244	+237	+230	+223
00000108	+216	+200	+184	+168	+152	+152	+152	+120
00000110	+88	+94	+100	+106	+112	+86	+60	+2
00000118	-56	-18	+19	-39	-98	-76	-55	-97
00000120	-140	-136	-133	-161	-190	-202	-215	-227
00000128	-240	-265	-290	-315	-340	-373	-406	-439
00000130	-472	-495	-518	-541	-564	-635	-706	-649
00000138	-592	-628	-664	-700	-736	-736	-736	-736
00000140	+404	+556	+454	+383	+313	+531	+239	+282
00000148	+326	+304	+282	+260	+238	+246	+254	+118
00000150	+238	+196	+154	+32	-90	-88	-86	+76
00000158	+238	+243	+247	+29	-191	-232	-272	-121
00000160	+29	-62	-153	-149	-145	-162	-180	-197
00000168	-216	-240	-265	-289	-315	-345	-376	-406
00000170	-438	-446	-456	-497	-539	-595	-653	-502
00000178	-608	-625	-642	-675	-708	-708	-708	-708
00000180	+440	+713	+475	+428	+382	+827	+249	+342
00000188	+436	+408	+380	+352	+324	+340	+356	-140
00000190	-124	+42	+208	+214	+220	+250	+280	+406
00000198	+532	+504	+476	+352	+229	+125	+22	-146
000001A0	-314	-244	-175	-138	-101	-123	-146	-169
000001A8	-192	-216	-241	-265	-290	-318	-347	-375
000001B0	-404	-399	-395	-454	-514	-557	-601	-356
000001B8	-624	-622	-620	-650	-680	-680	-680	-680
000001C0	+604	+677	+495	+457	+419	+770	+354	+386
000001C8	+418	+416	+414	+380	+346	+258	-342	-302
000001D0	-6	+288	+582	+604	+626	+588	+550	+688
000001D8	+826	+829	+833	+724	+616	+481	+348	+181
000001E0	+15	-139	-292	-175	-56	-83	-112	-139
000001E8	-168	-192	-216	-240	-265	-291	-317	-343
000001F0	-370	-351	-333	-411	-489	-486	-484	-402
000001F8	-576	-587	-598	-625	-652	-652	-652	-652
00000200	+1280	+1154	+1028	+998	+968	+970	+460	+430
00000208	+400	+424	+448	+408	+368	+432	-528	-208
00000210	+112	+534	+956	+994	+1032	+926	+820	+970
00000218	+1120	+1155	+1190	+1097	+1004	+839	+674	+509
00000220	+344	+223	+102	+45	-12	-45	-78	-111
00000228	-144	-168	-192	-216	-240	-264	-288	-312
00000230	-336	-304	-272	-368	-464	-416	-368	-448
00000238	-528	-552	-576	-600	-624	-624	-624	-624

00000240	+770	+671	+573	+554	+536	+629	+467	+464
00000248	+462	+492	+523	+490	+457	+281	-405	-101
00000250	+204	+599	+995	+1310	+1370	+1297	+1225	+1296
00000258	+1368	+1432	+1498	+1402	+1308	+1184	+1062	+874
00000260	+688	+586	+485	+303	+123	-82	-32	-76
00000268	-122	-174	-226	-199	-171	-193	-216	-238
00000270	-261	-314	-368	-325	-283	-360	-438	-451
00000278	-465	-515	-565	-583	-601	-617	-633	-633
00000280	+772	+701	+630	+623	+616	+545	+474	+499
00000288	+524	+561	+599	+572	+546	+131	-283	+6
00000290	+296	+665	+1034	+1627	+1708	+1669	+1630	+1623
00000298	+1616	+1711	+1806	+1709	+1612	+1531	+1450	+1241
000002A0	+1032	+950	+869	+563	+258	-120	+15	-42
000002A8	-100	-180	-261	-182	-103	-123	-144	-165
000002B0	-186	-325	-464	-283	-102	-305	-508	-455
000002B8	-402	-478	-554	-566	-578	-610	-642	-642
000002C0	+774	+730	+687	+675	+664	+620	+577	+581
000002C8	+586	+597	+610	+590	+571	-147	-96	+209
000002D0	+516	+794	+1073	+1575	+1822	+1976	+1875	+1869
000002D8	+1864	+1988	+2114	+2014	+1916	+1876	+1838	+1606
000002E0	+1376	+1266	+1156	+902	+137	-61	-3	-120
000002E8	-238	-122	-7	-69	-130	-164	-200	-219
000002F0	-239	-271	-304	-128	-209	-297	-386	-426
000002F8	-467	-937	-895	-549	-459	-667	-619	-619
00000300	+776	+760	+744	+728	+712	+696	+680	+664
00000308	+648	+635	+622	+609	+596	-425	+90	+413
00000310	+736	+924	+1112	+1524	+1936	+2284	+2120	+2116
00000318	+2112	+2267	+2422	+2321	+2220	+2223	+2226	+1973
00000320	+1720	+1582	+1444	+1242	+16	-2	-20	+58
00000328	+136	-65	-267	-212	-158	-207	-257	-274
00000330	-292	-218	-144	+26	-316	-290	-264	-142
00000338	-20	+2956	+2860	-788	-852	-980	-596	-596
00000340	+826	+807	+789	+770	+752	+749	+747	+744
00000348	+742	+677	+613	+516	+421	-285	+288	+573
00000350	+860	+1081	+1303	+1668	+2034	+2313	+2337	+2344
00000358	+2352	+2452	+2554	+2574	+2596	+2506	+2418	+2248
00000360	+2080	+1961	+1843	+925	+7	+40	+74	+748
00000368	+654	+453	+251	+48	-154	-107	-61	-111
00000370	-161	-28	+104	+45	-271	-274	-278	-842
00000378	+1411	+3007	+3323	+327	-1389	-1197	-493	-493
00000380	+876	+855	+834	+813	+792	+803	+814	+825
00000388	+836	+720	+605	+681	+758	+110	+487	+735
00000390	+984	+1239	+1494	+1813	+2132	+2343	+2554	+2573
00000398	+2592	+2639	+2686	+2829	+2972	+2791	+2610	+2525
000003A0	+2440	+2341	+2243	+608	-2	+83	+169	+1438
000003A8	+1172	+970	+768	+565	+363	+249	+135	+52
000003B0	-30	-95	-160	-193	-226	-259	-292	+763
000003B8	-742	+2290	+1738	-1118	-902	-902	-390	-390
000003C0	+926	+902	+879	+855	+832	+824	+817	+809
000003C8	+802	+763	+724	+397	+2375	+970	+589	+848
000003D0	+1108	+1396	+1685	+1941	+2198	+2468	+2739	+2785
000003D8	+2832	+2888	+2946	+3178	+2900	+3058	+2962	+2848
000003E0	+2736	+2896	+2546	-364	+309	+205	+871	+1760
000003E8	+1626	+1471	+1317	+1145	+975	+844	+714	+599
000003F0	+485	+351	+216	+146	+75	-355	+750	+2687
000003F8	+529	-1067	-615	-835	-799	-847	-383	-383
00000400	+976	+950	+924	+898	+872	+846	+820	+794
00000408	+768	+806	+844	+882	+1432	+2598	+692	+962
00000410	+1232	+1554	+1876	+2070	+2264	+2594	+2924	+2998

00000418	+3072	+3139	+3206	+3273	+2316	+3071	+3314	+3173
00000420	+3032	+2941	+1826	-57	+108	+73	+1574	+2083
00000428	+2080	+1973	+1866	+1727	+1588	+1441	+1294	+1147
00000430	+1000	+796	+592	+484	+376	+828	+256	+772
00000438	-248	-72	-408	+984	-184	-536	-376	-376
00000440	+1026	+997	+969	+941	+913	+888	+864	+840
00000448	+816	+762	+709	+768	+1339	+2269	+2176	+1411
00000450	+1414	+1677	+1941	+2188	+2436	+2730	+3023	+3157
00000458	+3291	+3349	+3409	+3420	+2152	+3000	+3594	+3403
00000460	+3213	+3233	+951	+12	+97	-303	+2883	+2755
00000468	+2373	+2312	+2252	+2143	+2036	+1861	+1687	+1544
00000470	+1403	+1254	+1106	+974	+842	+1229	+1105	+21
00000478	+217	+46	-381	+1912	+3181	+2765	+301	-723
00000480	+1076	+1045	+1015	+984	+954	+931	+909	+886
00000488	+864	+719	+575	+654	+1246	+1685	+3149	+1604
00000490	+1596	+1801	+2006	+2307	+2609	+2866	+3123	+3316
00000498	+3510	+3561	+3613	+3568	+1988	+2931	+3875	+3634
000004A0	+3394	+3527	+76	+81	+86	+859	+3168	+2917
000004A8	+2666	+2652	+2639	+2561	+2484	+2282	+2081	+1943
000004B0	+1806	+1713	+1621	+1464	+1308	+1119	+931	+550
000004B8	+170	-92	-354	+1560	+3986	+1970	-558	-558
000004C0	+1126	+1092	+1060	+1027	+995	+973	+953	+932
000004C8	+912	+899	+888	-340	+1249	+1756	+2521	+2421
000004D0	+1810	+2036	+2263	+2521	+2781	+3066	+3350	+3443
000004D8	+3537	+3612	+3688	+3476	+2496	+3021	+3803	+3833
000004E0	+3863	+2843	+33	+133	-21	+2099	+3197	+3061
000004E8	+2927	+2944	+2961	+2882	+2804	+2607	+2410	+2309
000004F0	+2209	+2139	+2071	+1842	+1614	+1328	+1044	+663
000004F8	+283	+10	-263	-488	-201	-201	-457	-457
00000500	+1176	+1141	+1106	+1071	+1036	+1017	+998	+979
00000508	+960	+825	+690	+203	+740	+1573	+1894	+3239
00000510	+2024	+2272	+2521	+2737	+2954	+3010	+3067	+3315
00000518	+3564	+3664	+3764	+3384	+3004	+3112	+3732	+3776
00000520	+3820	+1905	-10	+187	-128	+3341	+3226	+3207
00000528	+3188	+3236	+3284	+3204	+3124	+2932	+2740	+2676
00000530	+2612	+2567	+2522	+2221	+1920	+1539	+1158	+777
00000538	+396	+112	-172	-488	-292	-324	-356	-356
00000540	+1194	+1162	+1131	+1099	+1069	+1047	+1026	+972
00000548	+920	+969	+507	+380	+767	+1428	+1834	+2799
00000550	+2486	+2347	+2721	+2919	+3118	+3290	+3462	+3266
00000558	+3071	+3157	+3243	+3521	+3800	+3674	+3548	+3710
00000560	+3873	+874	+179	+91	+517	+3439	+3291	+3333
00000568	+3377	+3403	+3430	+3361	+3292	+3174	+3057	+3004
00000570	+2951	+2761	+2572	+2222	+1874	+1554	+1235	+883
00000578	+533	+220	-93	-470	-335	-319	-303	-303
00000580	+1212	+1184	+1157	+1129	+1102	+1078	+1055	+967
00000588	+880	+1114	+325	+559	+794	+1284	+1775	+2361
00000590	+2948	+2423	+2923	+3103	+3283	+3314	+3346	+3474
00000598	+3602	+3674	+3747	+3659	+3572	+3980	+3877	+3901
000005A0	+3926	-157	+368	+253	+1674	+3795	+3356	+3461
000005A8	+3566	+3571	+3577	+3518	+3460	+3417	+3375	+3332
000005B0	+3290	+2956	+2623	+2225	+1828	+1570	+1313	+991
000005B8	+670	+328	-14	-452	-378	-314	-250	-250
000005C0	+1230	+1206	+1182	+1158	+1135	+1109	+1083	+1025
000005C8	+968	+779	+78	+481	+885	+1284	+1939	+2466
000005D0	+3250	+2626	+2772	+3157	+3543	+3514	+3486	+3729
000005D8	+3717	+3775	+3834	+3780	+3728	+3934	+3885	+3915
000005E0	+2667	+92	+333	+173	+2831	+3701	+3549	+3587
000005E8	+3627	+3642	+3659	+3643	+3628	+3675	+3724	+3436

000005F0	+3149	+2847	+2545	+2275	+2006	+1730	+1454	+1114
000005F8	+775	+388	+1	-402	-293	-309	-325	-325
00000600	+1248	+1228	+1208	+1188	+1168	+1140	+1112	+1084
00000608	+1056	+700	+344	+660	+976	+1284	+2104	+2316
00000610	+3040	+2319	+2110	+2189	+2268	+2691	+3114	+3729
00000618	+3832	+3877	+3922	+3903	+3884	+3889	+3894	+3931
00000620	+1408	+341	+298	+95	+3988	+3609	+3742	+3715
00000628	+3688	+3715	+3742	+3769	+3796	+3679	+3562	+3285
00000630	+3008	+2738	+2468	+2326	+2184	+1890	+1596	+1238
00000638	+880	+448	+16	-352	-208	-304	-400	-400
00000640	+1296	+1284	+1272	+1260	+1249	+1165	+1081	+1093
00000648	+1106	+232	+382	+677	+971	+973	+1232	+834
00000650	+693	+537	+639	+564	+490	+563	+637	-106
00000658	+944	+2358	+3773	+3795	+4074	+3964	+3855	+4337
00000660	+212	+204	+197	+1341	+4023	+3813	+3860	+3810
00000668	+3762	+3766	+3771	+3776	+3781	+3603	+3427	+3201
00000670	+2977	+2838	+2699	+2400	+2101	+1982	+1607	+1280
00000678	+954	+545	-120	-321	-266	-314	-362	-362
00000680	+1344	+1340	+1337	+1333	+1330	+1190	+1051	+1103
00000688	+1156	+20	+933	+950	+967	+919	+872	+889
00000690	+906	+805	+705	+733	+761	+740	+720	+668
00000698	+616	+328	+40	+1640	+3752	+3784	+3816	+3208
000006A0	+40	+581	+97	+2589	+4058	+4018	+3979	+3907
000006A8	+3836	+3818	+3801	+3784	+3767	+3529	+3292	+3375
000006B0	+3458	+3706	+3954	+3754	+3555	+2843	+1619	+1067
000006B8	+516	+386	-256	-290	-324	-324	-324	-324
000006C0	+1392	+1364	+1337	+1309	+1283	+1247	+1212	+968
000006C8	+982	+1424	+1099	+1079	+1058	+1072	+1088	+815
000006D0	+799	+1056	+802	+772	+743	+645	+547	+769
000006D8	+736	+649	+563	+332	+102	+1939	+4033	+1982
000006E0	+444	+332	-36	+4076	+4093	+4047	+4001	+3955
000006E8	+3910	+3870	+3830	+3791	+3752	+3806	+3861	+3835
000006F0	+3811	+3678	+3545	+3380	+3216	+3639	+3806	+2341
000006F8	+1134	+1091	+24	-387	-286	-286	-286	-286
00000700	+1440	+1389	+1338	+1287	+1236	+1305	+1374	+1091
00000708	+1320	+1037	+1267	+1208	+1150	+715	+281	+486
00000710	+1204	+1564	+901	+1325	+1750	+1830	+1911	+1383
00000718	+344	+459	+574	+817	+548	+351	+666	+757
00000720	+336	+340	+856	+4028	+4128	+4076	+4024	+4004
00000728	+3984	+3922	+3861	+3799	+3738	+3828	+3919	+3785
00000730	+3652	+3394	+3137	+3007	+2878	+2900	+2923	+3105
00000738	+3800	+1284	+1328	+28	-248	-248	-248	-248
00000740	+1456	+1406	+1358	+1309	+1261	+1209	+1159	+1444
00000748	+1218	+1265	+33	-654	-1342	-977	-356	+394
00000750	+1401	+1753	+1338	+1738	+2140	+2575	+3009	+3524
00000758	+3784	+2536	+1033	+265	+522	+440	+615	+629
00000760	+388	+403	+2211	+4051	+4099	+4078	+4058	+3990
00000768	+3922	+3910	+3898	+3886	+3875	+3805	+3735	+3553
00000770	+3373	+3126	+2879	+2585	+2291	+2026	+1762	+2649
00000778	+3026	+2303	+2092	+665	-250	-250	-250	-250
00000780	+1472	+1425	+1379	+1332	+1286	+1371	+1457	+1030
00000788	-932	-1834	-1712	-1237	-763	-621	+33	+815
00000790	+1598	+1943	+1776	+2153	+2531	+2808	+3085	+3362
00000798	+3640	+4102	+4052	+3042	+496	+530	+564	+502
000007A0	+440	+211	+3055	+3818	+4070	+4081	+4093	+3976
000007A8	+3860	+3898	+3936	+3974	+4013	+3783	+3553	+3323
000007B0	+3094	+2858	+2623	+2420	+2217	+1921	+1626	+915
000007B8	+2764	+250	+296	+22	-252	-252	-252	-252
000007C0	+1488	+1443	+1399	+1371	+1343	+1308	+1530	-408

000007C8	-1834	-1589	-1089	-811	-535	-281	+485	+1171
000007D0	+1859	+2132	+2150	+2503	+2857	+3105	+3352	+3536
000007D8	+3720	+3875	+3775	+4298	+4054	+2123	+449	+502
000007E0	+556	+546	+26	+2113	+3945	+4115	+4031	+3946
000007E8	+3862	+3838	+3814	+3982	+3894	+3488	+3338	+3140
000007F0	+2943	+2622	+2302	+2030	+1758	+1495	+1234	+1259
000007F8	+774	-347	-188	-189	-190	-222	-254	-254
00000800	+1504	+1462	+1420	+1410	+1400	+1246	+1604	-1334
00000808	-1712	-1089	-978	-643	-308	+59	+938	+1529
00000810	+2120	+2322	+2524	+2854	+3184	+3402	+3620	+3710
00000818	+3800	+3905	+4010	+4019	+4028	+3973	+334	+503
00000820	+672	+627	+582	+409	+236	+2359	+3970	+3917
00000828	+3864	+3778	+3692	+3990	+3776	+3194	+3124	+2958
00000830	+2792	+2387	+1982	+1641	+1300	+1071	+842	+69
00000838	-192	-176	-160	-144	-128	-192	-256	-256
00000840	+1546	+1496	+1447	+1430	+1413	+1627	+1330	-2102
00000848	-1184	-819	-712	-395	-80	+405	+1148	+1713
00000850	+2280	+2486	+2692	+2995	+3297	+3467	+3638	+3712
00000858	+3787	+3915	+4045	+3917	+4047	+3097	+357	+655
00000860	+699	+198	+466	+381	+297	+376	+200	+1815
00000868	+3431	+3568	+3961	+4114	+3755	+3310	+3121	+2804
00000870	+2487	+2208	+1931	+1189	+447	+37	-116	-254
00000878	-136	-111	-86	-109	-132	-196	-260	-260
00000880	+1588	+1531	+1475	+1450	+1426	+1497	+33	-1591
00000888	-1168	-807	-446	-149	+148	+753	+1358	+1899
00000890	+2440	+2650	+2861	+3136	+3411	+3533	+3656	+3715
00000898	+3774	+3927	+4080	+3817	+4066	+2223	+380	+553
000008A0	+214	+3610	+350	+354	+358	+442	+526	+226
000008A8	-74	+286	+1158	+1678	+1686	+1634	+1582	+1114
000008B0	+646	+239	-168	-31	+107	-228	-51	-65
000008B8	-80	-46	-12	-74	-136	-200	-264	-264
000008C0	+1630	+1565	+1502	+1470	+1439	+1590	-817	-1399
000008C8	-960	-633	-308	-14	+280	+875	+1472	+1971
000008D0	+2472	+2718	+2965	+3229	+3492	+3582	+3674	+3701
000008D8	+3729	+3793	+3859	+4147	+4181	+707	+563	+417
000008E0	+1297	+3917	+4234	+2198	+163	+267	+372	+348
000008E8	+325	+108	+147	+186	-31	+38	+107	+96
000008F0	+85	+61	+38	-162	-106	-126	+111	+876
000008F8	-152	-93	-34	-87	-140	-204	-268	-268
00000900	+1672	+1601	+1530	+1491	+1452	+1685	-1666	-1209
00000908	-752	-461	-170	+121	+412	+999	+1586	+2045
00000910	+2504	+2787	+3071	+3322	+3574	+3633	+3693	+3688
00000918	+3684	+3661	+3638	+3711	+2760	+473	+746	+283
00000920	+2380	+4225	+4022	+4043	+4064	+2141	+218	+215
00000928	+212	+186	+160	+230	+300	+234	+168	+102
00000930	+36	-117	-269	+218	+1218	+2025	+2833	+1048
00000938	-224	-140	-56	-100	-144	-208	-272	-272
00000940	+1626	+1607	+1589	+1458	+1585	+692	-1479	-1107
00000948	-736	-451	-168	+115	+400	+805	+1468	+1937
00000950	+2408	+2703	+2999	+3327	+3655	+3568	+3482	+3620
00000958	+3759	+3439	+3121	+1601	+851	+819	+533	+437
00000960	+3415	+4252	+4066	+4055	+4045	+4084	+4124	+2995
00000968	+1867	+1068	+269	+62	-145	-38	+69	+704
00000970	+1339	+2183	+3028	+2816	+2861	+2953	+2790	-349
00000978	+96	-19	-134	-137	-140	-204	-268	-268
00000980	+1580	+1614	+1649	+1427	+1718	-300	-1293	-1006
00000988	-720	-443	-166	+111	+388	+613	+1350	+1831
00000990	+2312	+2620	+2928	+3076	+3225	+3249	+3273	+3297
00000998	+3322	+3475	+3628	+3333	+1502	+655	+832	+593

000009A0	+3938	+4024	+4110	+4068	+4026	+3980	+3934	+3984
000009A8	+4034	+3998	+3962	+3990	+4018	+3786	+3554	+3610
000009B0	+3666	+3459	+3253	+3111	+2969	+2858	+2236	-210
000009B8	-96	-154	-212	-174	-136	-200	-264	-264
000009C0	+1662	+1653	+1644	+1619	+1851	-988	-1266	-985
000009C8	-704	-401	-100	+9	+120	+403	+944	+1579
000009D0	+2216	+2504	+2793	+2873	+2954	+2976	+2999	+3085
000009D8	+3173	+3237	+3303	+3575	+521	+553	+587	+1771
000009E0	+3981	+4019	+4058	+4032	+4007	+3971	+3936	+3948
000009E8	+3961	+3920	+3879	+3806	+3989	+3866	+3743	+3636
000009F0	+3529	+3375	+3222	+3069	+2916	+2907	+1362	-119
000009F8	-64	-113	-162	-147	-132	-196	-260	-260
00000A00	+1744	+1692	+1640	+1556	+1472	-1932	-1240	-964
00000A08	-688	-361	-34	+165	+364	+707	+1050	+1585
00000A10	+2120	+2389	+2658	+2671	+2684	+2705	+2726	+2875
00000A18	+3024	+3001	+2978	+2283	+564	+965	+342	+2951
00000A20	+4024	+4015	+4006	+3997	+3988	+3963	+3938	+3913
00000A28	+3888	+3842	+3796	+3622	+3960	+3946	+3932	+3662
00000A30	+3392	+3292	+3192	+3028	+2864	+2956	+488	-28
00000A38	-32	-72	-112	-120	-128	-192	-256	-256
00000A40	+1834	+1635	+1692	+1718	+208	-1663	-1229	-924
00000A48	-619	-283	+50	+256	+719	+705	+948	+1126
00000A50	+1562	+1845	+2129	+2236	+2344	+2447	+2551	+2654
00000A58	+2759	+2738	+2719	+1562	+663	+623	+327	+4207
00000A60	+3992	+4012	+4034	+3990	+3948	+3922	+3898	+3872
00000A68	+3848	+3774	+3701	+3484	+3523	+3726	+3929	+3812
00000A70	+3695	+3604	+3513	+3407	+3300	+3350	-440	-231
00000A78	-22	-48	-74	-100	-126	-174	-222	-222
00000A80	+1924	+1578	+1745	+1880	-1057	-1394	-1219	-884
00000A88	-550	-207	+135	+93	+563	+449	+847	+669
00000A90	+1004	+1302	+1600	+1802	+2005	+2191	+2377	+2435
00000A98	+2494	+2477	+2460	+843	+763	+794	+1337	+3928
00000AA0	+3960	+4011	+4062	+3985	+3908	+3883	+3858	+3833
00000AA8	+3808	+3707	+3607	+3603	+3599	+3506	+3414	+3706
00000AB0	+3998	+3916	+3835	+3786	+3737	+2208	-345	+78
00000AB8	-12	-24	-36	-80	-124	-156	-188	-188
00000AC0	+1598	+1585	+1829	+2154	-1873	-1413	-1208	-556
00000AC8	-417	-514	-102	+440	+214	+191	+681	+435
00000AD0	+702	+870	+1039	+1224	+1409	+1709	+2010	+2039
00000AD8	+2069	+2086	+1849	+795	+766	+596	+2474	+3953
00000AE0	+3896	+3928	+3962	+3914	+3868	+3842	+3818	+3792
00000AE8	+3768	+3687	+3608	+3577	+3546	+3462	+3379	+3312
00000AF0	+3245	+3364	+3484	+3189	+2893	+858	-154	+35
00000AF8	-34	-48	-62	-108	-154	-154	-154	-154
00000B00	+1784	+1849	+1915	+892	-1666	-1176	-1711	-741
00000B08	-796	-822	+175	-748	+378	+191	+517	+202
00000B10	+400	+439	+479	+646	+814	+1229	+1645	+1644
00000B18	+1644	+1697	+1239	+748	+770	+399	+3613	+3978
00000B20	+3832	+3847	+3862	+3845	+3828	+3803	+3778	+3753
00000B28	+3728	+3669	+3611	+3552	+3494	+3419	+3345	+3174
00000B30	+3004	+2813	+2623	+2592	+2562	-237	+37	-9
00000B38	-56	-72	-88	-136	-184	-152	-120	-120
00000B40	+1802	+1900	+2255	-286	-1290	-1129	-712	-391
00000B48	-327	-385	-445	+201	-178	+436	+27	-45
00000B50	-118	+204	+270	+384	+498	+685	+874	+998
00000B58	+1123	+1252	+1127	+794	+717	+1161	+3654	+3843
00000B60	+3776	+3788	+3802	+3782	+3764	+3616	+3726	+3690
00000B68	+3656	+3595	+3536	+3476	+3417	+3341	+3265	+3078
00000B70	+2891	+2687	+2484	+2617	+1982	-28	+8	+14

00000B78	+18	-18	-54	+6	+66	-30	-126	-126
00000B80	+1820	+1696	+2084	-2232	-1939	-570	-1762	-1834
00000B88	-1394	-461	-552	-387	-223	-1110	-462	-37
00000B90	-124	-31	-451	-134	+183	+143	+104	+353
00000B98	+602	+809	+1017	+841	+665	+1924	+3696	+3708
00000BA0	+3720	+3731	+3742	+3721	+3700	+3431	+3674	+3629
00000BA8	+3584	+3523	+3462	+3401	+3341	+3264	+3187	+2982
00000BB0	+2778	+2562	+2346	+2386	+891	-77	-20	+36
00000BB8	+92	+36	-20	-108	-196	-164	-132	-132
00000BC0	+1710	+1955	+1177	-2833	-955	-2075	-2172	-364
00000BC8	-1885	-1352	-820	-1599	-843	-1249	-887	-652
00000BD0	-674	-554	-435	-636	-325	-304	-282	-101
00000BD8	-175	+493	+906	+871	+580	+2767	+3674	+3653
00000BE0	+3632	+3656	+3682	+3626	+3572	+3436	+3558	+3534
00000BE8	+3512	+3449	+3388	+3325	+3264	+3186	+3108	+2902
00000BF0	+2697	+2500	+2304	+2219	+343	+179	+271	+154
00000BF8	+38	-6	-50	-110	-170	-154	-138	-138
00000C00	+1600	+1959	-242	-2667	-2020	-2557	-2582	-1455
00000C08	+696	+316	+960	+2052	+2120	+1940	+1760	+1292
00000C10	+824	-310	-932	-1394	-832	-750	-668	-298
00000C18	-440	+434	+796	+902	+496	+3610	+3652	+3598
00000C20	+3544	+3583	+3622	+3533	+3444	+3443	+3442	+3441
00000C28	+3440	+3377	+3314	+3251	+3188	+3109	+3030	+2823
00000C30	+2616	+2439	+2262	+2053	-204	+179	+50	+17
00000C38	-16	-48	-80	-112	-144	-144	-144	-144
00000C40	+1956	+1852	-2091	-3025	-1145	+322	+2045	+1672
00000C48	+1555	+1328	+1614	+1916	+1706	+1622	+1282	+1502
00000C50	+1466	+1301	+1393	+940	-792	-1548	-768	-820
00000C58	-617	+926	+934	+909	+1397	+3323	+3456	+3446
00000C60	+3436	+3393	+3351	+3388	+3426	+3373	+3321	+3444
00000C68	+3313	+3264	+3217	+3153	+3090	+2997	+2906	+2686
00000C70	+2467	+2290	+2115	+1282	-61	+136	+79	+36
00000C78	-5	-37	-69	-101	-133	-133	-133	-133
00000C80	+1800	+1746	+669	+1992	+1779	+1665	+1552	+1727
00000C88	+1390	+1317	+1245	+1269	+1293	+1560	+1316	+1456
00000C90	+1084	+1121	+1158	+971	+1297	+726	-869	-1343
00000C98	-794	+1419	+1072	+917	+2299	+3036	+3261	+3294
00000CA0	+3328	+3204	+3080	+3244	+3409	+3305	+3201	+3449
00000CA8	+3186	+3153	+3121	+3056	+2992	+2887	+2783	+2550
00000CB0	+2318	+2143	+1968	+513	+82	+95	+108	+57
00000CB8	+6	-26	-58	-90	-122	-122	-122	-122
00000CC0	+1516	+1832	+1636	+1905	+1406	+1344	+1283	+1589
00000CC8	+1641	+1465	+1291	+1277	+1263	+1386	+1254	+1314
00000CD0	+1118	+1116	+1115	+905	+953	+1160	+1111	+118
00000CD8	-363	+807	+698	+700	+2240	+3325	+2361	+2934
00000CE0	+3252	+2998	+2745	+2924	+3103	+3155	+2952	+3277
00000CE8	+3091	+3057	+3024	+2959	+2894	+2776	+2659	+2414
00000CF0	+2169	+2074	+1981	+255	+65	+68	+73	+44
00000CF8	+17	-15	-47	-79	-111	-111	-111	-111
00000D00	+1744	+1662	+1581	+1563	+1546	+1536	+1527	+1453
00000D08	+1380	+1359	+1339	+1286	+1234	+1213	+1193	+1172
00000D10	+1152	+1112	+1073	+1097	+1122	+826	+1043	+1067
00000D18	+1092	+964	+837	+741	+2182	+2078	+2487	+2831
00000D20	+2664	+2793	+2923	+2860	+2798	+3007	+2705	+3106
00000D28	+2996	+2962	+2928	+2862	+2796	+2666	+2536	+2278
00000D30	+2020	+1751	+1482	-259	+48	+43	+38	+33
00000D38	+28	-4	-36	-68	-100	-100	-100	-100
00000D40	+1684	+1640	+1596	+1584	+1573	+1543	+1513	+1451
00000D48	+1391	+1359	+1329	+1282	+1236	+1213	+1190	+1168

0000D50	+1146	+1107	+1069	+1063	+1058	+920	+1038	+996
0000D58	+955	+924	+894	+880	+1635	+1679	+2235	+2439
0000D60	+2132	+2451	+2771	+2580	+2644	+2713	+2528	+2742
0000D68	+2701	+2828	+2699	+2570	+2442	+2383	+2324	+2105
0000D70	+1887	+1732	+811	-79	+55	+62	+71	+46
0000D78	+23	-7	-37	-67	-97	-113	-129	-129
0000D80	+1624	+1618	+1612	+1606	+1601	+1551	+1501	+1451
0000D88	+1402	+1361	+1320	+1279	+1239	+1214	+1189	+1164
0000D90	+1140	+1103	+1067	+1031	+995	+1014	+1034	+926
0000D98	+818	+885	+953	+1021	+1089	+1024	+1472	+2048
0000DA0	+2112	+2110	+2109	+2044	+2491	+2421	+2352	+2379
0000DA8	+2406	+2694	+2471	+2279	+2088	+2100	+2113	+1933
0000DB0	+1754	+1715	+140	+101	+62	+83	+104	+61
0000DB8	+18	-10	-38	-66	-94	-126	-158	-158
0000DC0	+1724	+1788	+1852	+1692	+1532	+1494	+1456	+1418
0000DC8	+1381	+1345	+1311	+1275	+1241	+1214	+1187	+1160
0000DD0	+1134	+1098	+1064	+1029	+995	+996	+998	+935
0000DD8	+873	+877	+883	+792	+702	+657	+1125	+1832
0000DE0	+2284	+1193	+1638	+1796	+2209	+2320	+2176	+2239
0000DE8	+2047	+2560	+2562	+1891	+1734	+1673	+1613	+1744
0000DF0	+1621	+1152	-83	-8	+69	+70	+73	+42
0000DF8	+13	-13	-39	-65	-91	-139	-187	-187
0000E00	+1824	+1702	+1580	+1522	+1464	+1438	+1412	+1386
0000E08	+1360	+1331	+1302	+1273	+1244	+1215	+1186	+1157
0000E10	+1128	+1095	+1062	+1029	+996	+979	+962	+945
0000E18	+928	+871	+814	+821	+828	+803	+1290	+1617
0000E20	+1944	+2068	+1168	+1292	+1416	+1708	+1488	+1844
0000E28	+1688	+2171	+2142	+1249	+1380	+1503	+1626	+1045
0000E30	-48	+79	+206	+141	+76	+59	+42	+25
0000E38	+8	-16	-40	-64	-88	-152	-216	-216
0000E40	+1688	+1615	+1542	+1501	+1460	+1429	+1398	+1367
0000E48	+1336	+1309	+1284	+1257	+1232	+1205	+1180	+1153
0000E50	+1128	+1092	+1058	+1022	+988	+968	+950	+930
0000E58	+912	+861	+812	+793	+776	+595	+672	+971
0000E60	+1272	+330	+924	+1038	+1152	+1298	+1444	+1910
0000E68	+1608	+1531	+1200	+515	+344	+259	+176	+251
0000E70	+72	+122	+174	+128	+84	+64	+46	+26
0000E78	+8	-18	-44	-70	-96	-144	-192	-192
0000E80	+1552	+1528	+1504	+1480	+1456	+1420	+1384	+1348
0000E88	+1312	+1289	+1266	+1243	+1220	+1197	+1174	+1151
0000E90	+1128	+1091	+1054	+1017	+980	+959	+938	+917
0000E98	+896	+853	+810	+767	+724	+645	+566	+583
0000EA0	+600	+640	+680	+528	+376	+376	+888	+1464
0000EA8	+1016	+637	+258	+295	+332	+297	+262	+227
0000EB0	+192	+167	+142	+117	+92	+71	+50	+29
0000EB8	+8	-20	-48	-76	-104	-136	-168	-168
0000EC0	+1544	+1521	+1498	+1475	+1452	+1411	+1370	+1329
0000EC8	+1288	+1267	+1248	+1227	+1208	+1187	+1168	+1147
0000ED0	+1128	+1088	+1050	+1010	+972	+948	+926	+902
0000ED8	+880	+843	+808	+771	+736	+677	+620	+609
0000EE0	+600	+614	+628	+546	+464	+238	+2060	+1690
0000EE8	+1576	+1709	+308	+313	+320	+285	+252	+217
0000EF0	+184	+162	+142	+120	+100	+76	+54	+30
0000EF8	+8	-22	-52	-82	-112	-128	-144	-144
0000F00	+1536	+1514	+1492	+1470	+1448	+1402	+1356	+1310
0000F08	+1264	+1247	+1230	+1213	+1196	+1179	+1162	+1145
0000F10	+1128	+1087	+1046	+1005	+964	+939	+914	+889
0000F18	+864	+835	+806	+777	+748	+711	+674	+637
0000F20	+600	+588	+576	+564	+552	+612	+160	+1916

00000F28	+1112	+223	+358	+333	+308	+275	+242	+209
00000F30	+176	+159	+142	+125	+108	+83	+58	+33
00000F38	+8	-24	-56	-88	-120	-120	-120	-120
00000F40	+1536	+1514	+1492	+1470	+1448	+1402	+1356	+1310
00000F48	+1264	+1246	+1230	+1212	+1196	+1178	+1162	+1144
00000F50	+1128	+1086	+1046	+1004	+964	+938	+914	+888
00000F58	+864	+834	+806	+776	+748	+710	+674	+636
00000F60	+600	+588	+576	+564	+552	+644	+480	+108
00000F68	+504	+158	+326	+316	+308	+274	+242	+208
00000F70	+176	+158	+142	+124	+108	+82	+58	+32
00000F78	+8	-24	-56	-88	-120	-120	-120	-120
00000F80	+1536	+1514	+1492	+1470	+1448	+1402	+1356	+1310
00000F88	+1264	+1247	+1230	+1213	+1196	+1179	+1162	+1145
00000F90	+1128	+1087	+1046	+1005	+964	+939	+914	+889
00000F98	+864	+835	+806	+777	+748	+711	+674	+637
00000FA0	+600	+588	+576	+564	+552	+420	+288	+348
00000FA8	+408	+351	+294	+301	+308	+275	+242	+209
00000FB0	+176	+159	+142	+125	+108	+83	+58	+33
00000FB8	+8	-24	-56	-88	-120	-120	-120	-120
00000FC0	+1536	+1514	+1492	+1470	+1448	+1402	+1356	+1310
00000FC8	+1264	+1246	+1230	+1212	+1196	+1178	+1162	+1144
00000FD0	+1128	+1086	+1046	+1004	+964	+938	+914	+888
00000FD8	+864	+834	+806	+776	+748	+710	+674	+636
00000FE0	+600	+588	+576	+564	+552	+420	+288	+348
00000FE8	+408	+350	+294	+300	+308	+274	+242	+208
00000FF0	+176	+158	+142	+124	+108	+82	+58	+32
00000FF8	+8	-24	-56	-88	-120	-120	-120	-120

4.2.4.3.4 Reconstructed Y Component

The reconstructed Y component is the same as the LL0 band shown in section [4.2.4.3.3.7](#).

4.2.4.3.5 Reconstructed Cb Component

The following is a dump of the reconstructed Cb component. All the coefficients are displayed in 11.5 fixed-point representation.

00000000	+1728	+1730	+1732	+1734	+1736	+1738	+1740	+1742
00000008	+1744	+1740	+1736	+1732	+1728	+1796	+1864	+1804
00000010	+1744	+1754	+1764	+1774	+1784	+1794	+1804	+1814
00000018	+1824	+1774	+1724	+1802	+1880	+1814	+1748	+1810
00000020	+1872	+1878	+1884	+1890	+1896	+1910	+1924	+1938
00000028	+1952	+1938	+1924	+1910	+1896	+1914	+1932	+1950
00000030	+1968	+1974	+1980	+1986	+1992	+1998	+2004	+2010
00000038	+2016	+2016	+2016	+2016	+2016	+2016	+2016	+2016
00000040	+1710	+1697	+1684	+1704	+1723	+1726	+1730	+1733
00000048	+1737	+1738	+1740	+1741	+1743	+1758	+1774	+1757
00000050	+1741	+1762	+1783	+1788	+1793	+1774	+1755	+1784
00000058	+1813	+1817	+1821	+1825	+1829	+1857	+1885	+1881
00000060	+1877	+1849	+1821	+1857	+1894	+1904	+1914	+1924
00000068	+1935	+1928	+1922	+1915	+1909	+1922	+1936	+1949
00000070	+1963	+1974	+1985	+1997	+2008	+2009	+2011	+2012
00000078	+2014	+2017	+2020	+2023	+2026	+2026	+2026	+2026
00000080	+1692	+1664	+1637	+1674	+1711	+1715	+1720	+1725
00000088	+1730	+1737	+1744	+1751	+1758	+1721	+1684	+1711
00000090	+1738	+1770	+1802	+1802	+1802	+1754	+1706	+1754

00000098	+1802	+1860	+1918	+1848	+1778	+1900	+2022	+1952
000000A0	+1882	+1820	+1759	+1825	+1892	+1898	+1905	+1911
000000A8	+1918	+1919	+1920	+1921	+1922	+1931	+1940	+1949
000000B0	+1958	+1974	+1991	+2008	+2025	+2021	+2018	+2015
000000B8	+2012	+2018	+2024	+2030	+2036	+2036	+2036	+2036
000000C0	+1674	+1631	+1589	+1644	+1698	+1703	+1710	+1716
000000C8	+1723	+1735	+1748	+1760	+1773	+1763	+1754	+1760
000000D0	+1767	+1794	+1821	+1800	+1779	+1830	+1881	+1900
000000D8	+1919	+2047	+2175	+2015	+1855	+1879	+1903	+1927
000000E0	+1951	+1759	+1824	+1856	+1890	+1892	+1895	+1897
000000E8	+1901	+1909	+1918	+1926	+1935	+1939	+1944	+1948
000000F0	+1953	+1974	+1996	+2019	+2041	+2032	+2025	+2017
000000F8	+2010	+2019	+2028	+2037	+2046	+2046	+2046	+2046
00000100	+1656	+1599	+1543	+1614	+1686	+1693	+1701	+1708
00000108	+1716	+1734	+1752	+1770	+1788	+1806	+1824	+1810
00000110	+1796	+1818	+1840	+2054	+2268	+1650	+1032	+510
00000118	-12	-70	-128	+390	+908	+1602	+2296	+2158
00000120	+2020	+1699	+1890	+1889	+1888	+1887	+1886	+1885
00000128	+1884	+1900	+1916	+1932	+1948	+1948	+1948	+1948
00000130	+1948	+1975	+2003	+2030	+2058	+2045	+2033	+2020
00000138	+2008	+2020	+2032	+2044	+2056	+2056	+2056	+2056
00000140	+1590	+1570	+1551	+1612	+1673	+1579	+1742	+1713
00000148	+1685	+1672	+1660	+1711	+1763	+1694	+1626	+1941
00000150	+2001	+2060	+583	-654	-1891	-2046	-2201	-2084
00000158	-1967	-2049	-2131	-2053	-1975	-1751	-1527	+41
00000160	+1609	+2374	+1859	+2000	+1886	+1898	+1912	+1909
00000168	+1907	+1900	+1894	+1919	+1945	+1944	+1944	+1943
00000170	+1943	+1967	+1992	+2017	+2042	+2032	+2023	+2014
00000178	+2006	+2017	+2028	+2039	+2050	+2050	+2050	+2050
00000180	+1524	+1542	+1560	+1610	+1661	+1467	+1785	+1719
00000188	+1654	+1611	+1568	+1653	+1738	+1839	+1940	+793
00000190	-866	-2050	-2210	-2082	-1954	-1902	-1850	-1862
00000198	-1874	-1980	-2086	-1936	-1786	-1776	-1766	-1820
000001A0	-1874	-534	+1829	+2112	+1884	+1911	+1939	+1934
000001A8	+1930	+1901	+1872	+1907	+1942	+1941	+1940	+1939
000001B0	+1938	+1960	+1982	+2004	+2027	+2021	+2015	+2009
000001B8	+2004	+2014	+2024	+2034	+2044	+2044	+2044	+2044
000001C0	+1586	+1641	+1697	+1704	+1712	+1577	+1699	+1660
000001C8	+1623	+1613	+1604	+1642	+1681	+1791	-402	-2036
000001D0	-1877	-2144	-1899	-1942	-1985	-1918	-1851	-1880
000001D8	-1909	-1959	-2009	-1931	-1853	-1801	-1749	-1617
000001E0	-1485	-1939	-1882	+96	+2074	+1971	+1869	+1895
000001E8	+1921	+1885	+1850	+1894	+1939	+1937	+1936	+1934
000001F0	+1933	+1952	+1972	+1991	+2011	+2008	+2006	+2003
000001F8	+2002	+2011	+2020	+2029	+2038	+2038	+2038	+2038
00000200	+1136	+1229	+1322	+1287	+1252	+1433	+1614	+1603
00000208	+1592	+1616	+1640	+1632	+1624	+2256	-1720	-1792
00000210	-1864	-1982	-2100	-2058	-2016	-1934	-1852	-1898
00000218	-1944	-1938	-1932	-1926	-1920	-1826	-1732	-1670
00000220	-1608	-1552	-1496	-1664	-1320	+2288	+1800	+1856
00000228	+1912	+1870	+1828	+1882	+1936	+1934	+1932	+1930
00000230	+1928	+1945	+1962	+1979	+1996	+1997	+1998	+1999
00000238	+2000	+2008	+2016	+2024	+2032	+2032	+2032	+2032
00000240	+1552	+1624	+1698	+1674	+1652	+1644	+1638	+1614
00000248	+1592	+1611	+1630	+1681	+1733	+1146	-2000	-1787
00000250	-1830	-1924	-2019	-2049	-2080	-1986	-1893	-1895
00000258	-1898	-1896	-1894	-1860	-1827	-1779	-1731	-1667
00000260	-1604	-1615	-1626	-1878	-594	+2063	+1903	+2016
00000268	+1873	+2132	+1880	+1884	+1888	+1921	+1955	+1941

00000270	+1927	+1925	+1925	+1955	+1987	+2005	+2025	+2043
00000278	+2063	+1995	+1927	+2099	+2015	+2095	+2175	+2175
00000280	+1456	+1509	+1562	+1551	+1540	+1601	+1662	+1627
00000288	+1592	+1606	+1621	+1731	+1842	+37	+2281	-1782
00000290	-1796	-1867	-1938	-2041	-2144	-2039	-1934	-1893
00000298	-1852	-1854	-1857	-1795	-1734	-1732	-1731	-1665
000002A0	-1600	-1678	-1757	-1836	+645	+2094	+2007	+1920
000002A8	+1322	+2139	+1933	+1886	+1840	+1909	+1979	+1952
000002B0	+1926	+1907	+1888	+1933	+1978	+2015	+2052	+2089
000002B8	+2126	+1982	+1838	+2174	+1998	+2158	+2318	+2318
000002C0	+1488	+1520	+1554	+1554	+1556	+1588	+1622	+1606
000002C8	+1592	+1569	+1547	+1700	+1855	-993	-2049	-1825
000002D0	-1858	-1905	-1953	-2016	-2080	-1995	-1911	-1858
000002D8	-1806	-1812	-1819	-1729	-1641	-1685	-1730	-1678
000002E0	-1628	-1677	-1727	-2194	+1947	+2125	+2046	+945
000002E8	-2205	+114	+2177	+2144	+1856	+1912	+1970	+1963
000002F0	+1957	+1935	+1915	+1925	+1937	+1991	+2047	+2181
000002F8	+2061	+2337	+2613	+1817	+2301	+2157	+2269	+2397
00000300	+1520	+1533	+1546	+1559	+1572	+1577	+1582	+1587
00000308	+1592	+1533	+1474	+1671	+1868	-2023	-1818	-1869
00000310	-1920	-1944	-1968	-1992	-2016	-1952	-1888	-1824
00000318	-1760	-1771	-1782	-1665	-1548	-1639	-1730	-1693
00000320	-1656	-1677	-1699	-1017	+2226	+1644	+2087	-286
00000328	-2148	-2167	-1674	+611	+2384	+2173	+1962	+1975
00000330	+1988	+1965	+1942	+1919	+1896	+1969	+2042	+2019
00000338	+1484	-1916	-1220	+2484	+1068	-916	+1708	+1964
00000340	+1504	+1514	+1526	+1536	+1548	+1550	+1554	+1556
00000348	+1560	+1581	+1604	+1786	+689	-2138	-1894	-1905
00000350	-1918	-1926	-1935	-1943	-1952	-1878	-1805	-1731
00000358	-1658	-1626	-1596	-1549	-1503	-1507	-1513	-1518
00000360	-1524	-1526	-1785	+148	+2080	+1995	+2422	-2094
00000368	-2003	-2033	-1809	-1665	-1776	-189	+1398	+2536
00000370	+2139	+2122	+2105	+2327	+2295	+2204	+2113	+2870
00000378	-213	-1669	-1077	-1237	-1653	-1589	+2059	+1931
00000380	+1488	+1497	+1506	+1515	+1524	+1525	+1526	+1527
00000388	+1528	+1631	+1735	+1902	-490	-2254	-1971	-1943
00000390	-1916	-1909	-1902	-1895	-1888	-1805	-1722	-1639
00000398	-1556	-1483	-1411	-1434	-1458	-1377	-1297	-1344
000003A0	-1392	-1376	-1872	+1312	+1935	+1834	+1734	-2622
000003A8	-2370	-2157	-1945	-1892	-1840	-2039	-2239	-2022
000003B0	-782	-281	+220	+433	+134	-377	-888	-1655
000003B8	-1398	-1166	-934	-1374	-1302	-726	+2410	+1898
000003C0	+1472	+1478	+1486	+1492	+1500	+1498	+1498	+1496
000003C8	+1496	+1600	+1705	+1666	-933	-1474	-2015	-1964
000003D0	-1914	-1891	-1869	-1846	-1824	-1731	-1639	-1546
000003D8	-1454	-1387	-1321	-1191	-1317	-1150	-1240	-1250
000003E0	-1260	-1545	-1575	+2459	+1885	+2057	+182	-2429
000003E8	-2225	-2088	-1952	-1928	-1904	-1905	-1907	-2149
000003F0	-1879	-1835	-1793	-1670	-1803	-1645	-1489	-1491
000003F8	-1239	-1335	-1431	-1335	-1495	+681	+2345	+2089
00000400	+1456	+1461	+1466	+1471	+1476	+1473	+1470	+1467
00000408	+1464	+1570	+1676	+1174	-1888	-950	-2060	-1986
00000410	-1912	-1874	-1836	-1798	-1760	-1658	-1556	-1454
00000418	-1352	-1292	-1232	-1204	-1688	-1180	-1184	-1156
00000420	-1128	-1203	-254	+2071	+1836	+2281	-1370	-2237
00000428	-2080	-2020	-1960	-1964	-1968	-2028	-2088	-2020
00000430	-1952	-1855	-1758	-1725	-1692	-1635	-1578	-1329
00000438	-1592	-1504	-1416	-1040	-1688	+2088	+2280	+2280
00000440	+1428	+1438	+1450	+1460	+1472	+1463	+1454	+1493

00000448	+1533	+1512	+1748	-160	-2068	-1346	-1137	-1775
00000450	-1902	-1848	-1794	-1708	-1622	-1544	-1466	-1356
00000458	-1247	-1198	-1149	-1196	-1755	-1246	-993	-1012
00000460	-1032	-1202	+930	+2023	+1837	+2238	-2480	-2286
00000468	-1838	-1799	-1761	-1835	-1909	-1954	-2000	-1982
00000470	-1964	-1908	-1853	-1829	-1807	-1749	-1692	-1538
00000478	-1642	-1526	-1410	-638	-122	+774	+1926	+1926
00000480	+1400	+1417	+1434	+1451	+1469	+1454	+1439	+1520
00000488	+1602	+1455	+1820	-1239	-1737	-1743	-726	-1821
00000490	-1892	-1822	-1752	-1618	-1485	-1431	-1377	-1259
00000498	-1142	-1104	-1066	-1188	-1823	-1313	-803	-869
000004A0	-936	-1203	+2115	+1976	+1838	+916	-2055	-1569
000004A8	-1596	-1579	-1563	-1706	-1850	-1881	-1913	-1944
000004B0	-1976	-1962	-1949	-1935	-1922	-1864	-1807	-1749
000004B8	-1692	-1548	-1404	-1004	-92	+996	+2084	+2084
000004C0	+1372	+1394	+1418	+1441	+1465	+1444	+1423	+1483
000004C8	+1543	+1765	+1732	-2204	-1533	-1611	-1179	-1274
000004D0	-1882	-1764	-1646	-1560	-1475	-1301	-1127	-1113
000004D8	-1101	-994	-887	-1052	-1730	-1395	-804	-709
000004E0	-872	-306	+2051	+1929	+2063	-151	-1597	-1347
000004E8	-1354	-1326	-1300	-1417	-1535	-1599	-1665	-1730
000004F0	-1796	-1824	-1852	-1880	-1909	-1883	-1857	-1767
000004F8	-1678	-1570	-1462	-1434	+1154	+2402	+1858	+1858
00000500	+1344	+1373	+1403	+1432	+1462	+1435	+1409	+1446
00000508	+1484	+1564	+621	-1890	-1842	-1737	-1633	-728
00000510	-1872	-1706	-1541	-1503	-1466	-1428	-1391	-1225
00000518	-1060	-884	-709	-917	-1638	-1478	-807	-551
00000520	-808	+590	+1988	+1882	+2288	-1218	-1140	-1126
00000528	-1112	-1075	-1038	-1129	-1220	-1319	-1418	-1517
00000530	-1616	-1686	-1756	-1826	-1896	-1902	-1908	-1786
00000538	-1664	-1592	-1520	-1864	+2400	+2016	+2144	+2144
00000540	+1348	+1372	+1398	+1424	+1450	+1463	+1477	+1491
00000548	+1505	+1729	-607	-1838	-1790	-1735	-1681	-1003
00000550	-1350	-1710	-1558	-1519	-1480	-1382	-1285	-1379
00000558	-1475	-1208	-941	-611	-793	-796	-800	-611
00000560	-680	+1364	+1872	+1932	+1481	-1150	-966	-926
00000568	-886	-868	-851	-929	-1009	-1061	-1114	-1230
00000570	-1348	-1521	-1695	-1805	-1915	-1900	-1886	-1792
00000578	-1698	-1604	-1766	-744	+2326	+2134	+2198	+2198
00000580	+1352	+1373	+1395	+1417	+1439	+1492	+1546	+1536
00000588	+1526	+1894	-1835	-1787	-1739	-1735	-1731	-1279
00000590	-828	-1714	-1577	-1536	-1495	-1337	-1180	-1023
00000598	-866	-764	-663	-562	-973	-371	-282	-417
000005A0	-552	+2138	+1757	+1983	+674	-1083	-793	-726
000005A8	-660	-662	-665	-731	-798	-804	-811	-945
000005B0	-1080	-1357	-1635	-1784	-1934	-1899	-1865	-1798
000005B8	-1732	-1616	-2012	+376	+2252	+2252	+2252	+2252
000005C0	+1356	+1373	+1391	+1409	+1427	+1425	+1423	+1501
000005C8	+1579	+907	-1814	-1702	-1847	-1909	-1716	-1634
000005D0	-786	-1686	-1819	-1712	-1605	-1371	-1139	-921
000005D8	-705	-656	-608	-384	-416	-233	-308	-477
000005E0	+376	+1968	+1769	+2033	-5	-839	-651	-606
000005E8	-562	-584	-606	-660	-715	-739	-763	-963
000005F0	-1164	-1432	-1702	-1843	-1985	-1977	-1971	-1884
000005F8	-1798	-2012	-2226	+2152	+2178	+2194	+2210	+2210
00000600	+1360	+1374	+1388	+1402	+1416	+1358	+1300	+1466
00000608	+1632	-81	-1794	-1619	-1956	-2085	-1702	-1991
00000610	-744	-891	-526	-353	-180	-383	-586	-821
00000618	-1056	-805	-554	-463	-372	-353	-334	-539

00000620	+1304	+1799	+1782	+2085	-684	-597	-510	-487
00000628	-464	-506	-548	-590	-632	-674	-716	-982
00000630	-1248	-1509	-1770	-1903	-2036	-2057	-2078	-1971
00000638	-1864	-1896	-1416	+2392	+2104	+2136	+2168	+2168
00000640	+1346	+1358	+1371	+1383	+1396	+1395	+1393	+1552
00000648	+1711	-1177	-1762	-2203	-1364	-465	+690	+1942
00000650	+1913	+1747	+1837	+1816	+1794	+1889	+1983	+1774
00000658	+1564	+548	-468	-299	-386	-391	-398	-147
00000660	+1895	+1920	+1946	+1284	-401	-397	-393	-421
00000668	-450	-478	-507	-568	-629	-722	-815	-1068
00000670	-1321	-1697	-2074	-2082	-2091	-2129	-2168	-2030
00000678	-1894	-2028	+142	+2280	+2114	+2082	+2050	+2050
00000680	+1332	+1343	+1354	+1365	+1377	+1432	+1487	+1382
00000688	+1278	-1763	-195	+1308	+1788	+1667	+1547	+1522
00000690	+1498	+1569	+1641	+1681	+1721	+1600	+1480	+1552
00000698	+1624	+1901	+2179	+1145	-401	-431	-462	-12
000006A0	+1974	+1786	+2111	+484	-119	-198	-277	-356
000006A8	-436	-451	-467	-547	-627	-770	-914	-898
000006B0	-882	-606	-330	-470	-611	-1435	-2259	-2091
000006B8	-1924	-2160	+1700	+2168	+2124	+2028	+1932	+1932
000006C0	+1318	+1327	+1337	+1346	+1357	+1405	+1452	+1420
000006C8	+1389	+1381	+1629	+1748	+1356	+1495	+1635	+1631
000006D0	+1627	+1551	+1732	+1689	+1647	+1728	+1809	+1730
000006D8	+1652	+1686	+1721	+1948	+1921	+874	-430	+363
000006E0	+1925	+1764	+1859	+148	-28	-95	-160	-291
000006E8	-422	-423	-426	-557	-688	-370	-309	-280
000006F0	-251	-570	-890	-858	-826	-563	-301	-1079
000006F8	-1858	-1636	+2170	+2296	+2166	+2118	+2070	+2070
00000700	+1304	+1312	+1321	+1329	+1338	+1378	+1419	+1459
00000708	+1500	+1452	+1404	+1420	+1436	+1580	+1724	+1484
00000710	+1244	+1022	+1313	+1187	+1062	+1088	+1115	+1397
00000718	+1680	+1728	+1777	+1729	+1682	+1922	+1651	+1763
00000720	+1876	+1742	+1609	-189	+62	+8	-45	-226
00000728	-408	-397	-387	-568	-750	-227	-217	-430
00000730	-644	-1047	-1451	-1502	-1554	-1229	-905	-580
00000738	-256	-856	+1616	+1912	+2208	+2208	+2208	+2208
00000740	+1290	+1304	+1319	+1334	+1350	+1377	+1404	+1271
00000748	+1395	+1525	+1655	+1769	+1884	+1802	+1720	+1430
00000750	+1141	+1026	+1168	+1037	+908	+700	+491	+331
00000758	+172	+873	+1575	+1524	+1731	+1991	+1738	+1774
00000760	+1811	+1914	+993	-119	+48	-74	-196	-271
00000768	-346	-407	-470	-324	-179	-213	-503	-810
00000770	-1117	-1273	-1430	-1636	-1841	-1823	-1551	-1246
00000778	-686	+1194	+1026	+1610	+2194	+2194	+2194	+2194
00000780	+1276	+1297	+1319	+1341	+1363	+1376	+1390	+1340
00000788	+1802	+1854	+1907	+1863	+1820	+1768	+1717	+1377
00000790	+1038	+1031	+1024	+889	+755	+568	+381	+290
00000798	+200	+19	-162	+553	+1781	+2060	+1827	+1786
000007A0	+1746	+2086	+378	-50	+35	-156	-348	-316
000007A8	-284	-419	-554	-337	-121	-456	-791	-934
000007B0	-1078	-1244	-1411	-1514	-1617	-1907	-1686	-1657
000007B8	-1116	+1964	+1972	+2076	+2180	+2180	+2180	+2180
000007C0	+1262	+1289	+1318	+1346	+1375	+1359	+1344	+1632
000007C8	+1921	+1927	+1934	+1876	+1820	+1702	+1585	+1259
000007D0	+935	+907	+880	+724	+569	+436	+302	+217
000007D8	+132	+44	-43	-99	+102	+801	+2011	+1878
000007E0	+1745	+1426	+2131	+916	-43	-191	-340	-393
000007E8	-446	-461	-478	-237	-254	-522	-790	-962
000007F0	-1135	-1519	-1647	-1760	-1872	-1446	-2045	-1827

000007F8	-1354	+2254	+2278	+2222	+2166	+2166	+2166	+2166
00000800	+1248	+1283	+1318	+1353	+1388	+1343	+1298	+1925
00000808	+2040	+2001	+1962	+1891	+1820	+1637	+1454	+1143
00000810	+832	+784	+736	+560	+384	+304	+224	+144
00000818	+64	+70	+76	+18	-40	+54	+1684	+1714
00000820	+1744	+1790	+1836	+1882	+1928	+798	-332	-470
00000828	-608	-505	-402	-139	-388	-589	-790	-991
00000830	-1192	-1794	-1884	-2006	-2128	-2266	-868	+818
00000838	+2504	+2288	+2072	+2112	+2152	+2152	+2152	+2152
00000840	+1238	+1263	+1290	+1332	+1375	+1301	+1484	+2002
00000848	+2009	+1973	+1939	+1871	+1805	+1608	+1411	+1118
00000850	+826	+751	+676	+505	+334	+273	+212	+151
00000858	+91	+69	+48	+11	-26	+482	+1758	+1771
00000860	+1784	+2033	+1771	+1860	+1950	+1989	+2029	+884
00000868	-260	-1156	-261	-309	-614	-922	-975	-1411
00000870	-1848	-2062	-2019	-697	+626	+2060	+2471	+2273
00000878	+2076	+2051	+2026	+2081	+2136	+2136	+2136	+2136
00000880	+1228	+1245	+1263	+1313	+1363	+1260	+1670	+2080
00000888	+1978	+1947	+1916	+1853	+1791	+1580	+1369	+1094
00000890	+820	+718	+616	+450	+285	+243	+201	+159
00000898	+118	+69	+20	+4	-13	+910	+1833	+1828
000008A0	+1824	+229	+1706	+1839	+1972	+1901	+1830	+1983
000008A8	+2136	+2032	+1416	+1056	+696	+280	+376	+728
000008B0	+1080	+1767	+2454	+2405	+2356	+2035	+2226	+2193
000008B8	+2160	+2070	+1980	+2050	+2120	+2120	+2120	+2120
000008C0	+1218	+1226	+1235	+1292	+1350	+1235	+1888	+2061
000008C8	+1979	+1935	+1893	+1834	+1776	+1551	+1326	+1070
000008D0	+814	+685	+556	+395	+235	+212	+189	+166
000008D8	+145	+116	+88	-68	+33	+1306	+1811	+1949
000008E0	+1576	-200	-183	+905	+1994	+1956	+1919	+1881
000008E8	+1844	+2004	+1909	+2005	+2102	+2042	+2239	+2195
000008F0	+2152	+2043	+1935	+2370	+2038	+2697	+1821	+368
000008F8	+2244	+2121	+1998	+2051	+2104	+2104	+2104	+2104
00000900	+1208	+1208	+1209	+1273	+1338	+1210	+2107	+2043
00000908	+1980	+1925	+1871	+1816	+1762	+1523	+1285	+1046
00000910	+808	+652	+497	+341	+186	+182	+179	+175
00000918	+172	+164	+157	+117	+590	+1958	+1791	+1815
00000920	+816	+140	-24	-28	-32	+988	+2008	+2036
00000928	+2064	+1977	+1890	+1931	+1972	+2013	+2054	+2127
00000930	+2200	+2320	+2440	+2080	+184	-1760	-3192	+336
00000938	+2328	+2172	+2016	+2052	+2088	+2088	+2088	+2088
00000940	+1222	+1215	+1209	+1266	+1325	+1459	+2104	+2046
00000948	+1989	+1945	+1903	+1861	+1819	+1612	+1406	+1136
00000950	+866	+715	+564	+446	+328	+295	+263	+230
00000958	+199	+481	+764	+711	+1427	+2086	+1721	+1692
00000960	+128	-37	+55	-14	-82	-108	-135	+335
00000968	+804	+1293	+1783	+2272	+2250	+2197	+1889	+1356
00000970	+568	-763	-2095	-3010	-2646	-2931	-2705	+2305
00000978	+2196	+2159	+2122	+2117	+2112	+2112	+2112	+2112
00000980	+1236	+1223	+1210	+1261	+1313	+1708	+2103	+2050
00000988	+1998	+1967	+1937	+1907	+1877	+1702	+1528	+1226
00000990	+924	+778	+633	+552	+471	+409	+348	+287
00000998	+226	+287	+349	+283	+1241	+1702	+1652	+1826
000009A0	-48	+43	+134	+1	-132	-181	-230	-343
000009A8	-456	-670	-884	-202	-544	-946	-1860	-1718
000009B0	-2088	-2311	-2534	-2469	-2404	-2311	-1706	+2483
000009B8	+2064	+2146	+2228	+2182	+2136	+2136	+2136	+2136
000009C0	+1250	+1230	+1211	+1255	+1300	+1957	+2101	+2054
000009C8	+2007	+1956	+1906	+1856	+1806	+1696	+1586	+1284

000009D0	+982	+841	+701	+657	+613	+554	+497	+438
000009D8	+381	+412	+445	+717	+1758	+1782	+1807	+1095
000009E0	-128	-70	-11	-97	-182	-253	-325	-428
000009E8	-532	-761	-991	-580	-170	-1033	-873	-1976
000009F0	-1800	-2018	-2237	-2343	-2450	-2650	-35	+2308
000009F8	+2092	+2117	+2142	+2151	+2160	+2160	+2160	+2160
00000A00	+1264	+1238	+1212	+1250	+1288	+2206	+2100	+2058
00000A08	+2016	+1946	+1876	+1806	+1736	+1690	+1644	+1342
00000A10	+1040	+905	+770	+763	+756	+701	+646	+591
00000A18	+536	+539	+542	+897	+1764	+1607	+1962	+365
00000A20	-208	-182	-156	-194	-232	-326	-420	-514
00000A28	-608	-853	-1098	-1471	-820	-97	-910	-955
00000A30	-2024	-2238	-2452	-2474	-2496	-2990	+1636	+2134
00000A38	+2120	+2088	+2056	+2120	+2184	+2184	+2184	+2184
00000A40	+1198	+1191	+1185	+1227	+1525	+2065	+2093	+2009
00000A48	+1925	+1887	+1850	+1781	+1712	+1682	+1653	+1464
00000A50	+1275	+1130	+986	+937	+889	+840	+792	+743
00000A58	+696	+684	+674	+1335	+1741	+1839	+1939	+54
00000A60	-294	-295	-297	-298	-300	-414	-527	-641
00000A68	-755	-947	-1140	-1732	-1813	-733	-166	-1038
00000A70	-887	-1234	-1581	-1609	-1636	-1158	+2392	+2279
00000A78	+2166	+2119	+2072	+2121	+2170	+2170	+2170	+2170
00000A80	+1132	+1145	+1159	+1205	+1763	+1924	+2086	+1960
00000A88	+1834	+1829	+1825	+1756	+1688	+1675	+1663	+1586
00000A90	+1510	+1356	+1202	+1112	+1023	+981	+939	+897
00000A98	+856	+831	+807	+1774	+1718	+1817	+1405	-512
00000AA0	-380	-409	-438	-403	-369	-502	-635	-768
00000AA8	-902	-1042	-1182	-1482	-1782	-2138	-1982	-610
00000AB0	-262	-486	-711	-744	-777	+162	+2125	+1912
00000AB8	+2212	+2150	+2088	+2122	+2156	+2156	+2156	+2156
00000AC0	+1194	+1146	+1100	+1182	+1776	+1927	+2079	+1863
00000AC8	+1903	+1978	+1799	+1843	+1632	+1619	+1608	+1612
00000AD0	+1617	+1517	+1418	+1351	+1284	+1216	+1149	+1098
00000AD8	+1048	+945	+1099	+1781	+1695	+1954	+422	-566
00000AE0	-530	-554	-579	-571	-565	-686	-806	-927
00000AE8	-1049	-1232	-1416	-1679	-1943	-2342	-2486	-2501
00000AF0	-2773	-2074	-1376	-1671	-2221	+458	+2369	+2137
00000AF8	+2162	+2133	+2104	+2123	+2142	+2142	+2142	+2142
00000B00	+1256	+1149	+1043	+1160	+1790	+1931	+2073	+1766
00000B08	+1972	+2129	+1774	+1931	+1576	+1565	+1554	+1639
00000B10	+1724	+1679	+1635	+1590	+1546	+1453	+1361	+1300
00000B18	+1240	+1060	+1392	+1788	+1672	+2092	-560	-620
00000B20	-680	-700	-721	-741	-762	-870	-979	-1087
00000B28	-1196	-1423	-1650	-1877	-2104	-2291	-2478	-2857
00000B30	-2724	-2895	-3067	-3110	-3666	+2547	+2103	+2107
00000B38	+2112	+2116	+2120	+2124	+2128	+2128	+2128	+2128
00000B40	+1214	+1170	+1128	+1453	+1779	+1692	+1861	+1807
00000B48	+1753	+1732	+1712	+1803	+1640	+1759	+1623	+1710
00000B50	+1799	+1666	+1790	+1755	+1719	+1628	+1539	+1497
00000B58	+1456	+1352	+1504	+1752	+1745	+1445	-902	-898
00000B60	-894	-907	-921	-935	-950	-1070	-1190	-1310
00000B68	-1431	-1641	-1852	-2062	-2273	-2431	-2590	-2812
00000B70	-2779	-2929	-3080	-3279	-2198	+2298	+2187	+2124
00000B78	+2062	+2081	+2100	+2119	+2138	+2138	+2138	+2138
00000B80	+1172	+1193	+1214	+1747	+1769	+1710	+2163	+2360
00000B88	+2046	+1592	+1651	+1677	+1704	+1954	+1693	+1783
00000B90	+1874	+1654	+1947	+1920	+1893	+1805	+1718	+1695
00000B98	+1672	+1644	+1617	+1717	+1818	+798	-1245	-1176
00000BA0	-1108	-1115	-1123	-1131	-1139	-1270	-1402	-1534

00000BA8	-1666	-1860	-2054	-2248	-2442	-2572	-2702	-2768
00000BB0	-2834	-2964	-3094	-3192	-219	+2306	+2272	+2142
00000BB8	+2012	+2046	+2080	+2114	+2148	+2148	+2148	+2148
00000BC0	+1194	+1150	+1364	+1784	+1694	+1983	+2272	+1441
00000BC8	+2147	+1980	+1813	+1838	+1864	+1909	+1698	+1823
00000BD0	+1949	+1818	+1943	+1989	+2034	+1933	+1833	+1812
00000BD8	+1792	+1712	+1633	+1649	+1923	-536	-1459	-1390
00000BE0	-1322	-1354	-1388	-1421	-1455	-1566	-1678	-1789
00000BE8	-1901	-2078	-2256	-2433	-2611	-2744	-2878	-2915
00000BF0	-2953	-2998	-3044	-3777	+1633	+2298	+1941	+2015
00000BF8	+2090	+2107	+2124	+2141	+2158	+2158	+2158	+2158
00000C00	+1216	+1109	+1514	+1823	+1620	+2001	+1870	+1803
00000C08	+1224	+1600	+1464	+1232	+1000	+1096	+1192	+1352
00000C10	+1512	+1726	+1940	+2058	+2176	+2062	+1948	+1930
00000C18	+1912	+1781	+1650	+1583	+2028	-1871	-1674	-1605
00000C20	-1536	-1595	-1654	-1713	-1772	-1863	-1954	-2045
00000C28	-2136	-2297	-2458	-2619	-2780	-2917	-3054	-3063
00000C30	-3072	-3033	-2994	-2827	+2460	+2035	+2122	+2145
00000C38	+2168	+2168	+2168	+2168	+2168	+2168	+2168	+2168
00000C40	+1190	+1271	+1610	+1756	+1647	+1523	+1144	+1324
00000C48	+1249	+1364	+1224	+1211	+1199	+1255	+1566	+1430
00000C50	+1294	+1404	+1514	+1800	+2087	+2075	+2063	+2003
00000C58	+1944	+1654	+1621	+1811	+979	-1997	-1903	-1888
00000C60	-1874	-1927	-1982	-2036	-2091	-2163	-2236	-2308
00000C68	-2381	-2513	-2646	-2778	-2911	-3005	-3100	-3114
00000C70	-3129	-3039	-3206	-1084	+2317	+2104	+2148	+2159
00000C78	+2171	+2175	+2179	+2183	+2187	+2187	+2187	+2187
00000C80	+1164	+1179	+1195	+1179	+1163	+1302	+1442	+1358
00000C88	+1274	+1385	+1496	+1447	+1399	+1158	+1429	+1508
00000C90	+1588	+1594	+1601	+1543	+1486	+1832	+2179	+2077
00000C98	+1976	+1528	+1593	+1785	-582	-2381	-2133	-2172
00000CA0	-2212	-2261	-2311	-2361	-2411	-2464	-2518	-2572
00000CA8	-2626	-2730	-2834	-2938	-3042	-3094	-3146	-3166
00000CB0	-3186	-3046	-3418	+658	+2174	+2174	+2174	+2174
00000CB8	+2174	+2182	+2190	+2198	+2206	+2206	+2206	+2206
00000CC0	+1202	+1230	+1259	+1272	+1286	+1321	+1356	+1343
00000CC8	+1331	+1405	+1480	+1474	+1470	+1349	+1483	+1522
00000CD0	+1562	+1576	+1591	+1573	+1557	+1589	+1622	+1718
00000CD8	+1816	+1690	+1820	+1694	-2015	-2556	-2330	-2376
00000CE0	-2422	-2610	-2799	-2700	-2602	-2669	-2736	-2803
00000CE8	-2871	-2946	-3022	-3097	-3173	-3182	-3192	-3153
00000CF0	-3115	-3324	-3278	+2256	+2159	+2147	+2136	+2156
00000CF8	+2177	+2189	+2201	+2213	+2225	+2225	+2225	+2225
00000D00	+1240	+1282	+1325	+1367	+1410	+1340	+1271	+1329
00000D08	+1388	+1426	+1465	+1503	+1542	+1540	+1539	+1537
00000D10	+1536	+1559	+1582	+1605	+1628	+1603	+1578	+1617
00000D18	+1656	+1596	+1536	+1604	-2936	-2476	-2528	-2580
00000D20	-2632	-2704	-2777	-2785	-2794	-2874	-2955	-3035
00000D28	-3116	-3163	-3210	-3257	-3304	-3271	-3238	-3141
00000D30	-3044	-3091	-2114	+2319	+2144	+2121	+2098	+2139
00000D38	+2180	+2196	+2212	+2228	+2244	+2244	+2244	+2244
00000D40	+1230	+1255	+1281	+1306	+1333	+1303	+1272	+1338
00000D48	+1405	+1436	+1468	+1500	+1533	+1535	+1537	+1539
00000D50	+1542	+1562	+1584	+1605	+1627	+1601	+1577	+1616
00000D58	+1656	+1807	+1959	-417	-2793	-2797	-2545	-2581
00000D60	-2618	-2687	-2757	-2794	-2833	-2901	-2968	-3036
00000D68	-3105	-3145	-3186	-3178	-3171	-3149	-3128	-3058
00000D70	-2989	-3221	-126	+2281	+2129	+2084	+2040	+2107
00000D78	+2175	+2189	+2203	+2217	+2231	+2231	+2231	+2231

0000D80	+1220	+1229	+1238	+1247	+1257	+1266	+1275	+1348
0000D88	+1422	+1447	+1473	+1499	+1525	+1530	+1536	+1542
0000D90	+1548	+1567	+1587	+1606	+1626	+1601	+1577	+1616
0000D98	+1656	+1763	+1871	+1658	-2138	-2862	-2563	-2583
0000DA0	-2604	-2671	-2738	-2805	-2873	-2928	-2983	-3038
0000DA8	-3094	-3128	-3162	-3100	-3038	-3028	-3018	-2976
0000DB0	-2934	-3352	+1862	+2244	+2114	+2048	+1982	+2076
0000DB8	+2170	+2182	+2194	+2206	+2218	+2218	+2218	+2218
0000DC0	+1210	+1234	+1259	+1283	+1308	+1325	+1341	+1390
0000DC8	+1439	+1457	+1477	+1496	+1516	+1525	+1535	+1544
0000DD0	+1554	+1571	+1589	+1607	+1625	+1616	+1608	+1632
0000DD8	+1656	+1718	+1782	+1685	+1845	+528	-2836	-2728
0000DE0	-2622	-2654	-2687	-2719	-2752	-2763	-2773	-2992
0000DE8	-2955	-3030	-3106	-2813	-2777	-3226	-2908	-3134
0000DF0	-3359	-971	+2186	+2270	+2099	+2075	+2052	+2108
0000DF8	+2165	+2175	+2185	+2195	+2205	+2205	+2205	+2205
0000E00	+1200	+1240	+1280	+1320	+1360	+1384	+1408	+1432
0000E08	+1456	+1469	+1482	+1495	+1508	+1521	+1534	+1547
0000E10	+1560	+1576	+1592	+1608	+1624	+1632	+1640	+1648
0000E18	+1656	+1675	+1694	+1713	+1732	+1871	+986	-827
0000E20	-2640	-2638	-2636	-2634	-2632	-2598	-2564	-2946
0000E28	-2816	-2933	-3050	-2783	-3028	-3169	-1774	+293
0000E30	+2360	+2179	+1998	+2041	+2084	+2103	+2122	+2141
0000E38	+2160	+2168	+2176	+2184	+2192	+2192	+2192	+2192
0000E40	+1232	+1266	+1300	+1334	+1368	+1390	+1412	+1434
0000E48	+1456	+1468	+1482	+1494	+1508	+1520	+1534	+1546
0000E50	+1560	+1578	+1596	+1614	+1632	+1640	+1648	+1656
0000E58	+1664	+1645	+1628	+1705	+1784	+2101	+1908	+1298
0000E60	+688	+1071	-594	-1587	-2580	-2891	-3202	-2281
0000E68	-2640	-2058	-1476	-94	+1032	+2278	+2244	+2209
0000E70	+2176	+2131	+2088	+2091	+2096	+2111	+2128	+2143
0000E78	+2160	+2168	+2176	+2184	+2192	+2192	+2192	+2192
0000E80	+1264	+1292	+1320	+1348	+1376	+1396	+1416	+1436
0000E88	+1456	+1469	+1482	+1495	+1508	+1521	+1534	+1547
0000E90	+1560	+1580	+1600	+1620	+1640	+1648	+1656	+1664
0000E98	+1672	+1617	+1562	+1699	+1836	+1821	+1806	+1887
0000EA0	+1968	+1964	+1960	+2020	+2080	+1936	+1792	+1200
0000EA8	+1632	+1889	+2146	+2083	+2020	+2093	+2166	+2079
0000EB0	+1992	+2085	+2178	+2143	+2108	+2121	+2134	+2147
0000EB8	+2160	+2168	+2176	+2184	+2192	+2192	+2192	+2192
0000EC0	+1296	+1318	+1340	+1362	+1384	+1402	+1420	+1438
0000EC8	+1456	+1468	+1482	+1494	+1508	+1520	+1534	+1546
0000ED0	+1560	+1582	+1604	+1626	+1648	+1656	+1664	+1672
0000ED8	+1680	+1667	+1656	+1739	+1824	+1811	+1800	+1835
0000EE0	+1872	+1881	+1890	+1819	+1748	+1995	+450	+937
0000EE8	+912	+715	+2056	+2019	+1984	+2035	+2088	+2059
0000EF0	+2032	+2085	+2140	+2129	+2120	+2129	+2140	+2149
0000EF8	+2160	+2168	+2176	+2184	+2192	+2192	+2192	+2192
0000F00	+1328	+1344	+1360	+1376	+1392	+1408	+1424	+1440
0000F08	+1456	+1469	+1482	+1495	+1508	+1521	+1534	+1547
0000F10	+1560	+1584	+1608	+1632	+1656	+1664	+1672	+1680
0000F18	+1688	+1719	+1750	+1781	+1812	+1803	+1794	+1785
0000F20	+1776	+1798	+1820	+1874	+1928	+1798	+2180	+674
0000F28	+1216	+2103	+1966	+1957	+1948	+1979	+2010	+2041
0000F30	+2072	+2087	+2102	+2117	+2132	+2139	+2146	+2153
0000F38	+2160	+2168	+2176	+2184	+2192	+2192	+2192	+2192
0000F40	+1328	+1344	+1360	+1376	+1392	+1408	+1424	+1440
0000F48	+1456	+1468	+1482	+1494	+1508	+1520	+1534	+1546
0000F50	+1560	+1584	+1608	+1632	+1656	+1664	+1672	+1680

00000F58	+1688	+1718	+1750	+1780	+1812	+1802	+1794	+1784
00000F60	+1776	+1798	+1820	+1858	+1896	+1750	+1860	+2338
00000F68	+1792	+2134	+1966	+1956	+1948	+1978	+2010	+2040
00000F70	+2072	+2086	+2102	+2116	+2132	+2138	+2146	+2152
00000F78	+2160	+2168	+2176	+2184	+2192	+2192	+2192	+2192
00000F80	+1328	+1344	+1360	+1376	+1392	+1408	+1424	+1440
00000F88	+1456	+1469	+1482	+1495	+1508	+1521	+1534	+1547
00000F90	+1560	+1584	+1608	+1632	+1656	+1664	+1672	+1680
00000F98	+1688	+1719	+1750	+1781	+1812	+1803	+1794	+1785
00000FA0	+1776	+1798	+1820	+1842	+1864	+1958	+2052	+1954
00000FA8	+1856	+1911	+1966	+1957	+1948	+1979	+2010	+2041
00000FB0	+2072	+2087	+2102	+2117	+2132	+2139	+2146	+2153
00000FB8	+2160	+2168	+2176	+2184	+2192	+2192	+2192	+2192
00000FC0	+1328	+1344	+1360	+1376	+1392	+1408	+1424	+1440
00000FC8	+1456	+1468	+1482	+1494	+1508	+1520	+1534	+1546
00000FD0	+1560	+1584	+1608	+1632	+1656	+1664	+1672	+1680
00000FD8	+1688	+1718	+1750	+1780	+1812	+1802	+1794	+1784
00000FE0	+1776	+1798	+1820	+1842	+1864	+1958	+2052	+1954
00000FE8	+1856	+1910	+1966	+1956	+1948	+1978	+2010	+2040
00000FF0	+2072	+2086	+2102	+2116	+2132	+2138	+2146	+2152
00000FF8	+2160	+2168	+2176	+2184	+2192	+2192	+2192	+2192

4.2.4.3.6 Reconstructed Cr Component

The following is a dump of the reconstructed Cb component. All the coefficients are displayed in 11.5 fixed-point representation.

00000000	-2112	-2114	-2116	-2118	-2120	-2122	-2124	-2126
00000008	-2128	-2118	-2108	-2098	-2088	-2150	-2212	-2146
00000010	-2080	-2100	-2120	-2140	-2160	-2164	-2168	-2172
00000018	-2176	-2092	-2008	-2052	-2096	-2132	-2168	-2076
00000020	-1984	-2088	-2192	-2168	-2144	-2136	-2128	-2120
00000028	-2112	-2126	-2140	-2154	-2168	-2150	-2132	-2114
00000030	-2096	-2096	-2096	-2096	-2096	-2096	-2096	-2096
00000038	-2096	-2080	-2064	-2048	-2032	-2032	-2032	-2032
00000040	-2128	-2113	-2098	-2115	-2132	-2133	-2134	-2135
00000048	-2137	-2127	-2117	-2107	-2097	-2117	-2137	-2125
00000050	-2114	-2134	-2154	-2159	-2163	-2135	-2108	-2128
00000058	-2149	-2132	-2116	-2116	-2115	-2115	-2114	-2098
00000060	-2082	-2112	-2142	-2141	-2139	-2133	-2128	-2122
00000068	-2117	-2127	-2137	-2147	-2158	-2146	-2134	-2122
00000070	-2111	-2108	-2106	-2104	-2102	-2101	-2101	-2101
00000078	-2101	-2087	-2073	-2059	-2045	-2045	-2045	-2045
00000080	-2144	-2112	-2080	-2112	-2145	-2145	-2145	-2145
00000088	-2146	-2136	-2126	-2116	-2107	-2085	-2063	-2105
00000090	-2148	-2168	-2189	-2178	-2167	-2107	-2048	-2085
00000098	-2122	-2173	-2225	-2180	-2135	-2098	-2061	-2120
000000A0	-2180	-2136	-2093	-2114	-2135	-2131	-2128	-2125
000000A8	-2122	-2128	-2135	-2141	-2148	-2142	-2137	-2131
000000B0	-2126	-2121	-2117	-2112	-2108	-2107	-2107	-2106
000000B8	-2106	-2094	-2082	-2070	-2058	-2058	-2058	-2058
000000C0	-2160	-2111	-2062	-2109	-2157	-2156	-2155	-2154
000000C8	-2155	-2145	-2135	-2125	-2116	-2132	-2148	-2132
000000D0	-2118	-2154	-2191	-2181	-2170	-2494	-2308	-2393
000000D8	-2479	-2470	-2461	-2243	-2282	-2353	-2167	-2174

000000E0	-2182	-2160	-2139	-2135	-2130	-2128	-2128	-2127
000000E8	-2127	-2129	-2132	-2134	-2138	-2138	-2139	-2139
000000F0	-2141	-2133	-2127	-2120	-2114	-2112	-2112	-2111
000000F8	-2111	-2101	-2091	-2081	-2071	-2071	-2071	-2071
00000100	-2176	-2110	-2045	-2107	-2170	-2168	-2167	-2165
00000108	-2164	-2154	-2145	-2135	-2126	-2180	-2235	-2161
00000110	-2088	-2141	-2195	-2440	-2686	-2371	-1033	-398
00000118	+236	+305	+375	-3	-894	-2096	-2787	-2485
00000120	-2184	-2185	-2187	-2156	-2126	-2127	-2129	-2130
00000128	-2132	-2131	-2130	-2129	-2128	-2135	-2142	-2149
00000130	-2156	-2147	-2138	-2129	-2120	-2119	-2118	-2117
00000138	-2116	-2108	-2100	-2092	-2084	-2084	-2084	-2084
00000140	-2112	-2085	-2058	-2112	-2166	-2067	-2225	-2190
00000148	-2157	-2107	-2057	-2104	-2151	-2119	-2088	-2632
00000150	-2666	-2263	-837	+844	+2526	+3327	+2847	+2847
00000158	+2847	+2726	+2606	+2967	+3070	+2968	+2867	+397
00000160	-2074	-2745	-2137	-2281	-2169	-2202	-2236	-2190
00000168	-2145	-2145	-2147	-2148	-2150	-2152	-2156	-2159
00000170	-2163	-2159	-2156	-2152	-2150	-2130	-2111	-2123
00000178	-2137	-2127	-2117	-2107	-2097	-2097	-2097	-2097
00000180	-2048	-2060	-2073	-2118	-2163	-1967	-2284	-2217
00000188	-2150	-2060	-1971	-2074	-2177	-2315	-2454	-1057
00000190	+1364	+2990	+2568	+2593	+2619	+2369	+2631	+2508
00000198	+2386	+2332	+2278	+2352	+2427	+2913	+2888	+3022
000001A0	+3156	+1302	-2088	-2406	-2213	-2279	-2345	-2251
000001A8	-2158	-2161	-2165	-2168	-2172	-2171	-2171	-2170
000001B0	-2170	-2172	-2175	-2177	-2180	-2142	-2105	-2131
000001B8	-2158	-2146	-2134	-2122	-2110	-2110	-2110	-2110
000001C0	-2112	-2163	-2215	-2235	-2255	-1994	-2247	-2194
000001C8	-2143	-2109	-2076	-2123	-2170	-2270	+700	+3527
000001D0	+2770	+2035	+2325	+2293	+2263	+2178	+2350	+2265
000001D8	+2181	+2129	+2078	+2154	+2231	+2521	+2557	+2559
000001E0	+2562	+3221	+3113	+140	-2832	-2034	-2261	-2199
000001E8	-2139	-2160	-2182	-2188	-2194	-2189	-2185	-2181
000001F0	-2177	-2185	-2193	-2201	-2210	-2154	-2098	-2138
000001F8	-2179	-2165	-2151	-2137	-2123	-2123	-2123	-2123
00000200	-1664	-1755	-1846	-1841	-1836	-1767	-2210	-2173
00000208	-2136	-2159	-2182	-2173	-2164	-2739	+2830	+2735
00000210	+2640	+2361	+2082	+1995	+1908	+1989	+2070	+2023
00000218	+1976	+1927	+1878	+1957	+2036	+2131	+2226	+2353
00000220	+2480	+2581	+2682	+2943	+2692	-2815	-2178	-2149
00000228	-2120	-2160	-2200	-2208	-2216	-2208	-2200	-2192
00000230	-2184	-2198	-2212	-2226	-2240	-2166	-2092	-2146
00000238	-2200	-2184	-2168	-2152	-2136	-2136	-2136	-2136
00000240	-2096	-2166	-2238	-2228	-2220	-2087	-2210	-2173
00000248	-2137	-2189	-2243	-2152	-2318	-2031	+3375	+2861
00000250	+2605	+2305	+2007	+1851	+1697	+1756	+1815	+1810
00000258	+1806	+1756	+1707	+1754	+1801	+1911	+2023	+2149
00000260	+2277	+2299	+2323	+2729	+1345	-2439	-2129	-2217
00000268	-2307	-2349	-2136	-2179	-2222	-2223	-2224	-2193
00000270	-2162	-2171	-2180	-2190	-2199	-2198	-2198	-2213
00000278	-2229	-2172	-2115	-2170	-2225	-2113	-2257	-2257
00000280	-2016	-2067	-2118	-2105	-2093	-2152	-2211	-2174
00000288	-2138	-2221	-2305	-2132	-2472	+212	+2897	+2477
00000290	+2570	+2251	+1932	+1709	+1487	+1524	+1561	+1598
00000298	+1636	+1586	+1537	+1552	+1567	+1693	+1820	+1947
000002A0	+2074	+2019	+1964	+2261	-514	-2321	-2080	-2031
000002A8	-1982	-2283	-2073	-2151	-2229	-2238	-2248	-2194
000002B0	-2140	-2144	-2149	-2154	-2159	-2231	-2304	-2281

000002B8	-2258	-2160	-2062	-2188	-2314	-2090	-2378	-2378
000002C0	-2064	-2094	-2126	-2125	-2125	-2152	-2179	-2159
000002C8	-2139	-2204	-2270	-2144	-2530	+1688	+2834	+2460
000002D0	+2343	+2147	+1953	+1678	+1404	+1387	+1370	+1418
000002D8	+1466	+1416	+1366	+1349	+1332	+1442	+1553	+1663
000002E0	+1775	+1817	+1861	+2415	-2405	-2457	-1999	-2035
000002E8	-281	-1464	-2393	-2378	-2363	-2301	-2240	-2195
000002F0	-2150	-2165	-2181	-2182	-2182	-2199	-2218	-2188
000002F8	-2159	-2756	-2329	-1934	-2307	-2627	-2179	-2307
00000300	-2112	-2123	-2135	-2146	-2158	-2153	-2149	-2144
00000308	-2140	-2188	-2236	-2156	-2588	+3164	+2772	+2444
00000310	+2116	+2045	+1975	+1648	+1322	+1251	+1181	+1238
00000318	+1296	+1246	+1197	+1147	+1098	+1192	+1287	+1381
00000320	+1476	+1617	+1758	+1291	-2760	-2083	-2430	-1273
00000328	-628	-647	-667	-1582	-2498	-2365	-2233	-2196
00000330	-2160	-2187	-2215	-2210	-2206	-2169	-2133	-2096
00000338	-2060	-280	-548	-2448	-1788	-860	-1980	-2236
00000340	-2112	-2120	-2130	-2140	-2150	-2145	-2141	-2137
00000348	-2133	-2147	-2161	-2079	-718	+3207	+2525	+2291
00000350	+2057	+1941	+1827	+1553	+1279	+1174	+1070	+1094
00000358	+1118	+1044	+970	+976	+983	+1001	+1019	+1165
00000360	+1313	+1305	+1555	-212	-2491	-2189	-2401	-867
00000368	-615	-642	-671	-603	-536	-1354	-2172	-2271
00000370	-2370	-2340	-2311	-2330	-2349	-2315	-2282	-2697
00000378	-1321	-420	-543	-394	-757	-741	-2261	-2261
00000380	-2112	-2119	-2127	-2135	-2143	-2138	-2134	-2130
00000388	-2126	-2106	-2087	-2259	+640	+2995	+2279	+2138
00000390	+1998	+1839	+1681	+1459	+1237	+1098	+960	+950
00000398	+940	+842	+744	+806	+869	+811	+753	+951
000003A0	+1150	+995	+1352	-1715	-2222	-2297	-2372	-463
000003A8	-602	-639	-676	-649	-623	-600	-577	-810
000003B0	-1044	-1214	-1384	-1426	-1469	-1183	-897	-483
000003B8	-582	-560	-538	-900	-750	-1134	-2542	-2286
000003C0	-2112	-2117	-2123	-2129	-2135	-2131	-2127	-2123
000003C8	-2119	-2017	-1916	-2886	+1262	+2014	+2256	+2097
000003D0	+1939	+1736	+1534	+1364	+1194	+1022	+850	+806
000003D8	+762	+736	+710	+508	+818	+604	+646	+752
000003E0	+859	+1131	+1149	-2865	-2273	-2339	-1639	-425
000003E8	-493	-522	-553	-566	-581	-677	-773	-661
000003F0	-550	-567	-585	-586	-588	-657	-727	-572
000003F8	-675	-668	-661	-798	-679	-1799	-2407	-2151
00000400	-2112	-2116	-2120	-2124	-2128	-2124	-2120	-2116
00000408	-2112	-2185	-2258	-1723	+1884	+1035	+2234	+2057
00000410	+1880	+1634	+1388	+1270	+1152	+946	+740	+662
00000418	+584	+630	+676	+466	+1280	+654	+540	+554
00000420	+568	+757	-78	-2481	-2324	-2383	-906	-389
00000428	-384	-407	-430	-485	-540	-499	-458	-513
00000430	-568	-689	-810	-771	-732	-645	-558	-663
00000438	-768	-776	-784	-696	-608	-2464	-2272	-2016
00000440	-2104	-2110	-2116	-2122	-2129	-2105	-2081	-2105
00000448	-2130	-2204	-2536	-84	+1856	+1148	+1209	+1701
00000450	+1683	+1507	+1332	+1188	+1045	+837	+630	+518
00000458	+407	+489	+572	+398	+1249	+662	+330	+383
00000460	+436	+589	-1304	-2350	-2117	-2615	+213	-12
00000468	-239	-265	-293	-320	-348	-377	-407	-484
00000470	-562	-626	-691	-675	-661	-625	-590	-682
00000478	-776	-804	-832	-540	-248	-664	-1848	-2616
00000480	-2096	-2104	-2113	-2121	-2130	-2086	-2043	-2095
00000488	-2148	-2225	-2815	+1555	+1829	+1519	+697	+1603

00000490	+1486	+1381	+1276	+1107	+938	+729	+520	+375
00000498	+230	+349	+468	+331	+1219	+670	+121	+212
000004A0	+304	+423	-2531	-2477	-2423	-1569	+309	-149
000004A8	-94	-125	-157	-157	-157	-256	-356	-456
000004B0	-556	-564	-573	-581	-590	-606	-623	-703
000004B8	-784	-832	-880	-384	+112	-1424	-2448	-2192
000004C0	-2088	-2098	-2109	-2119	-2131	-2099	-2068	-2100
000004C8	-2134	-2485	-2325	+2921	+2025	+1536	+1048	+1088
000004D0	+1385	+1270	+1156	+993	+831	+700	+570	+407
000004D8	+245	+256	+268	+343	+932	+662	+135	+185
000004E0	+236	-337	-2445	-2346	-2504	-793	+149	-75
000004E8	-45	-64	-84	-88	-93	-183	-273	-363
000004F0	-454	-454	-454	-518	-583	-619	-655	-723
000004F8	-792	-796	-800	-868	-1960	-2296	-2376	-2248
00000500	-2080	-2093	-2106	-2119	-2132	-2113	-2094	-2107
00000508	-2120	-2234	-813	+2752	+2222	+1555	+1401	+574
00000510	+1284	+1160	+1036	+880	+724	+672	+620	+440
00000518	+260	+164	+69	+357	+646	+654	+151	+159
00000520	+168	-1096	-2361	-2217	-2586	-18	-11	-3
00000528	+4	-4	-13	-21	-30	-110	-191	-271
00000530	-352	-344	-336	-456	-576	-632	-688	-744
00000538	-800	-760	-720	-584	-2496	-2400	-2304	-2304
00000540	-2072	-2086	-2102	-2117	-2133	-2171	-2211	-2170
00000548	-2130	-2462	+1045	+2615	+2138	+1656	+1432	+807
00000550	+951	+1193	+924	+734	+545	+397	+250	+486
00000558	+723	+569	+416	+311	+207	+384	+305	+242
00000560	+180	-1825	-2295	-2348	-1891	+69	-19	-10
00000568	-3	-7	-12	-16	-22	-65	-107	-182
00000570	-258	-309	-361	-477	-593	-640	-688	-736
00000578	-784	-752	-720	-1200	-2448	-2384	-2320	-2320
00000580	-2064	-2081	-2099	-2116	-2134	-2231	-2329	-2234
00000588	-2140	-2691	+2902	+2478	+2055	+1759	+1464	+1041
00000590	+618	+1227	+812	+589	+366	+379	+392	+277
00000598	+162	+207	+253	+267	+281	+114	-52	+70
000005A0	+192	-2555	-2230	-2481	-1197	+156	-28	-19
000005A8	-10	-11	-12	-13	-15	-20	-25	-94
000005B0	-164	-275	-387	-498	-610	-649	-689	-728
000005B8	-768	-744	-720	-1816	-2400	-2368	-2336	-2336
000005C0	-2056	-2075	-2095	-2115	-2135	-2178	-2222	-2138
000005C8	-2310	-1319	+2743	+2293	+2099	+1893	+1432	+1242
000005D0	+541	+1036	+1020	+699	+379	+376	+374	+275
000005D8	+177	+196	+217	+189	+162	+100	+39	+153
000005E0	-756	-2420	-2293	-2549	-502	+131	-4	-10
000005E8	-17	-14	-12	-9	-7	-7	-6	-102
000005F0	-198	-320	-444	-519	-595	-641	-689	-720
000005F8	-752	-768	-784	-2192	-2320	-2336	-2352	-2352
00000600	-2048	-2070	-2092	-2114	-2136	-2126	-2116	-2042
00000608	-2480	+52	+2584	+2108	+2144	+2028	+1400	+1444
00000610	+464	+78	-308	-470	-632	-394	-156	+18
00000618	+192	+187	+182	+113	+44	+87	+130	+237
00000620	-1704	-2286	-2356	-2618	+192	+106	+20	-2
00000628	-24	-18	-12	-6	+0	+6	+12	-110
00000630	-232	-367	-502	-541	-580	-635	-690	-713
00000638	-736	-792	-848	-2568	-2240	-2304	-2368	-2368
00000640	-2046	-2068	-2091	-2113	-2136	-2121	-2105	-2186
00000648	-2523	+1999	+2681	+2740	+1518	+117	-1541	-2639
00000650	-2457	-2465	-2474	-2466	-2459	-2498	-2536	-2303
00000658	-2070	-995	+81	-76	+24	+35	+47	-150
00000660	-2394	-2422	-2450	-1806	+117	+85	+53	+21

00000668	-11	-11	-11	-11	-11	-11	-11	-107
00000670	-203	-404	-606	-615	-625	-610	-596	-693
00000678	-791	-757	-1491	-2401	-2287	-2303	-2319	-2319
00000680	-2044	-2067	-2090	-2113	-2137	-2116	-2095	-2074
00000688	-2054	+2923	+219	-1748	-2692	-2563	-2435	-2114
00000690	-2306	-2193	-2080	-2159	-2239	-2298	-2357	-2320
00000698	-2284	-2432	-2580	-1544	+4	-16	-36	-280
000006A0	-2572	-2302	-2544	-994	+43	+64	+86	+44
000006A8	+2	-4	-10	-16	-22	-28	-34	-104
000006B0	-174	-186	-198	-178	-158	-330	-502	-674
000006B8	-846	-722	-2134	-2234	-2334	-2302	-2270	-2270
000006C0	-2042	-2065	-2089	-2112	-2137	-2159	-2180	-2154
000006C8	-2129	-2458	-2532	-2604	-2166	-2218	-2272	-2293
000006D0	-2315	-2000	-2198	-2219	-2242	-2322	-2401	-2385
000006D8	-2370	-2285	-2201	-2452	-2704	-1411	+137	-1402
000006E0	-2174	-2502	-2830	+250	+0	+28	+55	+35
000006E8	+15	+3	-9	-21	-33	-45	-57	-101
000006F0	-145	-175	-206	-220	-235	-177	-120	-414
000006F8	-709	-191	-2489	-2547	-2349	-2349	-2349	-2349
00000700	-2040	-2064	-2089	-2113	-2138	-2202	-2267	-2235
00000708	-2204	-2207	-2210	-2181	-2152	-2131	-2110	-2217
00000710	-1812	-1552	-2317	-2025	-1734	-1578	-1423	-1939
00000718	-2456	-2395	-2334	-2081	-2340	-2551	-2250	-2013
00000720	-2288	-2446	-2093	-43	-42	-8	+25	+26
00000728	+28	+10	-8	-26	-44	-62	-80	-98
00000730	-116	-165	-214	-263	-312	-281	-250	-155
00000738	-60	-940	-1820	-2348	-2364	-2396	-2428	-2428
00000740	-2038	-2058	-2079	-2100	-2122	-2123	-2124	-2285
00000748	-2191	-2065	-1940	-1910	-1882	-2232	-2327	-2149
00000750	-1717	-1485	-2022	-1759	-1497	-1242	-987	-716
00000758	-446	-1226	-2007	-2723	-2160	-2330	-2245	-2175
00000760	-2362	-2338	-1034	+109	-28	-19	-10	+15
00000768	+41	+19	-3	-25	-47	-89	-131	-141
00000770	-151	-208	-266	-355	-445	-458	-472	-405
00000778	-83	-1135	-1163	-1895	-2371	-2387	-2403	-2403
00000780	-2036	-2053	-2071	-2089	-2107	-2044	-1982	-2080
00000788	-1666	-1668	-1671	-1897	-2124	-2590	-2545	-2083
00000790	-1622	-1419	-1729	-1495	-1261	-1162	-1064	-774
00000798	-484	-314	-144	-806	-2492	-2366	-2240	-2338
000007A0	-2436	-2486	-489	+4	-15	-30	-45	+4
000007A8	+54	+28	+2	-24	-50	-116	-182	-184
000007B0	-186	-252	-318	-448	-578	-636	-694	-656
000007B8	-106	-2098	-2042	-2210	-2378	-2378	-2378	-2378
000007C0	-2034	-2047	-2062	-2076	-2091	-2093	-2096	-1650
000007C8	-1461	-1687	-1913	-2155	-2398	-2676	-2442	-2016
000007D0	-1591	-1448	-1563	-1341	-1120	-986	-853	-623
000007D8	-394	-265	-137	+200	+24	-1554	-2363	-2324
000007E0	-2286	-2122	-2727	-1220	+31	+136	-15	+25
000007E8	+67	+37	+7	-7	-21	-111	-201	-211
000007F0	-221	-295	-370	-460	-551	-509	-468	-634
000007F8	-545	-2805	-2249	-2301	-2353	-2353	-2353	-2353
00000800	-2032	-2043	-2054	-2065	-2076	-2143	-2210	-1477
00000808	-1768	-1962	-2156	-2414	-2672	-2762	-2340	-1950
00000810	-1560	-1479	-1398	-1189	-980	-811	-642	-473
00000818	-304	-217	-130	-75	-20	+27	-2486	-2311
00000820	-2136	-2527	-2406	-2445	-2484	-979	+14	+47
00000828	+80	+46	+12	+10	+8	-106	-220	-238
00000830	-256	-339	-422	-473	-524	-639	-754	-1637
00000838	-2520	-2232	-2456	-2392	-2328	-2328	-2328	-2328

00000840	-2012	-2030	-2049	-2052	-2055	-2191	-2073	-1585
00000848	-1867	-2081	-2296	-2526	-2757	-2653	-2294	-1886
00000850	-1479	-1380	-1282	-1087	-893	-748	-604	-491
00000858	-379	-243	-109	-181	+1	-606	-2493	-2283
00000860	-2331	-2481	-2376	-2413	-2452	-2308	-2421	-1350
00000868	-278	-124	+30	+88	+145	+127	+109	+27
00000870	-56	-278	-501	-1107	-1714	-2162	-2612	-2532
00000878	-2453	-2297	-2397	-2369	-2341	-2341	-2341	-2341
00000880	-1992	-2018	-2045	-2040	-2035	-2241	-1936	-1695
00000888	-1966	-2201	-2436	-2639	-2842	-2545	-2248	-1823
00000890	-1398	-1282	-1166	-986	-806	-686	-566	-510
00000898	-454	-271	-88	-289	+22	-1239	-2500	-2257
000008A0	-2526	-388	-2346	-2383	-2421	-2358	-2296	-2490
000008A8	-2684	-2342	-2001	-1627	-1254	-1176	-1099	-1501
000008B0	-1904	-2266	-2628	-2510	-2393	-2407	-2422	-2404
000008B8	-2386	-2362	-2338	-2346	-2354	-2354	-2354	-2354
000008C0	-1972	-2006	-2040	-2043	-2046	-2194	-1831	-1835
000008C8	-2097	-2336	-2576	-2735	-2895	-2564	-2234	-1839
000008D0	-1445	-1279	-1114	-916	-719	-623	-528	-528
000008D8	-529	-425	-323	-59	-53	-2527	-2443	-2517
000008E0	-2081	+170	-140	-1312	-2485	-2440	-2395	-2382
000008E8	-2370	-2400	-2431	-2509	-2589	-2559	-2530	-2500
000008F0	-2472	-2429	-2387	-2489	-2335	-2939	-2008	-1331
000008F8	-2447	-2395	-2343	-2355	-2367	-2367	-2367	-2367
00000900	-1952	-1994	-2037	-2047	-2058	-2148	-1727	-1977
00000908	-2228	-2472	-2716	-2832	-2948	-2584	-2220	-1856
00000910	-1492	-1277	-1062	-847	-632	-561	-490	-547
00000918	-604	-581	-558	-343	-1152	-2281	-2386	-2523
00000920	-1124	-40	+19	+15	+10	-1242	-2495	-2531
00000928	-2568	-2459	-2350	-2369	-2388	-2407	-2426	-2477
00000930	-2528	-2593	-2659	-2212	-1254	+369	+967	-1026
00000938	-2508	-2428	-2348	-2364	-2380	-2380	-2380	-2380
00000940	-1948	-1996	-2044	-2060	-2077	-1957	-1837	-2069
00000948	-2303	-2545	-2788	-2918	-3049	-2873	-2442	-2026
00000950	-1611	-1374	-1138	-965	-793	-732	-672	-707
00000958	-743	-847	-953	-2017	-2059	-2441	-2313	-2327
00000960	-295	+99	-19	+23	+65	+26	-13	-629
00000968	-1246	-1795	-2345	-2509	-2675	-2540	-2406	-1887
00000970	-1368	-467	+434	+439	+699	+1162	+856	-2695
00000978	-2409	-2413	-2417	-2389	-2361	-2361	-2361	-2361
00000980	-1944	-1998	-2052	-2074	-2097	-1767	-1949	-2163
00000988	-2378	-2619	-2860	-3005	-3150	-3163	-2664	-2197
00000990	-1730	-1472	-1214	-1084	-954	-904	-854	-868
00000998	-882	-859	-836	-877	-1942	-2091	-2240	-2389
000009A0	+22	-18	-57	+32	+121	+14	-93	-9
000009A8	+76	+149	+221	+166	+110	+143	+175	+239
000009B0	+304	+379	+455	+530	+605	+676	+235	-2573
000009B8	-2310	-2398	-2486	-2414	-2342	-2342	-2342	-2342
000009C0	-1940	-2000	-2060	-2072	-2084	-1640	-1964	-2144
000009C8	-2325	-2532	-2740	-2899	-3059	-3052	-2790	-2319
000009D0	-1849	-1569	-1290	-1202	-1115	-1075	-1036	-1028
000009D8	-1021	-1077	-1135	-503	-2689	-2395	-2359	-1553
000009E0	+19	-6	-30	+25	+80	+34	-12	+37
000009E8	+86	+124	+162	+137	+111	+137	+163	+237
000009F0	+312	+393	+475	+525	+574	+654	-803	-2466
000009F8	-2339	-2383	-2427	-2375	-2323	-2323	-2323	-2323
00000A00	-1936	-2002	-2068	-2070	-2072	-1514	-1980	-2126
00000A08	-2272	-2446	-2620	-2794	-2968	-2942	-2916	-2442
00000A10	-1968	-1667	-1366	-1321	-1276	-1247	-1218	-1189

00000A18	-1160	-1041	-922	-1411	-2412	-2189	-2478	-719
00000A20	+16	+6	-4	+18	+40	+54	+68	+82
00000A28	+96	+100	+104	+108	+112	+132	+152	+236
00000A30	+320	+408	+496	+520	+544	+632	-1840	-2360
00000A38	-2368	-2368	-2368	-2336	-2304	-2304	-2304	-2304
00000A40	-1898	-1921	-1944	-2111	-1766	-1551	-1848	-1985
00000A48	-2122	-2318	-2515	-2664	-2813	-3074	-3079	-2828
00000A50	-2321	-2024	-1729	-1608	-1489	-1457	-1425	-1393
00000A58	-1362	-1246	-1131	-1879	-2372	-2532	-2693	+331
00000A60	+25	+40	+55	+54	+54	+71	+88	+105
00000A68	+123	+151	+180	+208	+237	+83	-70	+48
00000A70	+167	+248	+329	+346	+363	+733	-2738	-2577
00000A78	-2416	-2395	-2374	-2353	-2332	-2332	-2332	-2332
00000A80	-1860	-1840	-1820	-2152	-1460	-1588	-1716	-1844
00000A88	-1972	-2191	-2411	-2535	-2659	-2950	-2730	-2958
00000A90	-2674	-2383	-2092	-1897	-1703	-1668	-1633	-1598
00000A98	-1564	-1452	-1340	-2348	-2333	-2365	-1885	-157
00000AA0	+34	+74	+115	+91	+68	+88	+109	+129
00000AA8	+150	+203	+256	+309	+362	+291	+220	+117
00000AB0	+14	+88	+162	+172	+183	-702	-2612	-2282
00000AB8	-2464	-2422	-2380	-2370	-2360	-2360	-2360	-2360
00000AC0	-2110	-1967	-1824	-1953	-1314	-1513	-1712	-1815
00000AC8	-1918	-2207	-2242	-2453	-2408	-2602	-2541	-2752
00000AD0	-2707	-2692	-2679	-2409	-2140	-2054	-1968	-1867
00000AD8	-1766	-1721	-1677	-2369	-2293	-2516	-948	-53
00000AE0	+75	+92	+110	+95	+82	+105	+129	+152
00000AE8	+177	+222	+268	+313	+359	+354	+350	+441
00000AF0	+533	+472	+411	+414	+674	-1689	-2518	-2339
00000AF8	-2416	-2401	-2386	-2387	-2388	-2388	-2388	-2388
00000B00	-1848	-1838	-1828	-1754	-1168	-1438	-1708	-1786
00000B08	-1864	-2225	-2075	-2372	-2158	-2255	-2353	-2546
00000B10	-2740	-2747	-2755	-2666	-2578	-2441	-2305	-2136
00000B18	-1968	-1991	-2015	-2390	-2254	-2669	-13	+51
00000B20	+116	+111	+106	+101	+96	+123	+150	+177
00000B28	+204	+242	+280	+318	+356	+418	+480	+510
00000B30	+540	+600	+661	+657	+1166	-2677	-2425	-2396
00000B38	-2368	-2380	-2392	-2404	-2416	-2416	-2416	-2416
00000B40	-1882	-1711	-1796	-1369	-1198	-1419	-1640	-1749
00000B48	-1858	-1977	-1842	-2058	-2019	-2113	-2207	-2366
00000B50	-2525	-2478	-2689	-2836	-2983	-2759	-2536	-2393
00000B58	-2250	-2194	-2139	-2357	-2318	-2018	+72	+113
00000B60	+157	+150	+145	+139	+134	+159	+186	+212
00000B68	+239	+273	+308	+342	+377	+439	+502	+548
00000B70	+595	+632	+669	+931	+170	-2666	-2430	-2403
00000B78	-2376	-2385	-2394	-2403	-2412	-2412	-2412	-2412
00000B80	-1916	-1840	-2276	-1240	-1228	-1400	-1572	-1712
00000B88	-1852	-1731	-1610	-1745	-1881	-1972	-2063	-2186
00000B90	-2310	-2211	-2625	-2751	-2877	-2822	-2768	-2650
00000B98	-2532	-2398	-2265	-2324	-2383	-1369	+156	+177
00000BA0	+198	+191	+185	+178	+172	+197	+223	+248
00000BA8	+274	+305	+336	+367	+398	+461	+524	+587
00000BB0	+650	+664	+679	+1206	-827	-2656	-2437	-2410
00000BB8	-2384	-2390	-2396	-2402	-2408	-2408	-2408	-2408
00000BC0	-1950	-1953	-1956	-1063	-1194	-1317	-1440	-1435
00000BC8	-1430	-1499	-1314	-1431	-1550	-1638	-1726	-1798
00000BD0	-1871	-1927	-2240	-2409	-2578	-2597	-2616	-2731
00000BD8	-2846	-2554	-2262	-2259	-2511	-527	+176	+207
00000BE0	+239	+231	+224	+217	+210	+234	+259	+284
00000BE8	+309	+336	+364	+391	+419	+482	+546	+609

0000BF0	+673	+744	+816	+936	-2015	-2485	-2187	-2289
0000BF8	-2392	-2395	-2398	-2401	-2404	-2404	-2404	-2404
0000C00	-1984	-2066	-1636	-886	-1160	-1234	-1308	-1414
0000C08	-1520	-2037	-2042	-1887	-1732	-1817	-1902	-1923
0000C10	-1944	-1900	-1856	-2068	-2280	-2372	-2464	-2556
0000C18	-2648	-2454	-2260	-2194	-2640	+314	+196	+238
0000C20	+280	+272	+264	+256	+248	+272	+296	+320
0000C28	+344	+368	+392	+416	+440	+504	+568	+632
0000C30	+696	+825	+954	+923	-2692	-2315	-2450	-2425
0000C38	-2400	-2400	-2400	-2400	-2400	-2400	-2400	-2400
0000C40	-2252	-1953	-1142	-1035	-1441	-1826	-2211	-2244
0000C48	-2278	-2220	-1908	-1914	-1922	-2001	-2336	-2095
0000C50	-2111	-2171	-2231	-2131	-2031	-2143	-2255	-2303
0000C58	-2352	-2306	-2260	-2359	-1689	+442	+269	+305
0000C60	+341	+333	+325	+317	+309	+329	+349	+369
0000C68	+389	+415	+441	+468	+494	+536	+579	+669
0000C70	+760	+797	+1091	-248	-2610	-2406	-2459	-2431
0000C78	-2404	-2400	-2396	-2392	-2388	-2388	-2388	-2388
0000C80	-2008	-2096	-1673	-1953	-2234	-2162	-2091	-2051
0000C88	-2012	-2149	-2286	-2199	-2113	-1930	-2259	-2012
0000C90	-2278	-2186	-2094	-2194	-2295	-2171	-2047	-2051
0000C98	-2056	-2158	-2261	-2524	-739	+570	+343	+372
0000CA0	+402	+394	+386	+378	+370	+386	+402	+418
0000CA8	+434	+462	+491	+520	+549	+569	+590	+707
0000CB0	+824	+770	+1228	-1418	-2528	-2498	-2468	-2438
0000CB8	-2408	-2400	-2392	-2384	-2376	-2376	-2376	-2376
0000CC0	-1988	-2191	-2139	-2150	-2163	-2130	-2098	-2081
0000CC8	-2066	-2140	-2216	-2179	-2143	-2066	-2245	-2137
0000CD0	-2285	-2233	-2181	-2225	-2270	-2326	-2382	-2166
0000CD8	-1952	-2250	-2549	-2465	+180	+394	+352	+407
0000CE0	+463	+455	+447	+423	+399	+523	+391	+547
0000CE8	+447	+493	+540	+572	+603	+633	+665	+792
0000CF0	+920	+1094	+1269	-2764	-2446	-2429	-2413	-2412
0000CF8	-2412	-2400	-2388	-2376	-2364	-2364	-2364	-2364
0000D00	-1968	-2031	-2094	-2093	-2092	-2099	-2106	-2113
0000D08	-2120	-2133	-2147	-2160	-2174	-2203	-2233	-2262
0000D10	-2292	-2280	-2269	-2257	-2246	-2226	-2207	-2283
0000D18	-2360	-2343	-2327	-2406	+586	-38	+363	+443
0000D20	+524	+516	+508	+468	+428	+660	+380	+676
0000D28	+460	+525	+591	+624	+658	+699	+741	+878
0000D30	+1016	+907	+286	-2575	-2364	-2361	-2358	-2387
0000D38	-2416	-2400	-2384	-2368	-2352	-2352	-2352	-2352
0000D40	-2020	-2071	-2124	-2080	-2037	-2062	-2089	-2115
0000D48	-2142	-2152	-2164	-2176	-2188	-2211	-2235	-2259
0000D50	-2283	-2275	-2267	-2260	-2253	-2249	-2246	-2290
0000D58	-2336	-2337	-2339	-1205	-71	-16	+296	+496
0000D60	+441	+469	+497	+381	+521	+635	+493	+735
0000D68	+465	+544	+624	+640	+656	+747	+839	+899
0000D70	+960	+1115	-1033	-2493	-2418	-2378	-2339	-2379
0000D78	-2420	-2408	-2396	-2384	-2372	-2372	-2372	-2372
0000D80	-2072	-2113	-2155	-2068	-1982	-2027	-2073	-2118
0000D88	-2164	-2173	-2183	-2193	-2203	-2220	-2238	-2256
0000D90	-2274	-2270	-2267	-2264	-2261	-2273	-2286	-2299
0000D98	-2312	-2332	-2352	-2052	-729	+7	+230	+550
0000DA0	+358	+422	+486	+294	+614	+610	+606	+794
0000DA8	+470	+564	+658	+656	+655	+797	+939	+921
0000DB0	+904	+1324	-2352	-2412	-2472	-2396	-2320	-2372
0000DB8	-2424	-2416	-2408	-2400	-2392	-2392	-2392	-2392
0000DC0	-1996	-1930	-1865	-1960	-2055	-2087	-2120	-2153

0000DC8	-2186	-2193	-2201	-2209	-2217	-2229	-2241	-2253
0000DD0	-2265	-2265	-2266	-2267	-2268	-2280	-2294	-2306
0000DD8	-2320	-2342	-2365	-2707	-2538	-1491	-188	+172
0000DE0	+275	+327	+379	+287	+451	+505	+559	+773
0000DE8	+475	+551	+628	+512	+653	+909	+654	+1007
0000DF0	+1104	-739	-2583	-2506	-2430	-2397	-2365	-2396
0000DF8	-2428	-2424	-2420	-2416	-2412	-2412	-2412	-2412
0000E00	-1920	-2004	-2088	-2108	-2128	-2148	-2168	-2188
0000E08	-2208	-2214	-2220	-2226	-2232	-2238	-2244	-2250
0000E10	-2256	-2261	-2266	-2271	-2276	-2289	-2302	-2315
0000E18	-2328	-2353	-2378	-2339	-2300	-2477	-1630	-719
0000E20	+192	+232	+272	+280	+288	+400	+512	+752
0000E28	+480	+539	+598	+369	+652	+767	-142	-1211
0000E30	-2792	-2547	-2302	-2345	-2388	-2399	-2410	-2421
0000E38	-2432	-2432	-2432	-2432	-2432	-2432	-2432	-2432
0000E40	-2024	-2070	-2116	-2130	-2144	-2164	-2184	-2204
0000E48	-2224	-2228	-2232	-2236	-2240	-2244	-2248	-2252
0000E50	-2256	-2262	-2270	-2276	-2284	-2296	-2310	-2322
0000E58	-2336	-2319	-2304	-2287	-2272	-2559	-2336	-1855
0000E60	-1376	-2264	-1104	-520	+64	+384	+704	+704
0000E68	+192	-44	-280	-1236	-1936	-3018	-2564	-2349
0000E70	-2392	-2390	-2390	-2388	-2388	-2398	-2410	-2420
0000E78	-2432	-2432	-2432	-2432	-2432	-2432	-2432	-2432
0000E80	-2128	-2136	-2144	-2152	-2160	-2180	-2200	-2220
0000E88	-2240	-2242	-2244	-2246	-2248	-2250	-2252	-2254
0000E90	-2256	-2265	-2274	-2283	-2292	-2305	-2318	-2331
0000E98	-2344	-2287	-2230	-2237	-2244	-2387	-2530	-2481
0000EA0	-2432	-2456	-2480	-2600	-2720	-2448	-2176	-1904
0000EA8	-2144	-2419	-2694	-2585	-2476	-2451	-2426	-2465
0000EB0	-2504	-2491	-2478	-2433	-2388	-2399	-2410	-2421
0000EB8	-2432	-2432	-2432	-2432	-2432	-2432	-2432	-2432
0000EC0	-2104	-2122	-2140	-2158	-2176	-2196	-2216	-2236
0000EC8	-2256	-2256	-2256	-2256	-2256	-2256	-2256	-2256
0000ED0	-2256	-2266	-2278	-2288	-2300	-2312	-2326	-2338
0000ED8	-2352	-2317	-2284	-2281	-2280	-2357	-2436	-2417
0000EE0	-2400	-2408	-2416	-2360	-2304	-2480	-864	-1648
0000EE8	-1408	-1225	-2580	-2509	-2440	-2427	-2416	-2435
0000EF0	-2456	-2446	-2438	-2412	-2388	-2398	-2410	-2420
0000EF8	-2432	-2432	-2432	-2432	-2432	-2432	-2432	-2432
0000F00	-2080	-2108	-2136	-2164	-2192	-2212	-2232	-2252
0000F08	-2272	-2270	-2268	-2266	-2264	-2262	-2260	-2258
0000F10	-2256	-2269	-2282	-2295	-2308	-2321	-2334	-2347
0000F18	-2360	-2349	-2338	-2327	-2316	-2329	-2342	-2355
0000F20	-2368	-2360	-2352	-2376	-2400	-2256	-2624	-1392
0000F28	-1696	-2593	-2466	-2435	-2404	-2405	-2406	-2407
0000F30	-2408	-2403	-2398	-2393	-2388	-2399	-2410	-2421
0000F38	-2432	-2432	-2432	-2432	-2432	-2432	-2432	-2432
0000F40	-2080	-2108	-2136	-2164	-2192	-2212	-2232	-2252
0000F48	-2272	-2270	-2268	-2266	-2264	-2262	-2260	-2258
0000F50	-2256	-2268	-2282	-2294	-2308	-2320	-2334	-2346
0000F58	-2360	-2348	-2338	-2326	-2316	-2328	-2342	-2354
0000F60	-2368	-2360	-2352	-2360	-2368	-2352	-2592	-2192
0000F68	-2560	-2768	-2466	-2434	-2404	-2404	-2406	-2406
0000F70	-2408	-2402	-2398	-2392	-2388	-2398	-2410	-2420
0000F78	-2432	-2432	-2432	-2432	-2432	-2432	-2432	-2432
0000F80	-2080	-2108	-2136	-2164	-2192	-2212	-2232	-2252
0000F88	-2272	-2270	-2268	-2266	-2264	-2262	-2260	-2258
0000F90	-2256	-2269	-2282	-2295	-2308	-2321	-2334	-2347
0000F98	-2360	-2349	-2338	-2327	-2316	-2329	-2342	-2355

00000FA0	-2368	-2360	-2352	-2344	-2336	-2448	-2560	-2480
00000FA8	-2400	-2433	-2466	-2435	-2404	-2405	-2406	-2407
00000FB0	-2408	-2403	-2398	-2393	-2388	-2399	-2410	-2421
00000FB8	-2432	-2432	-2432	-2432	-2432	-2432	-2432	-2432
00000FC0	-2080	-2108	-2136	-2164	-2192	-2212	-2232	-2252
00000FC8	-2272	-2270	-2268	-2266	-2264	-2262	-2260	-2258
00000FD0	-2256	-2268	-2282	-2294	-2308	-2320	-2334	-2346
00000FD8	-2360	-2348	-2338	-2326	-2316	-2328	-2342	-2354
00000FE0	-2368	-2360	-2352	-2344	-2336	-2448	-2560	-2480
00000FE8	-2400	-2432	-2466	-2434	-2404	-2404	-2406	-2406
00000FF0	-2408	-2402	-2398	-2392	-2388	-2398	-2410	-2420
00000FF8	-2432	-2432	-2432	-2432	-2432	-2432	-2432	-2432

4.2.4.4 Inverse Color Conversion

The following is a dump of the decoded 64x64 XRGB image obtained by using the [Color Conversion transform matrix \(section 3.1.8.2.5\)](#) on the reconstructed Y, Cb, and Cr component data. The Y, Cb, and Cr component data, presented in earlier sections, is in 11.5 fixed-point representation. This should be converted to floating-point representation before using the transform matrix given in section [3.1.8.2.5](#). Alternatively, the transform matrix can be appropriately modified to handle fixed-point data.

```

00000000 00229cdf 00249de0 00259fe2 002ca5e8 00229cdf 00229ce0 00239de0 00229ce0
00000008 00229cdf 00229cdf 00239ce0 00249ce0 00249ce0 00219ce3 001e9ce6 00209ae2
00000010 002299dd 002199de 00209adf 00209ae0 001f9be0 001e9ae0 001d99e0 001c98e0
00000018 001b97df 001e96dc 002194d9 001f93dd 001d93e0 001b94dc 001895d8 001c92db
00000020 00208fde 001b91de 001693df 001793df 001992df 001891df 00178fdf 00178edf
00000028 00168dde 00158cdd 00148cdc 00128cda 00118cd9 00118bd9 00128ada 001289da
00000030 001288db 001187da 001186da 001085da 000f85d9 000f84d9 000e83d9 000d82d8
00000038 000d82d8 000d81d8 000d80d7 000d7fd7 000d7ed6 000d7ed6 000d7ed6 000d7ed6
00000040 00259fe1 0027a1e2 0029a2e3 002ba4e6 00249fe1 00249fe1 00249fe1 00249ee1
00000048 00239ee1 00249ee1 00249ee1 00259de1 00259de2 00249de2 00229de2 00229ce1
00000050 00229bdf 00219ce0 00209ce1 00209ce2 00209ce2 00209ae0 002199de 001f99df
00000058 001d98e0 001e97e0 001f97e0 001d96df 001c95de 001c94e0 001c94e1 001d93e1
00000060 001d92e0 001b93de 001a94dc 001a93de 001a93e0 001992e0 001891df 00188fdf
00000068 00178edf 00168ede 00158edd 00148ddc 00138ddb 00138cdb 00138bdb 00128adb
00000070 001289db 001288db 001187db 001186db 001085db 000f84da 000e83d9 000e83d9
00000078 000e83d9 000e82d9 000e81d8 000e80d8 000d7fd7 000d7fd7 000d7fd7 000d7fd7
00000080 0027a3e3 002aa4e3 002ea6e3 002aa4e3 0026a2e3 0026a1e3 0025a1e3 0025a0e3
00000088 0025a0e3 0025a0e3 00259fe3 00269fe3 00269ee4 00279ee1 00279edf 00259ee0
00000090 00239ee1 00219ee2 00209ee4 00209de4 00219de3 00229be0 002499dc 002299de
00000098 001f98e0 001d99e4 001b9ae7 001c98e2 001c96dc 001e94e3 002092ea 001d94e6
000000A0 001a96e2 001c96de 001d95da 001c94de 001b94e1 001a93e0 001a92e0 001991e0
000000A8 001890e0 001790df 00178fde 00168fde 00158edd 00148ddd 00138cdc 00138bdc
000000B0 00128adc 001289dc 001188dc 001187dd 001086dd 000f85db 000e83d9 000e84da
000000B8 000f84da 000e83da 000e82d9 000e81d9 000e80d8 000e80d8 000e80d8 000e80d8
000000C0 002aa7e5 002da7e4 0031a8e3 002ca6e3 0027a4e4 0027a3e4 0027a3e4 0027a3e4
000000C8 0026a2e4 0026a2e4 0027a1e5 0027a0e5 0027a0e6 0026a0e5 0025a0e4 00259fe4
000000D0 00259ee3 00239ee5 00229fe6 00229fe5 00229fe4 0013a5e6 001b9fe8 0016a0e8
000000D8 0011a0e7 00129fef 00139ef7 001b99ec 00179ae2 00149ce4 001d98e5 001c97e6
000000E0 001b96e7 001c98dc 001d97df 001c96e1 001c94e2 001b94e1 001b93e1 001a93e0
000000E8 001a92e0 001991e0 001890e0 001790df 00168fdf 00158ede 00158dde 00148cdd
000000F0 00138bdc 00128add 001289dd 001188de 001187de 000f85dc 000d83da 000f85db
000000F8 001086db 000f84db 000f83da 000e82da 000e81da 000e81da 000e81da 000e81da
00000100 002caae7 0030aae5 0034abe3 002ea8e4 0029a6e5 0028a6e5 0028a5e5 0028a5e5
00000108 0028a5e6 0028a4e6 0028a3e7 0028a2e7 0028a1e8 0025a2e9 0023a3ea 0025a0e8
00000110 00279ee6 00259fe7 0023a0e9 0018a4f5 000ea7ff 001ba6de 00558ebb 006f839c

```

00000118 0089797e 008d797c 00917979 007f7b94 005687af 00229bd6 0004a4fd 00109df4
00000120 001c97eb 001c9ada 001c98e4 001c97e3 001d95e2 001c95e2 001c94e2 001c94e1
00000128 001b94e1 001a93e1 001a92e1 001991e1 001890e1 00178fe0 00158edf 00148dde
00000130 00138cdd 00128bde 00128adf 001289df 001188e0 000f85dd 000d83da 000f85db
00000138 001187dd 001086dc 000f84dc 000e83db 000e81db 000e81db 000e81db 000e81db
00000140 0030abe5 0036afe8 0034abe4 002faae5 002ba8e6 0036aee8 0026a6e8 0029a7e7
00000148 002ca8e7 002da7e6 002fa5e5 002ca5e7 0029a4e9 002ba5e5 002ca5e2 0010aaef
00000150 0013adf6 0023a3f8 006091a5 00a6755d 00ec5915 00ff490c 00fa5504 00ff590f
00000158 00ff5d1b 00ff6116 00fa6412 00ff550f 00ff4b0d 00fb4918 00f54823 008e737e
00000160 00269eda 0006a2ff 001d97e2 001799ea 001c97e4 001a98e4 001898e4 001a96e3
00000168 001b95e3 001a94e2 001a93e0 001992e1 001891e2 001790e1 00168fe0 00158fdf
00000170 00138ede 00138ddf 00138ce0 00128be0 001189e0 001087de 000f85db 00138ae0
00000178 000f87dc 000f86dc 000f85dc 000f84dc 000e83db 000e83db 000e83db 000e83db
00000180 0034abe2 003cb4ec 0034ace5 0031abe6 002daae8 0044b6eb 0024a7ea 0029aaea
00000188 002face9 0032a9e6 0035a7e3 0030a7e6 002ba8ea 0025aaf0 0020adf6 004d8ba7
00000190 00b8674c 00ff5510 00f7650c 00f86313 00fa611b 00f0671f 00fc6222 00fb6926
00000198 00f96f29 00f67122 00f3721b 00f26b20 00f16424 00ff5622 00ff531f 00ff4b17
000001A0 00ff440e 00b1615b 001f95e0 00129bf0 001c9ae5 00189ae6 00159be7 001898e6
000001A8 001b95e5 001b95e2 001995e0 001994e1 001892e2 001792e1 001691e0 001590df
000001B0 00148fdf 00148fe0 00148fe1 00128de1 00108be0 001189de 001186dd 00178fe4
000001B8 000e87db 000e87dc 000f87dd 000f85dc 000e84dc 000e84dc 000e84dc 000e84dc
000001C0 0036b1eb 0036b4f0 002eafed 002caeec 002aadec 0041b4ef 0029abe9 002cabe8
000001C8 002fabe7 0031abe6 0032aae6 002faae7 002ca9e8 0025a7eb 00946a5f 00ff3e06
000001D0 00f95618 00e27312 00f87329 00f77427 00f77626 00f27628 00f8712b 00f9772e
000001D8 00f97e30 00f77f2e 00f5812b 00f57b2c 00f5752d 00fd6a2b 00fb652a 00f65e2c
000001E0 00f1572e 00ff4810 00ff460f 00817680 0002a7f1 002496ea 00199be4 001b98e4
000001E8 001d96e5 001b96e2 001a96e0 001995e1 001794e3 001793e2 001692e1 001691e0
000001F0 001590df 001591e1 001591e3 00138fe1 00108ce0 00128be0 00158ae0 00168de2
000001F8 000f89dd 000f88dd 000f88dd 000f86dd 000f85dc 000f85dc 000f85dc 000f85dc
00000200 005fc1e7 0057bee8 004fbbbe9 004fbaae6 004ebae3 0051b6ee 002eaaee8 002eade6
00000208 002fabe5 002face7 002eade9 002eace7 002daae5 0015b2ff 00ec4310 00f15016
00000210 00f75d1c 00f87123 00f9862a 00f6882d 00f48b31 00f48532 00f47f33 00f78535
00000218 00fa8c37 00f88e39 00f7903a 00f88b38 00f98635 00f87e35 00f77635 00f76d34
00000220 00f76532 00f85e31 00f95730 00ff5125 00f65237 0003a5fd 001e9be1 001e98e3
00000228 001f96e5 001c97e2 001a97df 001896e1 001795e4 001794e3 001793e2 001692e1
00000230 001692e0 001693e2 001794e4 001391e2 000f8ee0 00148ee1 00198ee3 00148ce1
00000238 000f8bde 000f8ade 000f89de 000f88dd 000f86dd 000f86dd 000f86dd 000f86dd
00000240 003cb6ee 0036b4ef 0030b2f0 0030b1ee 002fb1ec 0038b0ef 002eaae9 002faee8
00000248 0031ade6 002fafa8 002eb1ea 0031adec 0029afee 0030aac8 00ff3d05 00fa501a
00000250 00f96021 00f87428 00f7882f 00fa9638 00f59b38 00f5973b 00f6923e 00f89440
00000258 00fa9742 00fa9a44 00fa9d46 00f99845 00f89444 00f98d43 00fa8641 00f97d3f
00000260 00f9743d 00f77039 00f56d35 00ff6122 00bf6c63 00129ee7 00229ae8 001c99ed
00000268 00179ce4 001498f0 001b94e1 001a96e2 001998e3 001897e4 001896e5 001895e4
00000270 001993e2 001792e1 001590df 001692e2 001793e5 001490e4 00128ee2 00118de3
00000278 00108de3 00118bde 001289d9 000f88e2 000c89dd 001085e0 000987e4 000987e4
00000280 0040b5e9 003bb4e9 0037b2ea 0037b2e9 0038b1e8 0033b0ea 002eaaeb 0030afe9
00000288 0033afe8 0030b2ea 002eb5ec 0034aff2 0025b4f7 008d7f86 00f64f00 00ed5c1e
00000290 00fa6326 00f7762d 00f58a35 00fea242 00f7ab3f 00f7a843 00f7a548 00f9a34a
00000298 00faa24c 00fba64f 00fcaa52 00f9a652 00f7a252 00fa9c50 00fd974e 00fc8d4b
000002A0 00fb8348 00f68341 00f1823a 00f5732c 00718cac 00179af0 002599ef 002697e9
000002A8 00269bc6 001696f1 001d91e3 001c96e3 001b9be3 001a99e6 001998e9 001b97e7
000002B0 001c95e5 001891df 00138dda 001992e2 001e98ea 001592e6 000b8de2 000e8ee5
000002B8 00108fe9 00128cdf 001489d4 000e88e6 00088cdc 001184e4 000488ec 000488ec
000002C0 003eb6ea 003bb5eb 0038b4eb 0038b3eb 0035b2eb 0033b1ec 0034b1eb
000002C8 0035b1ea 0032b3e9 0030b5e9 0034b0f0 0023b6f8 00c56044 00f9540c 00f26322
000002D0 00f77029 00f77d2f 00f78b35 00fba142 00f6b046 00fbb44f 00f7b051 00f9af54
000002D8 00fbad56 00fcb25a 00feb75d 00fab35f 00f6b061 00faac5d 00fda95a 00fb9f55
000002E0 00f99551 00f7914b 00f68d45 00ff7e23 001ba5f0 00129ef4 002896f1 00239fb1
000002E8 006c9600 003c9c82 00179ef8 00169cf4 00149de3 00169ae5 001897e7 001995e6

000002F0 001a93e5 001993e3 001793e0 001c98e6 001a95e5 001692e5 00138fe5 00138ceb
000002F8 00138be3 000087e4 00007cf5 001a86d3 000d8cf1 00008fe2 000d85ea 000886f1
00000300 003cb7ec 003bb7ed 003ab6ed 0039b6ed 0038b5ed 0037b5ed 0037b4ed 0037b3ed
00000308 0036b3ec 0034b4e9 0031b5e5 0035b1ef 0021b8fa 00fd4203 00fc581e 00f86a26
00000310 00f47c2d 00f78431 00f98c36 00f8a041 00f6b54d 00fec05b 00f6bc5a 00f8ba5d
00000318 00fbb861 00fdb6e5 00ffc469 00fbc16c 00f5bd70 00fabcb6b 00febb66 00fab160
00000320 00f6a75a 00f89f55 00fa984f 00df956f 0008a6fc 00259ddb 00159ff3 004aa172
00000328 0069a90d 0062a406 005a981b 0034969b 000e99ff 001297f2 001695e4 001793e5
00000330 001892e5 001995e6 001a98e7 00209deb 001593df 001892e4 001a91e9 002095eb
00000338 00259dd1 00d0f772 00c1f396 000083f1 001782a0 003c7e2f 001787cc 000b8ada
00000340 003db9ed 003cb8ed 003bb8ed 003ab7ed 0039b7ed 0039b7ed 0039b6ed 003ab6ed
00000348 003ab6ed 0037b4ed 0034b2ec 0035abf3 006e96b3 00ff4601 00f86520 00f67329
00000350 00f58131 00f78b37 00f9953e 00f8a649 00f8b854 00fcc260 00f8c465 00f9c36a
00000358 00fac26e 00fac773 00facb77 00fbcb7b 00fccb7e 00fac87b 00f8c578 00f9bc72
00000360 00fbb46d 00f6b069 00feaa57 0094a0a5 0013a1f3 00219df0 00199eff 0071c124
00000368 0079b826 0072b21e 006aaa24 0067a125 00649a19 00419d72 001f9fcb 001994ff
00000370 001399f1 00199cf4 001ea0f8 001b9cff 001193f6 001293f1 001393ec 000083ff
00000378 0072cca0 00cbf982 00d0ffac 0079a046 00337700 003a7c03 000d8de2 000d8edb
00000380 003fbbec 003ebaed 003db9ed 003cb9ed 003bb8ed 003bb8ed 003cb9ee 003cb9ee
00000388 003db9ef 003ab4f1 0037aff3 0032b3fe 00b48f7d 00ff5907 00f37122 00f57c2b
00000390 00f68735 00f7923d 00f89d45 00f9ac50 00f9bb5a 00f9c465 00facd71 00facd76
00000398 00facd7b 00f7cf80 00f4d286 00fcd689 00ffd98c 00fbd48b 00f3cf8a 00f9c885
000003A0 00ffc17f 00f5c27d 00ffbc5e 0048abcd 001e9deb 001ea2e8 001da8e5 0099d31c
000003A8 008ach22 0082c427 007abc2c 0075b429 0070ad25 006dab17 006ba908 005ea912
000003B0 00519f54 00489b6d 003e9887 003b9592 00389880 00449663 00509446 0083b43c
000003B8 004f851b 00afe187 009fcc83 00368011 0043821c 0032853c 000492f9 001092dd
000003C0 0040bcee 003fbcee 003ebbee 003dbaed 003cbaed 003cb9ed 003cb9ec 003cb9ec
000003C8 003cb8ec 003fb4f0 0043aff5 000ebbe9 00ffb897 00f7814d 00f57623 00f6812e
000003D0 00f88c39 00f89943 00f8a64d 00f8b257 00f9bd60 00fac96d 00fbd47b 00fad681
000003D8 00fad788 00fbd98e 00fbd98e 00fae5a1 00fed692 00fadea0 00f9db98 00fad694
000003E0 00fbd090 00ffd285 00ffc778 00009afd 0026a8f2 0020a4f8 0053bea5 00a4da31
000003E8 009dd638 0097d03a 0091ca3d 008bc539 0085c035 007dbe31 0074bc2d 0076b81c
000003F0 0077b027 0072ab25 006da724 006ba328 0068a31f 0058951a 0078b745 00bbf181
000003F8 0073ad4c 00417c15 00508b1e 0043861c 00498614 0017868b 000b90f6 00168ee8
00000400 0042beef 0041bdee 0040bcee 003fbced 003ebbed 003dbaec 003db9eb 003cb8ea
00000408 003bb7e9 0039b9f0 0037bbf7 0050b5dc 00ff9744 00fec49d 00f87a24 00f88530
00000410 00f9913d 00f8a049 00f7af55 00f8b85d 00f9c065 00face75 00fcd885 00fbde8d
00000418 00fae195 00fee29b 00ffe2a0 00f9e9a4 00ffbe6b 00fdde9f 00ffe8a6 00f9e3a3
00000420 00f8dea0 00fdd899 00b6bdab 00119ff1 001ea4e9 001a9fff 0089d465 00b0e245
00000428 00b0e04e 00acdc4e 00a7d94e 00a1d649 009ad345 0097ce3d 0094c935 008dc534
00000430 0086c133 007bbc32 006fb731 006db330 006cae2e 007eba3f 0070a531 007bb54f
00000438 00579a20 005c9f2b 00519425 0080b965 00609a1d 000390e3 00118ef2 001c89f2
00000440 0044c0ef 0043bfef 0042beee 0040bdee 003fbcee 003fbbed 0040baeb 003eb9ed
00000448 003cb9ee 0037b9eb 0027bcf7 00949c8f 00fb9637 00f9bc7c 00f9b585 00f7994a
00000450 00f69b43 00f6a64e 00f7b259 00f8bc66 00fac672 00fad380 00fae08d 00f9e698
00000458 00f9eba2 00feea6 00ffeaab 00fcefa9 00faba62 00fbdc99 00fff4b9 00f9ebc2
00000460 00f7e6ab 00ffe5a3 0064b1d1 00199ff0 00269fe9 000499f2 00e3f051 00d5ef58
00000468 00c0e364 00bde165 00bae065 00b5de5d 00b0dc56 00aad74e 00a3d346 009bd043
00000470 0093cd3f 008cc93e 0084c63c 0081c139 007dbc36 008bc746 0089c245 0063a02c
00000478 0065aa2c 005ea42d 00509626 00a4cf98 00d9eadd 00b9ddff 00389ef4 00008fd4
00000480 0046c1ef 0044c0ef 0043bfef 0042beef 0040bdef 0042bced 0043baec 0040baf0
00000488 003dbaf4 0035b8e7 0017bdf7 00d97f50 00f79147 00f7a554 00ffdbba 00f8a24d
00000490 00f3a549 00f5ad53 00f7b55e 00f9c16f 00fbcc7f 00f9d88a 00f8e595 00f8eda2
00000498 00f8f5ae 00fff3b2 00fff2b6 00fef5ae 00f4b659 00f9db93 00feffcd 00fbf6c1
000004A0 00f7edb6 00fff2ac 0013a4f7 0016a5f0 0018a5e8 0056b4cd 00f1f271 00d5ef84
000004A8 00cfe67b 00cde77c 00cbe77c 00c9e672 00c7e567 00bce15f 00b1dd57 00a9dc51
000004B0 00a0da4b 009dd749 009ad447 0094cf43 008fcb3f 0088c43c 0082be39 0072b430
000004B8 0063a928 0059a028 004e9827 00a0c479 00fffbf7 007fd3f5 00038fe2 000e89e2
000004C0 0048c3ef 0046c2ef 0045c1f0 0043c0f0 0042bfff0 0042beee 0043bdec 0041bcef

000004C8 003fbcf2 002fc0fe 0036bdfc 00f54c00 00ff8a52 00faa65e 00fdc48e 00fbc185
000004D0 00f5ae50 00f7b65e 00f9be6c 00fac978 00fbd485 00fed9e8 00ffe8aa 00fdeeeae
000004D8 00f9f5b2 00fcf6ba 00fff7c2 00fcf0b2 00f7cc6e 00fbde91 00fdfcca 00fffbdb1
000004E0 00fffd8c 00cae4c8 0016a1f2 001da4ef 0012a1f1 009fd5b9 00eaf28c 00dcf095
000004E8 00d9eb90 00d9ec93 00d9ec95 00d6eb8c 00d4ea83 00c9e779 00bfe3f6 00b8e368
000004F0 00b1e262 00afe05e 00addf5a 00a3d952 0099d449 008ecb41 0084c33a 0075b833
000004F8 0066ac2c 005da329 00559927 004b9421 002499b9 001593fe 000993d8 00f90d8
00000500 004ac5ef 0048c4f0 0046c2f0 0045c1f1 0043c0f1 0043bfef 0043bfed 0042beee
00000508 0041bdf0 0038bbf0 0072a1b8 00ff5d1e 00f97931 00f5a151 00f9ad61 00fee0bd
00000510 00f8b758 00fabf69 00fcc87a 00fcd282 00fcd8b 00fbde8f 00fbel93 00fbeb48
00000518 00fbf5b5 00faf8c2 00f9fcce 00f9ecb7 00fae183 00fee290 00fbfac8 00fdf8d8
00000520 00fffccb 008bcedc 00189fee 0025a3ee 000b9dfb 00e8f6a5 00e4f1a6 00e4f0a6
00000528 00e4efa6 00e5f1aa 00e6f2ad 00e3f1a6 00e0ef9e 00d7ec93 00cde987 00c8ea80
00000530 00c2eb78 00clea73 00c0e96e 00b1e360 00a3dd53 0094d247 0086c83b 0078bc35
00000538 0069b030 0062a52b 005b9b27 0057920a 000995fc 000d96e5 001091eb 001091eb
00000540 004ac5f0 0049c4f0 0047c3f1 0045c2f1 0044c1f2 0041c1f2 003fc1f2 003fbff1
00000548 003fbcf0 0032c3fe 00be7f6e 00fe6526 00f67b35 00f59a4d 00f8ab5c 00fbd0a0
00000550 00f7c783 00fec16b 00fdd17f 00fbd87 00f9e590 00f8ed9a 00f7f4a5 00fbaea9a
00000558 00ffdf8e 00fce3a0 00f7e6b1 00fceecc 00fffbcb 00fff3c7 00fcf1c3 00fef5d2
00000560 00fffd3 004bb5e7 0021a5ed 001ca2ee 003daae2 00eef6ac 00e6f2b1 00e8f2b5
00000568 00e9f3b8 00eaf4ba 00ebf5bc 00e8f3b6 00e6f2af 00e0f0a8 00dbee2 00d6ef9a
00000570 00d1f092 00c9ed82 00c1eb73 00b0e362 00aldc51 0094d347 0088ca3e 007bbf38
00000578 006eb433 0066a92e 005da01b 003d9448 00a93f6 000e94ec 001193f0 001193f0
00000580 004bc5f1 004ac5f1 0048c4f1 0047c3f2 0045c3f2 0040c3f4 003bc4f6 003cbff3
00000588 003ebbf0 002dcaff 00ff5d25 00fe6d2f 00f37d39 00f59348 00f8a958 00f7c083
00000590 00f7d7ae 00ffc36d 00ffda84 00fbe48c 00f7ee94 00f8ed9e 00faeca7 00f9f1b4
00000598 00f8f6c1 00fcf6c8 00fff6d0 00fef2d3 00fcf4ba 00fff6e8 00f7fdea 00fdfde3
000005A0 00fffcdb 000b9df1 002aaaed 001baaf6 0080c8da 00fdffbb 00e8f2bd 00ebf4c4
000005A8 00eff7cb 00eff7cb 00eff7cb 00edf6c5 00ebf5c0 00eaf4be 00e8f3bd 00e4f4b4
000005B0 00e0f6ab 00d0f191 00c1ec77 000e463 009edb4e 0095d448 008bcc42 007fc23b
000005B8 0073b935 006aac31 0060a510 00229687 000b91f1 000e93f3 001294f5 001294f5
000005C0 004cc6f1 004bc5f2 0049c5f2 0047c4f2 0046c4f2 0043c4f1 0040c4f0 0042c0f3
000005C8 0039c1f6 005eacca 00fb591e 00f36e31 00f88135 00fb923f 00fbaf5e 00ffc373
000005D0 00fde2ba 00ffcd75 00ffd372 00ffe584 00fff796 00fef4a2 00fdf1ae 00fff8c2
000005D8 00fcf8cd 00fef8d2 00fff9d6 00fef6e1 00fcf5dd 00fffbee 00fbfce8 00fffce0
000005E0 00b2e0e8 0019a4f0 0026abec 0016a8f6 00c2e4d8 00f9fac5 00eff6cb 00f0f7ce
000005E8 00f1f8d2 00f1f8d1 00f2f9d1 00f1f9cd 00f1f9ca 00f2fbca 00f4fdca 00e7f8b6
000005F0 00daf3a2 00cbef8a 00bcec71 00b0e661 00a5e151 009ad949 008fd240 0083c73b
000005F8 0077bc35 006ab31d 005ea905 00138dea 001193ef 001093f0 00f93f0 00f93f0
00000600 004dc6f2 004cc6f2 004ac5f3 0048c5f3 0047c5f3 0046c4ef 0046c4eb 0048c0f3
00000608 0034c7fb 00989591 00fc6428 00f1773b 00fc8432 00ff9135 00ffb564 00ffbe5a
00000610 00f3ddb6 00ccd097 00b4cea5 00b0d3b1 00abd7bd 00c3e1bf 00daebc1 00f5fdc7
00000618 00ffffbd 00fffecb 00fffcdb 00fffce0 00fbfce5 00fdfbe6 00fffae7 00fffbdd
00000620 0061c4f4 0026aaee 0022abec 0010a7f6 00ffffd7 00f5f5d0 00f6fad9 00f4f9d9
00000628 00f2f9da 00f3fad8 00f4fbd7 00f5fcd5 00f7fdd4 00f3face 00f0f7c8 00e2f4b0
00000630 00d4f199 00c5ee82 00b7eb6b 00b1e95f 00abe754 009fdf49 0094d83f 0087cc3a
00000638 007bc034 006bb425 005ba332 000495f9 001795ee 001293ed 00c91eb 00c91eb
00000640 004fc8f3 004dc8f3 004cc8f4 004bc8f4 0049c8f4 0047c5f2 0045c2ef 0042c2f8
00000648 0034c8ff 00df6746 00ff632a 00ff701b 00e18b53 00a4a185 0063c1ed 0026c0ff
00000650 002ab8ff 0025b5f1 0027b7f9 0026b5f6 0023b3f2 0024b5fa 0025b7ff 00189ddf
00000658 0043bbf4 009edae8 00f9f9dc 00f3fbe6 00ffffea 00fdffe6 00fafce2 00ffffff
00000660 001ea8ef 001ca8f1 001ba8f2 005bc4f1 00ffffe7 00fbf9e1 00fbfce3 00f8f8e0
00000668 00f5fadd 00f5f5db 00f5fbda 00f6fcd7 00f6fdd3 00f0f8c9 00ebf4be 00dff2a9
00000670 00d4f094 00c7f47b 00baf862 00b0ef58 00a6e64e 00a3e248 0098d73a 008acd38
00000678 007bc435 0070b821 003b9c84 000d93f4 001394ed 001193e9 00f92e6 00f92e6
00000680 0050c9f4 004fc4f4 004ecaf5 004dc4f5 004ccaf6 0048c5f4 0045c0f3 0047c2ef
00000688 004ac4eb 00ff521f 00a79a92 0051b7e6 0028c7ff 002cc4f9 0031c1f1 003fbbf0
00000690 0037c0ef 0039b9f0 003bb3f1 0038b5f4 0036b7f7 0032b9f0 002fbb8e 002fb8eb
00000698 002fb5ed 0020acf3 0010a3fa 0070c9f3 00f5f9df 00f6fbde 00f6fdde 00d8ebe4

000006A0 0011a5ee 002db2f5 0014a5f8 00a5e2ec 00ffffff8 00fffeff3 00fffded 00fcfde6
000006A8 00f8fce0 00f7fcde 00f6fcdd 00f6fcd8 00f5fdd3 00edf7c4 00e5f1b4 00e5f5b8
000006B0 00e4f9bb 00ecfed2 00f3ffe9 00edfedb 00e8f9cd 00caef89 009cd636 0084c72e
000006B8 006bb826 006cb315 001a95d6 001591ef 001093eb 001193e6 001294e1 001294e1
000006C0 0052cbf4 0050caf4 004ecaf4 004ccaf3 004ac9f3 0048c8f5 0046c7f6 0040bfed
000006C8 0041bfeb 0041d4f9 0033c9fc 002fc9ff 0042c3ec 0040c3f4 003ec3fc 0035bbf4
000006D0 0033bbf3 0049bdf7 0039b7f9 0037b7f6 0035b7f2 002eb5f4 0028b3f5 002fbbf8
000006D8 002fbaf2 0030b5f2 0031b0f1 001facf6 000dabed 007fd2ed 00fffff6 0080d9d2
000006E0 002faaf8 001dafec 0003aae6 00fff8ff 00fffffe 00fffff9 00fffd4f 00fdfeeb
000006E8 00fbfee3 00f9fde1 00f7fce0 00f5fdd8 00f4fddf 00f5fce2 00f6fde8 00f3fde8
000006F0 00f1fde9 00ebfdd3 00e6fdba 00e0f8ba 00daf2b7 00eafcd2 00f2fde6 00b7de8d
000006F8 0084c73d 009ab848 0014a1f9 000494f3 001094ef 001095ec 001095e9 001095e9
00000700 0054ccf5 0051cbf4 004ecaf3 004cc9f2 0049c8f1 0048cbf5 0048cef9 0040c4f3
00000708 0049cafc 0040c2f1 0047caf5 0046c7f4 0046c4f3 0039b5ee 002ca5e8 002eb1e1
00000710 0056c1ea 006dc9e9 0037c2e5 0051caeb 006bd2f1 0074d1f5 007dcff9 0056c7f8
00000718 001fafe8 0025blee 002cb3f4 003eb5f9 002bb3ee 001baff5 0032b5f0 003fb2f9
00000720 0026a9f2 001faeeb 003fb8f4 00fcfff3 00fffff3 00fffff3 00fffffb 00fffff1
00000728 00feffe6 00fbffe5 00f8fde3 00f5fdd7 00f3fecb 00f5fbeb 00f7feee 00f2fdde
00000730 00edfccf 00e3f9b0 00d9f692 00d2f48b 00ccf184 00ceee97 00d0eaa9 00daebc1
00000738 00f4fbe9 007fc679 005ac1ff 001aa1eb 001195f2 00f96f2 000e97f2 000e97f2
00000740 0054cdf5 0052ccf4 004fcbf3 004dc9f3 004ac8f2 0049c6f2 0047c4f2 0049d2f3
00000748 0046c8f3 004dc5fc 002c9add 001883cd 00046cbe 000080c5 00f96d4 002eaddb
00000750 0060c6eb 0076cdef 0051caea 0069d2f0 0081daf5 009ae4f7 00b3eff9 00cfaaff
00000758 00e3feff 009ae1ff 0048bcf7 0011b5dd 0032aef0 0028acfc 0031b2f3 0034b1f6
00000760 0025adf0 0026acf6 0098d1fc 00fffdff 00fffffb 00fffffb 00fffffb 00fdfee
00000768 00fcfde7 00fbfee4 00faffe0 00f8fde7 00f7fcef 00f3fbeb 00effdd9 00e9fbc2
00000770 00e3f9ac 00d9f49b 00ceef8b 00c1ea76 00b4e562 00abdd5a 00a2d261 00c1e98e
00000778 00dbe8b9 0096d4ff 008ed0fa 0042aeef 001095f1 001096f1 00f96f1 00f96f1
00000780 0055cef5 0053ccf4 0050cbf4 004ecaf4 004cc8f4 0051caf7 0057cbfa 0045c0ea
00000788 001a75c7 000058ad 00015bb4 00066fc0 000b84cd 000093ce 0011a7e0 003eb9e6
00000790 006bcbeb 007ed1f6 006cd3f0 0082dbf4 0098e3f9 00a5ecf7 00b2f4f5 00c7f7f9
00000798 00ddfafd 00f2ffff 00f8fff6 00bcebfe 0022b4f2 0029afff 002fb0f7 0029b1f2
000007A0 0023b1ee 001aa7fa 00cae6f4 00f7f8f4 00feffff 00fefff7 00fefff7 00fcffeb
000007A8 00fbfae9 00fbfee3 00fbffdc 00fbffe9 00fbfff7 00f1fedd 00e7fbc3 00e0f6b4
000007B0 00d8f0a5 00ceec94 00c4e884 00b8e678 00ace36c 00a0df53 0094d455 0080bd1e
000007B8 00d2e599 002ca1f4 0030a2f6 00209cf3 001096f1 001096f1 001096f1 001096f1
000007C0 0055cef4 0053cdf4 0051cbf5 0050cbf5 004ecaf6 004dc9f4 0054d0fa 002b86ce
000007C8 000752b1 00045fb9 000a74c9 000882ce 000691d4 0002a0d5 0024b5e7 004cc4ea
000007D0 0074d3ee 0083d9f5 007fddf4 0093e4f6 00a8ecf9 00b6f2f9 00c3f9f9 00d3fafb
000007D8 00e3fcfc 00edfefb 00f0f9f3 00ffffff 00fffdff 007edcef 0026adfd 002aaff7
000007E0 002db2f2 0034b1e0 0009a7f7 008dd3f5 00fdfbf9 00fffff6 00fdffeb 00fcffe6
000007E8 00fcfce0 00f9fcde 00f7fcdd 00fcffef 00f9fdec 00e8f5d0 00dff5bd 00d9f1ad
000007F0 00d2ed9d 00c5e97e 00b8e26d 00abdd5e 009fd74f 0098c95f 0092c735 008bc942
000007F8 0080b34d 00009bf2 001894f8 001595f5 001397f2 001296f1 001195f0 001195f0
00000800 0056cff4 0054cdf5 0052ccf5 0051cbf7 0051cbf9 0049c8f1 0051d5fa 001662c1
00000808 00005cbb 000874cd 00037cce 00028dd4 00019edb 0009aedc 0037c2ee 005acfef
00000810 007edcf0 0088e1f4 0092e6f8 00a5eef8 00b9f5f9 00c7f9fb 00d5fdfe 00dfdfdc
00000818 00e9fdfa 00f0fefc 00f8ffff 00fafffe 00fdfff3 00fdfff3 001db0e8 002ab1ee
00000820 0037b2f5 0025b9f7 0029b4f8 0022aff5 001baaf2 009fd7f6 00fdffea 00fcfee0
00000828 00fcfd7 00f8fada 00f4f7dd 00fdfef5 00f6fae1 00dfec3 00d8efb6 00d2eca6
00000830 00ccea95 00bce567 00abdb56 009fd344 0092cb33 0085c824 0079b46a 003a9eaf
00000838 00c97ff 001994f9 00f9bee 00139af0 001699f3 001497f1 001295ef 001295ef
00000840 0058d0f5 0056cef5 0053cdf4 0053ccf6 0052cbf8 0053d6fb 004fc8fc 00004cad
00000848 00096fca 000b80d4 000588d5 000598db 0005a8e1 0018b6e6 003fc8f2 0063d3f3
00000850 0086dff5 0091e4f7 009ce9fa 00aef0f9 00c0f7f9 00cbfafb 00d7fdfd 00defdfc
00000858 00e6fefb 00f0fffe 00faffff 00f2fefb 00fefff3 00c6e9fb 001eb0ec 0030b4f6
00000860 0030b7f8 0019a8f7 0026b0f0 0022aef3 001eabf5 0027aafa 001ca6f6 007dcdea
00000868 00dff4dd 00eaffb0 00fdfeed 00ffffef 00fcf9d3 00edeeb4 00e6e9ac 00d9e68a
00000870 00cbe367 00b9e153 00a6dd4d 0075c57f 0043adb0 00229bf3 000a9cff 000998f6

00000878 00109cef 00189aee 00149ded 00159bf0 001599f2 001397f0 001195ee 001195ee
00000880 005ad1f6 0057cff5 0054cef4 0054cdf6 0053cbf8 004dd3f4 002c9add 00045ec1
00000888 000572c9 000683d2 000794dc 0008a2e2 0008b1e8 0028bfef 0048cef6 006bd8f8
00000890 008fe3fa 009be8fa 00a6edfb 00b7f3fb 00c7f9fa 00d0fbfc 00d9fdfd 00defefd
00000898 00e2fff0 00efffff 00fcffff 00ebfef7 00ffffff 008fd7f8 001eb0f1 002eb0f6
000008A0 0018abec 00e0f7fd 0024ade9 0023acf1 0021acf8 0026aef7 002cb0f6 001aa9f5
000008A8 0008a3f4 0022a7f9 004cc2f2 006dcdef 007ec9db 007fcac2 0081c6c6 0061bccb
000008B0 0041b3d0 0024a7e9 00089bff 00119dff 001a9fff 000f99e9 00149cf9 00159cf7
000008B8 00159cf5 00179df1 00199eed 00179cef 001599f1 001397ef 001195ed 001195ed
000008C0 005cd2f6 0059d0f5 0055cff3 0054cdf5 0053ccf8 0051d5f6 00167bcf 000467c6
000008C8 00067bcf 00068bd7 00059cdf 0008a9e5 000ab6eb 002bc4f1 004cd2f7 006ddb9f
000008D0 008ee5fa 009deafb 00aceffb 00bdf5fb 00cefbfa 00d5fbfc 00dcfcfd 00dcfefd
000008D8 00ddfffd 00e4ffff 00eafffd 00ffffff 00ffffff 0027c0de 0026b5f6 001fb0f9
000008E0 004dc6ff 00fff9ef 00feffff 008bd8f7 0018a7f3 001daaf4 0023acf6 0022acf3
000008E8 0022abf0 001aa3f2 001aa6ee 0018a8f5 000ea2f3 0011a4f2 0014a4ff 0015a3fc
000008F0 0016a3fa 0017a2f3 0019a2ec 000e99fe 00169bed 0000a1ff 002b9de8 0061b5b0
000008F8 00109af7 00149cf2 00189eed 00169cef 00149af0 001298ee 001096ec 001096ec
00000900 005fd3f7 005bd2f5 0056d0f3 0055cef5 0053cdf7 0056d8f8 00005cc0 000370cb
00000908 000785d6 000594dc 0004a3e2 0008afe8 000cbcee 002ec8f3 0050d5f9 006fdefa
00000910 008de7fb 009fecfb 00b1f2fb 00c3f7fb 00d4fcfa 00d9fcfc 00defcfd 00dbfdfd
00000918 00d9ffff 00d9fdfb 00d9fcfa 00e5fafa 00a4eaf7 002badfb 002fb9fa 001aaeed
00000920 0099dbf8 00ffffff 00fedfcd 00fffffd 00ffffff 008cd4fa 0019a9f6 0018a9f7
00000928 0016aaf9 001aa7f3 001ea5ee 001fa7f2 0021a9f6 001ea7f7 001ba5f7 0017a4f9
00000930 0012a2fb 000b9dfd 000399fe 0026a2fa 006fc0b0 00cfa5e 00ffe528 0074b4b3
00000938 000b98fa 00119af4 00179dee 00159cee 00139aef 001198ed 000f96eb 000f96eb
00000940 005dd1f6 005bd2f5 0058d2f4 0053cef4 0056d2fb 0040b2e6 000164c6 000376cf
00000948 000487d7 000296dd 0001a4e4 0004b1ea 0007bdf1 001bc8f2 0043d5fc 0064ddfb
00000950 0085e6fb 0098ebfc 00acf1fd 00bef9ff 00cfffff 00cfdfff 00cfff9b 00d2fefefe
00000958 005fffff 00c6f9ff 00b8efff 005ad7d9 0040b9e9 002fb9ff 002bb2f0 0028afeb
00000960 00def0f2 00ffffff 00ffffff 00ffefef 00ffefef 00ffefef 00ffffff 00ffffff 00c2e8f0
00000968 0084cde7 0053bbe9 0022a9eb 0014a1ff 00069ff8 000fa0f8 0019a3eb 0043b1e1
00000970 006ec2c9 00b0d79a 00f2eb6b 00ebee32 00f8e647 00ffe23a 00fde142 000098f4
00000978 0019a1fc 00169ef7 00129bf1 00139af1 00149af0 001298ee 001096ec 001096ec
00000980 005ccff6 005bd2f6 005ad4f6 0052cdf2 005ad6fe 00298cd5 00026ccc 00027bd2
00000988 000189d8 000097df 0000a6e6 0000b2ed 0002bef4 0009c7f1 0035d5ff 0059ddfd
00000990 007ce5fb 0091eafd 00a6f0ff 00b1f2ff 00bbf5ff 00bef5fc 00c1f6f9 00c1f7f7
00000998 00c1f9f4 00c7fdfc 00cdffff 00c2f9f8 005acd4f 0039b1f3 0038baf5 002ab4f7
000009A0 00fcfbf8 00fdfeff 00feffff 00ffffef 00ffffc6 00fdfeff 00f7ffee 00fcffea
000009A8 00ffffe5 00ffffd8 00ffffcb 00ffffb1 00ffffdf 00fdffc2 00f7ff88 00fbfe92
000009B0 00ffff7f 00fdffc6 00faf759 00f8f059 00f7e958 00f7e359 00d0d368 000998ff
000009B8 00189aef 00129af2 000c99f5 001199f3 001599f2 001397f0 001195ee 001195ee
000009C0 005fd2f9 005cd3f8 0059d4f6 0058d3f8 005edaff 001971cd 00026ecd 00037bd3
000009C8 000488d9 000497e0 0005a6e6 0001ade7 0000b5e8 0007beea 0023cbf5 004cd7f8
000009D0 0074e4fc 0089e8fd 009fecfe 00a5edfe 00abeffe 00aeeffc 00b0eff9 00b3f3f9
000009D8 00b6f6f8 00b6f9fc 00b5fcff 00daf3ff 001ab9f1 0028b3f4 002bb3f6 0073cef4
000009E0 00fdfd5 00fdfeff 00fdffff 00ffffef 00ffffd3 00fdfeff 00faffe9 00fdffe4
000009E8 00ffffde 00ffffd0 00ffffc2 00fdfad7 00ffffc3 00ffffc0 00fcfb5 00fcff84
000009F0 00fcfb8b 00fbf67a 00f9f269 00f7ed5e 00f4e954 00f7e948 0087bda9 00109af4
000009F8 00179cf2 00149bf1 00119af1 001399f2 001698f3 001496f1 001294ef 001294ef
00000A00 0062d4fc 005dd4f9 0059d4f6 0056d1f6 0053cef5 00014ebe 00026fcd 00057bd4
00000A08 000787da 000996e0 000ca5e7 000bb0e9 0009bbeb 0015c5f3 0021d0fc 0046dafc
00000A10 006ce3fc 0082e6fd 0097e9fe 0099e9fe 009ce8fe 009ee9fb 00a0e9f9 00a6eefa
00000A18 00acf3fc 00b0effc 00b5ecfb 0089ddf9 0028b4f3 003ebef7 00leadf7 00bde8f0
00000A20 00fefff2 00fefff3 00fdfff4 00fefef2 00fefef0 00fefee4 00fefede 00fefede
00000A28 00fefed8 00fcffc9 00fbfba 00f6fea0 00ffffce 00fff9f6 00ffffc9 00fd7be
00000A30 00f8f87a 00f9f66b 00f9f35c 00f5ee56 00f1e84f 00f8ee37 003fa7ea 00189df5
00000A38 00179df4 00169cf1 00159bee 00169af2 001798f5 001596f3 001394f1 001394f1
00000A40 0066d7fc 005fd1f5 0060d4f6 0059d8f9 00399ddb 000858be 00096ccd 000c7ad2
00000A48 001087d7 001296df 0013a6e8 0013b0eb 001bc3f5 000fc8f3 0017d0f9 0027d3f4

0000A50 004bd7f7 0061dbf8 0077def9 007fe0fa 0088e1fa 008de4fb 0091e7fb 0096eafc
0000A58 009aedfd 009feafb 00a3e7fa 005eccfb 002db7f5 0024b8f9 0014b1f5 00ffffbf
0000A60 00fefeec 00ffffff 00ffffee 00ffffec 00fefdeb 00fefde4 00fefddd 00fefed6
0000A68 00fefece 00fcfdcl 00fcfcb5 00f6fb8d 00f8fc8a 00f8facc 00f8fef2 00f9ffbe
0000A70 00fbf9c2 00fbf8ac 00fcf796 00faf491 00f7f18d 00ffe5a9 000096f7 00089af7
0000A78 00159ef7 00169df4 00169cf0 00169bf2 001699f4 001497f3 001396f1 001396f1
0000A80 006bd9fb 0061cef1 0067d3f7 005cdefd 001f6cc0 000f63bf 000f6acd 001478d1
0000A88 001887d4 001997df 001aa6e9 0014a9e4 001dbbef 000dbeeb 0023c5f6 0013c6ed
0000A90 002acb3f 0040cff4 0056d4f4 0065d7f6 0074daf7 007bdfb 0083e5fe 0086e6fe
0000A98 0089e8fd 008ee5fb 0092e2fa 0033bcfc 0032b9f7 0031bafd 0057c5f7 00f4ffde
0000AA0 00fdffe7 00ffffe7 00ffffe7 00ffffe6 00fdfce6 00fdfd 00fdfd 00fdfd
0000AA8 00fefd3c 00fdfaba 00fcf8af 00fef99f 00fffb8e 00fafe77 00f4fb7d 00f9f8d2
0000AB0 00fdffee 00fefedf 00fffc0 00fefacd 00fdf9ca 00a6d3ce 000399eb 001ea1ec
0000AB8 00149ffa 00159ef6 00179ef2 00169cf3 00159af3 001499f2 001398f1 001398f1
0000AC0 0055d4f4 005bd1f1 0069d6f6 006ee2ff 000c50a8 001161be 000f6acd 001f83d6
0000AC8 001f89cd 000f8cdd 001a9be0 0022b1f4 001dabe1 0014aedf 0026bdee 0015bae7
0000AD0 001fc1ef 0025c7ef 002bcbef 003cdcf1 004ecef3 005bd6f9 0068defe 006ddfc
0000AD8 0073ddfb 0076ddf5 0070d3f7 0031bafb 0033b9f6 0024b6ff 00a4dee5 00f9ffdc
0000AE0 00fdfedc 00ffffdc 00ffffdc 00fefedb 00fcfd 00fdfd 00fdfd 00fdfd
0000AE8 00fefd3c 00fdfbaf 00fcfaa2 00dfb93 00fefb83 00fcfd6b 00f9fc60 00fbf85d
0000AF0 00fd74c 00fef576 00fff2a1 00f6ec87 00f8e360 0051bbb4 000d9afe 001a9ef7
0000AF8 00159ef6 00159df4 00159df2 00149bf2 001299f2 001299f2 001299f2 001299f2
0000B00 0067d4fd 0069d6f9 006cd9f5 004fb7dc 001953af 001c67c6 00005abd 001a7eca
0000B08 00157bd4 000581dc 002aa1e7 000189d3 002dabe3 0023a7dc 0029b4e6 0017ade1
0000B10 0014b7ec 0015b9ea 0016bbe9 001fbfec 0028c2ef 003bcd7 004ed8ff 0056d5fb
0000B18 005dd2f8 005ed6f0 004ec5f4 002fb9fa 0035b8f4 0017b1ff 00f0f7d2 00feffda
0000B20 00fd3cd2 00fd3dd1 00fd3ed1 00fd3ecf 00fd3ecd 00fd3cd7 00fd3cd0 00fd3db9
0000B28 00fd3db2 00fd3ca4 00fd3c95 00fd3c87 00fd3c79 00fd3fa6 00fef85f 00f9f645
0000B30 00f6ef47 00f2e938 00efe428 00eee425 00fdd05 000399ff 0017alf5 00179ef4
0000B38 00169cf3 00159cf3 00149cf3 00129bf1 001099f0 00119af1 00129bf2 00129bf2
0000B40 0066d5fb 0070d5fc 0078e2ff 003b86c7 00235fba 001e6aba 00227ad1 002787d8
0000B48 00248cd7 001d8dd4 002189d1 002ca1ea 002296d5 0031aaef 0020ald 0017ald
0000B50 000ea1e0 001aaec3 0013b1eb 0010b8ed 000dc0ef 001cc1ef 002cc3f0 0036c4f2
0000B58 0040c5f4 0047c9f2 0045c3f6 0031bafa 0031b7f7 004cc2f4 00f5fac0 00fdffc6
0000B60 00fd3cc5 00fd3dc4 00fd3dc4 00fd3dc2 00fd3dc1 00f8f9b6 00fd3db3 00fd3db3
0000B68 00fd3ca3 00fcfc95 00fcfb88 00fcfb7b 00fbfb6d 00fcf962 00fcf757 00f8f245
0000B70 00f4eb41 00f0e532 00ebe023 00fbc01c 00c5d244 000aa2fe 00169ff9 00179ff6
0000B78 00189ff3 00179ef2 00159df2 00179ff5 0018alf8 00159ef5 00129bf2 00129bf2
0000B80 0065d7fa 0064d1f7 005de7ff 0004439b 000e4ca5 00317bcd 000455c1 000053c9
0000B88 000368c6 002687ca 002881ca 002789d1 002791d7 000774c9 00178dcf 001f9ce1
0000B90 00179be4 001e9eda 000097de 0003a5e6 0008b1ee 0009b0e8 000aafe2 0017b4e9
0000B98 0024b9ef 0030bdf4 003cc1f9 0034bcf9 002cb6f9 0080d2e8 00fafdaf 00fcfdb3
0000BA0 00fd3cb7 00fd3cb7 00fd3db7 00fd3cb6 00fbfcb5 00f4f4a5 00fd3da5 00fcfc9d
0000BA8 00fcfc94 00fbfb87 00fbfb7b 00fafa6e 00fafa61 00faf758 00faf54e 00f7ee44
0000BB0 00f3e73a 00ede12c 00e7db1e 00ffd21a 0078b090 0009a0fd 00159dfd 0018a0f8
0000BB8 001aa2f2 0018a0f2 00169ef2 00139bf2 001099f1 00119af2 00129bf3 00129bf3
0000BC0 0060d4f7 0067dcfd 004fc2f0 00002c8a 002e6bc0 000547ad 000044ba 003685c4
0000BC8 00064ebc 001462c3 002d70cb 000f5ab4 002274cd 001169c2 001979c2 001d80d0
0000BD0 001980d7 001a86d3 001090de 00038dda 000599e6 00059ce1 00049edd 0005a6e1
0000BD8 0000a7de 001fb6ee 0039bdf7 0038bcf6 0024b5fc 00bfe8b9 00fafea2 00fbfca5
0000BE0 00fcfaa8 00fcfca7 00fd3da6 00fbfca3 00f9fb9f 00f6f795 00fafb92 00fbfb8b
0000BE8 00fbfb85 00fafa79 00fafa6d 00f9f961 00f8f956 00f9f64c 00f9f442 00f5ec39
0000BF0 00f2e531 00efde28 00ecd620 00eed900 0032a6e5 0019a4ff 0029a4f4 0020a2f4
0000BF8 0018a0f5 00179ef4 00159df4 00139bf3 001199f2 00129af2 00129af3 00129af3
0000C00 005bd1f5 0063dff 00318dcc 00062d91 000e499a 0000369f 00003897 00155fb6
0000C08 0053aad9 0031a6e2 0045bcef 006dddf 0076defa 006dd9f9 0064d5f9 0054c5f3
0000C10 0045b5ed 00238ed6 001277ce 00006cc6 000282de 000187db 00008dd7 00079be1
0000C18 000099dc 0022b1f0 0036baf4 003cbcf4 001cb5ff 00fffe89 00fbff96 00fbfc98
0000C20 00fbf99a 00fcfb98 00fd3d96 00fafb90 00f6f98a 00f7f984 00f8fa7f 00fafa7a

00000C28 00fbfb75 00fafa6a 00f9f960 00f8f855 00f7f84a 00f7f540 00f8f336 00f4eb2f
00000C30 00f0e328 00f0da24 00f0d121 00e9ca24 00049bfb 0020a3f6 0016a1f7 0016a0f7
00000C38 00169ef7 00159df6 00149cf5 00139bf4 00129af3 00129af3 00129af3 00129af3
00000C40 005ae3ff 0064d8ff 000d4798 00002682 001d6bb7 003aa2de 005fe5ff 0052d8fd
00000C48 004dd6f6 0048ccf5 005fd0f6 0068d9ff 0061d3f8 005bd2f8 0042cbff 0053cfe
00000C50 0051cff5 0049caf6 004acdff 0040baff 000e7edb 000069c2 000584da 000184d5
00000C58 00068cd8 0038bef8 003abef7 0035beff 0062c7e2 00fbf379 00f8fa83 00f9f983
00000C60 00faf884 00f9f77f 00f7f77b 00f8f979 00f9fa77 00f8f972 00f7f86c 00fcfc6c
00000C68 00f9f864 00f8f85b 00f8f752 00f7f649 00f6f53f 00f5f237 00f4ef2f 00f1e628
00000C70 00eede20 00ead61f 00f2cc11 009db96c 000c9ffe 001ba3f9 0017a2f9 0017a0f9
00000C78 00169ef8 00169df7 00159cf6 00149bf5 00139af5 00139af5 00139af5 00139af5
00000C80 0060d8f9 005bd9f8 004cadd7 0069ddff 0056ddf8 0055d6fc 0055d0ff 005cd5ff
00000C88 0053cbf2 004bcacf 0043cafa 0047c9f8 004cc8f6 005ccff1 0046ccf8 0055caff
00000C90 003ec4fa 0043c3fb 0048c2fd 003ebff4 0044ccfb 0037b3fc 000b7bd4 00006dc9
00000C98 000d80d4 004eccff 003ec3fa 002ec2ff 00a7dea8 00f8ec5b 00f5f570 00f7f66f
00000CA0 00faf76e 00f5f467 00f1f060 00f6f663 00fbfc65 00f8f95f 00f6f659 00fefe5d
00000CA8 00f7f652 00f7f54c 00f7f545 00f6f33d 00f6f235 00f3ef2f 00f1eb29 00efe221
00000CB0 00ecd818 00e5d21a 00f3c700 0052a9b4 0014a4fb 0015a3fb 0017a3fc 0017a1fa
00000CB8 00179ff8 00169df8 00159cf7 00159bf7 001499f6 001499f6 001499f6 001499f6
00000CC0 0058cff2 0059ddfd 0055d5f9 005ddef7 004dcef3 004dcbf3 004cc8f3 0056d2fc
00000CC8 0059d3fd 0050cefb 0047cafa 0048c9f9 0049c7f9 0051cbf6 0045c9f9 004bc8fd
00000CD0 003fc5f9 0041c4fa 0043c2fb 003bbdf3 003ac0f4 003ec7fc 003ac6fc 0025a1e3
00000CD8 001f8dd9 0037b9f7 0026bbfa 002abbf4 00ced857 00f9fa5b 00d9db49 00edec58
00000CE0 00faf560 00f2ef4d 00e9ea3b 00eeef46 00f2f451 00f9f34f 00edf145 00fef84b
00000CE8 00f4f542 00f5f43d 00f6f337 00f5f131 00f5ef2b 00f2eb27 00f0e622 00eedb1d
00000CF0 00ecd117 00f1cc09 00f5c509 00fadff7 0017a1f9 0018a1f9 0018a1f8 0018a0f9
00000CF8 00179ff9 00169df9 00169cf8 00159bf8 001599f8 001599f8 001599f8 001599f8
00000D00 0060d5fb 005bd3fb 0056d2fb 0055d1fc 0055d0fe 0054d0fa 0053d1f6 0051cef7
00000D08 004ecbf8 004dcbf9 004ccafb 0049c8fb 0047c6fc 0045c6fb 0043c6fa 0041c6fa
00000D10 0040c7f9 003fc5f9 003ec3f9 003fc3fb 0041c4fd 0038baf2 0040c1f8 003dc3fb
00000D18 003bc5fe 0037c1f6 0034beef 002ebcf0 00ded722 00bfdc38 00dee142 00ecea4a
00000D20 00eae442 00eee942 00f2ee42 00eed3f7 00eaec3d 00fbee3f 00e5ec31 00fff239
00000D28 00f2f531 00f4f32e 00f5f12a 00f5ee25 00f4ec21 00f2e71e 00f0e11c 00eed519
00000D30 00ecc917 00dec40c 00bbbe39 000798f8 001a9ff8 001a9ff7 001a9ff5 00189ff7
00000D38 00179ff9 00179ef9 00169cf9 00169bf9 001699f9 001699f9 001699f9 001699f9
00000D40 005cd4f9 0058d4f9 0055d3f9 0056d2fa 0058d0fb 0056d0f8 0054d0f6 0051cef7
00000D48 004dccf9 004ccbfa 004bcafb 0049c8fb 0047c7fb 0045c7fb 0043c6fa 0041c6fa
00000D50 0040c6f9 003fc4f9 003ec3f9 003ec2fa 003ec2fb 003abef5 003ec2f8 003bc1f9
00000D58 0037c0f9 0036beff 0035bbff 0067bb84 00b0d219 00b4d31a 00d3da39 00e2dd3d
00000D60 00d6d532 00e1df38 00ece93e 00e1e636 00e9e536 00f1e634 00e5e42b 00f6e62e
00000D68 00e9eb29 00f0ee2a 00f0e824 00ece420 00e9e01d 00ebdb1c 00edd71c 00e9ce19
00000D70 00e5c516 00e7c004 006cb292 00109dfc 0018a1f7 001aa0f5 001ca0f3 0019a0f6
00000D78 00179ff9 00169ef9 00169cf9 00159bf8 00159af8 001499f8 001499f7 001499f7
00000D80 0058d4f6 0056d4f6 0054d5f7 0057d3f7 005bd1f8 0058d0f6 0054cff5 0050cef8
00000D88 004dcdfa 004bcbfb 004acafb 0048c9fb 0046c7fb 0045c7fa 0043c7fa 0042c6fa
00000D90 0040c6f9 003fc4f9 003ec3f9 003dc1f9 003cc0f9 003cc1f8 003cc2f7 0038bfff6
00000D98 0034bbf5 0035bdfd 0037beff 0046bcfc 0082c92c 00a0be02 00b8c420 00d8cf31
00000DA0 00d2d632 00d4d52e 00d7d42a 00cdd725 00e9df2f 00e6dd2a 00e4dc25 00edd922
00000DA8 00e0e220 00ede927 00eae01e 00e4da1c 00ded319 00e5d01a 00ebcd1b 00e5c818
00000DB0 00dec214 00f0bc00 001da5eb 0019a1ff 0016a2f7 0019a2f4 001ea2f1 001aa0f5
00000DB8 00169ff9 00169ef8 00159df8 00159cf8 00149bf8 00139af7 001299f6 001299f6
00000DC0 005ed5f9 0063d6fc 0068d6ff 005fd3fc 0056d0f8 0053cff8 0051cef8 004ecdff9
00000DC8 004bccfb 004acfbf 0048cafb 0047c9fa 0046c8fb 0044c7fa 0043c7fa 0042c6fa
00000DD0 0040c5f9 003fc4f9 003ec3f9 003dc1f9 003cc0f9 003bc1f9 003bc1f8 0038bfff7
00000DD8 0036bdf7 0035bdfa 0034bdfe 0022c3f6 0027bbfc 0053b0b2 009bc606 00c1d322
00000DE0 00d3dd36 00b4ba12 00c4c71f 00c5cf22 00d9d82d 00dfdb30 00dcd52b 00e8d520
00000DE8 00d5d51c 00e8e428 00ece324 00d1ce1f 00d3c51d 00dcc302 00cfc312 00e3c209
00000DF0 00e3be00 0084bf6e 000ca0f6 00129ffd 0018a2f6 0019a1f5 001ba1f4 0018a0f6
00000DF8 00169ff8 00159ef8 00159df8 00149cf7 00139bf7 00129af6 001098f4 001098f4

00000E00 0065d7fb 005dd4fa 0056d2f8 0053d0f9 0050cff9 004fcef9 004dcdfa 004bcdfa
00000E08 004accfb 0048cbfb 0047cafb 0046c9fa 0045c8fa 0044c7fa 0043c7fa 0042c6fa
00000E10 0040c5fa 003fc4f9 003ec3f9 003dc1f9 003bc0f9 003ac0f9 0039c0f9 0038bff9
00000E18 0037bff9 0034bef8 0031bcf7 0033bbf8 0035bbfa 002cbcff 0061c2df 0093cb85
00000E20 00c5d52b 00cbd82f 00b0bb13 00b5be17 00b9c21b 00c7c826 00c5bf21 00dbc817
00000E28 00cac819 00dbd722 00ddd61a 00b7bd0d 00c8bd04 00d0c000 00adc951 006cb8b1
00000E30 0004a3ff 0013a4fb 0021a4f5 001ea3f5 001aa1f6 0019a1f6 0018a0f7 0017a0f7
00000E38 00169ff8 00159ef7 00149ef7 00139df7 00139cf6 00119af4 000f98f2 000f98f2
00000E40 005cd5f9 0058d3f8 0053d1f8 0052d0f9 0050cff9 004ecef9 004ccd9a 004accfa
00000E48 0048ccfa 0047cbfa 0046cafa 0045c9fa 0044c8fa 0043c7fa 0042c7fa 0041c6fa
00000E50 0040c5fa 003fc4f9 003ec2f9 003cc1f9 003bc0f9 003ac0f9 0038bff9 0037bff9
00000E58 0036bff9 0035bdf6 0034bbf3 0035b9f7 0035b8fb 0022b5ff 002fb5ff 004dba66
00000E60 006bbfce 0027b1c5 006cbc7c 008abd49 00a7be15 00b9bf09 00ccc000 00dac43d
00000E68 00bbca20 00aec73e 0099bc54 005aad8b 0036abc4 0004b3ff 0015a7ff 0021a4ff
00000E70 0019a0fb 001ba2fa 001da4f9 001ba3f8 001aa1f7 0019a1f7 0018a0f7 0017a0f7
00000E78 00169ff8 00159ef7 00149ef7 00139df7 00129cf6 00119af5 000f99f3 000f99f3
00000E80 0053d2f6 0052d1f7 0051d1f8 0050d0f9 004fcffa 004dcefa 004bcdfa 0049ccfa
00000E88 0047cbfa 0046caf9 0045caf9 0044c9f9 0044c8fa 0043c7fa 0042c6f9 0041c6f9
00000E90 0040c5fa 003fc4f9 003dc2f9 003cc1f9 003ac0f9 0039c0f9 0038bff9 0036bff9
00000E98 0035bef8 0036bcf4 0038baf0 0036b8f6 0034b5fc 002cb6f9 0023b7f6 0025b5fa
00000EA0 0028b4ff 0028b6ff 0029b7ff 001fb5ff 0015b2ff 0020aef7 003cb9ff 005acb00
00000EA8 0042befa 002ab6fc 0012adff 0018acfc 001eacfa 001ea9fd 001ea7ff 001ba8fa
00000EB0 0018a8f4 0018a6f8 0018a4fd 0019a3fa 001aa1f7 0019a1f7 0018a0f8 0017a0f8
00000EB8 00169ff8 00159ef7 00149df7 00139cf6 00129bf6 00119af5 001099f4 001099f4
00000EC0 0054d1f8 0052d1f8 0051d0f9 004fcffa 004ecffa 004ccefa 004acdf9 0048ccf9
00000EC8 0045cbf9 0045caf9 0044c9f9 0043c8f9 0043c8f9 0042c7f9 0042c6f9 0041c5f9
00000ED0 0040c5fa 003fc4f9 003dc2f9 003bc1f9 003ac0fa 0038bff9 0037bff9 0036bef9
00000ED8 0034bef8 0035bcf6 0035baf5 0034b8f8 0033b6fc 002eb6f9 0029b6f7 0029b5f8
00000EE0 002ab4fa 002ab5fb 002ab5fc 002ab2f6 002aafef 001ba9f6 009bcfd9 006dcfe9
00000EE8 0074c7e4 0080c9dd 0019adfb 001cacf9 001fabf8 001fa9f9 001ea7fb 001ca7f9
00000EF0 001aa7f6 001aa5f8 001aa4fb 001aa3fa 001aa2f8 0019a1f8 0018a0f8 0017a0f8
00000EF8 00169ff8 00159ef7 00149df7 00139cf6 00129bf6 00119bf5 00119af5 00119af5
00000F00 0055d0f9 0053d0fa 0051d0fa 004fcffa 004dcffa 004bcefa 0049cdf9 0046ccf9
00000F08 0044caf8 0043caf8 0043c9f8 0043c8f9 0042c8f9 0042c7f9 0041c6f9 0041c6f9
00000F10 0040c5fa 003ec3f9 003dc2fa 003bc1fa 0039c0fa 0038bff9 0036bff9 0035bef9
00000F18 0034bdf8 0033bcf9 0033bafa 0032b9fb 0032b8fc 0030b7fa 002eb6f8 002db5f7
00000F20 002bb4f5 002bb4f6 002bb3f7 0029b2f9 0028b2fc 0030b2f7 0012a8fe 007fd4e1
00000F28 0058bbe6 0015aafb 001fadf8 0020acf7 0020aaf5 001fa9f6 001ea8f7 001da6f7
00000F30 001ca5f8 001ca4f8 001ba3f9 001ba3f9 001ba2f9 0019a1f9 0018a0f8 0017a0f8
00000F38 00169ff8 00159ef7 00149df7 00139cf6 00129bf5 00129bf5 00129bf5 00129bf5
00000F40 0055d0f9 0053d0fa 0051d0fa 004fcffa 004dcffa 004bcefa 0049cdf9 0046ccf9
00000F48 0044caf8 0043caf8 0043c9f8 0043c8f9 0042c8f9 0042c7f9 0041c6f9 0041c6f9
00000F50 0040c5fa 003ec3f9 003dc2fa 003bc1fa 0039c0fa 0038bff9 0036bff9 0035bef9
00000F58 0034bdf8 0033bcf9 0033bafa 0032b9fb 0032b8fc 0030b7fa 002eb6f8 002db5f7
00000F60 002bb4f5 002bb4f6 002bb3f7 002ab2f8 0029b2fa 002db6f5 001db5f6 00239bff
00000F68 0020b6f3 000cacfb 001eacf7 001fabf6 0020aaf5 001fa9f6 001ea8f7 001da6f7
00000F70 001ca5f8 001ca4f8 001ba3f9 001ba3f9 001ba2f9 0019a1f9 0018a0f8 0017a0f8
00000F78 00169ff8 00159ef7 00149df7 00139cf6 00129bf5 00129bf5 00129bf5 00129bf5
00000F80 0055d0f9 0053d0fa 0051d0fa 004fcffa 004dcffa 004bcefa 0049cdf9 0046ccf9
00000F88 0044caf8 0043caf8 0043c9f8 0043c8f9 0042c8f9 0042c7f9 0041c6f9 0041c6f9
00000F90 0040c5fa 003ec3f9 003dc2fa 003bc1fa 0039c0fa 0038bff9 0036bff9 0035bef9
00000F98 0034bdf8 0033bcf9 0033bafa 0032b9fb 0032b8fc 0030b7fa 002eb6f8 002db5f7
00000FA0 002bb4f5 002bb4f6 002bb3f7 002bb2f8 002bb1f8 0022aff9 0019acfa 001eadf7
00000FA8 0024aef3 0020adf5 001dabf6 001fabf6 0020aaf5 001fa9f6 001ea8f7 001da6f7
00000FB0 001ca5f8 001ca4f8 001ba3f9 001ba3f9 001ba2f9 0019a1f9 0018a0f8 0017a0f8
00000FB8 00169ff8 00159ef7 00149df7 00139cf6 00129bf5 00129bf5 00129bf5 00129bf5
00000FC0 0055d0f9 0053d0fa 0051d0fa 004fcffa 004dcffa 004bcefa 0049cdf9 0046ccf9
00000FC8 0044caf8 0043caf8 0043c9f8 0043c8f9 0042c8f9 0042c7f9 0041c6f9 0041c6f9
00000FD0 0040c5fa 003ec3f9 003dc2fa 003bc1fa 0039c0fa 0038bff9 0036bff9 0035bef9

```
00000FD8 0034bdf8 0033bcf9 0033bafa 0032b9fb 0032b8fc 0030b7fa 002eb6f8 002db5f7
00000FE0 002bb4f5 002bb4f6 002bb3f7 002bb2f8 002bb1f8 0022aff9 0019acfa 001eadf7
00000FE8 0024aef3 0020adf5 001dabf6 001fabf6 0020aaf5 001fa9f6 001ea8f7 001da6f7
00000FF0 001ca5f8 001ca4f8 001ba3f9 001ba3f9 001ba2f9 0019a1f9 0018a0f8 0017a0f8
00000FF8 00169ff8 00159ef7 00149df7 00139cf6 00129bf5 00129bf5 00129bf5 00129bf5
```

4.2.4.5 Decoded Image

The following is the decoded image that is represented by the XRGB data given in section [4.2.4.4](#).



Figure 20: Decoded image

5 Security

5.1 Security Considerations for Implementers

None.

5.2 Index of Security Parameters

None.

6 Appendix A: Product Behavior

The information in this specification is applicable to the following Microsoft products or supplemental software. References to product versions include released service packs:

- Windows 7 Enterprise operating system with Service Pack 1 (SP1)
- Windows 7 Ultimate operating system with Service Pack 1 (SP1)
- Windows Server 2008 R2 Standard operating system with Service Pack 1 (SP1)
- Windows Server 2008 R2 Enterprise operating system with Service Pack 1 (SP1)
- Windows Server 2008 R2 Datacenter operating system with Service Pack 1 (SP1)
- Microsoft Hyper-V Server 2008 R2 Service Pack 1
- Windows 8 operating system
- Windows Server 2012 operating system
- Windows 8.1 operating system
- Windows Server 2012 R2 operating system

Exceptions, if any, are noted below. If a service pack or Quick Fix Engineering (QFE) number appears with the product version, behavior changed in that service pack or QFE. The new behavior also applies to subsequent service packs of the product unless otherwise specified. If a product edition appears with the product version, behavior is different in that product edition.

Unless otherwise specified, any statement of optional behavior in this specification that is prescribed using the terms SHOULD or SHOULD NOT implies product behavior in accordance with the SHOULD or SHOULD NOT prescription. Unless otherwise specified, the term MAY implies that the product does not follow the prescription.

[<1> Section 1.5](#): Microsoft RDP 8.0 RemoteFX servers require that the [TS_FRAME_ACKNOWLEDGE_CAPABILITYSET \(section 2.2.1.3\)](#) be sent by the client.

[<2> Section 1.5](#): Microsoft RDP 8.0 RemoteFX servers do not require that the **connectionType** field of the Client Core Data ([MS-RDPBCGR] section [2.2.1.3.2](#)) be set to CONNECTION_TYPE_LAN (0x06).

[<3> Section 2.2.2.1.3](#): Microsoft RDP 7.1 RemoteFX clients validate the **width** field.

[<4> Section 2.2.2.1.3](#): Microsoft RDP 7.1 RemoteFX clients validate the **height** field.

[<5> Section 2.2.3.1](#): Microsoft RDP 8.0 RemoteFX servers do not check for the special **frameID** value of 0xFFFFFFFF.

7 Change Tracking

No table of changes is available. The document is either new or has had no changes since its last release.

8 Index

A

[Abstract data model](#) 30
[Applicability](#) 11

C

[Capability negotiation](#) 11
[Change tracking](#) 140

D

[Data model - abstract](#) 30

E

[Event processing](#) 32
[Examples - sample use case](#) 51

F

[Fields - vendor-extensible](#) 11

G

[Glossary](#) 6

H

[Higher-layer triggered events](#) 32

I

[Implementer - security considerations](#) 138
[Index of security parameters](#) 138
[Informative references](#) 7
[Initialization](#) 32
[Introduction](#) 6

L

[Local events](#) 33

M

[Message flows - overview](#) 8
Messages
 [syntax](#) 12
 [transport](#) 12

N

[Normative references](#) 6

O

Overview
 [message flows](#) 8
 [RemoteFX codec](#) 7

[synopsis](#) 7

P

[Parameters - security index](#) 138
[Preconditions](#) 10
[Prerequisites](#) 10
[Product behavior](#) 139

R

References
 [informative](#) 7
 [normative](#) 6
[Relationship to other protocols](#) 10
RemoteFX algorithm
 [decoding](#) 47
 [encoding](#) 33
 [overview](#) 33
 [stream](#) 48
[RemoteFX codec - overview](#) 7

S

[Sample use case](#) 51
Security
 [implementer considerations](#) 138
 [parameter index](#) 138
[Sequencing rules](#) 32
[Standards assignments](#) 11
[Syntax - messages](#) 12

T

[Timer events](#) 33
[Timers](#) 32
[Tracking changes](#) 140
[Transport](#) 12
[Triggered events](#) 32
[TS_FRAME_ACKNOWLEDGE_CAPABILITYSET_packet](#) 15
[TS_FRAME_ACKNOWLEDGE_PDU_packet](#) 27
[TS_RFX_BLOCKT_packet](#) 16
[TS_RFX_CAPS_packet](#) 13
[TS_RFX_CAPS_CONTAINER_packet](#) 12
[TS_RFX_CAPSET_packet](#) 13
[TS_RFX_CHANNELS_packet](#) 21
[TS_RFX_CHANNELT_packet](#) 18
[TS_RFX_CODEEC_CHANNELT_packet](#) 17
[TS_RFX_CODEEC_QUANT_packet](#) 18
[TS_RFX_CODEEC_VERSIONS_packet](#) 20
[TS_RFX_CODEEC_VERSIONT_packet](#) 18
[TS_RFX_CONTEXT_packet](#) 21
[TS_RFX_FRAME_BEGIN_packet](#) 22
[TS_RFX_FRAME_END_packet](#) 23
[TS_RFX_ICAP_packet](#) 14
[TS_RFX_RECT_packet](#) 19
[TS_RFX_REGION_packet](#) 23
[TS_RFX_SRVR_CAPS_CONTAINER_packet](#) 15

[TS_RFX_SYNC packet](#) 20
[TS_RFX_TILE packet](#) 26
[TS_RFX_TILESET packet](#) 24

U

[Use case example](#) 51

V

[Vendor-extensible fields](#) 11
[Versioning](#) 11