



INTERNATIONAL TELECOMMUNICATION UNION

ITU-T

TELECOMMUNICATION
STANDARDIZATION SECTOR
OF ITU

X.212

(11/95)

**DATA NETWORKS AND OPEN SYSTEM
COMMUNICATIONS**

**OPEN SYSTEMS INTERCONNECTION –
SERVICE DEFINITIONS**

**INFORMATION TECHNOLOGY –
OPEN SYSTEMS INTERCONNECTION –
DATA LINK SERVICE DEFINITION**

ITU-T Recommendation X.212

(Previously “CCITT Recommendation”)

FOREWORD

ITU (International Telecommunication Union) is the United Nations Specialized Agency in the field of telecommunications. The ITU Telecommunication Standardization Sector (ITU-T) is a permanent organ of the ITU. Some 179 member countries, 84 telecom operating entities, 145 scientific and industrial organizations and 38 international organizations participate in ITU-T which is the body which sets world telecommunications standards (Recommendations).

The approval of Recommendations by the Members of ITU-T is covered by the procedure laid down in WTSC Resolution No. 1 (Helsinki, 1993). In addition, the World Telecommunication Standardization Conference (WTSC), which meets every four years, approves Recommendations submitted to it and establishes the study programme for the following period.

In some areas of information technology which fall within ITU-T's purview, the necessary standards are prepared on a collaborative basis with ISO and IEC. The text of ITU-T Recommendation X.212 was approved on 21st of November 1995. The identical text is also published as ISO/IEC International Standard 8886.

NOTE

In this Recommendation, the expression "Administration" is used for conciseness to indicate both a telecommunication administration and a recognized operating agency.

© ITU 1996

All rights reserved. No part of this publication may be reproduced or utilized in any form or by any means, electronic or mechanical, including photocopying and microfilm, without permission in writing from the ITU.

ITU-T X-SERIES RECOMMENDATIONS

DATA NETWORKS AND OPEN SYSTEM COMMUNICATIONS

(February 1994)

ORGANIZATION OF X-SERIES RECOMMENDATIONS

Subject area	Recommendation Series
PUBLIC DATA NETWORKS	
Services and Facilities	X.1-X.19
Interfaces	X.20-X.49
Transmission, Signalling and Switching	X.50-X.89
Network Aspects	X.90-X.149
Maintenance	X.150-X.179
Administrative Arrangements	X.180-X.199
OPEN SYSTEMS INTERCONNECTION	
Model and Notation	X.200-X.209
Service Definitions	X.210-X.219
Connection-mode Protocol Specifications	X.220-X.229
Connectionless-mode Protocol Specifications	X.230-X.239
PICS Proformas	X.240-X.259
Protocol Identification	X.260-X.269
Security Protocols	X.270-X.279
Layer Managed Objects	X.280-X.289
Conformance Testing	X.290-X.299
INTERWORKING BETWEEN NETWORKS	
General	X.300-X.349
Mobile Data Transmission Systems	X.350-X.369
Management	X.370-X.399
MESSAGE HANDLING SYSTEMS	X.400-X.499
DIRECTORY	X.500-X.599
OSI NETWORKING AND SYSTEM ASPECTS	
Networking	X.600-X.649
Naming, Addressing and Registration	X.650-X.679
Abstract Syntax Notation One (ASN.1)	X.680-X.699
OSI MANAGEMENT	X.700-X.799
SECURITY	X.800-X.849
OSI APPLICATIONS	
Commitment, Concurrency and Recovery	X.850-X.859
Transaction Processing	X.860-X.879
Remote Operations	X.880-X.899
OPEN DISTRIBUTED PROCESSING	X.900-X.999

CONTENTS

	<i>Page</i>
1 Scope.....	1
2 Normative references	1
2.1 Identical Recommendations International Standards	1
3 Definitions.....	1
3.1 OSI Reference Model definitions	1
3.2 Service Conventions definitions	2
3.3 Data Link Service definitions	2
4 Abbreviations	2
5 Conventions.....	2
5.1 General conventions.....	2
5.2 Parameters.....	3
6 Overview of the Data Link Service.....	3
7 Classes and types of Data Link Service	3
8 Features of the connection-mode Data Link Service	4
9 Model of the connection-mode Data Link Service.....	4
9.1 DLC Endpoint Connection Identification	4
9.2 Model of a Data-link-connection	4
10 Quality of connection-mode Data Link Service.....	7
10.1 Determination of QOS for Connection-mode Service	7
10.2 Definition of connection-mode QOS parameters.....	8
11 Sequence of primitives	10
11.1 Concepts used to define the connection-mode Data Link Service	10
11.2 Constraints of Sequence of Primitives	10
12 Connection establishment phase	12
12.1 Function	12
12.2 Types of primitives and parameters	13
12.3 Sequence of primitives.....	14
13 Connection release phase	14
13.1 Function	14
13.2 Types of primitive and parameters.....	15
13.3 Sequence of primitives when releasing an established DLC	16
13.4 Sequence of primitives in a DLS user rejection of DLC establishment attempt.....	17
13.5 Sequence of primitives in a DLS provider rejection of a DLC establishment attempt	17
13.6 Sequence of primitives in a DLS user abort of a DLC establishment attempt.....	17
14 Data transfer phase	18
14.1 Data transfer.....	18
14.2 Reset service	19
15 Features of the Connectionless-mode Data Link Service.....	21
16 Model of the Connectionless-mode Data Link Service.....	21
16.1 Model of a data-link-connectionless-mode data transmission	22
17 Quality of Connectionless-mode Service	22
17.1 Determination of QOS for Connectionless-mode Service	23
17.2 Definition of connectionless-mode QOS parameters.....	23

	<i>Page</i>
18 Sequence of connectionless-mode primitives at one DLSAP	24
19 Data transfer	25
19.1 Function	25
19.2 Types of primitives and parameters	25
19.3 Sequence of primitives	26

Summary

This Recommendation | International Standard defines the set of capabilities, in terms of an abstract service definition, provided by the Data Link Layer to the Network Layer. For designers of Network Layer protocols, it provides a definition of the Data Link service to allow design and implementation independent of details of the Data Link Layer protocol. For designers of Data Link Layer protocols, it defines the set of capabilities to be made available through the action of the protocol.

Introduction

This Recommendation | International Standard is one of a set of Recommendations | International Standards produced to facilitate the interconnection of information processing systems. It is related to other Recommendations | International Standards in the set as defined by ITU-T Rec. X.200 | ISO/IEC 7498-1, OSI Reference Model – The Basic Model. The reference model described by ITU-T Rec. X.200 | ISO/IEC 7498-1 subdivides the area of standardization for Open Systems Interconnection (OSI) into a series of layers of specification, each of a manageable size.

This Recommendation | International Standard defines the services provided by the Data Link Layer to the Network Layer at the boundary between the Data Link and Network Layers of the OSI Reference Model. It provides for the designers of network protocols a definition of the Data Link Service existing to support the network protocol and for the designers of Data Link Protocols a definition of the services to be made available through the action of the Data Link Protocol over the underlying service. The relationship is illustrated in Figure Intro. 1.

Throughout the set of OSI Recommendations | International Standards, the term “service” refers to the abstract capability provided by one layer of the OSI Reference Model to the layer immediately above. Thus, the Data Link Service defined in this Recommendation | International Standard is a conceptual architectural service, independent of administrative divisions.

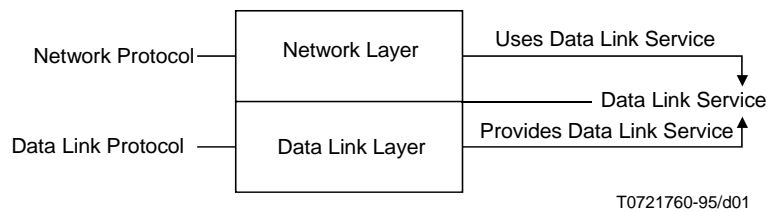

Figure Intro. 1 – Relationship of this Recommendation | International Standard to other OSI Recommendations | International Standards

INTERNATIONAL STANDARD

ITU-T RECOMMENDATION

**INFORMATION TECHNOLOGY – OPEN SYSTEMS INTERCONNECTION –
DATA LINK SERVICE DEFINITION**

1 Scope

This Recommendation | International Standard defines the OSI Data Link Service in terms of:

- a) the primitive actions and events of the service;
- b) the parameters associated with each primitive action and event, and the form that they take; and
- c) the interrelationship between, and the valid sequences of these actions and events.

The principal objective of this Recommendation | International Standard is to specify the characteristics of a conceptual Data Link Service and thus, supplement the OSI Reference Model in guiding the development of Data Link Protocols.

This Recommendation | International Standard does not specify individual implementation or products, nor does it constrain the implementation of Data Link entities and interfaces within an information processing system.

There is no conformance of equipment to this Data Link Service Definition Recommendation | International Standard. Instead, conformance is achieved through implementation of conforming Data Link Protocols that fulfil the Data Link Service defined in this Recommendation | International Standard.

2 Normative references

The following Recommendations and International Standards contain provisions which, through reference in this text, constitute provisions of this Recommendation | International Standard. At the time of publication, the editions indicated were valid. All Recommendations and International Standards are subject to revision, and parties to agreements based on this Recommendation | International Standard are encouraged to investigate the possibility of applying the most recent edition of the Recommendations and Standards listed below. Members of IEC and ISO maintain registers of currently valid International Standards. The Telecommunication Standardization Bureau maintains a list of currently valid ITU-T Recommendations.

2.1 Identical Recommendations | International Standards

- ITU-T Recommendation X.200 (1994) | ISO/IEC 7498-1:1994, *Information technology – Open Systems Interconnection – Basic Reference Model: The Basic Model*.
- ITU-T Recommendation X.210 (1993) | ISO/IEC 10731:1994, *Information technology – Open Systems Interconnection – Basic Reference Model: Conventions for the definition of OSI services*.

PART 1 – GENERAL

3 Definitions**3.1 OSI Reference Model definitions**

This Recommendation | International Standard is based on the concepts developed and makes use of the following terms defined in ITU-T Rec. X.200 | ISO/IEC 7498-1:

- a) Data link entity;
- b) Data Link Layer;
- c) Data Link Service;
- d) Data-link-service-access-point;

- e) Data-link-service-access-point-address;
- f) Data-link-service-data-unit;
- g) Reset.

3.2 Service Conventions definitions

This Recommendation | International Standard makes use of the following terms defined in ITU-T Rec. X.210 | ISO/IEC 10731, as they apply to the Data Link Layer:

- a) Data Link Service Users;
- b) Data Link Service Provider;
- c) Primitive;
- d) Request;
- e) Indication;
- f) Response;
- g) Confirm.

3.3 Data Link Service definitions

This Recommendation | International Standard makes use of the following terms:

a) **data-link-connection**

An association established by a Data Link Layer between two or more Data Link Service Users for the transfer of data, which provides explicit identification of a set of Data Link data transmissions and agreement concerning the Data Link data transmission services to be provided for the set.

NOTE – This definition clarifies the definition given in ITU-T Rec. X.200 | ISO/IEC 7498-1.

b) **data-link-connection-mode data transmission**

The transmission of a Data-link-service-data-unit within the context of a Data-link-connection that has been previously established.

c) **data-link-connectionless-mode data transmission**

The transmission of a Data-link-service-data-unit not in the context of a Data-link-connection and not required to maintain any logical relationship among multiple invocations.

4 Abbreviations

For this purposes of this Recommendation | International Standard, the following abbreviations apply:

DL	Data Link
DLC	Data-link-connection
DLL	Data Link Layer
DLS	Data Link Service
DLSAP	Data-link-service-access-point
DLSDU	Data-link-service-data-unit
OSI	Open Systems Interconnection
QOS	Quality of Service

5 Conventions

5.1 General conventions

This Recommendation | International Standard uses the descriptive conventions given in ITU-T Rec. X.210 | ISO/IEC 10731.

The service model, service primitives, and time-sequence diagrams used are entirely abstract descriptions; they do not represent a specification for implementation.

5.2 Parameters

Service primitives, used to represent service user/service provider interactions (see ITU-T Rec. X.210 | ISO/IEC 10731), convey parameters which indicate information available in the user/provider interaction.

The parameters which apply to each group of Data Link Service primitives are set out in tables in clauses 12 to 14 and 19. Each “X” in the tables indicates that the primitive labelling the column in which it falls may carry the parameter labelling the row in which it falls.

Some entries are further qualified by items in brackets. These may be:

- a) *A parameter specific constraint:*
(=) indicates that the value supplied in an indication or confirm primitive is always identical to that supplied in a previous request or response primitive issued at the peer service-access-point
- b) *Indication that some Note applies to the entry:*
(See Note X) indicates that the referenced Note contains additional information pertaining to the parameter and its use.

In any particular interface, not all parameters need be explicitly stated. Some may be implicitly associated with the DLSAP at which the primitive is issued.

6 Overview of the Data Link Service

The DLS provides for the transparent and reliable transfer of data between DLS users. It makes invisible to these DLS users the way in which supporting communications resources are utilized to achieve this transfer.

In particular, the DLS provides for the following:

- a) *Independence of underlying Physical Layer* – The DLS relieves DLS users from all concerns regarding which configuration is available (e.g. point-to-point connection) or which physical facilities are used (e.g. half-duplex transmission).
- b) *Transparency of transferred information* – The DLS provides for the transparent transfer of DLS user-data. It does not restrict the content, format or coding of the information, nor does it ever need to interpret its structure or meaning.
- c) *Reliable transfer of data* – The DLS relieves the DLS user from loss, insertion, corruption or, if requested, misordering of data which may occur. In some cases of unrecoverable errors in the Data Link Layer, duplication or loss of DLSDUs may occur.

NOTE 1 – Detection of duplicate or lost DLSDUs may be performed by DLS users.

- d) *Quality of Service selection* – The DLS makes available to DLS users a means to request and to agree upon a quality of service for the transfer of data. QOS is specified by means of QOS parameters representing characteristics such as throughput, transit delay, accuracy and reliability.
- e) *Addressing* – The DLS allows the DLS user to identify itself and to specify the DLSAP to which a DLC is to be established whenever more than two DLSAPs are supported by the DLS provider. Data Link addresses have only local significance within a specific Data Link configuration over a single transmission medium (point-to-point or multi-point physical connection) or a group of parallel transmission media (multi-link or splitting function). Therefore it is not appropriate to define a global addressing structure.

NOTE 2 – The DLS is required to differentiate between the individual systems that are physically or logically connected to a multi-point Data Link and to differentiate between connections when the Data Link Layer includes a multiplexing function. For commonality with other Service definitions, this mechanism is referred to as addressing and the objects used to differentiate between systems are referred to as addresses.

7 Classes and types of Data Link Service

There are no distinct classes of Data Link Service defined. There are two types of Data Link Service:

- a) a connection-mode service (defined in Part 2); and
- b) a connectionless-mode service (defined in Part 3).

When making reference to this Recommendation | International Standard, a user or provider of Data Link Service shall state which types of service it expects to use or provide.

PART 2 – DEFINITION OF THE CONNECTION-MODE SERVICE

8 Features of the connection-mode Data Link Service

The DLS provides the following features to the DLS user:

- a) The means to establish a DLC with another DLS user for the purpose of exchanging DLSDUs.
- b) The establishment of an agreement between the initiating DLS user and the DLS provider for a certain QOS associated with each DLC.
- c) The means of transferring DLSDUs of restricted length on a DLC. The transfer of DLSDUs is transparent, in that the boundaries of DLSDUs and the contents of DLSDUs are preserved unchanged by the DLS, and there are no constraints on the DLSDU content imposed by the DLS.

NOTE – The length of a DLSDU may be limited because of internal mechanisms employed by the data-link-protocol (see ITU-T Rec. X.200 | ISO/IEC 7498-1, 7.6.3.5.2).
- d) The means by which the receiving DLS user may flow control the rate at which the sending DLS user may send DLSDUs.
- e) The means by which a DLC can be returned to a defined state and the activities of the two DLS users synchronized by use of a Reset service element.
- f) The unconditional, and therefore possibly destructive, release of a DLC by either of the DLS users or by the DLS provider.

9 Model of the connection-mode Data Link Service

This Recommendation | International Standard uses the abstract model for a layer service defined in clause 4 of ITU-T Rec. X.210 | ISO/IEC 10731. The model defines the interactions between the DLS users and the DLS provider which take place at the two DLSAPs. Information is passed between the DLS user and the DLS provider by service primitives, which may convey parameters.

9.1 DLC Endpoint Connection Identification

If a DLS user needs to distinguish among several DLCs at the same DLSAP, then a local connection endpoint identification mechanism must be provided. All primitives issued at such a DLSAP within the context of a DLC would be required to use this mechanism to identify this DLC. Such an implicit identification is not described in this Recommendation | International Standard.

9.2 Model of a Data-link-connection

Between the two endpoints of a DLC, there exists a flow control function that relates the behaviour of the DLS user receiving data to the ability of the other DLS user to send data. As a means of specifying this flow control feature and its relationship with other capabilities provided by the connection-mode DLS, the queue model of a DLC, which is described in the following clauses, is used.

This queue model of a DLC is discussed only to aid in the understanding of the end-to-end service features perceived by DLS users. It is not intended to serve as a substitute for a precise, formal description of the DLS, nor as a complete specification of all allowable sequences of DLS primitives. (Allowable primitive sequences are specified in clause 11. See also the Note below.) In addition, this model does not attempt to describe all the functions or operations of DL entities that are used to provide the DLS. No attempt to specify or constrain DLS provider implementations is implied.

NOTE – The internal mechanisms which support the operation of the DLS are not visible to the DLS user. In addition to the interactions between service primitives described by this model (e.g. the issue of a DL-RESET request primitive at an DLSAP may prevent the receipt of a DL-DATA indication primitive, corresponding to a previously issued DL-DATA request primitive, by the peer DLS user) there may also be:

- a) constraints applied locally on the ability to invoke primitives;
- b) service procedures defining particular sequencing constraints on some primitives.

9.2.1 Queue model concepts

The queue model represents the operation of a DLC in the abstract by a pair of queues linking the two DLSAPs. There is one queue for each direction of information flow (see Figure 1).

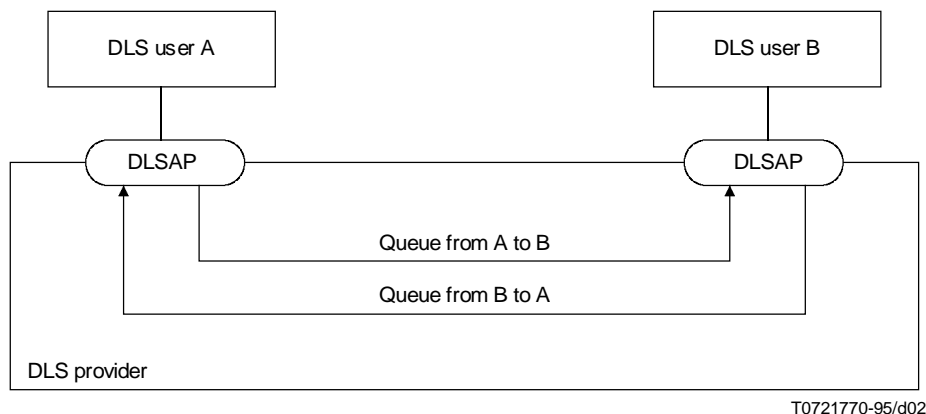

Figure 1 – Queue model of a DLC

Each queue represents a flow control function in one direction of transfer. The ability of a DLS user to add objects to a queue will be determined by the behaviour of the other DLS user in removing objects from the queue. Objects are entered or removed from the queue as a result of interactions at the two DLSAPs.

The pair of queues is considered to be available for each potential DLC.

The following objects may be placed in a queue by a DLS user (see clauses 12-14):

- a) a connect object, representing a DL-CONNECT request or response primitive and its parameters;
- b) a data object, representing a DL-DATA request primitive and its parameters;
- c) a reset object, representing a DL-RESET request or response primitive and its parameters; and
- d) a disconnect object, representing a DL-DISCONNECT request primitive and its parameters.

The following objects may be placed in a queue by the DLS provider (see clauses 12-14):

- 1) a reset object;
- 2) a synchronization mark object (see 9.2.4); and
- 3) a disconnect object.

The queues are defined to have the following general properties:

- i) a queue is empty before a connect object has been entered and can be returned to this state, with loss of its contents, by the DLS provider;
- ii) objects are entered into a queue by the sending DLS user, subject to control by the DLS provider. Objects may also be entered by the DLS provider;
- iii) objects are removed from the queue, under the control of the receiving DLS user;
- iv) objects are normally removed in the same order that they were entered (however, see 9.2.3); and
- v) a queue has a limited capacity, but this capacity is not necessarily either fixed or determinable.

9.2.2 DLC establishment

A pair of queues is associated with a DLC between two DLSAPs when the DLS provider receives a DL-CONNECT request primitive at one of the DLSAPs, and a connect object is entered into one of the queues. From the standpoint of the DLS users of the DLC, the queues remain associated with the DLC until a disconnect object representing a DL-DISCONNECT request or indication primitive is either entered or removed, respectively, from the queue.

DLS user A, who initiates a DLC establishment by entering a connect object representing a DL-CONNECT request primitive into the queue from DLS user A to DLS user B, is not allowed to enter any other object, other than a disconnect object, into the queue until after the connect object representing the DL-CONNECT confirm primitive has been removed from the DLS user B to DLS user A queue. In the queue from DLS user B to DLS user A data objects can be entered only after DLS user B has entered a connect object representing a DL-CONNECT response primitive.

The properties exhibited by the queues while the DLC exists represent the agreements reached among the DLS users and the DLS provider during this connection establishment procedure concerning QOS.

9.2.3 Data transfer

Flow control on the DLC is represented in this queue model by the management of the queue capacity, allowing objects to be added to the queues. The addition of an object may prevent addition of a further object.

Once objects are in the queue, the DLS provider may manipulate pairs of adjacent objects, resulting in deletion. An object may be deleted if, and only if, the object which follows it is defined to be destructive with respect to the object. If necessary the last object in the queue will be deleted to allow a destructive object to be entered – they may therefore always be added to the queue. Disconnect objects are defined to be destructive with respect to all other objects. Reset objects are defined to be destructive with respect to all other objects except connect, disconnect objects.

The relationships between objects which may be manipulated in the above fashion are summarized in Table 1.

Whether the DLS provider performs actions resulting in deletion or not will depend upon the behaviour of the DLC users and the agreed QOS for the DLC. In general, if a DLS user does not remove objects from a queue, the DLS provider shall, after some unspecified period of time, perform all the permitted deletions.

Table 1 – Relationships between queue model objects

Following object y is defined with respect to the preceding object x	Connect	Data	Reset	Synchronization mark	Disconnect
Connect	N/A	–	–	N/A	DES
Data	N/A	–	DES	N/A	DES
Reset	N/A	–	DES	–	DES
Synchronization mark	N/A	–	DES	N/A	DES
Disconnect	N/A	N/A	N/A	N/A	DES
N/A x will not precede y in a valid state of a queue – Not to be destructive nor to be able to advance ahead DES To be destructive to the preceding object					

9.2.4 Reset

In order to accurately model the reset service a synchronization mark object is required. The synchronization mark object exhibits the following properties:

- a) it cannot be removed from a queue by a DLS user;
- b) a queue appears empty to a DLS user when a synchronization mark object is the next object in the queue;
- c) a synchronization mark object can be destroyed by a disconnect object (see Table 1);
- d) when a reset object is immediately preceded by a synchronization mark object, both the reset object and the synchronization mark object are deleted from the queue.

The initiation of a reset procedure is represented in the two queues as follows:

- i) initiation of a reset procedure by the DLS provider is represented by the introduction into each queue of a reset object followed by a synchronization mark object;
- ii) a reset procedure initiated by a DLS user is represented by the addition of a reset object into the queue from the reset initiator to the peer DLS user and the insertion of a reset object followed by a synchronization mark object into the other queue by the peer DLS user.

Unless destroyed by a disconnect object, a synchronization mark object remains in the queue until the next object following it in the queue is a reset object. Both the synchronization mark object and the following reset object are then deleted by the DLS provider.

NOTE – Associated with the initiation of a reset procedure are restrictions on the issuance of certain other types of primitives. These restrictions will result in restrictions on the entry of certain object types into the queue until the reset procedure is completed (see 14.2.3).

9.2.5 DLC release

The insertion into a queue of a disconnect object, which may occur at any time, represents the initiation of a DLC release procedure. The release procedure may be destructive with respect to other objects in the two queues and eventually results in the emptying of the queues and the disassociation of the queues with the DLC.

The insertion of a disconnect object may also represent the rejection of a DLC establishment attempt or the failure to complete DLC establishment. In such cases, if a connect object representing a DL-CONNECT request primitive is deleted by a disconnect object, then the disconnect object is also deleted. The disconnect object is not deleted when it deletes any other object, including the case where it deletes a connect object representing a DL-CONNECT response primitive.

10 Quality of connection-mode Data Link Service

The term “Quality of Service” (QOS) refers to certain characteristics of a DLC as observed between the connection endpoints. QOS describes aspects of a DLC that are attributable solely to the DLS provider.

Once a DLC is established, the DLS users at the two ends have the same knowledge and understanding of what the QOS over the DLC is.

10.1 Determination of QOS for Connection-mode Service

QOS is determined in terms of QOS parameters. These parameters give DLS users a method of specifying their needs and give the DLS provider a basis for protocol selection.

The DLS QOS parameters can be divided into the following two types, based upon the way in which their values are determined:

- a) those QOS parameters which may be selected on a per-connection basis during the establishment phase of a DLC;
- b) those QOS parameters which are not selected during DLC establishment but whose values are known by other methods.

There are three QOS parameters, throughput, protection, and priority (as defined in 10.2.1, 10.2.5 and 10.2.6 respectively), which are of the type that may be selected during DLC establishment. The selection procedures for these parameters are described in detail in 12.2.5. Once the DLC is established, throughout the lifetime of the DLC, the agreed QOS values are not reselected at any point, and there is no guarantee that the original values will be maintained. The DLS users should also be aware that changes in QOS on a DLC are not explicitly signalled by the DLS provider.

The remaining QOS characteristics that are identified as parameters, but for which there is no selection during DLC establishment, are transit delay, residual error rate and resilience (as defined in 10.2.2 through 10.2.4 respectively). The values of these parameters for a particular DLC are determined by other methods such as *a priori* knowledge and agreement.

If selection is allowed, certain measures of QOS are requested by the sending DLS user when the DL-CONNECT request primitive action is initiated. The requested measures (or parameter values and options) are based on *a priori* knowledge by the DLS user of the service(s) made available to it by the DLS provider. Knowledge of the characteristics and type of service provided (i.e. the parameters, formats, and options that affect the transfer of data) is made available to a DLS user through some layer management interaction prior to (any) invocation of the DL connection-mode service. Thus, the DLS user has explicit knowledge of the characteristics of the service it can expect to be provided with each invocation of the service.

The DLS provider may also provide information on the current QOS independently of access to the service by the DLS user. This seemingly dynamic aspect of QOS determination is not a negotiation but provided with knowledge of the characteristics of the service currently outside of any instance of the invocation of the service.

10.2 Definition of connection-mode QOS parameters

QOS parameters can be classified as:

- a) parameters that express DLS performance, as shown in Table 2.
- b) parameters that express other DLS characteristics, as shown in Table 3.

NOTE – Some QOS parameters are defined in terms of the issuance of DLS primitives. Reference to a DLS primitive refers to the complete execution of that DLS primitive at the appropriate DLSAP.

Table 2 – Classification of performance QOS parameters

Performance criterion	
Speed	Accuracy/reliability
Throughput	Residual error rate (corruption, duplication/loss)
Transit delay	Resilience

Table 3 – QOS parameters not associated with performance

Protection
Priority

10.2.1 Throughput

Throughput is defined as the total number of DLSDU bits successfully transferred by a DL-DATA request/DL-DATA indication primitive sequence divided by the input/output time for that sequence.

Successful transfer of the bits in a transmitted DLSDU is defined to occur when the bits are delivered to the intended receiving DLS user without error, in the proper sequence, prior to release of the DLC by the receiving DLS user.

The input/output time for a DL-DATA request/DL-DATA indication primitive sequence is the greater of the two times in the following list:

- a) the time between the first and the last DL-DATA request in the sequence;
- b) the time between the first and the last DL-DATA indication in the sequence.

Throughput is only meaningful for a sequence of complete DLSDUs.

Throughput is specified independently for each direction of transfer. In general, each throughput specification will define both the desired target value and the minimum acceptable value (or lowest acceptable QOS) for a DLC. Each specification is an average rate and will be based on a previously stated average DLSDU size.

Either the input or the output of a sequence of DLSDUs may be delayed excessively by the DLS users. Occurrences of delay caused by the DLS users are excluded in calculating average throughput values.

10.2.2 Transit delay

Transit delay is the elapsed time between DL-DATA request primitives and the corresponding DL-DATA indication primitives. Elapsed time values are calculated only on DLSDUs that are successfully transferred.

Successful transfer of a DLSDU for the purposes of the QOS parameter is defined to occur when the DLSDU is transferred from the sending DLS user to the intended receiving DLS user without error, and in the proper sequence prior to release of the DLC by the receiving DLS user.

For connection-mode transfer transit delay is specified independently for each direction of transfer. Each specification is based on a previously stated average DLSDU size.

The transit delay for an individual DLSDU may be increased if the receiving DLS user exercises interface flow control. Such occurrences are excluded in calculating transit delay values.

10.2.3 Residual error rate

Residual error rate is the ratio of total incorrect, lost and duplicate DLSDUs to total DLSDUs transferred across the DLS boundary during a measurement period. The relationship among these quantities is defined, for a particular DLS user pair, as shown in Figure 2.

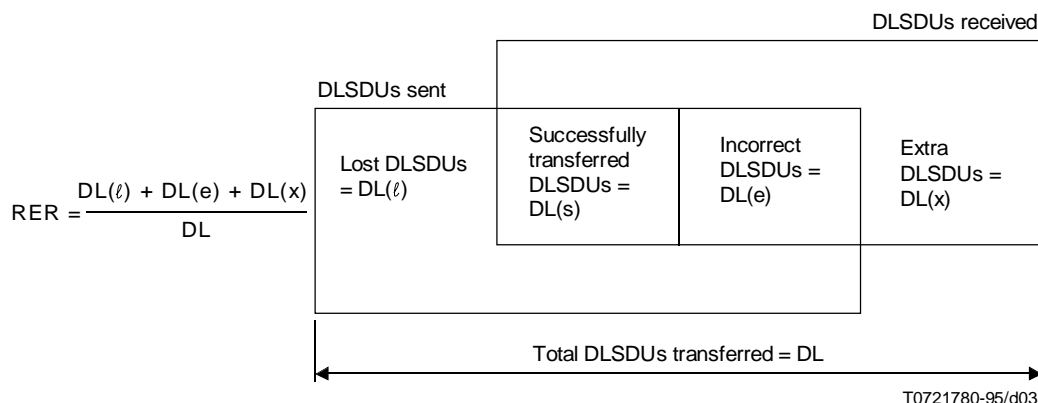

Figure 2 – Components of Residual Error Rate

10.2.4 Resilience

This parameter specifies the probability of:

- a) a DLS provider initiated DLC release (i.e. the issuance of a DL-DISCONNECT indication primitive with no prior DL-DISCONNECT request primitive); or
- b) a DLS provider initiated reset (i.e. the issuance of a DL-RESET indication primitive with no prior DL-RESET request primitive);

during a specified time interval on an established DLC.

10.2.5 Protection

Protection is the extent to which a DLS provider attempts to prevent unauthorized monitoring or manipulation of DLS user originated information. Protection is specified by a minimum and maximum protection option within a range of three possible protection options:

- a) no protection features;
- b) protection against passive monitoring; and
- c) protection against modification, replay, addition or deletion.

Within the specified range, a DLS user selects a particular value during DLC establishment.

Each protection feature addresses a particular type of privacy or security threat, and each if available is typically provided by a different DLS provider mechanism.

10.2.6 Priority

The specification of priority is concerned with the relationship between DLCs.

This parameter specifies the relative importance of a DLC with respect to:

- a) the order in which DLCs are to have their QOS degraded, if necessary; and
- b) the order in which DLCs are to be released to recover resources, if necessary.

Priority is specified by a minimum and a maximum within a given range. Within the specified range, a DLS user selects a particular value during DLC establishment.

This parameter only has meaning in the context of some management entity of structure able to judge relative importance. The number of priority levels is limited.

11 Sequence of primitives

11.1 Concepts used to define the connection-mode Data Link Service

The service definition uses the following concepts:

- a) DLC can be dynamically established or terminated between the DLS users for the purpose of exchanging data;
- b) associated with each DLC, certain measures of QOS that are agreed between the DLS provider and the DLS users when the connection is established;
- c) the DLC allows transmission of data and preserves its division into DLSDUs; the transmission of this data is subject to flow control;
- d) the DLC can be returned to a defined state, and the activities of the two DLS users synchronized by the use of a Reset Service;
- e) failure to provide the requested service may be signalled to the DLS user. There are three classes of failure:
 - 1) failures involving termination of the DLC;
 - 2) failures involving loss or duplication of user data, but without loss of DLC; and
 - 3) failures to provide the requested QOS without loss or duplication of user data or loss of the DLC.

11.2 Constraints of Sequence of Primitives

This clause defines the constraints of the sequence in which the primitives defined in clauses 12-14 may occur. The constraints determine the order in which primitives occur, but do not fully specify when they may occur. Other constraints, such as flow control of data, will affect the ability of a DLS user or a DLS provider to issue a primitive at any particular time.

The connection-mode primitives and their parameters are summarized in Table 4.

Table 4 – Summary of data-link-connection-mode primitives and parameters

Phase	Service	Primitive	Parameters
DLC establishment	DLC establishment	DL-CONNECT request	(Called address, calling address, QOS parameter set, DLS user-data)
		DL-CONNECT indication	(Called address, calling address, QOS parameter set, DLS user-data)
		DL-CONNECT response	(Responding address, QOS parameter set, DLS user- data)
		DL-CONNECT confirm	(Responding address, QOS parameter set, DLS user-data)
Data transfer	Normal data transfer	DL-DATA request	(DLS user-data)
		DL-DATA indication	(DLS user-data)
	Reset	DL-RESET request	(Reason)
		DL-RESET indication	(Originator, reason)
		DL-RESET response	
		DL-RESET confirm	
DLC release	DLC release	DL-DISCONNECT request	(Reason, DLS user-data)
		DL-DISCONNECT indication	(Originator, reason, DLS user-data)

11.2.1 Relation of primitives at the two endpoints

A primitive issued at one DLC endpoint will, in general, have consequences at the other DLC endpoint. The relations of primitives of each type at one DLC endpoint to primitives at the other DLC endpoint are defined in the appropriate subclauses of clauses 12-15; all of these relations are summarized in the diagrams in Figure 3.

However, a DL-DISCONNECT request or indication primitive may terminate any of the other sequences before completion.

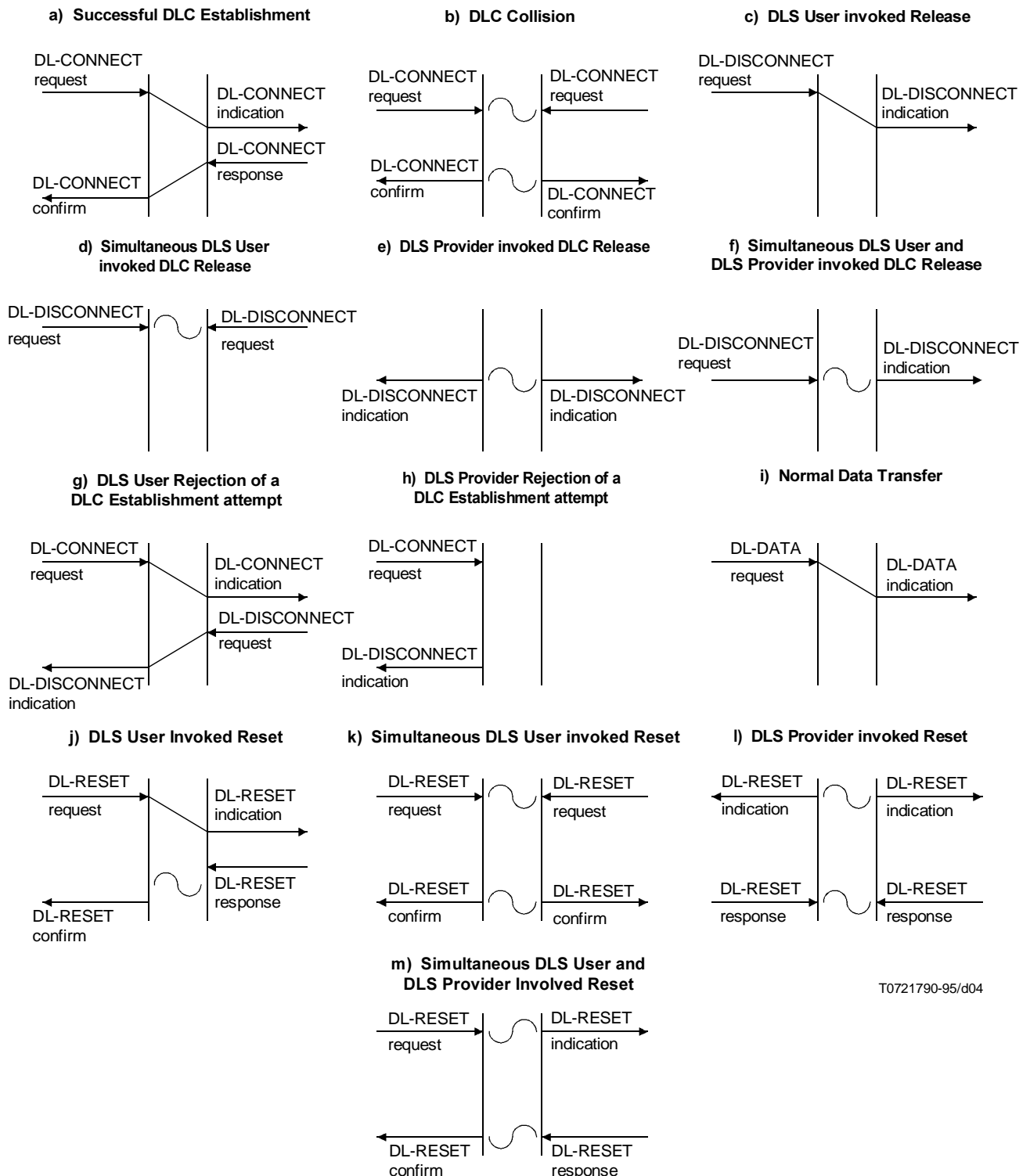

Figure 3 – Summary of Data-link-connection-mode Service Primitive Time-sequence Diagram

11.2.2 Sequence of primitives at one DLC endpoint

The possible overall sequences of primitives at a DLC endpoint are defined in the state transition diagram, Figure 4. In the diagram:

- a) DL-DISCONNECT stands for either the request or the indication form of the primitive in all cases.
- b) The labelling of the states “DLS user initiated reset pending” (5) and “DLS provider initiated reset pending” (6) indicate the party that started the local interaction, and does not necessarily reflect the value of the originator parameter.
- c) The “Idle” state (1) reflects the absence of a DLC. It is the initial and final state of any sequence, and once it has been re-entered, the DLC is released.
- d) The use of a state transition diagram to describe the allowable sequences of service primitives does not impose any requirements or constraints on the internal organization of any implementation of the service.

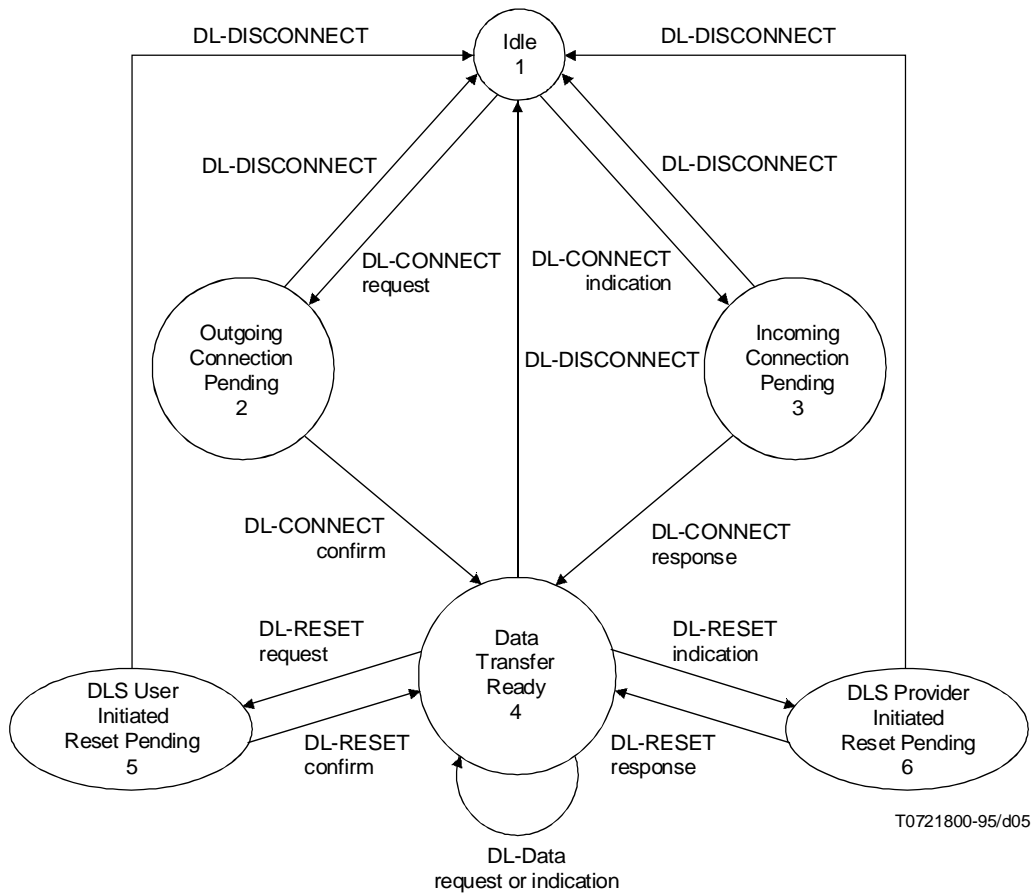

Figure 4 – State transition diagram for Sequences of Data-link-connection-mode Service primitives at a DLC Endpoint

12 Connection establishment phase

12.1 Function

The connection establishment service primitives can be used to establish a DLC.

Simultaneous DL-CONNECT request primitives at the two DLSAPs result in one DLC as indicated in Figure 5.

12.2 Types of primitives and parameters

Table 5 indicates the types of primitives and the parameters needed for connection establishment.

Table 5 – DLC establishment primitives and parameters

Parameter	DL-CONNECT request	DL-CONNECT indication	DL-CONNECT response	DL-CONNECT confirm
Called address	X	X(=) (Note 2)		
Calling address	X (Note 2)	X(=)		
Responding address			X (Notes 1, 2)	X(=)
Quality of service parameter set	X	X	X	X
DLS user-data	X (Note 3)	X(=)	X (Note 3)	X(=)

NOTES

- 1 The need for responding address parameter is for further study.
- 2 This parameter may be implicitly associated with the DLSAP at which the primitive is issued.
- 3 The maximum amount of DLS user-data on the DLC is agreed between the DLS users and the DLS provider.

12.2.1 Addresses

The parameters which take addresses as values (see 12.2.2-12.2.4) all refer to DLSAP addresses.

NOTE – If the configuration allows any of these addresses to be known by the DL entity on an *a priori* basis, then these DLSAP address(es) need not explicitly be conveyed in the protocol.

12.2.2 Called address

The called address parameter conveys an address identifying the DLSAP to which the DLC is to be established.

12.2.3 Calling address

The calling address parameter conveys the address of the DLSAP from which the DLC has been requested.

12.2.4 Responding address

The responding address parameter conveys the address of the DLSAP to which the DLC has been established.

12.2.5 Quality of Service parameter set

The use of the QOS parameter selection is not required when only one level of QOS is offered by the DLS provider.

12.2.5.1 Throughput

Two quality of service sub-parameters “target” and “lowest quality acceptable”, which are in the agreed range, are passed to the DLS provider in the DL-CONNECT request primitive. The DLS provider will indicate to the DLS users, the “available” throughput in the DL-CONNECT confirm primitive, and DL-CONNECT indication primitives. The “available throughput” parameter shall be a value from the range between the “target” and “lowest quality acceptable” (see 10.2.1).

12.2.5.2 Selected protection

This parameter specifies a particular degree of protection, within the agreed range (see 10.2.5) for the DLSDU of any subsequently submitted DL-DATA request primitive transferred on the DLC.

12.2.5.3 Selected priority

This parameter specifies a particular priority, within the agreed range (see 10.2.6), for the DLSDU of any subsequent DL-DATA request primitive transferred on the DLC.

12.2.6 DLS user-data

This parameter allows the transmission of DLS user-data between DLS users, without modification by the DLS provider, during the DLC establishment phase. The DLS users may transmit any integral number of octets up to a limit agreed between the DLS users and the DLS provider. The value of this limit (including 0) is made available to the DLS users by the use of management facilities or *a priori* knowledge.

12.3 Sequence of primitives

The sequence of primitives in a successful connection establishment is defined by the time-sequence diagram in Figure 5.

These DLC establishment procedures may fail either due to the inability of the DLS provider to establish a DLC or due to the unwillingness of the called DLS user to accept a DL-CONNECT indication primitive (for these cases see DLC release service, see 13.4 and 13.5).

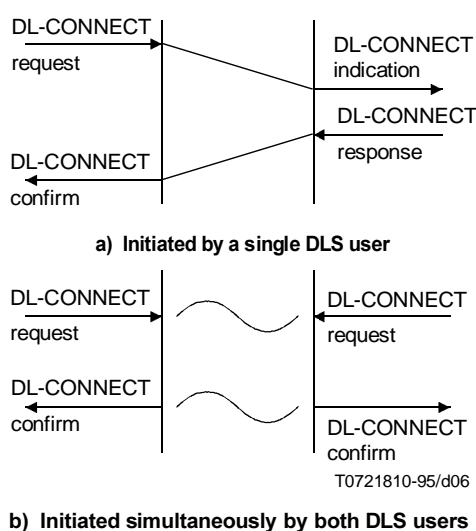

Figure 5 – DLC Establishment

13 Connection release phase

13.1 Function

The connection release service primitives are used to release a DLC. The release may be initiated by any of the following:

- a) either or both of the DLS users, to release an established DLC;
- b) the DLS provider to release an established DLC; all failures to maintain a DLC are indicated in this way;
- c) the DLS user, to reject a DL-CONNECT indication primitive;
- d) the DLS provider, to indicate its inability to establish a requested DLC; or
- e) the DLS user which sent the DL-CONNECT request primitive, to abandon the connection attempt before the connection has been made available for use by receipt of a DL-CONNECT confirm primitive.

Initiation of the release service is permitted at any time regardless of the current phase of the DLC. Once a release service has been initiated, the DLC will be disconnected. A DL-DISCONNECT request primitive cannot be rejected. The DLS does not guarantee delivery of any DLSDU associated with the DLC once the release phase is entered.

13.2 Types of primitive and parameters

Table 6 indicates the types of primitives and the parameters needed for connection release.

Table 6 – DLC release primitives and parameters

Parameter	Primitive	DL-DISCONNECT request	DL-DISCONNECT indication
Originator			X
Reason		X	X
DLS user-data		X (Note)	X(=)
NOTE – The maximum amount of DLS user-data on the DLC is agreed between the DLS users and the DLS provider.			

13.2.1 Originator

The originator parameter indicates the source of the DLC release. Its value indicates either the DLS user, the DLS provider, or that the originator is unknown.

13.2.2 Reason

The reason parameter gives information about the cause of the release. The value conveyed in this parameter will be as follows:

- a) When the originator parameter indicates a DLS provider generated DLC release, the value is one of:
 - 1) “disconnection-permanent condition”;
 - 2) “disconnection-transient condition”;
 - 3) “connection rejection-DLSAP-address unknown”;
 - 4) “connection rejection-DLSAP unreachable/permanent condition”;
 - 5) “connection rejection-DLSAP unreachable/transient condition”;
 - 6) “connection rejection-QOS not available/permanent condition”;
 - 7) “connection rejection-QOS not available/transient condition”; or
 - 8) “reason unspecified”.

NOTE – Addition to, or refinement of this list of values to convey more specific diagnostic and management information is for further study.

- b) When the originator parameter indicates DLS user initiated DLC release, the value is one of:
 - 1) “disconnection-normal condition”;
 - 2) “disconnection-abnormal condition”;
 - 3) “connection rejection-permanent condition”;
 - 4) “connection rejection-transient condition”; or
 - 5) “reason unspecified”, and
- c) When the originator parameter indicates an unknown originator the value of the reason parameter is “reason unspecified”. This allows the parameters to be implied when they cannot be explicitly conveyed in the Data Link protocol.

13.2.3 DLS user-data

This parameter allows the transmission of DLS user-data from one DLS user to the other, without modification by the DLS provider, during DLC release phase. The DLS user releasing the DLS may transmit any integral number of octets up to a limit agreed between the DLS users and the DLS provider. The value of this limit (including 0) is made available to the DLS users by the use of management facilities or *a priori* knowledge.

13.3 Sequence of primitives when releasing an established DLC

The sequence of primitives depends on the origins of the DLC release action. The sequence may be:

- a) initiated by one DLS user, with a DL-DISCONNECT request primitive from that DLS user leading to a DL-DISCONNECT indication primitive to the other DLS user;
- b) initiated by both DLS users, with a DL-DISCONNECT request primitive from each of the DLS users;
- c) initiated by the DLS provider, with a DL-DISCONNECT indication primitive to each of the DLS users; or
- d) initiated independently by one DLS user and the DLS provider, with a DL-DISCONNECT request primitive from the originating DLS user and a DL-DISCONNECT indication primitive to the other.

The sequences of primitives in these four cases are defined by the time-sequence diagrams in Figures 6 to 9.

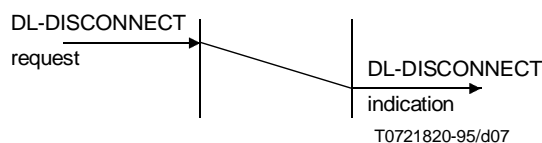

Figure 6 – DLS User invocation



Figure 7 – Simultaneous invocation by both DLS Users

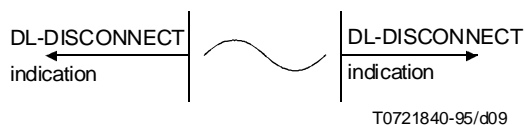

Figure 8 – DLS Provider invocation

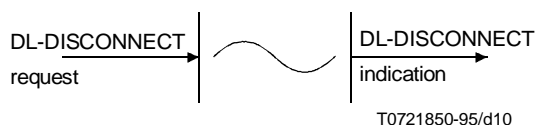

Figure 9 – Simultaneous DLS User and DLS Provider invocations

13.4 Sequence of primitives in a DLS user rejection of DLC establishment attempt

A DLS user may reject a DLC establishment attempt by using a DL-DISCONNECT request primitive. The originator parameter in the DL-DISCONNECT request and indication primitives will indicate DLS user initiated release. The sequence of events is defined in the time-sequence diagram in Figure 10.

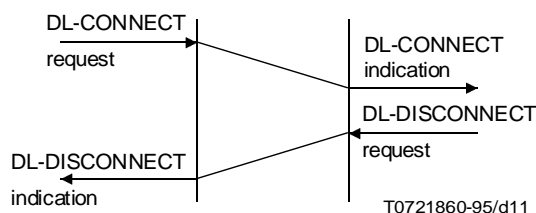

Figure 10 – Sequence of primitives in DLS User rejection of a DLC establishment attempt

13.5 Sequence of primitives in a DLS provider rejection of a DLC establishment attempt

If the DLS provider is unable to establish a DLC, it indicates this to the requester by a DL-DISCONNECT indication primitive. The originator parameter in this DL-DISCONNECT indication primitive indicates a DLS provider originated release. The sequence of events is defined in the time-sequence diagram in Figure 11.

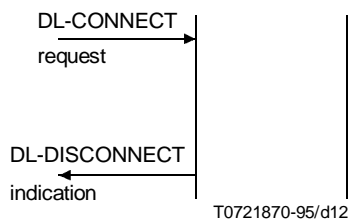

Figure 11 – Sequence of primitive in DLS Provider rejection of a DLC establishment attempt

13.6 Sequence of primitives in a DLS user abort of a DLC establishment attempt

If the DLS user, having previously sent a DL-CONNECT request primitive and not received a DL-CONNECT confirm primitive or DL-DISCONNECT indication primitive, wishes to abort the DLC establishment attempts, the DLS user shall issue a DL-DISCONNECT request primitive. The resulting sequence of primitives is dependent upon the relative timing of the primitives involved and the transit delay of the DLS provider as defined by the time-sequence diagrams in Figures 12 to 14. No information can be implied by detecting which of these alternatives occur.

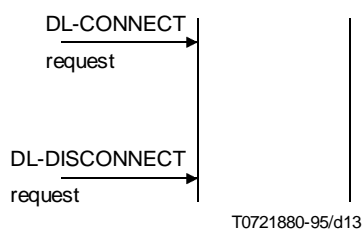

Figure 12 – Both primitives are destroyed in the queue

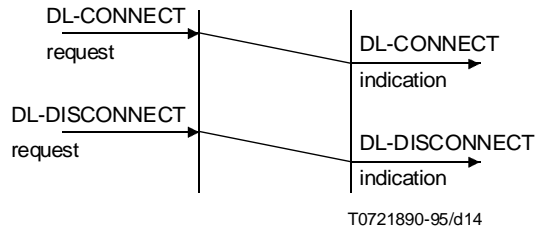

Figure 13 – DL-CONNECT response is sent

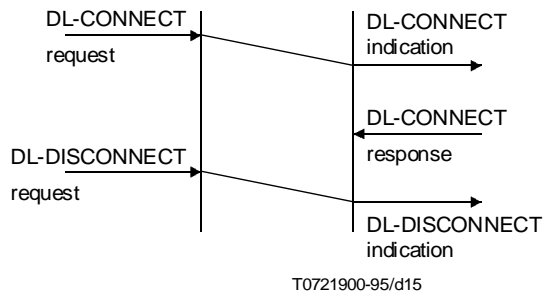

Figure 14 – DL-DISCONNECT indication arrives after DL-CONNECT response is sent

14 Data transfer phase

14.1 Data transfer

14.1.1 Function

The data transfer service primitives provide for an exchange of user-data (DLSDUs), in either direction or in both directions simultaneously on a DLC. The DLS preserves both the sequence and the boundaries of the DLSDUs.

NOTE – Designers of protocols using DLS should realize that the requested QOS applies to complete DLSDUs, and that divisions of available data into small DLSDUs may have cost implications because of the impact on cost optimization mechanisms operated by the DLS provider.

14.1.2 Types of primitives and parameter

Table 7 indicates the types of primitives and the parameters needed for data transfer.

Table 7 – Data transfer primitives and parameter

Primitive	DL-DATA request	DL-DATA indication
Parameter		
DLS user-data	X	X(=)

14.1.2.1 DLS user-data

This parameter allows the transmission of DLS user-data between DLS users, without modification by the DLS provider. The DLS user may transmit any integral number of octets greater than zero up to a limit determined by the DLS provider. The value of this limit is made available to the DLS user by the use of management facilities or *a priori* knowledge.

14.1.3 Sequence of primitives

The operation of the DLS in transferring DLSDUs can be modelled as a queue of unknown size within the DLS provider (see clause 9). The ability of a DLS user to issue a DL-DATA request primitive or of the DLS provider to issue a DL-DATA indication primitive depends on the behaviour of the receiving DLS user and the resulting state of the queue.

The sequence of primitives in a successful data transfer is defined in the time-sequence diagram in Figure 15.

The above sequence of primitives may remain uncompleted if any DL-RESET or any DL-DISCONNECT primitive occurs.

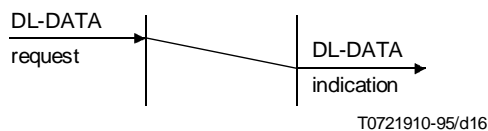

Figure 15 – Sequence of primitives for normal data transfer service

14.2 Reset service

14.2.1 Function

The reset service may be used:

- a) by the DLS user, to resynchronize the use of the DLC; or
- b) by the DLS provider, to report detected loss of data unrecoverable within the DLS. All loss of data which does not involve loss of the DLC is reported in this way.

Invocation of the reset service will unblock the flow of DLSDUs in case of congestion of the DLC; it will cause the DLS provider to discard DLSDUs, and to notify the DLS user or users that did not invoke the reset service that a reset has occurred. The service will be completed in a finite time, irrespective of the acceptance of DLSDUs. Any DLSDUs not delivered to the DLS users before completion of the service will be discarded by the DLS provider.

NOTE – A reset may require a recovery procedure to be performed by the DLS users.

14.2.2 Types of primitives and parameters

Table 8 indicates the types of primitives and the parameters needed for the reset service.

Table 8 – Reset primitives and parameters

Primitive	DL-RESET request	DL-RESET indication	DL-RESET response	DL-RESET confirm
Parameter				
Originator		X		
Reason	X	X		

14.2.2.1 Originator

The originator parameter indicates the source of the reset service. Its value indicates either the DLS user, the DLS provider, or that the originator is unknown.

14.2.2.2 Reason

The reason parameters give information indicating the cause of the reset service. The value conveyed in this parameter will be as follows:

- a) When the originator parameter indicates a DLS provider generated reset service, the value is one of:
 - 1) “Data Link flow control congestion”; or
 - 2) “Data Link error”.

NOTE – Addition to or refinement of this list of values to convey more specific diagnostic or management information is for further study.

- b) When the originator parameter indicates a DLS user initiated reset service, the value is “user resynchronization”; and
- c) When the originator parameter indicates an unknown originator, the value is “reason unspecified”. This allows the parameters to be implied when they cannot be explicitly conveyed in the Data Link protocol.

14.2.3 Sequence of primitives

The interaction between each DLS user and the DLS provider shall be either one of the following exchanges of primitives:

- a) a DL-RESET request primitive from the DLS user, followed by a DL-RESET confirm primitive from the DLS provider; or
- b) a DL-RESET indication primitive from the DLS provider, followed by a DL-RESET response primitive from the DLS user.

The DL-RESET request primitive acts as a synchronization mark in the stream of DLSDUs that are transmitted by the issuing DLS user; the DL-RESET indication primitive likewise acts as a synchronization mark in the stream of DLSDUs by the peer DLS user. Similarly, the DL-RESET response primitive acts as a synchronizing mark in the stream of DLSDUs transmitted by the responding DLS user, while the DL-RESET confirm primitive acts as a synchronization mark in the stream of DLSDUs that are received by the DLS user which originally issued the reset service.

The resynchronization properties of the reset service are that:

- 1) No DLSDU transmitted by the DLS user *before* the synchronization mark in that transmitted stream will be delivered to the other DLS user *after* the synchronization mark in that received stream.

The DLS provider will discard all DLSDUs, submitted before the issuing of the DL-RESET request primitive that have not been delivered to the peer DLS user when the DLS provider issues the DL-RESET indication primitive.

Also, the DLS provider will discard all DLSDUs, submitted before the issuing of the DL-RESET response primitive that have not been delivered to the initiator of the DL-RESET response primitive when the DLS provider issues the DL-RESET confirm primitive.

- 2) No DLSDU transmitted by a DLS user *after* the synchronization mark in that transmitted stream will be delivered to the other DLS user *before* the synchronization mark in that received stream.

The complete sequence of primitives depends upon the origin of the reset action and the occurrence or otherwise of conflicting origins. Thus the reset service may be:

- i) invoked by one DLS user, leading to interaction a) with that DLS user and interaction b) with the peer DLS user;
- ii) invoked by both DLS users, leading to interaction a) with both DLS users;
- iii) invoked by the DLS provider, leading to interaction b) with both DLS users; or
- iv) invoked by one DLS user and the DLS provider, leading to interaction a) with the originating DLS user and b) with the peer DLS user.

The sequence of primitives in these four cases is defined in the time-sequence diagrams in Figures 16-19.

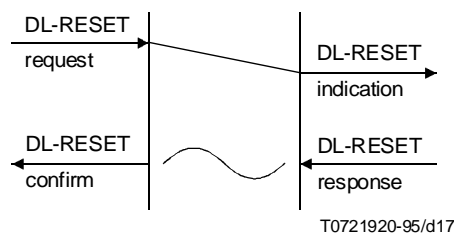

Figure 16 – Sequence of primitives in a DLS user initiated reset service

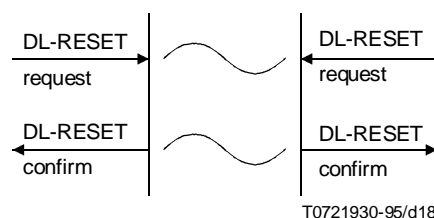

Figure 17 – Sequence of primitives in a simultaneous DLS user initiated reset service

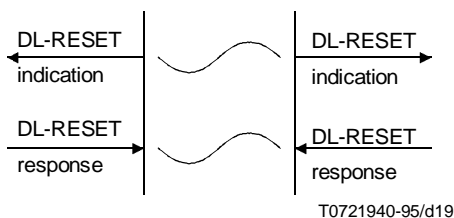

Figure 18 – Sequence of primitives in a DLS provider initiated reset service

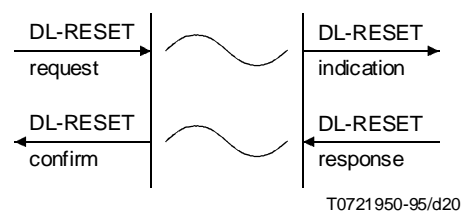

Figure 19 – Sequence of primitives in a simultaneous DLS user and DLS provider initiated reset service

The above sequences of primitives may remain uncompleted if a DL-DISCONNECT primitive occurs.

PART 3 – DEFINITION OF THE CONNECTIONLESS-MODE SERVICE

15 Features of the Connectionless-mode Data Link Service

The DLS provides the following features to the DLS user:

- a) a means by which DLSDUs of limited length are delimited and transparently transmitted from one source DLSAP to a destination DLSAP in a single DLS access, without establishing or later releasing a DLC;
- b) associated with each instance of connectionless-mode transmission, certain measures of QOS which are selected by the sending DLS user when the connectionless-mode transmission is initiated.

16 Model of the Connectionless-mode Data Link Service

This Recommendation | International Standard uses the abstract model for a layer service defined in clause 4 of ITU-T Rec. X.210 | ISO/IEC 10731. The model defines the interactions between the DLS users and DLS provider which takes place at the two DLSAPs. Information is passed between the DLS user and the DLS provider by service primitives, which may convey parameters.

16.1 Model of a data-link-connectionless-mode data transmission

A defining characteristic of data-link-connectionless-mode data transmission is the independent nature of each invocation of the DL-connectionless-mode service.

In practice, however, it is often possible to relate to DLS users certain characteristics of the service for an association existing between a given pair of DLSAPs, which enhance the basic data-link-connectionless-mode service in order to effectively correlate the choice of Network Layer protocol type with the service provided.

NOTE – It is anticipated that such information is made available to the DLS user through some management facility (or set of facilities).

Thus, as a descriptive aid, the data-link-connectionless-mode service – as provided between any two DLSAPs – can be modelled in the abstract as an association between the two DLSAPs. This association is permanent.

Only one type of object, the unitdata object, can be handed over to the DLS provider via a DLSAP. In Figure 20, DLS user A represents the DLS user that passes objects to the DLS provider. DLS user B represents the DLS user that accepts objects from the DLS provider.

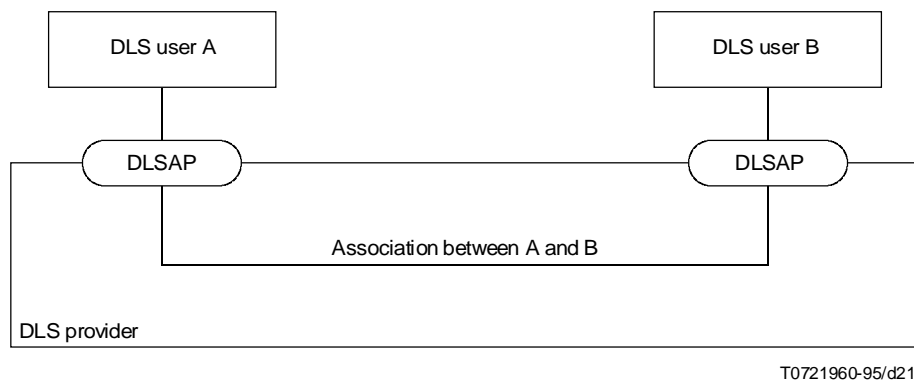

Figure 20 – Model for a connectionless DLS data transmission

In general, the DLS provider may perform any or all of the following actions:

- a) discard objects;
- b) duplicate objects; and/or
- c) change the order of service request primitives into a different order of service indication primitives.

However, with respect to a given association, some characteristics of the nature and type of service, beyond those attributed to the basic DL-connectionless-mode service, may be related to the DLS user through some management facility. The following are examples of some requirements or constraints that may be assumed/observed by the DLS user:

- a) objects will not be discarded;
- b) objects will not be duplicated; and
- c) the order of the service indication primitives will be the same as the order of the service request primitives.

Where such information is made known to the DLS user prior to the invocation of the DL-connectionless-mode service, it may make use of such knowledge to select an appropriate Network Layer protocol.

The operations that are performed by the DLS provider for a particular DL association do not depend on the behaviour of the DLS users. Awareness of the characteristics of the DLS provided is part of the DLS users' *a priori* knowledge of the OSI environment.

17 Quality of Connectionless-mode Service

The term "Quality of Service" (QOS) refers to certain characteristics of a connectionless-mode data transmission as observed between the DLSAPs. QOS describes aspects of a connectionless-mode data transmission which are solely attributable to the DLS provider; it can only be properly determined in the absence of DLS user behaviour (which is beyond the control of the DLS provider) that specifically constrains or impedes the performance of the DLS.

Whether the view of the QOS during each instance of the use of connectionless-mode data transmission is the same to each DLS user associated with the service, depends on the nature of their association and the type of information concerning the nature of the service made available to the DLS user(s) by the DLS provider prior to the invocation of the service.

17.1 Determination of QOS for Connectionless-mode Service

A basic characteristic of a connectionless-mode service is that, unlike a connection-mode service, no dynamic association similar to that during a connection establishment is set up between the parties involved. Thus, the service characteristics to be provided during the transfer are not selected on a per DLC basis.

Associated with each DL connectionless-mode transmission, certain measures of QOS are requested by the sending DLS user when the primitive action is initiated. The requested measures (or parameter values) and options, are based on *a priori* knowledge by the DLS user of the service(s) made available to it by the DLS provider. Knowledge of the characteristics and type of service provided (i.e. the parameters, formats, and options that affect the transfer of data) is made available to a DLS user through some layer management interaction prior to (any) invocation of the DL-connectionless-mode service. Thus, the DLS user not only has knowledge of the parties with which it may communicate, it also has explicit knowledge of the characteristics of the service it can expect to be provided with each invocation of the service.

The DLS provider may also provide information on the current QOS independently of access to the service by a DLS user. This seemingly dynamic aspect of QOS determination is not a negotiation but provided with knowledge of the characteristics of the service currently outside of any instance of the invocation of the service.

17.2 Definition of connectionless-mode QOS parameters

QOS parameters are classified as:

- a) parameters that express DLS performance, as shown in Table 9.
- b) parameters that express other DLS characteristics, as shown in Table 10.

NOTE – Some QOS parameters are defined in terms of the issuance of DLS primitives. Reference to a DLS primitive refers to the complete execution of that DLS primitive at the appropriate DLSAP.

Table 9 – Classification of performance QOS parameters

Performance criterion	
Speed	Accuracy/reliability
Transit delay	Residual error rate (corruption, duplication/loss)

Table 10 – QOS parameters not associated with performance

Protection Priority

17.2.1 Transit delay

Transit delay is the elapsed time between DL-UNIT-DATA request primitives and the corresponding DL-UNIT-DATA indication primitives. Elapsed time values are calculated only on DLSDUs that are successfully transferred.

Successful transfer of a DLSDU is defined, for the purpose of this QOS parameter, to occur when the DLSDU is transferred from the sending DLS user to the intended receiving DLS user without error.

For connectionless-mode transfer, transit delay is specified independently for each data-link-connectionless-mode data transmission.

The transit delay for an individual DLSDU may be increased if the receiving DLS user exercises interface flow control. Such occurrences are excluded in calculating both average and maximum transit delay values.

17.2.2 Residual Error Rate

Residual error rate is the ratio of total incorrect, lost and duplicate DLSDUs to total DLSDUs transferred across the DLS boundary during a measurement period. The relationship among these quantities is defined, for a particular DLS user pair, as shown in Figure 21.

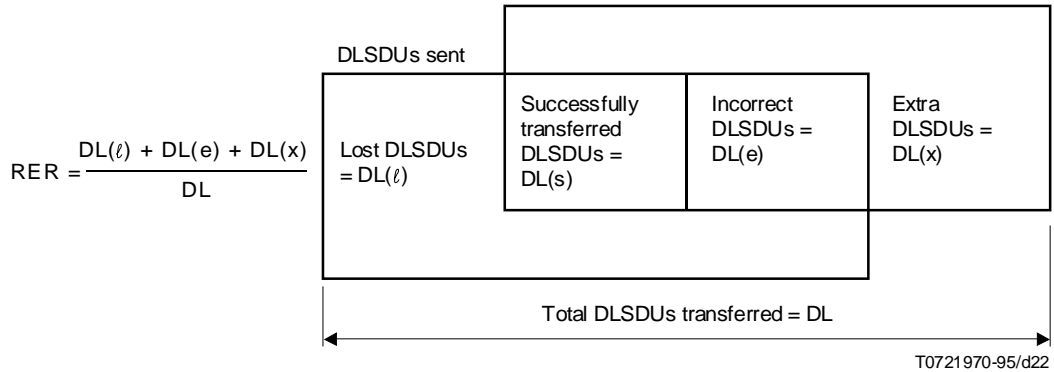

Figure 21 – Components of Residual Error Rate

17.2.3 Protection

Protection is the extent to which a DLS provider attempts to prevent unauthorized monitoring or manipulation of DLS user originated information. Protection is specified by a minimum and maximum protection option within a range of three possible protection options:

- a) no protection features;
- b) protection against passive monitoring; and
- c) protection against modification, replay, addition or deletion.

Within the specified range, a DLS user selects a particular value for each DLSDU submitted or connectionless-mode data transmission.

Each protection feature addresses a particular type of privacy or security threat and each is typically provided by a different DLS provider mechanism.

17.2.4 Priority

The specification of priority is concerned with the relationship between connectionless-mode data transfer invocations.

This parameter specifies the relative importance of unitdata objects with respect to gaining use of shared resources.

This parameter only has meaning in the context of some management entity of structure able to judge relative importance. The number of priority levels is limited.

18 Sequence of connectionless-mode primitives at one DLSAP

The possible overall allowed sequence of primitives at a DLSAP are defined in the state transition diagram in Figure 22.

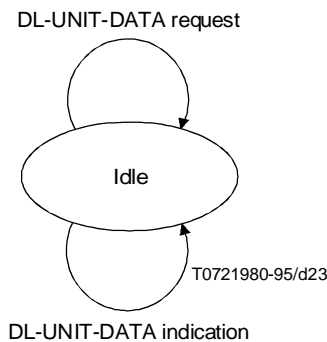

Figure 22 – State transition diagram for sequences of connectionless-mode primitives at one DLSAP

19 Data transfer

19.1 Function

Data-link connectionless-mode data transmission service primitives can be used to transmit an independent, self-contained DLSDU from one DLSAP to another DLSAP in a single DL service access. The DLSDU is independent in the sense that it bears no relationship to any other DLSDU transmitted through the invocation of the connectionless-mode service or the connection-mode service (unless specific QOS requests have been accepted). It is self-contained in that all of the information required to deliver the DLSDU is presented to the DLS provider, together with the user data to be transmitted, in a single service access; thus, no initial establishment or subsequent release of a DLS is required, provided that the DLS users exist and are known to the DLS provider.

A DLSDU transmitted using data-link-connectionless-mode data transmission is not considered by the DLS provider to be related in any way to any other DLSDU. Although the DLS maintains the integrity of individual DLSDUs, it does not necessarily deliver them to the receiving DLS user in the order in which they are presented by the sending DLS user.

No means are provided by which the receiving DLS user may control the rate at which the sending DLS user may send DLSDU (peer-to-peer flow control). The DLS provider will not maintain any state information relative to any aspects of the flow of information between any specific combination of DLSAPs. Flow control exerted by the DLS provider upon the sending DLS user can only be described in terms of a specific interface.

19.2 Types of primitives and parameters

Table 11 indicates the types of primitives and parameters needed for the data-link-connectionless-mode data transfer service.

Table 11 – Data-link-connectionless-mode data transfer primitives and parameters

Parameter	Primitive	DL-UNIT-DATA request	DL-UNIT-DATA indication
Source address		X	X(=)
Destination address		X	X(=)
QOS parameter set		X	X (Note)
DLS user-data		X	X(=)
NOTE – The need for QOS parameters to be included in the DL-UNIT-DATA indication is for further study.			

19.2.1 Addresses

The addresses referred to in Table 11 are DLSAP addresses. The connection-mode and connectionless-mode DLSs may both use the same DLSAP addresses.

NOTE – If the configuration allows any of these addresses to be known by the data link entity on an *a priori* basis, then these DLSAP addresses need not explicitly be conveyed in this protocol.

19.2.2 Quality of Service

The value of the QOS parameter is a list of sub-parameters. For each parameter, the values on the two primitives are related so that:

- a) on the DL-UNIT-DATA request primitive, any defined value is allowed; and
- b) on the DL-UNIT-DATA indication primitive, the quality of service indicated is less than or equal to the value specified for the corresponding DL-UNIT-DATA request primitive.

The use of the QOS parameter selection is not required when only one level of QOS is offered by the DLS provider.

19.2.3 DLS User-Data

This parameter allows the transmission of DLS user-data between DLS users, without modification by the DLS provider. The DLS user may transmit any integral number of octets greater than zero up to a limit determined by the DLS provider. The value of this limit is made available to the DLS user by the use of management facilities or *a priori* knowledge.

19.3 Sequence of primitives

The sequence of primitives in a successful data-link-connectionless-mode data transmission is defined in the time-sequence diagram in Figure 23.

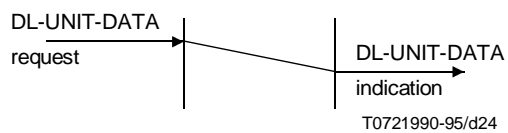

Figure 23 – Sequence of primitives in data-link-connectionless-mode data transfer