



INTERNATIONAL TELECOMMUNICATION UNION

ITU-T

TELECOMMUNICATION
STANDARDIZATION SECTOR
OF ITU

X.211

(11/95)

**DATA NETWORKS AND OPEN SYSTEM
COMMUNICATIONS**

**OPEN SYSTEMS INTERCONNECTION –
SERVICE DEFINITIONS**

**INFORMATION TECHNOLOGY –
OPEN SYSTEMS INTERCONNECTION –
PHYSICAL SERVICE DEFINITION**

ITU-T Recommendation X.211

(Previously “CCITT Recommendation”)

FOREWORD

ITU (International Telecommunication Union) is the United Nations Specialized Agency in the field of telecommunications. The ITU Telecommunication Standardization Sector (ITU-T) is a permanent organ of the ITU. Some 179 member countries, 84 telecom operating entities, 145 scientific and industrial organizations and 38 international organizations participate in ITU-T which is the body which sets world telecommunications standards (Recommendations).

The approval of Recommendations by the Members of ITU-T is covered by the procedure laid down in WTSC Resolution No. 1 (Helsinki, 1993). In addition, the World Telecommunication Standardization Conference (WTSC), which meets every four years, approves Recommendations submitted to it and establishes the study programme for the following period.

In some areas of information technology which fall within ITU-T's purview, the necessary standards are prepared on a collaborative basis with ISO and IEC. The text of ITU-T Recommendation X.211 was approved on 21st of November 1995. The identical text is also published as ISO/IEC International Standard 10022.

NOTE

In this Recommendation, the expression "Administration" is used for conciseness to indicate both a telecommunication administration and a recognized operating agency.

© ITU 1996

All rights reserved. No part of this publication may be reproduced or utilized in any form or by any means, electronic or mechanical, including photocopying and microfilm, without permission in writing from the ITU.

ITU-T X-SERIES RECOMMENDATIONS

DATA NETWORKS AND OPEN SYSTEM COMMUNICATIONS

(February 1994)

ORGANIZATION OF X-SERIES RECOMMENDATIONS

Subject area	Recommendation Series
PUBLIC DATA NETWORKS	
Services and Facilities	X.1-X.19
Interfaces	X.20-X.49
Transmission, Signalling and Switching	X.50-X.89
Network Aspects	X.90-X.149
Maintenance	X.150-X.179
Administrative Arrangements	X.180-X.199
OPEN SYSTEMS INTERCONNECTION	
Model and Notation	X.200-X.209
Service Definitions	X.210-X.219
Connection-mode Protocol Specifications	X.220-X.229
Connectionless-mode Protocol Specifications	X.230-X.239
PICS Proformas	X.240-X.259
Protocol Identification	X.260-X.269
Security Protocols	X.270-X.279
Layer Managed Objects	X.280-X.289
Conformance Testing	X.290-X.299
INTERWORKING BETWEEN NETWORKS	
General	X.300-X.349
Mobile Data Transmission Systems	X.350-X.369
Management	X.370-X.399
MESSAGE HANDLING SYSTEMS	X.400-X.499
DIRECTORY	X.500-X.599
OSI NETWORKING AND SYSTEM ASPECTS	
Networking	X.600-X.649
Naming, Addressing and Registration	X.650-X.679
Abstract Syntax Notation One (ASN.1)	X.680-X.699
OSI MANAGEMENT	X.700-X.799
SECURITY	X.800-X.849
OSI APPLICATIONS	
Commitment, Concurrency and Recovery	X.850-X.859
Transaction Processing	X.860-X.879
Remote Operations	X.880-X.899
OPEN DISTRIBUTED PROCESSING	X.900-X.999

CONTENTS

	<i>Page</i>
1 Scope	1
2 Normative references	1
2.1 Identical Recommendations International Standards	1
3 Definitions	1
3.1 Basic Reference Model definitions	1
3.2 Service convention definitions	2
4 Abbreviations	2
5 Conventions	2
5.1 General conventions	2
5.2 Parameters	2
5.3 PhC endpoint identification convention	3
6 Overview and general characteristics	3
7 Features of the Physical Service	3
7.1 The Physical Service offers the following features to a PhS user	3
7.2 Other aspects of the Physical Service include	4
8 Classes of Physical Service	4
9 Model of the Physical Service	4
9.1 Model of the layer service	4
9.2 Model of a point-to-point PhC	5
9.3 Model of a relayed point-to-point PhC where the relay is controlled within the PhS Provider	5
9.4 Model of a relayed point-to-point PhC where the relay is controlled from the Network Layer	6
10 Quality of Physical Service	6
10.1 Definition of PhC QOS	6
10.2 Determination of QOS values	8
11 Sequence of primitives	8
11.1 Relation of primitives at the two PhC endpoints	8
11.2 Sequence of primitives at one PhC endpoint	8
12 PhC activation phase	14
12.1 Function	14
12.2 Types of primitives and parameters	14
12.3 Sequence of primitives	14
13 PhC deactivation phase	14
13.1 Function	14
13.2 Types of primitives and parameters	14
13.3 Sequence of primitives	14
14 Data transfer phase	17
14.1 Function	17
14.2 Types of primitives and parameters	17
14.3 Sequence of primitives	17

	<i>Page</i>
Annex A – Internal structure of the Physical Layer	18
A.1 Introduction.....	18
A.2 Classifications regarding multiplexing	18
A.3 Isochronous transmission.....	18
Annex B – Operation of data link protocol using the half-duplex physical service	20
B.1 Introduction.....	20
B.2 Operation	20
Annex C – Composite state transition diagram	23
C.1 Introduction.....	23

Summary

This Recommendation | International Standard defines the set of capabilities, in terms of abstract service definition, provided by the Physical Layer to the Data Link Layer. For designers of Data Link Layer protocols, it provides a definition of the Physical service to allow design and implementation independent of details of the Physical Layer protocol. For designers of Physical Layer protocols, it defines the set of capabilities to be made available through the action of the protocol over the underlying physical media.

Introduction

This Recommendation | International Standard is one of a set of Recommendations and International Standards produced to facilitate the interconnection of information processing systems. It is related to other Recommendations | International Standards in the set as defined by the Open Systems Interconnection (OSI) Basic Reference Model (see ITU-T Rec. X.200 | ISO/IEC 7498-1). The OSI Basic Reference Model subdivides the area of standardization for interconnection into a series of layers of specification, each of manageable size.

This Recommendation | International Standard defines the service provided by the Physical Layer to the Data Link Layer at the boundary between the Physical and Data Link Layers of the OSI Basic Reference Model. It provides for the designers of Data Link Protocols a definition of the Physical Service existing to support the Data Link Protocol and for the designers of Physical Protocols a definition of the services to be made available through the action of the Physical Protocol over the underlying physical media, which are external to the OSI Physical Layer. The relationship of the Physical Layer with the Data Link Layer is illustrated in Figure Intro. 1.

NOTE – It is important to distinguish the specialized use of the term “Service” within the set of OSI Recommendations | International Standards from its use elsewhere to describe the provision of a service by some organizations (i.e. the provision of a service by an Administration as defined in Recommendations of the ITU-T).

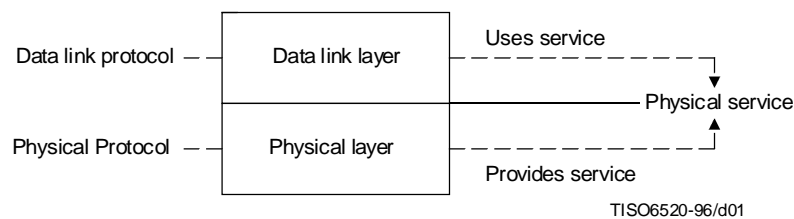

Figure Intro. 1 – Relationship of this Recommendation | International Standard to other OSI Recommendations | International Standards

INTERNATIONAL STANDARD**ITU-T RECOMMENDATION****INFORMATION TECHNOLOGY – OPEN SYSTEMS INTERCONNECTION –
PHYSICAL SERVICE DEFINITION****1 Scope**

This Recommendation | International Standard defines the OSI Physical Service in terms of:

- a) the primitive actions and events of the Service;
- b) the parameters associated with each primitive action and event, and the form which they take;
- c) the interrelationship between, and the valid sequences of, these actions and events.

The principal objective of this Recommendation | International Standard is to specify the characteristics of a conceptual Physical Service and thus supplement the OSI Basic Reference Model in guiding the development of Physical Layer protocols.

This Recommendation | International Standard does not specify individual implementations or products nor does it constrain the implementation of entities and interfaces within an information processing system.

There is no conformance of equipment to this Recommendation | International Standard. Instead, conformance is achieved through implementation of conforming OSI Physical protocols that fulfil the Physical Service defined in this Recommendation | International Standard.

2 Normative references

The following Recommendations and International Standards contain provisions which, through reference in this text, constitute provisions of this Recommendation | International Standard. At the time of publication, the editions indicated were valid. All Recommendations and Standards are subject to revision, and parties to agreements based on this Recommendation | International Standard are encouraged to investigate the possibility of applying the most recent editions of the Recommendations and Standards listed below. Members of IEC and ISO maintain registers of currently valid International Standards. The Telecommunication Standardization Bureau of the ITU maintains a list of currently valid ITU-T Recommendations.

2.1 Identical Recommendations | International Standards

- ITU-T Recommendation X.200 (1994) | ISO/IEC 7498-1:1994, *Information technology – Open Systems Interconnection – Basic Reference Model: The Basic Model*.
- ITU-T Recommendation X.210 (1993) | ISO/IEC 10731:1994, *Information technology – Open Systems Interconnection – Basic Reference Model: Conventions for the definition of OSI services*.

3 Definitions

NOTE – Terms and definitions for Data communication and Open Systems Interconnection Architecture are given in ISO 2382-9 and ISO/IEC 2382-26.

3.1 Basic Reference Model definitions

This Recommendation | International Standard is based on the concepts developed in the OSI Basic Reference Model, ITU-T Rec. X.200 | ISO/IEC 7498-1, and makes use of the following terms defined in it:

- a) Data circuit;
- b) Physical connection;
- c) Physical layer;

ISO/IEC 10022 : 1996 (E)

- d) Physical media;
- e) Physical service;
- f) Physical service access point;
- g) Physical service data unit.

3.2 Service convention definitions

This Recommendation | International Standard also makes use of the following terms defined in the OSI Service Conventions, ITU-T Rec. X.210 | ISO/IEC 10731, as they apply to the Physical Layer:

- a) Physical Service user;
- b) Physical Service provider;
- c) primitive;
- d) request;
- e) indication.

4 Abbreviations

For the purposes of this Recommendation | International Standard, the following abbreviations apply:

OSI	Open Systems Interconnection
Ph	Physical
PhC	Physical Connection
PhL	Physical Layer
PhPDU	Physical Protocol Data Unit
PhS	Physical Service
PhSAP	Physical Service Access Point
PhSDU	Physical Service Data Unit
QOS	Quality of Service

5 Conventions

5.1 General conventions

This Recommendation | International Standard uses the descriptive conventions given in the OSI Service Conventions, ITU-T Rec. X.210 | ISO/IEC 10731.

The layer service model, service primitives, and time-sequence diagrams taken from those conventions are entirely abstract descriptions; they do not represent a specification for implementation.

5.2 Parameters

Service primitives, used to represent service-user/service-provider interactions (see ITU-T Rec. X.210 | ISO/IEC 10731) may convey parameters that indicate information available in the user/provider interaction.

The parameters which apply to each group of Physical Service primitives are set out in Table 1 to Table 4 (see clause 11 to clause 14). The tables also indicate the association of which parameters can be carried by each respective primitive.

Some entries are further qualified by items in brackets. These may be:

- a) an indication that the parameter is conditional in some way:
 - (C) indicates that the parameter is not present on the primitive for every connection; the parameter definition describes the conditions under which the parameter is present or absent;
- b) a parameter specific constraint:
 - (=) indicates that the value supplied in an indication primitive is always identical to that supplied in a previous request primitive issued at the peer service access point;

- c) an indication that some note applies to the entry:

(Note x) indicates that the referenced note contains additional information pertaining to the parameter and its use.

In any particular interface, not all parameters need be explicitly stated. Some may be implicitly associated with the PhSAP at which the primitive is issued.

5.3 PhC endpoint identification convention

If at a PhSAP there is more than one PhC and distinction among them is needed by the PhS user, PhC endpoint identification must be provided. All primitives issued at such a PhSAP would be required to use this mechanism to identify PhCs. Such an implicit identification is not described as a parameter of the service primitives in this Physical Service Definition.

When the PhC traverses relays which are controlled through a separate PhC, this implicit identification mechanism must provide additionally for identification of these dependencies.

6 Overview and general characteristics

The Physical Service provides for the transparent transfer of data between PhS users. It makes invisible to the PhS users the way in which supporting communication resources are utilized to achieve this transfer. Service classes are defined to categorize the distinctions that are visible to the PhS user.

The PhS provides for PhCs between PhS users. Since connections cannot be established through the protocol at the Physical Layer but rather are configured when the service is created, the PhC, which is a logical concept, nevertheless must relate directly to the real physical media paths provided to the Physical Layer. For this reason:

- a) There is no distinction between connection-mode and connectionless-mode at the Physical Layer. The service is independent of whether the higher layers operate in connection-mode or connectionless-mode.
- b) Each PhC is identified within the Physical Layer.
- c) A PhC can only relate to a particular PhSAP (i.e. a PhC implies a specific source PhSAP, and a specific destination PhSAP or group of PhSAPs if a multi-endpoint connection).

The PhC may traverse Physical Layer relay, or intermediate systems when several physical media are used in tandem. Such relaying may be controlled through a management function exercised over a separate, but related, PhC, or may be controlled from the Network Layer, as specified in ITU-T Rec. X.200 | ISO/IEC 7498-1, 7.5.4.2, for the interconnection of data circuits. The Physical Layer does not make any routing decisions. Intermediate systems may also be used for mapping different Physical Layer protocols associated with a PhC.

The Quality of Service provided by the Physical Service is pre-defined, in accordance with the class of service, though it may optionally be varied through management control of the configuration.

Actual data transmission takes place over the physical media. The mechanical, electromagnetic and other media dependent characteristics of the physical media connection are defined at the boundary (interface) between the Physical Layer and the physical media. Definitions of these characteristics are found in other ITU-T Recommendations and International Standards.

7 Features of the Physical Service

7.1 The Physical Service offers the following features to a PhS user

- a) **PhC activation:** The means to activate a PhC with another PhS user for the purpose of exchanging PhSDUs. More than one PhC may exist between the same pair of PhS users. The PhC Activation service is optional and need not apply for duplex or simplex transmission (i.e. sustained Data Transfer phase).

NOTE 1 – In a multiplexed realization of the Physical Layer, activation of the sublayer which carries all the PhCs (the control for which may appear to be at the service boundary relating to a particular PhC) may be necessary before activation of any of the other PhCs can occur. Such subsequent activations may provide only an activation indication at the service boundary, and may be implicit in the management or other action which establishes the entirety of a PhC which contains a Physical Layer relay.

- b) **PhC transfer:** The means of transferring PhSDUs on a PhC. A PhSDU consists of one bit or a string of bits. PhSDUs are transferred transparently over a PhC without change to the content (within the Quality of Service) or constraint on their data values. PhSDUs are delivered in the same order in which they are submitted.

NOTE 2 – Use of the term “bit” is not intended to preclude the use of non-binary codes.

- c) **PhC identification:** The means to identify, when necessary, individual PhCs at the PhSAPs. Note that the parameters to identify a particular PhC within the PhSAP are implicit (see 5.3).
- d) **PhC deactivation:** The means for unconditional, and therefore possible destructive, deactivation of a PhC by either the PhS user or by the PhS provider. The PhC Deactivation service is optional and need not apply for duplex or simplex transmission (i.e. sustained Data Transfer phase).

7.2 Other aspects of the Physical Service include

- a) The transfer of PhSDUs may be either duplex (two-way simultaneous), half-duplex (two-way alternate), or simplex (one way); either point-to-point or multi-endpoint; and either synchronous or asynchronous, as appropriate (see clause 8).
- b) The data signalling rate on the physical media may not correspond with the PhSDU throughput rate due to the inclusion of Physical Layer protocol control information, multiplexing function, encoding mechanisms, or other transmission control functions.
- c) PhSDU synchronization is provided by the Physical Service. This includes bit synchronization. Other delimiting may be available, which is a variable feature.
- d) PhC endpoint identifiers are not globally known. In the case of multiplexing, they will be conveyed implicitly or explicitly via the Physical protocol.
- e) Fault condition notifications to the PhS user, beyond conveying a PhC deactivation indication, are for further study. Fault condition notifications may include apparent faults due solely to transmission errors.

8 Classes of Physical Service

Distinctions of Physical Service are necessary to identify features that relate to the requirements of the service as seen by the Data Link Layer. These distinctions are:

- a) Type of transmission: synchronous and asynchronous.
- b) Mode of operation: duplex, half-duplex, and simplex.

NOTE 1 – While these modes describe the operation at the Physical Layer service boundary between the Physical Layer and the Data Link Layer, they do not necessarily imply the specific mode of operation of the Physical Layer entity and the interface between the Physical Layer and the underlying physical media. This applies to operations associated with specific PhS provider implementations, such as collision detection and multiplexing, which may map on to certain service primitives (for example, Activation and Deactivation) but are otherwise transparent to the PhS user.

- c) Topology: point-to-point and multi-endpoint.

NOTE 2 – This encompasses various forms of LAN topology (ring/bus).

- d) Constant or variable bit rate.

NOTE 3 – In a multiplexed structure, the overall aggregated bit rate will generally be constant. However, the division of this rate between the PhCs may not be constant. Where there is a choice (implying that there are other users of the facilities of the Physical Layer) a variable rate will normally be selected for the OSI data user. Further clarification is given in Annex A.

9 Model of the Physical Service

9.1 Model of the layer service

This Recommendation | International Standard uses the abstract model for a layer service defined in the OSI Service Conventions (see ITU-T Rec. X.210 | ISO/IEC 10731, clause 5). The model defines the interactions between the PhS users and the PhS provider that take place at PhSAPs. Information is passed between the PhS user and the PhS provider by service primitives, which may convey parameters. The description of the model is applicable to point-to-point PhCs (linking two PhSAPs). The extension of the model for multi-endpoint PhCs is for further study.

9.2 Model of a point-to-point PhC

The operation of a PhC is modelled in the abstract by a pair of bit streams linking the two PhSAPs. There is one bit stream for each direction of transmission (see Figure 1). Each bit stream conveys Physical Protocol Data Units (PhPDUs). Bits within each bit stream are delivered in the same order in which they were submitted.

NOTE – In the variable bit rate class of service, the bit streams may operate intermittently.

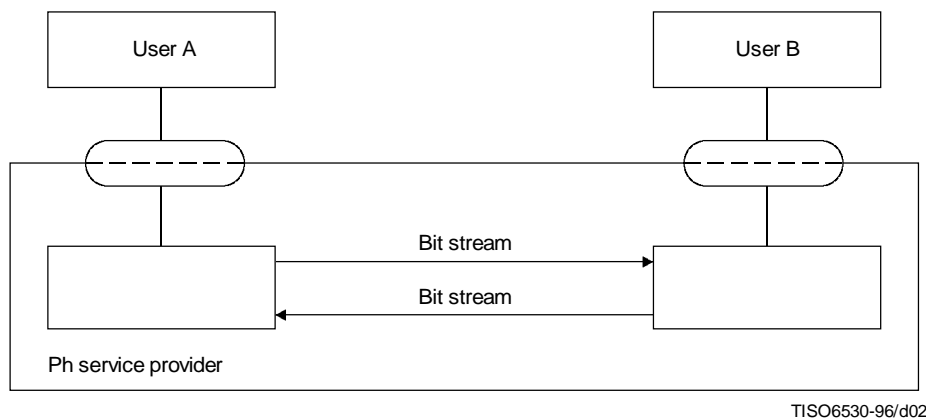

Figure 1 – Simple model of a PhC

9.3 Model of a relayed point-to-point PhC where the relay is controlled within the PhS Provider

The operation of the PhC is modelled exactly as described in 9.2 except for the interposition of the relay within the data circuit to support tandem physical media (see Figure 2).

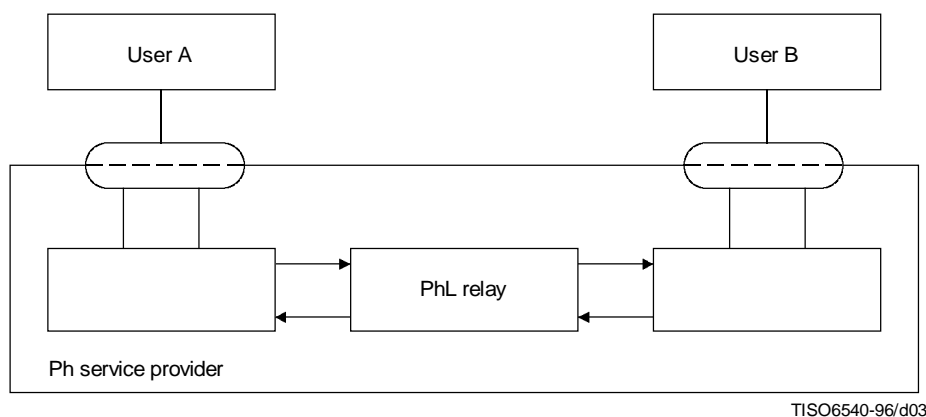

Figure 2 – Simple model of a PhC relayed within PhS Provider

9.4 Model of a relayed point-to-point PhC where the relay is controlled from the Network Layer

The operation of each of the relay-controlling PhCs can be accomplished by the Network Layer control information being conveyed either via the same PhC (in-band signalling), or via a separate PhC (out-of-band signalling), see Figure 3. Physical Layer relay systems do not complete the end-to-end PhC until Network Layer control actions are completed among the Network Layer entities en route. Deactivation may be accomplished through either Network Layer protocol or management actions.

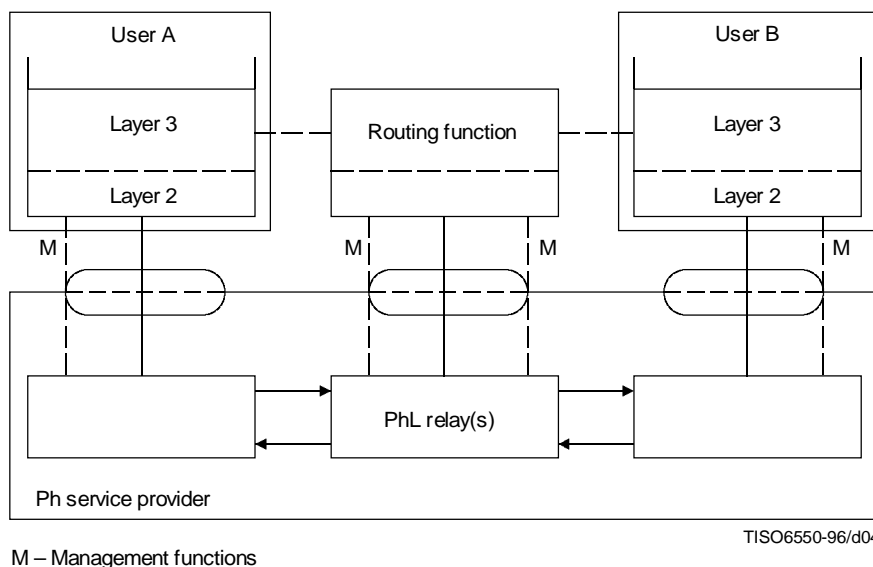

Figure 3 – Simplified model of a PhC relayed with control from the Network Layer

10 Quality of Physical Service

The term “Quality of Service” (QoS) refers to certain characteristics of a PhC as observed between the connection endpoints. QoS describes aspects of a PhC that are attributable solely to the PhS provider; it can only be properly determined in the absence of PhS user behaviour (which is beyond the control of the PhS provider) that specifically constrains or impairs the performance of the Physical Service.

The PhS users have knowledge of the relevant QoS of the PhC. This is true even in the case of a PhC spanning several physical circuits.

10.1 Definition of PhC QoS

The Quality of Service of a PhC depends on the physical media and on the physical protocol used to provide the Physical Service.

It may be characterized by:

- a) service availability;
- b) error rate;
- c) throughput;
- d) transit delay;
- e) protection.

These characteristics are defined in 10.1.1 to 10.1.5.

10.1.1 Service availability

This is for further study.

10.1.2 Error rate

Error rate is defined as the ratio of total altered, lost, created bit information to the total bit information transferred across the PhS boundary during a measurement period.

NOTE – The causes of bit information corruption are not listed exhaustively.

The relationship among these qualities is defined for a particular PhS user pair as specified in Figure 4.

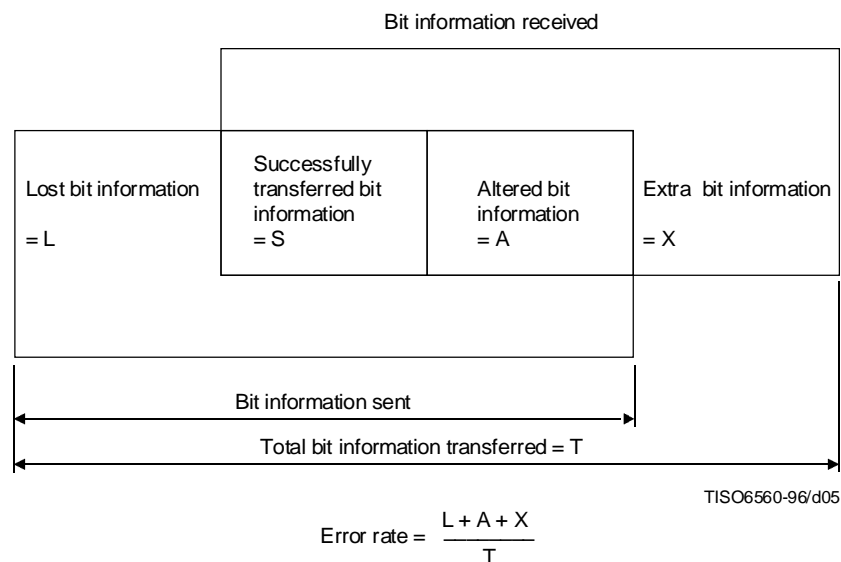

Figure 4 – Error rate

10.1.3 Throughput

Throughput is defined as the ratio of the total number of bits successfully transferred in a sequence of PhSDUs to the input/output time elapsed for that sequence of PhSDUs. The input/output time is the maximum value of the time for transmitting the sequence at the originating PhC endpoint and the time for receiving this sequence at the destination PhC endpoint. Throughput is only meaningful for a sequence of complete PhSDUs.

10.1.4 Transit delay

Transit delay is defined as the time elapsed between the submission of a PhSDU to the PhSAP and its reception at the destination PhSAP; this value concerns only physical data units which are transferred successfully.

10.1.5 Protection

This is for further study.

10.2 Determination of QOS values

QOS is described in terms of QOS parameters. These parameters are selected and determined by methods other than Physical Service primitives, although they may be determined in some cases through layer management primitives or by an *a priori* knowledge of the available configuration.

There is no guarantee that the originally agreed upon QOS values will be maintained throughout the lifetime of the PhC. The PhS user should be aware that a change in QOS is not explicitly signalled in the Physical Service, although in some cases it may be signalled through layer management functions.

11 Sequence of primitives

This clause defines the constraints on the sequences in which the primitives defined in clause 12 to clause 14 may occur. The constraints determine the order in which primitives occur, but do not fully specify when they may occur. Table 1 is a summary of the PhS primitives and their parameters, and defines the phases in which they occur (Activation, Data Transfer, and Deactivation).

Table 1 – Summary of Physical Service primitives and parameters

Phase	Service	Primitive	Parameters
PhC Activation (Note 1)	PhC Activation	Ph-ACTIVATE request	(Note 2)
		Ph-ACTIVATE indication	
Data Transfer	Data Transfer	Ph-DATA request	PhS – User Data
		Ph-DATA indication	
PhC Deactivation (Note 1)	PhC Deactivation	Ph-DEACTIVATE request	(Note 3)
		Ph-DEACTIVATE indication	
<p>NOTES</p> <p>1 The PhC Activation and PhC Deactivation services are optional and need not apply for duplex or simplex transmission.</p> <p>2 Parameters which differentiate the constituent elements of the particular state transition sequence (see Figures 6 to 14) according to the class of service (see clause 8) are not described as parameters of the PhC Activate service primitives in this Physical Service Definition.</p> <p>3 Parameters associated with PhC Deactivation are for further study.</p>			

11.1 Relation of primitives at the two PhC endpoints

A primitive issued at one PhC endpoint will, in general, have consequences at the other PhC endpoint. The relations of primitives of each type to primitives at the other PhC endpoint are defined in the appropriate subclause in clause 12 to clause 14; these relations are summarized in the diagrams in Figure 5. Additional sequences and relationships are for further study.

11.2 Sequence of primitives at one PhC endpoint

NOTE – A composite state diagram, comprising all the recognized sequences of primitives at PhC endpoints, is included in Annex C.

Specific primitive sequences that apply to individual modes of operation and topologies are shown in Figures 6 to 14 inclusive.

PhS User Activation – Duplex, Half-Duplex, Simplex

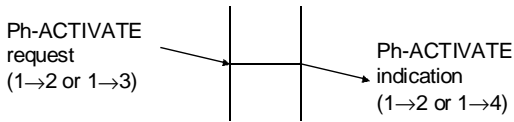

PhS User Deactivation – Duplex, Half-Duplex, Simplex:

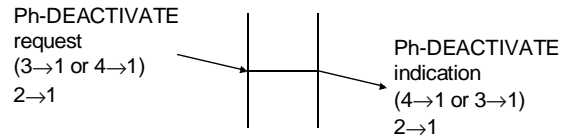

PhS User Activation, mode shift – Half-duplex receive to half-duplex send or to duplex:

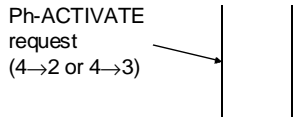

PhS User Deactivation, mode shift – Half-duplex send or duplex to half-duplex receive:

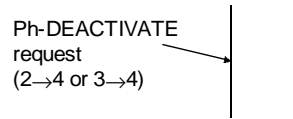

PhS Provider Deactivation – Duplex, Half-Duplex, Simplex:

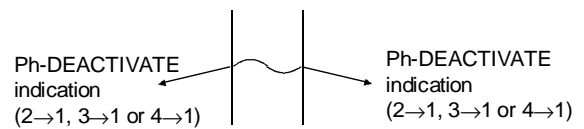

Simultaneous PhS User Activation – Duplex:

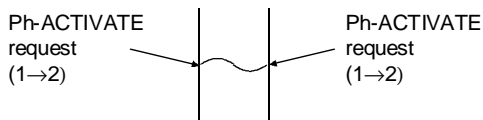

Simultaneous PhS User and PhS Provider Deactivation – Duplex, Half-duplex, Simplex:

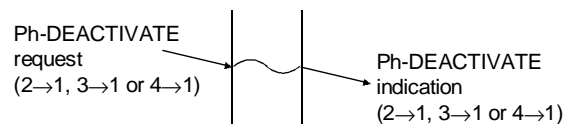

PhS User Activation Collision – Half-Duplex:

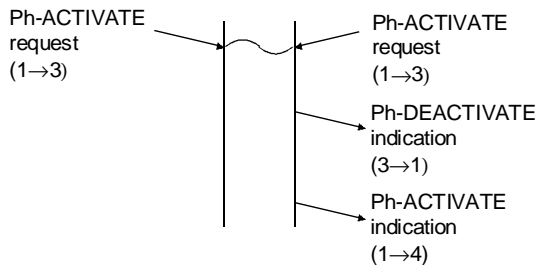

Simultaneous PhS User Deactivation – Duplex:

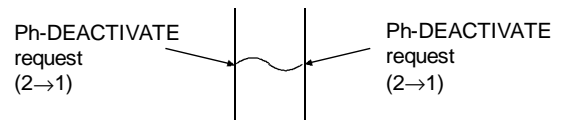

Data Transfer:

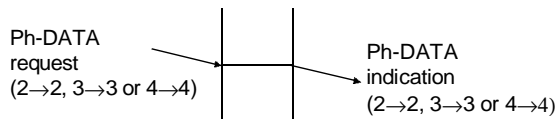

Simultaneous PhS User Deactivation – Half Duplex:

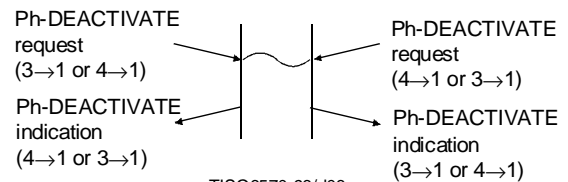

TISO6570-96/d06

Note – Figures in parentheses refer to the applicable transitions between the states indicated in Figure C.1 for the related PhC endpoint.

Figure 5 – Summary of Physical Service primitive time sequence diagrams

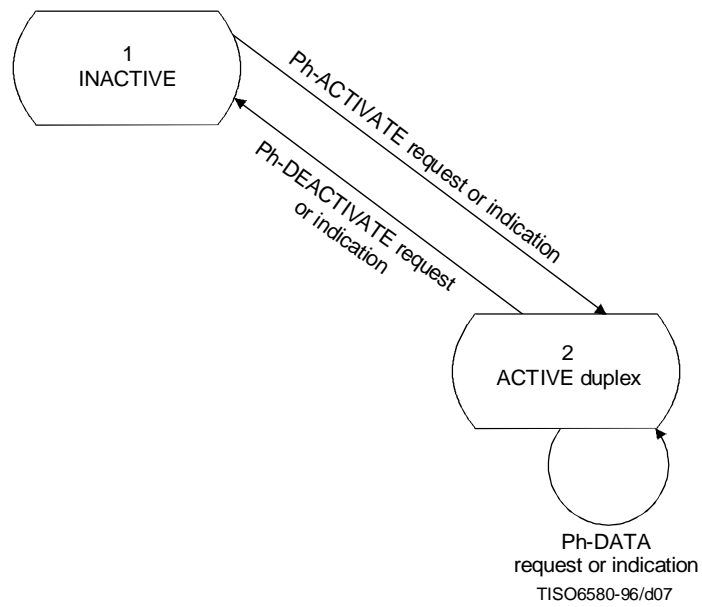

Figure 6 – State transition diagram for duplex mode with Activation/Deactivation

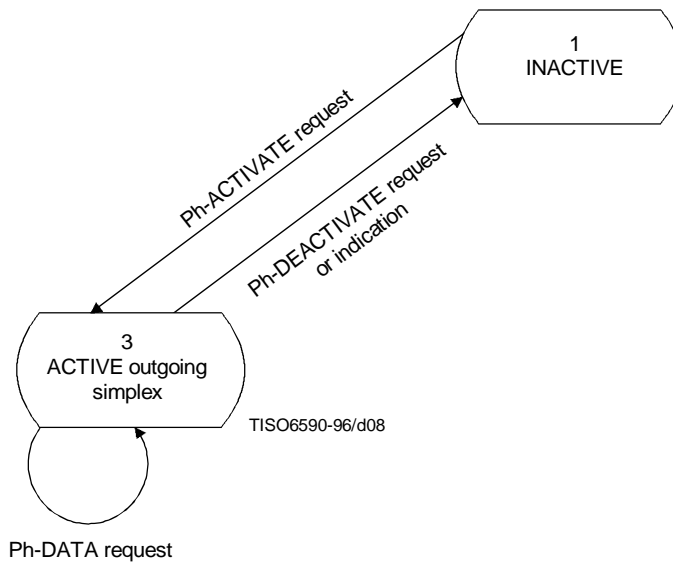

Figure 7 – State transition diagram for simplex mode, outgoing

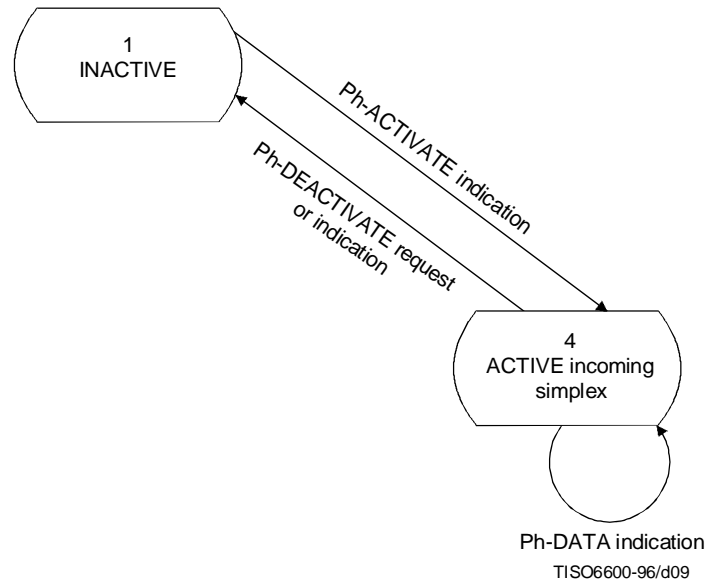

Figure 8 – State transition diagram for simplex mode, incoming

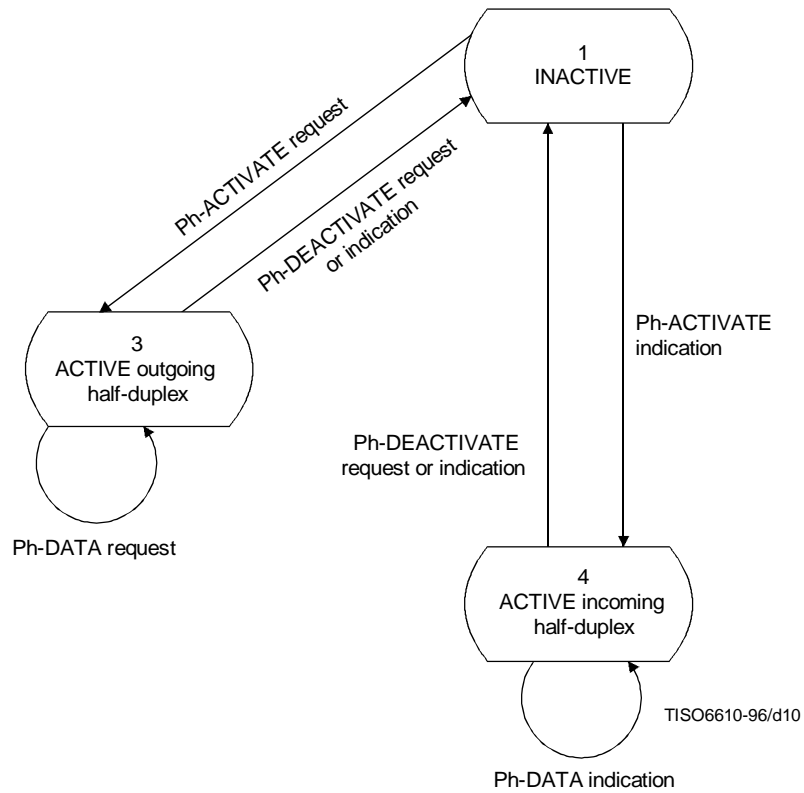

Figure 9 – State transition diagram for half-duplex mode

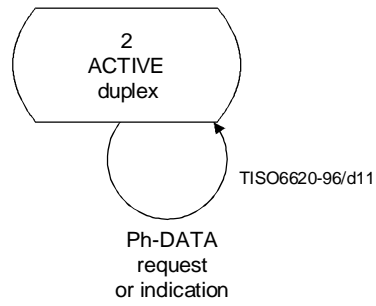

Figure 10 – State transition diagram for duplex mode, data transfer phase only

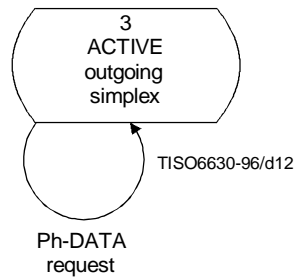

Figure 11 – State transition diagram for simplex mode, outgoing, data transfer phase only

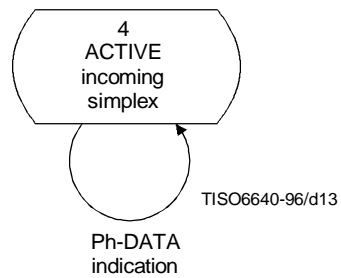

Figure 12 – State transition diagram for simplex mode, incoming, data transfer phase only

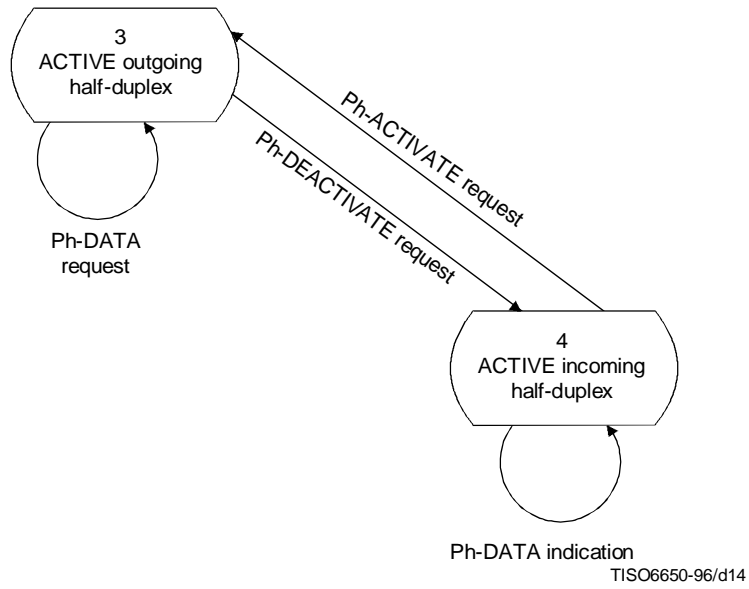

Figure 13 – State transition diagram for half-duplex mode without inactive state

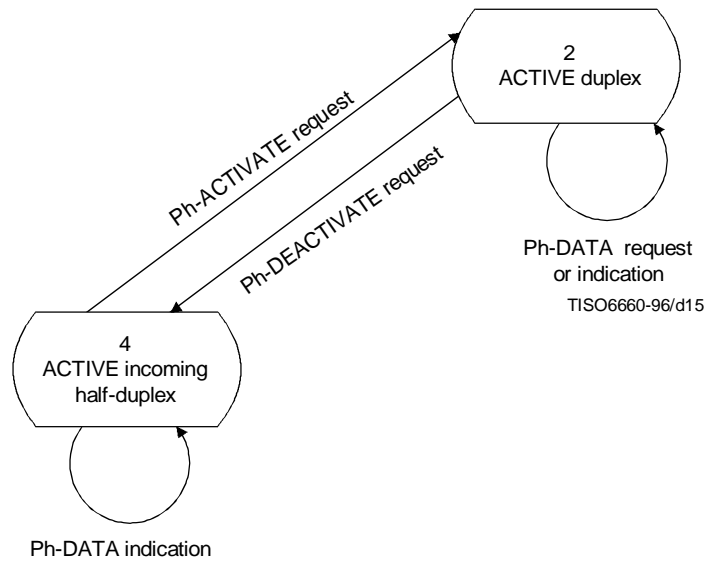

Figure 14 – State transition diagram for half-duplex/duplex mode shift

12 PhC activation phase

12.1 Function

The PhC activation service primitives are used for activating directions of transmission. They are required for half-duplex and are optional for duplex and simplex. The Ph-ACTIVATE request primitive requests activation of the PhC. Each direction of transmission is activated independently for half-duplex operation, and both directions of transmission are activated for duplex operation. For half-duplex and simplex operation, the Ph-ACTIVATE request primitive activates the outgoing direction of transmission, and the Ph-ACTIVATE indication primitive indicates activation of the incoming direction of transmission. During half-duplex operation, a Ph-ACTIVATE request cannot be issued by the PhS user after receipt of the Ph-ACTIVATE indication and before the receipt of a Ph-DEACTIVATE indication primitive.

12.2 Types of primitives and parameters

The PhC activation service involves two primitives as shown in Table 2. The parameters in the table are for further study.

Table 2 – Physical Service Activate primitives and parameters

Parameter	Primitive	
	Ph-ACTIVATE request	Ph-ACTIVATE indication
(Note)		
NOTE – See Note 2 to Table 1.		

12.3 Sequence of primitives

The sequence of primitives in a successful activation of a direction of transmission is defined by the time sequence diagram in Figure 15.

13 PhC deactivation phase

13.1 Function

The PhC deactivation service primitives are used for deactivating directions of transmission. They are required for half-duplex and are optional for duplex and simplex. The Ph-DEACTIVATE request primitive requests deactivation of the PhC. Each direction of transmission is deactivated independently for half-duplex operation, and both directions of transmission are deactivated for duplex operation. For half-duplex and simplex operation, the Ph-DEACTIVATE request primitive deactivates the outgoing direction of transmission, and the Ph-DEACTIVATE indication primitive indicates deactivation of the incoming direction of transmission. During half-duplex operation, a Ph-ACTIVATE request primitive can be issued by a PhS user after receipt of the Ph-DEACTIVATE indication primitive.

13.2 Types of primitives and parameters

The PhC deactivation service involves two primitives as shown in Table 3.

13.3 Sequence of primitives

The sequence of primitives for deactivation are expressed in the time sequence diagrams in Figure 16.

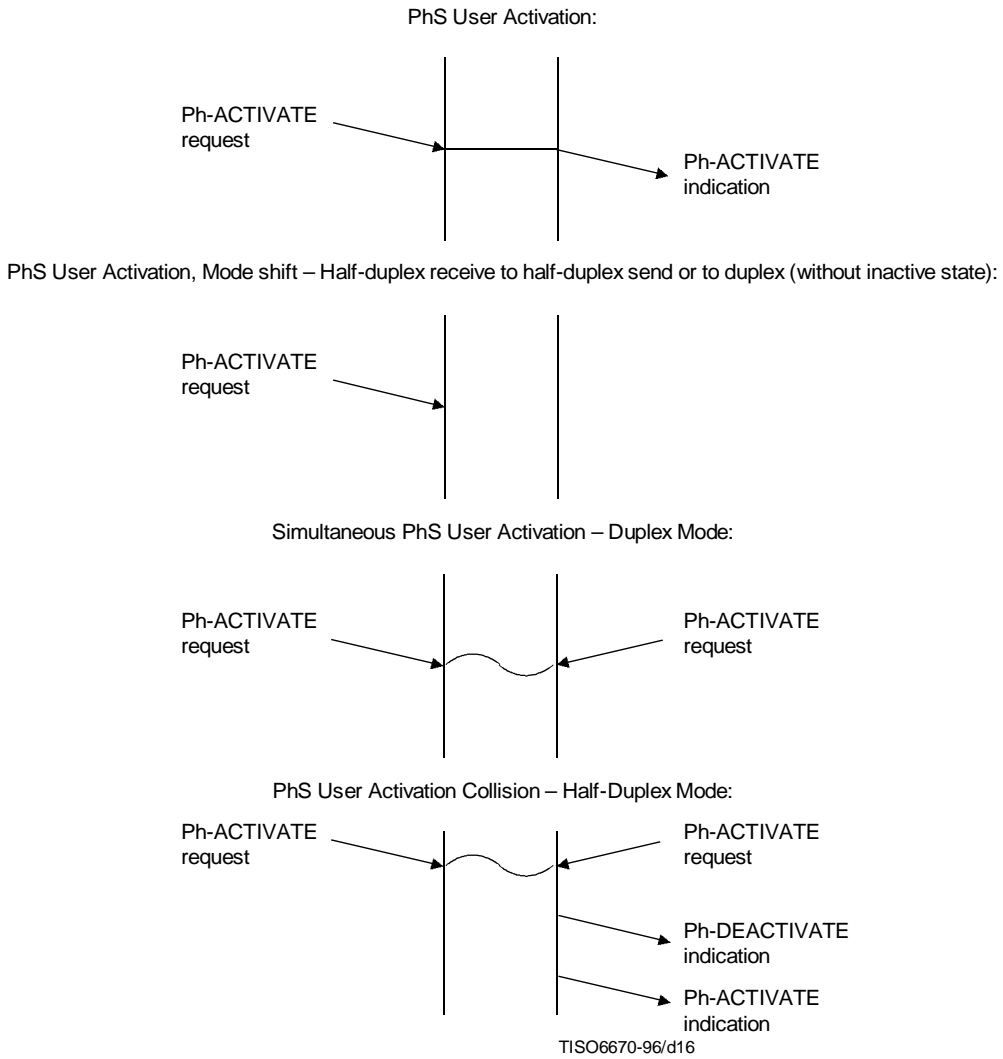

Note – There is no indication to the PhS user, who issued the Activate request, when the PhS provider is unable to activate the direction of transmission.

Figure 15 – Sequence of primitives for Activation

Table 3 – Physical Service Deactivate primitives and parameters

Parameter	Primitive	
	Ph-DEACTIVATE request	Ph-DEACTIVATE indication
(Note)		
NOTE – The need for deactivation parameters, e.g. Originator, is for further study. The Originator parameter indicates the source of the PhC deactivation. Its value indicates whether PhS user, PhS provider, or unknown caused the action.		

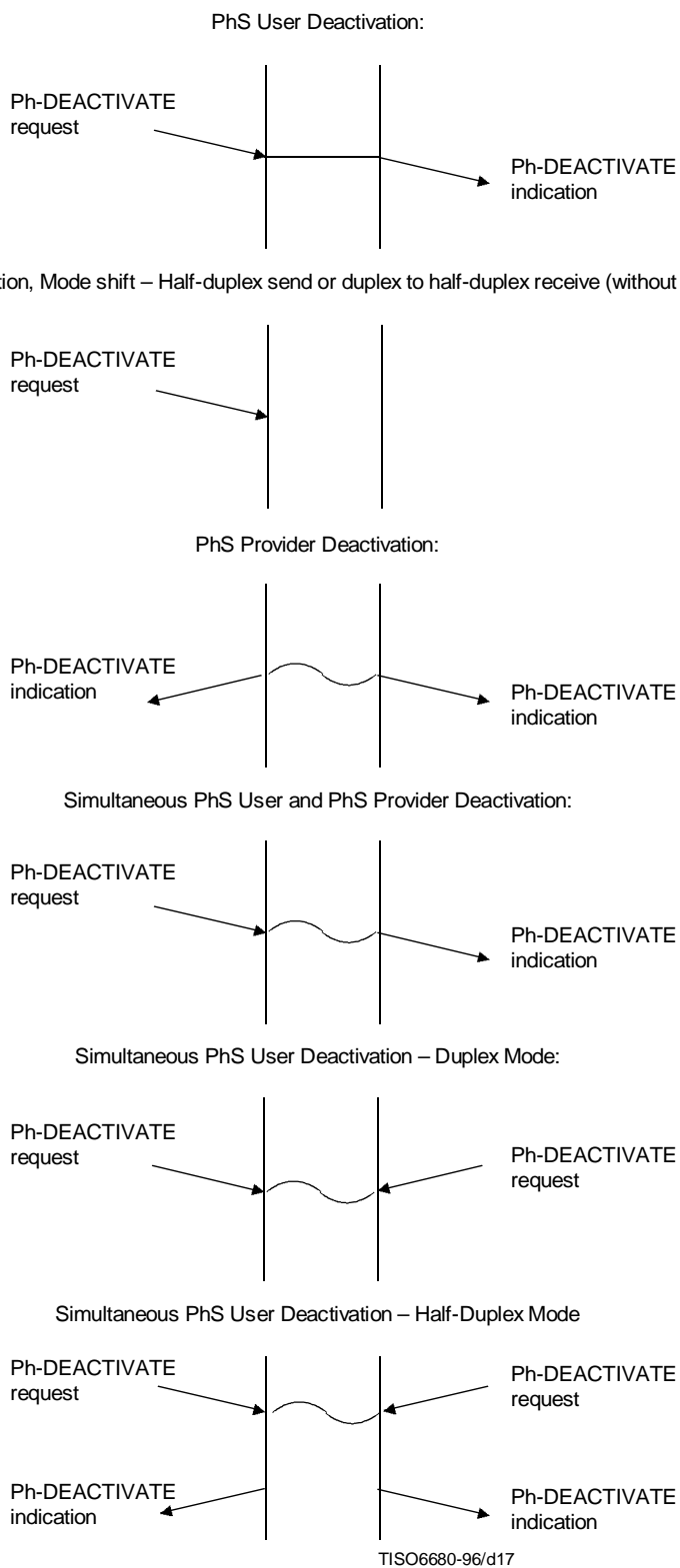

Note – The Ph-DEACTIVATE indication might not distinguish between invocation by the remote PhS user or invocation by the PhS provider (e.g. due to a failure)

Figure 16 – Sequence of primitives for Deactivation

14 Data transfer phase

14.1 Function

The data transfer service primitives provide for an exchange of user data called Physical Service Data Units (PhSDUs). The Physical Service preserves the sequence of the PhSDUs.

14.2 Types of primitives and parameters

Table 4 indicates the types of primitives and the parameters needed for Data Transfer.

The User Data parameter conveys PhSDUs for transmission between the PhS users. The size of the PhSDU is a PhS provider option. The PhS user has *a priori* knowledge of the PhSDU size value.

NOTE – To achieve the potential performance advantage when the variable bit rate class of service is applicable, the PhS user should ensure that the Service Data Unit (PhSDU) contains valid data (ideally: *only* valid data).

Table 4 – Data Transfer primitives and parameters

Parameter	Primitive	
	Ph-DATA request	Ph-DATA indication
User Data	X	X(=)

14.3 Sequence of primitives

The operation of the Physical Service in transferring PhSDUs can be modelled as a pair of bit streams within the PhS provider (see clause 9).

The Physical Layer serves to pass a transparent bit stream (PhSDUs) continuously or intermittently. This requires that the Ph-DATA primitives are present, as necessary, throughout the Data Transfer Phase. Immediately upon receipt of a Ph-ACTIVATE indication primitive, an incoming user data bit stream (PhSDUs) is available to the PhS user. Upon issuance of a Ph-ACTIVATE request primitive, an outgoing user data bit stream (PhSDUs) is assumed to be available to the PhS user.

The sequence of primitives in a successful data transfer is defined in the time sequence diagram in Figure 17.

The sequence of primitives in Figure 17 may remain uncompleted if a Ph-DEACTIVATE primitive occurs.

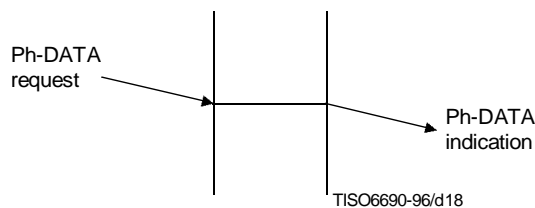

Figure 17 – Sequence of primitives in data transfer

Annex A

Internal structure of the Physical Layer

(This annex does not form an integral part of this Recommendation | International Standard)

A.1 Introduction

The Physical Layer can be realized in a number of different ways. The main differences between the possible methods of implementation can be classified according to whether multiplexing is included, and if so the form that it takes (statistical or time division). From this premise, it is possible to divide the functionality required of the layer in such a manner that the structure represented by each of the three multiplexing classifications can be derived from a single, common sub-structure for the layer.

An added complication is that practical implementations of the Physical Layer commonly provide services other than those defined by this Physical Service definition. Such services can be classified as being those for which timing integrity is paramount (for example, conversational speech and video services). Clearly, it is desirable that the relationship between the functions required to support such services and those required to support this Physical Service definition is made apparent to implementors. This annex shows that relationship. In so doing, the notion of convergence sublayers within or above the Physical Layer is introduced. This notion permits convergence to specific real-time service interface requirements from a common Physical Layer implementation, as well as convergence to different media requirements.

A.2 Classifications regarding multiplexing

A.2.1 Non-multiplexed

The simplest form for the Physical Layer is one in which there is no multiplexing. Bit, character or other sub-structure synchronization may be provided but all such entities are aggregated to form, for the duration of an activation, what is in essence a continuous bit stream (as seen by the next higher layer).

A.2.2 Time division multiplexed

In this form, a frame structure is defined within which individual channels (or time slots) are assigned. Synchronization is applied to the frame as a whole. Individual time-slots do not carry labels. They are not necessarily all of the same size, though the size will be pre-defined.

A.2.3 Statistically multiplexed

A recent innovation is the use of a fixed length sub-structure, or “cell” within an overall frame structure. Each cell has a header in which a routing label is carried, thus identifying individual channels. The rate of cell allocation (to a channel) is not necessarily constant, i.e. the proportion of the overall aggregated bit rate allocated to a channel can be changed dynamically according to demand. This technique is known as Asynchronous Transfer Mode (ATM).

A.3 Isochronous transmission

A characteristic of all three of the above arrangements is that isochronous transmission can be supported. The application is therefore not restricted to OSI and may cover those for which timing integrity is an essential requirement.

In the first two multiplexing arrangements, there is no significant difference in the service definition for the two kinds of application. However, in the third arrangement, specific constraints on cell allocation are imposed to ensure integrity in transmission. As a result, different classes of service have been identified only one of which is directly relevant to the OSI definition. These classes are listed in Table A.1.

Table A.1 – Classes of Service in ATM

Class	Timing Integrity	Bit Rate
A	Required	Constant
B	Required	Variable
C	Not required	Variable

NOTE – In ATM, distinction between connection oriented and connectionless is also included. This is not relevant to the definition of Physical Service.

A.3.1 PhC endpoint identification

For all three classifications, identification of a PhC is always pre-defined, either at the time of installation or by a management mechanism requiring the use of protocol at a higher layer. This aspect is clarified in clause 9 of this service definition.

NOTE – In ATM, priority is given to the signalling channels which may be used to convey the higher layer protocol that defines the routing labels for all the other channels. There is always one such channel (the meta signalling channel) pre-defined at installation.

A.3.2 Convergence sublayers

If the characteristics of the service interface defined by the multiplexing characteristics of the Physical Layer do not exactly match the characteristics required by the Data Link Layer, a convergence mechanism is required. For example, segmentation of the frames generated at the Data Link Layer into cells is needed with cell-based transmission. Convergence mechanisms will also be required for time-sensitive services (for example, to map PCM-coded speech samples into cells).

NOTE – The multiplex layer may support the transfer of a PhSDU consisting of an integral number of cells (formed, if necessary, by including padding, suitably delineated, within the PhSDU).

This principle is also applicable to half-duplex operation within the Physical Layer. An example convergence protocol for this instance is given in Annex B.

A.3.3 Structure of the Physical Layer

See Figure A.1. The term *physical layer* refers to the whole of the layer. The base component of the layer (which is always present) is here called *base physical sublayer* but in some implementations it is called the *physical layer*. The use of the term *physical layer* with two different meanings should be especially noted.

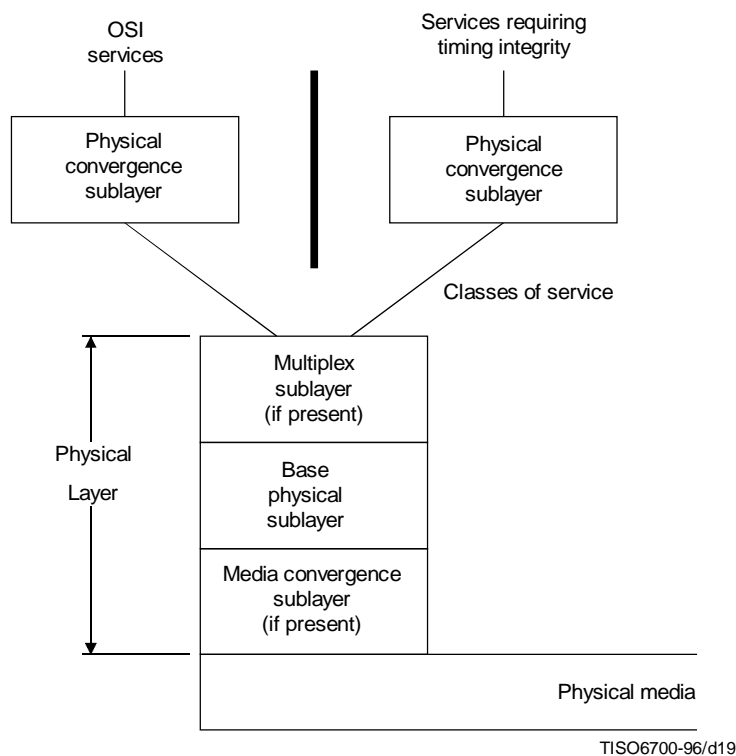

Figure A.1 – Structure of the Physical Layer

Annex B

Operation of data link protocol using the half-duplex physical service

(This annex does not form an integral part of this Recommendation | International Standard)

B.1 Introduction

This annex defines a method for operating a data link protocol using the half-duplex physical service.

B.2 Operation

Figure B.1 illustrates the structure of the relevant layers and sublayers for the cases of:

- a) operation with the duplex physical service;
- b) operation with the half-duplex physical service.

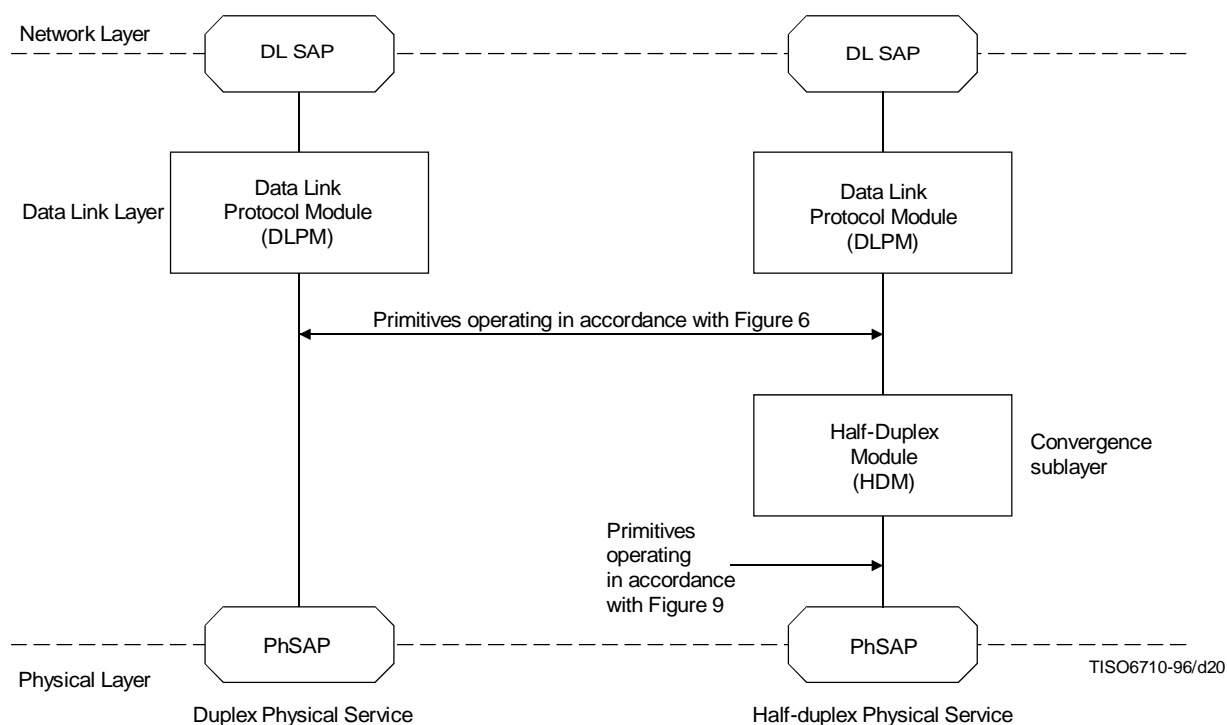

Figure B.1 – Structure of the data link layer

A Half-Duplex Module (HDM) is necessary in the convergence sublayer in order to alter the transmission direction when using the half-duplex physical service. The Data Link Protocol Module (DLPM) may operate any protocol such as LAPB.

The primitives exchanged between the PhSAP and the HDM are:

- Ph-ACTIVATE request;
- Ph-ACTIVATE indication;
- Ph-DEACTIVATE request;
- Ph-DEACTIVATE indication;
- Ph-DATA request;
- Ph-DATA indication.

These primitives operate in accordance with Figure 9 (half-duplex mode).

For the purpose of this annex, the DLPM is assumed to operate with the HDM in the exact same manner as it would operate with the duplex physical service, i.e. in accordance with Figure 6. For clarity in the following description, the six primitives exchanged between the DLPM and the HDM are designated as follows:

- Hdm-ACTIVATE request;
- Hdm-ACTIVATE indication;
- Hdm-DEACTIVATE request;
- Hdm-DEACTIVATE indication;
- Hdm-DATA request;
- Hdm-DATA indication.

The state diagram for the HDM is shown in Figure B.2. The four states are:

- *Idle state (0)*: The HDM waits for activation by either the PhSAP or the DLPM.
- *Outgoing transmission state (1)*: The HDM conveys service data units from the DLPM to the PhSAP (using the Hdm-DATA request and the Ph-DATA request primitives).
- *Wait to receive state (2)*: The HDM waits for authorization to receive from the PhSAP.
- *Incoming reception state (3)*: The HDM conveys service data units from the PhSAP to the DLPM (using the Ph-DATA indication and Hdm-DATA indication primitives).

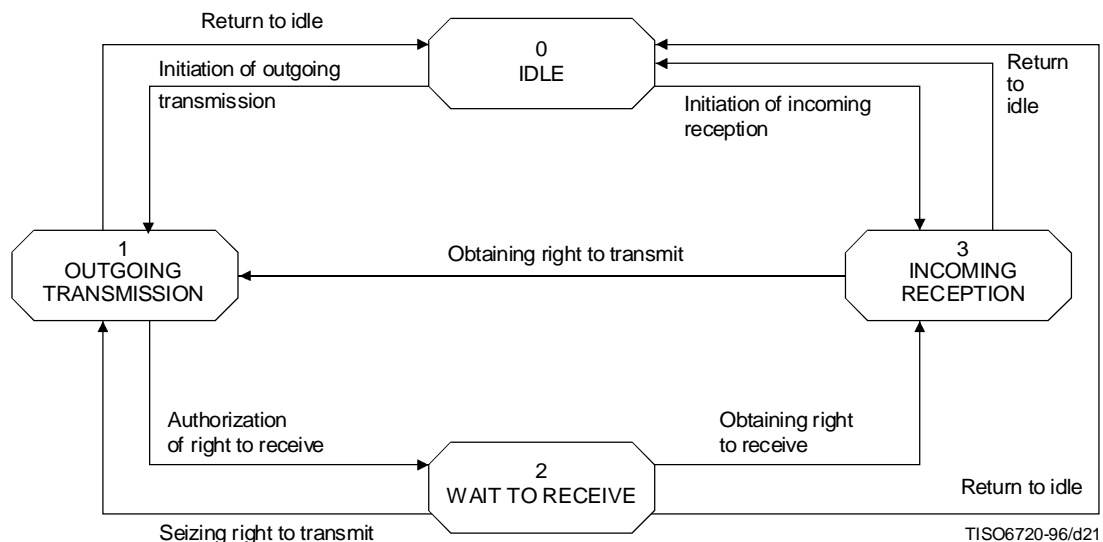

Figure B.2 – State diagram for HDM

Table B.1 describes the state transitions in more detail. It identifies the events that cause a state transition and the action taken as a result of the state transition.

Table B.1 – Description of HDM state transitions

Current state	New state	Name of transition	Event causing the transition	HDM action taken as a result of the transition
0	1	Initiation of outgoing transition	Hdm-ACTIVATE request primitive (DLPM to HDM)	Issue Ph-ACTIVATE request primitive (HDM to PhSAP)
0	3	Initiation of incoming reception	Ph-ACTIVATE indication primitive (PhSAP to HDM)	Issue Hdm-ACTIVATE indication primitive (HDM to DLPM)
1	0	Return to idle	Ph-DEACTIVATE indication primitive (PhSAP to HDM)	Issue Hdm-DEACTIVATE indication primitive (HDM to DLPM)
1	0	Return to idle	Hdm-DEACTIVATE request primitive (DLPM to HDM)	Issue Ph-DEACTIVATE request primitive (HDM to PhSAP)
1	2	Authorization of right to receive	Detection of need of altering transmission direction from sending to receiving (Note 1)	Issue Ph-DEACTIVATE request primitive (HDM to PhSAP) and start HDM Timer T (Note 2)
2	0	Return to idle	Hdm-DEACTIVATE request primitive (DLPM to HDM)	Stop HDM Timer T (Note 2)
2	1	Seizing right to transmit	Expiration of HDM Timer T (Note 2)	Issue Ph-ACTIVATE request primitive (HDM to PhSAP)
2	3	Obtaining right to receive	Ph-ACTIVATE indication primitive (PhSAP to HDM)	Stop HDM Timer T (Note 2)
3	0	Return to idle	Hdm-DEACTIVATE request primitive (DLPM to HDM)	Issue Ph-DEACTIVATE request primitive (HDM to PhSAP)
3	1	Obtaining right to transmit	Ph-DEACTIVATE indication primitive (PhSAP to HDM)	Issue Ph-ACTIVATE request primitive (HDM to PhSAP)

NOTES

- 1 For HDLC-based data link protocols such as LAPB, the detection of more than two successive flags in the user data parameter of an Hdm-DATA request primitive or a series of such primitives may be used by the HDM as an indication that outgoing transmission is no longer needed and, consequently, the need to alter the direction of transmission.
- 2 Expiration of Timer T is used to seize the right for outgoing transmission in order to maintain communications when permission for incoming data reception is not granted by the physical service. The value of Timer T is a system parameter which depends upon the specific characteristics of the physical service. To avoid a contention condition during this recovery process, different values of Timer T are to be used at the two ends of the data link.

Table B.2 describes the operation of the HDM in terms of events that can occur in each state.

Table B.2 – State transitions of HDM in response to stimuli

Stimuli	State assumed as a result of stimuli after action in Table B.1 is taken					
	Ph-ACTIVATE indication	Ph-DEACTIVATE indication	Hdm-ACTIVATE request	Hdm-DEACTIVATE request	Hdm-DATA request with successive flags	Expiration of Timer T
Initial state						
0	3	0	1	0	N/A	N/A
1	N/A	0	N/A	0	2	N/A
2	3	N/A	N/A	0	N/A	1
3	N/A	1	N/A	0	N/A	N/A

Annex C

Composite state transition diagram

(This annex does not form an integral part of this Recommendation | International Standard)

C.1 Introduction

For explanatory purposes only, a composite state transition diagram (see Figure C.1), comprising all the state transition diagrams defined in Figures 6 to 14, is provided to enable easy recognition of all possible states.

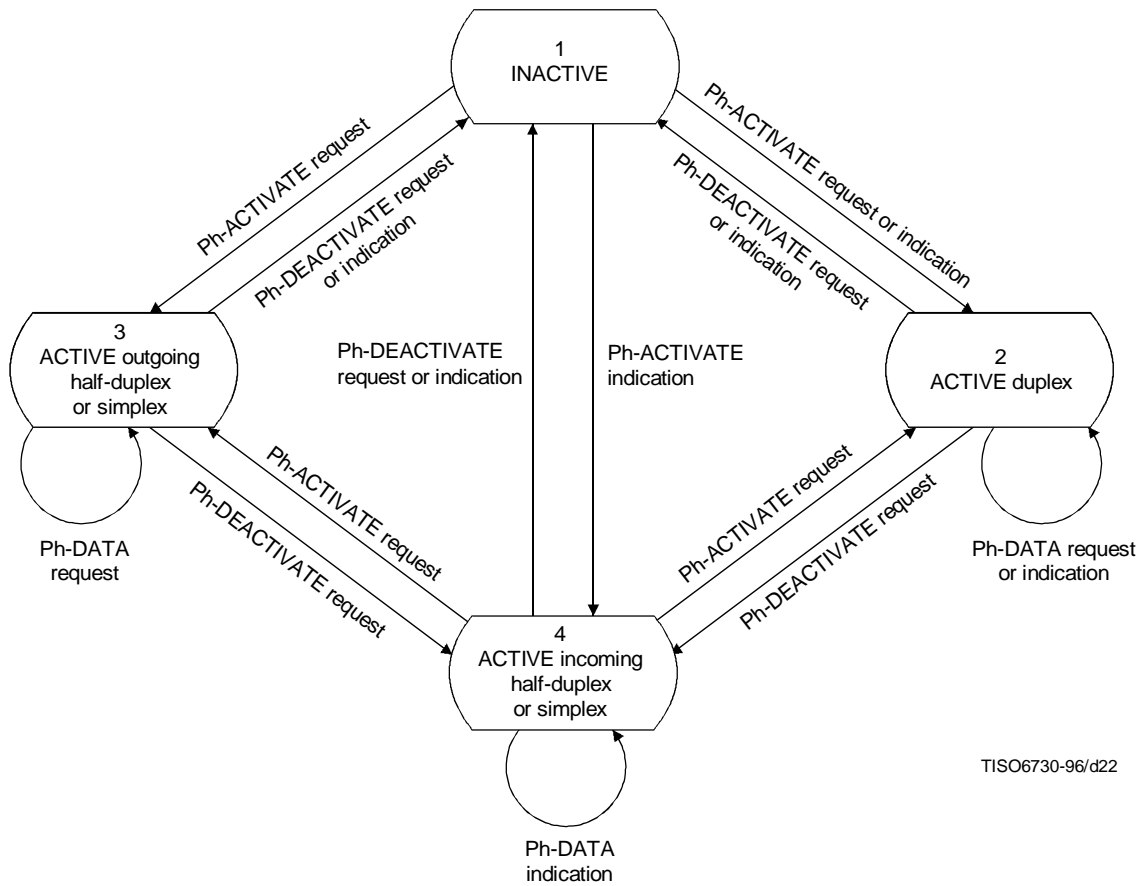

Figure C.1 – Composite state transition diagram for sequences of primitives at a PhC endpoint