



INTERNATIONAL TELECOMMUNICATION UNION

ITU-T

TELECOMMUNICATION
STANDARDIZATION SECTOR
OF ITU

X.124

(06/99)

SERIES X: DATA NETWORKS AND OPEN SYSTEM
COMMUNICATIONS

Public data networks – Network aspects

**Arrangements for the interworking of the E.164
and X.121 numbering plans for frame relay and
ATM networks**

ITU-T Recommendation X.124

(Previously CCITT Recommendation)

ITU-T X-SERIES RECOMMENDATIONS
DATA NETWORKS AND OPEN SYSTEM COMMUNICATIONS

PUBLIC DATA NETWORKS	
Services and facilities	X.1–X.19
Interfaces	X.20–X.49
Transmission, signalling and switching	X.50–X.89
Network aspects	X.90–X.149
Maintenance	X.150–X.179
Administrative arrangements	X.180–X.199
OPEN SYSTEMS INTERCONNECTION	
Model and notation	X.200–X.209
Service definitions	X.210–X.219
Connection-mode protocol specifications	X.220–X.229
Connectionless-mode protocol specifications	X.230–X.239
PICS proformas	X.240–X.259
Protocol Identification	X.260–X.269
Security Protocols	X.270–X.279
Layer Managed Objects	X.280–X.289
Conformance testing	X.290–X.299
INTERWORKING BETWEEN NETWORKS	
General	X.300–X.349
Satellite data transmission systems	X.350–X.399
MESSAGE HANDLING SYSTEMS	X.400–X.499
DIRECTORY	X.500–X.599
OSI NETWORKING AND SYSTEM ASPECTS	
Networking	X.600–X.629
Efficiency	X.630–X.639
Quality of service	X.640–X.649
Naming, Addressing and Registration	X.650–X.679
Abstract Syntax Notation One (ASN.1)	X.680–X.699
OSI MANAGEMENT	
Systems Management framework and architecture	X.700–X.709
Management Communication Service and Protocol	X.710–X.719
Structure of Management Information	X.720–X.729
Management functions and ODMA functions	X.730–X.799
SECURITY	X.800–X.849
OSI APPLICATIONS	
Commitment, Concurrency and Recovery	X.850–X.859
Transaction processing	X.860–X.879
Remote operations	X.880–X.899
OPEN DISTRIBUTED PROCESSING	X.900–X.999

For further details, please refer to ITU-T List of Recommendations.

ITU-T RECOMMENDATION X.124

ARRANGEMENTS FOR THE INTERWORKING OF THE E.164 AND X.121 NUMBERING PLANS FOR FRAME RELAY AND ATM NETWORKS

Summary

This Recommendation defines the procedures applicable for the purpose of numbering plan interworking between ATM Networks which use the E.164 numbering plan and Public Frame Relay Data Networks which may use either the X.121 numbering plan or the E.164 numbering plan. The principles for interworking between the E.164 and X.121 numbering plans covered in this Recommendation are illustrated by various examples. The scenario (for FR/ATM service interworking) where the ATM terminal is identified by an AESA (NSAP) is also illustrated.

Source

ITU-T Recommendation X.124 was prepared by ITU-T Study Group 7 (1997-2000) and was approved under the WTSC Resolution No. 1 procedure on the 18th of June 1999.

FOREWORD

ITU (International Telecommunication Union) is the United Nations Specialized Agency in the field of telecommunications. The ITU Telecommunication Standardization Sector (ITU-T) is a permanent organ of the ITU. The ITU-T is responsible for studying technical, operating and tariff questions and issuing Recommendations on them with a view to standardizing telecommunications on a worldwide basis.

The World Telecommunication Standardization Conference (WTSC), which meets every four years, establishes the topics for study by the ITU-T Study Groups which, in their turn, produce Recommendations on these topics.

The approval of Recommendations by the Members of the ITU-T is covered by the procedure laid down in WTSC Resolution No. 1.

In some areas of information technology which fall within ITU-T's purview, the necessary standards are prepared on a collaborative basis with ISO and IEC.

NOTE

In this Recommendation the term *recognized operating agency (ROA)* includes any individual, company, corporation or governmental organization that operates a public correspondence service. The terms *Administration*, *ROA* and *public correspondence* are defined in the *Constitution of the ITU (Geneva, 1992)*.

INTELLECTUAL PROPERTY RIGHTS

The ITU draws attention to the possibility that the practice or implementation of this Recommendation may involve the use of a claimed Intellectual Property Right. The ITU takes no position concerning the evidence, validity or applicability of claimed Intellectual Property Rights, whether asserted by ITU members or others outside of the Recommendation development process.

As of the date of approval of this Recommendation, the ITU had not received notice of intellectual property, protected by patents, which may be required to implement this Recommendation. However, implementors are cautioned that this may not represent the latest information and are therefore strongly urged to consult the TSB patent database.

ITU 1999

All rights reserved. No part of this publication may be reproduced or utilized in any form or by any means, electronic or mechanical, including photocopying and microfilm, without permission in writing from the ITU.

CONTENTS

	<i>Page</i>
1 Introduction	1
2 Scope	1
3 References.....	2
4 Definitions	2
5 Abbreviations.....	2
6 Interworking.....	3
6.1 Numbering plans	3
6.2 Methods.....	4
6.3 Terminal dialling procedures.....	5
7 Interworking diagrams	5
7.1 Conventions used in the interworking diagrams.....	5
7.2 Index of interworking diagrams.....	6
7.3 Interworking diagrams.....	7

ARRANGEMENTS FOR THE INTERWORKING OF THE E.164 AND X.121 NUMBERING PLANS FOR FRAME RELAY AND ATM NETWORKS

(Geneva, 1999)

1 Introduction

Public B-ISDN (ATM) networks utilize the E.164 numbering plan, whilst Public Frame Relay Data Networks (PFRDNs) may be numbered under either the X.121 numbering plan or the E.164 numbering plan. A call from a B-ISDN (E.164) to a PFRDN (X.121), a PFRDN (X.121) to a PFRDN (E.164) and calls routed through networks using a different numbering plan to that of the originating or destination network are examples of the need for numbering plan interworking. Numbering plan interworking is a fundamental requirement for the successful completion of calls between data networks utilizing different numbering plans.

This Recommendation defines the general procedures applicable to numbering plan interworking between:

- Public Frame Relay Data Networks which utilize differing numbering plans;
- Public Frame Relay Data Networks and B-ISDNs (Public ATM Networks).

The numbering and addressing principles for B-ISDNs are described in Recommendation E.191. The numbering principles for public data networks are defined in Recommendation X.121.

NOTE – Within this Recommendation the term Public Frame Relay Data Network can be used interchangeably with the term Public Data Network providing the Frame Relay Data Transmission Service. The term ATM Network can be used interchangeably with the term B-ISDN.

2 Scope

2.1 The scope of this Recommendation is to define the procedures applicable for the purpose of numbering plan interworking between B-ISDN (Public ATM Networks) and Public Frame Relay Data Networks utilizing the E.164 numbering plan and those Public Frame Relay Data Networks which use the X.121 numbering plan.

2.2 The principles for interworking between the E.164 and X.121 numbering plans covered in this Recommendation are illustrated by various examples which involve only Frame Relay calls. The scenario (for FR/ATM service interworking) where the ATM terminal is identified by an AESA (NSAP) is also illustrated. The numbering plan interworking principles utilize the Numbering Plan Identifier (NPI) method.

2.3 Interworking involving two or more Frame Relay or ATM Networks is included in the scope of this Recommendation.

2.4 This Recommendation applies to numbering plan interworking across network boundaries. Its applicability to calls within a single country is a national matter.

3 References

The following ITU-T Recommendations and other references contain provisions which, through reference in this text, constitute provisions of this Recommendation. At the time of publication, the editions indicated were valid. All Recommendations and other references are subject to revision; all users of this Recommendation are therefore encouraged to investigate of applying the most recent edition of the Recommendations and other references listed below. A list of the currently valid ITU-T Recommendations is regularly published.

- ITU-T Recommendation E.164 (1997), *The international public telecommunications numbering plan.*
- ITU-T Recommendation E.191 (1996), *B-ISDN numbering and addressing.*
- ITU-T Recommendation I.555 (1997), *Frame Relaying Bearer Service interworking.*
- ITU-T Recommendation X.36 (1995), *Interface between Data Terminal Equipment (DTE) and Data Circuit-terminating Equipment (DCE) for public data networks providing frame relay data transmission service by dedicated circuit.*
- ITU-T Recommendation X.36/Amd.1 (1996), *Switched Virtual Circuit (SVC) signalling and refinements of Permanent Virtual Circuit (PVC) signalling.*
- ITU-T Recommendation X.36/Amd.2 (1997), *Frame transfer priority.*
- ITU-T Recommendation X.36/Amd.3 (1998), *Frame discard priority, service classes, NSAP signalling and protocol encapsulation*
- ITU-T Recommendation X.46 (1998), *Access to FRDTS via B-ISDN.*
- ITU-T Recommendation X.76 (1995), *Network-to-network interface between public data networks providing the frame relay data transmission service.*
- ITU-T Recommendation X.76/Amd.1 (1997), *Switched virtual circuits.*
- ITU-T Recommendation X.76/Amd.2 (1998), *Frame relay service classes and priorities.*
- ITU-T Recommendation X.121 (1996), *International numbering plan for public data networks.*
- ITU-T Recommendation X.122 (1998), *Numbering plan interworking for the E.164 and X.121 numbering plans.*
- ITU-T Recommendation X.123 (1996), *Mapping between escape codes and TOA/NPI for E.164/X.121 numbering plan interworking during the transition period.*
- ITU-T Recommendation X.300 (1996), *General principles for interworking between public networks and between public networks, and other networks for the provision of data transmission services.*
- ITU-T Recommendation X.301 (1996), *Description of the general arrangements for call control within a subnetwork and between subnetworks for the provision of data transmission services.*

4 Definitions

A list of terms and their definitions relating to numbering are contained in Recommendations E.164 and X.121.

5 Abbreviations

This Recommendation uses the following abbreviations:

AESA	ATM End System Address
ALT-ADD	Alternative Address
ATM	Asynchronous Transfer Mode
AU	Access Unit
B-ISDN	Broadband Integrated Services Digital Network
CSM	Call Set-up Message

DCE	Data Circuit-terminating Equipment
DNIC	Data Network Identification Code
DTE	Data Terminal Equipment
FMBS	Frame Mode Bearer Service
FR	Frame Relay
FRDTS	Frame Relay Data Transmission Service
ND	Number Digits
NPI	Numbering Plan Identification
NSAP	Network Service Access Point (address)
PDN	Public Data Network
PFRDN	Public Frame Relay Data Network
STE	Signalling Terminal Equipment
TON	Type of Number

6 Interworking

The sample call flows shown in the figures are from terminal to terminal. The application of this Recommendation includes the following numbering plan interworking scenarios:

- calls from/to a frame relay terminal on a PFRDN numbered under X.121, to/from a PFRDN numbered under E.164;
- calls from/to an ATM terminal with frame relay capabilities on an ATM Network numbered under E.164, to/from a frame relay terminal on a PFRDN numbered under X.121;
- calls from/to a frame relay terminal on a PFRDN numbered under X.121, utilizing an ATM Network as a transit network for calls to/from a frame relay terminal on a PFRDN numbered under X.121;
- calls from/to a frame relay terminal on a PFRDN numbered under X.121, utilizing an ATM Network as a transit network for calls to/from a frame relay terminal on a PFRDN numbered under E.164;
- calls from/to a frame relay terminal on a PFRDN numbered under X.121, to/from an ATM terminal on an ATM Network numbered under E.164 (service interworking);
- calls from/to a frame relay terminal on a PFRDN numbered under X.121, to/from an ATM terminal on an ATM Network identified by an AESA (ISO NSAP) (service interworking).

NOTE – The interworking scenario for calls from/to a frame relay terminal on an ATM Network numbered under E.164, utilizing a PFRDN numbered under X.121 as a transit network for calls to/from a frame relay terminal on an ATM Network numbered under E.164 is for further study.

6.1 Numbering plans

The two numbering plans included in the arrangements shown in this Recommendation are the E.164 and the X.121 numbering plans.

6.1.1 Escape codes

For the purpose of number plan interworking for the provision of Frame Relay Data Services, escape codes are not used.

6.1.2 Prefixes

Definitions of prefixes are contained in Recommendations E.164 and X.121. Since for the purposes of interworking the full international number format is used, the use of prefixes is not required within the scope of this Recommendation.

6.2 Methods

In the diagrams that are included in this Recommendation, there are two main situations when numbering plan interworking occurs. One situation is when a terminal is placing a call and must indicate to the originating switch that numbering plan interworking is involved. The other is when one switching system is passing a call over a trunk to another switching system and must indicate to the receiving switching system that interworking is involved.

Different methods of accomplishing numbering plan interworking are portrayed in the diagrams in this Recommendation.

6.2.1 Dial-in method

The dial-in method of numbering plan interworking occurs when a terminal on one network places a call that terminates on an Access Unit (AU) of another network that uses the numbering plan of the called terminal. When the call from the originating terminal reaches the access unit, it appears to the second network simply as a call origination. Thus, the calling terminal establishes the call by using a two-step process. In the first step, the calling terminal enters the called party number in the originating network's numbering plan. The call proceeds to a termination point on the first network which is also an origination point on the second network. The calling terminal receives the equivalent of dial tone from the second network and then enters the called party number using the numbering plan of the called terminal. Except for access unit functions, neither network needs to have a switching system that deals with numbering plan interworking.

6.2.2 NPI method

The Numbering Plan Identification (NPI) method is a protocol technique by which the called or calling party number, which may come from either the X.121 or E.164 numbering plan, can be specified in an unambiguous manner, since the numbering plan is clearly and uniquely identified by the coding in the NPI field of the called/calling party number.

This method requires the use of a call control protocol and the existence of an NPI field within the protocol message that passes the called and calling addresses. The NPI field contains a code that indicates which numbering plan the called (or calling) party number belongs to. Within the X.36 and X.76 Frame Relay Signalling protocols and the Q.2931 and Q.2933 ATM signalling protocols the called or calling party number (which includes the NPI, TON and digits) are carried in a specific field of the call set-up message.

6.2.2.1 Numbering Plan Identification

The Numbering Plan Identification (NPI) field shall be coded to be either X.121 or E.164. In the case where the ATM terminal is identified by an AESA (NSAP) (see Figures 13 and 14), the Numbering Plan Identification (NPI) field is coded as ISO NSAP.

6.2.2.2 Type of number

The Type of Number (TON) field shall be coded to be "International Number". In the case where the ATM terminal is identified by an AESA (NSAP) (see Figures 13 and 14), the Type of Number field is coded as Alternative Address (ALT-ADD) at the X.36 Frame Relay interface and is coded as UNKNOWN at the Q.2931 ATM interface. The interworking function is required to map the TON values to the appropriate value expected on the interface.

6.3 Terminal dialling procedures

To the extent reasonably possible, the method used for a numbering plan interworking arrangement should be such that it minimizes the impact on the user. When a terminal in one numbering plan wishes to call a terminal whose number is in another numbering plan, there are two basic methods for establishing a connection. The two methods are called the single stage method and the double stage method. Both single and double stage methods are included in the accompanying diagrams and are described below.

6.3.1 Single stage dialling

Single stage dialling to achieve numbering plan interworking is typically accomplished as follows:

This procedure requires the existence of a user-to-network protocol that contains an NPI field and an originating terminal that provides some means whereby the caller can specify the appropriate NPI. The calling terminal enters the called party number in an appropriate format. The originating switching system can then use the information in the NPI field to determine the numbering plan of the called party number. The calling terminal must also be aware that the called party number is in another numbering plan and must use the appropriate NPI when the connection is established.

6.3.2 Two stage dialling

The two stage method derives its name from the fact that the calling terminal must enter the called party address information in two separate stages. As the first stage in the process, the calling terminal enters a called party address which corresponds to an access unit to a network that uses the numbering plan of the called terminal. A connection is established between the calling terminal and the access unit.

When this connection has been established, the access unit sends a response to the calling terminal. At this point, the calling terminal becomes equivalent to a subscriber on the network that has just returned the response. The calling terminal then enters the address of the called terminal. This second called address information is passed transparently through the originating network to the network that returned the second stage response. The call will then be established to the called subscriber.

7 Interworking diagrams

This clause is comprised of three parts. The first part describes the conventions used in the interworking diagrams. The second part includes an index of the interworking diagrams that have been developed for this Recommendation. Finally, the third part contains the interworking diagrams.

7.1 Conventions used in the interworking diagrams (Figures 2 through 14)

7.1.1 The figures are intended only as examples and are consequently not restrictive unless it is specified.

7.1.2 A specific set of figures is associated with each direction of interworking, but for both directions, the same reference configuration is used for comparison.

7.1.3 Called/calling party numbers are represented in the format applicable to the numbering plan. NPI and TON are shown where appropriate.

The presence and the exact format of the called and calling party numbers at the DTE/DCE interface are network-dependent.

7.1.4 The diagrams represent either 2 or 3 network interworking cases.

7.1.5 Where appropriate, the relevant DTE/DCE or STE/STE Recommendations (for example X.36, X.76) are shown.

7.1.6 The connection of networks and terminals, etc., are shown schematically by reference configurations.

7.1.6.1 Networks are represented by ovals, terminals by triangles, and the path between them by a line.

7.1.6.2 Under each terminal symbol a type of terminal has been indicated. Where a Frame Relay (called or calling) terminal is shown, this indicates a terminal using X.36 procedures. Where an ATM (called or calling) terminal is shown, this indicates an ATM terminal using Q.2933 or Q.2931 procedures. In addition, under this information is shown the numbering plan(s) in which the terminal is identified.

7.1.7 The number flows and additional call set-up procedures are shown in block diagram form under the network schematic.

7.1.7.1 The networks are represented by large vertical rectangles connected by smaller horizontal rectangles in a two-layer structure.

7.1.7.2 The lower layer shows the called and calling numbers which are associated to the X.36 protocol elements [i.e. Call Set-up Message (CSM)]. This lower layer is always entirely present from the calling terminal to the called terminal.

7.1.7.3 The upper layer shows, when needed, the additional procedures associated with the establishment of the physical connection. This may include: establishment of X.46 call offering procedures, etc.

7.1.7.4 The rectangles are numbered, indicating the order in which the necessary steps are carried out.

7.1.7.5 Access unit terminology in the diagrams (as shown in Figures 11 and 12) is defined in Recommendation X.46.

7.2 Index of interworking diagrams

The following scenarios are described in this Recommendation.

Figure 1 Provides a schematic summary of the interworking scenarios described in this Recommendation.

Figure 2 Interworking from a PFRDN numbered under X.121 to a PFRDN numbered under E.164 using X.36/X.76 procedures.

Figure 3 Interworking from a PFRDN numbered under E.164 to a PFRDN numbered under X.121 using X.36/X.76 procedures.

Figure 4 Network interworking from a PFRDN numbered under X.121 to ATM Network numbered under E.164 using X.36/X.76 and Q.2933 procedures.

Figure 5 Network interworking from ATM Network numbered under E.164 to a PFRDN numbered under X.121 using Q.2933 and X.36/X.76 procedures.

Figure 6 Network interworking from a PFRDN numbered under X.121 using X.36/X.76 procedures to a PFRDN numbered under X.121 using X.36/X.76 procedures with an ATM Network (E.164) using Q.2933 procedures as a transit network.

Figure 7 Network interworking from a PFRDN numbered under X.121 using X.36/X.76 procedures to a PFRDN numbered under E.164 using X.36/X.76 procedures with an ATM Network (E.164) using Q.2933 procedures as a transit network.

Figure 8 Network interworking from a PFRDN numbered under E.164 using X.36/X.76 procedures to a PFRDN numbered under X.121 using X.36/X.76 procedures with an ATM Network (E.164) using Q.2933 procedures as a transit network.

Figure 9 Service interworking from a PFRDN numbered under X.121 to an ATM Network numbered under E.164 using X.36/X.76 and Q.2931 procedures.

Figure 10 Service interworking from an ATM Network numbered under E.164 to a PFRDN numbered under X.121 using Q.2931 and X.36/X.76 procedures.

Figure 11 FRDTS interworking from a PFRDN numbered under X.121 using X.36 procedures to an ATM Network numbered under E.164 using X.46 procedures.

Figure 12 FRDTS interworking from an ATM Network numbered under E.164 using X.46 procedures to a PFRDN numbered under X.121 using X.36 procedures.

Figure 13 Service interworking from a frame relay terminal on a PFRDN numbered under X.121 to an ATM terminal identified by an AESA (NSAP format) using X.36/X.76 and Q.2931 procedures.

Figure 14 Service interworking from an ATM terminal identified by an AESA (NSAP format) to a frame relay terminal on a PFRDN numbered under X.121 using X.36/X.76 and Q.2931 procedures.

7.3 Interworking diagrams

Figure 1 is a representation of the interworking scenarios which are described in this Recommendation and provides a simple graphic depiction of the linkages between networks.

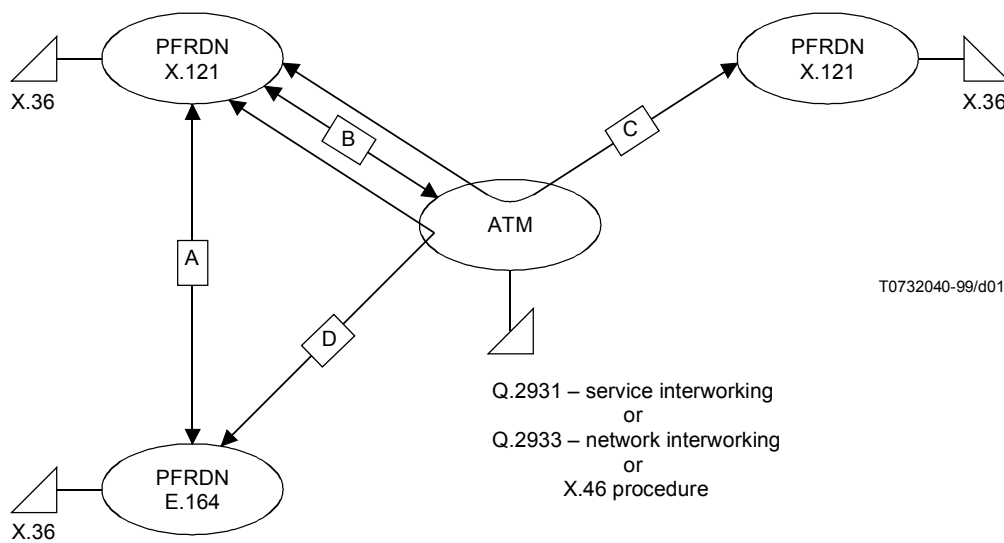
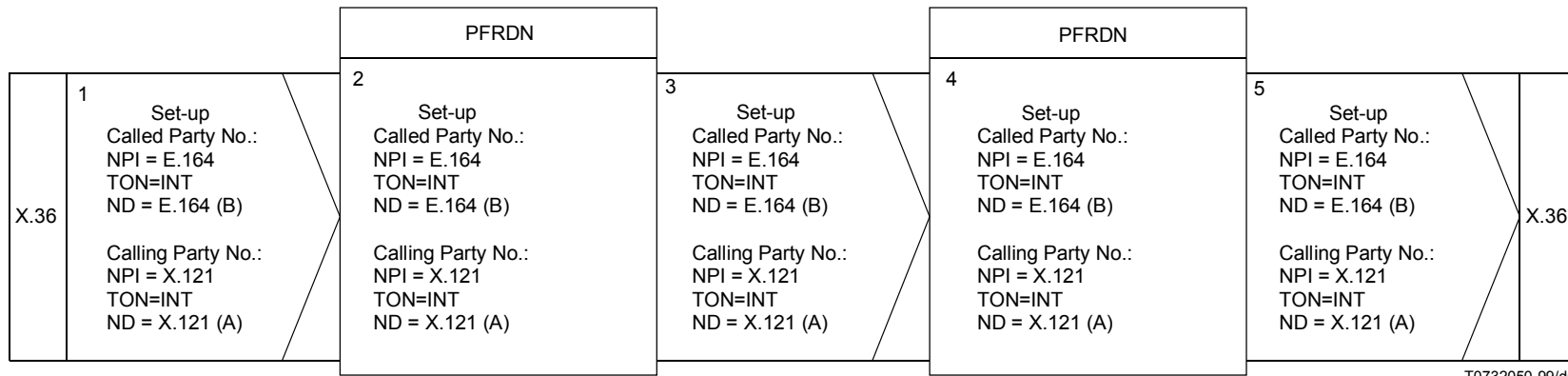
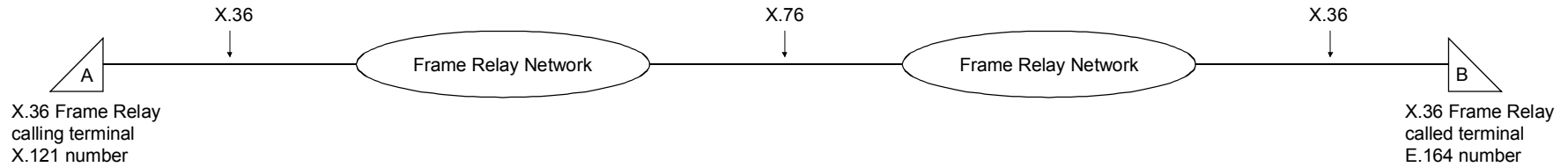

Figure 1/X.124 – Scenarios for interworking

The following list describes the links associated with each interworking figure.

LINK A	Figures 2, 3	LINK B	Figures 4, 5, 9, 10, 11, 12, 13, 14
LINK C	Figure 6	LINK D	Figures 7, 8



T0732050-99/d02

NOTE – This scenario is single stage dialling.

Figure 2/X.124 – Interworking from a PFRDN numbered under X.121 to a PFRDN numbered under E.164 using X.36/X.76 procedures

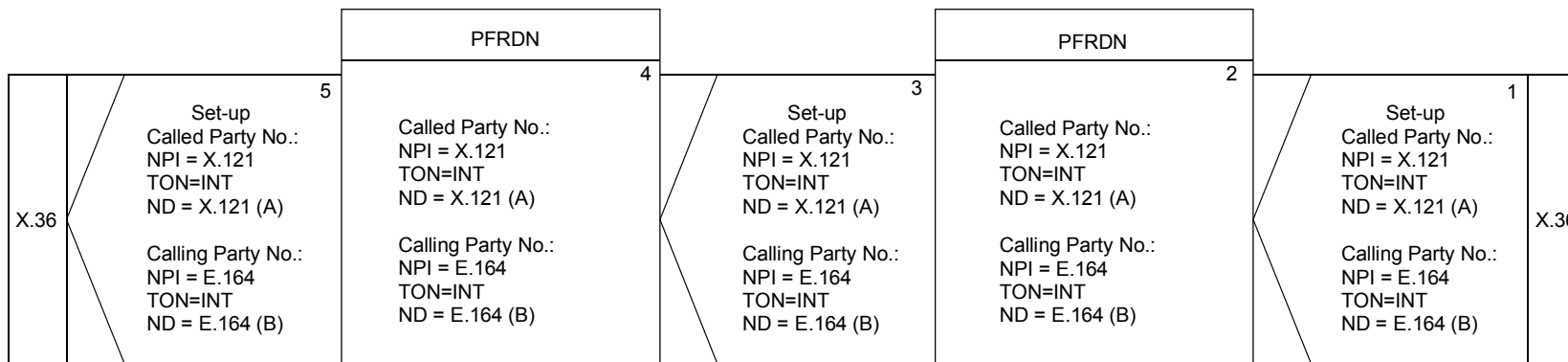
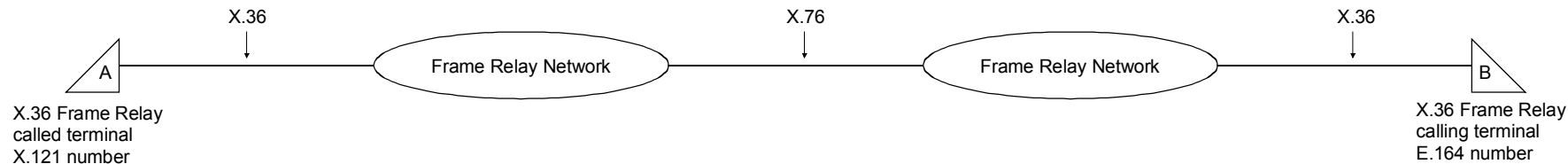

T0732060-99/d03

NOTE – This scenario is single stage dialling.

Figure 3/X.124 – Interworking from a PFRDN numbered under E.164 to a PFRDN numbered under X.121 using X.36/X.76 procedures

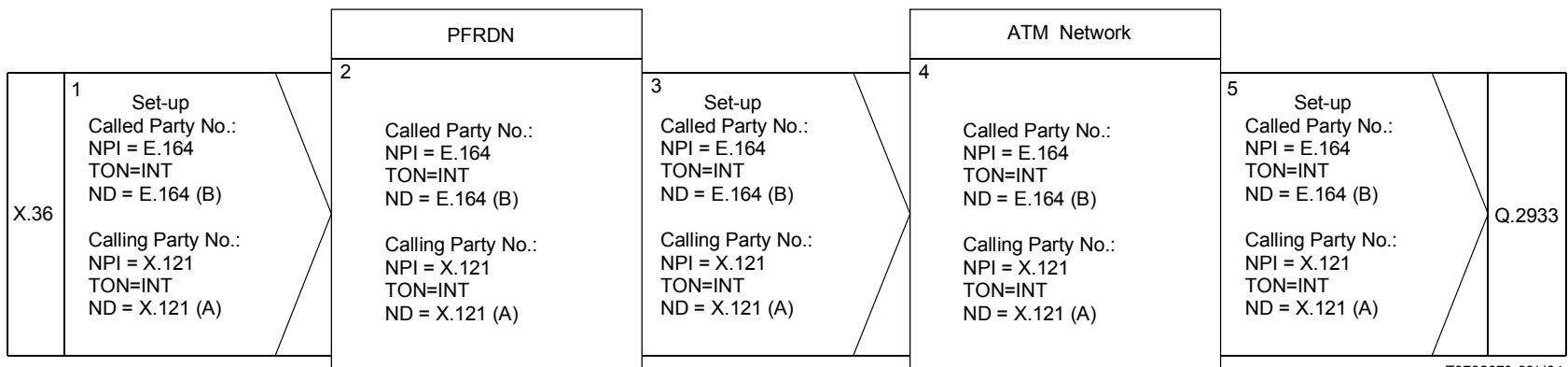
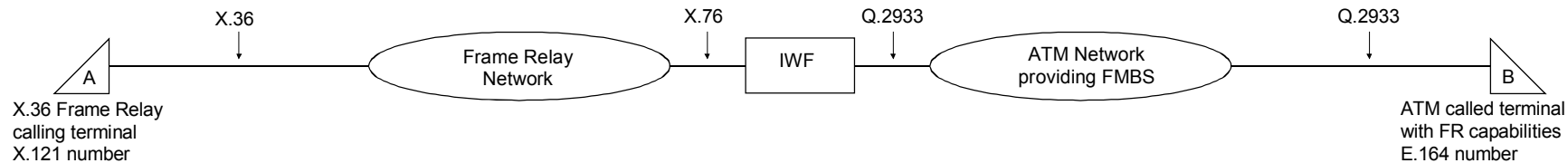

T0732070-99/d04

- NOTE 1 – This scenario is single stage dialling.
- NOTE 2 – This scenario is network interworking.
- NOTE 3 – The ATM Network must provide a FMBS capability.

Figure 4/X.124 – Network interworking from a PFRDN numbered under X.121 to an ATM Network numbered under E.164 using X.36/X.76 and Q.2933 procedures

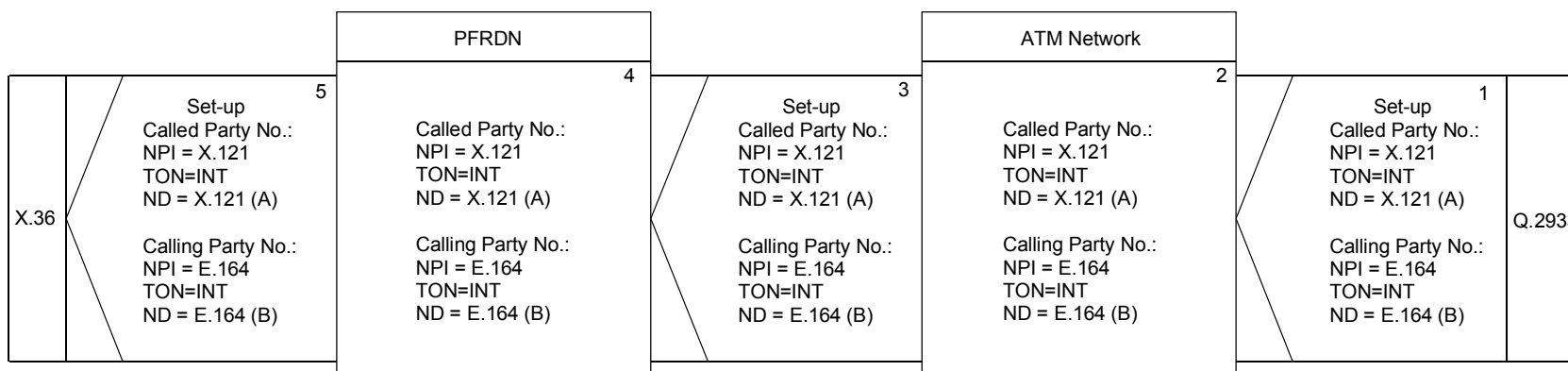
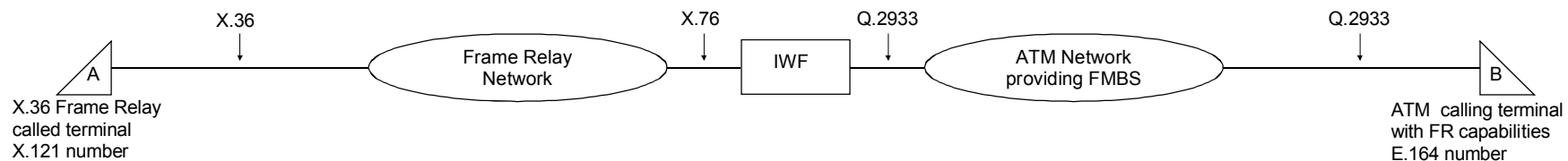

T0732080-99/d05

- NOTE 1 – This scenario is single stage dialling.
- NOTE 2 – This scenario is network interworking.
- NOTE 3 – The ATM Network must provide a FMBS capability.

Figure 5/X.124 – Network interworking from an ATM Network numbered under E.164 to a PFRDN numbered under X.121 using Q.2933 and X.36/X.76 procedures

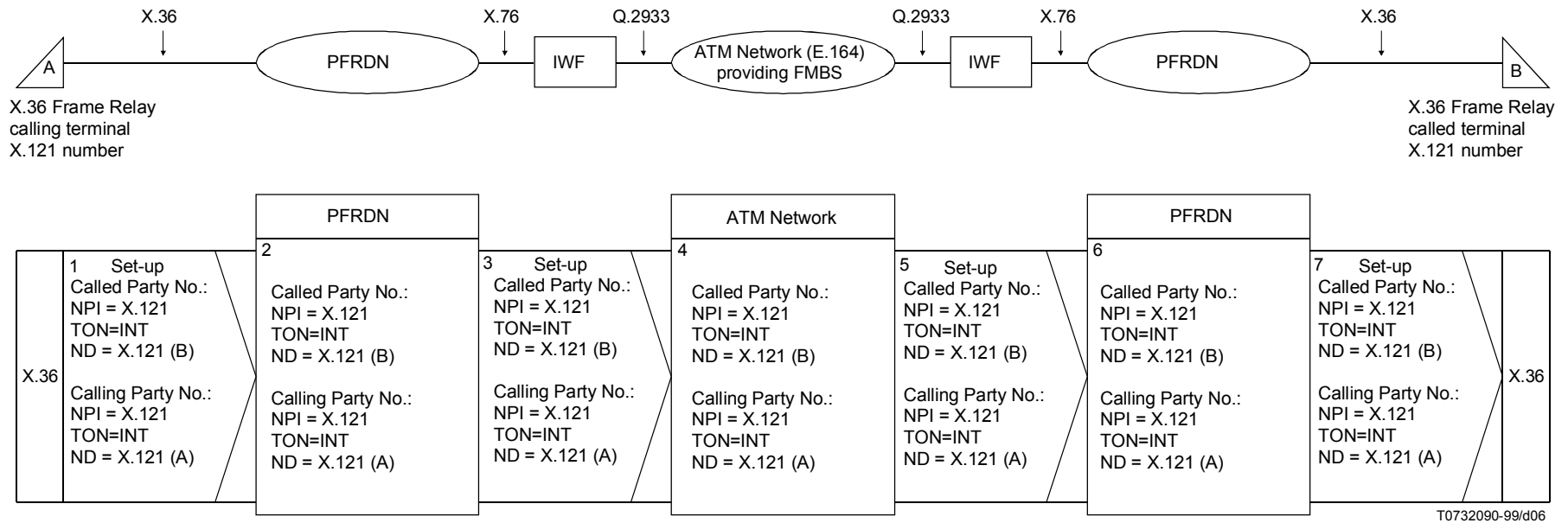

NOTE 1 – This scenario is single stage dialling.
 NOTE 2 – This scenario is network interworking.
 NOTE 3 – The ATM Network provides a Frame Mode Bearer Service.

Figure 6/X.124 – Network interworking from a PFRDN numbered under X.121 using X.36/X.76 procedures to a PFRDN numbered under X.121 using X.36/X.76 procedures with an ATM Network (E.164) using Q.2933 procedures as a transit network

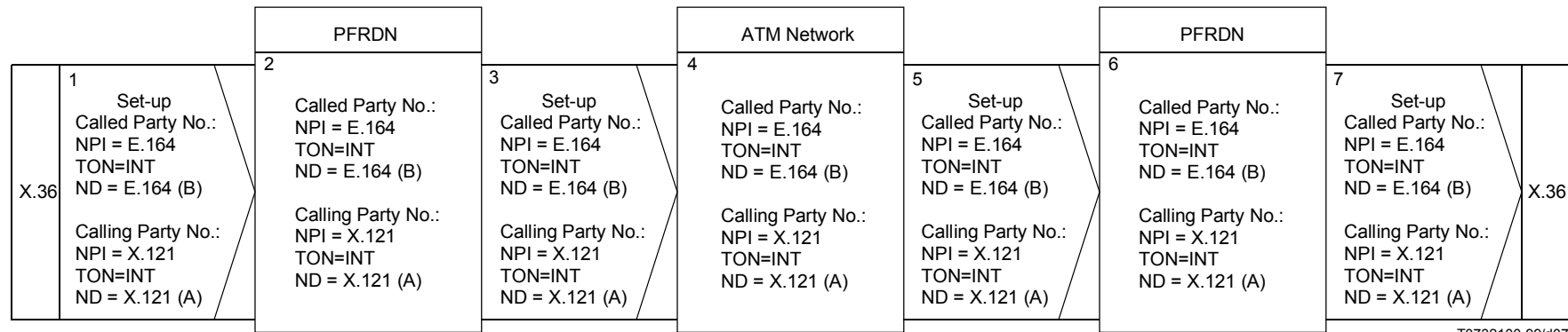
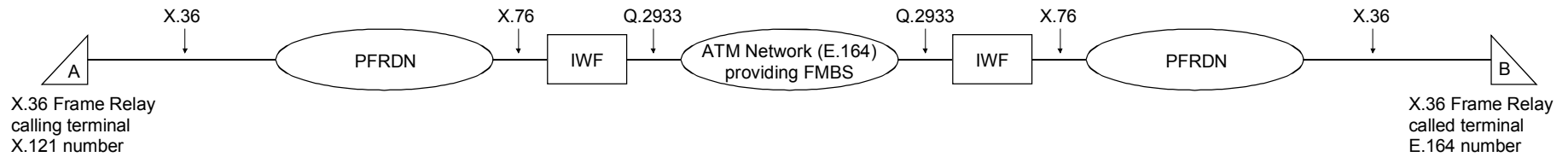

T0732100-99/d07

NOTE 1 – This scenario is single stage dialling.
 NOTE 2 – This scenario is network interworking.
 NOTE 3 – The ATM Network provides a Frame Mode Bearer Service.

Figure 7/X.124 – Network interworking from a PFRDN numbered under X.121 using X.36/X.76 procedures to a PFRDN numbered under E.164 using X.36/X.76 procedures with an ATM Network (E.164) using Q.2933 procedures as a transit network

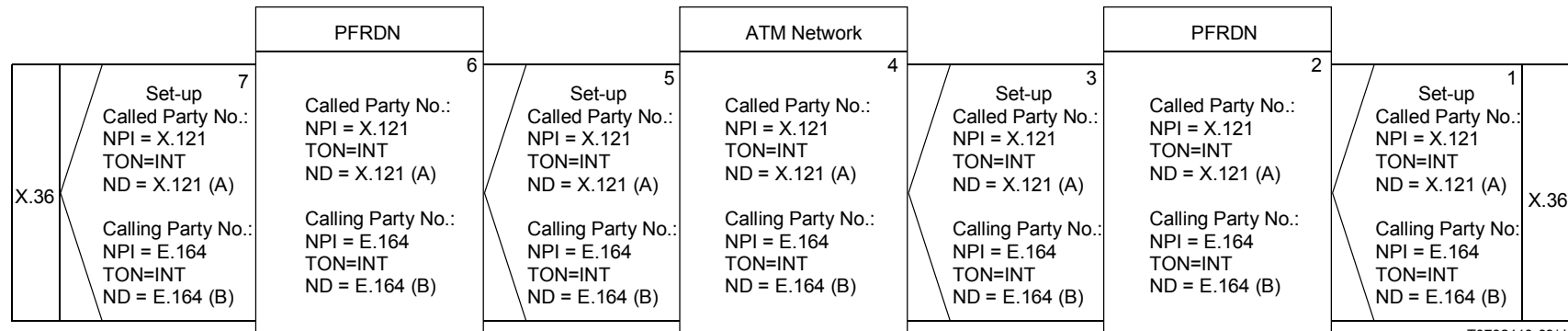
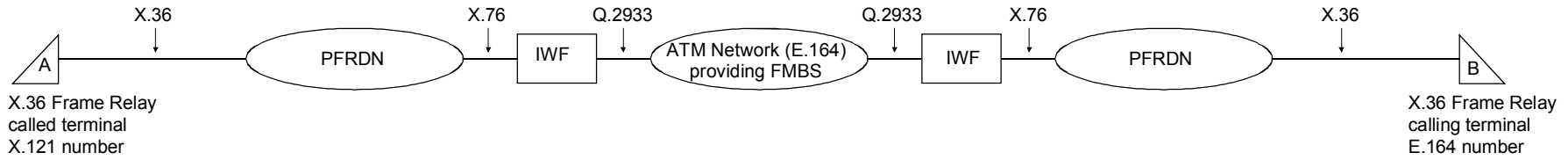

T0732110-99/d08

- NOTE 1 – This scenario is single stage dialling.
- NOTE 2 – This scenario is network interworking.
- NOTE 3 – The ATM Network provides a Frame Mode Bearer Service.

Figure 8/X.124 – Network interworking from a PFRDN numbered under E.164 using X.36/X.76 procedures to a PFRDN numbered under X.121 using X.36/X.76 procedures with an ATM Network (E.164) using Q.2933 procedures as a transit network

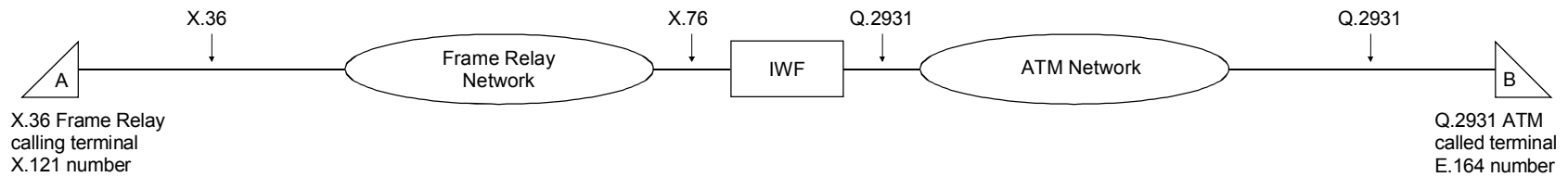

X.36 Frame Relay calling terminal X.121 number

Q.2931 ATM called terminal E.164 number

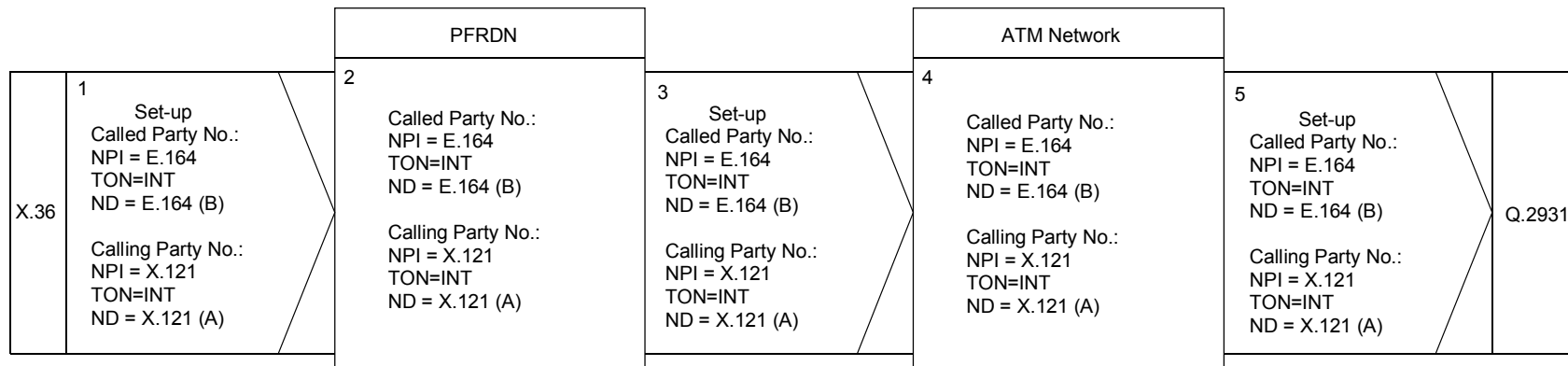

T0732120-99/d09

NOTE 1 – This scenario is single stage dialling.
NOTE 2 – This scenario is service interworking.

Figure 9/X.124 – Service interworking from a PFRDN numbered under X.121 to an ATM Network numbered under E.164 using X.36/X.76 and Q.2931 procedures

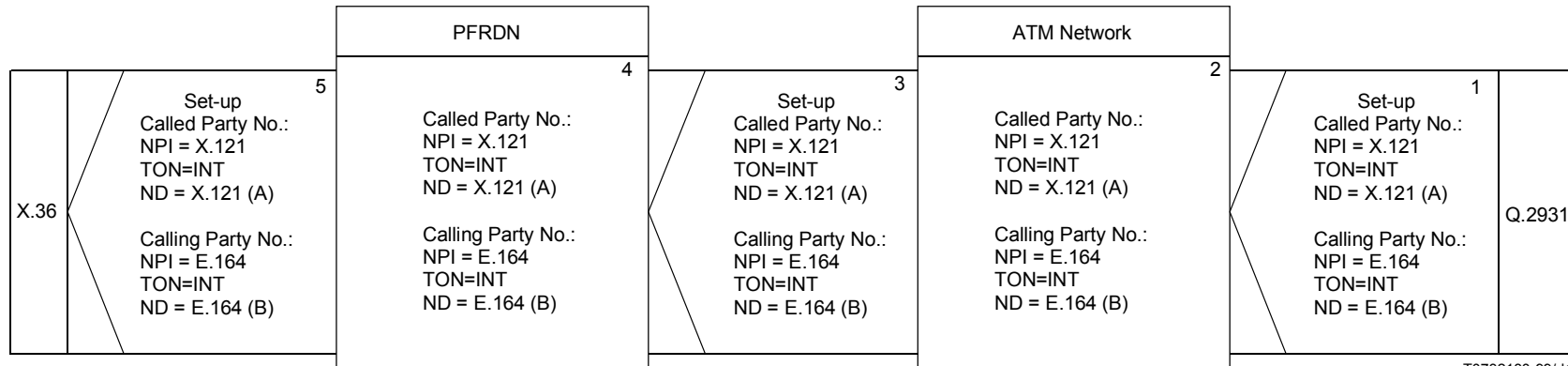
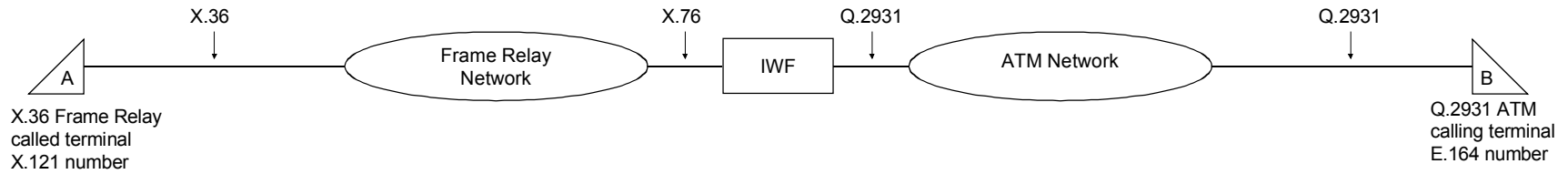

T0732130-99/d10

NOTE 1 – This scenario is single stage dialling.
NOTE 2 – This scenario is service interworking.

Figure 10/X.124 – Service interworking from an ATM Network numbered under E.164 to a PFRDN numbered under X.121 using Q.2931 and X.36/X.76 procedures

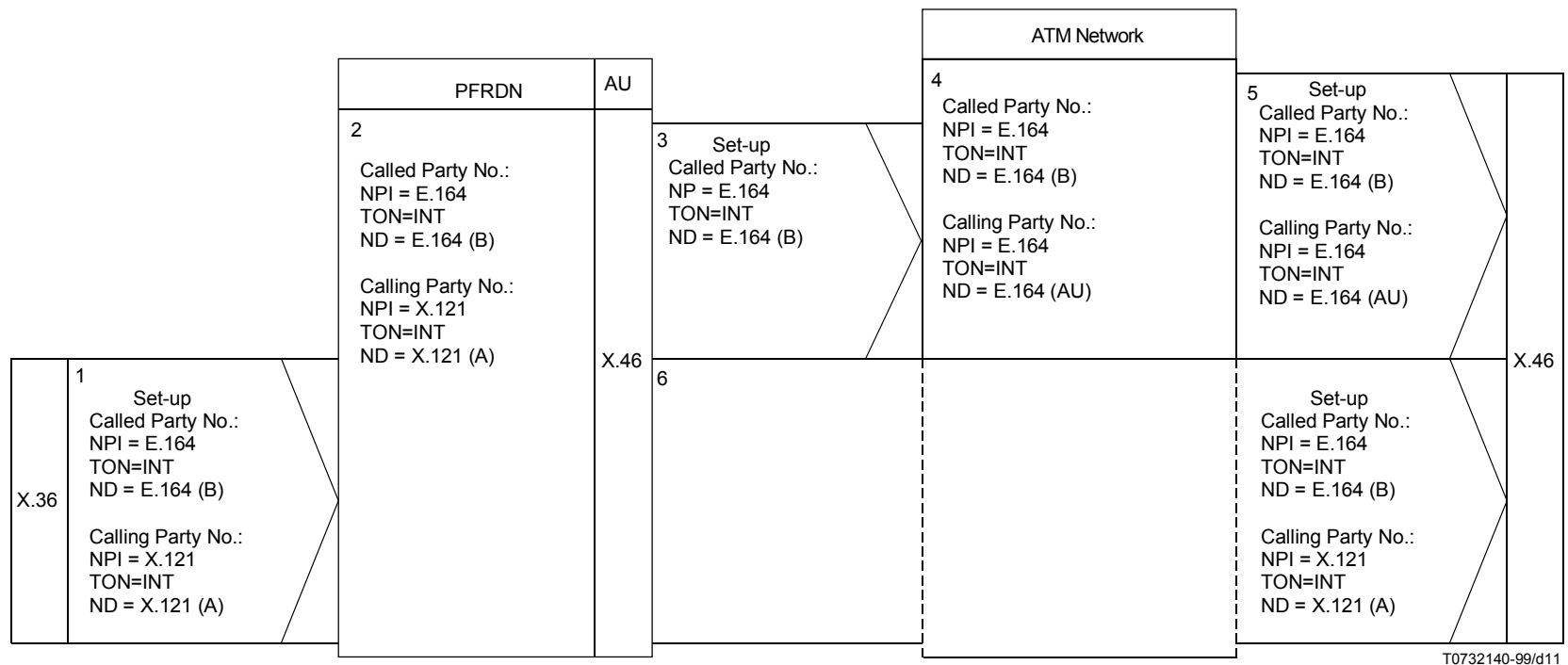
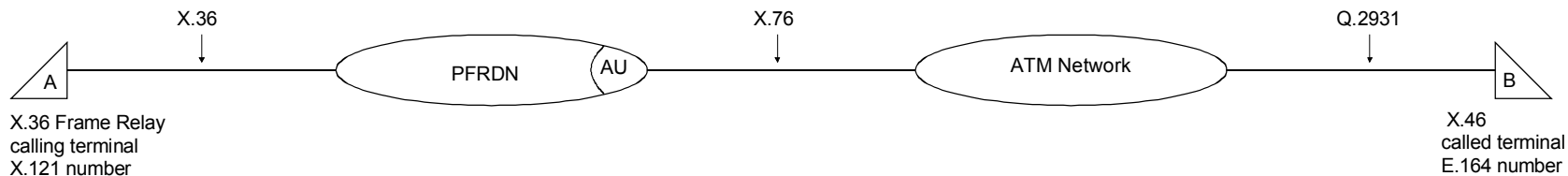

NOTE 1 – This scenario is two stage dialling.

NOTE 2 – Steps 3, 4 and 5 are not used when a circuit between terminal B and the Access Unit is already established.

Figure 11/X.124 – FRDTS interworking from a PFRDN numbered under X.121 using X.36 procedures to an ATM Network numbered under E.164 using X.46 procedures

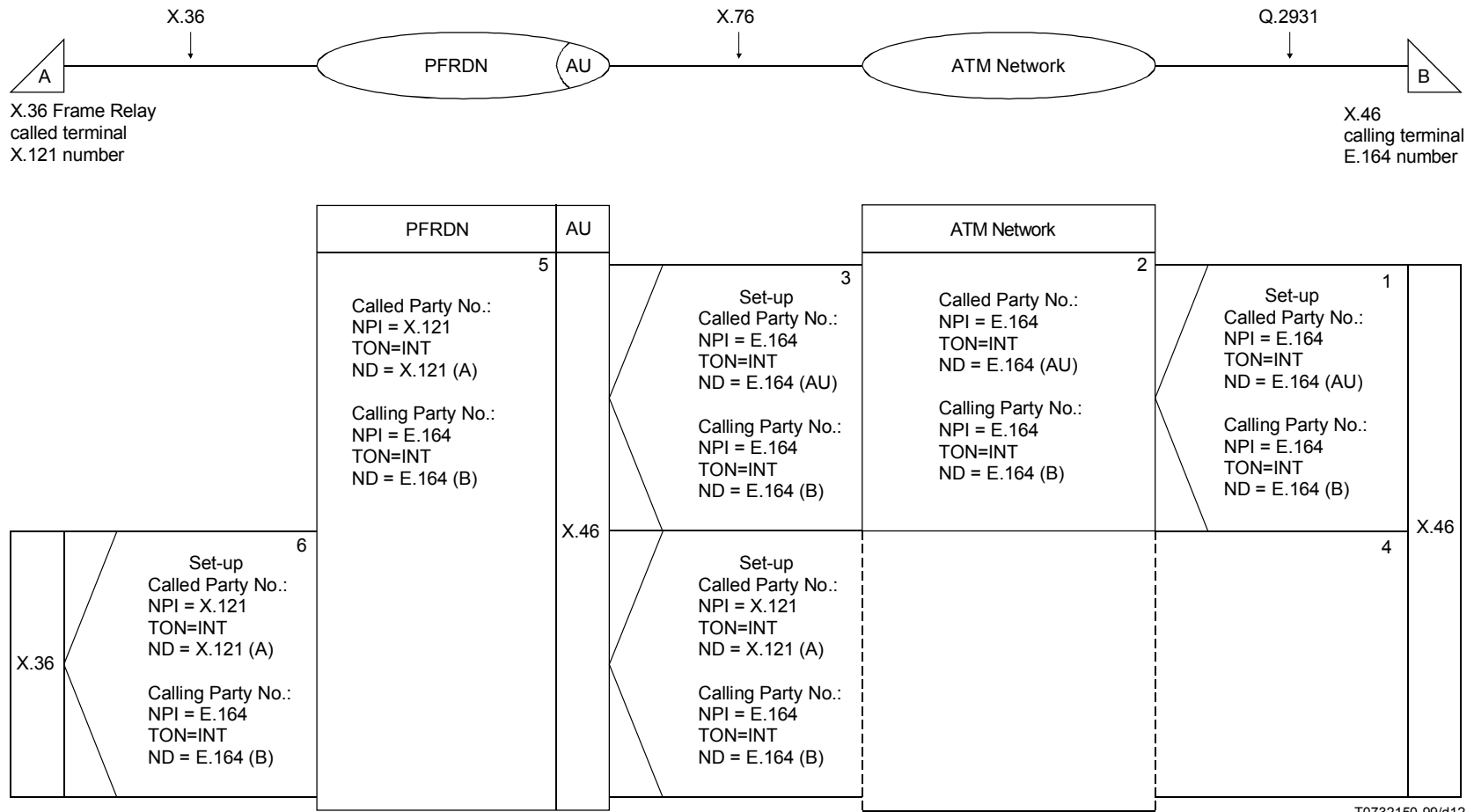

T0732150-99/d12

NOTE 1 – This scenario is two stage dialling.

NOTE 2 – Steps 1, 2 and 3 are not used when a circuit between terminal B and the Access Unit is already established.

Figure 12/X.124 – FRDTS interworking from an ATM Network numbered under E.164 using X.46 procedures to a PFRDN numbered under X.121 using X.36 procedures

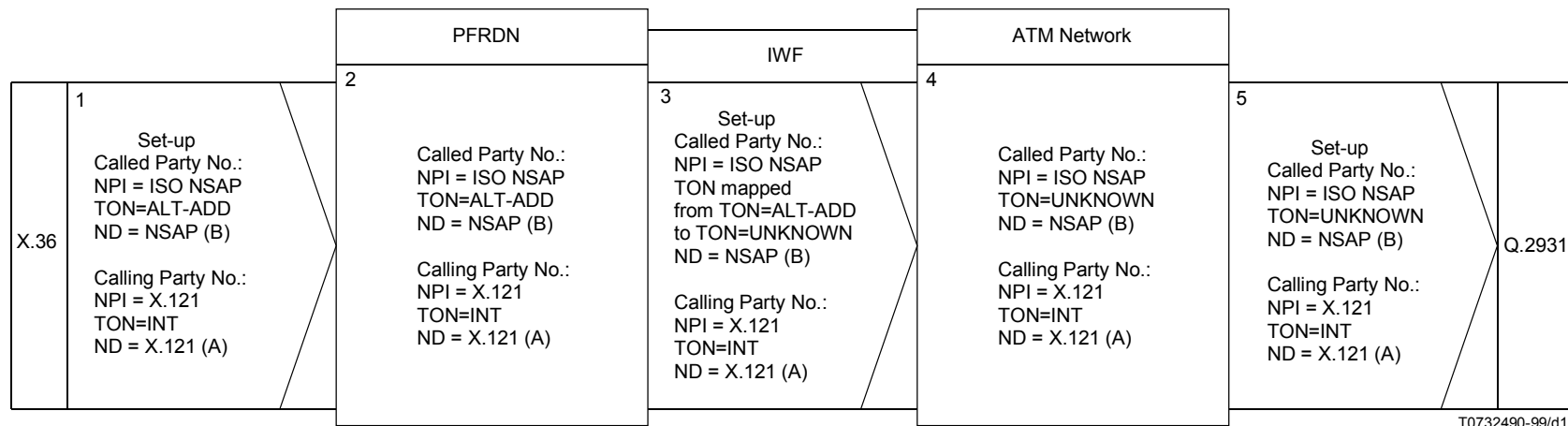
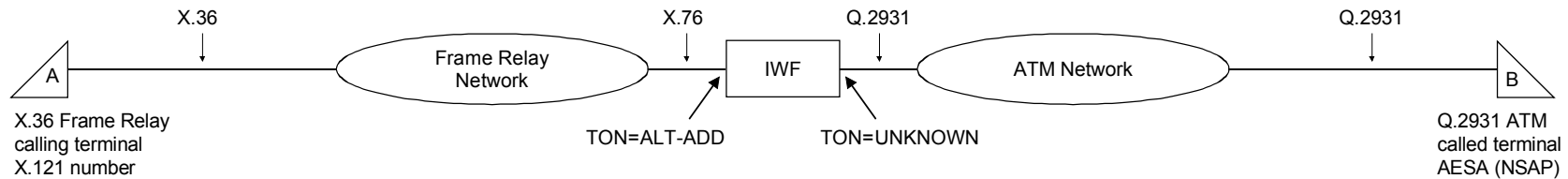

NOTE 1 – This scenario is single stage dialling.

NOTE 2 – This scenario is service interworking.

NOTE 3 – The IWF maps the TON value from TON=ALT-ADD to TON=UNKNOWN.

Figure 13/X.124 – Service interworking from a frame relay terminal on a PFRDN numbered under X.121 to an ATM terminal identified by an AESA (NSAP format) using X.36/X.76 and Q.2931 procedures

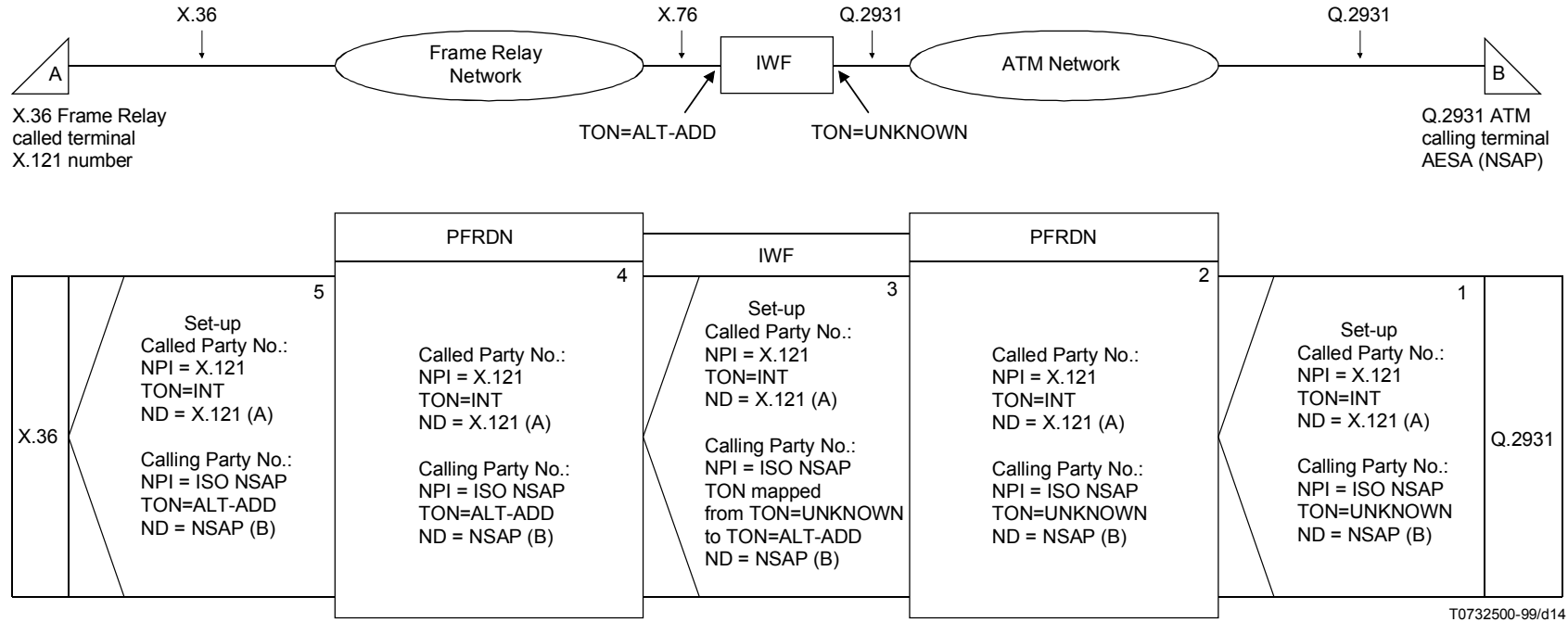

NOTE 1 – This scenario is single stage dialling.
 NOTE 2 – This scenario is service interworking.
 NOTE 3 – The IWF maps the TON value from TON=UNKNOWN to TON=ALT-ADD.

Figure 14/X.124 – Service interworking from an ATM terminal identified by an AESA (NSAP format) to a frame relay terminal on a PFRDN numbered under X.121 using X.36/X.76 and Q.2931 procedures

ITU-T RECOMMENDATIONS SERIES

Series A	Organization of the work of the ITU-T
Series B	Means of expression: definitions, symbols, classification
Series C	General telecommunication statistics
Series D	General tariff principles
Series E	Overall network operation, telephone service, service operation and human factors
Series F	Non-telephone telecommunication services
Series G	Transmission systems and media, digital systems and networks
Series H	Audiovisual and multimedia systems
Series I	Integrated services digital network
Series J	Transmission of television, sound programme and other multimedia signals
Series K	Protection against interference
Series L	Construction, installation and protection of cables and other elements of outside plant
Series M	TMN and network maintenance: international transmission systems, telephone circuits, telegraphy, facsimile and leased circuits
Series N	Maintenance: international sound programme and television transmission circuits
Series O	Specifications of measuring equipment
Series P	Telephone transmission quality, telephone installations, local line networks
Series Q	Switching and signalling
Series R	Telegraph transmission
Series S	Telegraph services terminal equipment
Series T	Terminals for telematic services
Series U	Telegraph switching
Series V	Data communication over the telephone network
Series X	Data networks and open system communications
Series Y	Global information infrastructure
Series Z	Languages and general software aspects for telecommunication systems