



INTERNATIONAL TELECOMMUNICATION UNION

**ITU-T**

TELECOMMUNICATION  
STANDARDIZATION SECTOR  
OF ITU

**X.82**

**PUBLIC DATA NETWORKS**

**TRANSMISSION, SIGNALLING AND SWITCHING**

---

**DETAILED ARRANGEMENTS FOR  
INTERWORKING BETWEEN CSPDNS AND  
PSPDNS BASED ON RECOMMENDATION T.70**

**ITU-T Recommendation X.82**

(Extract from the *Blue Book*)

---

## NOTES

1 ITU-T Recommendation X.82 was published in Fascicle VIII.3 of the *Blue Book*. This file is an extract from the *Blue Book*. While the presentation and layout of the text might be slightly different from the *Blue Book* version, the contents of the file are identical to the *Blue Book* version and copyright conditions remain unchanged (see below).

2 In this Recommendation, the expression "Administration" is used for conciseness to indicate both a telecommunication administration and a recognized operating agency.

© ITU 1988, 1993

All rights reserved. No part of this publication may be reproduced or utilized in any form or by any means, electronic or mechanical, including photocopying and microfilm, without permission in writing from the ITU.

## Recommendation X.82

### DETAILED ARRANGEMENTS FOR INTERWORKING BETWEEN CSPDNs AND PSPDNs BASED ON RECOMMENDATION T.70

(Melbourne, 1988)

The CCITT,

*considering*

- (a) that administrations are currently operating CSPDNs and PSPDNs;
- (b) that it is essential to make it possible to allow interworking between DTEs connected to the different types of PDNs;
- (c) that CCITT services, e.g. telematic services, can be carried by PSPDN or CSPDN or both, as defined in existing Recommendations T.70 and X.300;
- (d) that Recommendation T.70 defines the network-independent basic transport service for telematic services;
- (e) that Recommendation X.300 defines general principles for interworking between public networks, and between public networks and other networks for the provision of data transmission services;
- (f) that Recommendation X.322 defines general arrangements for interworking between PSPDNs and CSPDNs for the provision of data transmission services;
- (g) that Recommendation X.75 defines procedures for PSPDN/PSPDN interworking and that Recommendation X.71 defines procedures for CSPDN/CSPDN interworking;
- (h) that Recommendation X.25 defines the user interface to PSPDNs, and that Recommendations X.21/X.21 *bis* define the user interface to CSPDNs;

*unanimously declares the view*

that detailed arrangements for interworking between CSPDNs and PSPDNs on the basis of Recommendation T.70 for telematic services shall be in accordance with the procedures specified in this Recommendation.

#### CONTENTS

0	<i>Introduction</i>
1	<i>Scope and field of application</i>
2	<i>References</i>
3	<i>Definitions</i>
4	<i>Abbreviations</i>
5	<i>General aspects</i>
5.1	Circuit switched public data network
5.2	Packet switched public data network
6	<i>Specification of interworking functions</i>
6.1	Connection establishment phase
6.1.1	Connection establishment initiated on the CSPDN side
6.1.2	Connection establishment initiated on the PSPDN side

- 6.2 Connection release phase
  - 6.2.1 Connection release initiated on the CSPDN side
  - 6.2.2 Connection release initiated on the PSPDN side
  - 6.2.3 Connection release initiated by the IWF T.70
- 6.3 Data transfer phase
  - 6.3.1 Handling of user data
  - 6.3.2 Handling of qualifier bit
  - 6.3.3 Handling of delivery confirmation bit
  - 6.3.4 Handling of more data bit
  - 6.3.5 Reset
- 7 *Restart request*
  - 7.1 Restart request initiated by the PSPDN
  - 7.2 Restart request initiated by the IWF T.70

*Appendix I - Items in relationship to the OSI connection-mode network service*

## **0 Introduction**

This Recommendation is one of a set of Recommendations produced to facilitate considerations of interworking between networks. It is based on Recommendation X.300, which defines the general principles for interworking between public networks, and between public networks and other networks for the provision of data transmission services. Recommendation X.300 indicates in particular how collections of physical equipment can be represented as "Subnetworks" for consideration in interworking situations.

This Recommendation describes the interworking arrangements between circuit switched public data networks (CSPDN) and packet switched public data networks (PSPDN) based on CCITT Recommendation T.70.

## **1 Scope and field of application**

The purpose of this Recommendation is to describe the detailed arrangements for the interworking between CSPDNs and PSPDNs based on Recommendation T.70. These arrangements are applicable only to the interworking involving telematic services, and not to the interworking involving communication capabilities described in Recommendation X.300.

The mapping of protocol data units taken from different protocols is limited to the capabilities of each of the protocols. The functions that are required to provide the full OSI connection-mode network service (CONS) and their relation to this Recommendation can be found in the Appendix I.

## **2 References**

Recommendation T.70	Network-independent basic transport service for telematic services,
Recommendation X.1	International user classes of service in public data networks and integrated services digital networks (ISDNs),
Recommendation X.2	International data transmission services and optional user facilities in public data networks and ISDNs,
Recommendation X.21	Interface between data terminal equipment (DTE) and data circuit-terminating equipment (DCE) for synchronous operation on public data networks,
Recommendation X.21 <i>bis</i>	Use on public data networks of data terminal equipment (DTE) which is designed for interfacing to synchronous V-series modems,
Recommendation X.25	Interface between data terminal equipment (DTE) and data circuit-terminating equipment (DCE) for terminals operating in the packet mode and connected to public data networks by dedicated circuit,
Recommendation X.71	Decentralized terminal and transit control signalling system on international circuits between synchronous data networks,
Recommendation X.75	Packet switched signalling system between public networks providing data transmission services,
Recommendation X.121	International numbering plan for public data networks,
Recommendation X.300	General principles for interworking between public networks, and between public networks and other networks for the provision of data transmission services.

### 3 Definitions

No specific definitions need to be taken into account.

### 4 Abbreviations

CLI	Calling Line Identification
CONS	Connection-mode Network Service
COT	Class of Traffic
CP	Call Progress
CSPDN	Circuit Switched Public Data Network
CUG	Closed User Group
DM	Disconnected Mode
DNIC	Data Network Identification Code
DTE	Data Terminal Equipment
EOS	End of Selection
IWF	Interworking Function
NS	Network Service
OSI	Open Systems Interconnection
PDN	Public Data Networks
PSPDN	Packet Switched Public Data Network
QOS	Quality of Service
SABM	Set Asynchronous Balanced Mode
TID	Terminal Identifier
TTC	Transit Through Connect
TTD	Transit Centres Through Connected
UA	Unnumbered Acknowledgment
UC	User Class

### 5 General aspects

This Recommendation, in describing interworking arrangements between two subnetworks, adheres to the general principles of Recommendation X.300. The environments of these two subnetworks are described in the following sections.

#### 5.1 *Circuit switched public data network*

The CSPDN provides switched data transmission services as defined in Recommendation X.1 and X.2 for the provision of data transmission services. The transmission capability of the CSPDN may also be used for the provision of telematic services defined in the T-series Recommendations.

*Note* - For additional application rules for telematic services see § 3.3 of CCITT Recommendation T.70.

#### 5.2 *Packet switched public data network*

The PSPDN provides packet switched data transmission services as defined in Recommendation X.1 and X.2 for the provision of data transmission services. The transmission capability of the PSPDN may also be used for the provision of telematic services defined in the T-series Recommendations.

*Note* - For additional application rules for telematic services see § 3.1 of CCITT Recommendation T.70.

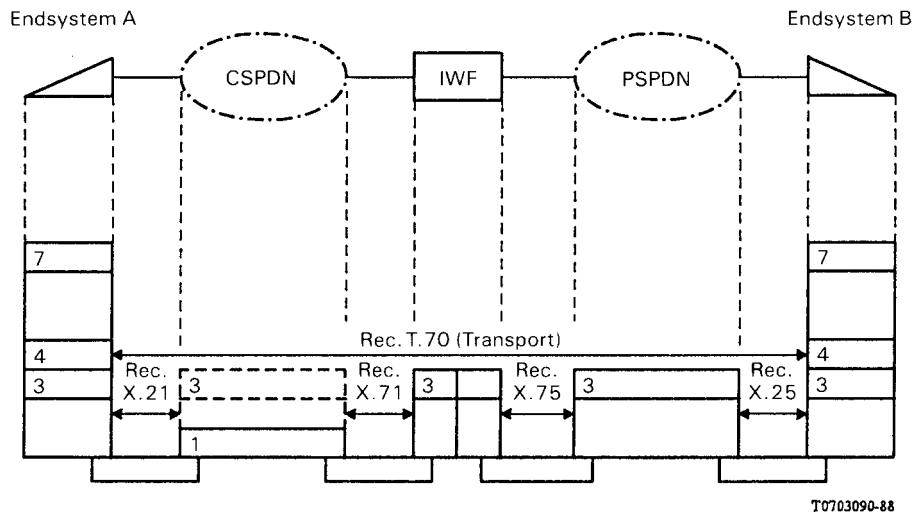

FIGURE 1/X.82

**Interworking between CSPDN and PSPDN  
based on Recommendation T.70**

## 6 Specification of interworking functions

This section describes the detailed mapping for the interworking between CSPDNs and PSPDNs based on Recommendation T.70.

### 6.1 Connection establishment phase

#### 6.1.1 Connection establishment initiated on the CSPDN side

Figures 2/X.82 to 6/X.82 show the signalling when a terminal connected to the CSPDN initiates a call towards a terminal in the PSPDN. The order of events in time might be different for unrelated signals received from the circuit and packet switched side, depending on the transmission delays and response times in both subnetworks.

While Figure 2/X.82 represents the successful connection establishment several possible unsuccessful call attempts are shown in figures 3/X.82 to 6/X.82.

##### 6.1.1.1 Selection signals

Any non allocated selection character shall result in the call being cleared with a call progress signal.

##### 1) First class-of-traffic character (1st COT)

Alternative routing allowed/not allowed is not transferred to the PSPDN.

The implementation of transit/terminal indicator Bit 1 is as follows:

If Bit 1 = 0 the DNIC is included in the selection signals;

If Bit 1 = 1 the DNIC is not included in the selection signals.

##### 2) First user class character (1st UC)

1st UC is only used to indicate that 2nd UC follows.

##### 3) Second user class character (2nd UC)

When the 2nd UC indicate TELETEX by "1001" in the bits b1 to b4, this shall be mapped to "00000010" in the first octet of the call user data field of the call request packet of Recommendation X.75. In case there is no 2 UC or in cases of coding other than "1001" the call attempt may either be rejected or continued.

*Note* - This reflects the status of Recommendation T.70. However, the transparency of the call user data field needs further consideration. Other possible mapping requirements e.g. to the class of traffic facility of Recommendation X.75 are for further study.

4) Second class-of-traffic character (2nd COT)

Bit b1 is used to indicate national/international traffic, and is not to be transferred in the Recommendation X.75 signalling. The bits b2 and b3 indicate whether the called line identification of the called terminal is requested (b2) and/or the closed user group characters of the calling terminal are following.

5) Third class-of-traffic character (3rd COT)

When receiving a 3rd COT the call attempt may either be rejected or continued. The possible future use of the 3rd COT is for further study.

6) Closed user group characters(CUG)

The closed user group characters are transferred as CUG utility in Recommendation X.75. If the CUG sequence contains less than 4 characters, excluding DNIC, zeros are inserted in the X.75 CUG utility. If a CUG DNIC is not included in the X.71 signalling, a dummy DNIC of "0000" is inserted in the CUG utility.

7) Network or service identification signal

The IWF T70 shall return a DNIC.

8) Called DTE address

The selection signals received from the CSPDN are transferred into the X.75 address field. If the called DTE address does not contain a DNIC, a DNIC shall be added by the IWF T.70.

6.1.1.2 *Transit through connect signal (TTC)*

The Calling line identification shall always be required (b2 = 1).

6.1.1.3 *Calling line identification signal (CLI)*

The calling line identification signals are used in the calling DTE address field in the X.75 Call Request Packet. If the calling line ID does not contain a CNIC, a DNIC may be added by the IWF T.70.

6.1.1.4 *Call progress signal (CP)*

The call progress signal "terminal called" is sent to inform the calling terminal that the call is being established.

The IWF may repeat this CP in order to avoid that the call attempt is cleared by the calling DTE before the call attempt in the PSPDN is either connected or timed out and cleared.

6.1.1.5 *Call request packet*

1) Called and calling DTE address

The called DTE address is obtained from the DNIC and the called terminal number in the X.71 selection signals. The end of selection character is not transferred.

The calling DTE address is obtained from the X.71 calling line identification signals. If no DNIC is included, the DNIC of the calling network will be inserted.

2) Network utilities

The throughput class indication shall be signalled and the value indicated shall be mapped to the bit rate on the circuit switched side. A lower throughput class in the call connected packet may be accepted.

The default value of 2 for window size, and 128 for packet size, shall apply for all calls and needs therefore not be signalled. The use of other values is subject to bilateral agreement.

3) User facilities

No user facilities shall be signalled.

4) Call user data

See § 6.1.1.1, item 3).

6.1.1.6 *SABM command*

The calling terminal uses address (B) in commands and (A) in responses, the IWF T.70 uses address (A) in commands and (B) in responses according to Recommendation T.70.

After receiving the originating through connection signal the IWF T.70 shall wait for the link set up by the DTE connected to the CSPDN. After a time-out condition the IWF T.70 may attempt to set up the link level itself.

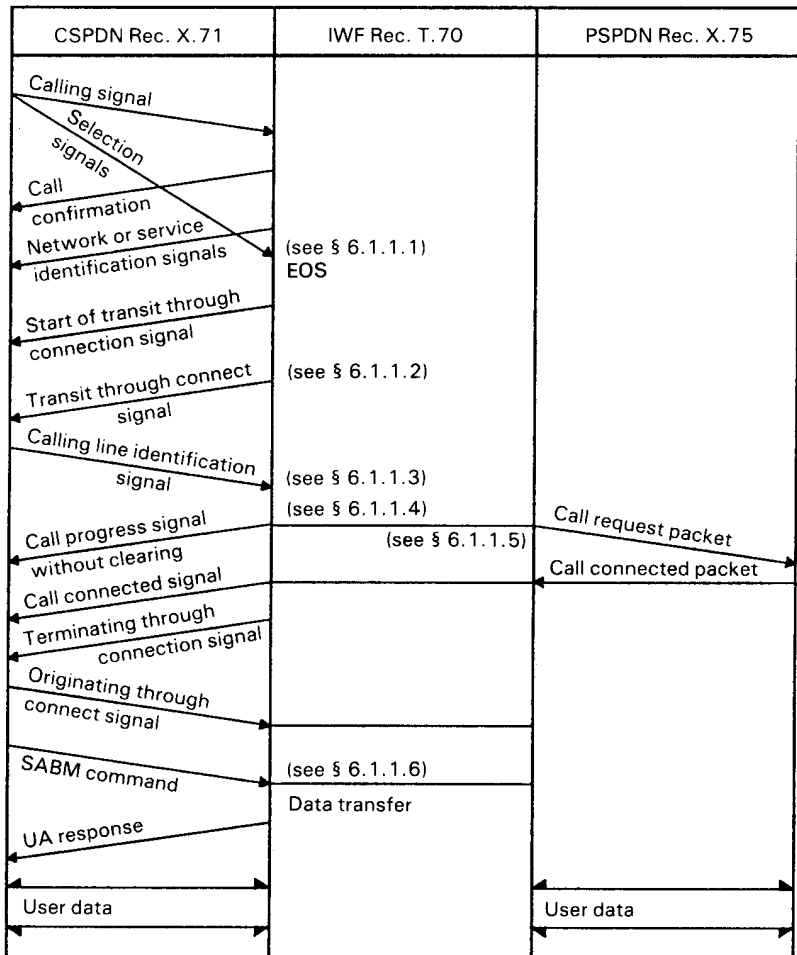

T0703100-88

FIGURE 2/X.82

Successful connection establishment CSPDN → PSPDN

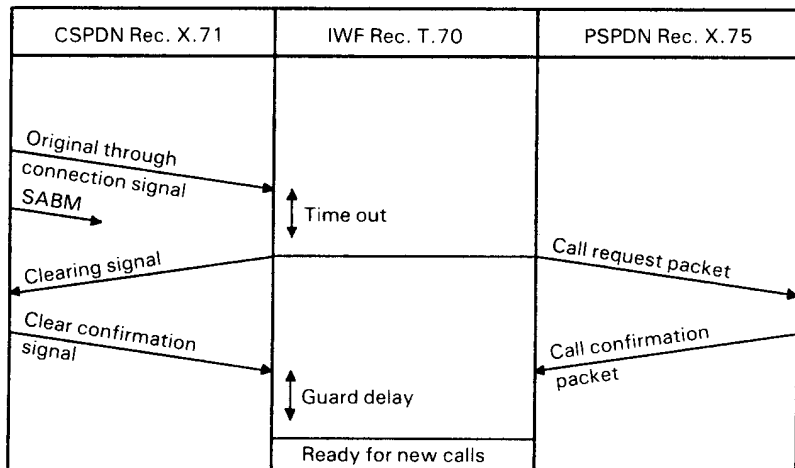

T0703110-88

FIGURE 3/X.82

Unsuccessful connection establishment CSPDN → PSPDN  
(IWF Rec. T.70 does not receive an SABM)



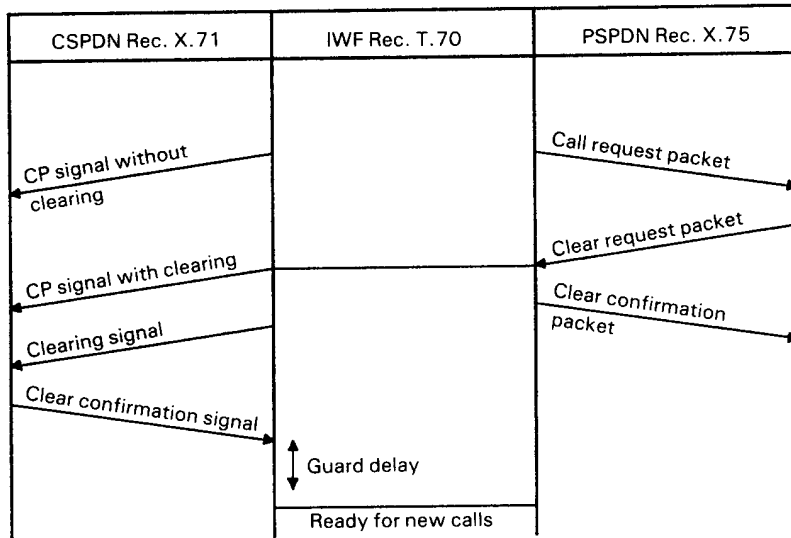

T0703120-88

FIGURE 4/X.82

Unsuccessful connection establishment CSPDN → PSPDN  
(IWF Rec. T.70 receives a clear request packet)

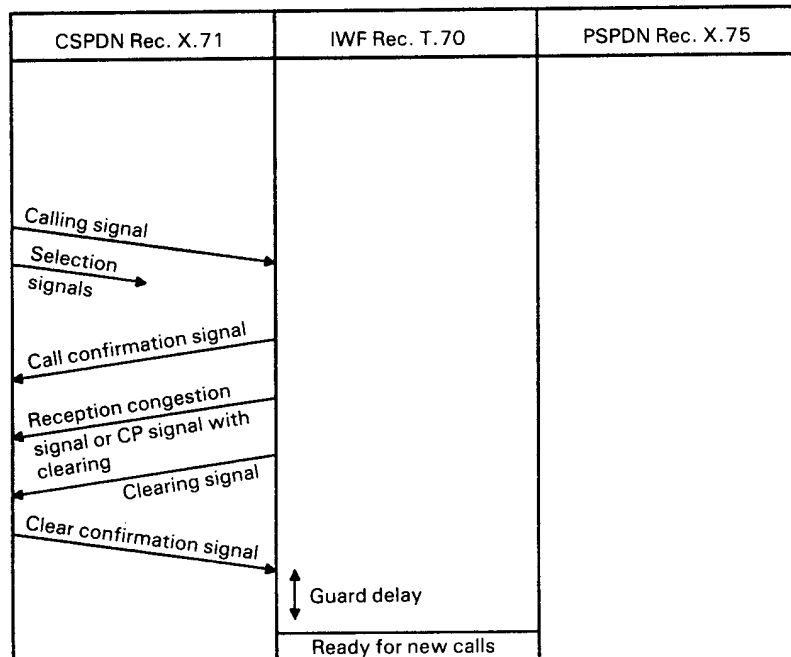

T0703130-88

FIGURE 5/X.82

Unsuccessful connection establishment CSPDN → PSPDN  
(IWF Rec. T.70 busy or no logical channels available)

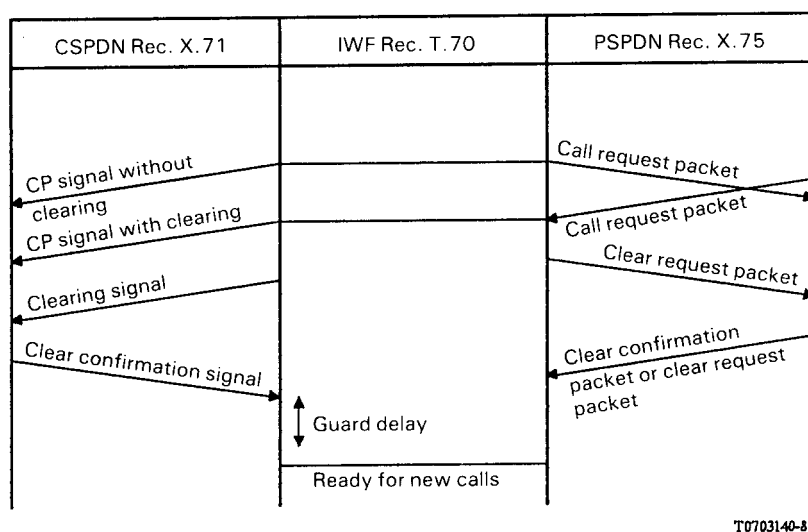

FIGURE 6/X.82

**Unsuccessful connection establishment CSPDN → PSPDN  
(Collision of call request packets on the PSPDN-side)**

### 6.1.2 Connection establishment initiated on the PSPDN side

Figures 7/X.82 to 11/X.82 show the signalling when a terminal connected to the PSPDN initiates a call towards a terminal in the CSPDN. The order of events in time might be different for unrelated signals received from the circuit and packet switched side, depending on the transmission delays and response times in both subnetworks.

While Figure 7/X.82 represents the successful connection establishment several possible unsuccessful call attempts are shown in Figures 8/X.82 to 11/X.82.

#### 6.1.2.1 Call request packet

The called DTE address always includes a DNIC which may be transferred to the CSPDN.

The calling DTE address is stored and will be transferred later in the calling line identification signal, if requested by the called DTE.

##### 1) Network utilities

The transit network identification code shall not be transferred in the X.71 signalling, since DNICs cannot be signalled in X.71 in the forward direction.

The call identifier shall not be signalled in X.71.

If the received throughput class indication is greater than the data signalling on the circuit switched side, the value of the data signalling rate shall be returned. In all other cases the received value is returned.

The default values of 2 for window size, and 128 for packet size, shall apply for all calls. The use of other values is subject to bilateral agreement.

According to Recommendation T.70 terminals shall not use the fast select facility. the receipt of fast select indication shall result in sending a clear request packet.

The closed user group and closed user group with outgoing access are mapped to the corresponding signals in Recommendation X.71.

The transit delay indication cannot be signalled in Recommendation X.71.

##### 2) User facilities

For further study.

3) Call user data

The telematic protocol identifier as defined in Recommendation T.70 is mapped to the 2nd UC in Recommendation X.71 (all remaining information will get lost). When receiving other codes in the first octet of the call user data field of the call request packet of Recommendation X.75 the call attempt may either be rejected or continued.

*Note* - This reflects the status of Recommendation T.70. However, the transparency of the call user data field needs further consideration. Other possible mapping requirements e.g. to the class of traffic facility of Recommendation X.75 are for further study.

#### 6.1.2.2 Selection signals

1) First class-of-traffic character (1st COT)

"Alternative routing allowed" is signalled. The X.75 called DTE address may be passed unchanged to the CSPDN or the DNIC may be stripped.

*Note* - The X.75 addresses of the called and calling DTE always include a DNIC.

Bit 1 is set accordingly. Bit 1 = 0: DNIC included; Bit 1 = 1: DNIC not included. "UC follows" is indicated.

2) First user class character (1st UC)

1st UC is only used to indicate that the second class-of-traffic (2nd COT) character and second user class (2nd UC) character follows.

3) Second user class character (2nd UC)

When the first octet of the call user data field of the call request packet of Recommendation X.75 indicates Teletex by "0000010", this shall be mapped to "1001" in the bits b1 to b4 of the 2nd UC in Recommendation X.71. In cases of coding other than "0000010" the call attempt may either be rejected or continued.

*Note* - This reflects the status of Recommendation T.70. However, the transparency of the call user data field needs further consideration, Other possible mapping requirements e.g. to the class of traffic facility of Recommendation X.75 are for further study.

4) Second class-of-traffic (2nd COT)

Bits 1, 2 and 4 of the 2nd COT are always set to "0". Bit 3 is set according to the X.75 utilities received.

5) Third class-of-traffic character (3rd COT)

The third class-of-traffic character is not transmitted by the IWF T.70.

6) Closed user group (CUG)

See § 6.1.1.1, item 6).

7) Transit through connect signal (TTC)

The calling line identification is only signalled if it has been requested in the TTC signal. The transit centres through-connected (TTD) signal is sent in other cases.

#### 6.1.2.3 SABM command

The calling DTE uses address (B) in commands and (A) in responses, the called DTE uses address (A) in commands and (B) in responses, according to CCITT Recommendation T.70.

#### 6.1.2.4 Call connected packet

If any network or service identification signals are received that indicate transit networks, these are transferred in the Transit network identification network utility. The Throughput class is set according to the procedure described under "Network utilities" (see § 6.1.2.1, item 1)).

The time relation between "UA Response Frame" received and "Call Connected Packet" sent is for further study.

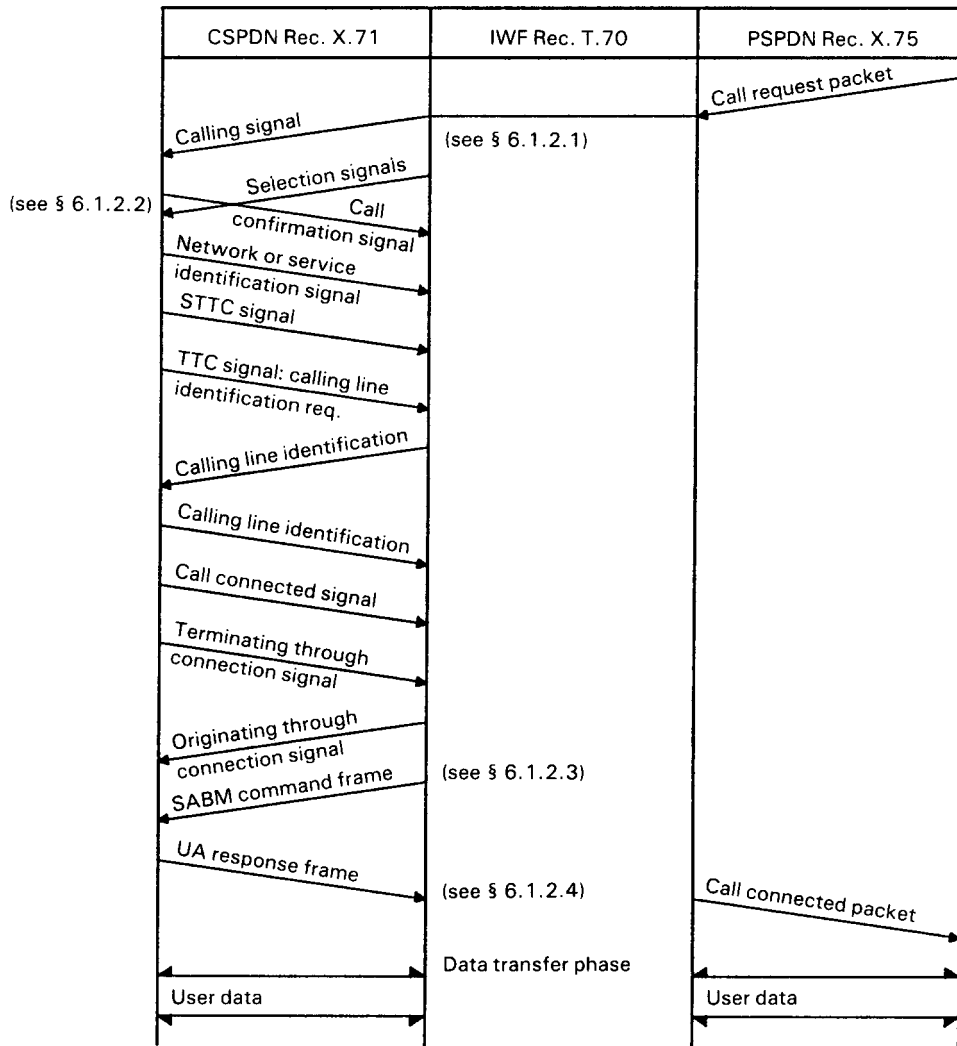

FIGURE 7/X.82

Successful connection establishment PSPDN → CSPDN

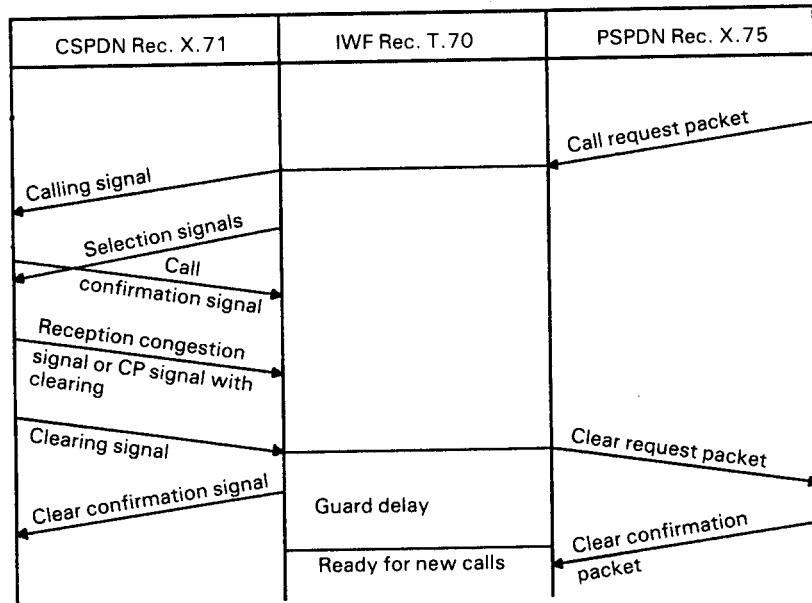

FIGURE 8/X.82

Unsuccessful connection establishment PSPDN → CSPDN  
(CSPDN or endsystem not available)

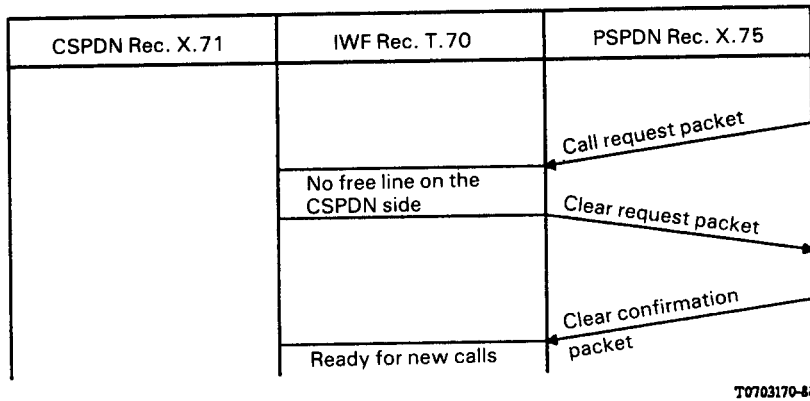
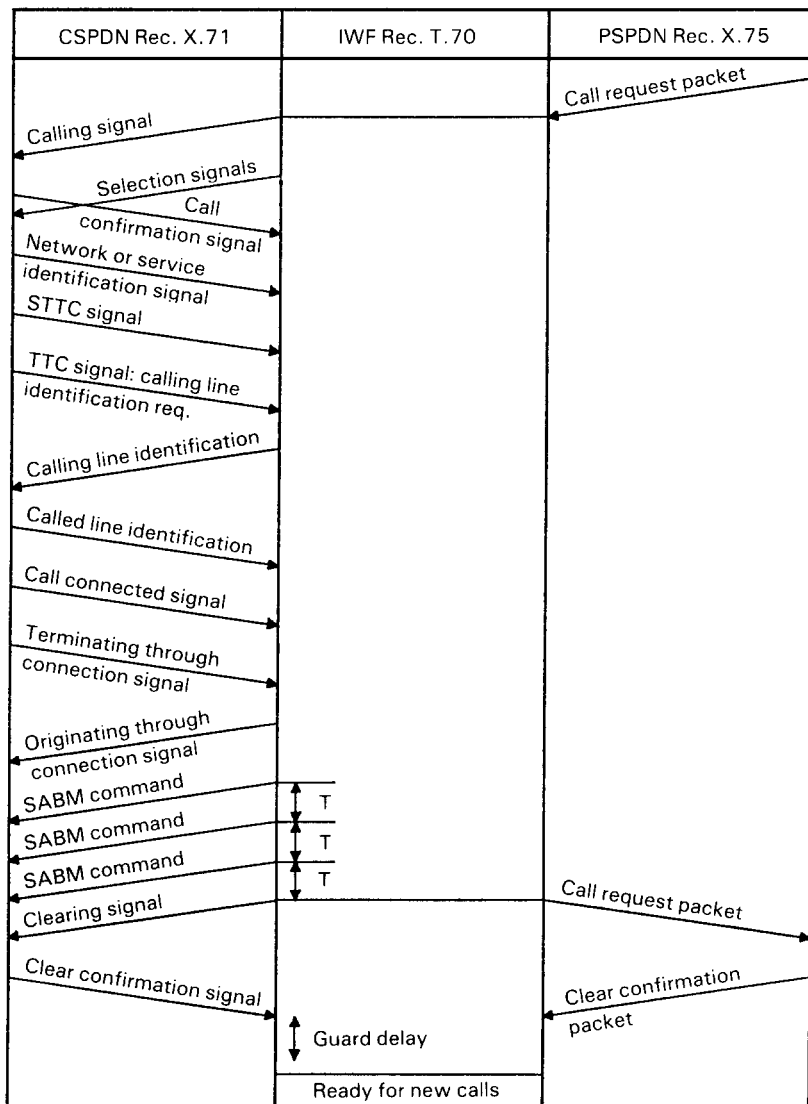

FIGURE 9/X.82

Unsuccessful connection establishment PSPDN → CSPDN  
(no free line on the CSPDN-side available)



T0703180-83

FIGURE 10/X.82

Unsuccessful connection establishment PSPDN → CSPDN  
(SABM command not answered)

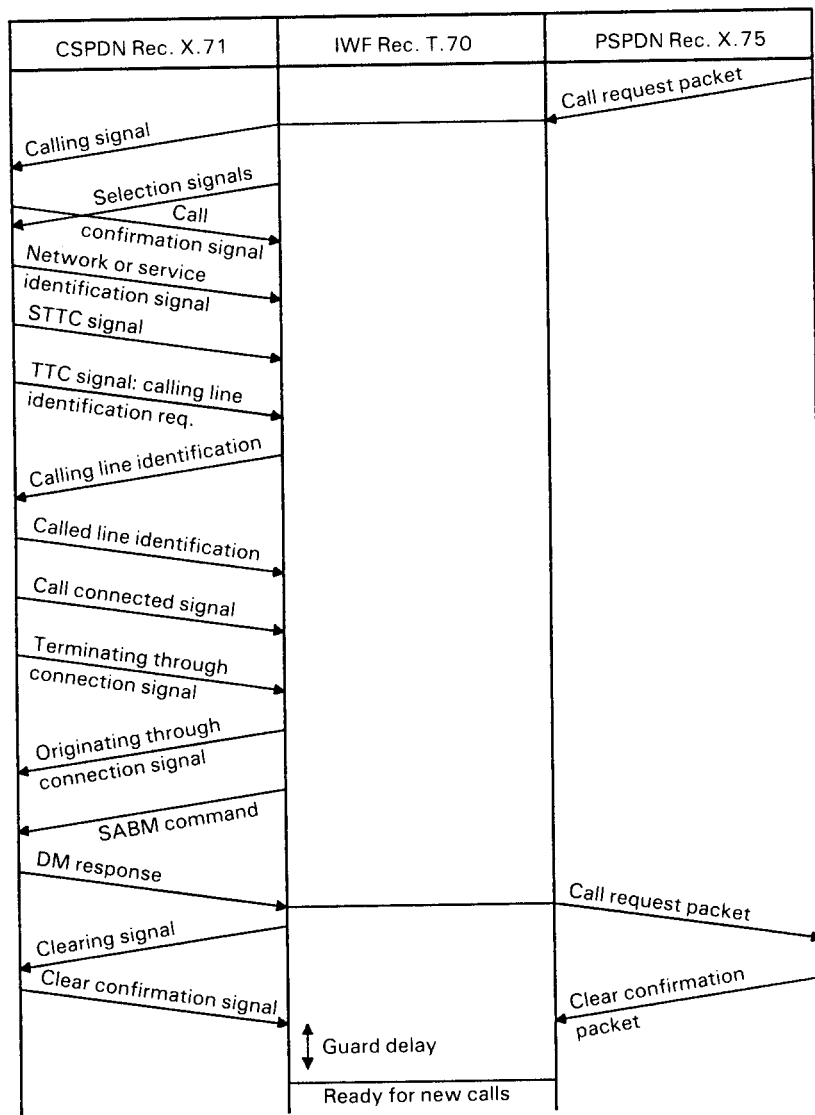

T0703190-88

FIGURE 11/X.82

Unsuccessful connection establishment PSPDN → CSPDN  
(SABM command answered with DM Response)

6.2 Connection release phase

6.2.1 Connection release initiated on the CSPDN-side (Figure 12/X.82)

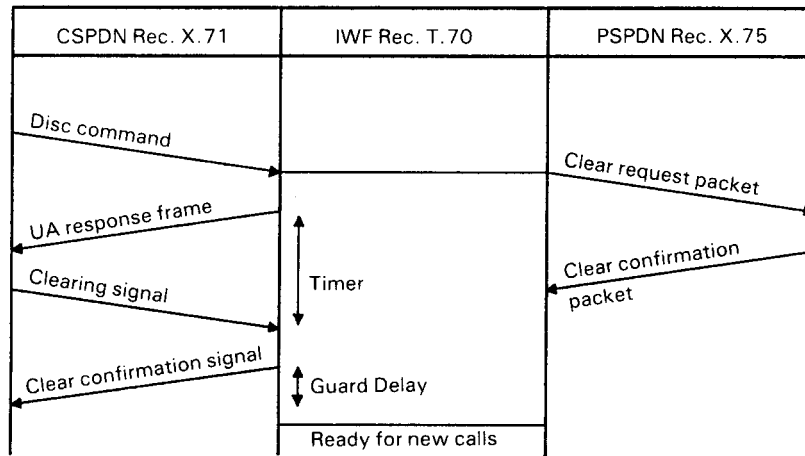

T0703200-88

a) Possibility 1

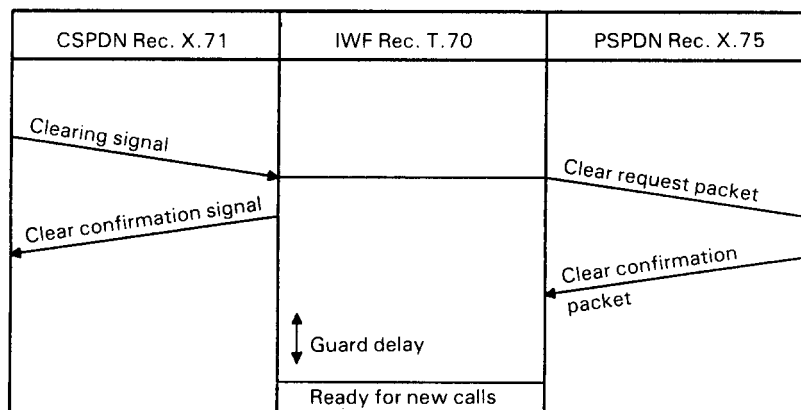

T0703210-88

b) Possibility 2

FIGURE 12/X.82

Connection Release initiated on the CSPDN-side



6.2.2 Connection release initiated on the PSPDN-side (Figure 13/X.82)

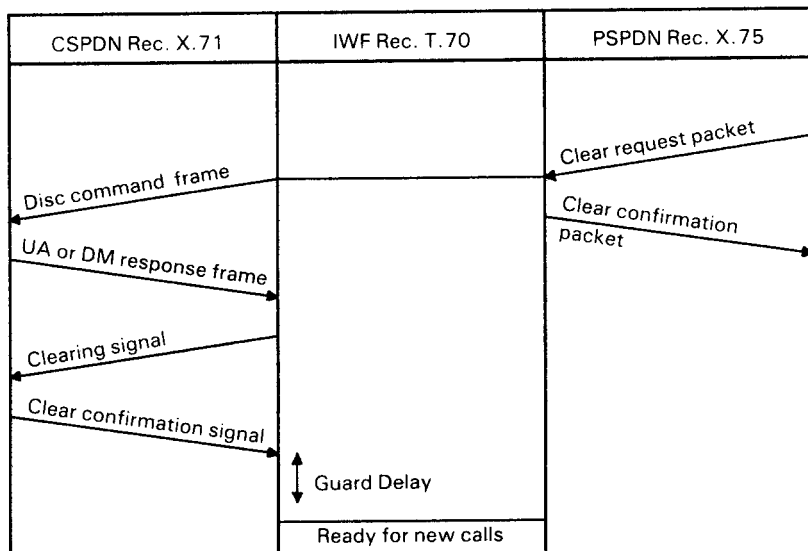

T0703220-88

a) Possibility 1

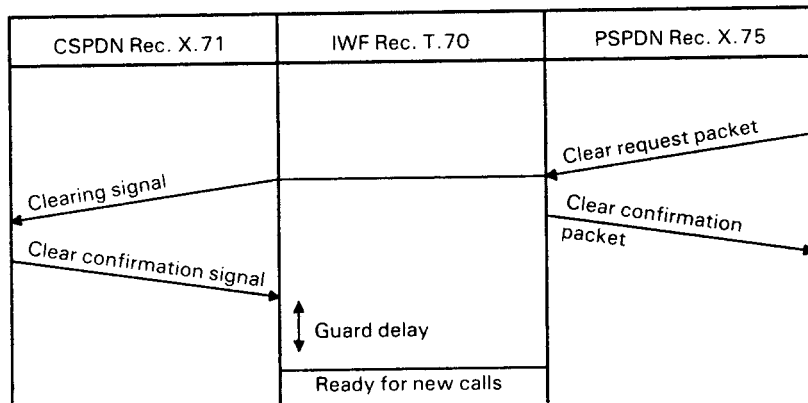

T0703230-88

b) Possibility 2

FIGURE 13/X.82

Connection Release initiated on the PSPDN-side

6.2.3 Connection release initiated by the IWF T70 (Figure 14/X.82)

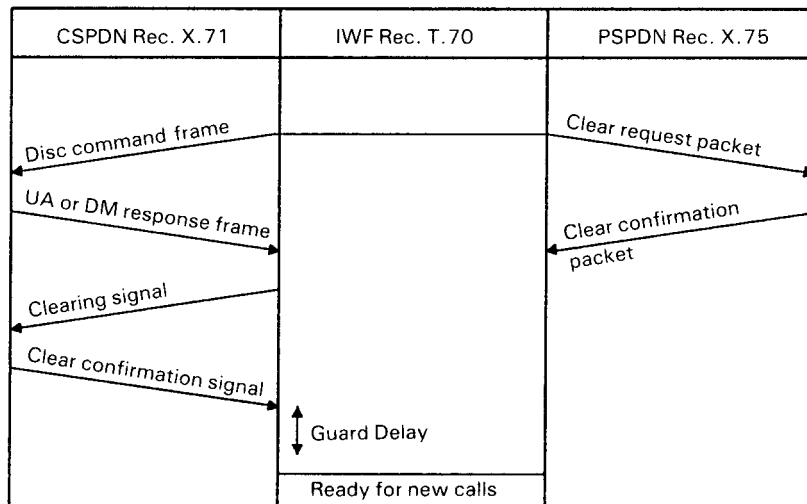

T0703240-88

a) Possibility 1

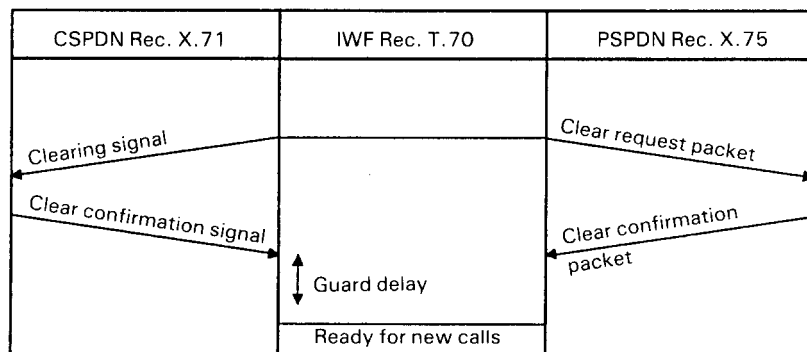

T0703250-88

b) Possibility 2

FIGURE 14/X.82

Connection Release initiated by the IWF T.70

### 6.3 Data transfer phase

#### 6.3.1 Handling of user data

The user data shall be transferred transparently from the user data field in the data packet on the packet switched side to the user data field in the network data block on the circuit switched side, and vice versa (see Figure 15/X.82).

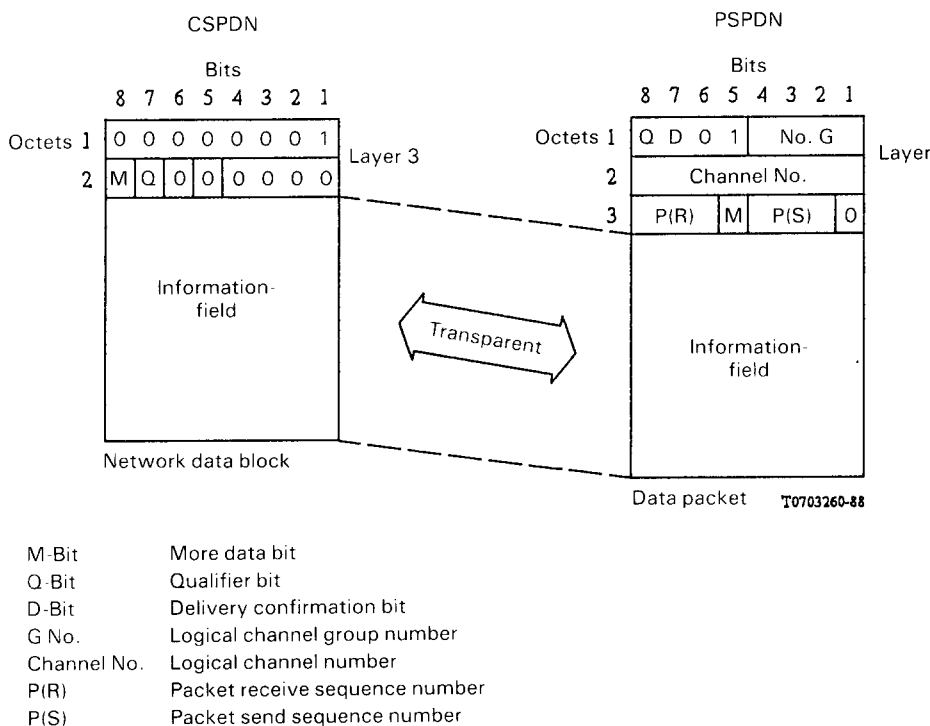

FIGURE 15/X.82

Data transfer phase

#### 6.3.2 Handling of Qualifier bit (Q-bit)

Independent from the value of the Q-Bit in an incoming data packet the IWF T.70 may

- a) use Q-bit = 0 in the corresponding outgoing network data block, and vice versa;
- b) transfer it transparently. This means that the value of the Q-bit in an incoming data packet shall be transferred in the corresponding outgoing network data block, and vice versa.

#### 6.3.3 Handling of Delivery confirmation bit (D-bit)

The D-bit in incoming Data Packets is ignored. The IWF T70 shall set the D-bit = 0 in outgoing Data Packets.

#### 6.3.4 Handling of More data bit (M-bit)

Network Data Blocks with more than 128 octets (up to 2048) are segmented into a Data Packet sequence with a number of octets in each Data Packet according to the selected value for the packet size. If the received M-bit of the last Data Packet in the sequence is set to 0. In all other cases the M-bit = 1.

Received Data Packets may be directly transferred in Network Data Blocks of the same size with the M-bit unchanged and transferred as one Network Data Block.

6.3.5 *Reset*

When a Reset request is received from the packet switched side this shall result in a disconnection of the link on the circuit switched side. After successful disconnection and setting up of the link again the reset is confirmed. The procedure is shown in Figure 16/X.82.

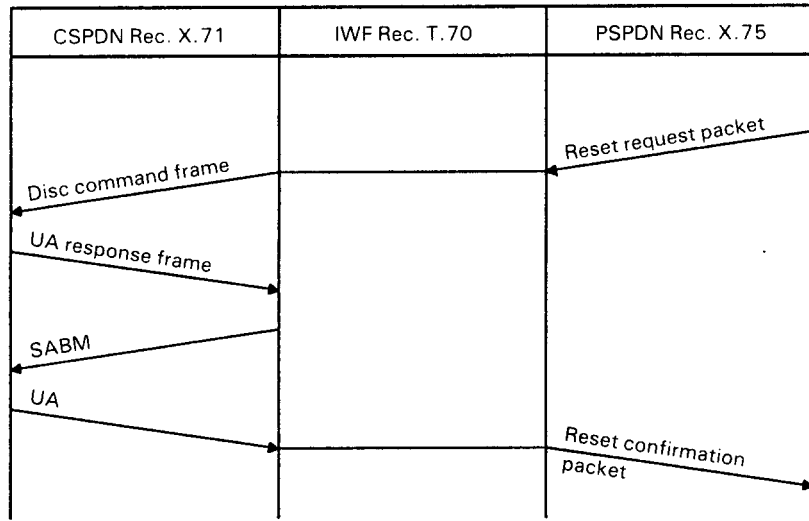

T0703270-88

FIGURE 16/X.82

**Reset**

**7 Restart request**

7.1 *Restart request initiated by the PSPDN*

An incoming Restart request packet from the packet switched side results in a clearing of all related circuits on the circuit switched side. This is described in Figure 17/X.82.

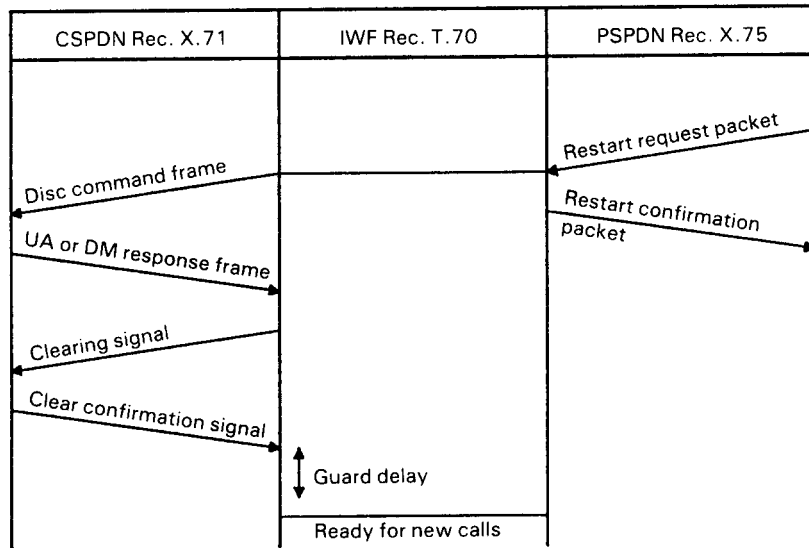

T0703220-88

FIGURE 17/X.82

**Restart Request initiated by the PSPDN**

7.2 Restart request initiated by the IWF T.70

The IWF T.70 may request a restart by clearing all circuit on the circuit switched side and sending Restart request on the packet switched side. This is shown in Figure 18/X.82.

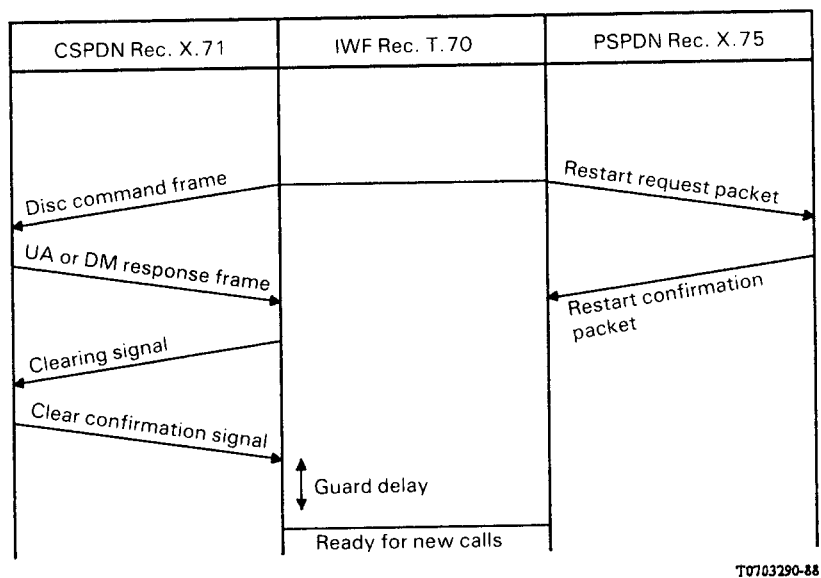

FIGURE 18/X.82

Restart Request initiated by the IWF T.70

APPENDIX I

(to Recommendation X.82)

Items in relationship to the OSI connection-mode network service

- 1) Connection establishment phase
  - Network address extension not supported
  - Receipt confirmation selection not supported (see Note 1)
  - Expedited data not supported (see Note 1)
  - QOS not supported (see Note 1)
  - NS user data not supported (see Note 2)
- 2) Data transfer phase
  - D-bit not supported (see Note 1)
- 3) Connection release phase
  - Network address extension not supported,
  - NS user data not supported (see Note 2).

Note 1 - NS provider options, when provided within a subnetwork, would lead to additional actions and events (i.e. receipt confirmation, EXPEDITED DATA transfer).

Note 2 - The objective is to make this parameter a mandatory parameter to be supported by all subnetworks in the future. However, a number of existing subnetworks cannot support it now. During the interim period, while these subnetworks exist and are not modified to provide this parameter, it is considered as a provider-option. No negotiation mechanism is needed in the connection-mode network service. Limiting, in some subnetworks, the length of NS-user-data to be provided to a value lower than 128 octets (e.g. 16 to 32 octets) for an interim period would imply fewer changes to existing interfaces and signalling systems and would simplify the introduction of such a service in existing subnetworks.