



INTERNATIONAL TELECOMMUNICATION UNION

ITU-T

TELECOMMUNICATION
STANDARDIZATION SECTOR
OF ITU

X.25

(10/96)

SERIES X: DATA NETWORKS AND OPEN SYSTEM
COMMUNICATION

Public data networks – Interfaces

**Interface between Data Terminal
Equipment (DTE) and Data Circuit-terminating
Equipment (DCE) for terminals operating in the
packet mode and connected to public data
networks by dedicated circuit**

ITU-T Recommendation X.25

(Previously "CCITT Recommendation")

ITU-T X-SERIES RECOMMENDATIONS
DATA NETWORKS AND OPEN SYSTEM COMMUNICATION

PUBLIC DATA NETWORKS	X.1-X.199
Services and facilities	X.1-X.19
Interfaces	X.20-X.49
Transmission, signalling and switching	X.50-X.89
Network aspects	X.90-X.149
Maintenance	X.150-X.179
Administrative arrangements	X.180-X.199
OPEN SYSTEM INTERCONNECTION	X.200-X.299
Model and notation	X.200-X.209
Service definitions	X.210-X.219
Connection-mode protocol specifications	X.220-X.229
Connectionless-mode protocol specification	X.230-X.239
PICS proformas	X.240-X.259
Protocol Identification	X.260-X.269
Security Protocols	X.270-X.279
Layer Managed Objects	X.280-X.289
Conformance testing	X.290-X.299
INTERWORKING BETWEEN NETWORKS	X.300-X.399
General	X.300-X.349
Satellite data transmission systems	X.350-X.399
MESSAGE HANDLING SYSTEMS	X.400-X.499
DIRECTORY	X.500-X.599
OSI NETWORKING AND SYSTEM ASPECTS	X.600-X.699
Networking	X.600-X.629
Efficiency	X.630-X.649
Naming, Addressing and Registration	X.650-X.679
Abstract Syntax Notation One (ASN.1)	X.680-X.699
OSI MANAGEMENT	X.700-X.799
Systems Management framework and architecture	X.700-X.709
Management Communication Service and Protocol	X.710-X.719
Structure of Management Information	X.720-X.729
Management functions	X.730-X.799
SECURITY	X.800-X.849
OSI APPLICATIONS	X.850-X.899
Commitment, Concurrency and Recovery	X.850-X.859
Transaction processing	X.860-X.879
Remote operations	X.880-X.899
OPEN DISTRIBUTED PROCESSING	X.900-X.999

For further details, please refer to ITU-T List of Recommendations.

FOREWORD

The ITU-T (Telecommunication Standardization Sector) is a permanent organ of the International Telecommunication Union (ITU). The ITU-T is responsible for studying technical, operating and tariff questions and issuing Recommendations on them with a view to standardizing telecommunications on a worldwide basis.

The World Telecommunication Standardization Conference (WTSC), which meets every four years, establishes the topics for study by the ITU-T Study Groups which, in their turn, produce Recommendations on these topics.

The approval of Recommendations by the Members of the ITU-T is covered by the procedure laid down in WTSC Resolution No. 1 (Helsinki, March 1-12, 1993).

ITU-T Recommendation X.25 was revised by ITU-T Study Group 7 (1993-1996) and was approved under the WTSC Resolution No. 1 procedure on the 5th of October 1996.

NOTE

In this Recommendation, the expression "Administration" is used for conciseness to indicate both a telecommunication administration and a recognized operating agency.

© ITU 1997

All rights reserved. No part of this publication may be reproduced or utilized in any form or by any means, electronic or mechanical, including photocopying and microfilm, without permission in writing from the ITU.

CONTENTS

	<i>Page</i>
1 DTE/DCE interface characteristics (physical layer).....	2
1.1 X.21 interface.....	2
1.2 X.21 <i>bis</i> interface.....	3
1.3 V-Series interface.....	4
1.4 X.31 interface.....	4
2 Link access procedures across the DTE/DCE interface.....	4
2.1 Scope and field of applications.....	4
2.2 Framing aspects.....	5
2.3 LAPB elements of procedures.....	9
2.4 Description of the LAPB procedure.....	23
2.5 MultiLink Procedure (MLP) (Subscription-time selectable option).....	35
3 Description of the packet layer DTE/DCE interface.....	45
3.1 Logical channels.....	45
3.2 Basic structure of packets.....	45
3.3 Procedure for restart.....	45
3.4 Error handling.....	47
4 Procedures for virtual circuit services.....	47
4.1 Procedures for virtual call service.....	47
4.2 Procedures for permanent virtual circuit service.....	49
4.3 Procedures for data and interrupt transfer.....	49
4.4 Procedures for flow control.....	52
4.5 Effects of clear, reset and restart procedures on the transfer of packets.....	56
4.6 Effects of the physical layer and the data link layer on the packet layer.....	57
5 Packet formats.....	58
5.1 General.....	58
5.2 Call set-up and clearing packets.....	60
5.3 Data and interrupt packets.....	74
5.4 Flow control and reset packets.....	74
5.5 Restart packets.....	82
5.6 Diagnostic packet.....	84
5.7 Packets required for optional user facilities.....	86
6 Procedures for optional user facilities (packet layer).....	86
6.1 TOA/NPI address subscription.....	86
6.2 Extended and super extended packet sequence numbering facilities.....	86
6.3 D-bit modification.....	88
6.4 Packet retransmission.....	88
6.5 Incoming calls barred.....	88
6.6 Outgoing calls barred.....	89
6.7 One-way logical channel outgoing.....	89
6.8 One-way logical channel incoming.....	89
6.9 Non-standard default packet sizes.....	89
6.10 Non-standard default window sizes.....	89
6.11 Default throughput classes assignment.....	90
6.12 Flow control parameter negotiation.....	90
6.13 Throughput class negotiation facilities.....	91
6.14 Closed user group related facilities.....	92
6.15 Bilateral closed user group related facilities.....	95

	<i>Page</i>	
6.16	Fast select.....	98
6.17	Fast select acceptance	98
6.18	Reverse charging.....	98
6.19	Reverse charging acceptance	98
6.20	Local charging prevention.....	98
6.21	Network User Identification (NUI) related facilities	99
6.22	Charging information	100
6.23	ROA related facilities.....	100
6.24	Hunt group	100
6.25	Call redirection and call deflection related facilities.....	101
6.26	Called line address modified notification.....	104
6.27	Transit delay selection and indication	104
6.28	Alternative addressing related facilities	105
7	Formats for facility fields	107
7.1	General	107
7.2	Coding of the facility code fields	109
7.3	Coding of the facility parameter fields.....	109
	Annex A – Range of logical channels used for virtual calls and permanent virtual circuits	119
	Annex B – Packet layer DTE/DCE interface state diagrams	121
	B.1 Symbol definition of the state diagrams.....	121
	B.2 Order definition of the state diagrams.....	121
	Annex C – Actions taken by the DCE on receipt of packets in a given state of the packet layer DTE/DCE interface as perceived by the DCE.....	124
	Annex D – Packet layer DCE time-outs and DTE time-limits.....	134
	D.1 DCE time-outs.....	134
	D.2 DTE time-limits.....	134
	Annex E – Coding of X.25 network generated diagnostic fields in clear, reset and restart indication, and diagnostic packets.....	137
	Annex F – Subscription-time optional user facilities that may be associated with a network user identifier in conjunction with the NUI override facility.....	139
	Annex G – ITU-T specified DTE facilities to support the OSI Network service and other purposes	140
	G.1 Introduction.....	140
	G.2 Coding of the facility code fields	140
	G.3 Coding of the facility parameter field	140
	Appendix I – Examples of data link layer transmitted bit patterns by the DCE and the DTE	145
	Appendix II – An explanation of how the values for N1 in 2.4.9.5 are derived	146
	II.1 DTE N1	146
	II.2 DCE N1.....	146
	II.3 General DCE N1 calculations	147
	Appendix III – Examples of multilink resetting procedures	149
	III.1 Introduction.....	149
	III.2 MLP reset initiated by either the DCE or the DTE	149
	III.3 MLP reset initiated by both the DCE and the DTE simultaneously.....	150
	Appendix IV – Information on addresses in call set-up and clearing packets	150
	IV.1 Main address and complementary address	150
	IV.2 Addresses in call request packet	151
	IV.3 Addresses in incoming call packets	151
	IV.4 Addresses in call accepted packets.....	152
	IV.5 Addresses in call connected packets	152
	IV.6 Addresses in clear request packets	153
	IV.7 Addresses in clear indication packets.....	153

	<i>Page</i>
IV.8 Addresses in clear confirmation packets	153
IV.9 Addresses in call redirection and call deflection related facilities	153
Appendix V – Guidelines for transmission over channels with long round trip delay and/or transmission rates higher than 64 000 bit/s	153
V.1 Preamble.....	153
V.2 Common guidelines	154
V.3 Guidelines for channels with long round trip delays operating at 64 000 bit/s.....	154
V.4 Guidelines for circuits with long round trip delays operating at 1920 kbit/s	155
Appendix VI – Format for NUI parameter field.....	155
Appendix VII – Examples of the use of multi-selective reject option	157

SUMMARY

This Recommendation specifies the protocol to be used between a Data Terminal Equipment (DTE) and a Packet Switched Public Data Network (PSPDN), when the access is made by a dedicated circuit. In reference to the OSI model, three layers are described: the physical layer, the data link layer and the packet layer. The service offered is compliant with the OSI network service and permits the transmission of data without loss nor duplication. The access speeds and the throughputs may go up to 2 Mbit/s.

Recommendation X.25

INTERFACE BETWEEN DATA TERMINAL EQUIPMENT (DTE) AND DATA CIRCUIT-TERMINATING EQUIPMENT (DCE) FOR TERMINALS OPERATING IN THE PACKET MODE AND CONNECTED TO PUBLIC DATA NETWORKS BY DEDICATED CIRCUIT

(Geneva, 1976; amended at Geneva, 1980;
Malaga-Torremolinos, 1984; Melbourne, 1988; Helsinki 1993;
revised in 1996)

The establishment in various countries of public data networks providing packet switched data transmission services creates a need to produce standards to facilitate international interworking.

The ITU-T,

considering

- (a) that Recommendation X.1 includes specific user classes of service for data terminal equipments operating in the packet mode, defines categories of access, Recommendation X.2 defines user facilities, Recommendations X.21 and X.21 *bis* define DTE/DCE physical layer interface characteristics, Recommendation X.92 defines the hypothetical reference connections for packet switched data transmission service and Recommendation X.96 defines *call progress* signals;
- (b) that data terminal equipments operating in the packet mode will send and receive network control information in the form of packets;
- (c) that certain data terminal equipments operating in the packet mode will use a packet interleaved synchronous data circuit;
- (d) the desirability of being able to use a single data circuit to a Data Switching Exchange (DSE) for all user facilities;
- (e) that Recommendation X.2 specifies which of the various data transmission services and optional user facilities described in this Recommendation are “essential” and have thus to be made available internationally, and which are not;
- (f) the need for defining an international Recommendation for the exchange between DTE and DCE of control information for the use of packet switched data transmission services;
- (g) that this definition is made in Recommendation X.32 with regard to the access through a public switched telephone network, an Integrated Services Digital Network (ISDN), or a circuit switched public data network;
- (h) that Recommendation X.31 defines the support of packet-mode terminal equipment by an Integrated Services Digital Network (ISDN);
- (i) that, when this Recommendation is used to support the Network Service defined in Recommendation X.213 | ISO/IEC 8348, the physical, data link and packet layers correspond to the Physical, Data link and Network Layers respectively, as defined in Recommendation X.200;
- (j) that this Recommendation includes all the features necessary to support the services included in Recommendation X.213 | ISO/IEC 8348 as well as other features; that Recommendation X.223 defines the use of X.25 packet layer protocol to provide the OSI connection mode Network service;
- (k) that the necessary elements for an interface Recommendation should be defined independently as:
 - *Physical layer*: The mechanical, electrical, functional and procedural characteristics to activate, maintain and deactivate the physical link between the DTE and the DCE;
 - *Data link layer*: The link access procedure for data interchange across the link between the DTE and the DCE;
 - *Packet layer*: The packet format and control procedures for the exchange of packets containing control information and user data between the DTE and the DCE,

unanimously declares

that for public data networks accessed via dedicated circuits by data terminal equipments operating in the packet mode:

- (1) the mechanical, electrical, functional and procedural characteristics to activate, maintain and deactivate the physical link between the DTE and the DCE should be as specified in clause 1 below, *DTE/DCE interface characteristics*;
- (2) the link access procedure for data interchange across the link between the DTE and the DCE should be as specified in clause 2 below, *Link access procedure across the DTE/DCE interface*;
- (3) the packet layer procedures for the exchange of control information and user data at the DTE/DCE interface should be as specified in clause 3 below, *Description of the packet layer DTE/DCE interface*;
- (4) the procedures for virtual call and permanent virtual circuit services should be as specified in clause 4 below, *Procedures for virtual circuit services*;
- (5) the format for packets exchanged between the DTE and the DCE should be as specified in clause 5 below, *Packet formats*;
- (6) the procedures for optional user facilities should be as specified in clause 6 below, *Procedures for optional user facilities*;
- (7) the formats for optional user facilities should be as specified in clause 7 below, *Formats for facility fields*.

NOTE – This Recommendation fully specifies the behaviour of the DCE. In addition, a minimum set of requirements is specified for the DTE. Additional guidance for the design of DTEs is available in ISO standards: ISO 7776 (data link layer) and ISO/IEC 8208 (packet layer). It is not required by this Recommendation that these ISO/IEC standards be used. If using these ISO standards, note must be taken that their scope is expanded beyond that of just interfacing with packet switched public data networks.

It should also be noted that this Recommendation uses the term DTE to refer to the equipment to which the DCE interfaces. In ISO/IEC 8208, distinction is made between a DTE and a packet switched private data network, which are both considered as DTEs in this Recommendation.

Finally, the procedures in this Recommendation may be selected for use for cases other than packet-mode operation when accessing a Public Data Network by dedicated circuit. In such cases, it may not be possible nor necessary to apply the capabilities in this Recommendation exactly as defined herein. For example, the procedures for layer 2 addressing in clause 2 or for optional user facilities in clause 6 may need to be modified for the specific environment. One case where this approach has been adopted is ISO/IEC 8881 (where only use of the packet layer procedures has been adopted with a few enhancements to the optional user facilities for use on a local area network). Another case is where this Recommendation is applied to the interface between a Packet Switched Public Data Network and a Packet Switched Private Data Network and the goal is to provide a global transparent service for DTEs on both networks. In this case, the issues on addressing, and optional user facilities need to be properly resolved; Recommendation X.327 provides a framework for this resolution.

1 DTE/DCE interface characteristics (physical layer)

Administrations may offer one or more of the interfaces specified below. The exact use of the relevant points in these Recommendations is detailed below.

1.1 X.21 interface

1.1.1 DTE/DCE physical interface elements

The DTE/DCE physical interface elements shall be according to 2.1/X.21 through 2.5/X.21.

1.1.2 Procedures for entering operational phases

The procedures for entering operational phases shall be as described in 5.2/X.21. The data exchanged on circuits T and R when the interface is in states 13S, 13R and 13 of Figure A.3/X.21 will be as described in subsequent subclauses of this Recommendation.

The *not ready* states given in 2.5/X.21 are considered to be *non-operational* states and may be considered by the higher layers to be *out of order* states (see 4.6 below).

1.1.3 Failure detection and test loops

The failure detection principles shall be according to 2.6/X.21. In addition, $i = \text{OFF}$ may be signalled due to momentary transmission failures. Higher layers may delay for several seconds before considering the interface to be out of order.

The definitions of test loops and the principles of maintenance testing using the test loops are provided in Recommendation X.150.

A description of the test loops and the procedures for their use is given in clause 7/X.21.

Automatic activation by a DTE of a test loop 2 in the DCE at the remote terminal is not possible. However, some Administrations may permit the DTE to control the equivalent of a test loop 2, at the local DSE, to verify the operation of the leased line or subscriber line and/or all or part of the DCE or line terminating equipment. Control of the loop, if provided, may be either manual or automatic, as described in Recommendations X.150 and X.21 respectively.

1.1.4 Signal element timing

Signal element timing shall be in accordance with 2.6.3/X.21.

1.2 X.21 bis interface

1.2.1 DTE/DCE physical interface elements

The DTE/DCE physical interface elements shall be according to 1.2/X.21 *bis*.

1.2.2 Operational phases

When circuit 107 is in the ON condition, and circuits 105, 106, 108 and 109, if provided, are in the ON condition, data exchange on circuits 103 and 104 will be as described in subsequent subclauses of this Recommendation.

When circuit 107 is in the OFF condition, or any of circuits 105, 106, 108 or 109, if provided, are in the OFF condition, this is considered to be in a *non-operational* state, and may be considered by the higher layers to be in an *out of order* state (see 4.6 below).

1.2.3 Failure detection and test loops

The failure detection principles, the description of test loops and the procedures for their use shall be according to 3.1/X.21 *bis* through 3.3/X.21 *bis*. In addition, circuits 106 and 109 may enter the OFF condition due to momentary transmission failures. Higher layers may delay for several seconds before considering the interface to be out of order.

Automatic activation by a DTE of test loop 2 in the DCE at the remote terminal is not possible. However, some Administrations may permit the DTE to control the equivalent of a test loop 2, at the local DSE, to verify the operation of the leased line or subscriber line and/or all or part of the DCE or line terminating equipment. Control of the loop, if provided, may be either manual or automatic, as described in Recommendations X.150 and X.21 *bis* respectively.

1.2.4 Signal element timing

Signal element timing shall be in accordance with 3.4/X.21 *bis*.

1.3 V-Series interface

General operation with V-Series modems is as described in 1.2 above. However, for specific details, particularly related to failure detection principles, loop testing, and the use of circuits 107, 109, 113 and 114, refer to the appropriate V-Series Recommendations.

The delay between 105-ON and 106-ON (when these circuits are present) will be more than 10 ms and less than 1s. In addition, circuits 106 or 109 may enter the OFF condition due to momentary transmission failures or modem retraining. Higher layers may delay for several seconds before considering the interface to be out of order.

1.4 X.31 interface

1.4.1 DTE/DCE physical interface

The DTE/DCE physical interface shall coincide with the R reference point between the DTE and the Terminal Adaptor (TA). The purpose of the TA is to allow the operation of a DTE over an ISDN. The functionalities of such a TA when accessing a packet switched data transmission service through a semi-permanent ISDN connection (i.e. a non-switched B-channel) are described in clause 7/X.31.

NOTES

1 This type of access is considered a dedicated access to a public switched data transmission service. Non-dedicated access to a public switched data transmission service is defined in Recommendations X.32 and X.31.

2 The DTE and the TA functionalities may be implemented in the same piece of equipment in the case of a packet mode terminal TE1 conforming to the I-Series Recommendations. In this case, this Recommendation covers layer 2 and layer 3 operation on the semi-permanent B-channel.

1.4.2 Operational phases

The operational phases are as described in clause 7/X.31.

1.4.3 Maintenance

The maintenance shall be made as described in 7.6/X.31.

1.4.4 Synchronization

The synchronization shall be made as described in clause 7/X.31.

2 Link access procedures across the DTE/DCE interface

2.1 Scope and field of applications

2.1.1 The Link Access Procedures (LAPB) are described as the Data Link Layer Element and are used for data interchange between a DCE and a DTE over a single physical circuit, or optionally over multiple physical circuits, operating in user classes of service 8 to 11, 26, 30 to 33, 35, 37, 45, 53 and 59 as indicated in Recommendation X.1. The optional, subscription-time selectable, multiple physical circuit operation (known as multilink operation) is required if the effects of circuit failures are not to disrupt the Packet Layer operation.

The Single Link Procedures (SLPs) described in 2.2, 2.3 and 2.4 (LAPB) are used for data interchange over a single physical circuit, conforming to the description given in clause 1, between a DTE and a DCE. When the optional multilink operation is employed, a Single Link Procedure (SLP) is used independently on each physical circuit, and the MultiLink Procedure (MLP) described in 2.5 is used for data interchange over these multiple parallel LAPB data links. In addition, when only a single physical circuit is employed with LAPB, agreements may be made with the Administration to use this optional multilink procedure over the one LAPB data link.

2.1.2 The Single Link Procedures (SLPs) use the principles and terminology of the High-level Data Link Control (HDLC) procedures specified by the International Organization for Standardization (ISO)/International Electrotechnical Commission (IEC). The multilink procedure (MLP) is based on the principles and terminology of the Multilink Control Procedures specified by ISO/IEC.

2.1.3 Each transmission facility is duplex.

2.1.4 DCE compatibility of operation with the HDLC balanced classes (class BA) of procedure is achieved using the LAPB procedure described in 2.2, 2.3 and 2.4. Class BA with options 2, 8 is the basic service (LAPB synchronous modulo 8), and is available in all networks.

Class BA 2, 8, with the addition of option 10.1 (LAPB synchronous modulo 128) is recognized as an optional, subscription-time selectable, extended sequence numbering service that may be available in those networks wishing to serve DTE applications having a need for modulo 128 sequence numbering. When HDLC option 10.1 is added, option 3.3 (SREJ) may be used to replace option 2 (REJ). If option 3.3 is used, option 2 shall not be used. This replacement of option 2 with option 3.3 is an optional subscription time selectable service.

Class BA 3.3, 8, with the addition of option 10.2 (LAPB synchronous modulo 32 768) is recognized as an optional, subscription-time selectable, super sequence numbering service that may be available in those networks wishing to serve DTE applications having a need for modulo 32 768 sequence numbering and multi-selective reject recovery.

The relationship between the sequence number and recovery is:

	Basic (modulo 8)	Extended (modulo 128)	Super (modulo 32 768)
REJ recovery (2.3.5.2.1)	Mandatory	Subscription-time option (Note)	Prohibited
SREJ recovery (2.3.5.2.2)	Prohibited	Subscription-time option (Note)	Mandatory
NOTE – If SREJ recovery is used, REJ recovery shall not be used.			

HDLC option 15.1 can be added to either Class BA 2, 8 or Class BA 2, 8, 10.1 or Class BA 3.3, 8, 10.1 to replace synchronous transmission with start/stop transmission. This addition is an optional, subscription-time selectable service that may be available in those networks wishing to serve DTEs using start/stop transmission.

DTE manufacturers and implementors must be aware that the procedure hereunder described as LAPB synchronous transmission modulo 8 will be the only one available in all networks.

NOTE – Some networks may continue to support another data link layer procedure, called LAP. The specification concerning LAP has not been modified since 1988. It is planned that all future enhancements to this Recommendation be based on LAPB. No changes or enhancements are planned for LAP. As such, details of LAP may be found in the 1988 *Blue Book Series Recommendations* under Recommendation X.25 (see 2.1.6, 2.2, 2.6 and 2.7).

2.1.5 For those networks that choose to support the basic service (LAPB synchronous transmission, modulo 8) and at least one of the extended LAPB sequence numbering, SREJ recovery and/or start/stop transmission options, the choice of basic mode or addition of these options is made at subscription time. The choice of capabilities for each data link procedure is independent of all others. The choice of extended LAPB sequence numbering is independent of the mode for the corresponding Packet Layer procedures. All choices are matters for agreement for a period of time with the Administration.

2.2 Framing aspects

2.2.1 Flag sequence

All frames shall start and end with the flag sequence consisting of one 0 bit followed by six contiguous 1 bits and one 0 bit. The DTE and DCE shall only send complete eight-bit flag sequences when sending multiple flag sequences (see 2.2.4). A single flag may be used as both the closing flag for one frame and the opening flag for the next frame.

2.2.2 Transparency

2.2.2.1 Synchronous transmission

The DCE or DTE, when transmitting, shall examine the frame content between the two flag sequences including the address, control, information and FCS fields and shall insert a 0 bit after all sequences of 5 contiguous 1 bits (including the last 5 bits of the FCS) to ensure that a flag sequence is not simulated. The DCE or DTE, when receiving, shall examine the frame content and shall discard any 0 bit which directly follows 5 contiguous 1 bits.

2.2.2.2 Start/stop transmission

The control escape octet identifies an octet occurring within a frame to which the following transparency procedure is applied. The encoding of the control escape octet is:

```

Bit order of transmission    1 2 3 4 5 6 7 8
                             1 0 1 1 1 1 1 0
    
```

The DCE or DTE, when transmitting, shall examine the frame content between the two flag sequences including the address, control information and FCS fields and, following completion of the FCS calculation, shall:

- 1) upon the occurrence of a flag or a control escape octet, complement data bit 6; and
- 2) insert a control escape octet immediately preceding the octet resulting from the above prior to transmission.

The DCE or DTE, when receiving, shall examine the frame content between the two flag sequences and shall, upon receipt of a control escape octet and prior to FCS calculation:

- a) discard the control escape octet; and
- b) restore the immediately following octet by complementing data bit 6.

NOTE – Other octet values may optionally be included in the transparency procedure by the transmitter. Such inclusion is for further study/standardization.

2.2.3 Transmission considerations

2.2.3.1 Order of bit transmission

Addresses, commands, responses and sequence numbers shall be transmitted with the low-order bit first (for example, the first bit of the sequence number that is transmitted shall have the weight 2^0). The order of transmitting bits within the information field is not specified under clause 2. The FCS shall be transmitted to the line commencing with the coefficient of the highest term, which is found in bit position 16 of the FCS field (see Tables 2-1, 2-2 and 2-3).

NOTE – In Tables 2-1 to 2-9, bit 1 is defined as the low-order bit.

2.2.3.2 Start/stop transmission

For start/stop transmission, each octet is delimited by a start bit and a stop bit. Mark-hold (continuous logical 1 condition) is used for inter-octet time fill if required. Typical octet transmission is as shown in Figure 2-1. The DTE or DCE, when receiving a frame, shall examine its contents and shall discard its start and stop bits and the 1s inserted as inter-octet time fill.

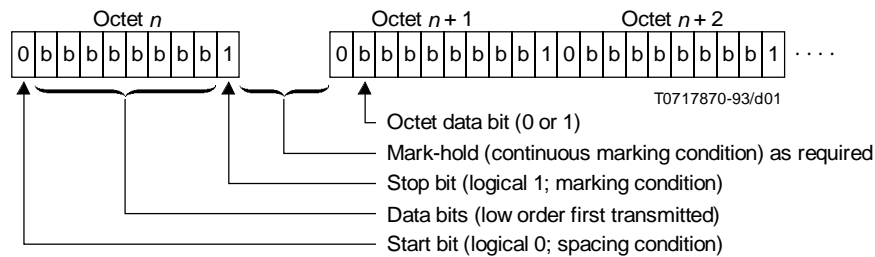

FIGURE 2-1/X.25

Typical octet transmission (start/stop transmission)

2.2.4 Interframe time fill

Interframe time fill is accomplished by transmitting contiguous flags between frames (see 2.2.1).

2.2.5 Intraframe time fill

2.2.5.1 Synchronous transmission

There is no provision for time fill within a frame when using synchronous transmission.

2.2.5.2 Start/stop transmission

In start/stop transmission, this is the sequence transmitted within a frame when the next octet is not available for contiguous transmission immediately following the preceding octet.

Inter-octet time fill is accomplished by transmitting continuous mark-hold condition (logical 1 state) (see 2.2.3.2 above). There is no provision for time fill within an octet (i.e. between the start bit and stop bit).

2.2.6 Link channel states

A link channel as defined here is the means for transmission for one direction.

2.2.6.1 Active channel state

The DCE incoming or outgoing channel is defined to be in an active condition when it is receiving or transmitting, respectively, a frame, an abortion sequence, or (for start/stop transmission only) interframe time fill.

2.2.6.2 Idle channel state

The DCE incoming or outgoing channel is defined to be in an idle condition when it is receiving or transmitting, respectively, a continuous 1s state for a period of time.

See 2.3.5.5 for a description of DCE action when an idle condition exists on its incoming channel for an excessive period of time.

2.2.6.2.1 Synchronous transmission

For synchronous transmission, an idle channel state exists when the continuous 1s state persists for at least 15 bit times.

2.2.6.2.2 Start/stop transmission

For start/stop transmission, an idle channel state exists when the continuous 1s state persists for at least *xxx* bit times (*xxx* is for further study but must be longer than reasonable values for intraframe time fill).

2.2.7 Frame structure

All transmissions on an SLP are in frames conforming to one of the formats of Table 2-1 for basic (modulo 8) operation, or alternatively one of the formats of Table 2-2 for extended (modulo 128) operation or alternatively one the formats of Table 2-3 for super (modulo 32 768) operation. The flag preceding the address field is defined as the opening flag. The flag following the FCS field is defined as the closing flag. These frame formats do not include bits (synchronous transmission) or octets (asynchronous transmission) inserted for transparency (see 2.2.2) nor bits inserted for transmission timing (i.e. start or stop bits).

2.2.7.1 Address field

The address field shall consist of one octet. The address field identifies the intended receiver of a command frame and the transmitter of a response frame. The coding of the address field is described in 2.4.2 below.

2.2.7.2 Control field

For modulo 8 (basic) operation, the control field shall consist of one octet. For modulo 128 (extended) operation, the control field shall consist of two octets for frame formats that contain sequence numbers, and one octet for frame formats that do not contain sequence numbers. For modulo 32 768 (super) operation, the control field shall consist of four octets for frame formats that contain sequence numbers, and one octet for frame formats that do not contain sequence numbers. The content of this field is described in 2.3.2 below.

TABLE 2-1/X.25

Frame formats – Basic (modulo 8) operation

Bit order of transmission	12345678	12345678	12345678	16 to 1	12345678	
	Flag	Address	Control	FCS	Flag	
	F 01111110	A 8 bits	C 8 bits	FCS 16 bits	F 01111110	
Bit order of transmission	12345678	12345678	12345678	16 to 1	12345678	
	Flag	Address	Control	Information	FCS	Flag
	F 01111110	A 8 bits	C 8 bits	Info N bits	FCS 16 bits	F 01111110
FCS Frame Check Sequence						

TABLE 2-2/X.25

Frame formats – Extended (modulo 128) operation

Bit order of transmission	12345678	12345678	1 to a)	16 to 1	12345678	
	Flag	Address	Control	FCS	Flag	
	F 01111110	A 8 bits	C bits a)	FCS 16 bits	F 01111110	
Bit order of transmission	12345678	12345678	1 to a)	16 to 1	12345678	
	Flag	Address	Control	Information	FCS	Flag
	F 01111110	A 8 bits	C bits a)	Info N bits	FCS 16 bits	F 01111110
FCS Frame Check Sequence						
a) 16 for frame formats that contain sequence numbers; 8 for frame formats that do not contain sequence numbers.						

TABLE 2-3/X.25

Frame formats – Super (modulo 32 768) operation

Bit order of transmission	12345678	12345678	1 to a)	16 to 1	12345678	
	Flag	Address	Control	FCS	Flag	
	F 01111110	A 8 bits	C bits a)	FCS 16 bits	F 01111110	
Bit order of transmission	12345678	12345678	1 to a)	16 to 1	12345678	
	Flag	Address	Control	Information	FCS	Flag
	F 01111110	A 8 bits	C bits a)	Info N bits	FCS 16 bits	F 01111110
FCS Frame Check Sequence						
a) 32 for frame formats that contain sequence numbers; 8 for frame formats that do not contain sequence numbers.						

2.2.7.3 Information field

The information field of a frame, when present, follows the control field (see 2.2.7.2 above) and precedes the frame check sequence field (see 2.2.7.4 below).

For start/stop transmission there shall be eight (8) information bits between the start bit and the stop bit.

When transmitting from the DCE to the DTE, if the information to be inserted in the information field does not have a number of bits that is multiple of 8, the DCE shall pad this information field with zeros so that the information field will be octet-aligned.

When transmitting from the DTE to the DCE, the DTE shall transmit only octet-aligned information.

See 2.3.4.9, 2.5.2 and clause 5 for the various codings and groupings of bits in the information field as used in this Recommendation.

See 2.3.4.9 and 2.4.9.5 below with regard to the maximum information field length.

2.2.7.4 Frame Check Sequence (FCS) field

The notation used to describe the FCS is based on the property of cyclic codes that a code vector such as 1000000100001 can be represented by a polynomial $P(x) = x^{12} + x^5 + 1$. The elements of an n -element code word are thus the coefficients of a polynomial of order $n - 1$. In this application, these coefficients can have the value 0 or 1 and the polynomial operations are performed modulo 2. The polynomial representing the content of a frame is generated using the first bit received after the frame opening flag as the coefficient of the highest order term.

The FCS field shall be a 16-bit sequence. It shall be the ones complement of the sum (modulo 2) of:

- 1) the remainder of $x^k (x^{15} + x^{14} + x^{13} + x^{12} + x^{11} + x^{10} + x^9 + x^8 + x^7 + x^6 + x^5 + x^4 + x^3 + x^2 + x + 1)$ divided (modulo 2) by the generator polynomial $x^{16} + x^{12} + x^5 + 1$, where k is the number of bits in the frame existing between, but not including, the final bit of the opening flag and the first bit of the FCS, excluding bits (synchronous transmission) or octets (start/stop transmission) inserted for transparency, and bits inserted for transmission timing (i.e. start or stop bits); and
- 2) the remainder of the division (modulo 2) by the generator polynomial $x^{16} + x^{12} + x^5 + 1$ of the product of x^{16} by the content of the frame, existing between but not including, the final bit of the opening flag and the first bit of the FCS, excluding bits (synchronous transmission) or octets (start/stop transmission) inserted for transparency and bits inserted for transmission timing (i.e. start or stop bits).

As a typical implementation, at the transmitter, the initial content of the register of the device computing the remainder of the division is preset to all 1s and is then modified by division by the generator polynomial (as described above) on the address, control and information fields; the ones complement of the resulting remainder is transmitted as the 16-bit FCS.

At the receiver, the initial content of the register of the device computing the remainder is preset to all 1s. The final remainder, after multiplication by x^{16} and then division (modulo 2) by the generator polynomial $x^{16} + x^{12} + x^5 + 1$ of the serial incoming protected bits and the FCS, will be 0001110100001111 (x^{15} through x^0 , respectively) in the absence of transmission errors.

NOTE – Examples of transmitted bit patterns by the DCE and the DTE illustrating application of the transparency mechanism and the frame check sequence to the SABM command and the UA response are given in Appendix I.

2.3 LAPB elements of procedures

2.3.1 The LAPB elements of procedures are defined in terms of actions that occur on receipt of frames at the DCE or DTE.

The elements of procedures specified below contain the selection of commands and responses relevant to the LAPB data link and system configurations described in 2.1 above. Together, 2.2 and 2.3 form the general requirements for the proper management of an LAPB access data link.

2.3.2 LAPB control field formats and parameters

2.3.2.1 Control field formats

The control field contains a command or a response, and sequence numbers where applicable.

Three types of control field formats are used to perform numbered information transfer (I format), numbered supervisory functions (S format) and unnumbered control functions (U format).

The control field formats for basic (modulo 8) operation are depicted in Table 2-4.

The control field formats for extended (modulo 128) operation are depicted in Table 2-5.

The control field formats for super (modulo 32 768) operation are depicted in Table 2-6.

2.3.2.1.1 Information transfer format I

The I format is used to perform an information transfer. The functions of N(S), N(R) and P are independent; i.e. each I frame has an N(S), an N(R) which may or may not acknowledge additional I frames received by the DCE or DTE, and a P bit that may be set to 0 or 1.

2.3.2.1.2 Supervisory format S

The S format is used to perform data link supervisory control functions such as acknowledge I frames, request retransmission of I frames, and to request a temporary suspension of transmission of I frames. The functions of N(R) and P/F are independent; i.e. each supervisory frame has an N(R) which may or may not acknowledge additional I frames received by the DCE or DTE, and a P/F bit that may be set to 0 or 1.

2.3.2.1.3 Unnumbered format U

The U format is used to provide additional data link control functions. This format contains no sequence numbers, but does include a P/F bit that may be set to 0 or 1. The unnumbered frames have the same control field length (one octet) in basic (modulo 8) operation, extended (modulo 128) operation, and super (modulo 32 768) operation.

2.3.2.2 Control field parameters

The various parameters associated with the control field formats are described below.

2.3.2.2.1 Modulus

Each I frame is sequentially numbered and may have the value 0 through modulus minus 1 (where “modulus” is the modulus of the sequence numbers). The modulus equals either 8, 128 or 32 768 and the sequence numbers cycle through the entire range.

2.3.2.2.2 Send state variable V(S)

The send state variable V(S) denotes the sequence number of the next in-sequence I frame to be transmitted. V(S) can take on the values 0 through modulus minus 1. The value of V(S) is incremented by 1 with each successive I frame transmission, but cannot exceed the N(R) of the last received I or supervisory frame by more than the maximum number of outstanding I frames (k). The value of k is defined in 2.4.9.6 below.

2.3.2.2.3 Send sequence number N(S)

Only I frames contain N(S), the send sequence number of transmitted I frames. At the time that an in-sequence I frame is designated for transmission, the value of N(S) is set equal to the value of the send state variable V(S).

2.3.2.2.4 Receive state variable V(R)

The receive state variable V(R) denotes the sequence number of the next in-sequence I frame expected to be received. V(R) can take on the values 0 through modulus minus 1. The value of V(R) is incremented by 1 by the receipt of an error-free, in-sequence I frame whose send sequence number N(S) equals the receive state variable V(R).

TABLE 2-4/X.25

LAPB control field format – Basic (modulo 8) operation

Control field bits	1	2	3	4	5	6	7	8
I format	0	N(S)			P	N(R)		
S format	1	0	S	S	P/F	N(R)		
U format	1	1	M	M	P/F	M	M	M

N(S) Transmitter send sequence number (bit 2 = low-order bit)
 N(R) Transmitter receive sequence number (bit 6 = low-order bit)
 S Supervisory function bit
 M Modifier function bit
 P/F Poll bit when issued as a command, final bit when issued as a response (1 = Poll/Final)
 P Poll bit (1 = Poll)

TABLE 2-5/X.25

LAPB control field formats – Extended (modulo 128) operation

Control field bits	1st octet								2nd octet							
	1	2	3	4	5	6	7	8	9	10	11	12	13	14	15	16
I format	0	N(S)							P	N(R)						
S format	1	0	S	S	X	X	X	X	P/F	N(R)						
U format	1	1	M	M	P/F	M	M	M								

N(S) Transmitter send sequence number (bit 2 = low-order bit)
 N(R) Transmitter receive sequence number (bit 10 = low-order bit)
 S Supervisory function bit
 M Modifier function bit
 X Reserved and set to 0
 P/F Poll bit when issued as a command, final bit when issued as a response (1 = Poll/Final)
 P Poll bit (1 = Poll)

TABLE 2-6/X.25

LAPB control field formats – Super (modulo 32 768) operation

Control field bits	First two octets				Next two octets								
	1	2....	16		17	18....	32						
I format	0	N(S)				P	N(R)						
S format	1	0	S	S	X	X	X	X	...	X	P/F	N(R)	
U format	1	1	M	M	P/F	M	M	M					
N(S)	Transmitter send sequence number (bit 2 = low-order bit)												
N(R)	Transmitter receive sequence number (bit 18 = low-order bit)												
S	Supervisory function bit												
M	Modifier function bit												
X	Reserved and set to 0												
P/F	Poll bit when issued as a command, final bit when issued as a response (1 = Poll/Final)												
P	Poll bit (1 = Poll)												

2.3.2.2.5 Receive sequence number N(R)

All I frames and supervisory frames, except SREJ frames with F bit set to 0, shall contain N(R), the expected send sequence number of the next received I frame. At the time that a frame of the above types is designated for transmission, the value of N(R) is set equal to the current value of the receive state variable V(R). N(R) indicates that the DCE or DTE transmitting the N(R) has received correctly all I frames numbered up to and including N(R) – 1.

2.3.2.2.6 Poll/Final bit P/F

All frames contain P/F, the Poll/Final bit. In command frames, the P/F bit is referred to as the P bit. In response frames, it is referred to as the F bit.

2.3.3 Functions of the Poll/Final bit

The Poll bit set to 1 is used by the DCE or DTE to solicit (poll) a response from the DTE or DCE, respectively. The Final bit set to 1 is used by the DCE or DTE to indicate the response frame transmitted by the DTE or DCE, respectively, as a result of the soliciting (poll) command.

The use of the P/F bit is described in 2.4.3 below.

2.3.4 Commands and responses

For basic (modulo 8) operation, the commands and responses represented in Table 2-7 will be supported by the DCE and the DTE.

For extended (modulo 128) operation, the commands and responses represented in Table 2-8 will be supported by the DCE and the DTE.

For super (modulo 32 768) operation, the commands and responses represented in Table 2-9 will be supported by the DCE and the DTE.

For purposes of the LAPB procedures, those encodings of the modifier function bits in Tables 2-4, 2-5 and 2-6 not identified in Tables 2-7, 2-8 and 2-9 are identified as “undefined or not implemented” command and response control fields.

The commands and responses in Tables 2-7, 2-8 and 2-9 are defined as follows:

TABLE 2-7/X.25

LAPB commands and responses – Basic (modulo 8) operation

Format	Command	Response	Encoding								
			1	2	3	4	5	6	7	8	
Information transfer	I (Information)		0	N(S)				P	N(R)		
Supervisory	RR (Receive Ready)	RR (Receive Ready)	1	0	0	0	P/F		N(R)		
	RNR (Receive Not Ready)	RNR (Receive Not Ready)	1	0	1	0	P/F		N(R)		
	REJ (Reject)	REJ (Reject)	1	0	0	1	P/F		N(R)		
Unnumbered	SABM (Set Asynchronous Balanced Mode)		1	1	1	1	P		1	0	0
	DISC (Disconnect)		1	1	0	0	P		0	1	0
		DM (Disconnect Mode)	1	1	1	1	F		0	0	0
		UA (Unnumbered Acknowledgement)	1	1	0	0	F		1	1	0
		FRMR (Frame Reject)	1	1	1	0	F		0	0	1

TABLE 2-8/X.25

LAPB commands and responses – Extended (modulo 128) operation

Format	Command	Response	Encoding										
			1	2	3	4	5	6	7	8	9	10 to 16	
Information transfer	I (Information)		0	N(S)						P	N(R)		
Supervisory	RR (Receive Ready)	RR (Receive Ready)	1	0	0	0	0	0	0	0	P/F	N(R)	
	RNR (Receive Not Ready)	RNR (Receive Not Ready)	1	0	1	0	0	0	0	0	P/F	N(R)	
	REJ (Reject)	REJ (Reject)	1	0	0	1	0	0	0	0	P/F	N(R)	
		SREJ (Selective Reject)	1	0	1	1	0	0	0	0	F	N(R)	
Unnumbered	SABME (Set Asynchronous Balanced Mode Extended)		1	1	1	1	P	1	1	0			
	DISC (Disconnect)		1	1	0	0	P	0	1	0			
		DM (Disconnected Mode)	1	1	1	1	F	0	0	0			
		UA (Unnumbered Acknowledgement)	1	1	0	0	F	1	1	0			
		FRMR (Frame Reject)	1	1	1	0	F	0	0	1			

TABLE 2-9/X.25

LAPB commands and responses – Super (modulo 32 768) operation)

Format	Command	Response	Encoding															
			1	2	3	...	8	16	17	18 to 32	33 to 40							
Information transfert	I (Information)		0	N(S)												P	N(R)	
Supervisory	RR (Receive Ready)	RR (Receive Ready)	1	0	0	0	0	0	0	0	0	0	0	0	0	0	P/F	N®
	RNR (Receive Not Ready)	RNR (Receive Not Ready)	1	0	1	0	0	0	0	0	0	0	0	0	0	0	P/F	N(R)
	REJ (Reject)	REJ (Reject)	1	0	0	1	0	0	0	0	0	0	0	0	0	0	P/F	N(R)
		SREJ (Selective Reject)	1	0	1	1	0	0	0	0	0	0	0	0	0	0	F	N(R)
Unnumbered	SM (Set Mode)		1	1	0	0	P	0	1	1							0000	0000
	DISC (Disconnect)		1	1	0	0	P	0	1	0							0010	0100
		FRMR (Frame Reject)	1	1	1	0	F	0	0	1							0000	
		UA (Unnumbered acknowledgement)	1	1	0	0	F	1	1	0								
		DM (Disconnected Mode)	1	1	1	1	F	0	0	0								

2.3.4.1 Information (I) command

The function of the information (I) command is to transfer across a data link a sequentially numbered frame containing an information field.

2.3.4.2 Receive Ready (RR) command and response

The Receive Ready (RR) supervisory frame is used by the DCE or DTE to:

- 1) indicate it is ready to receive an I frame; and
- 2) acknowledge previously received I frames numbered up to and including N(R) – 1.

An RR frame may be used to indicate the clearance of a busy condition that was reported by the earlier transmission of an RNR frame by that same station (DCE or DTE). In addition to indicating the DCE or DTE status, the RR command with the P bit set to 1 may be used by the DCE or DTE to ask for the status of the DTE or DCE, respectively.

2.3.4.3 Receive Not Ready (RNR) command and response

The Receive Not Ready (RNR) supervisory frame is used by the DCE or DTE to indicate a busy condition; i.e. temporary inability to accept additional incoming I frames. I frames numbered up to and including $N(R) - 1$ are acknowledged. I frame $N(R)$ and any subsequent I frames received, if any, are not acknowledged; the acceptance status of these I frames will be indicated in subsequent exchanges.

In addition to indicating the DCE or DTE status, the RNR command with the P bit set to 1 may be used by a DCE or DTE to ask for the status of the DTE or DCE, respectively.

2.3.4.4 Reject (REJ) command and response

The reject (REJ) supervisory frame is used by the DCE or DTE to request transmission of I frames starting with the frame numbered $N(R)$. I frames numbered $N(R) - 1$ and below are acknowledged. Additional I frames pending initial transmission may be transmitted following the retransmitted I frame(s).

Only one REJ exception condition for a given direction of information transfer may be established at any time. The REJ exception condition is cleared (reset) upon the receipt of an I frame with an $N(S)$ equal to the $N(R)$ of the REJ frame.

An REJ frame may be used to indicate the clearance of a busy condition that was reported by the earlier transmission of an RNR frame by that same station (DCE or DTE). In addition to indicating the DCE or DTE status, the REJ command with the P bit set to 1 may be used by the DCE or DTE to ask for the status of the DTE or DCE, respectively.

2.3.4.5 Selective reject (SREJ) response

The selective reject (SREJ) supervisory frame shall be used by a DCE or DTE to request retransmission of one or more (not necessarily contiguous) I frames. The $N(R)$ field of the control field of the SREJ frame shall contain the sequence number of the earliest I frame to be retransmitted and the information field shall contain, in ascending order (i.e. 127 is higher than 126 and 0 is higher than 127 for modulo 128, and 32 767 is higher than 32 766 and 0 is higher than 32 767 for modulo 32 768), the sequence numbers of additional I frames(s), if any, in need of retransmission.

For extended (modulo 128) operation, the information field shall be encoded such that there is an octet for each standalone I frame in need of retransmission, and a 2-octet span list for each sequence of two or more contiguously numbered I frames in need of retransmission, as depicted in Table 2-10. In the case of standalone I frames, their identity in the information field consists of the appropriate $N(R)$ value preceded by a 0 bit in the octet used. In the case of span lists, their identity in the information field consists of the $N(R)$ value of the first I frame in the span list preceded by a 1 bit in the octet used, followed by the $N(R)$ value of the last I frame in the span list preceded by a 1 bit in the octet used. The number of bits in an SREJ frame shall not exceed the value of parameter $N1$, the maximum number of bits in an I frame.

For super (modulo 32 768) operation, the information field shall be encoded such that there is a 2-octet field for each standalone I frame in need of retransmission, and a 4-octet span list for each sequence of two or more contiguously numbered I frames in need of retransmission, as depicted in Table 2-11. In the case of standalone I frames, their identity in the information field consists of the appropriate $N(R)$ value preceded by a 0 bit in the 2-octet field used. In the case of span lists, their identity in the information field consists of the $N(R)$ value of the first I frame in the span list preceded by a 1 bit in the 2-octet field used, followed by the $N(R)$ value of the last I frame in the span list preceded by a 1 bit in the 2-octet field used. The number of bits in an SREJ frame shall not exceed the value of parameter $N1$, the maximum number of bits in an I frame.

If the P/F bit in an SREJ frame is set to 1, then I frames numbered up to $N(R) - 1$ inclusive [$N(R)$ being the value in the control field] are considered as acknowledged. If the P/F bit in an SREJ frame is set to 0, then the $N(R)$ in the control field of the SREJ frame does not indicate acknowledgement of I frames.

The procedures to be followed on receipt of an SREJ frame are specified in 2.4.6.6.

TABLE 2-11/X.25
Control field and information encoding for modulo-32 768 numbering

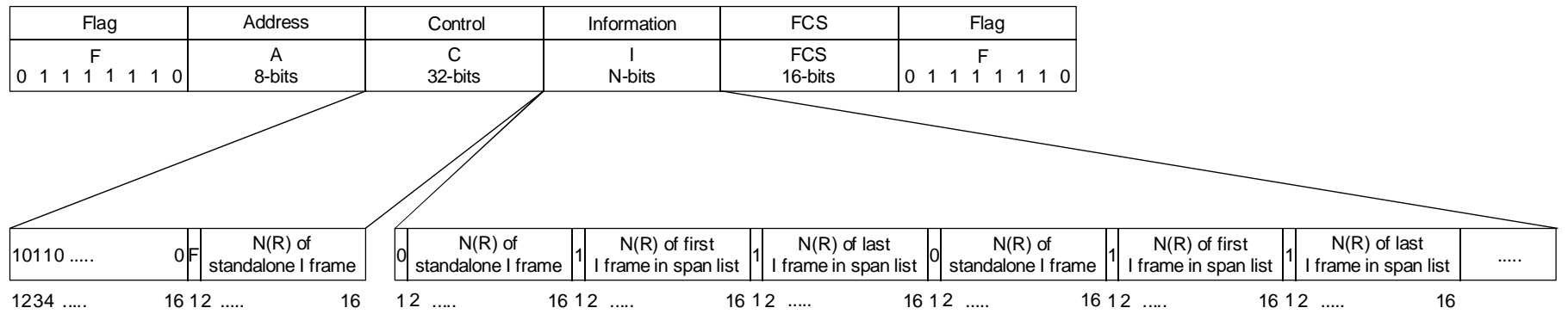

T0724610-96/d03

2.3.4.6 Set Asynchronous Balanced Mode (SABM) command/Set Asynchronous Balanced Mode Extended (SABME) command (subscription-time option)/Set Mode (SM) command (subscription-time option)

The SABM unnumbered command is used to place the addressed DCE or DTE in an Asynchronous Balanced Mode (ABM) information transfer phase where all command/response control fields will be one octet in length.

The SABME unnumbered command is used to place the addressed DCE or DTE in an Asynchronous Balanced Mode (ABM) information transfer phase where numbered command/response control fields will be two octets in length, and unnumbered command/response control fields will be one octet in length.

The SM unnumbered command is used for super operation (modulo 32 768) to place the addressed DCE or DTE in an Asynchronous Balanced Mode (ABM) information transfer phase where numbered command/response control fields will be four octets in length, and unnumbered command/response control fields (other than SM) will be one octet in length. The SM unnumbered command is 5 octets in length.

No information field is permitted with the SABM or SABME or SM command. The transmission of a SABM/SABME/SM command indicates the clearance of a busy condition that was reported by the earlier transmission of an RNR frame by that same station (DCE or DTE). The DCE or DTE confirms acceptance of SABM/SABME/SM [modulo 8 (basic) operation/modulo 128 (extended) operation/modulo 32 768 (super) operation] command by the transmission, at the first opportunity, of a UA response. Upon acceptance of this command, the DCE or DTE send state variable V(S) and receive state variable V(R) are set to 0.

Previously transmitted I frames that are unacknowledged when this command is actioned remain unacknowledged. It is the responsibility of a higher layer (e.g. Packet Layer or MLP) to recover from the possible loss of the contents (e.g. packets) of such I frames.

NOTE – The mode of operation of a data link [basic (modulo 8) or extended (modulo 128) or super (modulo 32 768)] is determined at subscription time and is only changed by going through a new subscription process.

2.3.4.7 Disconnect (DISC) command

The DISC unnumbered command is used to terminate the mode previously set. It is used to inform the DCE or DTE receiving the DISC command that the DTE or DCE sending the DISC command is suspending operation. No information field is permitted with the DISC command. Prior to actioning the DISC command, the DCE or DTE receiving the DISC command confirms the acceptance of the DISC command by the transmission of a UA response. The DTE or DCE sending the DISC command enters the disconnected phase when it receives the acknowledging UA response.

Previously transmitted I frames that are unacknowledged when this command is actioned remain unacknowledged. It is the responsibility of a higher layer (e.g. Packet Layer or MLP) to recover from the possible loss of the contents (e.g. packets) of such I frames.

2.3.4.8 Unnumbered Acknowledgement (UA) response

The UA unnumbered response is used by the DCE or DTE to acknowledge the receipt and acceptance of the mode-setting commands. Received mode-setting commands are not actioned until the UA response is transmitted. The transmission of a UA response indicates the clearance of a busy condition that was reported by the earlier transmission of an RNR frame by that same station (DCE or DTE). No information field is permitted with the UA response.

2.3.4.9 Disconnected Mode (DM) response

The DM unnumbered response is used to report a status where the DCE or DTE is logically disconnected from the data link, and is in the disconnected phase. The DM response may be sent to indicate that the DCE or DTE has entered the disconnected phase without benefit of having received a DISC command, or, if sent in response to the reception of a mode setting command, is sent to inform the DTE or DCE that the DCE or DTE, respectively, is still in the disconnected phase and cannot execute the set mode command. No information field is permitted with the DM response.

A DCE or DTE in a disconnected phase will monitor received commands and will react to an SABM/SABME/SM command as outlined in 2.4.4 below, and will respond with a DM response with the F bit set to 1 to any other command received with the P bit set to 1.

2.3.4.10 Frame reject (FRMR) response

The FRMR unnumbered response is used by the DCE or DTE to report an error condition not recoverable by retransmission of the identical frame, i.e. at least one of the following conditions, which results from the receipt of a valid frame:

- 1) the receipt of a command or response control field that is undefined or not implemented;
- 2) the receipt of an I frame with an information field which exceeds the maximum established length;
- 3) the receipt of an invalid N(R) (defined below); or
- 4) the receipt of a frame with an information field which is not permitted or the receipt of a supervisory or unnumbered frame with incorrect length.

An undefined or not implemented control field is any of the control field encodings that are not identified in Tables 2-7, 2-8 or 2-9.

A valid N(R) must be within the range from the lowest send sequence number N(S) of the still unacknowledged frame(s) to the current DCE send state variable inclusive (or to the current internal variable *x* if the DCE is in the timer recovery condition as described in 2.4.5.9).

An information field which immediately follows the control field, and consists of 3 or 5 or 9 octets [modulo 8 (basic) operation or modulo 128 (extended) operation or modulo 32 768 (super), respectively], is returned with this response and provides the reason for the FRMR response. These formats are given in Tables 2-12, 2-13 and 2-14.

TABLE 2-12/X.25

LAPB FRMR information field format – Basic (modulo 8) operation

Information field bits																							
1	2	3	4	5	6	7	8	9	10	11	12	13	14	15	16	17	18	19	20	21	22	23	24
Rejected frame control field								0	V(S)			C/R	V(R)			W	X	Y	Z	0	0	0	0
<p>Rejected frame control field is the control field of the received frame which caused the frame reject.</p> <p>V(S) Is the current send state variable value at the DCE or DTE reporting the rejection condition (bit 10 = low-order bit).</p> <p>C/R Set to 1 indicates the rejected frame was a response. C/R set to 0 indicates the rejected frame was a command.</p> <p>V(R) Is the current receive state variable value at the DCE or DTE reporting the rejection condition (bit 14 = low-order bit).</p> <p>W Set to 1 indicates that the control field received and returned in bits 1 through 8 was undefined or not implemented.</p> <p>X Set to 1 indicates that the control field received and returned in bits 1 through 8 was considered invalid because the frame contained an information field which is not permitted with this frame or is a supervisory or unnumbered frame with incorrect length. Bit W must be set to 1 in conjunction with this bit.</p> <p>Y Set to 1 indicates that the information field received exceeded the maximum established capacity.</p> <p>Z Set to 1 indicates the control field received and returned in bits 1 through 8 contained an invalid N(R).</p> <p>NOTE – Bits 9 and 21 to 24 shall be set to 0.</p>																							

TABLE 2-13/X.25

LAPB FRMR information field format – Extended (modulo 128) operation

Information field bits												
1 to 16	17	18 to 24	25	26 to 32	33	34	35	36	37	38	39	40
Rejected frame control field	0	V(S)	C/R	V(R)	W	X	Y	Z	0	0	0	0
<p>Rejected frame control field is the control field of the received frame which caused the frame reject. When the rejected frame is an unnumbered frame, the control field of the rejected frame is positioned in bit positions 1-8, with 9-16 set to 0.</p> <p>V(S) Is the current send state variable value at the DCE or DTE reporting the rejection condition (bit 18 = low-order bit).</p> <p>C/R Set to 1 indicates the rejected frame was a response. C/R set to 0 indicates the rejected frame was a command.</p> <p>V(R) Is the current receive state variable value at the DCE or DTE reporting the rejection condition (bit 26 = low-order bit).</p> <p>W Set to 1 indicates that the control field received and returned in bits 1 through 16 was undefined or not implemented.</p> <p>X Set to 1 indicates that the control field received and returned in bits 1 through 16 was considered invalid because the frame contained an information field which is not permitted with this frame or is a supervisory or unnumbered frame with incorrect length. Bit W must be set to 1 in conjunction with this bit.</p> <p>Y Set to 1 indicates that the information field received exceeded the maximum established capacity.</p> <p>Z Set to 1 indicates the control field received and returned in bits 1 through 16 contained an invalid N(R).</p> <p>NOTE – Bits 17 and 37 to 40 shall be set to 0.</p>												

TABLE 2-14/X.25

LAPB FRMR information field format – Super (modulo 32 768) operation

Information field bits												
1 to 32	33	34 to 48	49	50 to 64	65	66	67	68	69	70	71	72
Rejected frame control field	0	V(S)	C/R	V(R)	W	X	Y	Z	0	0	0	0
<p>Rejected frame control field is the control field of the received frame which caused the frame reject. When the rejected frame is an unnumbered frame, the control field of the rejected frame is positioned in bit positions 1-8, with 9-32 set to 0.</p> <p>V(S) Is the current send state variable value at the DCE or DTE reporting the rejection condition (bit 34 = low-order bit).</p> <p>C/R Set to 1 indicates the rejected frame was a response. C/R set to 0 indicates the rejected frame was a command.</p> <p>V(R) Is the current receive state variable value at the DCE or DTE reporting the rejection condition (bit 50 = low-order bit).</p> <p>W Set to 1 indicates that the control field received and returned in bits 1 through 32 was undefined or not implemented.</p> <p>X Set to 1 indicates that the control field received and returned in bits 1 through 32 was considered invalid because the frame contained an information field which is not permitted with this frame or is a supervisory or unnumbered frame with incorrect length. Bit W must be set to 1 in conjunction with this bit.</p> <p>Y Set to 1 indicates that the information field received exceeded the maximum established capacity.</p> <p>Z Set to 1 indicates the control field received and returned in bits 1 through 32 contained an invalid N(R).</p> <p>NOTE – Bits 33 and 69 to 72 shall be set to 0.</p>												

2.3.5 Exception condition reporting and recovery

The error recovery procedures which are available to effect recovery following the detection/occurrence of an exception condition at the Data Link Layer are described below. Exception conditions described are those situations which may occur as the result of transmission errors, DCE or DTE malfunction, or operational situations.

2.3.5.1 Busy condition

The busy condition results when the DCE or DTE is temporarily unable to continue to receive I frames due to internal constraints, e.g. receive buffering limitations. In this case an RNR frame is transmitted from the busy DCE or DTE. I frames pending transmission may be transmitted from the busy DCE or DTE prior to or following the RNR frame.

An indication that the busy condition has cleared is communicated by the transmission of a UA (only in response to an SABM/SABME/SM command), RR, REJ or SABM/SABME/SM (modulo 8/modulo 128/modulo 32 768) frame.

2.3.5.2 N(S) sequence error condition

If the multi-selective reject option is not used, the information field of all I frames received whose N(S) does not equal the receive state variable V(R) will be discarded.

If the multi-selective reject option is used, the information field of all I frames received whose N(S) is not in the range V(R) and V(R) + k – 1 inclusive, shall be discarded. If the multi-selective reject option is used, the information field of all I frames received by the DCE or DTE whose N(S) is in the range V(R) and V(R) + k – 1 inclusive, shall be saved in the receive buffer.

An N(S) sequence error exception condition occurs in the receiver when an I frame received contains an N(S) which is not equal to the receive state variable V(R) at the receiver. The receiver does not acknowledge (increment its receive state variable) the I frame causing the sequence error, or any I frame which may follow, until an I frame with the correct N(S) is received.

A DCE or DTE which receives one or more valid I frames having sequence errors or subsequent supervisory frames (RR, RNR and REJ) shall accept the control information contained in the N(R) field and the P or F bit to perform data link control functions, e.g. to receive acknowledgement of previously transmitted I frames and to cause the DCE or DTE to respond (P bit set to 1).

The means specified in 2.3.5.2.1, 2.3.5.2.2 and 2.3.5.2.3 shall be available for initiating the retransmission of lost or errored I frames following the occurrence of an N(S) sequence error condition.

2.3.5.2.1 REJ recovery

The REJ frame is used by a receiving DCE or DTE to initiate a recovery (retransmission) following the detection of an N(S) sequence error.

With respect to each direction of transmission on the data link, only one “sent REJ” exception condition from a DCE or DTE, to a DTE or DCE, is established at a time. A “sent REJ” exception condition is cleared when the requested I frame is received.

A DCE or DTE receiving an REJ frame initiates sequential (re-)transmission of I frames starting with the I frame indicated by the N(R) contained in the REJ frame. The retransmitted frames may contain an N(R) and a P bit that are updated from, and therefore different from, the ones contained in the originally transmitted I frames.

2.3.5.2.2 SREJ recovery

Only SREJ recovery shall be used when the multi-selective reject option is used; REJ recovery shall not be used.

The SREJ frame shall be used to initiate more efficient error recovery by selectively requesting the retransmission of one or more (not necessarily contiguous) lost or errored I frame(s) following the detection of sequence errors, rather than requesting the retransmission of all I frames. When a DCE or DTE receives an out-of-sequence frame, the I frame shall be saved in a receive buffer. The I frame shall be delivered to the upper layer only when all I frames numbered below N(S) are correctly received. If frame number N(S) – 1 has not been received previously, then an SREJ response frame with the F bit set to 0 shall be transmitted, that contains the sequence numbers of the block of consecutive missing I frames ending at N(S) – 1. The DCE or DTE on receiving such an SREJ frame shall retransmit all requested I frames. After having retransmitted these I frames, the DCE or DTE may transmit new I frames, if they become available.

When a DCE or DTE receives a command frame with the P bit set to 1, if there are out-of-sequence I frames saved in the receive buffer, it shall transmit an SREJ frame with the F bit set to 1, that contains a complete list of missing sequence numbers. The DCE or DTE on receiving such an SREJ frame shall retransmit all requested I frames, except those that were transmitted subsequent to the last command frame with the P bit set to 1.

2.3.5.2.3 Time-out recovery

If a DCE or DTE, due to a transmission error, does not receive (or receives and discards) a single I frame or the last I frame in a sequence of I frames, it will not detect an N(S) sequence error condition and, therefore, will not transmit an REJ frame

If the multi-selective reject option is not used, then the DTE or DCE which transmitted the unacknowledged I frame(s) shall, following the completion of a system specified time-out period (see 2.4.5.1 and 2.4.5.9 below), take appropriate recovery action to determine at which I frame retransmission must begin. The retransmitted frame(s) may contain an N(R) and a P bit that is updated from, and therefore different from, the ones contained in the originally transmitted frame(s).

If the multi-selective reject option is used, then the DTE or DCE which transmitted the unacknowledged I frame(s) shall, following the completion of a system specified time-out period (see 2.4.5.1 and 2.4.5.9 below), send a supervisory command frame (RR or RNR) with the P bit set to 1. I frames shall only be retransmitted on the receipt of an RR response frame with the F bit set to 1 or an SREJ frame.

2.3.5.3 Invalid frame condition

Any frame which is invalid will be discarded, and no action is taken as the result of that frame. An invalid frame is defined as one which:

- a) is not properly bounded by two flags;
- b) in basic (modulo 8) operation, contains fewer than 32 bits between flags; in extended (modulo 128) operation, contains fewer than 40 bits between flags of frames that contain sequence numbers or 32 bits between flags of frames that do not contain sequence numbers; in super (modulo 32 768) operation, contains fewer than 56 bits between flags of frames that contain sequence numbers or 32 bits between flags of frames that do not contain sequence numbers;

NOTE – The above bit lengths do not include bits (synchronous transmission) or octets (start/stop transmission) inserted for transparency and bits inserted for transmission timing (i.e. start or stop bits).

- c) or start/stop transmission, in addition to conditions listed in b), contains an octet-framing violation (i.e. a 0 bit occurs where a stop bit is expected);
- d) contains a Frame Check Sequence (FCS) error;
- e) contains an address other than A or B (for single link operation) or other than C or D (for multilink operation); or
- f) frame aborted: in synchronous transmission, a frame is aborted when it contains at least seven contiguous 1 bits (with no inserted 0 bits); in start/stop transmission, a frame is aborted when it contains the two-octet sequence composed of the control escape octet followed by a closing flag.

For those networks that are octet aligned, a detection of non-octet alignment may be made at the Data Link Layer by adding a frame validity check that requires the number of bits between the opening flag and the closing flag, excluding inserted bits (for transparency or for transmission timing for start/stop transmission), to be an integral number of octets in length, or the frame is considered invalid.

2.3.5.4 Frame rejection condition

A frame rejection condition is established upon the receipt of an error-free frame with one of the conditions listed in 2.3.4.9 above.

At the DCE or DTE, this frame rejection exception condition is reported by an FRMR response for appropriate DTE or DCE action, respectively. Once a DCE has established such an exception condition, no additional I frames are accepted until the condition is reset by the DTE, except for examination of the P bit. The FRMR response may be repeated at each opportunity, as specified in 2.4.8.3, until recovery is effected by the DTE, or until the DCE initiates its own recovery in case the DTE does not respond.

2.3.5.5 Excessive idle channel state condition on incoming channel

Upon detection of an idle channel state condition (see 2.2.6.2 above) on the incoming channel, the DCE shall wait for a period T3 (see 2.4.9.3 below) without taking any specific action, waiting for detection of a return to the active channel state (i.e. detection of at least one flag sequence). After the period T3, the DCE shall notify the higher layer (e.g. the Packet Layer or the MLP) of the excessive idle channel state condition, but shall not take any action that would preclude the DTE from establishing the data link by normal data link set-up procedures.

NOTE – Other actions to be taken by the DCE at the Data Link Layer upon expiration of period T3 is a subject for further study.

2.4 Description of the LAPB procedure

2.4.1 LAPB basic, extended and super modes of operation

In accordance with the system choice made by the DTE at subscription time, the DCE will either support modulo 8 (basic) operation or will support modulo 128 (extended) operation or will support modulo 32 768 (super) operation. Changing from basic operation, extended operation and super operation in the DCE requires resubscription by the DTE for the desired service, and is not supported dynamically.

Table 2-7 indicates the command and response control field formats used with the basic (modulo 8) service. The mode-setting command employed to initialize (set up) or reset the basic mode is the SABM command. Table 2-8 indicates the command and response control field formats used with the extended (modulo 128) service. Table 2-9 indicates the command and response control field formats used with the super (modulo 32 768) service. The mode-setting command employed to initialize (set up) or reset the extended or super mode is the SABME or SM command respectively.

2.4.2 LAPB procedure for addressing

The address field identifies a frame as either a command or a response. A command frame contains the address of the DCE or DTE to which the command is being sent. A response frame contains the address of the DCE or DTE sending the frame.

In order to allow differentiation between single link operation and the optional multilink operation for diagnostic and/or maintenance reasons, different address pair encodings are assigned to data links operating with multilink procedure compared to data links operating with the single link procedure.

Frames containing commands transferred from the DCE to the DTE will contain the address A for the single link operation and address C for the multilink operation.

Frames containing responses transferred from the DCE to the DTE will contain the address B for the single link operation and address D for the multilink operation.

Frames containing commands transferred from the DTE to the DCE shall contain the address B for the single link operation and address D for the multilink operation.

Frames containing responses transferred from the DTE to the DCE shall contain the address A for the single link operation and address C for the multilink operation.

These addresses are coded as follows:

	Address	1	2	3	4	5	6	7	8
Single link operation	A	1	1	0	0	0	0	0	0
	B	1	0	0	0	0	0	0	0
Multilink operation	C	1	1	1	1	0	0	0	0
	D	1	1	1	0	0	0	0	0

NOTE – The DCE will discard all frames received with an address other than A or B (single link operation), or C or D (multilink operation).

2.4.3 LAPB procedure for the use of the P/F bit

The DCE or DTE receiving an SABM/SABME/SM, DISC, supervisory command or I frame with the P bit set to 1 will set the F bit to 1 in the next response frame it transmits.

The response frame returned by the DCE to an SABM/SABME/SM or DISC command with the P bit set to 1 will be a UA or DM response with the F bit set to 1. The response frame returned by the DCE to an I frame with the P bit set to 1, received during the information transfer phase, will be an RR, REJ, SREJ, RNR or FRMR response with the F bit set to 1. The response frame returned by the DCE to a supervisory command with the P bit set to 1, received during the information transfer phase, will be an RR, REJ, SREJ, RNR or FRMR response with the F bit set to 1. The response frame returned by the DCE to an I frame or supervisory frame with the P bit set to 1, received during the disconnected phase, will be a DM response with the F bit set to 1.

The P bit may be used by the DCE in conjunction with the timer recovery condition (see 2.4.5.9 and 2.4.6.9 below).

NOTE – Other use of the P bit by the DCE is a subject for further study.

2.4.4 LAPB procedure for data link set-up and disconnection

2.4.4.1 Data link set-up

The DCE will indicate that it is able to set up the data link by transmitting contiguous flags (active channel state).

Either the DTE or the DCE may initiate data link set-up. Prior to initiation of data link set-up, either the DCE or the DTE may initiate data link disconnection (see 2.4.4.3) for the purpose of ensuring that the DCE and the DTE are in the same phase. The DCE may also transmit an unsolicited DM response to request the DTE to initiate data link set-up.

The DTE shall initiate data link set-up by transmitting an SABM/SABME/SM command to the DCE. If, upon receipt of the SABM/SABME/SM command correctly, the DCE determines that it can enter the information transfer phase, it will return a UA response to the DTE, will reset its send and receive state variables V(S) and V(R) to zero, and will consider that the data link is set up. If, upon receipt of the SABM/SABME/SM command correctly, the DCE determines that it cannot enter the information transfer phase, it will return a DM response to the DTE as a denial to the data link set-up initialization and will consider that the data link is *not* set up. In order to avoid misinterpretation of the DM response received, it is suggested that the DTE always sends its SABM/SABME/SM command with the P bit set to 1. Otherwise, it is not possible to differentiate a DM response intended as a denial to data link set-up from a DM response that is issued in a separate unsolicited sense as a request for a mode-setting command (as described in 2.4.4.4.2).

The DCE will initiate data link set-up by transmitting an SABM/SABME/SM command to the DTE and starting its Timer T1 in order to determine when too much time has elapsed waiting for a reply (see 2.4.9.1 below). Upon reception of a UA response from the DTE, the DCE will reset its send and receive state variables V(S) and V(R) to zero, will stop its Timer T1, and will consider that the data link is set up. Upon reception of a DM response from the DTE as a denial to the data link set-up initialization, the DCE will stop its Timer T1 and will consider that the data link is *not* set up.

The DCE, having sent the SABM/SABME/SM command, will ignore and discard any frames except an SABM/SABME/SM or DISC command, or a UA or DM response received from the DTE. The receipt of an SABM/SABME/SM or DISC command from the DTE will result in a collision situation that is resolved per 2.4.4.5 below. Frames other than the UA and DM responses sent in response to a received SABM/SABME/SM or DISC command will be sent only after the data link is set up and if no outstanding SABM/SABME/SM command exists.

After the DCE sends the SABM/SABME/SM command, if a UA or DM response is not received correctly, Timer T1 will run out in the DCE. The DCE will then resend the SABM/SABME/SM command and will restart Timer T1. After transmission of the SABM/SABME/SM command N2 times by the DCE, appropriate higher layer recovery action will be initiated. The value of N2 is defined in 2.4.9.4 below.

2.4.4.2 Information transfer phase

After having transmitted the UA response to the SABM/SABME/SM command or having received the UA response to a transmitted SABM/SABME/SM command, the DCE will accept and transmit I and supervisory frames according to the procedures described in 2.4.5 below.

When receiving the SABM/SABME/SM command while in the information transfer phase, the DCE will conform to the data link resetting procedure described in 2.4.8 below.

2.4.4.3 Data link disconnection

The DTE shall initiate a disconnect of the data link by transmitting a DISC command to the DCE. On correctly receiving a DISC command in the information transfer phase, the DCE will send a UA response and enter the disconnected phase. On correctly receiving a DISC command in the disconnected phase, the DCE will send a DM response and remain in the disconnected phase. In order to avoid misinterpretation of the DM response received, it is suggested that the DTE always sends its DISC command with the P bit set to 1. Otherwise, it is not possible to differentiate a DM response intended as an indication that the DCE is already in the disconnected phase from a DM response that is issued in a separate unsolicited sense as a request for a mode-setting command (as described in 2.4.4.4.2).

The DCE will initiate a disconnect of the data link by transmitting a DISC command to the DTE and starting its Timer T1 (see 2.4.9.1 below). Upon reception of a UA response from the DTE, the DCE will stop its Timer T1 and will enter the disconnected phase. Upon reception of a DM response from the DTE as an indication that the DTE was already in the disconnected phase, the DCE will stop its Timer T1 and will enter the disconnected phase.

The DCE, having sent the DISC command, will ignore and discard any frames except an SABM/SABME/SM or DISC command, or a UA or DM response received from the DTE. The receipt of an SABM/SABME/SM or DISC command from the DTE will result in a collision situation that is resolved per 2.4.4.5 below.

After the DCE sends the DISC command, if a UA or DM response is not received correctly, Timer T1 will run out in the DCE. The DCE will then resend the DISC command and will restart Timer T1. After transmission of the DISC command N2 times by the DCE, appropriate higher layer recovery action will be initiated. The value of N2 is defined in 2.4.9.4 below.

2.4.4.4 Disconnected phase

2.4.4.4.1 After having received a DISC command from the DTE and returned a UA response to the DTE, or having received the UA response to a transmitted DISC command, the DCE will enter the disconnected phase.

In the disconnected phase, the DCE may initiate data link set-up. In the disconnected phase, the DCE will react to the receipt of an SABM/SABME/SM command as described in 2.4.4.1 above and will transmit a DM response in answer to a received DISC command. When receiving any other command (defined, or undefined or not implemented) with the P bit set to 1, the DCE will transmit a DM response with the F bit set to 1. Other frames received in the disconnected phase will be ignored by the DCE.

2.4.4.4.2 When the DCE enters the disconnected phase after detecting error conditions as listed in 2.4.7 below, or after an internal malfunction, it may indicate this by sending a DM response rather than a DISC command. In these cases, the DCE will transmit a DM response and start its Timer T1 (see 2.4.9.1 below).

If Timer T1 runs out before the reception of an SABM/SABME/SM or DISC command from the DTE, the DCE will retransmit the DM response and restart Timer T1. After transmission of the DM response N2 times, the DCE will remain in the disconnected phase and appropriate recovery actions will be initiated. The value of N2 is defined in 2.4.9.4 below.

Alternatively, after an internal malfunction, the DCE may either initiate a data link resetting procedure (see 2.4.8 below) or disconnect the data link (see 2.4.4.3 above) prior to initiating a data link set-up procedure (see 2.4.4.1 above).

2.4.4.5 Collision of unnumbered commands

Collision situations shall be resolved in the following way:

2.4.4.5.1 If the sent and received unnumbered commands are the same, the DCE and the DTE shall each send the UA response at the earliest possible opportunity. The DCE shall enter the indicated phase either:

- 1) after receiving the UA response;
- 2) after sending the UA response; or
- 3) after timing out waiting for the UA response having sent a UA response.

In the case of 2) above, the DCE will accept a subsequent UA response to the mode-setting command it issued without causing an exception condition if received within the time-out interval.

2.4.4.5.2 If the sent and received unnumbered commands are different, the DCE and the DTE shall each enter the disconnected phase and issue a DM response at the earliest possible opportunity.

2.4.4.6 Collision of DM response with SABM/SABME/SM or DISC command

When a DM response is issued by the DCE as an unsolicited response to request the DTE to issue a mode-setting command as described in 2.4.4.4, a collision between an SABM/SABME/SM or DISC command and the unsolicited DM response may occur. In order to avoid misinterpretation of the DM response received, the DTE always sends its SABM/SABME/SM or DISC command with the P bit set to 1.

2.4.4.7 Collision of DM responses

A contention situation may occur when both the DCE and the DTE issue a DM response. In this case, the DTE will issue an SABM/SABME/SM command to resolve the contention situation.

2.4.5 LAPB procedures for information transfer

The procedures which apply to the transmission of I frames in each direction during the information transfer phase are described below.

In the following, "number one higher" is in reference to a continuously repeated sequence series, i.e. 7 is 1 higher than 6 and 0 is 1 higher than 7 for modulo 8 series, and 127 is 1 higher than 126 and 0 is 1 higher than 127 for modulo 128 series and 32 767 is one higher than 32 766 and 0 is one higher than 32 767 for modulo 32 768 series.

2.4.5.1 Sending I frames

When the DCE has an I frame to transmit (i.e. an I frame not already transmitted, or having to be retransmitted as described in 2.4.5.6 below), it will transmit it with an N(S) equal to its current send state variable V(S), and an N(R) equal to its current receive state variable V(R). At the end of the transmission of the I frame, the DCE will increment its send state variable V(S) by 1.

If Timer T1 is not running at the time of transmission of an I frame, it will be started.

If the send state variable V(S) is equal to the last value of N(R) received plus k (where k is the maximum number of outstanding I frames – see 2.4.9.6 below), the DCE will not transmit any new I frames, but may retransmit an I frame as described in 2.4.5.6 or 2.4.5.9 below.

When the DCE is in the busy condition, it may still transmit I frames, provided that the DTE is not busy. When the DCE is in the frame rejection condition, it will stop transmitting I frames.

2.4.5.2 Receiving an I frame

2.4.5.2.1 When the DCE is not in a busy condition and receives a valid I frame whose send sequence number N(S) is equal to the DCE receive state variable V(R), the DCE will accept the information field of this frame, increment by one its receive state variable V(R), and act as follows:

- a) If the DCE is still not in a busy condition:
 - i) If an I frame is available for transmission by the DCE, it may act as in 2.4.5.1 above and acknowledge the received I frame by setting N(R) in the control field of the next transmitted I frame to the value of the DCE receive state variable V(R). Alternatively, the DCE may acknowledge the received I frame by transmitting an RR frame with the N(R) equal to the value of the DCE receive state variable V(R).
 - ii) If no I frame is available for transmission by the DCE, it will transmit an RR frame with N(R) equal to the value of the DCE receive state variable V(R).
- b) If the DCE is now in a busy condition, it will transmit an RNR frame with N(R) equal to the value of the DCE receive state variable V(R) (see 2.4.5.8).

2.4.5.2.2 When the DCE is in a busy condition, it may ignore the information field contained in any received I frame.

2.4.5.3 Reception of invalid frames

When the DCE receives an invalid frame (see 2.3.5.3), this frame will be discarded.

2.4.5.4 Reception of out-of-sequence I frames

When the DCE receives a valid I frame whose send sequence number $N(S)$ is incorrect, i.e. not equal to the current DCE receive state variable $V(R)$, it will discard the information field of the I frame and transmit an REJ frame with the $N(R)$ set to one higher than the $N(S)$ of the last correctly received I frame. The REJ frame will be a command frame with the P bit set to 1 if an acknowledged transfer of the retransmission request is required; otherwise the REJ frame may be either a command or a response frame. The DCE will then discard the information field of all I frames received until the expected I frame is correctly received. When receiving the expected I frame, the DCE will then acknowledge the I frame as described in 2.4.5.2 above. The DCE will use the $N(R)$ and P bit information in the discarded I frames as described in 2.3.5.2 above.

2.4.5.5 Receiving acknowledgement

When correctly receiving an I frame or a supervisory frame (RR, RNR or REJ), even in the busy condition, the DCE will consider the $N(R)$ contained in this frame as an acknowledgement for all I frames it has transmitted with an $N(S)$ up to and including the received $N(R) - 1$. The DCE will stop Timer T1 when it correctly receives an I frame or a supervisory frame with the $N(R)$ higher than the last received $N(R)$ (actually acknowledging some I frames), or an REJ frame with an $N(R)$ equal to the last received $N(R)$.

If Timer T1 has been stopped by the receipt on an I, RR or RNR frame, and if there are outstanding I frames still unacknowledged, the DCE will restart Timer T1. If Timer T1 then runs out, the DCE will follow the recovery procedure (see 2.4.5.9 below) with respect to the unacknowledged I frames. If Timer T1 has been stopped by the receipt of an REJ frame, the DCE will follow the retransmission procedures in 2.4.5.6 below.

2.4.5.6 Receiving an REJ frame

When receiving an REJ frame, the DCE will set its send state variable $V(S)$ to the $N(R)$ received in the REJ control field. It will transmit the corresponding I frame as soon as it is available or retransmit it in accordance with the procedures described in 2.4.5.1 above. (Re)transmission will conform to the following procedure:

- i) if the DCE is transmitting a supervisory command or response when it receives the REJ frame, it will complete that transmission before commencing transmission of the requested I frame;
- ii) if the DCE is transmitting an unnumbered command or response when it receives the REJ frame, it will ignore the request for retransmission;
- iii) if the DCE is transmitting an I frame when the REJ frame is received, it may abort the I frame and commence transmission of the requested I frame immediately after abortion;
- iv) if the DCE is not transmitting any frame when the REJ frame is received, it will commence transmission of the requested I frame immediately.

In all cases, if other unacknowledged I frames had already been transmitted following the one indicated in the REJ frame, then those I frames will be retransmitted by the DCE following the retransmission of the requested I frame. Other I frames not yet transmitted may be transmitted following the retransmitted I frames.

If the REJ frame was received from the DTE as a command with the P bit set to 1, the DCE will transmit an RR, RNR or REJ response with the F bit set to 1 before transmitting or retransmitting the corresponding I frame.

2.4.5.7 Receiving an RNR frame

After receiving an RNR frame whose $N(R)$ acknowledges all frames previously transmitted, the DCE will stop Timer T1 and may then transmit an I frame, with the P bit set to 0, whose send sequence number is equal to the $N(R)$ indicated in the RNR frame, restarting Timer T1 as it does. After receiving an RNR frame whose $N(R)$ indicates a previously transmitted frame, the DCE will not transmit or retransmit any I frame, Timer T1 being already running. In either case, if the Timer T1 runs out before receipt of a busy clearance indication, the DCE will follow the procedure described in 2.4.5.9 below. In any case, the DCE will not transmit any other I frames before receiving an RR or REJ frame, or before the completion of a link resetting procedure.

Alternatively, after receiving an RNR frame, the DCE may wait for a period of time (e.g. the length of the Timer T1) and then transmit a supervisory command frame (RR, RNR or REJ) with the P bit set to 1, and start Timer T1, in order to determine if there is any change in the receive status of the DTE. The DTE shall respond to the P bit set to 1 with a supervisory response frame (RR, RNR or REJ) with the F bit set to 1 indicating either continuance of the busy condition (RNR) or clearance of the busy condition (RR or REJ). Upon receipt of the DTE response, Timer T1 is stopped.

- 1) If the response is the RR or REJ response, the busy condition is cleared and the DCE may transmit I frames beginning with the I frame identified by the N(R) in the received response frame.
- 2) If the response is the RNR response, the busy condition still exists and the DCE will, after a period of time (e.g. the length of Timer T1), repeat the enquiry of the DTE receive status.

If Timer T1 runs out before a status response is received, the enquiry process above is repeated. If N2 attempts to get a status response fail (i.e. Timer T1 runs out N2 times), the DCE will initiate a data link resetting procedure as described in 2.4.8.2 below or will transmit a DM response to ask the DTE to initiate a data link set-up procedure as described in 2.4.4.1 and enter the disconnected phase. The value of N2 is defined in 2.4.9.4 below.

If, at any time during the enquiry process, an unsolicited RR or REJ frame is received from the DTE, it will be considered to be an indication of clearance of the busy condition. Should the unsolicited RR or REJ frame be a command frame with the P bit set to 1, the appropriate response frame with the F bit set to 1 must be transmitted before the DCE may resume transmission of I frames. If Timer T1 is running, the DCE will wait for the non-busy response with the F bit set to 1 or will wait for Timer T1 to run out and then either may reinitiate the enquiry process in order to realize a successful P/F bit exchange or may resume transmission of I frames beginning with the I frame identified by the N(R) in the received RR or REJ frame.

2.4.5.8 DCE busy condition

When the DCE enters a busy condition, it will transmit an RNR frame at the earliest opportunity. The RNR frame will be a command frame with the P bit set to 1 if an acknowledged transfer of the busy condition indication is required; otherwise the RNR frame may be either a command or a response frame. While in the busy condition, the DCE will accept and process supervisory frames, will accept and process the contents of the N(R) fields of I frames, and will return an RNR response with the F bit set to 1 if it receives a supervisory command or I command frame with the P bit set to 1. To clear the busy condition, the DCE will transmit either an REJ frame or an RR frame, with N(R) set to the current receive state variable V(R), depending on whether or not it discarded information fields of correctly received I frames. The REJ frame or the RR frame will be a command frame with the P bit set to 1 if an acknowledged transfer of the busy-to-non-busy transition is required, otherwise the REJ frame or the RR frame may be either a command or a response frame.

2.4.5.9 Waiting acknowledgement

The DCE maintains an internal transmission attempt variable which is set to 0 when the DCE sends a UA response, when the DCE receives a UA response or an RNR command or response, or when the DCE correctly receives an I frame or supervisory frame with the N(R) higher than the last received N(R) (actually acknowledging some outstanding I frames).

If Timer T1 runs out waiting for the acknowledgement from the DTE for an I frame transmitted, the DCE will enter the timer recovery condition, add one to its transmission attempt variable and set an internal variable x to the current value of its send state variable V(S). The DCE will then restart Timer T1, set its send state variable V(S) to the last value of N(R) received from the DTE and retransmit the corresponding I frame with the P bit set to 1, or transmit an appropriate supervisory command frame (RR, RNR or REJ) with the P bit set to 1.

The timer recovery condition is cleared when the DCE receives a valid supervisory frame with the F bit set to 1.

If, while in the timer recovery condition, the DCE correctly receives a supervisory frame with the F bit set to 1 and with the N(R) within the range from its current send state variable V(S) to x included, it will clear the timer recovery condition (including stopping Timer T1) and set its send state variable V(S) to the value of the received N(R), and may then resume with I frame transmission or retransmission, as appropriate.

If, while in the timer recovery condition, the DCE correctly receives an I or supervisory frame with the P/F bit set to 0 and with a valid N(R) (see 2.3.4.9), it will not clear the timer recovery condition. The value of the received N(R) may be used to update the send state variable V(S). However, the DCE may decide to keep the last transmitted I frame in store (even if it is acknowledged) in order to be able to retransmit it with the P bit set to 1 when Timer T1 runs out at a later time.

If the received supervisory frame with the P/F bit set to 0 is an REJ frame with a valid N(R), the DCE may either immediately initiate (re)transmission from the value of the send state variable V(S), or it may ignore the request for retransmission and wait until the supervisory frame with the F bit set to 1 is received before initiating (re)transmission of frames from the value identified in the N(R) field of the supervisory frame with the F bit set to 1. In the case of immediate retransmission, in order to prevent duplicate retransmissions following the clearance of the timer recovery condition, the DCE shall inhibit retransmission of a specific I frame [same N(R) in the same numbering cycle] if the DCE has retransmitted that I frame as the result of a received REJ frame with the P/F bit set to 0.

If, while in the timer recovery condition, the DCE receives an REJ command with the P bit set to 1, the DCE will respond immediately with an appropriate supervisory response with the F bit set to 1. The DCE may then use the value of the N(R) in the REJ command to update the send state variable V(S), and may either immediately begin (re)transmission from the value N(R) indicated in the REJ frame or ignore the request for retransmission and wait until the supervisory frame with the F bit set to 1 is received before initiating (re)transmission of I frames from the value identified in the N(R) field of the supervisory frame with the F bit set to 1. In the case of immediate retransmission, in order to prevent duplicate retransmissions following the clearance of the timer recovery condition, the DCE shall inhibit retransmission of a specific I frame [same N(R) in the same numbering cycle] if the DCE has retransmitted that I frame as the result of the received REJ command with the P bit set to 1.

If Timer T1 runs out in the timer recovery condition, and no I or supervisory frame with the P/F bit set to 0 and with a valid N(R) has been received, or no REJ command with the P bit set to 1 and with a valid N(R) has been received, the DCE will add one to its transmission attempt variable, restart Timer T1, and either retransmit the I frame sent with the P bit set to 1 or transmit an appropriate supervisory command with the P bit set to 1.

If the transmission attempt variable is equal to N2, the DCE will initiate a data link resetting procedure as described in 2.4.8.2 below, or will transmit a DM response to ask the DTE to initiate a data link set-up procedure as described in 2.4.4.1 above and enter the disconnected phase. N2 is a system parameter (see 2.4.9.4 below).

NOTE – Although the DCE may implement the internal variable x , other mechanisms do exist that achieve the identical function.

2.4.6 Procedures for information transfer when using multi-selective reject option

The procedures which apply to the transmission of I frames in each direction during the information transfer phase, when using the multi-selective reject option, are described below.

In the following, “number one higher” is in reference to a continuously repeated sequence series, i.e. 127 is one higher than 126 and 0 is one higher than 127 for modulo 128 series, and 32 767 is one higher than 32 766 and 0 is one higher than 32 767 for modulo 32 768 series.

The term “outstanding poll condition” is used to indicate the condition when the DCE has sent a command frame with the P bit set to 1 and has not yet received a response frame with the F bit set to 1

2.4.6.1 Sending new I frames

When the DCE has a new I frame to transmit (i.e. an I frame not already transmitted), it shall transmit it with an N(S) equal to its current send state variable V(S), and an N(R) equal to its current receive sequence number V(R). At the end of the transmission of the frame, it shall increment its send state variable V(S) by one.

The DCE Timer T1, if not running at the time of transmission of the I frame, shall be started.

If the DCE send state variable V(S) is equal to the last value of N(R) received plus k (where k is the maximum number of outstanding I frames; see 2.4.9.6), the DCE shall not transmit any new I frames.

If the remote DCE is busy, the DCE shall not transmit any new I frames.

When the DCE is in the busy condition, it may still transmit I frames, provided that the DTE is not busy.

2.4.6.2 Receiving an in-sequence I frame

When the DCE is not in a busy condition and receives a valid I frame whose send sequence number is equal to the DCE receive state variable $V(R)$, the DCE shall accept the information field of this frame and increment by one the receive state variable $V(R)$. If the I frame, whose $N(S)$ is equal to (the incremented value of) $V(R)$, is present in the receive buffer, then the DCE shall remove it from the receive buffer, deliver it to the upper layer and increment $V(R)$ by one; the DCE shall repeat this procedure until $V(R)$ reaches a value such that the I frame whose $N(S)$ is equal to $V(R)$ is not present in the receive buffer. The DCE shall then take one of the following actions:

- a) If the DCE is still not in a busy condition:
 - i) If the P bit is set to 1, then the DCE shall transmit a response frame with the F bit set to 1, as specified in 2.4.6.11.
 - ii) Otherwise, if an I frame is available and eligible for transmission (as specified in 2.4.9.6), the DCE shall act as described in 2.4.6.1 and acknowledge the received I frame by setting $N(R)$ in the control field of the next transmitted I frame to the value of the DCE receive state variable $V(R)$, or the DCE shall acknowledge the received I frame by transmitting an RR frame with the $N(R)$ equal to the value of the DCE receive state variable $V(R)$.
 - iii) Otherwise the DCE shall transmit an RR frame with the $N(R)$ equal to the value of the DCE receive state variable $V(R)$.
- b) If the DCE is now in a busy condition, it shall transmit an RNR frame with $N(R)$ equal to the value of the DCE receive variable $V(R)$ (see 2.4.6.8).

When the DCE is in busy condition, it may ignore the information field contained in any received I frame.

2.4.6.3 Reception of invalid frames

When the DCE receives an invalid frame (see 2.3.5.3), it shall discard the frame.

2.4.6.4 Reception of out-of-sequence I frames

When the DCE is not in a busy condition and the DCE receives a valid I frame whose send sequence number $N(S)$ is out-of-sequence, i.e. not equal to the DCE receive state variable $V(R)$, then it shall perform one of the following actions:

- a) If $N(S)$ is less than $V(R)$ or greater than or equal to $V(R) + k$, then it shall discard the information field of the I frame. If the P bit of the I frame is set to 1, then the DCE shall transmit a response frame with the F bit set to 1, as specified in 2.4.6.11.
- b) If $N(S)$ is greater than $V(R)$ and less than $V(R) + k$, then it shall save the I frame in the receive buffer. It shall then perform one of the following actions:
 - 1) If the P bit of the I frame is set to 1, then the DCE shall transmit a response frame with the F bit set to 1, as specified in 2.4.6.11.
 - 2) Otherwise, if the DCE is now in a busy condition, it shall transmit an RNR frame with $N(R)$ equal to the value of the DCE receive variable $V(R)$ (see 2.4.6.8).
 - 3) Otherwise, if I frame numbered $N(S) - 1$ has not yet been received, then the DCE shall transmit an SREJ response frame with the F bit set to 0. The DCE shall create a list of contiguous sequence numbers $N(X)$, $N(X) + 1$, $N(X) + 2$, ..., $N(S) - 1$, where $N(X)$ is greater than or equal to $V(R)$ and none of the I frames $N(X)$ to $N(S) - 1$ have been received. The $N(R)$ field of the SREJ frame shall be set to $N(X)$ and the information field set to the list $N(X) + 1$, ..., $N(S) - 1$. If the list of sequence numbers is too large to fit into the information field of the SREJ frame, then the list shall be truncated to fit in one SREJ frame, by including only the earliest sequence numbers.

When the DCE is in busy condition, it may ignore the information field contained in any received I frame.

2.4.6.5 Receiving acknowledgement

When correctly receiving an I frame or supervisory frame (RR, RNR or SREJ with the F bit set to 1), even in the busy condition, the DCE shall consider the $N(R)$ contained in this frame as an acknowledgement for all the I frames it has transmitted with an $N(S)$ up to and including the received $N(R) - 1$. The DCE shall stop the Timer T1 if the received supervisory frame has the F bit set to 1 or if there is no outstanding poll condition and the $N(R)$ is higher than the last received $N(R)$ (actually acknowledging some I frames).

If Timer T1 has been stopped by the receipt of an I frame, an RR command frame, an RR response frame with the F bit set to 0 or an RNR frame, and if there are outstanding I frames still unacknowledged, the DCE shall restart Timer T1. If Timer T1 has been stopped by the receipt of an SREJ frame with the F bit set to 1, the DCE shall follow the retransmission procedure in 2.4.6.6.2. If Timer T1 has been stopped by the receipt of an RR frame with the F bit set to 1, the DCE shall follow the retransmission procedure in 2.4.6.10.

2.4.6.6 Receiving an SREJ response frame

2.4.6.6.1 Receiving an SREJ response frame with the F bit set to 0

When receiving an SREJ response frame with the F bit set to 0, the DCE shall retransmit all I frames, whose sequence numbers are indicated in the N(R) field and the information field of the SREJ frame, in the order specified in the SREJ frame. Retransmission shall conform to the following:

- a) If the DCE is transmitting a supervisory or I frame when it receives the SREJ frame, it shall complete that transmission before commencing transmission of the requested I frames.
- b) If the DCE is transmitting an unnumbered command or response when it receives the SREJ frame, it shall ignore the request for retransmission.
- c) If the DCE is not transmitting any frame when it receives the SREJ frame, it shall commence transmission of the requested I frames immediately.

If there is no outstanding poll condition, then a poll shall be sent, either by transmitting an RR command (or RNR command if the DCE is in the busy condition) with the P bit set to 1 or by setting the P bit in the last retransmitted I frame and Timer T1 shall be restarted.

If there is an outstanding poll condition, then Timer T1 shall not be restarted.

2.4.6.6.2 Receiving an SREJ response frame with the F bit set to 1

When receiving an SREJ response frame with the F bit set to 1, the DCE shall retransmit all I frames, whose sequence numbers are indicated in the N(R) field and the information field of the SREJ frame, in the order specified in the SREJ frame, except those I frames that were sent after the frame with the P bit set to 1 was sent. Retransmission shall conform to the following:

- a) If the DCE is transmitting a supervisory or I frame when it receives the SREJ frame, it shall complete that transmission before commencing transmission of the requested I frames.
- b) If the DCE is transmitting an unnumbered command or response when it receives the SREJ frame, it shall ignore the request for retransmission.
- c) If the DCE is not transmitting any frame when it receives the SREJ frame, it shall commence transmission of the requested I frames immediately.

If any frames are retransmitted, then a poll shall be sent, either by transmitting an RR command (or RNR command if the DCE is in the busy condition) with the P bit set to 1 or by setting the P bit in the last retransmitted I frame.

Timer T1 shall be restarted.

2.4.6.7 Receiving an RNR Frame

After receiving an RNR frame, the DCE shall stop transmission of I frames until an RR or SREJ frame is received.

The DCE shall start Timer T1, if necessary, as specified in 2.3.5.1.

When Timer T1 runs out before receipt of a busy clearance indication, the DCE shall transmit a supervisory frame (RR, RNR) with the P bit set to 1 and shall restart Timer T1, in order to determine if there is any change in the receive status of the DTE. The DTE shall respond to the P bit set to 1 with a supervisory response frame (RR, RNR, SREJ) with the F bit set to 1 indicating continuation of the busy condition (RNR frame) or clearance of the busy condition (RR, SREJ). Upon receipt of the DTE response, Timer T1 shall be stopped.

- a) If the response is an RR frame, the busy condition shall be assumed to be cleared and the DCE may retransmit frames as specified in 2.4.6.10. New I frames may be transmitted as specified in 2.4.6.1
- b) If the response is an SREJ frame, the busy condition shall be assumed to be cleared and the DCE may retransmit frames as specified in 2.4.6.6.2. New I frames may be transmitted as specified in 2.4.6.1

- c) If the response is an RNR frame, the busy condition shall be assumed to still exist and the DCE, after a period of time (for example the duration of Timer T1), shall repeat the enquiry of the DTE receive status.

If Timer T1 runs out before a status response is received, the enquiry process above shall be repeated. If N2 attempts to get a status response fail, the DCE shall initiate link resetting procedure as described in 2.4.8.

If, at any time during the enquiry process, an unsolicited RR or SREJ frame is received from the DTE, it shall be considered to be an indication of clearance of the busy condition. Should the unsolicited RR frame be a command frame with the P bit set to 1, the appropriate response frame with the F bit set to 1 shall be transmitted (see 2.4.6.11) before the DCE may resume transmission of I frames. The DCE shall not clear the poll outstanding condition. The DCE shall not stop Timer T1. If an unsolicited SREJ frame is received, then the DCE shall perform retransmissions as specified in 2.4.6.6.1.

2.4.6.8 DCE busy condition

When the DCE enters a busy condition, it shall transmit an RNR frame at the earliest opportunity. The RNR frame shall be a command frame with the P bit set to 1 if an acknowledged transfer of the busy condition indication is required; otherwise the RNR frame may be either a command or response frame. While in the busy condition, the DCE shall accept and process supervisory frames, accept and process the N(R) field of I, RR and SREJ frames with the F bit set to 1, and return an RNR response with the F bit set to 1 if it receives a supervisory command or I command frame with the P bit set to 1. Received I frames may be discarded or saved as specified in 2.4.6.2 and 2.4.6.4; however, RR or SREJ frames shall not be transmitted. To clear the busy condition, the DCE shall transmit an RR frame, with the N(R) field set to the current receive state variable V(R). The RR frame shall be a command frame with the P bit set to 1 if an acknowledged transfer of the busy-to-non-busy transition is required; otherwise the RR frame may be either a command or response frame.

2.4.6.9 Awaiting acknowledgement.

If Timer T1 runs out waiting for the acknowledgement from the DTE for an I frame transmitted, the DCE shall restart Timer T1 and transmit an appropriate supervisory command frame (RR, RNR) with the P bit set to 1. The DCE may transmit new I frames after sending this enquiry frame.

If the DCE receives an SREJ response frame with the F bit set to 1, the DCE shall restart Timer T1 and retransmit I frames as specified in 2.4.6.6.2.

If the DCE receives an SREJ response frame with the F bit set to 0, the DCE shall retransmit I frames as specified in 2.4.6.6.2.

If the DCE receives an RR response frame with the F bit set to 1, the DCE shall restart Timer T1 and retransmit I frames as specified in 2.4.6.10.

If the DCE receives an RR response frame with the F bit set to 0, or an RR command frame or I frame with the P bit set to 0 or 1, the DCE shall not restart Timer T1, but use the received N(R) as an indication of acknowledgement of transmitted I frames up to and including I frame numbered N(R) – 1.

If Timer T1 runs out before a supervisory response frame with the F bit set to 1 is received, the DCE shall retransmit an appropriate supervisory command frame (RR, RNR) with the P bit set to 1. After N2 such attempts, the DCE shall initiate a link resetting procedure as described in 2.4.8.

2.4.6.10 Receiving RR response frames with the F bit set to 1

When receiving an RR response frame with the F bit set to 1, the DCE shall process the N(R) field as specified in 2.4.6.5. If there are outstanding I frames that are unacknowledged and no new I frames have been transmitted subsequent to the last frame with the P bit set to 1, then the DCE shall retransmit all outstanding I frames except those that were sent after the frame with the P bit set to 1 was sent. Retransmission shall conform to the following:

- a) If the DCE is transmitting a supervisory or I frame when it receives the RR frame, it shall complete that transmission before commencing transmission of the requested I frames.
- b) If the DCE is transmitting an unnumbered command or response when it receives the RR frame, it shall ignore the request for retransmission.
- c) If the DCE is not transmitting any frame when it receives the RR frame, it shall commence transmission of the requested I frames immediately.

If any frames are retransmitted, then a poll shall be sent, either by transmitting an RR command (or RNR command if the DCE is in the busy condition) with the P bit set to 1 or by setting the P bit in the last retransmitted I frame.

Timer T1 shall be stopped. If any I frames are outstanding, then Timer T1 shall be started.

2.4.6.11 Responding to command frames with the P bit set to 1

When receiving an RR or RNR or I command frame with the P bit set to 1, the DCE shall generate an appropriate response frame as follows.

- a) If the DCE is in the busy condition, it shall transmit an RNR response frame with the F bit set to 1.
- b) If there are some out-of-sequence frames in the receive buffer, then it shall transmit an SREJ frame with the F bit set to 1; N(R) shall be set to the receive state variable V(R) and the information field set to the sequence numbers of all missing I frames, except V(R). If the list of sequence numbers is too large to fit in the information field of the SREJ frame, then the list shall be truncated by including only the earliest sequence numbers.
- c) If there are no out-of-sequence frames in the receive buffer, then an RR response frame with the F bit set to 1 shall be sent.

2.4.7 LAPB conditions for data link resetting or data link re-initialization (data link set-up)

2.4.7.1 When the DCE receives, during the information transfer phase, a frame which is not invalid (see 2.3.5.3) with one of the conditions listed in 2.3.4.9 above, the DCE will request the DTE to initiate a data link resetting procedure by transmitting an FRMR response to the DTE as described in 2.4.8.3.

2.4.7.2 When the DCE receives, during the information transfer phase, an FRMR response from the DTE, the DCE will either initiate the data link resetting procedures itself as described in 2.4.8.2 or return a DM response to ask the DTE to initiate the data link set-up (initialization) procedure as described in 2.4.4.1. After transmitting a DM response, the DCE will enter the disconnected phase as described in 2.4.4.4.2.

2.4.7.3 When the DCE receives, during the information transfer phase, a UA response, or an unsolicited response with the F bit set to 1, the DCE may either initiate the data link resetting procedures itself as described in 2.4.8.2, or return a DM response to ask the DTE to initiate the data link set-up (initialization) procedure as described in 2.4.4.1. After transmitting a DM response, the DCE will enter the disconnected phase as described in 2.4.4.4.2.

2.4.7.4 When the DCE receives, during the information transfer phase, a DM response from the DTE, the DCE will either initiate the data link set-up (initialization) procedures itself as described in 2.4.4.1, or return a DM response to ask the DTE to initiate the data link set-up (initialization) procedures as described in 2.4.4.1. After transmitting a DM response, the DCE will enter the disconnected phase as described in 2.4.4.4.2.

2.4.8 LAPB procedure for data link resetting

2.4.8.1 The data link resetting procedure is used to initialize both directions of information transfer according to the procedure described below. The data link resetting procedure only applies during the information transfer phase.

2.4.8.2 Either the DTE or the DCE may initiate the data link resetting procedure. The data link resetting procedure indicates a clearance of a DCE and/or DTE busy condition, if present.

The DTE shall initiate a data link resetting by transmitting an SABM/SABME/SM command to the DCE. If, upon correct receipt of the SABM/SABME/SM command, the DCE determines that it can continue in the information transfer phase, it will return a UA response to the DTE, will reset its send and receive state variables V(S) and V(R) to zero, and will remain in the information transfer phase. If, upon correct receipt of the SABM/SABME/SM command, the DCE determines that it cannot remain in the information transfer phase, it will return a DM response as a denial to the resetting request and will enter the disconnected phase.

The DCE will initiate a data link resetting by transmitting an SABM/SABME/SM command to the DTE and starting its Timer T1 (see 2.4.9.1 below). Upon reception of a UA response from the DTE, the DCE will reset its send and receive state variables V(S) and V(R) to zero, will stop its Timer T1, and will remain in the information transfer phase. Upon reception of a DM response from the DTE as a denial to the data link resetting request, the DCE will stop its Timer T1 and will enter the disconnected phase.

The DCE, having sent an SABM/SABME/SM command, will ignore and discard any frames received from the DTE except an SABM/SABME/SM or DISC command, or a UA or DM response. The receipt of an SABM/SABME/SM or DISC command from the DTE will result in a collision situation that is resolved per 2.4.4.5 above. Frames other than the UA or DM response sent in response to a received SABM/SABME/SM or DISC command will be sent only after the data link is reset and if no outstanding SABM/SABME/SM command exists.

After the DCE sends the SABM/SABME/SM command, if a UA or DM response is not received correctly, Timer T1 will run out in the DCE. The DCE will then resend the SABM/SABME/SM command and will restart Timer T1. After N2 attempts to reset the data link, the DCE will initiate appropriate higher layer recovery action and will enter the disconnected phase. The value of N2 is defined in 2.4.9.4 below.

2.4.8.3 The DCE may ask the DTE to reset the data link by transmitting an FRMR response (see 2.4.7.1 above). After transmitting an FRMR response, the DCE will enter the frame rejection condition.

The frame rejection condition is cleared when the DCE receives an SABM/SABME/SM command, a DISC command, an FRMR response, or a DM response; or if the DCE transmits an SABM/SABME/SM command, a DISC command, or a DM response. Other commands received while in the frame rejection condition will cause the DCE to retransmit the FRMR response with the same information field as originally transmitted.

The DCE may start Timer T1 on transmission of the FRMR response. If Timer T1 runs out before the frame rejection condition is cleared, the DCE may retransmit the FRMR response, and restart T1. After N2 attempts (time outs) to get the DTE to reset the data link, the DCE may reset the data link itself as described in 2.4.8.2 above. The value of N2 is defined in 2.4.9.4 below.

In the frame rejection condition, I frames and supervisory frames will not be transmitted by the DCE. Also, the DCE shall ignore and discard the N(S) and information fields of any received I frames and the N(R) fields of any received I frames and supervisory frames. When an additional FRMR response must be transmitted by the DCE as a result of the receipt of a command frame while Timer T1 is running, Timer T1 will continue to run. Upon reception of an FRMR response (even during a frame rejection condition), the DCE will initiate a resetting procedure by transmitting an SABM/SABME/SM command as described in 2.4.8.2 above, or will transmit a DM response to ask the DTE to initiate the data link set-up procedure as described in 2.4.4.1 and enter the disconnected phase.

2.4.9 List of LAPB system parameters

The DCE and DTE system parameters are as follows:

2.4.9.1 Timer T1

The value of the DTE Timer T1 system parameter may be different from the value of the DCE Timer T1 system parameter. These values shall be made known to both the DTE and the DCE, and agreed to for a period of time by both the DTE and the DCE.

The period of Timer T1, at the end of which retransmission of a frame may be initiated (see 2.4.4 and 2.4.5 above for the DCE), shall take into account whether T1 is started at the beginning or the end of the transmission of a frame.

The proper operation of the procedure requires that the transmitter's (DCE or DTE) Timer T1 be greater than the maximum time between transmission of a frame (SABM/SABME/SM, DISC, I or supervisory command, or DM or FRMR response) and the reception of the corresponding frame returned as an answer to that frame (UA, DM or acknowledging frame). Therefore, the receiver (DCE or DTE) should not delay the response or acknowledging frame returned to one of the above frames by more than a value T2, where T2 is a system parameter (see 2.4.9.2).

The DCE will not delay the response or acknowledging frame returned to one of the above DTE frames by more than a period T2.

2.4.9.2 Parameter T2

The value of the DTE parameter T2 may be different from the value of the DCE parameter T2. These values shall be made known to both the DTE and the DCE, and agreed to for a period of time by both the DTE and the DCE.

The period of parameter T2 shall indicate the amount of time available at the DCE or DTE before the acknowledging frame must be initiated in order to ensure its receipt by the DTE or DCE, respectively, prior to Timer T1 running out at the DTE or DCE (parameter T2 < Timer T1).

NOTE – The period of parameter T2 shall take into account the following timing factors: the transmission time of the acknowledging frame, the propagation time over the access data link, the stated processing times at the DCE and the DTE, and the time to complete the transmission of the frame(s) in the DCE or DTE transmit queue that are neither displaceable nor modifiable in an orderly manner.

Given a value for Timer T1 for the DTE or DCE, the value of parameter T2 at the DCE or DTE, respectively, must be no larger than T1 minus 2 times the propagation time over the access data link, minus the frame processing time at the DCE, minus the frame processing time at the DTE, and minus the transmission time of the acknowledging frame by the DCE or DTE, respectively.

2.4.9.3 Timer T3

The DCE shall support a Timer T3 system parameter, the value of which shall be made known to the DTE.

The period of Timer T3, at the end of which an indication of an observed excessively long idle channel state condition is passed to the Packet Layer, shall be sufficiently greater than the period of the DCE Timer T1 (i.e. $T3 > T1$) so that the expiration of T3 provides the desired level of assurance that the data link channel is in a non-active, non-operational state, and is in need of data link set-up before normal data link operation can resume.

2.4.9.4 Maximum number of attempts to complete a transmission N2

The value of the DTE N2 system parameter may be different from the value of the DCE N2 system parameter. These values shall be made known to both the DTE and the DCE, and agreed to for a period of time by both the DTE and the DCE.

The value of N2 shall indicate the maximum number of attempts made by the DCE or DTE to complete the successful transmission of a frame to the DTE or DCE, respectively.

2.4.9.5 Maximum number of bits in an I frame N1

The value of the DTE N1 system parameter may be different than the value of the DCE N1 system parameter. These values shall be made known to both the DTE and the DCE.

The values of N1 shall indicate the maximum number of bits in an I frame (excluding flags; 0 bits or control escape octets inserted for transparency for synchronous or start/stop transmission, respectively; and bits inserted for transmission timing for start/stop transmission) that the DCE or DTE is willing to accept from the DTE or DCE, respectively.

In order to allow for universal operation, a DTE should support a value of DTE N1 which is not less than 1080 bits (135 octets). DTEs should be aware that the network may transmit longer packets (see 5.2), that may result in a data link layer problem.

All networks shall offer to a DTE which requires it, a value of DCE N1 which is greater than or equal to 2072 bits (259 octets) plus the length of the address, control and FCS fields at the DTE/DCE interface, and greater than or equal to the maximum length of the data packets which may cross the DTE/DCE interface plus the length of the address, control and FCS fields at the DTE/DCE interface.

Appendix II provides a description of how the values stated above are derived.

2.4.9.6 Maximum number of outstanding I frames k

The value of the DTE k system parameter shall be the same as the value of the DCE k system parameter. This value shall be agreed to for a period of time by both the DTE and the DCE.

The value of k shall indicate the maximum number of sequentially numbered I frames that the DTE or DCE may have outstanding (i.e. unacknowledged) at any given time. The value of k shall never exceed seven for modulo 8 operation, or one hundred and twenty-seven for modulo 128 operation, or thirty-two thousand seven hundred and sixty-seven for modulo 32 768 operation. All networks (DCEs) shall support a value of seven. Other values of k (less than and greater than seven) may also be supported by networks (DCEs).

NOTE – Appendix V provides guidelines for selecting appropriate values of k and frame size to maximize the efficiency of access circuits operating at transmission speeds higher than 64 kbit/s or on circuits with long propagation delays. It is noted that, in some instances, the extended (modulo 128) or super (modulo 32 768) operation is necessary.

2.5 MultiLink Procedure (MLP) (Subscription-time selectable option)

The MultiLink Procedure (MLP) exists as an added upper sublayer of the Data Link Layer, operating between the Packet Layer and a multiplicity of single data link protocol functions (SLPs) in the Data Link Layer (see Figure 2-2).

A MultiLink Procedure (MLP) must perform the functions of accepting packets from the Packet Layer, distributing those packets across the available DCE or DTE SLPs for transmission to the DTE or DCE SLPs, respectively, and resequencing the packets received from the DTE or DCE SLPs for delivery to the DTE or DCE Packet Layer, respectively.

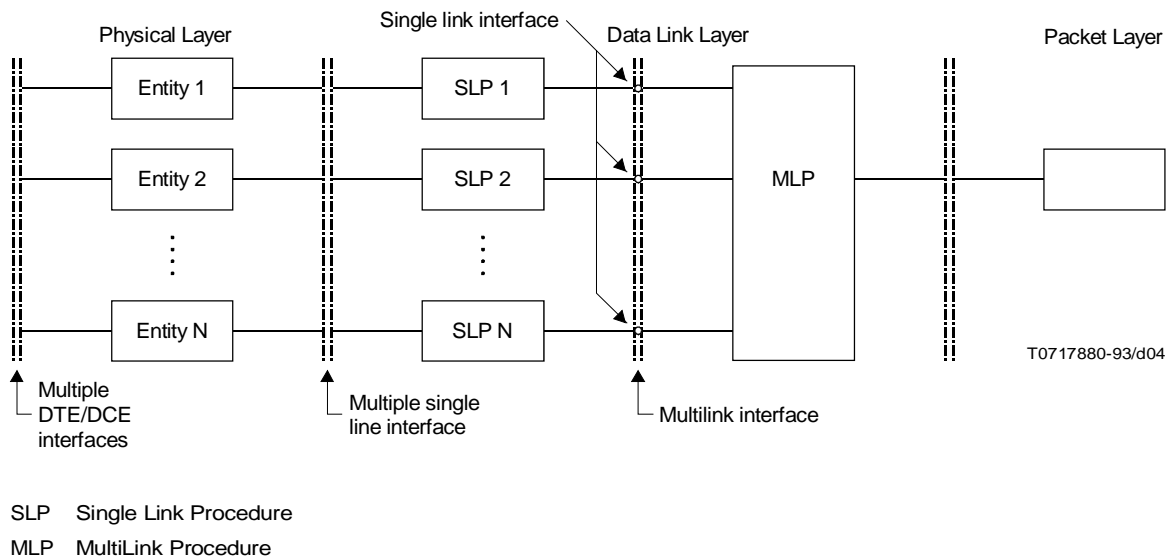

FIGURE 2-2/X.25
Multilink functional organization

2.5.1 Field of application

The optional MultiLink Procedure (MLP) described below is used for data interchange over one or more Single Link Procedures (SLPs), each conforming to the description in 2.2, 2.3 and 2.4, in parallel between a DCE and a DTE. The MultiLink Procedure provides the following general features:

- achieve economy and reliability of service by providing multiple SLPs between DCE and a DTE;
- permit addition and deletion of SLPs without interrupting the service provided by the multiple SLPs;
- optimize bandwidth utilization of a group of SLPs through load sharing;
- achieve graceful degradation of service when an SLP(s) fails;
- provide each multiple SLP group with a single logical Data Link Layer appearance to the Packet Layer; and
- provide resequencing of the received packets prior to delivering them to the Packet Layer.

2.5.2 Multilink frame structure

All information transfers over an SLP are in multilink frames conforming to one of the formats shown in Table 2-15.

TABLE 2-15/X.25
Multilink frame formats

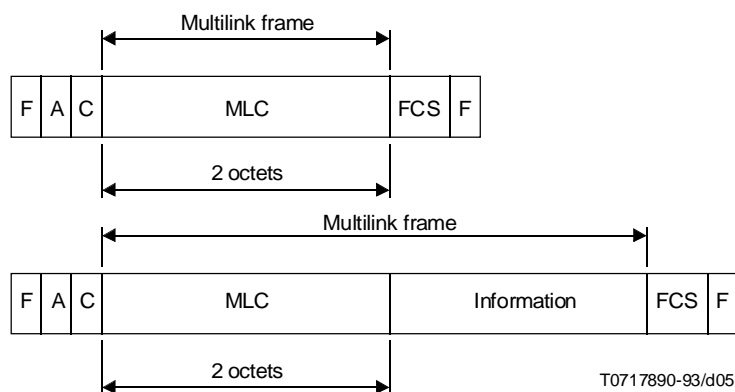

2.5.2.1 Multilink control field

The MultiLink Control field (MLC) consists of two octets, and its contents are described in 2.5.3.

2.5.2.2 Multilink information field

The information field of a multilink frame, when present, follows the MLC. See 2.5.3.2.3 and 2.5.3.2.4 for the various codings and groupings of bits in the multilink information field.

2.5.3 Multilink control field format and parameters

2.5.3.1 Multilink control field format

The relationship shown in Table 2-16 exists between the order of bits delivered to/received from an SLP and the coding of the fields in the multilink control field.

2.5.3.2 Multilink control field parameters

The various parameters associated with the multilink control field format are described below. See Table 2-16 and Figure 2-3.

TABLE 2-16/X.25
Multilink control field format

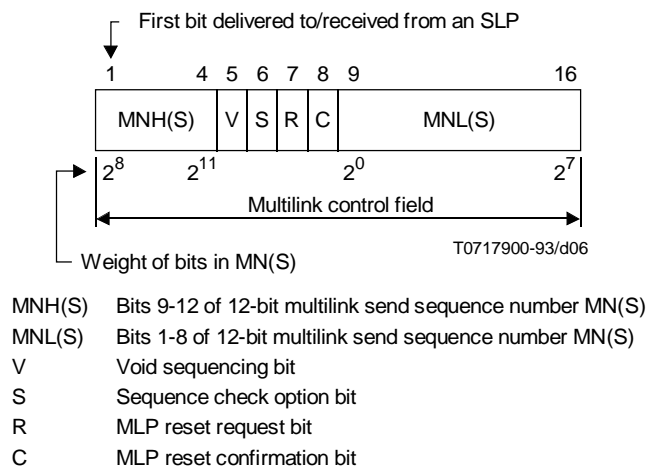

2.5.3.2.1 Void sequencing bit (V)

The void sequencing bit (V) indicates if a received multilink frame shall be subjected to sequencing constraints. V set to 1 means sequencing shall not be required. V set to 0 means sequencing shall be required.

NOTE – For the purposes of this Recommendation, this bit shall be set to 0.

2.5.3.2.2 Sequence check option bit (S)

The sequence check option bit (S) is only significant when V is set to 1 (indicating that sequencing of received multilink frames shall not be required). S set to 1 shall mean no MN(S) number has been assigned. S set to 0 shall mean an MN(S) number has been assigned, so that although sequencing shall not be required, a duplicate multilink frame check may be made, as well as a missing multilink frame identified.

NOTE – For the purposes of this Recommendation, this bit shall be set to 0.

2.5.3.2.3 MLP reset request bit (R)

The MLP reset request bit (R) is used to request a multilink reset (see 2.5.4.2). R set to 0 is used in normal communication, i.e. no request for a multilink reset. R set to 1 is used by the DCE MLP or DTE MLP to request the reset of the DTE MLP or DCE MLP state variables, respectively. In this R = 1 case, the multilink information field does not contain Packet Layer information, but may contain an optional 8-bit cause field that incorporates the reason for the reset.

NOTE – The encoding of the cause field is a subject for further study.

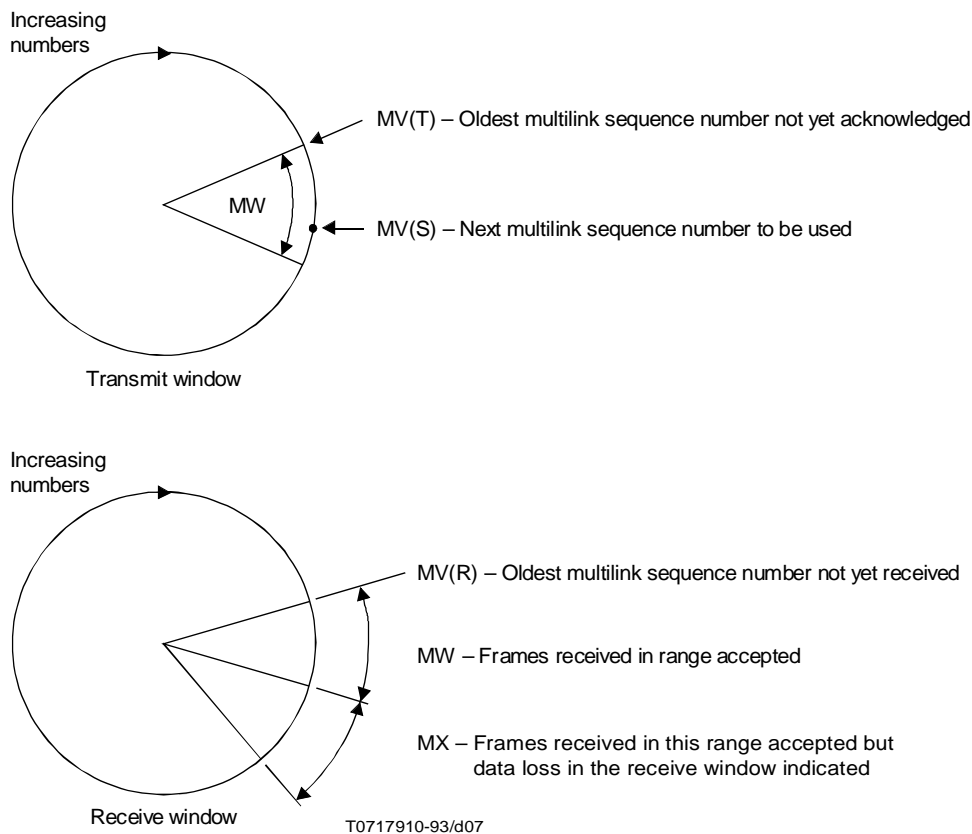

FIGURE 2-3/X.25
Parameters

2.5.3.2.4 MLP reset confirmation bit (C)

The MLP reset confirmation bit (C) is used in reply to an R bit set to 1 (see 2.5.3.2.3) to confirm the resetting of the multilink state variables (see 2.5.4.2). C set to 0 is used in normal communications, i.e. no multilink reset request has been activated. C set to 1 is used by the DCE MLP or DTE MLP in reply to a DTE MLP or DCE MLP multilink frame, respectively, with R set to 1, and indicates that the DCE MLP or DTE MLP state variable reset process has been completed by the DCE or DTE, respectively. In this $C = 1$ case, the multilink frame is used without an information field.

2.5.3.2.5 Multilink send state variable MV(S)

The multilink send state variable MV(S) denotes the sequence number of the next in-sequence multilink frame to be assigned to an SLP. This variable can take on the value 0 through 4095 (modulo 4096). The value of MV(S) is incremented by 1 with each successive multilink frame assignment.

2.5.3.2.6 Multilink sequence number MN(S)

Multilink frames contain the multilink sequence number MN(S). Prior to the assignment of an in-sequence multilink frame to an available SLP, the value of MN(S) is set equal to the value of the multilink send state variable MV(S). The multilink sequence number is used to resequence and to detect missing and duplicate multilink frames at the receiver before the contents of a multilink frame information field is delivered to the Packet Layer.

2.5.3.2.7 Transmitted multilink frame acknowledged state variable MV(T)

MV(T) is the state variable at the transmitting DCE MLP or DTE MLP denoting the oldest multilink frame which is awaiting an indication that a DCE SLP or DTE SLP has received an acknowledgement from its remote DTE SLP or DCE SLP, respectively. This variable can take on the value 0 through 4095 (modulo 4096). Some multilink frames with sequence numbers higher than MV(T) may already have been acknowledged.

2.5.3.2.8 Multilink receive state variable MV(R)

The multilink receive state variable MV(R) denotes the sequence number at the receiving DCE MLP or DTE MLP of the next in-sequence multilink frame to be received and delivered to the Packet Layer. This variable can take on the value 0 through 4095 (modulo 4096). The value of MV(R) is updated as described in 2.5.4.3.2 below. Multilink frames with higher sequence numbers in the DCE MLP or DTE MLP receive window may already have been received.

2.5.3.2.9 Multilink window size MW

MW is the maximum number of sequentially numbered multilink frames that the DCE MLP or DTE MLP may transfer to its SLPs beyond the lowest numbered multilink frame, whether or not transmitted by the SLP, which has not yet been acknowledged. MW is a system parameter which can never exceed 4095 – MX. The value of MW shall be agreed for a period of time with the Administration and shall have the same value for both the DCE MLP and the DTE MLP for a given direction of information transfer.

NOTE – Factors which will affect the value of parameter MW include, but are not limited to, single link transmission and propagation delays, the number of links, the range of multilink frame lengths, and SLP parameters N2, T1, and *k*.

The MLP transmit window contains the sequence numbers MV(T) to MV(T) + MW – 1 inclusive.

The MLP receive window contains the sequence numbers MV(R) to MV(R) + MW – 1 inclusive. Any multilink frame received within this window shall be delivered to the Packet Layer when its MN(S) becomes the same as MV(R).

2.5.3.2.10 Receive MLP window guard region MX

MX is a system parameter which defines a guard region of multilink sequence numbers of fixed size beginning at MV(R) + MW. The range of MX shall be large enough for the receiving MLP to recognize the highest MN(S) outside of its receive window that it may legitimately receive after a multilink frame loss has occurred.

A multilink frame with sequence number MN(S) = Y received in this guard region indicates that those missing multilink frame(s) in the range MV(R) to Y – MW has (have) been lost. MV(R) is then updated to Y – MW + 1.

NOTE – A number of methods may be selected in calculating a value for the guard region MX:

- a) in a system where the transmitting MLP assigns h_i in-sequence contiguous multilink frames at a time to the i th SLP, MX should be greater than or equal to the sum of the $h_i + 1 - h_{min}$, where h_{min} equals the smallest h_i encountered. Where there are L SLPs in the multilink group, MX should be greater than or equal to:

$$\sum_{i=1}^L h_i + 1 - h_{min}; \text{ or}$$

- b) in a system where the transmitting MLP assigns on a rotation basis h in-sequence contiguous multilink frames at a time to each SLP, MX at the receiving MLP should be greater than or equal to $h(L - 1) + 1$, where L is the number of SLPs in the multilink group; or
- c) MX should be no larger than MW.

Additional methods of selecting MX values are for further study.

2.5.4 Description of MultiLink Procedure (MLP)

The procedure below is presented from the perspective of the transmitter and receiver of multilink frames.

The arithmetic is performed modulo 4096.

2.5.4.1 Initialization

The DCE or DTE will perform an MLP initialization by first resetting MV(S), MV(T) and MV(R) to zero and then initializing each of its SLPs. Upon successful initialization of at least one of the SLPs, the DCE shall, and the DTE should, perform the multilink resetting procedure as described in 2.5.4.2. An SLP initialization is performed according to 2.4.4.1.

NOTE – An SLP that cannot be initialized should be declared out of service and appropriate recovery action should be taken.

2.5.4.2 Multilink resetting procedure

The multilink resetting procedure provides the mechanism for synchronizing the sending and receiving MLPs in both the DCE and the DTE, when deemed necessary by either the DCE or the DTE. Exact cases where the MLP resetting procedures are invoked is for further study. Following a successful multilink resetting procedure, the multilink sequence numbering in each direction begins with the value 0. Appendix III provides examples of the multilink resetting procedures when initiated by either the DCE or the DTE, or by both the DCE and the DTE simultaneously.

A multilink frame with R = 1 is used to request multilink reset, and a multilink frame with C = 1 confirms that the multilink reset process has been completed. An MLP resets MV(S) and MV(T) to zero on transfer of a multilink frame with R = 1; and resets MV(R) to zero on receipt of a multilink frame with R = 1.

When the DCE MLP or DTE MLP initiates the resetting procedure, it removes all of the unacknowledged multilink frames that are held in that MLP and its associated SLPs, and retains control of those frames. That is, the initiating MLP does not transfer a multilink frame with R = C = 0 until the reset process is completed. (One method to remove multilink frames in the SLP is to disconnect the data link of that SLP.) The initiating MLP then resets its multilink send state variable MV(S) and its transmitted multilink frame acknowledged state variable MV(T) to zero. The initiating MLP then transfers a multilink frame with R = 1 as a reset request on one of its SLPs and starts Timer MT3. The value of the MN(S) field in the R = 1 frame may be any value, since when R = 1 the MN(S) field is ignored by the receiving MLP. The initiating MLP continues to receive and process multilink frames from the remote MLP, in accordance with the procedures as described in 2.5.4.4 below until it receives a multilink frame with R = 1 from the remote MLP.

An MLP which has received a multilink frame with R = 1 (reset request) in the normal communication status from an initiating MLP starts the operation as described above; the MLP should receive no multilink frame with R = C = 0 from the other MLP until the reset process is completed. Any such multilink frame received is discarded. When an MLP has already initiated its own multilink resetting procedure and has transferred the multilink frame with R = 1 to one of its SLPs for transmission, that MLP does not repeat the above operation upon receipt of a multilink frame with R = 1 from the other MLP.

Receipt of a frame with R = 1 (reset request) causes the receiving MLP to deliver to the Packet Layer those packets already received and to identify those multilink frames assigned to SLPs but unacknowledged. The Packet Layer may be informed of the packet loss at the original value of MV(R) and at any subsequent value(s) of MV(R) for which there has been no multilink frame received up to and including the highest numbered multilink frame received. The receiving MLP then resets its multilink receive state variable MV(R) to zero.

After an MLP assigns a multilink frame with R = 1 to one of its SLPs, it shall receive indication of successful or unsuccessful transmission from that SLP as one of the conditions before transferring a multilink frame with C = 1; when the initiating MLP then receives a multilink frame with R = 1, and has completed the multilink state variable resetting operation described above, the initiating MLP transfers a multilink frame with C = 1 (reset confirmation) to the other MLP. When an MLP has:

- 1) received a multilink frame with R = 1;
- 2) transferred a multilink frame with R = 1 on one of its SLPs; and
- 3) completed the multilink state variable resetting operation above,

that MLP then transfers a multilink frame with C = 1 (reset confirmation) to the other MLP as soon as possible, given that indication of the successful or unsuccessful transmission of the R = 1 multilink frame has been received from that MLP's SLP. The C = 1 multilink frame is a reply to the multilink frame with R = 1. The value of the MN(S) field in the above C = 1 frame may be any value, since when C = 1 the MN(S) field is ignored by the receiving MLP. The multilink sequence number MN(S) received in each direction following multilink reset will begin with the value zero.

When an MLP uses only one SLP to transmit the multilink frame with $R = 1$ and the multilink frame with $C = 1$, the MLP can transfer the multilink frame with $C = 1$ immediately after the multilink frame with $R = 1$ without waiting for SLP indication of transmission completion. An MLP shall not retransmit a multilink frame with $R = 1$ or a multilink frame with $C = 1$ unless Timer MT3 (see 2.5.5.3 below) runs out. An MLP may use two different SLPs as long as one is used for transmitting the multilink frame with $R = 1$ and the other is used for transmitting the multilink frame with $C = 1$ following receipt of the SLP indication of successful or unsuccessful transmission of the $R = 1$ multilink frame. A multilink frame with $R = C = 1$ is never used.

When an MLP receives the multilink frame with $C = 1$, the MLP stops its Timer MT3. The transmission of the multilink frame with $C = 1$ to a remote SLP and the reception of a multilink frame with $C = 1$ from the remote MLP completes the multilink resetting procedure for an MLP. The first multilink frame transferred with $R = C = 0$ shall have a multilink sequence number $MN(S)$ value of zero. After an MLP transfers a multilink frame with $C = 1$ to an SLP, the MLP may receive one or more multilink frames with $R = C = 0$. After an MLP receives a multilink frame with $C = 1$, the MLP may transfer one or more multilink frames with $R = C = 0$ to its SLPs.

When an MLP additionally receives one or more multilink frames with $R = 1$ between receiving a multilink frame with $R = 1$ and transferring a multilink frame with $C = 1$, the MLP shall discard the extra multilink frames with $R = 1$. When an MLP receives a multilink frame with $C = 1$, which is not a reply to a multilink frame with $R = 1$, the MLP shall discard the multilink frame with $C = 1$.

After an MLP transfers a multilink frame with $C = 1$ on one of its SLPs, the MLP may receive a multilink frame with $R = 1$ from the other MLP. The MLP shall regard the multilink frame with $R = 1$ as a new reset request and shall start the multilink resetting procedure from the beginning. When an MLP which has not received a multilink frame with $R = 1$, transfers a multilink frame with $R = 1$, and therefore receives a multilink frame with $C = 1$, the MLP shall restart the resetting procedure from the beginning.

When Timer MT3 runs out, the MLP restarts the multilink resetting procedure from the beginning. The value of Timer MT3 shall be large enough to include the transmission, retransmission and propagation delays in the SLPs, and the operation time of the MLP that receives a multilink frame with $R = 1$ and responds with a multilink frame with $C = 1$.

2.5.4.3 Transmitting multilink frames

2.5.4.3.1 General

The transmitting DCE or DTE MLP shall be responsible for controlling the flow of packets from the Packet Layer into multilink frames and then to the SLPs for transmission to the receiving DTE or DCE MLP, respectively.

The functions of the transmitting DCE or DTE MLP shall be to:

- a) accept packets from the Packet Layer;
- b) allocate multilink control fields, containing the appropriate sequence number $MN(S)$, to the packets;
- c) assure that $MN(S)$ is not assigned outside the MLP transmit window (MW);
- d) pass the resultant multilink frames to the SLPs for transmission;
- e) accept indications of successful transmission acknowledgements from the SLPs;
- f) monitor and recover from transmission failures or difficulties that occur at the SLP sublayer; and
- g) accept flow control indications from the SLPs and take appropriate actions.

2.5.4.3.2 Transmission of multilink frames

When the transmitting DCE MLP accepts a packet from the Packet Layer, it shall place the packet in a multilink frame, set the $MN(S)$ equal to $MV(S)$, assure that $MN(S)$ is not assigned outside the transmit window (MW), set V , S , R and C to 0, and then increment $MV(S)$ by 1.

In the following, incrementing send and receive state variables is in reference to a continuously repeated sequence series, i.e. 4095 is 1 higher than 4094, and 0 is 1 higher than 4095 for modulo 4096 series.

If the $MN(S)$ is less than $MV(T) + MW$, and the DTE has not indicated a busy condition on all available DCE SLPs, the transmitting DCE MLP may then assign the new multilink frame to an available DCE SLP. The transmitting DCE MLP shall always assign the lowest $MN(S)$ unassigned multilink frame first. Also, the transmitting DCE MLP may assign a multilink frame to more than one DCE SLP. When the DCE SLP successfully completes the transmission of (a) multilink frame(s) by receiving an acknowledgement from the DTE SLP, it shall indicate this to the transmitting DCE MLP. The transmitting DCE MLP may then discard the acknowledged multilink frame(s). As the transmitting DCE receives new indications of acknowledgements from the DCE SLPs, $MV(T)$ shall be advanced to denote the lowest numbered multilink frame not yet acknowledged.

Whenever a DCE SLP indicates that it has attempted to transmit a multilink frame $N2$ times, the DCE MLP will then assign the multilink frame to the same or one or more other DCE SLPs unless the $MN(S)$ has been acknowledged on some previous DCE SLP. The DCE MLP shall always assign the lowest $MN(S)$ multilink frame first.

NOTE 1 – If a DCE MLP implementation is such that a multilink frame is assigned to more than one DCE SLP (e.g. to increase the probability of successful delivery) there is a possibility that one of these multilink frames (i.e. a duplicate) may be delivered to the remote DTE MLP after an earlier one has been acknowledged [the earlier multilink frame would have resulted in the receiving DTE MLP having incremented its $MV(R)$ and the transmitting DCE MLP having incremented its $MV(T)$]. To ensure that an old duplicate multilink frame is not mistaken for a new frame by the receiving DTE MLP, it is required that the transmitting DCE MLP shall never assign to a DCE SLP a new multilink frame with $MN(S)$ equal to $MN(S)' - MW - MX$, where $MN(S)'$ is associated with a duplicate multilink frame that was earlier assigned to other DCE SLPs, until all DCE SLPs have either successfully transmitted the multilink frame $MN(S)'$ or have attempted the transmission the maximum number of times. Alternatively, the incrementing of $MV(T)$ may be withheld until all DCE SLPs that were assigned the multilink frame $MN(S)'$ have either successfully transferred the multilink frame $MN(S)'$ or have attempted the transmission the maximum number of times. These and other alternatives are for further study.

Flow control is achieved by the window size parameter MW , and through busy conditions being indicated by the DTE SLPs.

The DCE MLP will not assign a multilink frame with an $MN(S)$ greater than $MV(T) + MW - 1$. At the point where the next DCE multilink frame to be assigned has an $MN(S) = MV(T) + MW$, the DCE MLP shall hold this and subsequent multilink frames until an indication of an acknowledgement that advances $MV(T)$ is received from the DCE SLPs.

The DTE MLP may exercise flow control of the DCE MLP by indicating a busy condition over one or more DTE SLPs. The number of SLPs made busy will determine the degree of DCE MLP flow control realized. When the DCE MLP receives an indication of a DTE SLP busy condition from one or more of its DCE SLPs, the DCE MLP may reassign any unacknowledged multilink frames that were assigned to those DCE SLPs. The DCE MLP will assign the multilink frames containing the lowest $MN(S)$ to an available DCE SLP as specified above.

NOTE 2 – The action to be taken on the receipt of an RNR frame by the DCE SLP whose unacknowledged multilink frames have been reassigned is for further study.

In the event of a circuit failure, a DCE SLP reset, or a DCE SLP or DTE SLP disconnection, all DCE MLP multilink frames that were unacknowledged on the affected DCE SLPs shall be reassigned to an operational DCE SLP(s) which is (are) not in the busy condition.

NOTE 3 – The means of detecting transmitting DCE MLP malfunctions (e.g. sending more than MW multilink frames) and the actions to be taken are for further study.

2.5.4.4 Receiving multilink frames

Any multilink frame less than two octets in length shall be discarded by the receiving DCE MLP.

NOTE 1 – The procedures to be followed by the receiving DCE MLP when V and/or S is equal to 1 are for further study. The procedures to be followed by the receiving DCE MLP when R or C is equal to 1 are described in 2.5.4.2 above.

When the DCE MLP receives multilink frames from one of the DCE SLPs, the DCE MLP will compare the multilink sequence number $MN(S)$ of the received multilink frame to its multilink receive state variable $MV(R)$, and act on the multilink frame as follows:

- a) If the received $MN(S)$ is equal to the current value of $MV(R)$, i.e. is the next expected in-sequence multilink frame, the DCE MLP delivers the packet to the Packet Layer.

- b) If the $MN(S)$ is greater than the current value of $MV(R)$ but less than $MV(R) + MW + MX$, the DCE MLP keeps the received multilink frame until condition a) is met, or discards it if it is a duplicate.
- c) If the $MN(S)$ is other than in a) and b) above, the multilink frame is discarded.

NOTE 2 – In case c) above, the recovery from desynchronization greater than MX between the local and the remote MLP, i.e. the value of $MN(S)$ reassigned to new multilink frames at the remote MLP is higher than $MV(R) + MW + MX$ at the local MLP, is for further study.

On receipt of each multilink frame, $MV(R)$ is incremented by the DCE MLP in the following way:

- i) If $MN(S)$ is equal to the current value of $MV(R)$, the $MV(R)$ is incremented by the number of consecutive in-sequence multilink frames that have been received. If additional multilink frames are awaiting delivery pending receipt of a multilink frame with $MN(S)$ equal to the updated $MV(R)$, then Timer MT1 (see 2.5.5.1 below) is restarted; otherwise Timer MT1 is stopped.
- ii) If $MN(S)$ is greater than the current value of $MV(R)$ but less than $MV(R) + MW$, $MV(R)$ remains unchanged. Timer MT1 is started, if not already running.
- iii) If $MN(S)$ is $MV(R) + MW$ but $< MV(R) + MW + MX$, $MV(R)$ is incremented to $MN(S) - MW + 1$ and then the Packet Layer may be informed of the packet loss at the original value of $MV(R)$. As $MV(R)$ is being incremented, if any multilink frame with $MN(S) = MV(R)$ has not yet been received, the Packet Layer may be informed of that packet loss also; if the multilink frame with $MN(S) = MV(R)$ has been received, it is delivered to the Packet Layer. After $MV(R)$ reaches $MN(S) - MW + 1$, it will then be incremented further [as in i) above] until the first unacknowledged $MN(S)$ is encountered. See Figure 2-4.
- iv) If the $MN(S)$ is other than that in i), ii) and iii) above, $MV(R)$ remains unchanged.

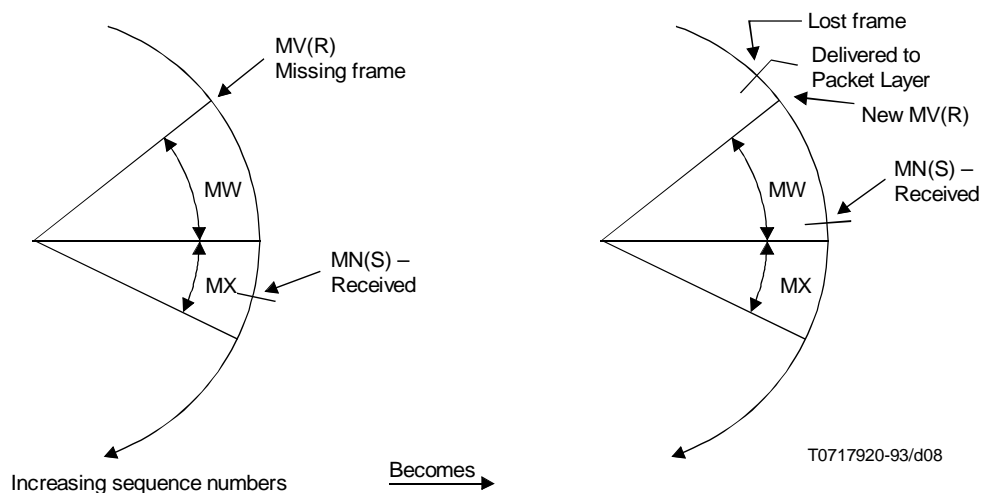

FIGURE 2-4/X.25
Detecting lost multilink frames

If Timer MT1 runs out, MV(R) is incremented to the MN(S) of the next multilink frame awaiting delivery to the Packet Layer and then the Packet Layer may be informed of the packet loss at the original MV(R). The procedure follows a) and i) above as long as there are consecutive in-sequence multilink frames which have been received.

When flow control of the DTE MLP is desired, one or more DCE SLP(s) may be made to indicate a busy condition. The number of DCE SLPs made busy determines the degree of flow control realized.

If the DCE MLP can exhaust its receive buffer capacity before resequencing can be completed, Timer MT2 (see 2.5.5.2 below) may be implemented. Whenever a busy condition is indicated by the DCE MLP on all DCE SLPs, and multilink frames at the DCE MLP are awaiting resequencing, Timer MT2 shall be started. When the busy condition is cleared on one or more DCE SLPs by the DCE MLP, Timer MT2 shall be stopped.

If Timer MT2 runs out, the multilink frame with MN(S) = MV(R) is blocked and shall be considered lost. MV(R) shall be incremented to the next sequence number not yet received, and the packets contained in multilink frames with intervening multilink sequence numbers are delivered to the Packet Layer. Timer MT2 shall be restarted if the busy condition remains in effect on all DCE SLPs and more multilink frames are awaiting resequencing.

2.5.4.5 Taking an SLP out of service

A DCE SLP may be taken out of service for maintenance, traffic, or performance considerations.

A DCE SLP is taken out of service by disconnecting at the Physical Layer or the Data Link Layer. Any outstanding DCE MLP multilink frames will be reassigned to one or more other DCE SLPs, unless the MN(S) has been previously acknowledged on some other DCE SLP. The usual procedure for taking a DCE SLP out of service at the Data Link Layer would be to flow control the DTE SLP with an RNR frame, and then logically disconnect the DCE SLP (see 2.4.4.3 above).

If the DCE SLP Timer T1 has run out N2 times and the DCE SLP data link resetting procedure is unsuccessful, then the DCE SLP will enter the disconnected phase, taking the DCE SLP out of service (see 2.4.5.8 and 2.4.7.2 above).

NOTE – In the case where all SLPs are out of service, the recovery mechanism is based on initiating the multilink resetting procedures. Other recovery procedures are for further study.

2.5.5 List of multilink system parameters

2.5.5.1 Lost-frame Timer MT1 (multilink)

Timer MT1 is used at a receiving DCE MLP to provide a means to identify during low traffic periods that the multilink frame with MN(S) equal to MV(R) is lost.

2.5.5.2 Group busy Timer MT2 (multilink)

Timer MT2 is provided at a receiving DCE MLP to identify a “blocked” multilink frame condition (e.g. a buffer exhaust situation) that occurs before required resequencing can be accomplished. Timer MT2 is started when all DCE SLPs are busy and there are multilink frames awaiting resequencing. If Timer MT2 runs out before the “blocked” multilink frame MV(R) is received, the “blocked” multilink frame(s) is (are) declared lost. MV(R) is incremented to the value of the next in-sequence multilink frame to be received, and any packets in intervening multilink frames are delivered to the Packet Layer.

NOTE – Timer MT2 may be set to infinity, e.g. when the receiving DCE always has sufficient storage capacity.

2.5.5.3 MLP reset confirmation Timer MT3 (multilink)

Timer MT3 is used by the DCE MLP to provide a means of identifying that the DTE MLP multilink frame with the C bit set to 1 that is expected following the transmission of the DCE MLP multilink frame with the R bit set to 1, has not been received.

3 Description of the packet layer DTE/DCE interface

This clause and subsequent clauses relate to the transfer of packets at the DTE/DCE interface. The procedures apply to packets which are successfully transferred across the DTE/DCE interface.

Each packet to be transferred across the DTE/DCE interface shall be contained within the data link layer information field which will delimit its length, and only one packet shall be contained in the information field.

NOTE – Some networks require the data fields of packets to contain an integral number of octets. The transmission by the DTE of data fields not containing an integral number of octets to the network may cause a loss of data integrity. DTEs wishing universal operation on all networks should transmit all packets with data fields containing only an integral number of octets. Full data integrity can only be assured by exchange of octet-oriented data fields in both directions of transmission.

This clause covers a description of the packet layer interface for virtual call and permanent virtual circuit services.

Procedures for the virtual circuit service (i.e. virtual call and permanent virtual circuit services) are specified in clause 4. Packet formats are specified in clause 5. Procedures and formats for optional user facilities are specified in clauses 6 and 7.

3.1 Logical channels

To enable simultaneous virtual calls and/or permanent virtual circuits, logical channels are used. Each virtual call or permanent virtual circuit is assigned a logical channel group number (less than or equal to 15) and a logical channel number (less than or equal to 255). For virtual calls, a logical channel group number and a logical channel number are assigned during the call set-up phase. The range of logical channels used for virtual calls is agreed with the Administration at the time of subscription to the service (see Annex A). For permanent virtual circuits, logical channel group numbers and logical channel numbers are assigned in agreement with the Administration at the time of subscription to the service (see Annex A).

3.2 Basic structure of packets

Every packet transferred across the DTE/DCE interface consists of at least three octets. These three octets contain a general format identifier, a logical channel identifier and a packet type identifier. Other packet fields are appended as required (see clause 5).

Packet types and their use in association with various services are given in Table 3-1.

3.3 Procedure for restart

The restart procedure is used to initialize or reinitialize the packet layer DTE/DCE interface. The restart procedure simultaneously clears all the virtual calls and resets all the permanent virtual circuits at the DTE/DCE interface (see 4.5).

Figure B.1 gives the state diagram which defines the logical relationships of events related to the restart procedure.

Table C.2 specifies actions taken by the DCE on the receipt of packets from the DTE for the restart procedure.

3.3.1 Restart by the DTE

The DTE may at any time request a restart by transferring across the DTE/DCE interface a *restart request* packet. The interface for each logical channel is then in the *DTE restart request* state (r2).

The DCE will confirm the restart by transferring a *DCE restart confirmation packet* and placing the logical channels used for virtual calls in the *ready* state (p1), and the logical channels used for permanent virtual circuits in the *flow control ready* state (d1).

NOTE – States p1 and d1 are specified in clause 4.

The *DCE restart confirmation* packet can only be interpreted universally as having local significance. The time spent in the *DTE restart request* state (r2) will not exceed time-limit T20 (see Annex D).

TABLE 3-1/X.25

Packet types and their use in various services

Packet type		Service	
		VC	PVC
From DCE to DTE	From DTE to DCE		
<i>Call set-up and clearing</i> (Note 1)			
Incoming call	Call request	X	
Call connected	Call accepted	X	
Clear indication	Clear request	X	
DCE clear confirmation	DTE clear confirmation	X	
<i>Data and interrupt</i> (Note 2)			
DCE data	DTE data	X	X
DCE interrupt	DTE interrupt	X	X
DCE interrupt confirmation	DTE interrupt confirmation	X	X
<i>Flow control and reset</i> (Note 3)			
DCE RR	DTE RR	X	X
DCE RNR	DTE RNR	X	X
	DTE REJ ^{a)}	X	X
Reset indication	Reset request	X	X
DCE reset confirmation	DTE reset confirmation	X	X
<i>Restart</i> (Note 4)			
Restart indication	Restart request	X	X
DCE restart confirmation	DTE restart confirmation	X	X
<i>Diagnostic</i> (Note 5)			
Diagnostic ^{a)}		X	X
VC Virtual Call PVC Permanent Virtual Circuit ^{a)} Not necessarily available on all networks. NOTES 1 See 4.1 and 6.16 for procedures, 5.2 for formats. 2 See 4.3 for procedures and 5.3 for formats. 3 See 4.4 and 6.4 for procedures, 5.4 and 5.7.1 for formats. 4 See 3.3 for procedures and 5.5 for formats. 5 See 3.4 for procedures and 5.6 for formats.			

3.3.2 Restart by the DCE

The DCE may indicate a restart by transferring across the DTE/DCE interface a *restart indication* packet. The interface for each logical channel is then in the *DCE restart indication* state (r3). In this state of the DTE/DCE interface, the DCE will ignore all packets except for *restart request* and *DTE restart confirmation*.

The DTE will confirm the restart by transferring a *DTE restart confirmation* packet and placing the logical channels used for virtual calls in the *ready* state (p1), and the logical channels used for permanent virtual circuits in the *flow control ready* state (d1).

The action taken by the DCE when the DTE does not confirm the restart within time-out T10 is given in Annex D.

3.3.3 Restart collision

Restart collision occurs when a DTE and a DCE simultaneously transfer a *restart request* and a *restart indication* packet. Under these circumstances, the DCE will consider that the restart is completed. The DCE will not expect a *DTE restart confirmation* packet and will not transfer a *DCE restart confirmation* packet. This places the logical channels used for virtual calls in the *ready* state (p1), and the logical channels used for permanent virtual circuits in the *flow control ready* state (d1).

3.4 Error handling

Table C.1 specifies the reaction of the DCE when special error conditions are encountered. Other error conditions are discussed in clause 4.

3.4.1 Diagnostic packet

The *diagnostic* packet is used by some networks to indicate error conditions under circumstances where the usual methods of indication (i.e. *reset*, *clear* and *restart* with cause and diagnostic) are inappropriate (see Tables C.1 and C.2). The *diagnostic* packet from the DCE supplies information on error situations which are considered unrecoverable at the packet layer of this Recommendation; the information provided permits an analysis of the error and recovery by higher layers at the DTE if desired or possible.

A *diagnostic* packet is issued only once per particular instance of an error condition. No confirmation is required to be issued by the DTE on receipt of a *diagnostic* packet.

4 Procedures for virtual circuit services

4.1 Procedures for virtual call service

Figures B.1, B.2 and B.3 show the state diagrams which define the events at the packet layer DTE/DCE interface for each logical channel used for virtual calls.

Annex C gives details of the action taken by the DCE on receipt of packets in each state shown in Annex B.

The call set-up and clearing procedures described in the following subclauses apply independently to each logical channel assigned to the virtual call service at the DTE/DCE interface.

4.1.1 Ready state

If there is no call in existence, a logical channel is in the *ready* state (p1).

4.1.2 Call request packet

The calling DTE shall indicate a call request by transferring a *call request* packet across the DTE/DCE interface. The logical channel selected by the DTE is then in the *DTE waiting* state (p2). The *call request* packet includes the called DTE address.

NOTES

1 A DTE address may be a DTE network address or any other DTE identification agreed for a period of time between the DTE and the DCE.

2 The called DTE address will either conform to the formats described in Recommendations X.121 and X.301 or will be an alternative address.

3 The *call request* packet should use the logical channel in the *ready* state with the highest number in the range which has been agreed with the Administration (see Annex A). Thus the risk of call collision is minimized.

4.1.3 Incoming call packet

The DCE will indicate that there is an incoming call by transferring across the DTE/DCE interface an *incoming call* packet. This places the logical channel in the *DCE waiting* state (p3).

The *incoming call* packet will use the logical channel in the *ready* state with the lowest number (see Annex A). The *incoming call* packet includes the calling DTE address.

NOTE – A DTE address may be a DTE network address or any other DTE identification agreed for a period of time between the DTE and the DCE.

4.1.4 Call accepted packet

The called DTE shall indicate its acceptance of the call by transferring across the DTE/DCE interface a *call accepted* packet specifying the same logical channel as that of the *incoming call* packet. This places the specified logical channel in the *data transfer* state (p4).

If the called DTE does not accept the call by a *call accepted* packet or does not reject it by a *clear request* packet as described in 4.1.7 within time-out T11 (see Annex D), the DCE will consider it as a procedure error from the called DTE and will clear the virtual call according to the procedure described in 4.1.8.

4.1.5 Call connected packet

The receipt of a *call connected* packet by the calling DTE specifying the same logical channel as that specified in the *call request* packet indicates that the call has been accepted by the called DTE by means of a *call accepted* packet. This places the specified logical channel in the *data transfer* state (p4).

The time spent in the *DTE waiting* state (p2) will not exceed time-limit T21 (see Annex D).

4.1.6 Call collision

Call collision occurs when a DTE and DCE simultaneously transfer a *call request* packet and an *incoming call* packet specifying the same logical channel. The DCE will proceed with the *call request* and cancel the *incoming call*.

4.1.7 Clearing by the DTE

At any time, the DTE may indicate clearing by transferring across the DTE/DCE interface a *clear request* packet (see 4.5). The logical channel is then in the *DTE clear request* state (p6). When the DCE is prepared to free the logical channel, the DCE will transfer across the DTE/DCE interface a *DCE clear confirmation* packet specifying the logical channel. The logical channel is then in the *ready* state (p1).

The *DCE clear confirmation* packet can only be interpreted universally as having local significance; however, within some Administrations' networks, clear confirmation may have end-to-end significance. In all cases, the time spent in the *DTE clear request* state (p6) will not exceed time-limit T23 (see Annex D).

It is possible that subsequent to transferring a *clear request* packet the DTE will receive other types of packets, depending upon the state of the logical channel, before receiving a *DCE clear confirmation* packet.

NOTE – The calling DTE may abort a call by clearing it before it has received a *call connected* or *clear indication* packet.

The called DTE may refuse an incoming call by clearing it as described in this subclause rather than transmitting a *call accepted* packet as described in 4.1.4.

4.1.8 Clearing by the DCE

The DCE will indicate clearing by transferring across the DTE/DCE interface a *clear indication* packet (see 4.5). The logical channel is then in the *DCE clear indication* state (p7). The DTE shall respond by transferring across the DTE/DCE interface a *DTE clear confirmation* packet. The logical channel is then in the *ready* state (p1).

The action taken by the DCE when the DTE does not confirm clearing within time-out T13 is given in Annex D.

4.1.9 Clear collision

Clear collision occurs when a DTE and DCE simultaneously transfer a *clear request* packet and a *clear indication* packet specifying the same logical channel. Under these circumstances the DCE will consider that the clearing is completed. The DCE will not expect a *DTE clear confirmation* packet and will not transfer a *DCE clear confirmation* packet. This places the logical channel in the *ready* state (p1).

4.1.10 Unsuccessful call

If a call cannot be established, the DCE will transfer a *clear indication* packet specifying the logical channel indicated in the *call request* packet.

4.1.11 Call progress signals

The DCE will be capable of transferring to the DTE *clearing call progress* signals as specified in Recommendation X.96.

Clearing call progress signals will be carried in *clear indication* packets which will terminate the call to which the packet refers. The method of coding *clear indication* packets containing *call progress* signals is detailed in 5.2.3.

4.1.12 Data transfer state

The procedures for the control of packets between DTE and DCE while in the *data transfer* state are contained in 4.3.

4.2 Procedures for permanent virtual circuit service

Figures B.1 and B.3 show the state diagrams which give a definition of events at the packet layer DTE/DCE interface for logical channels assigned for permanent virtual circuits.

Annex C gives details of the action taken by the DCE on receipt of packets in each state shown in Annex B.

For permanent virtual circuits there is no call set-up or clearing. The procedures for the control of packets between DTE and DCE while in the *data transfer* state are contained in 4.3.

If a momentary failure occurs within the network, the DCE will reset the permanent virtual circuit as described in 4.4.3, with the cause "Network congestion", and then will continue to handle data traffic.

If the network has a temporary inability to handle data traffic, the DCE will reset the permanent virtual circuit with the cause "Network out of order". When the network is again able to handle data traffic, the DCE should reset the permanent virtual circuit with the cause "Network operational".

4.3 Procedures for data and interrupt transfer

The data transfer and interrupt procedures described in this subclause apply independently to each logical channel assigned for virtual calls or permanent virtual circuits existing at the DTE/DCE interface.

Normal network operation dictates that user data in *data* and *interrupt* packets are all passed transparently, unaltered through the network in the case of packet DTE to packet DTE communications. The order of bits in *data* and *interrupt* packets is preserved. Packet sequences are delivered as complete packet sequences. DTE diagnostic codes are treated as described in 5.2.4, 5.4.3 and 5.5.1.

4.3.1 States for data transfer

A virtual call logical channel is in the *data transfer* state (p4) after completion of call establishment and prior to a clearing or a restart procedure. A permanent virtual circuit logical channel is continually in the *data transfer* state (p4) except during the restart procedure. *Data*, *interrupt*, *flow control* and *reset* packets may be transmitted and received by a DTE in the *data transfer* state of a logical channel at the DTE/DCE interface. In this state, the flow control and reset procedures described in 4.4 apply to data transmission on that logical channel to and from the DTE.

When a virtual call is cleared, *data* and *interrupt* packets may be discarded by the network (see 4.5). In addition, *data*, *interrupt*, *flow control* and *reset* packets transmitted by a DTE will be ignored by the DCE when the logical channel is in the *DCE clear indication* state (p7). Hence it is left to the DTE to define DTE to DTE protocols able to cope with the various possible situations that may occur.

4.3.2 User data field length of data packets

The standard maximum user data field length is 128 octets.

In addition, other maximum user data field lengths may be offered by Administrations from the following list: 16, 32, 64, 256, 512, 1024, 2048 and 4096 octets. An optional maximum user data field length may be selected for a period of time as the default maximum user data field length common to all virtual calls at the DTE/DCE interface (see 6.9).

A value other than the default may be selected for a period of time for each permanent virtual circuit (see 6.9). Negotiation of maximum user data field lengths on a per call basis may be made with the *flow control parameter negotiation* facility (see 6.12).

The user data field of *data* packets transmitted by a DTE or DCE may contain any number of bits up to the agreed maximum.

NOTE – Some networks require the user data field to contain an integral number of octets (see the Note in clause 3).

If the user data field in a *data* packet exceeds the locally permitted maximum user data field length, then the DCE will reset the virtual call or permanent virtual circuit with the resetting cause “Local procedure error”.

4.3.3 Delivery Confirmation bit

When supported by the network at the DTE/DCE interface, the setting of the Delivery Confirmation bit (D bit) is used to indicate whether or not the DTE wishes to receive an end-to-end acknowledgement of delivery, for data it is transmitting, by means of the packet receive sequence number P(R) (see 4.4).

NOTE – The use of the D-bit procedure does not obviate the need for a higher layer protocol agreed between the communicating DTEs which may be used with or without the D-bit procedure to recover from user or network generated resets and clearings.

The calling DTE may, during call establishment, ascertain that the D-bit procedure can be used for the call by setting bit 7 in the General Format Identifier of the *call request* packet to 1 (see 5.1.2). Every network or part of the international network supporting the D-bit procedure will pass this bit transparently. If a network or part of the international network crossed by the call does not support the D-bit procedure, it will reset this bit to 0. If the remote DTE is able to handle the D-bit procedure, it should not regard this bit being set to 1 in the *incoming call* packet as invalid.

Similarly, the called DTE can set bit 7 in the General Format Identifier of the *call accepted* packet to 1. Every network or part of the international network supporting the D-bit procedure will pass this bit transparently. If the network or part of the international network crossed by the call does not support the D-bit procedure, it will reset this bit to 0. If the calling DTE is able to handle the D-bit procedure, it should not regard this bit being set to 1 in the *call connected* packet as invalid.

The use by DTEs of the above mechanism in the *call request* and *call accepted* packets is recommended but is not mandatory for using the D-bit procedure during the virtual call.

4.3.4 More data mark

If a DTE or DCE wishes to indicate a sequence of more than one packet, it uses a more data mark (M bit) as defined below.

The M bit can be set to 1 in any *data* packet. When it is set to 1 in a full *data* packet or in a partially full *data* packet also carrying the D bit set to 1, it indicates that more data is to follow. Recombination with the following *data* packet may only be performed within the network when the M bit is set to 1 in a full *data* packet which also has the D bit set to 0.

A sequence of *data* packets with every M bit set to 1 except for the last one will be delivered as a sequence of *data* packets with the M bit set to 1 except for the last one when the original packets having the M bit set to 1 are either full (irrespective of the setting of the D bit) or partially full but have the D bit set to 1.

Two categories of *data* packets, A and B, have been defined as shown in Table 4-1. Table 4-1 also illustrates the network's treatment of the M and D bits at both ends of a virtual call or permanent virtual circuit.

4.3.5 Complete packet sequence

A complete packet sequence is defined as being composed of a single *category B* packet and all contiguous preceding *category A* packets (if any). *Category A* packets have the exact maximum user data field length with the M bit set to 1 and the D bit set to 0. All other *data* packets are *category B* packets.

When transmitted by a source DTE, a complete packet sequence is always delivered to the destination DTE as a single complete packet sequence.

Thus, if the receiving end has a larger maximum user data field length than the transmitting end, then packets within a complete packet sequence will be combined within the network. They will be delivered in a complete packet sequence where each packet, except the last one, has the exact maximum user data field length, the M bit set to 1, and the D bit set to 0. The user data field of the last packet of the sequence may have less than the maximum length and the M and D bits are set as described in Table 4-1.

If the maximum user data field length is the same at both ends, then user data fields of *data* packets are delivered to the receiving DTE exactly as they have been received by the network, except as follows. If a full packet with the M bit set to 1 and the D bit set to 0 is followed by an empty packet, then the two packets may be merged so as to become a single *category B* full packet. If the last packet of a complete packet sequence transmitted by the source DTE has a data field less than the maximum length, the M bit set to 1 and the D bit set to 0, then the last packet of the complete packet sequence delivered to the receiving DTE will have the M bit set to 0.

If the receiving end has a smaller maximum user data field length than the transmitting end, the packets will be segmented within the network, and the M and D bits will be set by the network as described to maintain complete packet sequences.

TABLE 4-1/X.25

Definition of two categories of data packets and network treatment of the M and D bits

Data packet sent by source DTE				Combining with subsequent packet(s) is performed by the network when possible	Data packet ^{a)} received by destination DTE	
Category	M	D	Full		M	D
B	0 or 1	0	No	No	0 (Note 1)	0
B	0	1	No	No	0	1
B	1	1	No	No	1	1
B	0	0	Yes	No	0	0
B	0	1	Yes	No	0	1
A	1	0	Yes	Yes (Note 2)	1	0
B	1	1	Yes	No	1	1

^{a)} Refers to the delivered *data* packet whose last bit of user data corresponds to the last bit of user data, if any, that was present in the *data* packet sent by the source DTE.

NOTES

1 The originating network will force the M bit to 0.

2 If the *data* packet sent by the source DTE is combined with other packets, up to and including a *category B* packet, the M and D bit settings in the *data* packet received by the destination DTE will be according to that given in the two right hand columns for the last *data* packet sent by the source DTE that was part of the combination.

4.3.6 Qualifier bit

In some cases, an indicator may be needed with the user data field to distinguish between two types of information. It may be necessary to differentiate, for example, between user data and control information. An example of such a case is contained in Recommendation X.29.

If such a mechanism is needed, an indicator in the data packet header called the Qualifier bit (Q bit) may be used.

The use of the Q bit is optional. If this mechanism is not needed, the Q bit is always set to 0. If the Q bit mechanism is used, the transmitting DTE should set the Q bit so as to have the same value (i.e. 0 or 1) in all *data* packets of the same complete packet sequence. A complete packet sequence transferred by the DTE to the DCE in this fashion will be delivered to the distant DTE as a complete packet sequence having the Q bit set in all packets to the value assigned by the transmitting DTE.

If the Q bit is not set by the DTE to the same value in all the *data* packets of a complete packet sequence, the value of the Q bit in any of the *data* packets of the corresponding packet sequence transferred to the distant DTE is not guaranteed by the network. Moreover, some networks may reset the virtual call or permanent virtual circuit as described in Annex C.

Successive *data* packets are numbered consecutively (see 4.4.1.1) regardless of the value of the Q bit.

4.3.7 Interrupt procedure

The interrupt procedure allows a DTE to transmit data to the remote DTE, without following the flow control procedure applying to *data* packets (see 4.4). The interrupt procedure can only apply in the *flow control ready* state (d1) within the *data transfer* state (p4).

The interrupt procedure has no effect on the transfer and flow control procedures applying to the *data* packets on the virtual call or permanent virtual circuit.

To transmit an interrupt, a DTE transfers across the DTE/DCE interface a *DTE interrupt* packet. The DTE should not transmit a second *DTE interrupt* packet until the first one is confirmed with a *DCE interrupt confirmation* packet (see Table C.4). The DCE, after the interrupt procedure is completed at the remote end, will confirm the receipt of the interrupt by transferring a *DCE interrupt confirmation* packet. The receipt of a *DCE interrupt confirmation* packet indicates that the interrupt has been confirmed by the remote DTE by means of a *DTE interrupt confirmation* packet.

The DCE indicates an interrupt from the remote DTE by transferring across the DTE/DCE interface a *DCE interrupt* packet containing the same data field as in the *DTE interrupt* packet transmitted by the remote DTE. A *DCE interrupt* packet is delivered at or before the point in the stream of *data* packets at which the *DTE interrupt* packet was generated. The DTE will confirm the receipt of the *DCE interrupt* packet by transferring a *DTE interrupt confirmation* packet.

4.3.8 Transit delay of data packets

Transit delay is an inherent characteristic of a virtual call or a permanent virtual circuit, common to the two directions of transmission.

This transit delay is the *data* packet transfer delay as defined in 3.1/X.135, measured between boundaries B_2 and B_{n-1} , as defined in Figure 2/X.135 (that means, excluding the access lines), with the conditions given in 3.2/X.135, and is expressed in terms of a mean value.

Selection of transit delay on a per call basis, and indication to both the calling and called DTEs of the value of transit delay applying for a given virtual call, may be made by the means of the *transit delay selection and indication* facility (see 6.27).

4.4 Procedures for flow control

This subclause only applies to the *data transfer* state (p4) and specifies the procedures covering flow control of *data* packets and reset on each logical channel used for a virtual call or a permanent virtual circuit.

4.4.1 Flow control

At the DTE/DCE interface of a logical channel used for a virtual call or permanent virtual circuit, the transmission of *data* packets is controlled separately for each direction and is based on authorizations from the receiver.

On a virtual call or permanent virtual circuit, flow control also allows a DTE to limit the rate at which it accepts packets across the DTE/DCE interface, noting that there is a network-dependent limit on the number of *data* packets which may be in the network on the virtual call or permanent virtual circuit.

4.4.1.1 Numbering of data packets

Each *data* packet transmitted at the DTE/DCE interface for each direction of transmission in a virtual call or permanent virtual circuit is sequentially numbered.

The sequence numbering scheme of the packets is performed modulo 8. The packet sequence numbers cycle through the entire range 0 to 7. Some Administrations will provide the *extended packet sequence numbering* facility (see 6.2) which, if selected, provides a sequence numbering scheme for packets being performed modulo 128. In this case, packet sequence numbers cycle through the entire range 0 to 127. Some Administrations will provide the *super extended packet sequence numbering* facility (see 6.2) which, if selected, provides a sequence numbering scheme for packets being performed modulo 32 768. In this case, packet sequence numbers cycle through the entire range 0 to 32 767. The packet sequence numbering scheme, modulo 8, 128 or 32 768, is the same for both directions of transmission and is common for all logical channels at the DTE/DCE interface.

NOTE – In addition, some networks may apply the packet sequence numbering scheme individually to each logical channel at the DTE/DCE interface. When the network supports the use of multiple modulus at the same interface, for virtual calls the selection is made by signalling of the GFI, for permanent virtual circuits the modulo is established by subscription.

Only *data* packets contain this sequence number called the packet send sequence number P(S).

The first *data* packet to be transmitted across the DTE/DCE interface for a given direction of data transmission, when the logical channel has just entered the *flow control ready* state (d1), has a packet send sequence number equal to 0.

4.4.1.2 Window description

At the DTE/DCE interface, a window is defined for each direction of data transmission of a logical channel used for a virtual call or permanent virtual circuit. The window is the ordered set of *W* consecutive packet send sequence numbers of the *data* packets authorized to cross the interface.

The lowest sequence number in the window is referred to as the lower window edge. When a virtual call or permanent virtual circuit at the DTE/DCE interface has just entered the *flow control ready* state (d1), the window related to each direction of data transmission has a lower window edge equal to 0.

The packet send sequence number of the first *data* packet not authorized to cross the interface is the value of the lower window edge plus *W* (modulo 8, or 128 when extended, or 32 768 when super extended).

The standard window size *W* is 2 for each direction of data transmission at the DTE/DCE interface. In addition, other window sizes may be offered by Administrations. An optional window size may be selected for a period of time as the default window size common to all virtual calls at the DTE/DCE interface (see 6.10). A value other than the default may be selected for a period of time for each permanent virtual circuit (see 6.10). Negotiation of window sizes on a per call basis may be made with the *flow control parameter negotiation* facility (see 6.12).

4.4.1.3 Flow control principles

When the sequence number P(S) of the next *data* packet to be transmitted by the DCE is within the window, the DCE is authorized to transmit this *data* packet to the DTE. When the sequence number P(S) of the next *data* packet to be transmitted by the DCE is outside of the window, the DCE will not transmit a *data* packet to the DTE. The DTE should follow the same procedure.

When the sequence number P(S) of the *data* packet received by the DCE is the next in sequence and is within the window, the DCE will accept this *data* packet. A received *data* packet containing a P(S) that is out of sequence [i.e. there is a duplicate or a gap in the P(S) numbering], outside the window, or not equal to 0 for the first *data* packet after entering the *flow control ready* state (d1) is considered by the DCE as a local procedure error. The DCE will reset the virtual call or permanent virtual circuit (see 4.4.3). The DTE should follow the same procedure.

A number (modulo 8, or 128 when extended, or 32 768 when super extended), referred to as a packet receive sequence number P(R), conveys across the DTE/DCE interface information from the receiver for the transmission of *data* packets. When transmitted across the DTE/DCE interface, a P(R) becomes the lower window edge. In this way, additional *data* packets may be authorized by the receiver to cross the DTE/DCE interface.

The packet receive sequence number, P(R), is conveyed in *data*, *receive ready* (RR) and *receive not ready* (RNR) packets.

The value of a P(R) received by the DCE must be within the range from the last P(R) received by the DCE up to and including the packet send sequence number of the next *data* packet to be transmitted by the DCE. Otherwise, the DCE will consider the receipt of this P(R) as a procedure error and will reset the virtual call or permanent virtual circuit. The DTE should follow the same procedure.

The receive sequence number P(R) is less than or equal to the sequence number of the next expected *data* packet and implies that the DTE or DCE transmitting P(R) has accepted at least all *data* packets numbered up to and including P(R) – 1.

4.4.1.4 Delivery confirmation

The D-bit procedure is optional for the network to support. When not supported by a network or part of the international network crossed by the virtual call or permanent virtual circuit, the DTEs always set the D bit to 0. Otherwise, the call will be reset by the network (see Annex C).

When the D bit is set to 0 in a *data* packet having P(S) = p, the significance of the returned P(R) corresponding to that *data* packet [i.e. P(R) ≥ p + 1] is a local updating of the window across the packet level interface so that the achievable throughput is not constrained by the DTE to DTE round trip delay across the network(s).

When the D bit is set to 0 in a *data* packet, the returned P(R) corresponding to that *data* packet does not signify that a P(R) has been received from the remote DTE.

When the D bit is set to 1 in a *data* packet having P(S) = p, the significance of the returned P(R) corresponding to that *data* packet [i.e. P(R) ≥ p + 1] is an indication that a P(R) has been received from the remote DTE for all data bits in the *data* packet in which the D bit had originally been set to 1.

NOTES

1 A DTE, on receiving a *data* packet with the D bit set to 1, should transmit the corresponding P(R) as soon as possible in order to avoid the possibility of deadlocks (e.g. without waiting for further *data* packets). A *data*, *RR* or *RNR* packet may be used to convey the P(R) (see Note in 4.4.1.6). Likewise, the DCE is required to send P(R) to the DTE as soon as possible when the P(R) is received from the remote DTE. When the DTE is not currently operating the D-bit procedure, the receipt of a *data* packet with the D bit set to 1 may be treated by the DTE as an error condition.

2 If a P(R) for a *data* packet with the D bit set to 1 is outstanding, local updating of the window will be deferred for subsequent *data* packets with the D bit set to 0. Some networks may also defer updating the window for previous *data* packets (within the window) with the D bit set to 0 until the corresponding P(R) for the packet with the outstanding D bit set to 1 is transmitted to the DTE.

3 P(R) values corresponding to the data contained in *data* packets with the D bit set to 1 need not be the same at the DTE/DCE interfaces at each end of a virtual call or a permanent virtual circuit.

4 If the DTE has sent *data* packets with the D bit set to 0, the DTE does not have to wait for local updating of the window by the DCE before initiating a resetting or clearing procedure.

4.4.1.5 DTE and DCE receive ready (RR) packets

RR packets are used by the DTE or DCE to indicate that it is ready to receive the *W data* packets within the window starting with P(R), where P(R) is indicated in the *RR* packet.

4.4.1.6 DTE and DCE receive not ready (RNR) packets

RNR packets are used by the DTE or DCE to indicate a temporary inability to accept additional *data* packets for a given virtual call or permanent virtual circuit. A DTE or DCE receiving an *RNR* packet shall stop transmitting *data* packets on the indicated logical channel, but the window is updated by the P(R) value of the *RNR* packet. The receive not ready situation indicated by the transmission of an *RNR* packet is cleared by the transmission in the same direction of an *RR* packet or by the initiation of a reset procedure.

The transmission of an *RR* packet after an *RNR* packet at the packet layer is not to be taken as a demand for retransmission of packets which have already been transmitted.

NOTE – The *RNR* packet may be used to convey across the DTE/DCE interface the P(R) value corresponding to a *data* packet which had the D bit set to 1 in the case that additional *data* packets cannot be accepted.

4.4.2 Throughput characteristics and throughput classes

The definitions of throughput and steady state throughput are given in clause 4/X.135.

Since throughput includes only the user data bits and not the protocol overheads, the maximum achievable throughput is, at all times, less than the access line transmission rate.

A throughput class for one direction of transmission is an inherent characteristic of the virtual call or permanent virtual circuit related to the amount of resources available to this virtual call or permanent virtual circuit. It is a measure of the steady state throughput that can be provided under optimal conditions on a virtual call or permanent virtual circuit. However, due to the statistical sharing of transmission and switching resources, it is not guaranteed that the throughput class can be reached 100% of the time.

The relationship between throughput class and the throughput parameters, and objectives described in Recommendation X.135 requires further study. The complete definition of the optimal conditions to ensure a desired steady state throughput in relation to specific throughput class also requires further study. Pending the results of these further studies, it cannot be guaranteed or verified that a network supporting a given throughput class value (64 kbit/s for instance) offers better performance to its users than a network not supporting that throughput class. However, a network may offer a guarantee to its users on a contractual basis.

The optimal conditions to maximize the steady state throughput include the following:

- 1) the access line characteristics of the local and remote DTEs do not constrain the throughput class;

NOTE 1 – In particular, because of the overhead due to the frame and packet headers, when the throughput class corresponding to the user class of service of the DTE is applicable to a virtual call or permanent virtual circuit, a steady state throughput equal to that throughput class can never be reached.

- 2) the window sizes at the local and remote DTE/DCE interfaces do not constrain the throughput;

NOTE 2 – In particular, the extended packet sequence numbering (see 6.2), non-standard default packet sizes (see 6.9), non-standard default window sizes (see 6.10) or/and flow control parameter negotiation facilities (see 6.12) may be needed, depending on a number of factors (see guidance concerning layer 2 in Appendix V, from which similar guidance may be derived for layer 3).

- 3) the traffic characteristics of other logical channels at local and remote DTE/DCE interfaces do not constrain the throughput;
- 4) the receiving DTE is not flow controlling the DCE such that the throughput class is not attainable;
- 5) the transmitting DTE sends only *data* packets which have the maximum data field length;
- 6) the D bit is not set to 1.

The throughput class is expressed in bits per second. The maximum data field length is specified for a virtual call or permanent virtual circuit, and thus the throughput class can be interpreted by the DTE as the number of full *data* packets/second at the DTE/DCE interface.

In the absence of the *default throughput classes assignment* facility (see 6.11), the default throughput classes for both directions of transmission correspond to the user class of service of the DTE (see 7.3.2) but do not exceed the maximum throughput class supported by the network. Negotiation of throughput classes on a per call basis may be made with one of the *throughput class negotiation* facilities (see 6.13).

NOTE 3 – Because of the capability of the X.25 protocol to support multiple simultaneous virtual calls or permanent virtual circuits, the sum of the throughput classes of all virtual calls and permanent virtual circuits supported at a DTE/DCE interface may be greater than the data transmission rate of the access line.

4.4.3 Procedure for reset

The reset procedure is used to reinitialize the virtual call or permanent virtual circuit and in so doing removes in each direction all *data* and *interrupt* packets which may be in the network (see 4.5). When a virtual call or permanent virtual circuit at the DTE/DCE interface has just been reset, the window related to each direction of data transmission has a lower window edge equal to 0, and the numbering of subsequent *data* packets to cross the DTE/DCE interface for each direction of data transmission shall start from 0.

The reset procedure can only apply in the *data transfer* state (p4) of the DTE/DCE interface. In any other state of the DTE/DCE interface, the reset procedure is abandoned. For example, when a clearing or restarting procedure is initiated, *reset request* and *reset indication* packets can be left unconfirmed.

For flow control, there are three states d1, d2 and d3 within the *data transfer* state (p4). There are *flow control ready* (d1), *DTE reset request* (d2), and *DCE reset indication* (d3) as shown in the state diagram in Figure B.3. When entering state p4, the logical channel is placed in state d1. Table C.4 specifies actions taken by the DCE on the receipt of packets from the DTE.

4.4.3.1 Reset request packet

The DTE shall indicate a request for reset by transmitting a *reset request* packet specifying the logical channel to be reset. This places the logical channel in the *DTE reset request* state (d2).

4.4.3.2 Reset indication packet

The DCE will indicate a reset by transmitting to the DTE a *reset indication* packet specifying the logical channel being reset and the reason for the resetting. This places the logical channel in the *DCE reset indication* state (d3). In this state, the DCE will ignore *data*, *interrupt*, *RR* and *RNR* packets.

4.4.3.3 Reset collision

Reset collision occurs when a DTE and a DCE simultaneously transmit a *reset request* packet and a *reset indication* packet specifying the same logical channel. Under these circumstances the DCE will consider that the reset is completed. The DCE will not expect a *DTE reset confirmation* packet and will not transfer a *DCE reset confirmation* packet. This places the logical channel in the *flow control ready* state (d1).

4.4.3.4 Reset confirmation packets

When the logical channel is in the *DTE reset request* state (d2), the DCE will confirm reset by transmitting to the DTE a *DCE reset confirmation* packet. This places the logical channel in the *flow control ready* state (d1).

The *DCE reset confirmation* packet can only be interpreted universally as having local significance; however, within some Administrations' networks, *reset confirmation* may have end-to-end significance. In all cases the time spent in the *DTE reset request* state (d2) will not exceed time-limit T22 (see Annex D).

When the logical channel is in the *DCE reset indication* state (d3), the DTE will confirm reset by transmitting to the DCE a *DTE reset confirmation* packet. This places the logical channel in the *flow control ready* state (d1). The action taken by the DCE when the DTE does not confirm the reset within time-out T12 is given in Annex D.

4.5 Effects of clear, reset and restart procedures on the transfer of packets

All *data* and *interrupt* packets generated by a DTE (or the network) before initiation by the DTE or the DCE of a clear, reset or restart procedure at the local interface will either be delivered to the remote DTE before the DCE transmits the corresponding indication on the remote interface, or be discarded by the network.

No *data* or *interrupt* packets generated by a DTE (or the network) after the completion of a reset (or for permanent virtual circuits also a restart) procedure at the local interface will be delivered to the remote DTE before the completion of the corresponding reset procedure at the remote interface.

When a DTE initiates a clear, reset or restart procedure at its local interface, all *data* and *interrupt* packets which were generated by the remote DTE (or the network) before the corresponding indication is transmitted to the remote DTE will be either delivered to the initiating DTE before DCE confirmation of the initial clear, reset or restart request, or be discarded by the network.

NOTE – The maximum number of packets which may be discarded is a function of network end-to-end delay and throughput characteristics and, in general, has no relation to the local window size. For virtual calls and permanent virtual circuits on which all *data* packets are transferred with the D bit set to 1, the maximum number of packets which may be discarded in one direction of transmission is not larger than the window size of the direction of transmission.

4.6 Effects of the physical layer and the data link layer on the packet layer

4.6.1 General principles

In general, if a problem is detected in one layer (physical, data link or packet layer) and can be solved in this layer according to the DCE error recovery procedures provided in this Recommendation without loss or duplication of data, the adjacent layers are not involved in the error recovery.

If an error recovery by the DCE implies a possible loss or duplication of data, then the higher layer is informed.

The reinitialization of one layer by the DCE is only performed if a problem cannot be solved in this layer.

Changes of operational states of the physical layer and the data link layer of the DTE/DCE do not implicitly change the state of each logical channel at the packet layer. Such changes when they occur are explicitly indicated at the packet layer by the use of restart, clear or reset procedures as appropriate.

4.6.2 Definition of an out of order condition

In the case of a single link procedure, there is an out of order condition when:

- a failure on the physical and/or data link layer is detected: such a failure is defined as a condition in which the DCE cannot transmit or cannot receive any frame because of abnormal conditions caused by, for instance, a line default between DTE and DCE;

NOTE – Short physical layer outages (e.g. loss of carrier) are not considered as physical layer failures by the DCE and the data link layer and packet layer are not informed.
- the DCE has received or transmitted a DISC command.

There may be other out of order network-dependent conditions such as: reset of the data link layer, expiration of T3 timer (see 2.4.5.3), receipt or transmission of a DM response, etc.

In the case of the Multilink procedure, an out of order condition is considered as having occurred when it is present at the same time for every single link procedure of the DTE/DCE interface. There may be other out of order network-dependent conditions such as the performance by DTE or DCE of the multilink resetting procedure (see 2.5.4.2), loss of multilink frame(s) (see 2.5.4.4), etc.

4.6.3 Actions on the packet layer when an out of order condition is detected

When an out of order condition is detected, the DCE will transmit to the remote end:

- 1) a reset with the cause “Out of order” for each permanent virtual circuit; and
- 2) a clear with the cause “Out of order” for each existing virtual call.

4.6.4 Actions on the packet layer during an out of order condition

During an out of order condition:

- 1) the DCE will clear any incoming virtual call with the cause “Out of order”;
- 2) for any *data* or *interrupt* packet received from the remote DTE on a permanent virtual circuit, the DCE will reset the permanent virtual circuit with the cause “Out of order”;
- 3) a *reset* packet received from the remote DTE on a permanent virtual circuit will be confirmed to the remote DTE by either *reset confirmation* or *reset indication* packet.

4.6.5 Actions on the packet layer when the out of order condition is recovered

When the out of order condition is recovered:

- 1) the DCE will send a *restart indication* packet with the cause “Network operational” to the local DTE;
- 2) a reset with the cause “Remote DTE operational” will be transmitted to the remote end of each permanent virtual circuit.

5 Packet formats

5.1 General

Each packet type contains a header which may contain the following fields: a protocol identifier octet, a general format identifier, a logical channel group number, a logical channel number and a packet type identifier.

The possible extension of packet formats by the addition of new fields is for further study. Any such field:

- a) would only be provided as an addition following all previously defined fields, and not as an insertion between any of the previously defined fields;
- b) would be transmitted to a DTE only when either the DCE has been informed that the DTE is able to interpret this field and act upon it, or when the DTE can ignore the field without adversely affecting the operation of the DTE/DCE interface (including charging).

Bits of an octet are numbered 8 to 1 where bit 1 is the low order bit and is transmitted first. Octets of a packet are consecutively numbered starting from 1 and are transmitted in this order.

5.1.1 Protocol identifier octet

For modulo 8 and modulo 128 operation, the protocol identifier octet is not present in any packet type. For modulo 32 768 operation, the protocol identifier octet is contained in the first octet of each packet.

NOTE – ITU-T Rec. X.263 | ISO/IEC 9577 defines an Initial Protocol Identifier (IPI) which overlays the first octet of each X.25 packet. For modulo 8 and modulo 128, the IPI overlays the first octet of each packet in which bit positions 8, 7, 6 and 5 contain the general format identifier and bit positions 4, 3, 2 and 1 contain either the logical channel group if present, or zeros. For modulo 32 768, the IPI overlays the first octet of each packet, which is the protocol identifier octet.

5.1.2 General format identifier

The general format identifier field is a four bit binary coded field which is provided to indicate the general format of the rest of the header. For modulo 8 and modulo 128 operation, the general format identifier field is contained in the first octet of each packet. For modulo 32 768 operation, the general format identifier field is contained in the second octet of each packet. The general format identifier field is located in bit positions 8, 7, 6 and 5, and bit 5 is the low order bit (see Table 5-1).

Bit 8 of the general format identifier is used for the Qualifier bit in *data* packets, for the Address bit in call set-up and clearing packets, and is set to 0 in all other packets.

Bit 7 of the general format identifier is used for the delivery confirmation procedure in *data* and *call set-up* packets and is set to 0 in all other packets.

Bits 6 and 5 are encoded for four possible indications. Three of the codes are used to distinguish packets using modulo 8 sequence numbering from packets using modulo 128 sequence numbering and from packets using modulo 32 768 sequence numbering. The fourth code is used in conjunction with the protocol identifier octet to indicate an extension to an extended family of general format identifier codes and extended formats which are a subject for further study.

NOTES

1 The DTE must encode the GFI to be consistent with whether or not it has subscribed to the *extended packet sequence numbering* facility or *super extended sequence numbering* facility (see 6.2).

2 It is envisaged that the reserved general format identifier code could be used to identify alternative packet formats, provided that the protocol identifier octet is the first octet of any such alternate packet format.

5.1.3 Logical channel group number

The logical channel group number appears in every packet except *restart* and *diagnostic* packets. For modulo 8 and modulo 128 operation, the logical channel group number is contained in the first octet of each packet. For modulo 32 768 operation, the logical channel group number is contained in the second octet of each packet. The logical channel group number is located in bit position 4, 3, 2 and 1. For each logical channel, this number has local significance at the DTE/DCE interface.

This field is binary coded and bit 1 is the low order bit of the logical channel group number. In *restart* and *diagnostic* packets, this field is coded all zeros.

5.1.4 Logical channel number

The logical channel number appears in every packet except *restart* and *diagnostic* packets. For modulo 8 and modulo 128 operation, the logical channel number is contained in the second octet of each packet. For modulo 32 768 operation, the logical channel number is contained in the third octet of each packet. The logical channel group number is located in all bit positions of the octet. For each logical channel, this number has local significance at the DTE/DCE interface.

This field is binary coded and bit 1 is the low order bit of the logical channel number. In *restart* and *diagnostic* packets, this field is coded all zeros.

5.1.5 Packet type identifier

Each packet shall be identified according to Table 5-2. For modulo 8 and modulo 128 operation, the packet type identifier is contained in the third octet of each packet. For modulo 32 768 operation, the packet type identifier is contained in the fourth octet of each packet.

TABLE 5-1/X.25

General format identifier

General format identifier		Bit position			
		8	7	6	5
<i>Call set-up</i> packets (Note 1)	Sequence numbering scheme modulo 8	X	X	0	1
	Sequence numbering scheme modulo 128	X	X	1	0
	Sequence numbering scheme modulo 32 768	X	X	1	1
<i>Clearing</i> packets (Note 1)	Sequence numbering scheme modulo 8	X	0	0	1
	Sequence numbering scheme modulo 128	X	0	1	0
	Sequence numbering scheme modulo 32 768	X	0	1	1
<i>Flow control, interrupt, reset, restart and diagnostic</i> packets	Sequence numbering scheme modulo 8	0	0	0	1
	Sequence numbering scheme modulo 128	0	0	1	0
	Sequence numbering scheme modulo 32 768	0	0	1	1
<i>Data</i> packets (Note 1)	Sequence numbering scheme modulo 8	X	X	0	1
	Sequence numbering scheme modulo 128	X	X	1	0
	Sequence numbering scheme modulo 32 768	X	X	1	1
Reserved format (Note 2)		a)	a)	0	0
a) Undefined. NOTES 1 A bit which is indicated as "X" may be set to either 0 or 1, as indicated in the text. 2 When the general format identifier field is contained in the first octet of a packet, this value is reserved for other applications. When the first octet of a packet is the Protocol Identifier Octet, then this value is reserved for general format identifier extension					

5.2 Call set-up and clearing packets

The format of the *call request/incoming* call packet, *call accepted/call connected* packet, *clear request/clear indication* packet and the *clear confirmation* packet are shown in Figures 5-4, 5-5, 5-6 and 5-7, respectively.

The maximum length of a call set-up/clearing packet is 259 octets (260 if the *super extended packet sequence numbering* facility is subscribed to). Except when a maximum is given in the following sections for a specified field, each field may vary in size up to a value so as to make the packet 259 octets in length (260 if the *super extended packet sequence numbering* facility is subscribed to).

If any of the field specific maximum is exceeded or if the maximum packet length is exceeded, the call is cleared as specified in Table C.3.

NOTE – Although a call set-up/clearing packet does not exceed 259 octets (260 if the *super extended packet sequence numbering* facility is subscribed to) when transmitted across the local DTE/DCE interface, it still may not be compatible in size with all interfaces en route to the remote DTE. This is especially true if, for example, facilities are added to the packet or the remote DTE's N1 (see 2.4.9.5) is set for universal operation (see Appendix II). In such cases, the call is cleared.

5.2.1 Address block format

The call set-up and clearing packets contain an address block. This address block has two possible formats. The first format, known as the non-TOA/NPI address format, can accommodate addresses conforming to the formats described in Recommendations X.121 and X.301 whose length (including possible prefixes and/or escape codes) is not greater than 15 digits. The second format, known as the TOA/NPI address format, can be used by networks and DTEs to accommodate addresses conforming to the formats described in Recommendations X.121 and X.301 whose length is greater than 15 digits and can also be used to carry an alternative address in the called DTE address field of the *call request* and *clear request* packet (see 6.1 for use of the NPI/TOA address format in conjunction with the *NPI/TOA address subscription* facility and 6.28 for more details on alternative addressing). The address block of the TOA/NPI format contains (in addition to the address itself) fields to specify the Type of Address (TOA) and the Numbering Plan Identification (NPI).

The non-TOA/NPI address format and the TOA/NPI address format are distinguished by bit 8 (A bit) of the general format identifier. When the A bit is set to 0, the non-TOA/NPI address format is used. When the A bit is set to 1, the TOA/NPI address format is used.

The non-TOA/NPI address format is supported by all networks. The TOA/NPI address format may be supported by some networks and by some DTEs.

NOTE 1 – An alternative address is one that does not conform to the formats specified in Recommendations X.121 and X.301. Such an alternative address can be used to identify the called DTE in the *call request* packet. The use of alternative addresses in other packet types is for further study.

NOTE 2 – Prior to 1997, packet-mode DTEs operating according to case B of Recommendation X.31 (ISDN virtual circuit bearer service) will be addressed by a maximum 12 digit address from the E.164 numbering plan. After 1996, such a packet-mode DTE may have 15 digit E.164 address. TOA/NPI address procedures will be required to address these DTEs. Recommendations E.165 and E.166 provide further guidance.

If the DTE has subscribed to the *TOA/NPI address subscription* facility (see 6.1), the DTE and DCE shall only use the TOA/NPI address format when transmitting call set-up or clearing packets across the DTE/DCE interface.

If the DTE has not subscribed to the *TOA/NPI address subscription* facility, the DTE and DCE shall only use the non-TOA/NPI address format when transmitting call set-up or clearing packets across the DTE/DCE interface. If the DTE has not subscribed to the *TOA/NPI address subscription* facility and the calling DTE address is too long for a non-TOA/NPI call set-up or clearing packet, the DCE will include no calling DTE address.

NOTE 3 – Some Administrations may provide an additional subscription-time facility allowing the DTE to indicate that the DCE shall clear the call with cause “incompatible destination” in the case described in the paragraph above, rather than include no calling DTE address (see Annex C).

The use of the TOA/NPI address format is only possible if the TOA/NPI address format is supported by the network. When the address format used by one DTE in a call set-up or call clearing packet is not the same as the address format used by the remote DTE, the network (if it supports the TOA/NPI address format) converts from one address format to the other (see 6.1).

TABLE 5-2/X.25

Packet type identifier

Packet type		Bit position							
		8	7	6	5	4	3	2	1
From DCE to DTE	From DTE to DCE								
<i>Call set-up and clearing</i>									
Incoming call	Call request	0	0	0	0	1	0	1	1
Call connected	Call accepted	0	0	0	0	1	1	1	1
Clear indication	Clear request	0	0	0	1	0	0	1	1
DCE clear confirmation	DTE clear confirmation	0	0	0	1	0	1	1	1
<i>Data and interrupt</i>									
DCE data	DTE data	X	X	X	X	X	X	X	0
DCE interrupt	DTE interrupt	0	0	1	0	0	0	1	1
DCE interrupt confirmation	DTE interrupt confirmation	0	0	1	0	0	1	1	1
<i>Flow control and reset</i>									
DCE RR (modulo 8)	DTE RR (modulo 8)	X	X	X	0	0	0	0	1
DCE RR (modulo 128) ^{a)}	DTE RR (modulo 128) ^{a)}	0	0	0	0	0	0	0	1
DCE RR (modulo 32 768) ^{a)}	DTE RR (modulo 32 768) ^{a)}	0	0	0	0	0	0	0	1
DCE RNR (modulo 8)	DTE RNR (modulo 8)	X	X	X	0	0	1	0	1
DCE RNR (modulo 128) ^{a)}	DTE RNR (modulo 128) ^{a)}	0	0	0	0	0	1	0	1
DCE RNR (modulo 32 768) ^{a)}	DTE RNR (modulo 32 768) ^{a)}	0	0	0	0	0	1	0	1
	DTE REJ (modulo 8) ^{a)}	X	X	X	0	1	0	0	1
	DTE REJ (modulo 128) ^{a)}	0	0	0	0	1	0	0	1
DCE REJ (modulo 32 768) ^{a)}	DTE REJ (modulo 32 768) ^{a)}	0	0	0	0	1	0	0	1
Reset indication	Reset request	0	0	0	1	1	0	1	1
DCE reset confirmation	DTE reset confirmation	0	0	0	1	1	1	1	1
<i>Restart</i>									
Restart indication	Restart request	1	1	1	1	1	0	1	1
DCE restart confirmation	DTE restart confirmation	1	1	1	1	1	1	1	1
<i>Diagnostic</i>									
Diagnostic ^{a)}		1	1	1	1	0	0	0	1

^{a)} Not necessarily available on every network.
NOTE – A bit which is indicated as “X” may be set to either 0 or 1 as indicated in the text.

5.2.1.1 Format of the address block when the A bit is set to 0 (non-TOA/NPI address)

Figure 5-1 illustrates the format of the address block when the A bit is set to 0.

5.2.1.1.1 Calling and called DTE address length fields

These fields are each four bits long and consist of field length indicators for the called and calling DTE addresses. Bits 4, 3, 2 and 1 indicate the length of the called DTE address in semi-octets. Bits 8, 7, 6 and 5 indicate the length of the calling DTE address in semi-octets. Each DTE address length indicator is binary coded and bit 1 or 5 is the low order bit of the indicator.

When the called DTE address length field of the *call request* packet is set to zero, and the *alternative address usage subscription* facility is subscribed to (see 6.28.2), the called DTE must be identified by an alternative address carried in the *called address extension* facility (see 6.28.3 and Annex G). In this case, it is still valid to carry a calling DTE address in the *call request* packet. The length of the calling DTE address is indicated in the calling DTE address length field as specified above.

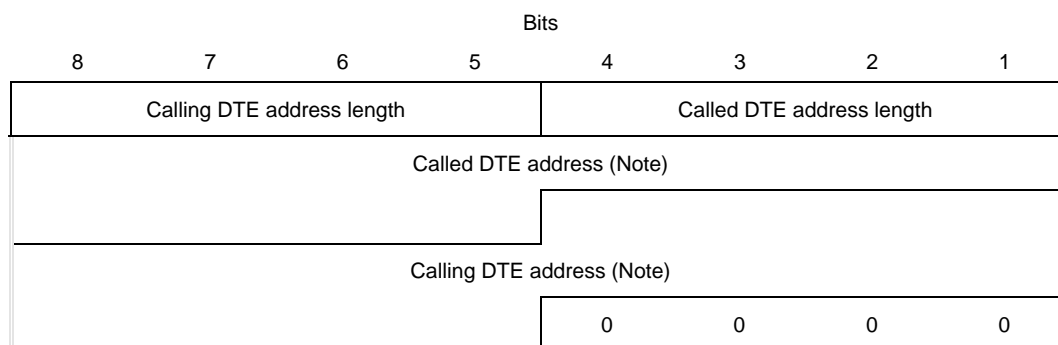

NOTE – The figure is drawn assuming the number of address digits present in the called DTE address field is odd and the number of address digits present in the calling DTE address field is even.

FIGURE 5-1/X.25

Format of the address block when the A bit is set to 0

5.2.1.1.2 Called and calling DTE address fields

Each digit of an address is coded in a semi-octet in binary coded decimal with bit 5 or 1 being the low order bit of the digit.

Starting from the high order digit, a DTE address is coded in consecutive octets with two digits per octet. In each octet, the higher order digit is coded in bits 8, 7, 6 and 5.

When present, the calling DTE address field starts on the first semi-octet following the end of the called DTE address field. Consequently, when the number of digits of the called DTE address field is odd, the beginning of the calling DTE address field, when present, is not octet aligned.

When the total number of digits in the called and calling DTE address fields is odd, a semi-octet with zeros in bits 4, 3, 2 and 1 will be inserted after the calling DTE address field in order to maintain octet alignment.

Further information on the coding of called and calling DTE address fields is given in Appendix IV.

NOTE – These fields may be used for optional addressing facilities such as abbreviated addressing. The optional addressing facilities employed, as well as the coding of those facilities are for further study.

5.2.1.2 Format of the address block when the A bit is set to 1 (TOA/NPI address)

Figure 5-2 illustrates the format of the address block when the A bit is set to 1.

5.2.1.2.1 Called and calling DTE address length fields

These fields are each one octet long and consist of field length indicators for the called and calling DTE addresses. They indicate the length of the called DTE address and the calling DTE address, respectively, in semi-octets. Each DTE address length indicator is binary coded and bit 1 is the low order bit of the indicator.

There is no actual maximum value for a DTE address length indicator. However, the maximum length of 259 octets (260 if the *super extended packet sequence numbering* facility is subscribed to) for the call set-up or clearing packet must not be exceeded (see 5.2).

When the called DTE address length field of the *call request* packet is set to zero, and the *alternative address usage subscription* facility is subscribed to (see 6.28.2), the called DTE must be identified by an alternative address carried in the *called address extension* facility (see 6.28.3 and Annex G). In this case, it is still valid to carry a calling DTE address in the *call request* packet. The length of the calling DTE address is indicated in the calling DTE address length field as specified above.

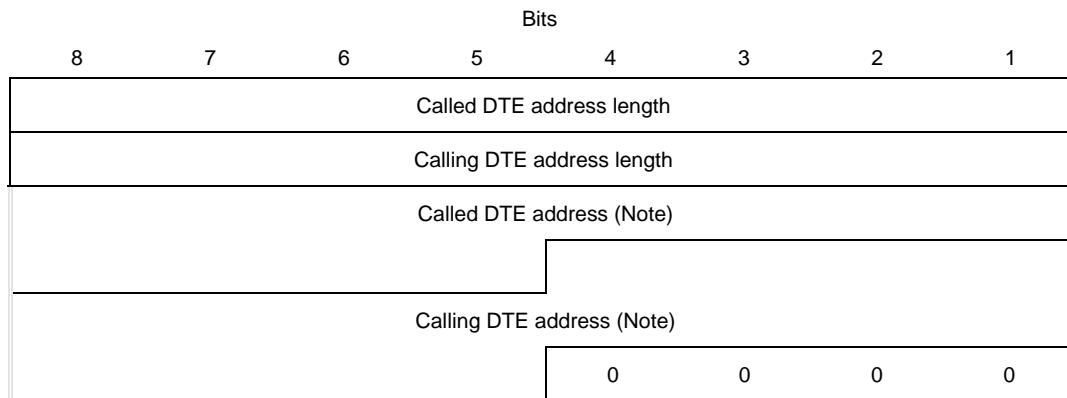

NOTE – The figure is drawn assuming the number of semi-octets present in the called DTE address field is odd and the number of semi-octets present in the calling DTE address field is even.

FIGURE 5-2/X.25

Format of the address block when the A bit is set to 1

5.2.1.2.2 Called and calling DTE address fields

These fields respectively consist of the called DTE address when present, and the calling DTE address when present.

Each DTE address field, when present, has three subfields: type of address subfield (TOA), numbering plan identification subfield (NPI) and the address digits subfield (see also Figure 5-3). The first two subfields are at the beginning of the address and are binary coded with the values indicated in Tables 5-3, 5-4 and 5-6. The allowed combinations of TOA and NPI subfields are given in Table 5-5.

NOTE – A DTE address containing type of address and numbering plan identification subfields but no address digits subfield is invalid.

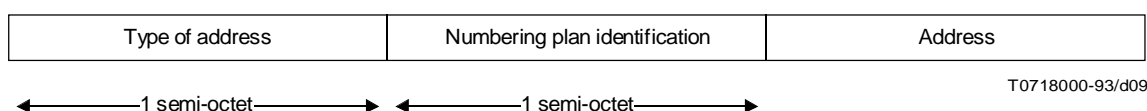

T0718000-93/d09

FIGURE 5-3/X.25

Format of the main address when the A bit is set to 1

When the type of address subfield indicates an address other than an alternative address, the other semi-octets of a DTE address are digits, coded in binary coded decimal with bit 5 or 1 being the low order bit of the digit. Starting from the high order digit, the address digits are coded in consecutive semi-octets. In each octet, the higher order digit is coded in bits 8, 7, 6 and 5.

When present, the calling DTE address field starts on the first semi-octet following the end of the called DTE address field. Consequently, when the number of semi-octets of the called DTE address field is odd, the beginning of the calling DTE address field, when present, is not octet aligned.

When the total number of semi-octets in the called and calling DTE address fields is odd, a semi-octet with zeros in bits 4, 3, 2 and 1 will be inserted after the calling DTE address field in order to maintain octet alignment.

TABLE 5-3/X.25

Coding of the type of address subfield

Bits: or Bits: (Note 1)	8	7	6	5	Type of address
	4	3	2	1	
	0	0	0	0	Network-dependent number or unknown
	0	0	0	1	International number
	0	0	1	0	National number
	0	0	1	1	Network specific number (for use in private networks)
	0	1	0	0	Complementary address without main address (Note 2)
	0	1	0	1	Alternative address
	1	1	1	1	Reserved for extension
Other values					Reserved

NOTES

1 The type of address subfield of the called DTE address field uses bits 8, 7, 6 and 5. The type of address subfield of the calling DTE address field uses bits 4, 3, 2 and 1 if the called DTE address field does *not* end on an octet boundary; otherwise, it uses bits 8, 7, 6 and 5.

2 See Appendix IV for the definition of a complementary address.

TABLE 5-4/X.25

Coding of the numbering plan identification subfield

Bits: or Bits: (Note 1)	8	7	6	5	Numbering plan
	4	3	2	1	
	0	0	0	0	Network-dependent number or unknown
	0	0	0	1	Rec. E.164 (digital) (Note 2)
	0	0	1	0	Rec. E.164 (analog) (Note 2)
	0	0	1	1	Rec. X.121
	0	1	0	0	Rec. F.69 (telex numbering plan)
	0	1	0	1	Private numbering plan (for private use only)
	1	1	1	1	Reserved for extension
Other values					Reserved

NOTES

1 The numbering plan identification subfield of the called DTE address field uses bits 4, 3, 2 and 1. The numbering plan identification subfield of the calling DTE address field uses bits 8, 7, 6 and 5 if the called DTE address does *not* end on an octet boundary; otherwise, it uses bits 4, 3, 2 and 1.

2 Recommendation E.164 (digital) is used when a digital interface on the destination network (ISDN or integrated ISDN/PSTN) is requested and as a default when it is not required to differentiate the service type or when the service type is unknown. Recommendation E.164 (analog) is used when an analog interface on the destination network (ISDN or integrated ISDN/PSTN) is requested.

TABLE 5-5/X.25

Allowed combinations of TOA and NPI subfields

Type of address	Numbering plan identification	Format of the address (Note)
Network-dependent number or unknown	Network-dependent number or unknown	Network-dependent
International number	Rec. E.164 (digital)	CC + NSN
	Rec. E.164 (analog)	CC + NSN
	Rec. X.121	DNIC + NTN or DCC + NN
	Rec. F.69	TDC + National Telex Number
National number	Rec. E.164 (digital)	NSN
	Rec. E.164 (analog)	NSN
	Rec. X.121	NTN or NN
	Rec. F.69	National Telex Number
Network specific number (for use in private networks)	Private numbering plan (for private use only)	Private network dependent
Complementary address without main address	Network-dependent number or unknown	Format non-defined
Alternative address	See Table 5-6	According to the alternative address coding authority
NOTE – The definition of the acronyms used in this column are given in the corresponding Recommendations listed in the previous column.		

When the type of address subfield indicates an alternative address, the coding of the address is in accordance with the coding authority specified in Table 5-6.

TABLE 5-6/X.25

Coding of the numbering plan identification subfield when interpreted as the alternative address coding

Bits: (Note)	4	3	2	1	Alternative address coding authority
	0	0	0	0	Character string coded in accordance with CCITT Rec. T.50 ISO/IEC 646
	0	0	0	1	OSI NSAP address coded in accordance with CCITT Rec. X.213 ISO/IEC 8348
	0	0	1	0	Media Access Control (MAC) address coded in accordance with ISO/IEC 10039
	0	0	1	1	Internet address coded in accordance with RFC 1166
	Other values				Reserved
NOTE – The numbering plan identification subfield (when interpreted as the alternative address coding of the called DTE address field) uses bits 4, 3, 2 and 1.					

Further information on the coding of called and calling DTE address fields is given in Appendix IV.

5.2.2 Call request and incoming call packets

Figure 5-4 illustrates the format of *call request* and *incoming call* packets.

5.2.2.1 General format identifier

Bit 8 of the general format identifier (A bit) should be set as described in 5.2.1.

Bit 7 of the general format identifier should be set to 0 unless the mechanism defined in 4.3.3 is used.

5.2.2.2 Address block

The address block is described in 5.2.1. The called DTE address (carried in the address block) of the *call request* packet will either conform to the format specified in Recommendations X.121 and X.301 or may be an alternative address coded as per the authority specified in Table 5-6. The called DTE address of the *incoming call* packet will conform only to the format specified in Recommendations X.121 and X.301.

5.2.2.3 Facility length field

The octet following the address block indicates the length of the facility field, in octets. The facility length indicator is binary coded and bit 1 is the low order bit of the indicator.

5.2.2.4 Facility field

The facility field is present only when the DTE is using an optional user facility requiring some indication in the *call request* and *incoming call* packets.

The coding of the facility field is defined in clauses 6 and 7.

The facility field contains an integral number of octets. The actual maximum length of this field is 255 octets; however, it is also limited by the global maximum length of the packet (see 5.2).

5.2.2.5 Call user data field

Following the facility field, the call user data field may be present and has a maximum length of 128 octets when used in conjunction with the *fast select* facility described in 6.16, 16 octets in the other case.

NOTE – Some networks require the call user data field to contain an integral number of octets (see the Note in clause 3).

When the virtual call is being established between two packet-mode DTEs, the network does not act on any part of the call user data field. In other circumstances, see Recommendation X.263.

5.2.3 Call accepted and call connected packets

Figure 5-5 illustrates the format of the *call accepted* and *call connected* packets in the basic or extended format.

5.2.3.1 Basic format

5.2.3.1.1 General format identifier

Bit 8 of the general format identifier (A bit) should be set as described in 5.2.1.

Bit 7 of the general format identifier should be set to 0 unless the mechanism defined in 4.3.3 is used.

5.2.3.1.2 Address block

The address block is described in 5.2.1.

The use of the called and calling DTE address length fields in *call accepted* packets is only mandatory when the called DTE address field, the calling DTE address field or the facility length field is present.

When present, the called and calling DTE addresses of the *call accepted* packet will conform to the format specified in Recommendations X.121 and X.301. The format of called and calling DTE addresses of the *call connected* packet will conform to the format specified in Recommendations X.121 and X.301. When an alternative address was used in the *call request* packet to establish the call, or in the *clear request* packet to deflect the call, it is a network option that no called address will be present in the *call connected* packet.

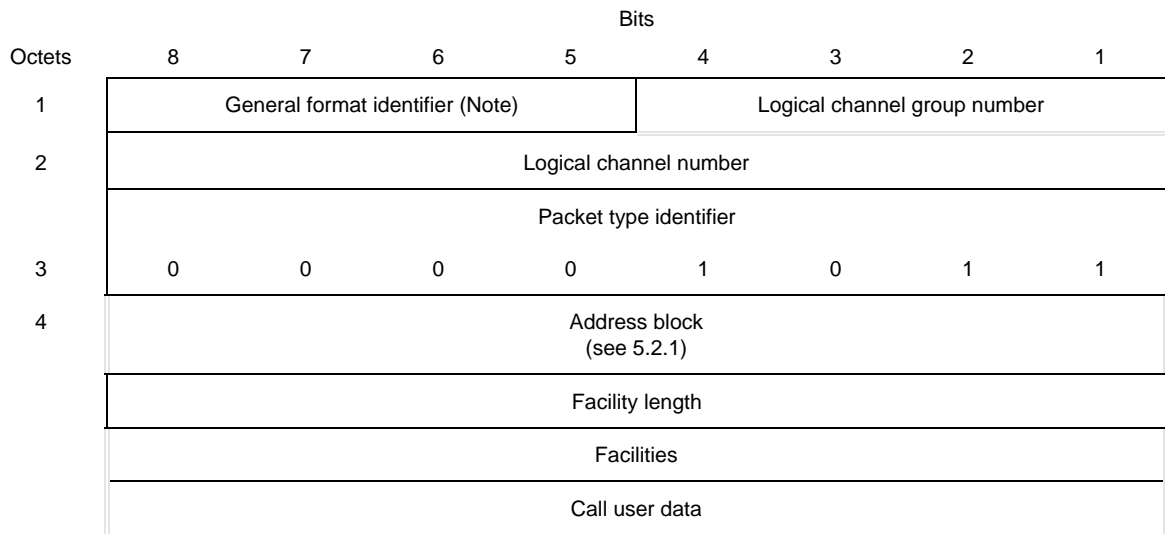

(Modulo 8 and modulo 128)

NOTE – Coded XX01 (modulo 8) or XX10 (modulo 128).

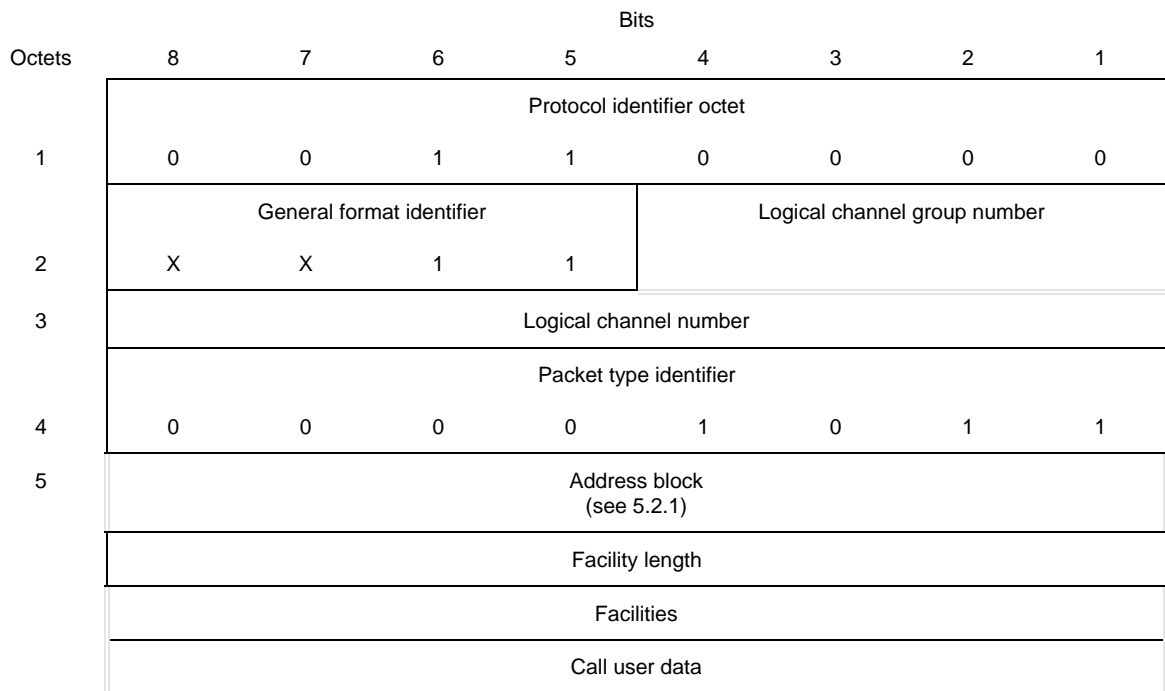

(Modulo 32 768)

FIGURE 5-4/X.25

Call request and incoming call packet format

Octets	Bits							
	8	7	6	5	4	3	2	1
1	General format identifier (Note)				Logical channel group number			
2	Logical channel number							
3	Packet type identifier							
4	0	0	0	0	1	1	1	1
4	Address block ^{a)} (see 5.2.1)							
	Facility length ^{a)}							
	Facilities ^{a)}							
	Call user data ^{b)}							

(Modulo 8 and modulo 128)

^{a)} These fields are not mandatory in the basic format of *call accepted* packets (see 5.2.3.1).

^{b)} This field may be present only in the extended format (see 5.2.3.2).

NOTE – Coded XX01 (modulo 8) or XX10 (modulo 128).

Octets	Bits							
	8	7	6	5	4	3	2	1
1	Protocol identifier octet							
	0	0	1	1	0	0	0	0
2	General format identifier				Logical channel group number			
3	X	X	1	1				
3	Logical channel number							
4	Packet type identifier							
4	0	0	0	0	1	1	1	1
5	Address block (see 5.2.1)							
	Facility length ^{a)}							
	Facilities ^{a)}							
	Call user data ^{b)}							

(Modulo 32 768)

^{a)} These fields are not mandatory in the basic format of *call accepted* packets (see 5.2.3.1).

^{b)} This field may be present only in the extended format (see 5.2.3.2).

FIGURE 5-5/X.25

Call accepted and call connected packet format

5.2.3.1.3 Facility length field

The octet following the address block indicates the length of the facility field, in octets. The facility length indicator is binary coded and bit 1 is the low order bit of the indicator.

The use of the facility length field in *call accepted* packets is only mandatory when the facility field is present.

5.2.3.1.4 Facility field

The facility field is present only when the DTE is using an optional user facility requiring some indication in the *call accepted* and *call connected* packets.

The coding of the facility field is defined in clauses 6 and 7.

The facility field contains an integral number of octets. The actual maximum length of this field is 255 octets; however, it is also limited by the global maximum length of the packet (see 5.2).

5.2.3.2 Extended format

The extended format may be used only in conjunction with the *fast select* facility described in 6.16. In this case, the called user data field may be present and has a maximum length of 128 octets.

The calling and called DTE address length fields and the facility length field must be present when the called user data field is present.

NOTE – Some networks require the called user data field to contain an integral number of octets (see the Note in clause 3).

When the virtual call is being established between two packet-mode DTEs, the network does not act on any part of the called user data field. See Recommendation X.263.

5.2.4 Clear request and clear indication packets

Figure 5-6 illustrates the format of *clear request* and *clear indication* packets, in basic and extended formats.

5.2.4.1 Basic format

5.2.4.1.1 Clearing cause field

The octet following the packet type identifier is the clearing cause field and contains the reason for the clearing of the call.

In the *clear request* packets, the clearing cause field should be set by the DTE to one of the following values:

bits:	8	7	6	5	4	3	2	1
value:	0	0	0	0	0	0	0	0
or:	1	X	X	X	X	X	X	X

where each X may be independently set to 0 or 1 by the DTE.

The DCE will prevent values of the clearing cause field other than those shown above from reaching the other end of the call by either accepting the *clear request* packet and forcing the clearing cause field to all zeros in the corresponding *clear indication* packet, or considering the *clear request* as an error and following the procedure described in Annex C.

The coding of the clearing cause field in *clear indication* packets is given in Table 5-7.

Octets	Bits							
	8	7	6	5	4	3	2	1
1	General format identifier (Note)				Logical channel group number			
2	Logical channel number							
3	Packet type identifier							
	0	0	0	1	0	0	1	1
4	Clearing cause							
5	Diagnostic code ^{a)}							
	Address block ^{b)} (see 5.2.1)							
	Facility length ^{b)}							
	Facilities ^{b)}							
	Call user data ^{b)}							

(Modulo 8 and modulo 128)

a) This field is not mandatory in the basic format of *clear request* packets (see 5.2.4.1).

b) Used only in the extended format (see 5.2.4.2).

NOTE – Coded X001 (modulo 8) or X010 (modulo 128).

Octets	Bits							
	8	7	6	5	4	3	2	1
1	Protocol identifier octet							
	0	0	1	1	0	0	0	0
2	General format identifier				Logical channel group number			
	X	X	1	1				
3	Logical channel number							
4	Packet type identifier							
	0	0	0	1	0	0	1	1
5	Clearing cause							
6	Diagnostic code ^{a)}							
	Address block (see 5.2.1)							
	Facility length ^{b)}							
	Facilities ^{b)}							
	Clear user data ^{b)}							

(Modulo 32 768)

a) This field is not mandatory in the basic format of *clear request* packets (see 5.2.4.1).

b) Used only in the extended format (see 5.2.4.2).

FIGURE 5-6/X.25

Clear request and clear indication packet format

TABLE 5-7/X.25

Coding of clearing cause field in clear indication packet

	Bits							
	8	7	6	5	4	3	2	1
DTE originated	0	0	0	0	0	0	0	0
DTE originated ^{a)}	1	X	X	X	X	X	X	X
Number busy	0	0	0	0	0	0	0	1
Out of order	0	0	0	0	1	0	0	1
Remote procedure error	0	0	0	1	0	0	0	1
Reverse charging acceptance not subscribed ^{b)}	0	0	0	1	1	0	0	1
Incompatible destination	0	0	1	0	0	0	0	1
Fast select acceptance not subscribed ^{b)}	0	0	1	0	1	0	0	1
Ship absent ^{c)}	0	0	1	1	1	0	0	1
Invalid facility request	0	0	0	0	0	0	1	1
Access barred	0	0	0	0	1	0	1	1
Local procedure error	0	0	0	1	0	0	1	1
Network congestion	0	0	0	0	0	1	0	1
Not obtainable	0	0	0	0	1	1	0	1
ROA out of order ^{b)}	0	0	0	1	0	1	0	1
^{a)} When bit 8 is set to 1, the bits represented by Xs are those included by the remote DTE in the clearing or restarting cause field of the <i>clear</i> or <i>restart request</i> packet respectively. ^{b)} May be received only if the corresponding optional user facility is used. ^{c)} Used in the conjunction with mobile maritime service.								

5.2.4.1.2 Diagnostic code

The octet following the clearing cause field is the diagnostic code and contains additional information on the reason for the clearing of the call.

In a *clear request* packet, the diagnostic code is not mandatory.

In a *clear indication* packet, if the clearing cause field indicates “DTE originated”, the diagnostic code is passed unchanged from the clearing DTE. If the clearing DTE has not provided a diagnostic code in its *clear request* packet, then the bits of the diagnostic code in the resulting *clear indication* packet will all be zero.

When a *clear indication* packet results from a *restart request* packet, the value of the diagnostic code will be that specified in the *restart request* packet, or all zeros in the case where no diagnostic code has been specified in the *restart request* packet.

When the clearing cause field does not indicate “DTE originated”, the diagnostic code in a *clear indication* packet is network generated. Annex E lists the codings for network generated diagnostics. The bits of the diagnostic code are all set to 0 when no specific additional information for the clearing is supplied.

NOTE – The contents of the diagnostic code field do not alter the meaning of the cause field. A DTE is not required to undertake any action on the contents of the diagnostic code field. Unspecified code combinations in the diagnostic code field shall not cause the DTE to refuse the cause field.

5.2.4.2 Extended format

The extended format is used for *clear request* and *clear indication* packets only when the DTE or the DCE needs to use the called and/or calling DTE address fields, the facility field and/or the clear user data field in conjunction with one or several optional user facilities described in clauses 6 and 7. The called DTE address field is used only when the *called line address modified notification* facility is used in clearing, in response to an *incoming call* or *call request* packet.

When the extended format is used, the diagnostic code field, the DTE address length fields and the facility length field must be present. Optionally, the clear user data field may also be present.

5.2.4.2.1 Address block

The address block is described in 5.2.1.

5.2.4.2.2 Facility length field

The octet following the address block indicates the length of the facility field, in octets. The facility length indicator is binary coded and bit 1 is the low order bit of the indicator.

5.2.4.2.3 Facility field

The facility field is present in the *clear request* or the *clear indication* packet only in conjunction with one or several optional user facilities requiring some indication in this packet.

The coding of the facility field is defined in clauses 6 and 7.

The facility field contains an integral number of octets. The actual maximum length of this field is 255 octets; however, it is also limited by the global maximum length of the packet (see 5.2).

5.2.4.2.4 Clear user data field

This field may be present only in conjunction with the *fast select* facility (see 6.16) or the *call deflection selection* facility (see 6.25.2.2). It has a maximum length of 128 octets in the first case, of 16 or 128 octets in the second case: whether the maximum length is 16 or 128 octets when using the *call deflection selection* facility is specified in 6.25.2.2.

NOTES

- 1 Some networks require the clear user data field to contain an integral number of octets (see the Note in clause 3).
- 2 The network does not act on any part of the clear user data field. See Recommendation X.263.

5.2.5 DTE and DCE clear confirmation packets

Figure 5-7 illustrates the format of the *DTE* and *DCE clear confirmation* packets, in the basic or extended format.

The extended format may be used for *DCE clear confirmation* packets only in conjunction with the *charging information* facility described in 6.22. It is not used for *DTE clear confirmation* packet.

5.2.5.1 Address block

The address block is described in 5.2.1.

The calling and called DTE address length fields are coded with all zeros and the called and calling DTE address fields are not present.

5.2.5.2 Facility length field

The octet following the address block indicates the length of the facility field, in octets. The facility length indicator is binary coded and bit 1 is the low order bit of the indicator.

Octets	Bits							
	8	7	6	5	4	3	2	1
1	General format identifier (Note)				Logical channel group number			
2	Logical channel number							
3	Packet type identifier							
	0	0	0	1	0	1	1	1
4	Address block ^{a)} (see 5.2.1)							
	Facility length ^{a)}							
	Facilities ^{a)}							

(Modulo 8 and modulo 128)

^{a)} Used only in the extended format of *DCE clear confirmation* packets.

NOTE – Coded X001 (modulo 8) or X010 (modulo 128).

Octets	Bits							
	8	7	6	5	4	3	2	1
1	Protocol identifier octet							
	0	0	1	1	0	0	0	0
2	General format identifier				Logical channel group number			
	X	0	1	1				
3	Logical channel number							
4	Packet type identifier							
	0	0	0	1	0	1	1	1
5	Address block ^{a)} (see 5.2.1)							
	Facility length ^{a)}							
	Facilities ^{a)}							

(Modulo 32 768)

^{a)} Used only in the extended format of *DCE clear confirmation* packets.

FIGURE 5-7/X.25

DTE and DCE clear confirmation packet format

5.2.5.3 Facility field

The coding of the facility field is defined in clauses 6 and 7.

The facility field contains an integral number of octets. The actual maximum length of this field is 255 octets; however, it is also limited by the global maximum length of the packet (see 5.2).

5.3 Data and interrupt packets

5.3.1 DTE and DCE data packets

Figure 5-8 illustrates the format of the *DTE* and *DCE data* packets.

5.3.1.1 Qualifier (Q) bit

Bit 8 of the general format identifier is the qualifier (Q) bit.

5.3.1.2 Delivery confirmation (D) bit

Bit 7 of the general format identifier is the delivery confirmation (D) bit.

5.3.1.3 Packet receive sequence number

Bits 8, 7 and 6 of octet 3, or bits 8 through 2 of octet 4 when extended, or bits 8 through 2 of octet 6 and bits 8 through 1 of octet 7 when super extended, are used for indicating the packet receive sequence number P(R). P(R) is binary coded and bit 6, or bit 2 when extended, is the low order bit. When super extended, bit 2 of octet 6 is the low order bit and bit 8 of octet 7 is the high order bit.

5.3.1.4 More data bit

Bit 5 in octet 3, or bit 1 in octet 4 when extended, or bit 1 in octet 6 when super extended, is used for the more data mark (M bit): 0 for no more data and 1 for more data.

5.3.1.5 Packet send sequence number

Bits 4, 3 and 2 of octet 3, or bits 8 through 2 of octet 3 when extended, or bits 8 through 2 of octet 4 and bits 8 through 1 of octet 5 when super extended, are used for indicating the packet send sequence number P(S). P(S) is binary coded and bit 2 is the low order bit. When super extended, bit 2 of octet 4 is the low order bit and bit 8 of octet 5 is the high order bit.

5.3.1.6 User data field

Bits following octet 3, or octet 4 when extended, or octet 7 when super extended, contain user data.

NOTE – Some networks require the user data field to contain an integral number of octets (see the Note in clause 3).

5.3.2 DTE and DCE interrupt packets

Figure 5-9 illustrates the format of the *DTE* and *DCE interrupt* packets.

5.3.2.1 Interrupt user data field

The octets following the packet type identifier contain the interrupt user data. This field may contain from 1 to 32 octets.

NOTE – Some networks require the interrupt user data field to contain an integral number of octets (see the Note in clause 3).

5.3.3 DTE and DCE interrupt confirmation packets

Figure 5-10 illustrates the format of the *DTE* and *DCE interrupt confirmation* packets.

5.4 Flow control and reset packets

5.4.1 DTE and DCE receive ready (RR) packets

Figure 5-11 illustrates the format of the *DTE* and *DCE RR* packets.

5.4.1.1 Packet receive sequence number

Bits 8, 7 and 6 of octet 3, or bits 8 through 2 of octet 4 when extended, or bits 8 through 2 of octet 5 and bits 8 through 1 of octet 6 when super extended, are used for indicating the packet receive sequence number P(R). P(R) is binary coded and bit 6, or bit 2 when extended, is the low order bit. When super extended, bit 2 of octet 5 is the low order bit and bit 8 of octet 6 is the high order bit.

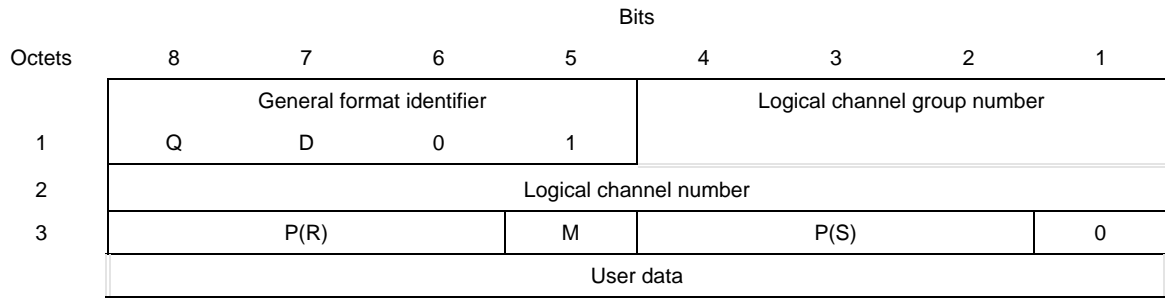

(Modulo 8)

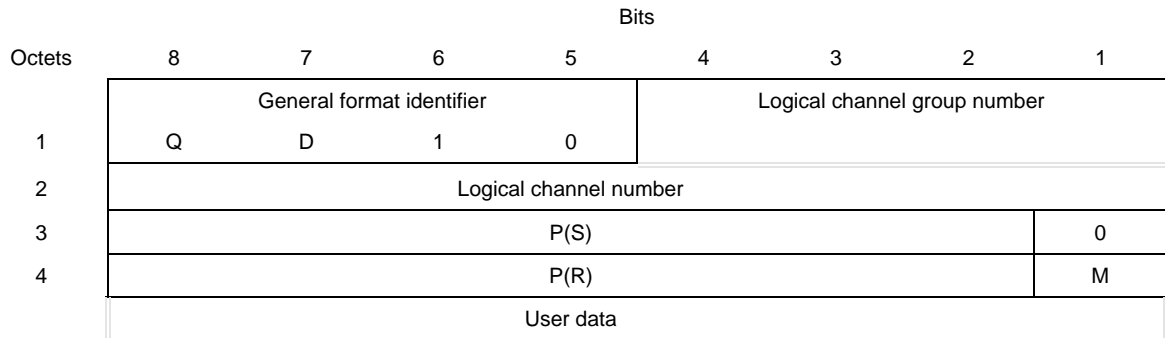

(Modulo 128)

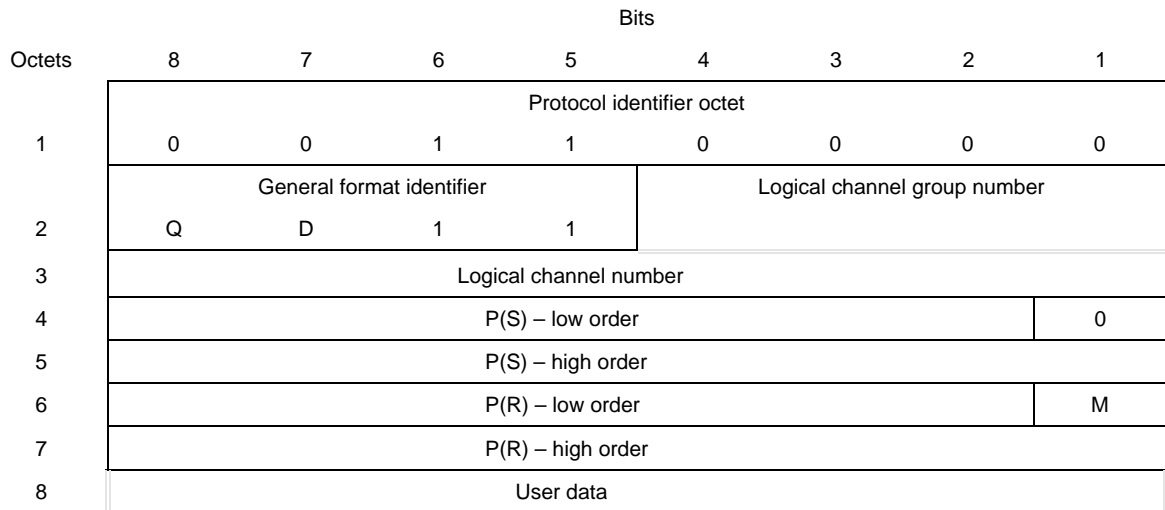

(Modulo 32 768)

D Delivery confirmation bit
M More data bit
Q Qualifier bit

FIGURE 5-8/X.25
DTE and DCE data packet format

Octets	Bits							
	8	7	6	5	4	3	2	1
1	General format identifier (Note)				Logical channel group number			
2	Logical channel number							
3	Packet type identifier							
	0	0	1	0	0	0	1	1
4	Interrupt user data							

(Modulo 8 or modulo 128)

NOTE – Coded 0001 (modulo 8) or 0010 (modulo 128).

Octets	Bits							
	8	7	6	5	4	3	2	1
1	Protocol identifier octet							
	0	0	1	1	0	0	0	0
2	General format identifier				Logical channel group number			
	0	0	1	1				
3	Logical channel number							
4	Packet type identifier							
	0	0	1	0	0	0	1	1
5	Interrupt user data							

(Modulo 32 768)

FIGURE 5-9/X.25

DTE and DCE interrupt packet format

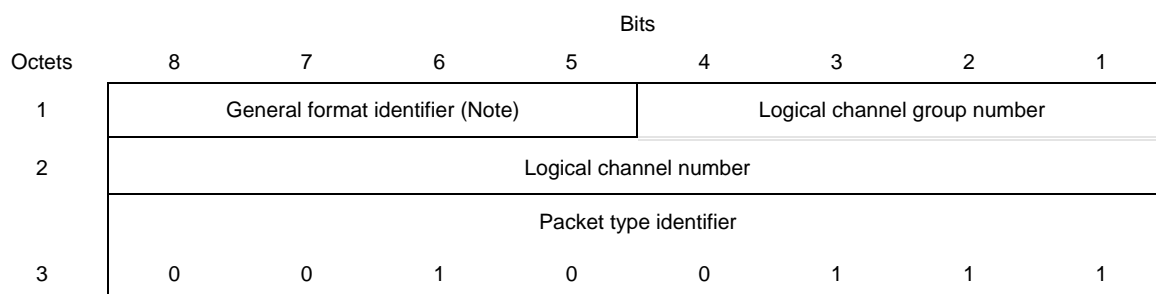

(Modulo 8 and modulo 128)

NOTE – Coded 0001 (modulo 8) or 0010 (modulo 128).

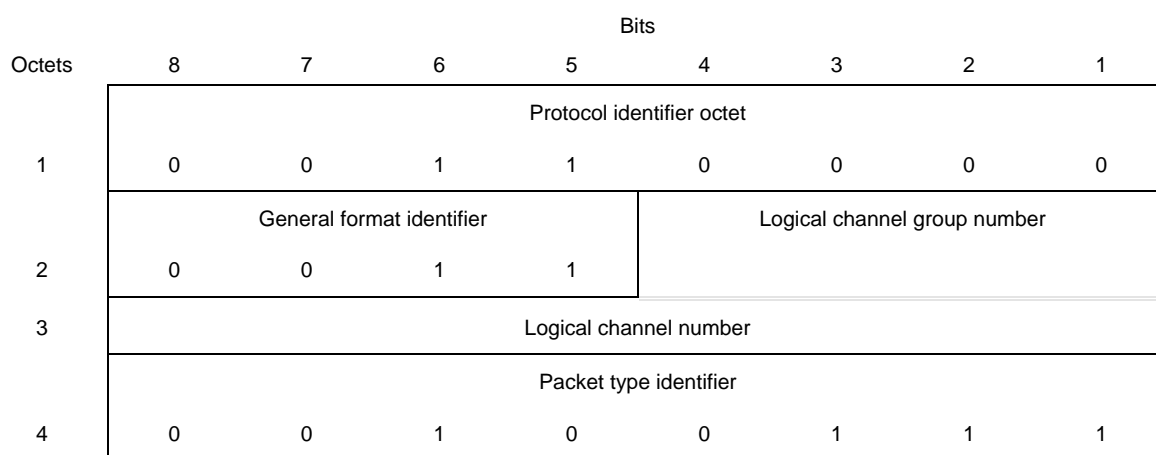

(Modulo 32 768)

FIGURE 5-10/X.25

DTE and DCE interrupt confirmation packet format

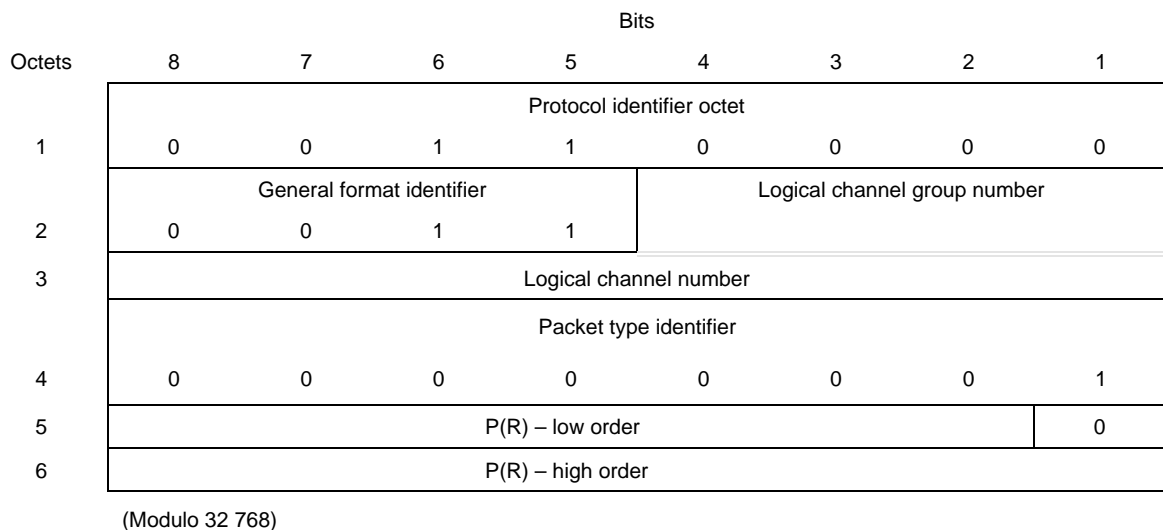
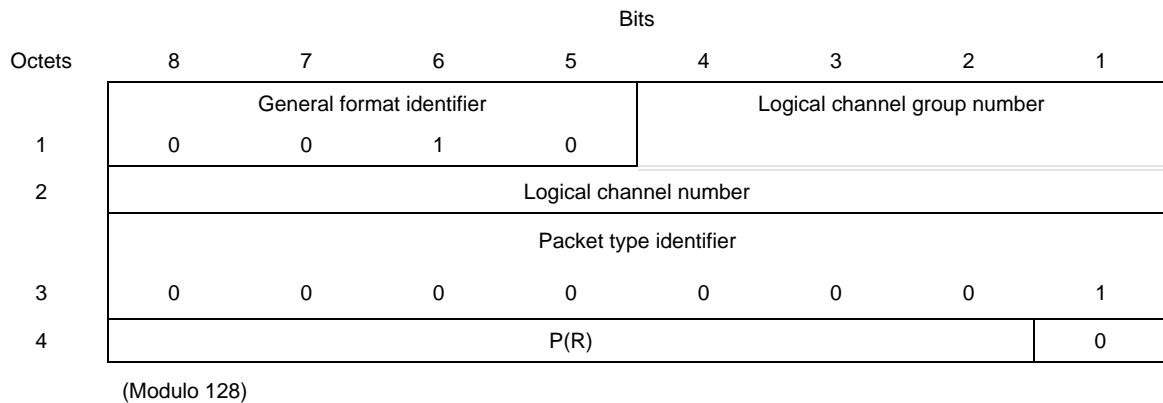
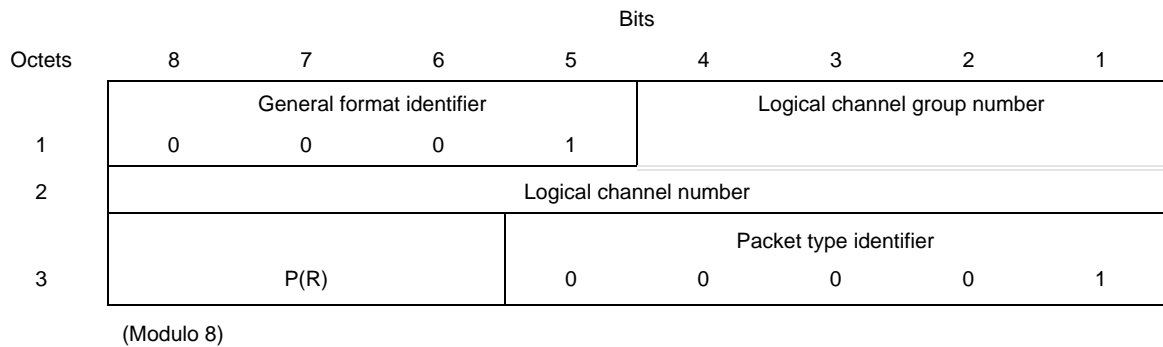

FIGURE 5-11/X.25
DTE and DCE RR packet format

5.4.2 DTE and DCE receive not ready (RNR) packets

Figure 5-12 illustrates the format of the *DTE* and *DCE RNR* packets.

5.4.2.1 Packet receive sequence number

Bits 8, 7 and 6 of octet 3, or bits 8 through 2 of octet 4 when extended, or bits 8 through 2 of octet 5 and bits 8 through 1 of octet 6 when super extended, are used for indicating the packet receive sequence number P(R). P(R) is binary coded and bit 6, or bit 2 when extended, is the low order bit. When super extended, bit 2 of octet 5 is the low order bit and bit 8 of octet 6 is the high order bit.

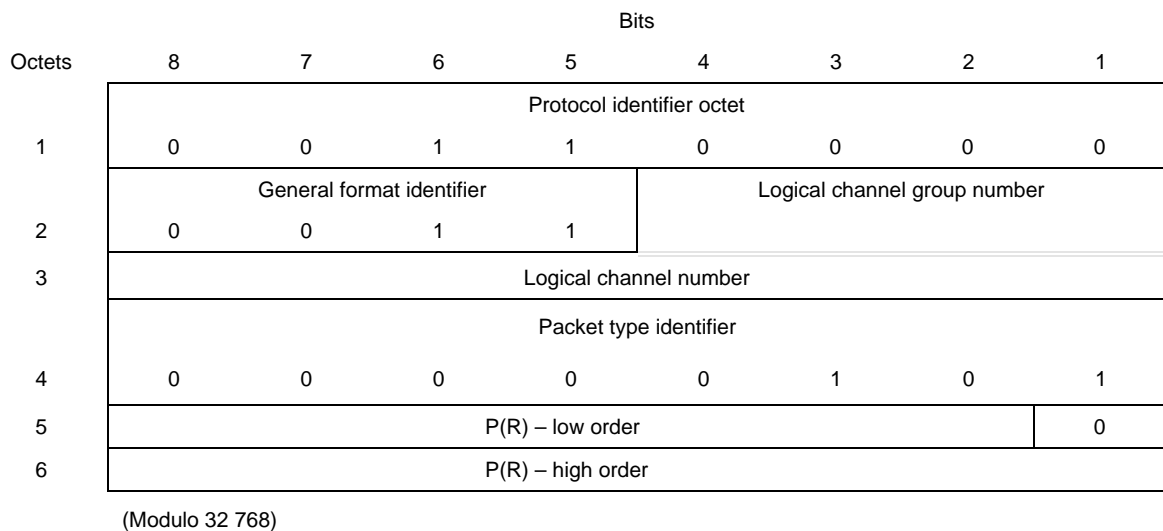
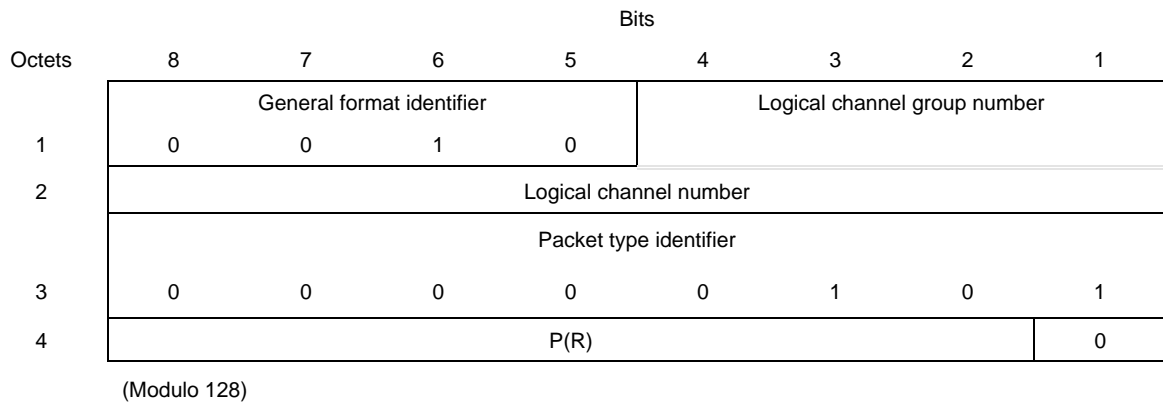
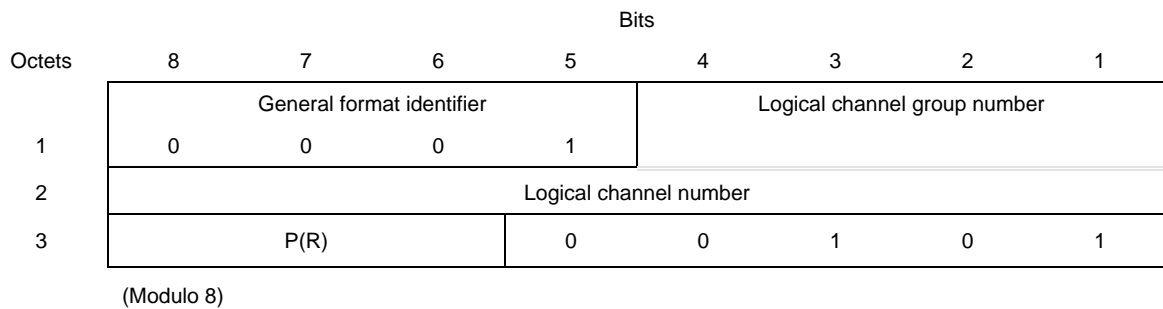

FIGURE 5-12/X.25

DTE and DCE RNR packet format

5.4.3 Reset request and reset indication packets

Figure 5-13 illustrates the format of the *reset request* and *reset indication* packets.

5.4.3.1 Resetting cause field

The octet following the packet type identifier is the resetting cause field and contains the reason for the reset.

Octets	Bits							
	8	7	6	5	4	3	2	1
1	General format identifier (Note)				Logical channel group number			
2	Logical channel number							
3	Packet type identifier							
3	0	0	0	1	1	0	1	1
4	Resetting cause							
5	Diagnostic code ^{a)}							

(Modulo 8 and modulo 128)

^{a)} This field is not mandatory in *reset request* packets.

NOTE – Coded 0001 (modulo 8) or 0010 (modulo 128).

Octets	Bits							
	8	7	6	5	4	3	2	1
1	Protocol identifier octet							
1	0	0	1	1	0	0	0	0
2	General format identifier				Logical channel group number			
2	0	0	1	1				
3	Logical channel number							
4	Packet type identifier							
4	0	0	0	1	1	0	1	1
5	Resetting cause							
6	Diagnostic code ^{a)}							

(Modulo 32 768)

^{a)} This field is not mandatory in *reset request* packets.

FIGURE 5-13/X.25

Reset request and reset indication packet format

In *reset request* packets, the resetting cause field should be set by the DTE to one of the following values:

bits:	8	7	6	5	4	3	2	1
value:	0	0	0	0	0	0	0	0
or:	1	X	X	X	X	X	X	X

where each X may be independently set to 0 or 1 by the DTE.

The DCE will prevent values of the resetting cause field, other than those shown above, from reaching the other end of the virtual call or permanent virtual circuit by either accepting the *reset request* packet and forcing the resetting cause field to all zeros in the corresponding *reset indication* packet, or considering the reset request as an error and following the procedure described in Annex C.

The coding of the resetting cause field in a *reset indication* packet is given in Table 5-8.

TABLE 5-8/X.25

Coding of resetting cause field in reset indication packet

	Bits							
	8	7	6	5	4	3	2	1
DTE originated	0	0	0	0	0	0	0	0
DTE originated ^{a)}	1	X	X	X	X	X	X	X
Out of order ^{b)}	0	0	0	0	0	0	0	1
Remote procedure error	0	0	0	0	0	0	1	1
Local procedure error	0	0	0	0	0	1	0	1
Network congestion	0	0	0	0	0	1	1	1
Remote DTE operational ^{b)}	0	0	0	0	1	0	0	1
Network operational ^{b)}	0	0	0	0	1	1	1	1
Incompatible destination	0	0	0	1	0	0	0	1
Network out of order ^{b)}	0	0	0	1	1	1	0	1
^{a)} When bit 8 is set to 1, the bits represented by Xs are those indicated by the remote DTE in the resetting cause field (virtual calls and permanent virtual circuits) or the restarting cause field (permanent virtual circuits only) of the <i>reset</i> or <i>restart request</i> packet, respectively. ^{b)} Applicable to permanent virtual circuits only.								

5.4.3.2 Diagnostic code

The octet following the resetting cause field is the diagnostic code and contains additional information on the reason for the reset.

In a *reset request* packet the diagnostic code is not mandatory.

In a *reset indication* packet, if the resetting cause field indicates “DTE originated”, the diagnostic code has been passed unchanged from the resetting DTE. If the DTE requesting a reset has not provided a diagnostic code in its *reset request* packet, then the bits of the diagnostic code in the resulting *reset indication* packet will all be zeros.

When a *reset indication* packet results from a *restart request* packet, the value of the diagnostic code will be that specified in the *restart request* packet, or all zeros in the case where no diagnostic code has been specified in the *restart request* packet.

When the resetting cause field does not indicate “DTE originated”, the diagnostic code in a *reset indication* packet is network generated. Annex E lists the codings for network generated diagnostics. The bits of the diagnostic code are all set to 0 when no specific additional information for the reset is supplied.

NOTE – The contents of the diagnostic code field do not alter the meaning of the cause field. A DTE is not required to undertake any action on the contents of the diagnostic code field. Unspecified code combinations in the diagnostic code field shall not cause the DTE to not accept the cause field.

5.4.4 DTE and DCE reset confirmation packets

Figure 5-14 illustrates the format of the *DTE* and *DCE reset confirmation* packets.

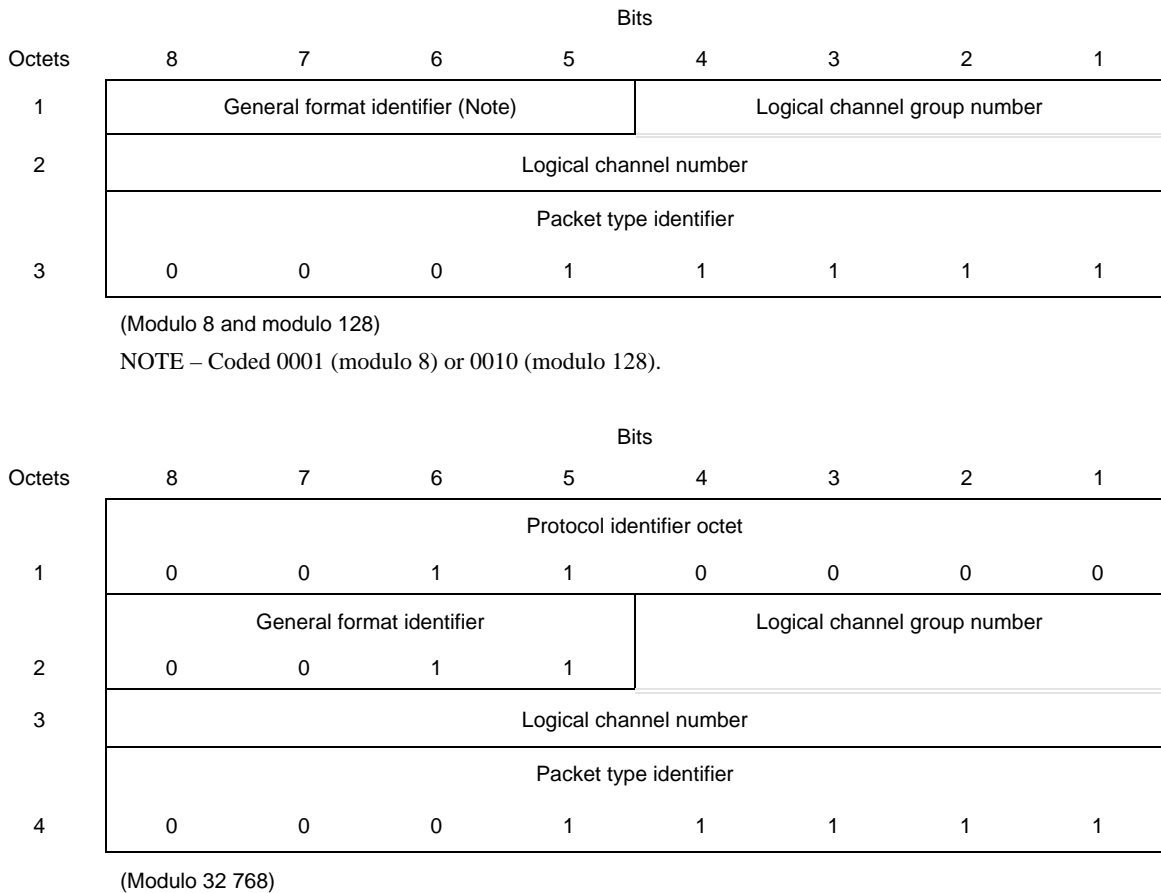

FIGURE 5-14/X.25

DTE and DCE reset confirmation packet format

5.5 Restart packets

5.5.1 Restart request and restart indication packets

Figure 5-15 illustrates the format of the *restart request* and *restart indication* packets.

5.5.1.1 Restarting cause field

The octet following the packet type identifier is the restarting cause field and contains the reason for the restart.

In *restart request* packets, the restarting cause field should be set by the DTE to one of the following values:

bits:	8	7	6	5	4	3	2	1
value:	0	0	0	0	0	0	0	0
or:	1	X	X	X	X	X	X	X

where each X may be independently set to 0 or 1 by the DTE.

Octets	Bits							
	8	7	6	5	4	3	2	1
1	General format identifier (Note)				0	0	0	0
2	0	0	0	0	0	0	0	0
Packet type identifier								
3	1	1	1	1	1	0	1	1
4	Restarting cause							
5	Diagnostic code ^{a)}							

(Modulo 8 and modulo 128)

a) This field is not mandatory in *restart request* packets.

NOTE – Coded 0001 (modulo 8) or 0010 (modulo 128).

Octets	Bits							
	8	7	6	5	4	3	2	1
Protocol identifier octet								
1	0	0	1	1	0	0	0	0
General format identifier				Logical channel group number				
2	0	0	1	1	0	0	0	0
3	0	0	0	0	0	0	0	0
Packet type identifier								
4	1	1	1	1	1	0	1	1
5	Restarting cause							
6	Diagnostic code ^{a)}							

(Modulo 32 768)

a) This field is not mandatory in *restart request* packets.

FIGURE 5-15/X.25

Restart request and restart indication packet format

The DCE will prevent values of the restarting cause field, other than those shown above, from reaching the other end of the virtual calls and/or permanent virtual circuits by either accepting the *restart request* packet and forcing the clearing or resetting cause field to all zeros in the corresponding *clear* and/or *reset indication* packets, or considering the restart request as an error and following the procedure described in Annex C.

The coding of the restarting cause field in the *restart indication* packets is given in Table 5-9.

TABLE 5-9/X.25

Coding of restarting cause field in restart indication packet

	Bits							
	8	7	6	5	4	3	2	1
Local procedure error	0	0	0	0	0	0	0	1
Network congestion	0	0	0	0	0	0	1	1
Network operational	0	0	0	0	0	1	1	1

5.5.1.2 Diagnostic code

The octet following the restarting cause field is the diagnostic code and contains additional information on the reason for the restart.

In a *restart request* packet, the diagnostic code is not mandatory. The diagnostic code, if specified, is passed to the corresponding DTEs as the diagnostic code of a *reset indication* packet for permanent virtual circuits or a *clear indication* packet for virtual calls.

The coding of the diagnostic code field in a *restart indication* packet is given in Annex E. The bits of the diagnostic code are all set to zero when no specific additional information for the restart is supplied.

NOTE – The contents of the diagnostic code field do not alter the meaning of the cause field. A DTE is not required to undertake any action on the contents of the diagnostic code field. Unspecified code combinations in the diagnostic code field shall not cause the DTE to not accept the cause field.

5.5.2 DTE and DCE restart confirmation packets

Figure 5-16 illustrates the format of the *DTE* and *DCE restart confirmation* packets.

Octets	Bits							
	8	7	6	5	4	3	2	1
1	General format identifier (Note)				0	0	0	0
2	0	0	0	0	0	0	0	0
Packet type identifier								
3	1	1	1	1	1	1	1	1

(Modulo 8 and modulo 128)

NOTE – Coded 0001 (modulo 8) or 0010 (modulo 128).

Octets	Bits							
	8	7	6	5	4	3	2	1
Protocol identifier octet								
1	0	0	1	1	0	0	0	0
General format identifier								
2	0	0	1	1	0	0	0	0
3	0	0	0	0	0	0	0	0
Packet type identifier								
4	1	1	1	1	1	1	1	1

(Modulo 32 768)

FIGURE 5-16/X.25

DTE and DCE restart confirmation packet format

5.6 Diagnostic packet

Figure 5-17 illustrates the format of the *diagnostic* packet.

Octets	Bits							
	8	7	6	5	4	3	2	1
1	General format identifier (Note 1)				0	0	0	0
2	0	0	0	0	0	0	0	0
3	Packet type identifier							
	1	1	1	1	0	0	0	1
4	Diagnostic code							
5	Diagnostic explanation (Note 2)							

(Modulo 8 and modulo 128)

NOTES

- 1 Coded 0001 (modulo 8) or 0010 (modulo 128).
- 2 The figure is drawn assuming the diagnostic explanation field is an integral number of octets in length.

Octets	Bits							
	8	7	6	5	4	3	2	1
1	Protocol identifier octet							
	0	0	1	1	0	0	0	0
2	General format identifier				0	0	0	0
	0	0	1	1	0	0	0	0
3	0	0	0	0	0	0	0	0
4	Packet type identifier							
	1	1	1	1	0	0	0	1
5	Diagnostic code							
6	Diagnostic explanation (Note)							

(Modulo 32 768)

NOTE – The figure is drawn assuming the diagnostic explanation field is an integral number of octets in length.

FIGURE 5-17/X.25

Diagnostic packet format

5.6.1 Diagnostic code field

The octet following the packet type identifier is the diagnostic code and contains information on the error condition which resulted in the transmission of the *diagnostic* packet. The coding of the diagnostic code field is given in Annex E.

5.6.2 Diagnostic explanation field

When the *diagnostic* packet is issued as a result of the reception of an erroneous packet from the DTE (see Tables C.1 and C.2), this field contains the first three octets of header information from the erroneous DTE packet. If the packet contains less than 3 octets, this field contains whatever bits were received.

When the *diagnostic* packet is issued as a result of a DCE time-out (see Table D.1), the diagnostic explanation field contains 2 octets coded as follows:

- bits 8, 7, 6 and 5 of the first octet contain the general format identifier for the interface;
- bits 4 to 1 of the first octet and bits 8 to 1 of the second octet are all 0 for expiration of time-out T10 and give the number of the logical channel on which the time-out occurred for expiration of time-out T12 or T13.

5.7 Packets required for optional user facilities

5.7.1 DTE reject (REJ) packet for the packet retransmission facility

Figure 5-18 illustrates the format of the *DTE REJ* packet, used in conjunction with the *packet retransmission* facility described in 6.4.

5.7.1.1 Packet receive sequence number

Bits 8, 7 and 6 of octet 3, or bits 8 through 2 of octet 4 when extended, or bits 8 through 2 of octet 5 and bits 8 through 1 of octet 6 when super extended, are used for indicating the packet receive sequence number P(R). P(R) is binary coded and bit 6, or bit 2 when extended, is the low order bit. When super extended, bit 2 of octet 5 is the low order bit and bit 8 of octet 6 is the high order bit.

6 Procedures for optional user facilities (packet layer)

6.1 TOA/NPI address subscription

TOA/NPI address subscription is an optional user facility agreed for a period of time for virtual calls.

When this facility is subscribed to, the DCE and DTE shall transmit call set-up and clearing packets only using the TOA/NPI address format. In this case, addresses in facilities (see 6.25) are also only in TOA/NPI format.

6.2 Extended and super extended packet sequence numbering facilities

Extended packet sequence numbering is an optional user facility agreed for a period of time. It is common to all logical channels at the DTE/DCE interface. This user facility, if subscribed to, provides sequence numbering of packets performed modulo 128.

Super extended packet sequence numbering is an optional user facility agreed for a period of time. It is common to all logical channels at the DTE/DCE interface. This user facility, if subscribed to, provides sequence numbering of packets performed modulo 32 768.

If neither extended nor the super extended sequence numbering is agreed, the sequence numbering of packets is performed modulo 8.

NOTE – In addition, some networks may permit the DTE to choose to use modulo 32 768 or modulo 128 or modulo 8 on a per-virtual call or logical channel basis. In this case, the use of either modulo 8 or modulo 128 or modulo 32 768 is permitted at the same DTE/DCE interface, with dynamic selection by the calling DTE. The same modulo applies to both directions of transmission. The means for the network to select the modulo in the *incoming call* packet for a given call, is beyond the scope of this Recommendation.

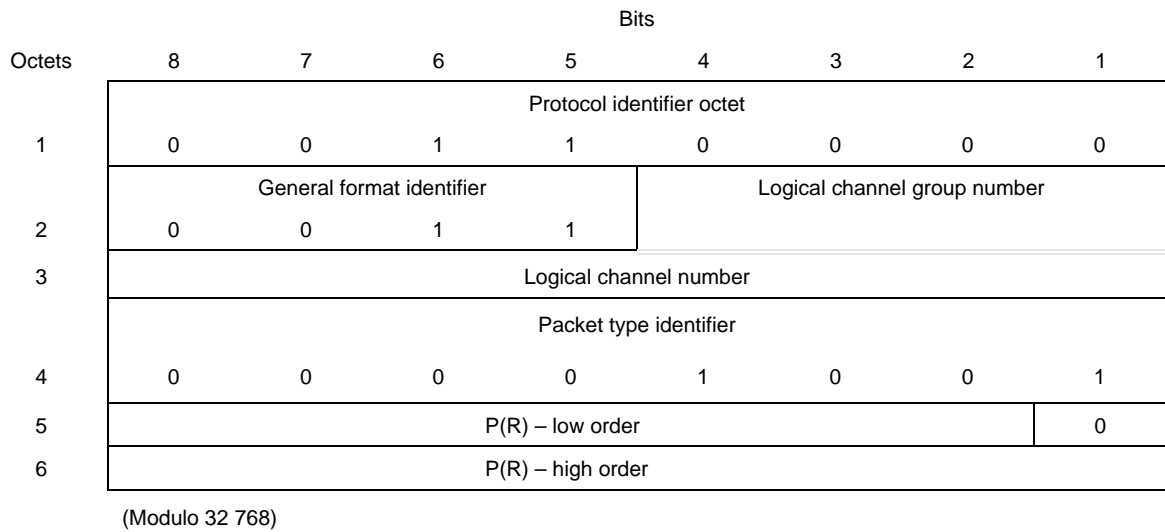
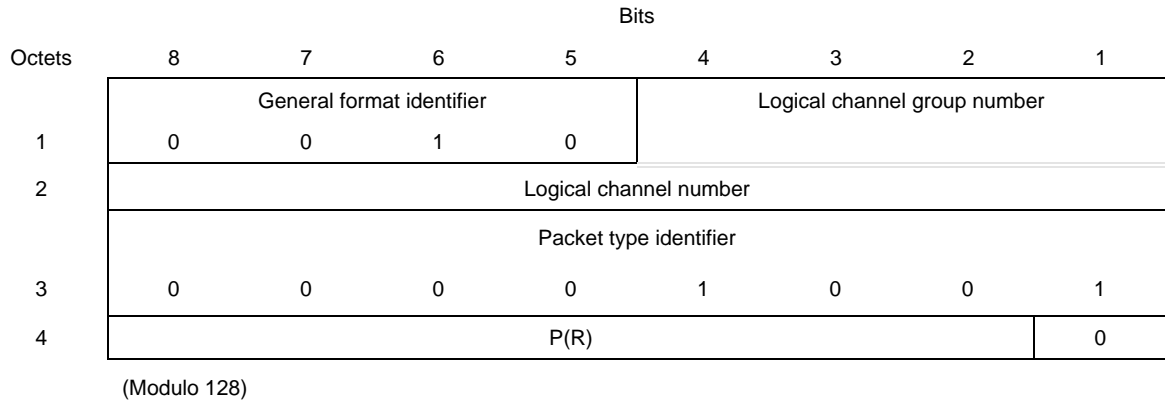
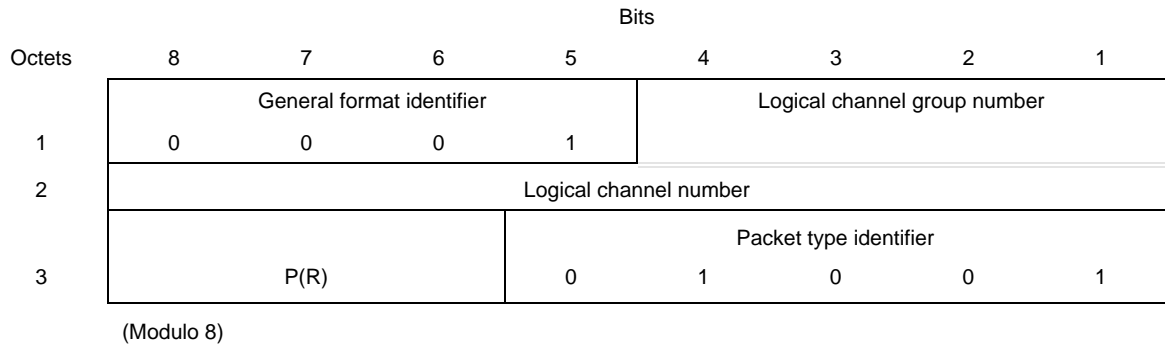

FIGURE 5-18/X.25

DTE REJ packet format

6.3 D-bit modification

D-bit modification is an optional user facility agreed for a period of time. This facility applies to all virtual calls and permanent virtual circuits at the DTE/DCE interface. This facility is only intended for use by those DTEs implemented prior to the introduction of the D-bit procedure which were designed for operation on public data networks that support end-to-end P(R) significance. It allows these DTEs to continue to operate with end-to-end P(R) significance within a national network .

For communication within the national network, this facility, when subscribed to:

- a) will change from 0 to 1 the value of bit 7 of the GFI in all *call request* and *call accepted* packets and the value of the D bit in all *DTE data* packets received from the DTE; and
- b) will set to 0 the value of bit 7 of the GFI in all *incoming call* and *call connected* packets, and the value of the D bit in all *DCE data* packets transmitted to the DTE.

For international operation, conversion b) above applies and conversion a) above does not apply. Other conversion rules for international operation are for bilateral agreement between Administrations.

6.4 Packet retransmission

Packet retransmission is an optional user facility agreed for a period of time. It is common to all logical channels at the DTE/DCE interface.

This user facility, if subscribed to, allows a DTE to request retransmission of one or several consecutive *DCE data* packets from the DCE by transferring across the DTE/DCE interface a *DTE reject* packet specifying a logical channel number and a sequence number P(R). The value of this P(R) should be within the range from the last P(R) received by the DCE up to, but not including, the P(S) of the next *DCE data* packet to be transmitted by the DCE. If the P(R) is outside this range, the DCE will initiate the reset procedure with the cause "Local procedure error" and diagnostic # 2.

When receiving a *DTE reject* packet, the DCE initiates on the specified logical channel retransmission of the *DCE data* packets, the packet send sequence numbers of which are starting from P(R), where P(R) is indicated in the *DTE reject* packet. Until the DCE transfers across the DTE/DCE interface a *DCE data* packet with a packet send sequence number equal to the P(R) indicated in the *DTE reject* packet, the DCE will consider the receipt of another *DTE reject* packet as a procedure error and reset the logical channel.

Additional *DCE data* packets pending initial transmission may follow the retransmitted packet(s).

A *DTE receive not ready* situation indicated by the transmission of an *RNR* packet is cleared by the transmission of a *DTE reject* packet.

The conditions under which the DCE ignores a *DTE reject* packet, or considers it as a procedure error, are those described for *flow control* packets (see Annex C).

6.5 Incoming calls barred

Incoming calls barred is an optional user facility agreed for a period of time. This facility applies to all logical channels used at the DTE/DCE interface for virtual calls.

This user facility, if subscribed to, prevents incoming virtual calls from being presented to the DTE. The DTE may originate outgoing virtual calls.

NOTES

- 1 Logical channels used for virtual calls retain their full duplex capability.
- 2 Some Administrations may provide a capability that allows a virtual call to be presented to the DTE only in cases where the called DTE address is the address of the calling DTE.

6.6 Outgoing calls barred

Outgoing calls barred is an optional user facility agreed for a period of time. This facility applies to all logical channels used at the DTE/DCE interface for virtual calls.

This user facility, if subscribed to, prevents the DCE from accepting outgoing virtual calls from the DTE. The DTE may receive incoming virtual calls.

NOTE – Logical channels used for virtual calls retain their full duplex capability.

6.7 One-way logical channel outgoing

One-way logical channel outgoing is an optional user facility agreed for a period of time. This user facility, if subscribed to, restricts the logical channel use to originating outgoing virtual calls only.

NOTE 1 – A logical channel used for virtual calls retains its full duplex capability.

The rules according to which logical channel group numbers and logical channel numbers can be assigned to one-way outgoing logical channels for virtual calls are given in Annex A.

NOTE 2 – If all the logical channels for virtual calls are one-way outgoing at a DTE/DCE interface, the effect is equivalent to the *incoming calls barred* facility (see 6.5, particularly Note 2).

6.8 One-way logical channel incoming

One-way logical channel incoming is an optional user facility agreed for a period of time. This user facility, if subscribed to, restricts the logical channel use to receiving incoming virtual calls only.

NOTE 1 – A logical channel used for virtual calls retains its full duplex capability.

The rules according to which logical channel group numbers and logical channel numbers can be assigned to one-way incoming logical channels for virtual calls are given in Annex A.

NOTE 2 – If all the logical channels for virtual calls are one-way incoming at a DTE/DCE interface, the effect is equivalent to the *outgoing calls barred* facility (see 6.6).

6.9 Non-standard default packet sizes

Non-standard default packet sizes is an optional user facility agreed for a period of time. This facility, if subscribed to, provides for the selection of default packet sizes from the list of packet sizes supported by the Administration. Some networks may constrain the packet sizes to be the same for each direction of data transmission across the DTE/DCE interface. In the absence of this facility, the default packet sizes are 128 octets.

NOTE – In this subclause, the term “packet sizes” refers to the maximum user data field lengths of *DCE data* and *DTE data* packets.

Values other than the default packet sizes may be negotiated for a virtual call by means of the *flow control parameter negotiation* facility (see 6.12). Values other than the default packet sizes may be agreed for a period of time for each permanent virtual circuit.

6.10 Non-standard default window sizes

Non-standard default window sizes is an optional user facility agreed for a period of time. This facility, if subscribed to, provides for the selection of default window sizes from the list of window sizes supported by the Administration. Some networks may constrain the default window sizes to be the same for each direction of data transmission across the DTE/DCE interface. In the absence of this facility, the default window sizes for normal and extended sequence numbering are 2, and the default window sizes for super extended sequence numbering are 128.

Values other than the default window sizes may be negotiated for a virtual call by means of the *flow control parameter negotiation* facility (see 6.12). Values other than the default window sizes may be agreed for a period of time for each permanent virtual circuit.

6.11 Default throughput classes assignment

Default throughput classes assignment is an optional user facility agreed for a period of time. This facility, if subscribed to, provides for the selection of default throughput classes from the list of throughput classes supported by the Administration. Some networks may constrain the default throughput classes to be the same for each direction of data transmission. In the absence of this facility, the default throughput classes correspond to the data rate of the DTE/DCE interface (see 7.3.2) but do not exceed the maximum throughput class supported by the network.

NOTE 1 – When no throughput class corresponds to the data rate of the DTE/DCE interface, the default throughput classes should be the ones just lower than the data rate. However, some networks may choose the ones just higher than the data rate.

The default throughput classes are the maximum throughput classes which may be associated with any virtual call at the DTE/DCE interface. Values other than the default throughput classes may be negotiated for a virtual call by means of one of the *throughput class negotiation* facilities (see 6.13). Values other than the default throughput classes may be agreed for a period of time for each permanent virtual circuit.

NOTE 2 – Throughput characteristics and throughput classes are described in 4.4.2.

6.12 Flow control parameter negotiation

Flow control parameter negotiation is an optional user facility agreed for a period of time which can be used by a DTE for virtual calls. This facility, if subscribed to, permits negotiation on a per call basis of the flow control parameters. The flow control parameters considered are the packet and window sizes at the DTE/DCE interface for each direction of data transmission.

NOTE – In this subclause, the term “packet sizes” refers to the maximum user data field lengths of *DCE data* and *DTE data* packets.

In the absence of the *flow control parameter negotiation* facility, the flow control parameters to be used at a particular DTE/DCE interface are the default packet sizes (see 6.9) and the default window sizes (see 6.10).

When the calling DTE has subscribed to the *flow control parameter negotiation* facility, it may request packet sizes and/or window sizes for both direction of data transmission (see 7.2 and 7.3.1). If particular window sizes are not explicitly requested in a *call request* packet, the DCE will assume that the default window sizes were requested for both directions of data transmission. If particular packet sizes are not explicitly requested, the DCE will assume that the default packet sizes were requested for both directions of data transmission.

When a called DTE has subscribed to the *flow control parameter negotiation* facility, each *incoming call* packet will indicate the packet and window sizes from which DTE negotiation can start. No relationship needs to exist between the packet sizes (P) and window sizes (W) requested in the *call request* packet and those indicated in the *incoming call* packet. The called DTE may request window and packet sizes with facility in the *call accepted* packet. The only valid facility requests in the *call accepted* packet, as a function of the facility indications in the *incoming call* packet, are given in Table 6-1. If the facility request is not made in the *call accepted* packet, the DTE is assumed to have accepted the indicated values (regardless of the default values) for both directions of data transmission.

When the calling DTE has subscribed to the *flow control parameter negotiation* facility, every *call connected* packet will indicate the packet and window sizes to be used at the DTE/DCE interface for the call. The only valid facility indications in the *call connected* packet, as a function of the facility requests in the *call request* packet, are given in Table 6-2.

TABLE 6-1/X.25

Valid facility request in call accepted packets in response to facility indications in incoming call packets

Facility indication	Valid facility request
W(indicated) \geq 2 W(indicated) = 1	W(indicated) \geq W(requested) \geq 2 W(requested) = 1 or 2
P(indicated) \geq 128 P(indicated) < 128	P(indicated) \geq P(requested) \geq 128 128 \geq P(requested) \geq P(indicated)

The network may have constraints requiring the flow control parameters used for a call to be modified before indicating them to the DTE in the *incoming call* packet or *call connected* packet, e.g. the ranges of parameter values available on various networks may differ.

TABLE 6-2/X.25

Valid facility requests in call accepted packets in response to facility indication in incoming call packets

Facility request	Valid facility request
W(requested) \geq 2 W(requested) = 1	W(requested) \geq W(indicated) \geq 2 W(indicated) = 1 or 2
P(requested) \geq 128 P(requested) < 128	P(requested) \geq P(indicated) \geq 128 128 \geq P(indicated) \geq P(requested)

Window and packet sizes need not be the same at each end of a virtual call.

The role of the DCE in negotiating the flow control parameters may be network dependent.

6.13 Throughput class negotiation facilities

Basic throughput class negotiation and *extended throughput class negotiation* are optional user facilities agreed for a period of time which can be used by a DTE for virtual calls. They are both called *throughput class negotiation* facilities. These facilities, if subscribed to, permit negotiation on a per call basis of the throughput classes. A DTE cannot subscribe to both of these facilities. When the *extended throughput class negotiation* facility has been subscribed to, the DTE may explicitly negotiate throughput class values higher than 192 000 bit/s.

The throughput classes are considered independently for each direction of data transmission.

Default values are agreed between the DTE and the Administration (see 6.11). The default values correspond to the maximum throughput classes which may be associated with any virtual call at the DTE/DCE interface.

When the calling DTE has subscribed to one of the *throughput class negotiation* facilities, it may request the throughput classes of the virtual call in the *call request* packet for both directions of data transmission (see 7.2 and 7.3.2). If particular throughput classes are not explicitly requested, the DCE will assume that the default values were requested for both directions of data transmission.

NOTE 1 – When the *basic throughput class negotiation* has been subscribed to, the default throughput classes cannot exceed the highest value (192 000 bit/s) that can be signalled in the *basic throughput class negotiation* facility (see however Note 4 below).

When a called DTE has subscribed to one of the *throughput class negotiation* facilities, each *incoming call* packet will indicate the throughput classes from which DTE negotiation may start. These throughput classes are lower or equal to the ones selected at the calling DTE/DCE interface, either explicitly, or by default if the calling DTE has not subscribed to one of the *throughput class negotiation* facilities or not explicitly requested throughput class values in the *call request* packet. These throughput classes indicated to the called DTE will also not be higher than the default throughput classes, respectively for each direction of data transmission, at the calling and the called DTE/DCE interfaces. They may be further constrained by internal limitations of the network.

The called DTE may request with a facility in the *call accepted* packet throughput classes that should finally apply to the virtual call. The only valid throughput classes in the *call accepted* packet are lower than or equal to the ones (respectively) indicated in the *incoming call* packet. If the called DTE does not make any throughput class facility request in the *call accepted* packet, the throughput classes finally applying to the virtual call will be the ones indicated in the *incoming call* packet.

If the called DTE has not subscribed to one of the *throughput class negotiation* facilities, the throughput classes finally applying to the virtual call are less than or equal to the ones selected at the calling DTE/DCE interface, and less than or equal to the default values defined at the called DTE/DCE interface.

When the calling DTE has subscribed to one of the *throughput class negotiation* facilities, every *call connected* packet will indicate the throughput classes finally applying to the virtual call.

When neither the calling DTE nor the called DTE has subscribed to one of the *throughput class negotiation* facilities, the throughput classes applying to the virtual call will not be higher than the ones agreed as defaults at the calling and called DTE/DCE interfaces. They may be further constrained to lower values by the network, e.g. for international service.

NOTE 2 – Since both *throughput class negotiation* and *flow control parameter negotiation* (see 6.12) facilities can be applied to a single call, the achievable throughput will depend on how users manipulate the D bit.

NOTE 3 – Users are cautioned that the choice of too small a window and packet size of a DTE/DCE interface (made by use of the *flow control parameter negotiation* facility) may adversely affect the attainable throughput class of a virtual call. This is likewise true of flow control mechanisms adopted by the DTE to control data transmission from the DCE.

NOTE 4 – For an interim period, some networks may allow subscription of default throughput classes higher than 192 000 bit/s, when the *basic throughput class negotiation* facility is also subscribed. In this case, the meaning of the value corresponding to 192 000 bit/s in the parameter field of the *basic throughput class negotiation* facility in *incoming call* and *call connected* packets is changed to “192 000 bit/s or higher”.

6.14 Closed user group related facilities

A set of Closed User Group (CUG) optional user facilities enables users to form groups of DTEs to and/or from which access is restricted. Different combinations of access restrictions to and/or from DTEs having one or more of these facilities result in various combinations of accessibility.

A DTE may belong to one or more CUGs. Each DTE belonging to at least one CUG has either the *closed user group* facility (see 6.14.1) or one or both of the *closed user group with outgoing access* and the *closed user group with incoming access* facilities (see 6.14.2 and 6.14.3). For each CUG to which a DTE belongs, either or none of the *incoming calls barred within a closed user group* or the *outgoing calls barred within a closed user group* facilities (see 6.14.4 and 6.14.5) may apply for that DTE. Different combinations of CUG facilities may apply for different DTEs belonging to the same CUG.

When a DTE belonging to one or more CUGs places a virtual call, the DTE may explicitly indicate in the *call request* packet the CUG selected by using the *closed user group selection* facility (see 6.14.6) or the *closed user group with outgoing access selection* facility (see 6.14.7) (see Note). When a DTE belonging to one or more CUGs receives a virtual call, the CUG selected may be explicitly indicated in the *incoming call* packet through the use of the *closed user group selection* facility or the *closed user group with outgoing access selection* facility.

NOTE – For a given virtual call, only one of the above-mentioned selection facilities can be present.

The number of CUGs to which a DTE can belong is network dependent.

6.14.1 Closed user group

Closed user group is an optional user facility agreed for a period of time for virtual calls. This user facility, if subscribed to, enables the DTE to belong to one or more closed user groups. A closed user group permits the DTEs belonging to the group to communicate with each other but precludes communication with all other DTEs.

When the DTE belongs to more than one closed user group, a preferential closed user group must be specified.

6.14.2 Closed user group with outgoing access

Closed user group with outgoing access is an optional user facility agreed for a period of time for virtual calls. This user facility, if subscribed to, enables the DTE to belong to one or more closed user groups (as in 6.14.1) and to originate virtual calls to DTEs in the open part of the network (i.e. DTEs not belonging to any closed user group) and to DTEs belonging to other CUGs with the incoming access capability.

When the *closed user group with outgoing access* facility is subscribed to and the DTE has a preferential CUG, then only the *closed user group selection* facility (as in 6.14.6) is applicable for use at the interface.

When the *closed user group with outgoing access* facility is subscribed to and the network offers to the DTE the capability of choosing whether or not to have a preferential CUG [i.e. the *closed user group with outgoing access selection* facility (see 6.14.7) is offered by the network], and the DTE has no preferential CUG, then both the *closed user group selection* and the *closed user group with outgoing access selection* facilities are applicable for use at the interface.

6.14.3 Closed user group with incoming access

Closed user group with incoming access is an optional user facility agreed for a period of time for virtual calls. This user facility, if subscribed to, enables the DTE to belong to one or more closed user groups (as in 6.14.1) and to receive incoming calls from DTEs in the open part of the network (i.e. DTEs not belonging to any closed user group) and from DTEs belonging to other CUGs with the outgoing access capability.

When the *closed user group with incoming access* facility is subscribed to and the DTE has a preferential CUG, then only the *closed user group selection* facility is applicable for use at the interface.

When the *closed user group with incoming access* facility is subscribed to and the network offers to the DTE the capability of choosing whether or not to have a preferential CUG (i.e. the *closed user group with outgoing access selection* facility is offered by the network), and the DTE has no preferential CUG, then both the *closed user group selection* and the *closed user group with outgoing access selection* facilities are applicable for use at the interface.

6.14.4 Incoming calls barred within a closed user group

Incoming calls barred within a closed user group is an optional user facility agreed for a period of time. This user facility, if subscribed to for a given closed user group, permits the DTE to originate virtual calls to DTEs in this closed user group, but precludes the reception of incoming calls from DTEs in this closed user group.

6.14.5 Outgoing calls barred within a closed user group

Outgoing calls barred within a closed user group is an optional user facility agreed for a period of time. This user facility, if subscribed for a given closed user group, permits the DTE to receive virtual calls from DTEs in this closed user group, but prevents the DTE from originating virtual calls to DTEs in this closed user group.

6.14.6 Closed user group selection

Closed user group selection is an optional user facility which may be used on a per virtual call basis. This facility may be requested or received by a DTE only if it has subscribed to the *closed user group* facility, or the *closed user group with outgoing access* facility and/or the *closed user group with incoming access* facility.

The *closed user group selection* facility (see 7.2 and 7.3.3) may be used by the calling DTE in the *call request* packet to specify the closed user group selected for a virtual call.

The *closed user group selection* facility is used in the *incoming call* packet to indicate to the called DTE the closed user group selected for a virtual call.

The number of closed user groups to which a DTE can belong is network dependent. If the maximum value of the index assigned for use by the DTE to select the closed user group is 99 or less, the basic format of the *closed user group selection* facility must be used. If the maximum value of the index assigned is between 100 and 9999, the extended format of the *closed user group selection* facility must be used.

Some networks may permit a DTE to use either the basic or extended format of the *closed user group selection* facility when the index is 99 or less.

NOTE – When a DTE subscribes to less than 101 closed user groups, the network should be able to agree on a maximum value of the index smaller than 100 if requested by the DTE.

The appearance in a *call request* packet of both formats, or a format inconsistent with the number of CUGs subscribed to, will be treated as a facility code not allowed.

The significance of the *closed user group selection* facility in *call request* packets is given in Table 6-3 and in *incoming call* packets is given in Table 6-4. Further guidance on the operation of *closed user group* facility is provided in Tables 7-5/X.301 and 7-7/X.301, Figures 7-7/X.301 and 7-8/X.301.

6.14.7 Closed user group with outgoing access selection

Closed user group with outgoing access selection is an optional user facility which may be used on a per virtual call basis. This facility may be requested by a DTE only if the network supports it and the DTE has subscribed to the *closed user group with outgoing access* facility or to both the *closed user group with outgoing access* and *closed user group with incoming access* facilities. This facility may be received by a DTE only if the network supports it and the DTE has subscribed to the *closed user group with incoming access* facility or to both the *closed user group with incoming access* and *closed user group with outgoing access* facilities.

The *closed user group with outgoing access selection* facility (see 7.2 and 7.3.4) may be used by the calling DTE in the *call request* packet to specify the closed user group selected for a virtual call and to indicate that outgoing access is also desired.

The *closed user group with outgoing access selection* facility is used in the *incoming call* packet to indicate to the called DTE the closed user group selected for a virtual call and that outgoing access had applied at the calling DTE.

The *closed user group with outgoing access selection* facility can only be present in the facility field of *call set-up* packets if the DTE does not have a preferential closed user group.

The number of closed user groups to which a DTE can belong is network dependent. If the maximum value of the index assigned for use by the DTE to select the closed user group is 99 or less, the basic format of the *closed user group with outgoing access selection* facility must be used. If the maximum value of the index assigned is between 100 and 9999, the extended format of the *closed user group with outgoing access selection* facility must be used.

Some networks may permit a DTE to use either the basic or extended format of the *closed user group with outgoing access selection* facility when the index is 99 or less.

NOTE – When a DTE subscribes to less than 101 closed user groups, the network should be able to agree to a maximum value of the index smaller than 100 if requested by the DTE.

The appearance in a *call request* packet of both formats or a format inconsistent with the number of CUGs subscribed to will be treated as a facility code not allowed.

The significance of the presence of the *closed user group with outgoing access selection* facility in *call request* packets is given in Table 6-3 and in *incoming call* packets is given in Table 6-4.

6.14.8 Absence of both CUG selection facilities

The significance of the absence of both the *closed user group selection* facility and the *closed user group with outgoing access selection* facility in *call request* packets is given in Table 6-3 and in *incoming call* packets is given in Table 6-4.

6.15 Bilateral closed user group related facilities

The set of Bilateral Closed User Group (BCUG) optional user facilities enables pairs of DTEs to form bilateral relations allowing access between each other while excluding access to or from other DTEs with which such a relation has not been formed. Different combinations of access restrictions for DTEs having these facilities result in various combinations of accessibility.

A DTE may belong to one or more BCUGs. Each DTE belonging to at least one BCUG has either the *bilateral closed user group* facility (see 6.15.1) or the *bilateral closed user group with outgoing access* facility (see 6.15.2). For a given BCUG, it is permissible for one DTE to subscribe to the *bilateral closed user group* facility while the other DTE subscribes to the *bilateral closed user group with outgoing access* facility.

When a DTE belonging to one or more BCUGs places a virtual call, the DTE should indicate in the *call request* packet the BCUG selected by using the *bilateral closed user group selection* facility (see 6.15.3). When a DTE belonging to one or more BCUGs receives a virtual call, the BCUG selected will be indicated in the *incoming call* packet through the use of the *bilateral closed user group selection* facility.

The number of BCUGs to which a DTE can belong is network dependent.

6.15.1 Bilateral closed user group

Bilateral closed user group is an optional user facility agreed for a period of time for virtual calls. This facility, if subscribed to, enables the DTE to belong to one or more bilateral closed user groups. A bilateral closed user group permits a pair of DTEs who bilaterally agree to communicate with each other to do so, but precludes communication with all other DTEs.

6.15.2 Bilateral closed user group with outgoing access

Bilateral closed user group with outgoing access is an optional user facility agreed for a period of time for virtual calls. This facility, if subscribed to, enables the DTE to belong to one or more bilateral closed user groups (as in 6.15.1) and to originate virtual calls to DTEs in the open part of the network (i.e. DTEs not belonging to any bilateral closed user group).

6.15.3 Bilateral closed user group selection

Bilateral closed user group selection is an optional user facility which may be used on a per virtual call basis. This facility should be requested or will only be received by a DTE if it has subscribed to the *bilateral closed user group* facility (see 6.15.1), or the *bilateral closed user group with outgoing access* facility (see 6.15.2).

The *bilateral closed user group selection* facility (see 7.2 and 7.3.5) is used by the calling DTE in the *call request* packet to specify the bilateral closed user group selected for a virtual call. The called DTE address length shall be coded all zeros.

The *bilateral closed user group selection* facility is used in the *incoming call* packet to indicate to the called DTE the bilateral closed user group selected for a virtual call. The calling DTE address length will be coded all zeros.

6.16 Fast select

Fast select is an optional user facility which may be requested by a DTE for a given virtual call.

TABLE 6-3/X.25

Meaning of closed user group facilities in call request packets

Closed user group subscription of the calling DTE(Note 1)	Contents of <i>call request</i> packet (Note 2)		
	<i>Closed user group selection facility</i>	<i>Closed user group with outgoing access selection facility</i>	Neither <i>closed user group selection</i> nor <i>closed user group with outgoing access selection facility</i>
CUG with preferential (Note 3)	CUG specified (Note 4)	Not allowed (call cleared)	Preferential or only CUG (Note 4)
CUG/IA with preferential	CUG specified (Note 4)	Not allowed (call cleared)	Preferential or only CUG (Note 4)
CUG/OA with preferential	CUG specified with OA (Note 4)	Not allowed (call cleared)	Preferential or only CUG with outgoing access (Notes 5, 6)
CUG/IA/OA with preferential	CUG specified with OA (Note 4)	Not allowed (call cleared)	Preferential or only CUG with outgoing access (Notes 5, 6)
CUG/IA without preferential	CUG specified (Note 4)	Not allowed (call cleared)	Not allowed (call cleared)
CUG/OA without preferential	CUG specified (Note 4)	CUG specified with outgoing access (Notes 5, 6)	Outgoing access
CUG/IA/OA without preferential	CUG specified (Note 4)	CUG specified with outgoing access (Notes 5, 6)	Outgoing access
No CUG	Not allowed (call cleared)	Not allowed (call cleared)	Outgoing access

OA Outgoing Access
IA Incoming Access

NOTES

- The order of subscription types is different from that in Table 6-4.
- The inclusion of both the *closed user group selection* facility and the *closed group with outgoing access selection* facility is not allowed in the *call request packet*.
- CUG without preferential is not allowed.
- If outgoing calls are barred within the specified CUG or within the preferential or only CUG, then the call is cleared.
- If outgoing calls are barred within the specified CUG or within the preferential or only CUG, then only outgoing access applies.
- For international calls, if the destination network does not support the *closed user group with outgoing access selection* facility, the call may be cleared even if the called DTE belongs to the specified closed user group or to the open world or has incoming access.

DTEs can request the *fast select* facility on a per call basis by means of an appropriate facility request (see 7.2 and 7.3.6) in a *call request* packet using any logical channel which has been assigned to virtual calls.

The *fast select* facility, if requested in the *call request* packet and if it indicates no restriction on response, allows this packet to contain a call user data field of up to 128 octets, authorizes the DCE to transmit to the DTE, during the *DTE waiting* state, a *call connected* or *clear indication* packet with a called or clear user data field respectively of up to 128 octets, and authorizes the DTE and the DCE to transmit after the call is connected, a *clear request* or a *clear indication* packet, respectively, with a clear user data field of up to 128 octets.

TABLE 6-4/X.25

Meaning of closed user group facilities in incoming call packets

Closed user group subscription of the called DTE (Note 1)	Contents of <i>incoming call packet</i>		
	<i>Closed user group selection facility</i> (Note 3)	<i>Closed user group with outgoing access selection facility</i> (Note 3)	Neither <i>closed user group selection</i> nor <i>closed user group with outgoing access selection facility</i>
CUG with preferential (Note 2)	CUG specified	Not applicable	preferential or only CUG (Note 5)
CUG/OA with preferential	CUG specified	Not applicable	preferential or only CUG (Note 5)
CUG/IA with preferential	CUG specified or CUG specified with incoming access	Not applicable	One of the following: – Preferential or only CUG – Preferential or only CUG with incoming access (Note 4) – Incoming access
CUG/IA/OA with preferential	CUG specified or CUG specified with incoming access	Not applicable	One of the following: – Preferential or only CUG – Preferential or only CUG with incoming access (Note 4) – Incoming access
CUG/OA without preferential	CUG specified	Not applicable	Not applicable
CUG/IA without preferential	CUG specified	CUG specified with incoming access	Incoming access
CUG/IA/OA without preferential	CUG specified	CUG specified with incoming access	Incoming access
No CUG	Not applicable	Not applicable	Incoming access
OA Outgoing Access IA Incoming Access NOTES 1 The order of subscription types is different from that in Table 6-3. 2 CUG without preferential is not allowed. 3 In this case, incoming calls are not barred within the specific CUG. 4 When incoming calls are barred within this CUG, only incoming access applies. 5 In this case, incoming calls are not barred within the preferential or only CUG			

The *fast select* facility, if requested in the *call request* packet and if it indicates restriction on response, allows this packet to contain a call user data field of up to 128 octets and authorizes the DCE to transmit to the DTE, during the *DTE waiting* state, a *clear indication* packet with a clear user data field of up to 128 octets; the DCE would not be authorized to transmit a *call connected* packet.

When a DTE requests the *fast select* facility in a *call request* packet, the *incoming call* packet should only be delivered to the called DTE if that DTE has subscribed to the *fast select acceptance* facility (see 6.17).

If the called DTE has subscribed to the *fast select acceptance* facility, it will be advised that the *fast select* facility, and an indication of whether or not there is a restriction on the response, has been requested through the inclusion of the appropriate facility (see 7.2 and 7.3.6) in the *incoming call* packet.

If the called DTE has not subscribed to the *fast select acceptance* facility, an *incoming call* packet with the *fast select* facility requested will not be transmitted and a *clear indication* packet with the cause “Fast select acceptance not subscribed” will be returned to the calling DTE.

The presence of the *fast select* facility indicating no restriction on response in an *incoming call* packet permits the DTE to issue as a direct response to this packet a *call accepted* or *clear request* packet with a called or clear user data field, respectively, of up to 128 octets. If the call is connected, the DTE and the DCE are then authorized to transmit a *clear request* or a *clear indication* packet, respectively, with a clear user data field of up to 128 octets.

The presence of the *fast select* facility indicating restriction on response in an *incoming call* packet permits the DTE to issue as a direct response to this packet a *clear request* packet with a clear user data field of up to 128 octets; the DTE would not be authorized to send a *call accepted* packet.

NOTE – The call user data field, the called user data field and the clear user data field will not be fragmented for delivery across the DTE/DCE interface.

The significance of the *call connected* packet or the *clear indication* packet with the cause “DTE originated” as a direct response to the *call request* packet with the *fast select* facility is that the *call request* packet with the data field has been received by the called DTE.

All other procedures of a call in which the *fast select* facility has been requested are the same as those of a virtual call.

6.17 Fast select acceptance

Fast select acceptance is an optional user facility agreed for a period of time. This user facility, if subscribed to, authorizes the DCE to transmit to the DTE incoming calls which request the *fast select* facility. In the absence of this facility, the DCE will not transmit to the DTE incoming calls which request the *fast select* facility.

6.18 Reverse charging

Reverse charging is an optional user facility which may be requested by a DTE for a given virtual call (see 7.2 and 7.3.6).

6.19 Reverse charging acceptance

Reverse charging acceptance is an optional user facility agreed for a period of time for virtual calls. This user facility, if subscribed to, authorizes the DCE to transmit to the DTE incoming calls which request the *reverse charging* facility. In the absence of this facility, the DCE will not transmit to the DTE incoming calls which request the *reverse charging* facility.

6.20 Local charging prevention

Local charging prevention is an optional user facility agreed for a period of time for virtual calls. This user facility, when subscribed to, authorizes the DCE to prevent the establishment of virtual calls which the subscriber must pay for by:

- a) not transmitting to the DTE incoming calls which request the *reverse charging* facility; and
- b) ensuring that the charges are made to another party whenever a call is requested by the DTE. This other party can be determined by using any of a number of actions, both procedural and administrative. The procedural methods include:
 - the use of reverse charging;
 - identification of a third party using *NUI subscription* facility (see 6.21.1) and *NUI selection* facility (see 6.21.3).

When the party to be charged has not been established for a call request, the DCE that receives the *call request* packet will apply reverse charging to this call.

NOTE – For an interim period of time, some networks may choose to enforce local charging prevention by clearing the call when the party to be charged has not been established.

6.21 Network User Identification (NUI) related facilities

The set of Network User Identification (NUI) related facilities enables the DTE to provide information to the network for purposes of billing, security, network management, or to invoke subscribed facilities.

This set is composed of three optional user facilities, *NUI subscription* facility (see 6.21.1) and *NUI override* facility (see 6.21.2) may be agreed for a period of time for virtual calls. A DTE may subscribe to one or both of these facilities. When one or both of these facilities are subscribed to, one or several network user identifiers are also agreed for a period of time. A given network user identifier may be either specific or common to *NUI subscription* facility and *NUI override* facility. The network user identifier is transmitted by the DTE to the DCE in the *NUI selection* facility (see 6.21.3).

Network user identifier is never transmitted to the remote DTE. The calling DTE address transmitted to the remote DTE in the calling DTE address field should not be inferred from the network user identifier transmitted by the DTE in the *NUI selection* facility in the *call request* packet.

6.21.1 NUI subscription

NUI subscription is an optional user facility agreed for a period of time for virtual calls. This facility, if subscribed to, enables the DTE to provide information to the network for billing, security or network management purposes on a per call basis. This information may be provided by the DTE in the *call request* packet or in the *call accepted* packet by using the *NUI selection* facility (see 6.21.3). It may be used whether or not the DTE has also subscribed to the *local charging prevention* facility (see 6.20). If the DCE determines that the network user identifier is invalid or that the *NUI selection* facility is not present when required by the network, it will clear the call as described in Annex C.

6.21.2 NUI override

NUI override is an optional user facility agreed for a period of time for virtual calls. When this facility is subscribed to, one or more network user identifiers are also agreed for a period of time. Associated with each network user identifier is a set of subscription-time optional user facilities. When one of these network user identifiers is provided in a *call request* packet by means of the *NUI selection* facility (see 6.21.3), the set of subscription-time optional user facilities associated with it overrides the facilities which apply to the interface. This override does not apply to other existing calls or subsequent calls on the interface. It remains in effect for the duration of the particular call to which it applies.

The optional user facilities that may be associated with a network user identifier when the *NUI override* facility has been subscribed to are specified in Annex F. The optional user facilities which have been agreed for a period of time for the interface and which are not overridden by using the *NUI override* facility remain in effect.

6.21.3 NUI selection

NUI selection is an optional user facility which may be requested by a DTE for a given virtual call (see 7.2 and 7.3.7). This user facility may be requested by a DTE only if it has subscribed to the *NUI subscription* facility (see 6.21.1) and/or the *NUI override* facility (see 6.21.2). *NUI selection* facility permits the DTE to specify which network user identifier is to be used in conjunction with the *NUI subscription* facility and/or the *NUI override* facility.

NUI selection may be requested in a *call request* packet if the selected network user identifier has been agreed in conjunction with the *NUI subscription* facility or the *NUI override* facility. *NUI selection* may be requested in the *call accepted* packet if the selected network user identifier has been agreed in conjunction with the *NUI subscription* facility.

Some networks may require that the *NUI selection* facility be requested by the DTE in every *call request* packet and, possibly, in every *call accepted* packet transmitted on a given DTE/DCE interface, when the *NUI subscription* facility has been agreed for a period of time for the interface.

If the network determines that the network user identifier is invalid or that any of the optional user facilities requested in the *call request* packet are not allowed for the DTE, it will clear the call.

6.22 Charging information

Charging information is an optional user facility which may be either agreed for a period of time or requested by a DTE for a given virtual call.

If the DTE is the DTE to be charged, the DTE can request the *charging information* facility on a per call basis by means of an appropriate facility request (see 7.2 and 7.3.8.1) in a *call request* packet or *call accepted* packet.

If a DTE subscribes to the *charging information* for a contractual period, the facility is in effect for the DTE, whenever the DTE is the DTE to be charged, without sending the facility request in *call request* or *call accepted* packets.

Using the *clear indication* or *DCE clear confirmation* packet, the DCE will send to the DTE information about the charge for that call and/or other information which makes it possible for the user to calculate the charge.

6.23 ROA related facilities

The set of ROA optional user facilities provides for the calling DTEs designation of a sequence of one or more ROA transit network(s) within the originating country through which the call is to be routed when more than one ROA transit network exists at a sequence of one or more gateways. In the case of international calls, this capability includes the selection of an international ROA in the originating country.

6.23.1 ROA subscription

ROA subscription is an optional user facility agreed for a period of time for virtual calls. This user facility, if subscribed to, applies (unless overridden for a single virtual call by the *ROA selection* facility) to all virtual calls where more than one ROA transit network exist at a sequence of one or more gateways. The *ROA subscription* facility provides a sequence of ROA transit networks through which calls are to be routed. In the absence of both the *ROA subscription* facility and the *ROA selection* facility (see 6.23.2), no user designation of ROA transit networks is in effect.

6.23.2 ROA selection

ROA selection is an optional user facility which may be requested by a DTE for a given virtual call (see 7.2 and 7.3.9). It is not necessary to subscribe to the *ROA subscription* facility in order to use this facility. This facility, when used for a given virtual call, applies for this virtual call only where more than one ROA transit network exist at a sequence of one or more gateways. The *ROA selection* facility provides a sequence of ROA transit networks through which the call is to be routed. The presence of this facility in a *call request* packet completely overrides the sequence of ROA transit networks that may have been specified by the *ROA subscription* facility (see 6.23.1).

If the DTE selects only one ROA transit network, either the basic or extended format of the *ROA selection* facility may be used. If the DTE selects more than one ROA transit network, the extended format of the *ROA selection* facility is used. The appearance of both formats in a *call request* packet will be treated as a facility code not allowed.

6.24 Hunt group

Hunt group is an optional user facility agreed for a period of time. This user facility, if subscribed to, distributes incoming calls having an address associated with the hunt group across a designated grouping of DTE/DCE interfaces.

Selection is performed for an incoming virtual call if there is at least one logical channel in the *ready* state (see 4.1.1), excluding one-way outgoing logical channels, available for virtual calls on any of the DTE/DCE interfaces in the group. Once a virtual call is assigned to a DTE/DCE interface, it is treated as a regular call.

When virtual calls are placed to a hunt group address in the case that specific addresses have also been assigned to the individual DTE/DCE interfaces, the *clear indication* packet (when no *call accepted* packet has been transmitted) or the *call connected* packet transferred to the calling DTE may contain the called DTE address of the selected DTE/DCE interface and the *called line address modified notification* facility (see 6.26) indicating the reason why the called DTE address is different from the one originally requested.

Virtual calls may be originated by the DTEs on DTE/DCE interfaces belonging to the hunt group; these are handled in the normal manner. In particular, the calling DTE address transferred to the remote DTE in the *incoming call* packet is the hunt group address unless the DTE/DCE interface has a specific address assigned. Permanent virtual circuits may be assigned to DTE/DCE interfaces belonging to the hunt group. These permanent virtual circuits are independent of the operation of the hunt group. Some networks may apply virtual call subscription time user facilities in common to all DTE/DCE interfaces in the hunt group, place a limit on the number of DTE/DCE interfaces in the hunt group, and/or constrain the size of the geographic region that can be served by a single hunt group.

6.25 Call redirection and call deflection related facilities

The set of call redirection and call deflection optional user facilities enables the redirection or the deflection of calls destined to one DTE (the “originally called DTE”) to another DTE (the “alternate DTE”). The *call redirection* facility (see 6.25.1) allows the DCE, in specific circumstances, to redirect calls destined to the originally called DTE; no *incoming call* packet is transmitted to the originally called DTE when such a redirection is performed. The *call deflection* related facilities (see 6.25.2) allow the originally called DTE to deflect individual incoming virtual calls after reception of the *incoming call* packet by this originally called DTE. A DTE may subscribe to the *call redirection* facility, to the *call deflection subscription* facility, or to both.

NOTE – It is not precluded that, in some cases, the alternate DTE be the same as the calling DTE, mainly when it is a packet switched private data network.

When a call to which the *call redirection* or *call deflection* facilities are applied is cleared, the clearing cause shall be that generated during the last attempt to reach a called DTE/DCE interface.

The basic service is limited to one call redirection or call deflection. In addition, some networks may permit a chaining of several call redirections or call deflections. In all cases, networks will ensure that loops are avoided and that the connection establishment phase has a limited duration, consistent with the DTE time limit T21 (see Table D.2).

When the virtual call is redirected or deflected, the *clear indication* packet, when no *call accepted* packet has been transmitted by any DTE, or the *call connected* packet transferred to the calling DTE will contain the called address of the alternate DTE and the *called line address modified notification* facility (see 6.26), indicating the reason why the called address is different from the one originally requested.

When the virtual call is redirected or deflected, some networks may indicate to the alternate DTE that the call was redirected or deflected, the reason for redirection or deflection, and the address of the originally called DTE, using the *call redirection* or *call deflection notification* facility (see 6.25.3) in the *incoming call* packet.

In addition, some networks may allow a DTE to indicate in a *call request* packet (see 6.25.3) that the call was redirected or deflected, the reason for the redirection or deflection, and the address of the originally called DTE, using the *call redirection* or *call deflection notification* facility.

Further information on the coding of the alternate DTE address is given in Appendix IV.

6.25.1 Call redirection

Call redirection is an optional user facility agreed for a period of time. This user facility, if subscribed to, redirects calls destined to this DTE when:

- 1) the DTE is out of order; or
- 2) the DTE is busy.

Some networks may provide call redirection only in case of 1). Some networks may offer, in addition:

- 3) systematic call redirection due to a prior request by the subscriber according to criteria other than 1) and 2) above, agreed to between the network and the subscriber.

In addition to the basic service, some networks may offer either one of the following (mutually exclusive) capabilities:

- 1) a list of alternate DTEs (C1, C2, . . .) is stored by the network of the originally called DTE (DTE B). Consecutive attempts of call redirection are tried to each of these addresses, in the order of the list, up to the completion of the call;
- 2) call redirections may be logically chained; if DTE C has subscribed to call redirection to DTE D, a call redirected from DTE B to DTE C may be redirected to DTE D; call redirections and call deflections may also be chained.

The order of call set-up processing at the originally called DCE as well as the alternate DCE will be according to the sequence of *call progress* signals in Table 1/X.96. For those networks that provide systematic call redirection due to a prior request by the subscriber, the systematic call redirection request will have the highest priority in the call set-up processing sequence at the originally called DCE.

6.25.2 Call deflection related facilities

6.25.2.1 Call deflection subscription

Call deflection subscription is an optional user facility agreed for a period of time. This facility, if subscribed to, enables the DTE to request, by using the *call deflection selection* facility (see 6.25.2.2), that an individual call presented to it by transmission of an *incoming call* packet be deflected to an alternate DTE.

The DCE may use a network timer, with a value agreed to with the subscriber, to limit the time between the transmission to the called DTE (either the originally called DTE or an alternate DTE in case of prior call redirection or call deflection) of an *incoming call* packet and the request by this called DTE of deflecting the call. Once this timer has expired, the called DTE will no longer be permitted to use the *call deflection selection* facility to deflect the call. If the called DTE tries to deflect the call after the expiration of this internal timer, the network clears the call.

6.25.2.2 Call deflection selection

Call deflection selection is an optional user facility which may be used on a per virtual call basis. This facility may be requested by a DTE only if it has subscribed to the *call deflection subscription* facility (see 6.25.2.1).

The *call deflection selection* facility (see 7.2 and 7.3.10) may be used by the called DTE in the *clear request* packet only in direct response to an *incoming call* packet to specify the alternate DTE address to which the call is to be deflected. If the *call deflection selection* facility is used in the *clear request* packet, then the DTE must also include any ITU-T-specified DTE facilities and user data to be sent to the alternate DTE. The ITU-T-specified DTE facilities and user data in the *clear request* packet are not dependent on the contents of the original *incoming call* packet. Up to 16 octets of user data may be included in the *clear request* packet in this case, if the original call was established without fast select; up to 128 octets of user data may be included in the *clear request* packet if the original call was established with fast select. If no ITU-T-specified DTE facilities are included in the *clear request* packet, then there will be none in the *incoming call* packet to the alternate DTE. If no clear user data is included in the *clear request* packet, then no call user data will be included in the *incoming call* packet to the alternate DTE. When requested for a given virtual call, the network deflects the call to the alternate DTE and does not respond to the calling DTE as a result of the clearing of the called DTE/DCE interface. The X.25 facilities that are present in the *incoming call* packet transmitted to the alternate DTE are those that would have been present in the *incoming call* packet if the call was a direct call from the calling DTE to the alternate DTE; moreover, the *call redirection* or *call deflection notification* facility (see 6.25.3) may also be present, if supported by the network.

The bit 7 of the General Format Identifier (see 4.3.3) in the *incoming call* packet transmitted to the originally called DTE or the alternate DTE has the same value as the same bit in the *call request* packet.

If the network offers only the basic service and if a call redirection or call deflection has already been performed, the DCE clears the call as indicated in Annex C when the *call deflection selection* facility is used.

6.25.3 Call redirection or call deflection notification

Call redirection or *call deflection notification* is a user facility used by the DCE in the *incoming call* packet to inform the alternate DTE that the call has been redirected or deflected, why the call was redirected or deflected, and the address of the originally called DTE.

When more than one address applies to a DTE/DCE interface, the *call redirection* or *call deflection notification* facility may also be used by the DTE in a *call request* packet to inform the called DTE that the call has been redirected or deflected in the calling DTE (which is supposed to be a packet switched private data network). When this facility is received from the DTE, the DCE will clear the call if the address contained in this facility is not one of those applying to the interface.

NOTE – This last possibility may not be supported by all network supporting the *call redirection* or *call deflection notification* facility

The following reasons can be indicated with the use of the *call redirection* or *call deflection notification* facility (see 7.2 and 7.3.11):

- 1) call redirection due to originally called DTE out of order;
- 2) call redirection due to originally called DTE busy;
- 3) call redirection due to prior request from the originally called DTE for systematic call redirection;
- 4) call deflection by the originally called DTE;
- 5) call redirection or call deflection in the calling DTE (which is supposed to be a packet switched private data network).

Some networks may also use the following reason in network-dependent cases not described in this Recommendation:

- 6) call distribution within a hunt group.

6.25.4 Inter-network Call Redirection and Deflection (ICRD) control facilities

Call redirection or call deflection is considered to be inter-network when the originally called DTE and the alternate DTE are on different PSPDNs. Because the tariff between the calling DTE and the alternate DTE may be more expensive than that between the calling DTE and the originally called DTE, optional facilities are defined to prevent ICRD from taking place in all cases of ICRD except for one. The exception case is when the calling DTE and the alternate DTE are served by the same PSPDN.

When a PSPDN supports ICRD, it will allow ICRD to take place unless the user subscribes to *ICRD prevention subscription* facility or uses the per call *ICRD status selection* facility to signal that ICRD should be prevented for the call. If a PSPDN does not support ICRD, ICRD is prevented by default.

6.25.4.1 ICRD prevention subscription

ICRD prevention subscription is an optional user facility agreed for a period of time. This facility, if subscribed to, will prevent calls originated by the subscribed DTE from undergoing ICRD except in the case where the alternate DTE is served by the same PSPDN as that of the subscribed DTE. This facility may be overridden by the *ICRD status selection* facility (see 6.25.4.2).

6.25.4.2 ICRD status selection

ICRD status selection is an optional user facility which may be used on a per virtual call basis. This facility may be requested by a calling DTE.

The *ICRD status selection* facility may be used by the calling DTE in the *call request* packet to indicate whether ICRD should be allowed or prevented. If signalled by the calling DTE, it overrides the default status of the interface concerning whether ICRD should be allowed or prevented. If the *ICRD status selection* facility indicates that ICRD allowance is requested, ICRD should be allowed by the PSPDN for the call whether or not *ICRD prevention subscription* facility is subscribed by the user. Likewise, if the *ICRD status selection* facility indicates that ICRD is prevented, ICRD should be prevented by the PSPDN for the call even if *ICRD prevention subscription* facility is not subscribed by the user.

This facility is not applicable to PSPDNs that do not support ICRD.

6.26 Called line address modified notification

Called line address modified notification is an optional user facility used by the DCE in the *call connected* or *clear indication* packets (see 7.2 and 7.3.12) to inform the calling DTE why the called DTE address in the packet is different from that specified in the *call request* packet transmitted by the calling DTE.

When more than one address applies to a DTE/DCE interface, the *called line address modified notification* facility may be used by the called DTE in the *clear request* packet (when no *call accepted* packet has been transmitted) or the *call accepted* packet, when the called DTE address is present in the packet and different from that specified in the *incoming call* packet. When this facility is received from the DTE, the DCE will clear the call if the called DTE address is not one of those applying to the interface.

NOTE – The DTE should be aware that a modification of any part of the called DTE address field, without notification by the *called line address modified notification* facility, may cause the call to be cleared.

The following reasons can be indicated with the use of the *called line address modified notification* facility in *call connected* or *clear indication* packets transmitted to the calling DTE:

- 1) call distribution within a hunt group;
- 2) call redirection due to originally called DTE out of order;
- 3) call redirection due to originally called DTE busy;
- 4) call redirection due to a prior request from the originally called DTE according to criteria agreed to between the network and the subscriber;
- 5) called DTE originated;
- 6) call deflection by the originally called DTE.

In *call accepted* or *clear request* packets, the reason indicated in conjunction with the use of the *called line address modified notification* facility should be “called DTE originated”.

When several reasons could apply to a same call, the reason to be indicated by the network in the *call connected* or the *clear indication* packet by means of the *called line address modified notification* facility is as specified below:

- 1) the indication of a call redirection or call deflection in the network has precedence over the indication of distribution within a hunt group or over a called DTE originated indication;
- 2) the called DTE originated indication has precedence over the indication of distribution within a hunt group;
- 3) when several call redirections or call deflections have been performed, the first one has precedence over the others.

The called DTE address indicated in the *call connected* or the *clear indication* packets should correspond to the last DTE which has been reached or attempted.

6.27 Transit delay selection and indication

Transit delay selection and indication is an optional user facility which may be requested by a DTE for a given virtual call. This facility permits selection and indication, on a per call basis, of the transit delay applicable to that virtual call as defined in 4.3.8.

A DTE wishing to specify a desired transit delay in the *call request* packet for a virtual call indicates the desired value (see 7.2 and 7.3.13).

The network, when able to do so, should allocate resources and route the virtual call in a manner such that the transit delay applicable to that call does not exceed the desired transit delay.

The *incoming call* packet transmitted to the called DTE and the *call connected* packet transmitted to the calling DTE, will both contain the indication of the transit delay applicable to the virtual call. This transit delay may be smaller than, equal to, or greater than the desired transit delay requested in the *call request* packet.

NOTE – During the interim period when this optional user facility is not yet supported by all networks, the indication of the transit delay applicable to the virtual call will not be provided in the *incoming call* packet transmitted to the called DTE, if either a transit network or the destination network does not support this facility.

6.28 Alternative addressing related facilities

The set of alternative addressing related facilities enables a virtual call to be established using an alternative address to identify a called DTE by the calling DTE or an alternate DTE by the deflecting DTE. An alternative address is defined as one that does not conform to the formats defined in Recommendations X.121 and X.301. In particular the following alternative addresses may be supported:

- Character string coded in accordance with CCITT Rec. T.50 | ISO/IEC 646;
- OSI NSAP address coded in accordance with CCITT Rec. X.213 | ISO/IEC 8348;
- Media Access Control (MAC) address in accordance with ISO/IEC 10039;
- an Internet address according to RFC 1166.

When an alternative address is received in a *call request* packet or a *clear request* packet with the *call deflection selection* facility, the DCE shall translate the alternative address to the format defined in Recommendations X.121 and X.301 as the basis on which to route the call. The translation of the address will depend on the rules determined at subscription time. A single alternative address could map to several X.121 addresses dependent on parameters such as time of day, etc. A single X.121 address could be reached by multiple alternative addresses.

NOTE – The use of directories to resolve the translation of the alternative address is a matter for further study.

When establishing a virtual call, an alternative address can only be present in the *call request* packet or in the *clear request* packet when the *call deflection selection* facility is used. The use of addresses in all other packets (including *clear request* packets when the *call deflection selection* facility is not used) is unchanged by using an alternative address in these cases. When an alternative address is used, the called DTE address of the *incoming call* and *call accepted* packets will conform to the format specified in Recommendations X.121 and X.301. However, it is a network option that the called DTE address of the *call connected* packet can either conform to the format specified in Recommendations X.121 and X.301 or be absent.

6.28.1 Alternative address registration related facilities

The set of alternative address registration related facilities, when subscribed to, enables users to register alternative addresses. There are two facilities for registering an alternative address. Depending on which facility is subscribed to, the alternative address either will have global significance or will be interface specific.

6.28.1.1 Global alternative address registration

Global alternative address registration is an optional user facility agreed for a period of time. Any DTE (both inside and outside of a specific network) can register alternative address translations with an Administration. All such alternative addresses would require uniqueness within the network of registration and thus have network wide (global) significance.

NOTE – It is envisaged that global translations will be registered for the benefit of any invoking DTEs, either as calling DTEs or as clearing DTEs using the *call deflection selection* facility. In this case, the translation of the alternative address would be independent of the invoking DTE. Organisations wishing the invoking DTEs of a specific network to use the alternative address of a DTE rather than its X.121 number will need to register such alternative addresses with the specific Administration.

6.28.1.2 Interface specific alternative address registration

Interface specific alternative address registration is an optional user facility agreed for a period of time. When subscribed to, alternative address translations that are specific to a DTE/DCE interface for use by a DTE when making or deflecting a call may be registered. In such cases, the rules for translation of the interface specific alternative

addresses are given at registration time. The *alternative address usage subscription* facility (see 6.28.2) must also be subscribed to. When an interface specific alternative address is the same as a global alternative address, the interface specific alternative address takes precedence and the translation will be according to the rules defined for the specific DTE/DCE interface.

6.28.2 Alternative address usage subscription

Alternative address usage subscription is an optional user facility which, when subscribed to by a DTE, allows the DTE to use an alternative address in the *call request* packet or the *clear request* packet with the *call deflection selection* facility. The decision to use an alternative address is made on a per call basis.

Networks may support all or a sub-set of the formats listed in 6.28. The formats supported will be made known to subscribing DTEs.

Which set is supported will determine how the alternative address may be carried in the *call request* packet (see 6.28.3.1 and 6.28.3.2). Two network options are allowed for use by DTEs. The first option permits a DTE to use the address block to carry any of the alternative address formats (see 6.28.3.1). The second option allows the DTE to use the *called address extension* facility (see Annex G) to carry an OSI NSAP address (i.e. an address conforming to CCITT Rec. X.213 | ISO/IEC 8348) as an alternative address (see 6.28.3.2). Either or both of these options can be supported by Administrations.

Regardless of the set of alternative addresses supported, the alternative address is always carried in the *call deflection selection* facility of a clear request packet.

6.28.3 Alternative address selection

When the *alternative address usage subscription* facility (see 6.28.2) has been subscribed to, a calling or deflecting DTE may identify a called DTE by using an alternative address in the *call request* packet or the *call deflection selection* facility of a *clear request* packet, respectively. In such cases the network would perform an analysis of the alternative address and derive an address conforming to the formats described in Recommendations X.121 and X.301 as the basis on which to route the call.

6.28.3.1 Use of the address block to carry an alternative address in a call request packet

If the first option of the *alternative address usage subscription* facility (see 6.28.2) applies to the DTE/DCE interface, then the alternative address is carried in the called address field of the *call request* packet using the TOA/NPI address format.

The coding of the TOA and NPI subfields when the alternative address is carried in the called DTE address field of the *call request* packet is given in Tables 5-3 and 5-5.

6.28.3.2 Use of the called address extension facility to carry an alternative address in a call request packet

If the second option of the *alternative address usage subscription* facility (see 6.28.2) applies to the DTE/DCE interface, then the alternative address is carried in the *called address extension* facility (see Annex G) of the *call request* packet.

The fact that the *called address extension* facility is being used to carry an alternative address is indicated by the called DTE address length field in the address block of the *call request* packet being set to zero.

NOTE 1 – The preferred method for using the *called address extension* facility is described above. However, some networks may implement a subscription-time optional user facility allowing the use of the *called address extension* facility to carry an alternative address without having the called DTE address length field set to zero. In this case, the translation will apply for every *call request* packet.

The OSI NSAP address carried in the *called address extension* facility would be passed unchanged between the two packet-mode terminals involved.

NOTE 2 – In those cases where the network does not support the analysis and translation of the OSI NSAP address carried in the *called address extension* facility, the semantics of an NSAP address can be used as an alternative address and carried in the called DTE address field of the *call request* packet in accordance with the codings specified in Tables 5-3 and 5-5 (see also 6.28.3.1). However, in such cases when this format is used and the called OSI NSAP address is also required by the called DTE, then the called OSI NSAP address must also be included in the *called address extension* facility by the calling DTE.

NOTE 3 – In those cases where the alternative address is not an NSAP address, and where the called DTE requires knowledge of the alternative address (for example a LAN address), the alternative address can be preserved and conveyed to the called DTE by carrying the alternative address in both the called DTE address field of the *call request* packet and the *called address extension* facility with the bits 8 and 7 of the first octet of the called extension facility set to 1 and 0 respectively to indicate that the called address is a non NSAP format (see Annex G).

6.28.3.3 Use of the call deflection selection facility to carry an alternative address in a clear request packet

When using an alternative address in a *clear request* packet, the alternative address is carried in the *call deflection selection* facility (see 6.25.2.2 and 7.3.10).

NOTES

1 When the called OSI NSAP address is also required by the called DTE, it must also be included in the *called address extension* facility by the deflecting DTE.

2 In those cases where the alternative address is not an NSAP address, and where the called DTE requires knowledge of the alternative address (e.g. a LAN address), the alternative address can be preserved and conveyed to the alternate DTE by carrying the alternative address in both the *call deflection selection* facility and the *called address extension* facility of the *clear request* packet with the bits 8 and 7 of the first octet of the *called address extension* facility set to 1 and 0 respectively to indicate that the called DTE address is a non NSAP format (see Annex G).

7 Formats for facility fields

7.1 General

The facility field is present only when a DTE is using an optional user facility requiring some indication in the *call request*, *incoming call*, *call accepted*, *call connected*, *clear request*, *clear indication* or *DCE clear confirmation* packet.

The facility field contains one or more facility elements. The first octet of each facility element contains a facility code to indicate the facility or facilities requested/negotiated.

The facility codes are divided into four classes, by making use of bits 8 and 7 of the facility code field, in order to specify facility parameters consisting of 1, 2, 3 or a variable number of octets. The general class coding of the facility code field is shown in Table 7-1.

TABLE 7-1/X.25

General class coding for facility code fields

Bits	8	7	6	5	4	3	2	1	
Class A	0	0	X	X	X	X	X	X	For single octet parameter field
Class B	0	1	X	X	X	X	X	X	For double octet parameter field
Class C	1	0	X	X	X	X	X	X	For triple octet parameter field
Class D	1	1	X	X	X	X	X	X	For variable length parameter field

For class D the octet following the facility code indicates the length, in octets, of the facility parameter field. The facility parameter field length is binary coded and bit 1 is the low order bit of this indicator.

The formats for the four classes are shown in Figure 7-1.

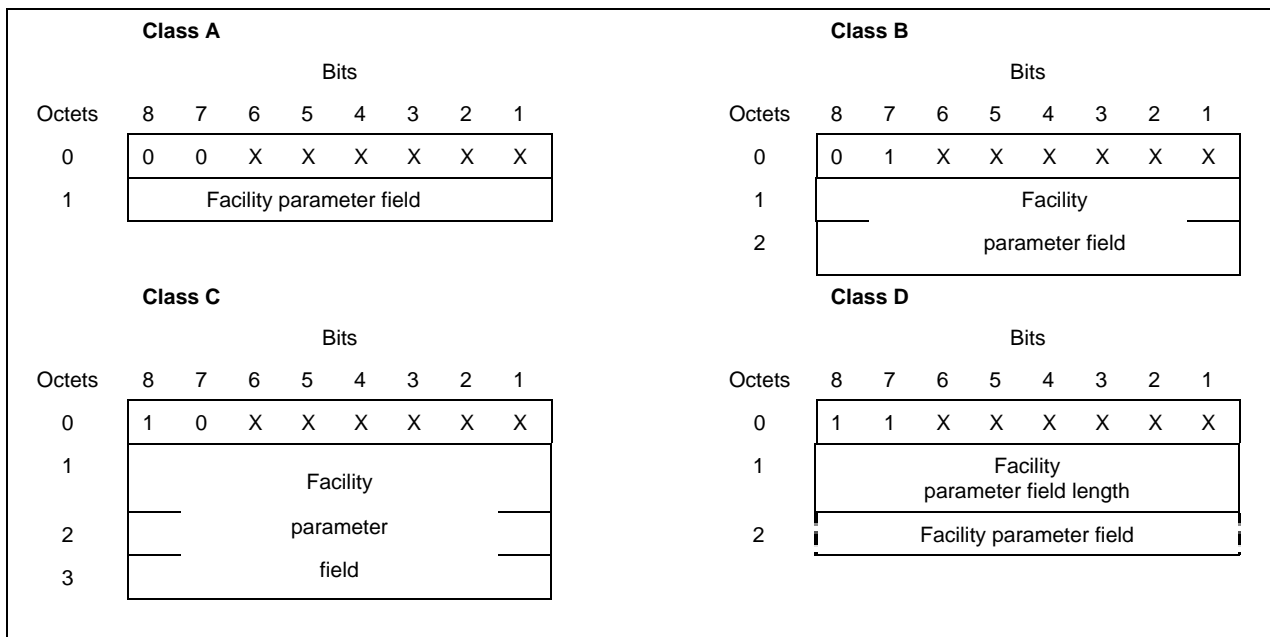

FIGURE 7-1/X.25

Facility element general formats

The facility code field is binary coded and, without extension, provides for a maximum of 64 facility codes for classes A, B and C and 63 facility codes for class D giving a total of 255 facility codes.

Facility code 11111111 is reserved for extension of the facility code. The octet following this octet indicates an extended facility code having the format A, B, C and D as defined above. Repetition of facility code 11111111 is permitted and additional extensions thus result.

The coding of the facility parameter field is dependent on the facility being requested/negotiated.

A facility code may be assigned to identify a number of specific facilities, each having a bit in the parameter field indicating facility requested/facility not requested. In this situation, the parameter field is binary encoded with each bit position relating to a specific facility. A 0 indicates that the facility related to the particular bit is not requested and a 1 indicates that the facility related to the particular bit is requested. Parameter bit positions not assigned to a specific facility are set to zero. If none of the facilities represented by the facility code are requested for a virtual call, the facility code and its associated parameter field need not be present.

In addition to the facility codes defined in this clause, other codes may be used for:

- non-X.25 facilities which may be provided by some network(s) (*call set-up* and *clearing* packets);
- ITU-T-specified DTE facilities as described in Annex G (*call set-up*, *clear request* and *clear indication* packets).

Facility markers, consisting of a single octet pair, are used to separate requests for X.25 facilities as defined in clauses 6 and 7 from other categories as defined above, and, when several categories of facilities are simultaneously present, to separate these categories from each other.

The first octet of the marker is a facility code field and is set to zero. The second octet is a facility parameter field.

The facility parameter field of a marker is set to zero when the marker precedes requests for:

- non-X.25 facilities provided by the network in case of intranetwork calls (*call set-up* and *clearing* packets);
- non-X.25 facilities provided by the network to which the calling DTE is connected, in case of internetwork calls (*call set-up* and *clearing* packets).

The facility parameter field of a marker is set to all ones when the marker precedes requests for non-X.25 facilities provided by the network to which the called DTE is connected, in case of internetwork calls (*call set-up* packets).

The facility parameter field of a marker is set to 00001111 when the marker precedes requests for ITU-T-specified DTE facilities.

All networks will support the facility markers with a facility parameter field set to all ones or to 00001111.

DTEs should not use a facility marker with a facility parameter field set to all ones in case of intranetwork calls. However, if a DTE uses such a marker in an intranetwork call, the DCE is not obliged to clear the call, and the marker, with the corresponding facility requests, may be transmitted to the remote DTE.

Facility codes for X.25 facilities and for the other categories of facilities may be simultaneously present. However, requests for X.25 facilities must precede the other requests, and requests for ITU-T-specified DTE facilities must follow the other requests.

The coding of ITU-T-specified DTE facilities should comply with the description in Annex G. However, the DCE is not required to verify that compliance. If the network verifies that compliance and finds an error, it may clear the call with the cause “invalid facility request”. The ITU-T-specified DTE facilities are passed unchanged by public data networks between the two packet-mode DTEs.

7.2 Coding of the facility code fields

The coding of a facility code field is the same in the various *call set-up* and *clearing* packets in which it is used.

Table 7-2 gives the coding of the facility code fields and the packet types in which they may be present.

NOTE – In a future version of this Recommendation, new facility codes (see clause 7) might be introduced without corresponding subscription-time facilities protecting the DTE from receiving them. However, such a subscription-time facility would be introduced if the new per-call facility would adversely affect the operation at the DTE/DCE interface. As a consequence, DTEs should discard any unrecognized facility codes rather than clear the call.

7.3 Coding of the facility parameter fields

The coding of a facility parameter field is the same in the various *call set-up* and *clearing* packets in which it is used.

7.3.1 Flow control parameter negotiation facility

7.3.1.1 Packet size

The packet size for the direction of transmission from the called DTE is indicated in bits 4, 3, 2 and 1 of the first octet of the facility parameter field. The packet size for the direction of transmission from the calling DTE is indicated in bits 4, 3, 2 and 1 of the second octet. Bits 8, 7, 6 and 5 of each octet must be zero.

TABLE 7-2/X.25
Coding of the facility code field

Facility	Packet types in which it may be used							Facility code bits
	Call request	Incoming call	Call accepted	Call connected	Clear request	Clear indication	DCE clear confirmation	8 7 6 5 4 3 2 1
Flow control parameter negotiation: – packet size – window size – super extended window size	X	X	X	X				0 1 0 0 0 0 1 0 0 1 0 0 0 0 1 1 1 1 0 1 0 1 0 1
Basic throughput class negotiation	X	X	X	X				0 0 0 0 0 0 1 0
Extended throughput class negotiation	X	X	X	X				0 1 0 0 1 1 0 0
Closed user group selection: – basic format – extended format	X	X						0 0 0 0 0 0 1 1 0 1 0 0 0 1 1 1
Closed user group with outgoing access selection: – basic format – extended format	X	X						0 0 0 0 1 0 0 1 0 1 0 0 1 0 0 0
Bilateral closed user group selection	X	X						0 1 0 0 0 0 0 1
Reverse charging	X	X						0 0 0 0 0 0 0 1
Fast select	X	X						(Note 1)
ICRD status selection	X							
NUI selection	X		X (Note 2)					1 1 0 0 0 1 1 0

TABLE 7-2/X.25 (cont.)
Coding of the facility code field

Facility	Packet types in which it may be used							Facility code bits
	Call request	Incoming call	Call accepted	Call connected	Clear request	Clear indication	DCE clear confirmation	8 7 6 5 4 3 2 1
Charging information: – requesting service – receiving information: i) monetary unit ii) segment count iii) call duration	X		X			X	X	0 0 0 0 0 1 0 0 1 1 0 0 0 1 0 1 1 1 0 0 0 0 1 0 1 1 0 0 0 0 0 1
ROA selection: – basic format – extended format	X							0 1 0 0 0 1 0 0 1 1 0 0 0 1 0 0
Call deflection selection					X (Note 4)			1 1 0 1 0 0 0 1
Call redirection or call deflection notification	X (Note 5)	X						1 1 0 0 0 0 1 1
Called line address modified notification			X (Note 3)	X	X (Notes 3 et 4)	X		0 0 0 0 1 0 0 0
Transit delay selection and indication	X	X		X				0 1 0 0 1 0 0 1
Marker (7.1)	X	X	X	X	X	X	X	0 0 0 0 0 0 0 0
Reserved for extension								1 1 1 1 1 1 1 1

TABLE 7-2/X.25 (end)
Coding of the facility code field

NOTES

- 1 This facility code and associated facility parameter will be present in the *incoming call* packet if either or both of *reverse charging* (if reverse charging acceptance is subscribed to) or *fast select* (if *fast select acceptance* is subscribed to) are indicated. They may, but need not, be present if neither *reverse charging acceptance* nor *fast select acceptance* are subscribed to.
- 2 This facility code and associated facility parameter may be present in *call accepted* packet only in conjunction with the *NUI subscription* facility (see 6.21.3).
- 3 Only when the reason “Called DTE originated” is used in the parameter field (see 6.26 and 7.3.12).
- 4 The DTE is not allowed to use both *call deflection selection* and *called line address modified notification* facilities in the same *clear request* packet.
- 5 Only when the reason “Calling DTE originated” is used in the parameter field (see 6.25 and 7.3.11)

The four bits indicating each packet size are binary coded and express the logarithm base 2 of the number of octets of the maximum packet size.

Networks may offer values from 4 to 12, corresponding to packet sizes of 16, 32, 64, 128, 256, 512, 1024, 2048 or 4096, or a contiguous subset of these values. All Administrations will provide a packet size of 128.

7.3.1.2 Window size

The window size for the direction of transmission from the called DTE is indicated in bits 7 to 1 of the first octet of the window size facility parameter field. The window size for the direction of transmission from the calling DTE is indicated in bits 7 to 1 of the second octet. Bit 8 of each octet must be zero.

The bits indicating each window size are binary coded and express the size of the window. A value of zero is not allowed.

Window sizes of 8 to 127 are only valid if extended sequence numbering is used (see 6.2). The ranges of contiguous values allowed by a network for calls with normal numbering and extended numbering are network dependent. All Administrations will provide a window size of 2.

7.3.1.3 Window size for super extended sequence numbering

The window size for the direction of transmission from the called DTE is indicated in bits 8 through 2 of octet 3 and bits 8 through 1 of octet 4 of the super extended window size facility parameter field. Bit 2 of octet 3 is the low order bit and bit 8 of octet 4 is the high order bit. The window size for the direction of transmission from the calling DTE is in bits 8 through 2 of octet 5 and bits 8 through 1 of octet 6 of the super extended window size facility parameter field. Bit 2 of octet 5 is the low order bit and bit 8 of octet 6 is the high order bit. Bit 1 of octet 3 and bit 1 of octet 5 are not used/ignored.

The bits indicating each window size are binary coded and express the size of the window. A value of zero is not allowed.

Octet 2 of the super extended window size facility parameter field is binary coded with a value of four. Bit 1 is the low order bit.

Window sizes of 128 to 32768 are only valid if super extended sequence numbering is used (see 6.2). The ranges of contiguous values allowed by a network for calls with normal numbering and extended numbering are network dependent. All Administrations will provide a window size of 128 when super extended sequence numbering is provided.

7.3.2 Throughput class negotiation facilities

7.3.2.1 Basic throughput class negotiation facility

The throughput class for the direction of data transmission from the called DTE is indicated in bits 8, 7, 6 and 5. The throughput class for the direction of data transmission from the calling DTE is indicated in bits 4, 3, 2 and 1.

The four bits indicating each throughput class are binary coded and correspond to throughput classes as indicated in Table 7-3.

7.3.2.2 Extended throughput class negotiation facility

The throughput class for the direction of data transmission from the calling DTE is indicated in bits 6 to 1 of the first octet of the facility parameter field. The throughput class for the direction of data transmission from the called DTE is indicated in bits 6 to 1 of the second octet. Bits 8 and 7 of each octet must be set to zero and are reserved for future allocation.

The bits indicating each throughput class are binary coded and correspond to throughput classes as indicated in Table 7-4.

NOTE – *Basic throughput class negotiation* and *extended throughput class negotiation* facilities should never be present simultaneously at the DTE/DCE interface.

TABLE 7-3/X.25

Coding of throughput classes in the basic throughput class negotiation facility

Bits: or Bits:	4	3	2	1	Throughput class (bit/s)
	0	0	0	0	Reserved
	0	0	0	1	Reserved
	0	0	1	0	Reserved
	0	0	1	1	75
	0	1	0	0	150
	0	1	0	1	300
	0	1	1	0	600
	0	1	1	1	1 200
	1	0	0	0	2 400
	1	0	0	1	4 800
	1	0	1	0	9 600
	1	0	1	1	19 200
	1	1	0	0	48 000
	1	1	0	1	64 000
	1	1	1	0	128 000
	1	1	1	1	192 000 (Note)

NOTE – See Note 4 in 6.13.

7.3.3 Closed user group selection facility**7.3.3.1 Basic format**

The index to the closed user group selected for the virtual call is in the form of two decimal digits. Each digit is coded in a semi-octet in binary coded decimal with bit 5 being the low order bit of the first digit and bit 1 being the low order bit of the second digit.

Indexes to the same closed user group at different DTE/DCE interfaces may be different.

7.3.3.2 Extended format

The index to the closed user group selected for the virtual call is in the form of four decimal digits. Each digit is coded in a semi-octet in binary coded decimal with bit 5 of the first octet being the low order bit of the first digit, bit 1 of the first octet being the low order bit of the second digit, bit 5 of the second octet being the low order bit of the third digit and bit 1 of the second octet being the low order bit of the fourth digit.

Indexes to the same closed user group at different DTE/DCE interfaces may be different.

7.3.4 Closed user group with outgoing access selection facility**7.3.4.1 Basic format**

The index to the closed user group selected for the virtual call is in the form of two decimal digits. Each digit is coded in a semi-octet in binary coded decimal with bit 5 being the low order bit of the first digit and bit 1 being the low order bit of the second digit.

Indexes to the same closed user group at different DTE/DCE interfaces may be different.

7.3.4.2 Extended format

The index to the closed user group selected for the virtual call is in the form of four decimal digits. Each digit is coded in a semi-octet in binary coded decimal with bit 5 of the first octet being the low order bit of the first digit, bit 1 of the first octet being the low order bit of the second digit, bit 5 of the second octet being the low order bit of the third digit, and bit 1 of the second octet being the low order bit of the fourth digit.

Indexes to the same closed user group at different DTE/DCE interfaces may be different.

TABLE 7-4/X.25

Coding of throughput classes in the extended throughput class negotiation facility

Bits:	8	7	6	5	4	3	2	1	Throughput class (bit/s)
0	0	0	0	0	0	0	0	0	Reserved
0	0	0	0	0	0	0	0	1	Reserved
0	0	0	0	0	0	0	1	0	Reserved
0	0	0	0	0	0	0	1	1	75
0	0	0	0	0	0	1	0	0	150
0	0	0	0	0	0	1	0	1	300
0	0	0	0	0	0	1	1	0	600
0	0	0	0	0	0	1	1	1	1 200
0	0	0	0	0	1	0	0	0	2 400
0	0	0	0	0	1	0	0	1	4 800
0	0	0	0	0	1	0	1	0	9 600
0	0	0	0	0	1	0	1	1	19 200
0	0	0	0	0	1	1	0	0	48 000
0	0	0	0	0	1	1	0	1	64 000
0	0	0	0	0	1	1	1	0	128 000
0	0	0	0	0	1	1	1	1	192 000
0	0	0	0	1	0	0	0	0	256 000
0	0	0	0	1	0	0	0	1	320 000
0	0	0	0	1	0	0	1	0	384 000
0	0	0	0	1	0	0	1	1	448 000
0	0	0	0	1	0	1	0	0	512 000
0	0	0	0	1	0	1	0	1	576 000
0	0	0	0	1	0	1	1	0	640 000
0	0	0	0	1	0	1	1	1	704 000
0	0	0	0	1	1	0	0	0	768 000
0	0	0	0	1	1	0	0	1	832 000
0	0	0	0	1	1	0	1	0	896 000
0	0	0	0	1	1	0	1	1	960 000
0	0	0	0	1	1	1	0	0	1 024 000
0	0	0	0	1	1	1	0	1	1 088 000
0	0	0	0	1	1	1	1	0	1 152 000
0	0	0	0	1	1	1	1	1	1 216 000
0	0	1	0	0	0	0	0	0	1 280 000
0	0	1	0	0	0	0	0	1	1 344 000
0	0	1	0	0	0	0	1	0	1 408 000
0	0	1	0	0	0	0	1	1	1 472 000
0	0	1	0	0	0	1	0	0	1 536 000
0	0	1	0	0	0	1	0	1	1 600 000
0	0	1	0	0	0	1	1	0	1 664 000
0	0	1	0	0	0	1	1	1	1 728 000
0	0	1	0	1	0	0	0	0	1 792 000
0	0	1	0	1	0	0	0	1	1 856 000
0	0	1	0	1	0	1	0	0	1 920 000
0	0	1	0	1	0	1	1	1	1 984 000
0	0	1	0	1	1	1	0	0	2 048 000
Other values									Reserved

7.3.5 Bilateral closed user group selection facility

The index to the bilateral closed user group selected for the virtual call is in the form of 4 decimal digits. Each digit is coded in a semi-octet in binary coded decimal with bit 5 of the first octet being the low order bit of the first digit, bit 1 of the first octet being the low order bit of the second digit, bit 5 of the second octet being the low order bit of the third digit, and bit 1 of the second octet being the low order bit of the fourth digit.

Indexes to the same bilateral closed user group at different DTE/DCE interfaces may be different.

7.3.6 Reverse charging, fast select, and ICRD status selection facilities

The coding of the facility parameter field is:

- Bit 1 = 0 for reverse charging not requested;
- Bit 1 = 1 for reverse charging requested;
- Bit 5 = 0 and bit 6 = 0 for ICRD status not selected (i.e. ICRD is allowed unless *ICRD prevention subscription* facility is subscribed);
- Bit 5 = 0 and bit 6 = 1 for ICRD prevention requested;
- Bit 5 = 1 and bit 6 = 0 for ICRD allowance requested;
- Bit 5 = 1 and bit 6 = 1 not allowed;
- Bit 8 = 0 and bit 7 = 0 or 1 for fast select not requested;
- Bit 8 = 1 and bit 7 = 0 for fast select requested with no restriction on response;
- Bit 8 = 1 and bit 7 = 1 for fast select requested with restriction on response.

NOTE – Bits 4, 3 and 2 may be assigned to other facilities in the future; presently, they are set to 0.

7.3.7 NUI selection facility

The octet following the facility code field indicates the length, in octets, of the facility parameter field. The following octets contain the network user identifier, in a format determined by the Administration. A possible format for the network user identifier is given in Appendix VI.

7.3.8 Charging information facility

7.3.8.1 Parameter field for requesting service

The coding of the facility parameter field is:

- Bit 1 = 0 for charging information not requested;
- Bit 1 = 1 for charging information requested.

NOTE – Bits 8, 7, 6, 5, 4, 3 and 2 may be assigned to other facilities in the future; presently, they are set to 0.

7.3.8.2 Parameter field indicating monetary unit

The octet following the facility code field indicates the length, in octets, of the facility parameter field.

The parameter field indicates the charging. The coding of the parameter is for further study.

7.3.8.3 Parameter field indicating segment count

The octet following the facility code field indicates the length, in octets, of the facility parameter field and has the value $n \times 8$ where n is the number of different tariff periods managed by the network.

For each tariff period, the first four octets of the facility parameter field indicate the number of segments sent to the DTE. The following four octets indicate the number of segments received from the DTE.

Each digit is coded in a semi-octet in binary coded decimal and bit 1 or bit 5 of each semi-octet is the low order bit of each digit and bits 4 to 1 of the last octet represent the lowest order digit of the segment count.

Segment size and the specific packet types to be counted are a matter of the Administration in the case of national calls and are specified in Recommendation D.12 for international calls.

NOTE – The relationship between a particular tariff period and its place in the parameter field is a national matter. The order is given by each Administration.

7.3.8.4 Parameter field indicating call duration

The octet following the facility code field indicates the length, in octets, of the facility parameter field and has the value $n \times 4$ where n is the number of different tariff periods managed by the network.

For each tariff period, the first octet of the facility parameter field indicates number of days, the second indicates number of hours, the third indicates number of minutes and the fourth indicates number of seconds. Each digit is coded in a semi-octet in binary coded decimal and bit 1 or bit 5 of each semi-octet is the low order bit of each digit. Bits 4 to 1 of each octet represent the low order digit.

NOTE – The relationship between a particular tariff period and its place in the parameter field is a national matter. The order is given by each Administration.

7.3.9 ROA selection facility

7.3.9.1 Basic format

The parameter field contains the data network identification code for the requested initial ROA transit network and is in the form of four decimal digits.

Each digit is coded in a semi-octet in binary coded decimal with bit 5 of the first octet being the low order bit of the first digit, bit 1 of the first octet being the low order bit of the second digit, bit 5 of the second octet being the low order bit of the third digit, and bit 1 of the second octet being the low order bit of the fourth digit.

7.3.9.2 Extended format

The octet following the facility code field indicates the length, in octets, of the facility parameter field and has the value $n \times 2$, where n is the number of ROA transit networks selected.

Each ROA transit network is indicated by a data network identification code, and is in the form of four decimal digits. Each digit is coded in a semi-octet in binary coded decimal with bit 5 of the first octet being the low order bit of the first digit, bit 1 of the first octet being the low order bit of the second digit, bit 5 of the second octet being the low order bit of the third digit, and bit 1 of the second octet being the low order of the fourth digit.

ROA transit network should appear in the facility parameter field in the order that the calling DTE wishes them to be traversed.

7.3.10 Call deflection selection facility

The octet following the facility code indicates the length, in octets, of the facility parameter field and has the value $n + 2$, where n is the number of octets necessary to hold the called address of the DTE to which the call is to be deflected (the alternate DTE).

The first octet of the facility parameter field indicates the reason for the DTE deflecting the call. The coding of this octet is:

bits	8	7	6	5	4	3	2	1
or	1	1	X	X	X	X	X	X

NOTE – Each X may be independently set to 0 or 1 by the called DTE and is passed transparently to the DTE to which the call is deflected. If bits 8 and 7 are not set to 1 by the called DTE, they are forced to this value by the DCE.

The second octet indicates the number of semi-octets in the alternate DTE address. This address length indicator is binary coded and bit 1 is the low order bit. Its value is limited to 15 when the A bit is set to 0 (see 5.2.1). When the A bit is set to 1, there is no restriction on the length.

The following octets contain the alternate DTE address, using coding which corresponds to the coding of the called DTE address field in the address block (see 5.2.1). When the number of semi-octets of the alternate DTE address is odd, a semi-octet with zeros in bits 4, 3, 2 and 1 will be inserted after the last semi-octet in order to maintain octet alignment.

7.3.11 Call redirection or call deflection notification facility

The octet following the facility code field indicates the length, in octets, of the facility parameter field and has the value $n + 2$, where n is the number of octets necessary to hold the originally called DTE address.

The first octet of the facility parameter field indicates the reason for the call redirection or call deflection. The coding of this octet is given in Table 7-5.

The second octet indicates the number of semi-octets in the originally called DTE address. This address length indicator is binary coded and bit 1 is the low order bit. Its value is limited to 15 when the A bit is set to 0 (see 5.2.1), to 17 when the A bit is set to 1.

The following octets contain the originally called DTE address. When both the calling DTE and the alternate DTE have subscribed to the *TOA/NPI address subscription* facility (see 6.1), or when none of them has subscribed to this facility, the originally called DTE address is coded identically to the called DTE address field in the *call request* packet. When these conditions are not satisfied, the network converts from one address format to the other (see 5.2.1). When the number of semi-octets of the originally added DTE address is odd, a semi-octet with zeros in bits 4, 3, 2 and 1 will be inserted after the last semi-octet in order to maintain octet alignment.

TABLE 7-5/X.25

Coding of the reason in the call redirection or call deflection notification facility parameter field

	Bits							
	8	7	6	5	4	3	2	1
Originally called DTE busy	0	0	0	0	0	0	0	1
Call distribution within a hunt group ^{a)}	0	0	0	0	0	1	1	1
Originally called DTE out of order	0	0	0	0	1	0	0	1
Systematic call redirection	0	0	0	0	1	1	1	1
Calling DTE originated ^{b)}	1	0	X	X	X	X	X	X
Call deflection by the originally called DTE ^{c)}	1	1	X	X	X	X	X	X

a) This value may be used by some networks for network-dependent reasons not described in this Recommendation.

b) This reason may be used in a *call request* packet to indicate a call redirection or a call deflection in the calling DTE (which is supposed to be a packet switched private data network); if bits 8 and 7 are not set to 1 and 0 respectively, they are forced to these values by the DCE; each X may be independently set to 0 or 1 by the calling DTE. As a result, this reason may also be used in the *incoming call* packet, the Xs being passed transparently from the calling DTE.

c) The Xs are those set by the originally called DTE in the *call deflection selection* facility (see 7.3.10).

TABLE 7-6/X.25

Coding of parameter field for called line address modified notification facility

	Bits							
	8	7	6	5	4	3	2	1
Call redirection due to originally called DTE busy	0	0	0	0	0	0	0	1
Call distribution within a hunt group	0	0	0	0	0	1	1	1
Call redirection due to originally called DTE out of order	0	0	0	0	1	0	0	1
Call redirection due to prior request from originally called DTE for systematic call redirection	0	0	0	0	1	1	1	1
Calling DTE originated ^{a)}	1	0	X	X	X	X	X	X
Call deflection by the originally called DTE ^{b)}	1	1	X	X	X	X	X	X

a) Each X may be independently set to 0 or 1 by the called DTE and is passed transparently to the calling DTE. However, bits 8 and 7, when they are not set to 1 and 0 respectively, are forced to these values by the DCE.

b) The Xs are those set by the originally called DTE in the *call deflection selection* facility (see 7.3.10).

7.3.12 Called line address modified notification facility

The coding of the facility parameter field for *called line address modified notification* is given in Table 7-6.

7.3.13 Transit delay selection and indication facility

This parameter is of two octets. Transit delay is expressed in milliseconds, binary coded, with bit 8 of octet 1 being the high order bit and bit 1 of octet 2 being the low order bit. The expressed transit delay may have a value from 0 to 65 534 (all bits set to 1 but the low order bit).

NOTE – During the interim period when this optional user facility is not yet supported by all networks, the transit delay indicated in the *call connected* packet transmitted to the calling DTE should have a value of 65 535 (all ones) when either a transit network involved in the virtual call or the destination network does not support this facility. So, this value should be interpreted by the calling DTE as an indication that the actual transit delay cannot be transmitted to it.

Annex A

Range of logical channels used for virtual calls and permanent virtual circuits

(This annex forms an integral part of this Recommendation)

In the case of a single logical channel DTE, logical channel 1 will be used.

For each multiple logical channel DTE/DCE interface, a range of logical channels will be agreed upon with the Administration according to Figure A.1.

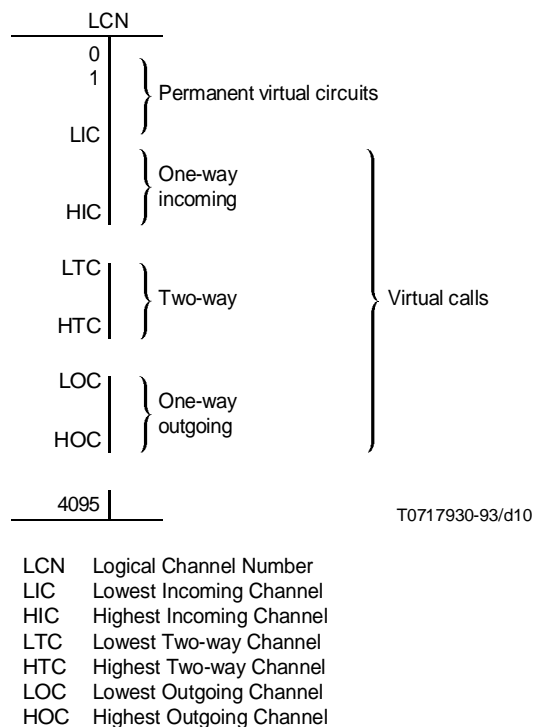

Annex B

Packet layer DTE/DCE interface state diagrams

(This annex forms an integral part of this Recommendation)

B.1 Symbol definition of the state diagrams

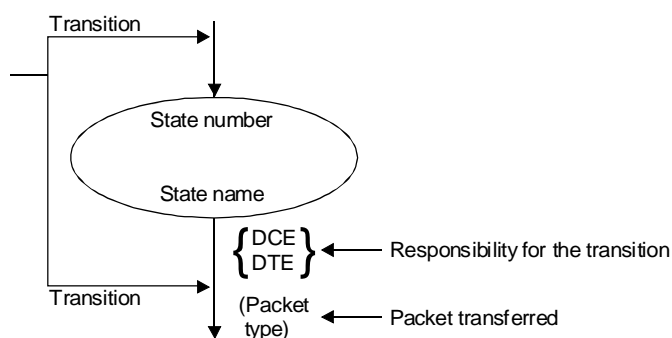

T0717940-93/d11

NOTES

- 1 Each state is represented by an ellipse wherein the state name and number are indicated.
- 2 Each state transition is represented by an arrow. The responsibility for the transition (DTE or DCE) and the packet that has been transferred is indicated beside that arrow.

B.2 Order definition of the state diagrams

For the sake of clarity, the normal procedure at the interface is described in a number of small state diagrams. In order to describe the normal procedure fully, it is necessary to allocate a priority to the different figures and to relate a higher order diagram with a lower one. This has been done by the following means:

- The figures are arranged in order of priority with Figure B.1 (restart) having the highest priority and subsequent figures (Figures B.2 and B.3) having lower priority. Priority means that when a packet belonging to a higher order diagram is transferred, that diagram is applicable and the lower order one is not.
- The relation with a state in a lower order diagram is given by including that state inside an ellipse in the higher order diagram.

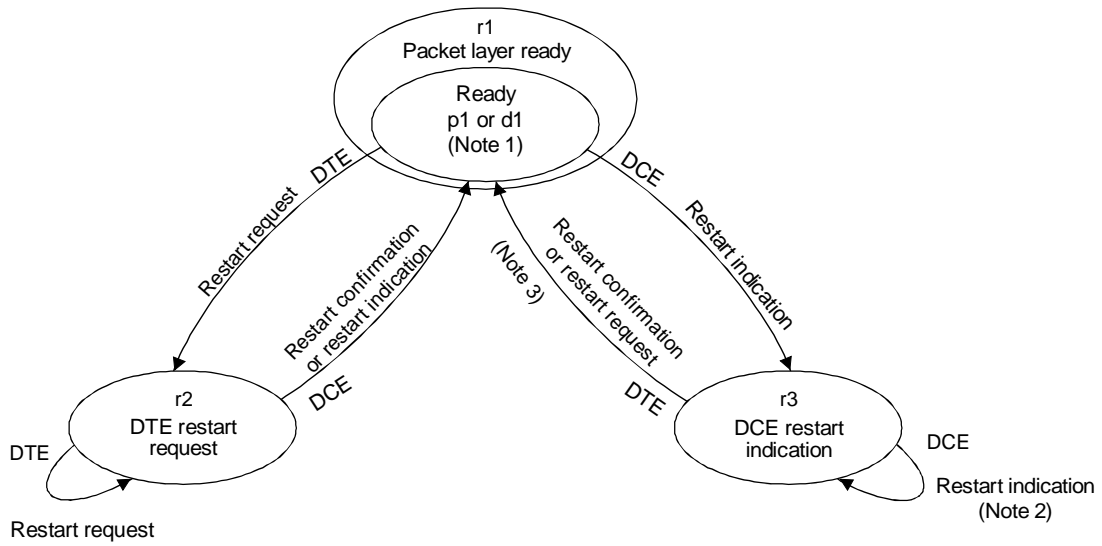

T0717950-93/d12

NOTES

- 1 State p1 for virtual calls or state d1 for permanent virtual circuits.
- 2 This transition takes place after time-out T10 expires the first time.
- 3 This transition also takes place after time-out T10 expires the second time (without transmission of any packet, except, possibly, a diagnostic packet).

FIGURE B.1/X.25
Diagram of states for the transfer of restart packets

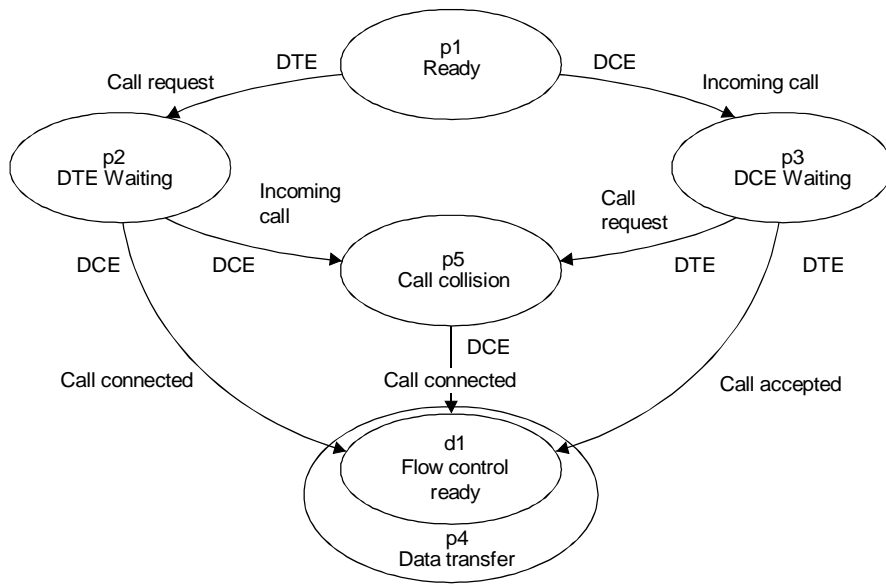

a) Call set-up phase

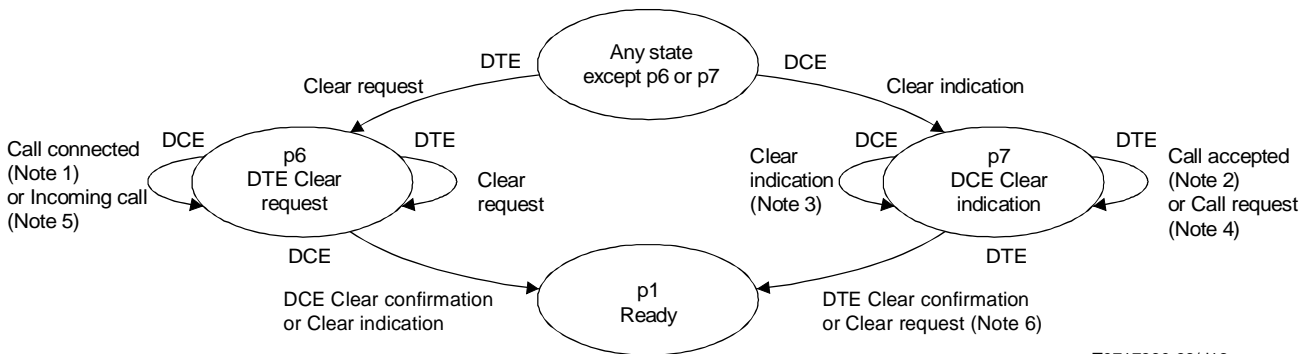

T0717960-93/d13

b) Call clearing phase

NOTES

- 1 This transition is possible only if the previous state was *DTE Waiting* (p2).
- 2 This transition is possible only if the previous state was *DCE Waiting* (p3).
- 3 This transition takes place after time-out T13 expires the first time.
- 4 This transition is possible only if the previous state was *Ready* (p1) or *DCE Waiting* (p3).
- 5 This transition is possible only if the previous state was *Ready* (p1) or *DTE Waiting* (p2).
- 6 This transition also takes place after time-out T13 expires the second time (without transmission of any packet, except, possibly, a diagnostic packet).

FIGURE B.2/X.25
Diagram of states for the transfer of call set-up and call clearing packets within the packet level ready (r1) state

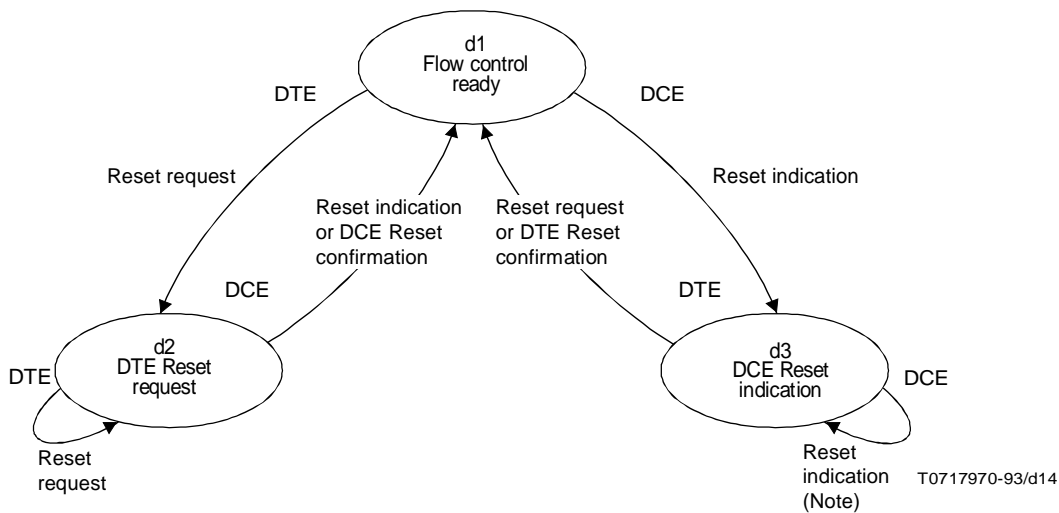

NOTE – This transition takes place after time-out T12 expires the first time.

FIGURE B.3/X.25

Diagram of states for the transfer of reset packets within the data transfer (p4) state

Annex C

Actions taken by the DCE on receipt of packets in a given state of the packet layer DTE/DCE interface as perceived by the DCE

(This annex forms an integral part of this Recommendation)

Introduction

This annex specifies the actions taken by the DCE on receipt of packets in a given state of the packet layer DTE/DCE interface as perceived by the DCE.

It is presented as a succession of chained tables.

The following rules are valid for all these tables:

- 1) There may be more than one error associated with a packet. The network will stop normal processing of a packet when an error is encountered. Thus only one diagnostic code is associated with an error indication by the DCE. The order of packet decoding and checking on networks is not standardized.
- 2) For those networks which are octet aligned, the detection of a non-integral number of octets may be made at the data link or packet layer. In this annex, only those networks which are octet aligned and detect the non-integral number of octets at the packet layer are concerned with the considerations about octet alignment.
- 3) In each table, the actions taken by the DCE are indicated in the following way:
 - DISCARD: The DCE discards the received packet and takes no subsequent action as a direct result of receiving that packet; the DCE remains in the same state.
 - DIAG # x: The DCE discards the received packet and, for networks which implement the *diagnostic* packet, transmits to the DTE a *diagnostic* packet containing the diagnostic # x. The state of the interface is not changed.
 - NORMAL or ERROR: The corresponding action is specified after each table.
- 4) Annex E gives a list of the diagnostic codes which may be used.

TABLE C.1/X.25

Special cases

Packet from DTE	Any state
Any packet with packet length shorter than 2 octets, or 3 octets when <i>super extended packet sequence numbering</i> facility is subscribed to, including data link layer valid I-frame containing no packet	DIAG # 38
Any packet with invalid general format identifier (GFI) or invalid protocol identifier	DIAG # 40
Any packet with unassigned logical channel	DIAG # 36
Any packet having a correct protocol identifier (when applicable), a correct GFI and either an assigned logical channel, or bits 4 through 1 of the octet containing the GFI and bits 8 through 1 of the following octet equal to 0	(see Table C.2)

TABLE C.2/X.25

Action taken by the DCE on receipt of packets in a given state of the packet layer DTE/DCE interface as perceived by the DCE: Restart procedure

State of the interface as perceived by the DCE	Packet layer ready r1	DTE restart request r2	DCE restart indication r3
Packet from the DTE			
Restart request with bits 1 to 4 of the octet containing the GFI and bits 1 to 8 of the following octet equal to zero	NORMAL (r2)	DISCARD	NORMAL (r1)
DTE restart confirmation with bits 1 to 4 of the octet containing the GFI and bits 1 to 8 of the following octet equal to zero	ERROR (r3) # 17	ERROR (r3) # 18	NORMAL (r1)
Packet supported by the DCE other than restart request or DTE restart confirmation with bits 1 to 4 of the octet containing the GFI and bits 1 to 8 of the following octet equal to zero	DIAG # 36	DIAG # 36	DIAG # 36
Packet having a packet type identifier which is shorter than 1 octet, with bits 1 to 4 of the octet containing the GFI and bits 1 to 8 of the following octet equal to zero	DIAG # 38	ERROR (r3) # 38	DISCARD
Packet having a packet type identifier which is undefined or not supported by the DCE (i.e. reject packet), with bits 1 to 4 of the octet containing the GFI and bits 1 to 8 of the following octet equal to zero	DIAG # 33	ERROR (r3) # 33	DISCARD
Data, interrupt, call set-up and clearing, flow control or reset, with assigned logical channel	See Table C.3 or C.4 (Note)	ERROR (r3) # 18	DISCARD
Restart request or DTE restart confirmation with bits 1 to 4 of octet 1 or bits 1 to 8 of octet 2 unequal to zero	See Table C.3 or C.4 (Note)	ERROR (r3) # 41	DISCARD
Packet having a packet type identifier which is shorter than 1 octet, with assigned logical channel	See Table C.3 or C.4 (Note)	ERROR (r3) # 38	DISCARD
Packet having a packet type identifier which is undefined or not supported by the DCE (i.e. reject packet), with assigned logical channel	See Table C.3 or C.4 (Note)	ERROR (r3) # 33	DISCARD
<p>ERROR (r3) # x: The DCE discards the received packet, indicates a restarting by transmitting to the DTE a <i>restart indication</i> packet, with the cause "Local procedure error" and the diagnostic # x, and enters state r3. If connected through a virtual call, the distant DTE is also informed of the restarting by a <i>clear indication</i> packet, with the cause "Remote procedure error" (same diagnostic). In the case of a permanent virtual circuit, the distant DTE will be informed by a <i>reset indication</i> packet, with the cause "Remote procedure error" (same diagnostic).</p> <p>NORMAL (r1): Provided none of the following error conditions has occurred, the action taken by the DCE follows the procedure as defined in clause 3 and 6.1 and DTE/DCE interface enters state r1:</p> <p>a) If a <i>restart request</i> packet or <i>DTE restart confirmation</i> packet received in state r3 exceeds the maximum permitted length, is too short or is not octet aligned (see rule 2 in the introduction of this annex), the DCE will invoke the ERROR # 39, # 38 or # 82 procedure, respectively.</p> <p>Some networks may invoke the ERROR # 81 procedure if the restarting cause field is not "DTE originated" in the <i>restart request</i> packet received in state r3.</p> <p>b) If a <i>restart request</i> packet received in state r1 exceeds the maximum permitted length, is too short or is not octet aligned (see rule 2 in the introduction of this annex), the DCE shall invoke the DIAG # 39, # 38 or # 82 procedure, respectively.</p> <p>Some networks may invoke the DIAG # 81 procedure if the restarting cause field is not "DTE originated" in the <i>restart request</i> packet received in state r1.</p> <p>NOTE – Table C.3 for logical channels assigned to virtual calls; Table C.4 for logical channels assigned to permanent virtual circuits.</p>			

TABLE C.3/X.25

Action taken by the DCE on receipt of packets in a given state of the packet layer DTE/DCE interface as perceived by the DCE: Call set-up and clearing on logical channel assigned to virtual call (Note 1)

State of the interface as perceived by the DCE Packet from the DTE with logical channel assigned to virtual call	Packet layer ready r1						
	Ready p1	DTE waiting p2 (Note 3)	DCE waiting p3 (Note 2)	Data transfer p4	Call collision p5 (Notes 2 and 3)	DTE clear request p6	DCE clear indication p7
Call request	NORMAL (p2)	ERROR (p7) # 21	NORMAL (p5)	ERROR (p7) # 23	ERROR (p7) # 24	ERROR (p7) # 25	DISCARD
Call accepted	ERROR (p7) # 20	ERROR (p7) # 21	NORMAL (p4)	ERROR (p7) # 23	ERROR (p7) # 24	ERROR (p7) # 25	DISCARD
Clear request	NORMAL (p6)	NORMAL (p6)	NORMAL (p6)	NORMAL (p6)	NORMAL (p6)	DISCARD	NORMAL (p1)
DTE clear confirmation	ERROR (p7) # 20	ERROR (p7) # 21	ERROR (p7) # 22	ERROR (p7) # 23	ERROR (p7) # 24	ERROR (p7) # 25	NORMAL (p1)
Data, interrupt, reset or flow control	ERROR (p7) # 20	ERROR (p7) # 21	ERROR (p7) # 22	(See Table C.4)	ERROR (p7) # 24	ERROR (p7) # 25	DISCARD
Restart request or DTE restart confirmation with bits 1 to 4 of the octet containing the GFI or bits 1 to 8 of the following octet unequal to zero	ERROR (p7) # 41	ERROR (p7) # 41	ERROR (p7) # 41	(See Table C.4)	ERROR (p7) # 41	ERROR (p7) # 41	DISCARD
Packets having a packet type identifier which is shorter than one octet	ERROR (p7) # 38	ERROR (p7) # 38	ERROR (p7) # 38	(See Table C.4)	ERROR (p7) # 38	ERROR (p7) # 38	DISCARD
Packet having a packet type identifier which is undefined or not supported by the DCE (i.e. <i>reject</i> packet)	ERROR (p7) # 33	ERROR (p7) # 33	ERROR (p7) # 33	(See Table C.4)	ERROR (p7) # 33	ERROR (p7) # 33	DISCARD
<p>ERROR (p7) # x: The DCE discards the received packet, indicates a clearing by transmitting to the DTE a <i>clear indication</i> packet, with the cause "Local procedure error" and the diagnostic # x, and enters state p7. If connected through a virtual call, the distant DTE is also informed of the clearing by a <i>clear indication</i> packet, with the cause "Remote procedure error" (same diagnostic).</p> <p>NORMAL (p1): Provided none of the following error conditions has occurred, the action taken by the DCE follows the procedures as defined in clause 4 and the DTE/DCE interface enters state p1. In all the cases specified hereunder, the DCE will transmit to the DTE a <i>clear indication</i> with the appropriate cause and diagnostic, and enter state p7. If connected through a virtual call, the distant DTE is also informed of the clearing by a <i>clear indication</i> packet with the same diagnostic: when the cause transmitted to the local DTE is "Incompatible destination" or "Network congestion", the same cause is to be used in the <i>clear indication</i> packet transmitted to the distant DTE; in the other cases, the cause to be used in the <i>clear indication</i> packet transmitted to the distant DTE is "Remote procedure error".</p> <p>NOTES</p> <p>1 On permanent virtual circuit, only state p4 exists and the DCE takes no action except those specified in Table C.4.</p> <p>2 This state does not exist in the case of an outgoing one-way logical channel (as perceived by the DTE).</p> <p>3 This state does not exist in the case of an incoming one-way logical channel (as perceived by the DTE).</p>							

a) **Call request packet**

Error condition		Cause	Specific diagnostics (Note 3 of Table E.1)
1.	Packet not octet aligned (see rule 2 in the introduction of this annex)	Local procedure error	# 82
2.	Packet too short	Local procedure error	# 38
3.	Incoming one-way logical channel (as perceived by the DTE)	Local procedure error	# 34
4.	Address length larger than remainder of packet	Local procedure error	# 38
5.	Address contains a non-BCD digit	Local procedure error	# 67, # 68
6.	Invalid calling DTE address (Note 1)	Local procedure error	# 68
7.	Invalid called DTE address (Note 1)	Local procedure error or not obtainable	# 67
8.	Packet exceeds 259 octets (260 if the <i>super extended packet sequence numbering</i> facility is subscribed to)	Local procedure error	# 39
9.	No combination of facilities could equal facility length	Local procedure error	# 69
10.	Facility length larger than remainder of packet	Local procedure error	# 38
11.	Facility code not allowed	Invalid facility request	# 65
12.	Facility value not allowed or invalid	Invalid facility request	# 66
13.	Class coding of the facility corresponding to a length of parameter larger than remainder of packet	Local procedure error	# 69
14.	Facility code repeated	Local procedure error	# 73
15.	Invalid network user identifier	Invalid facility request	# 84
16.	<i>NUI selection</i> facility expected by the DCE and not provided by the DTE	Local procedure error	# 84
17.	Invalid/unsupported NUI value or missing NUI detected at inter-network interface	Access barred	# 84
18.	ROA selection required	ROA out of order	# 76
19.	Facility values conflicts (e.g. a particular combination not supported)	Invalid facility request	# 66
20.	ITU-T specified DTE facility code or parameter not allowed or invalid	Invalid facility request	# 77
21.	Call user data larger than 16, or 128 in case of <i>fast select</i> facility	Local procedure error	# 39
If the virtual call cannot be established by the network, the DCE should use a <i>call progress</i> signal and diagnostic code among the following:			
22.	Requested ROA out of order	ROA out of order	# 0
23.	Requested ROA invalid or not supported	ROA out of order	# 119
24.	Unknown number	Not obtainable	# 67
25.	Incoming call barred	Access barred	# 70
26.	Closed user group protection	Access barred	# 65
27.	Ship absent	Ship absent	# 0
28.	Reverse charging rejected	Reverse charging acceptance not subscribed	# 0

Error condition		Cause	Specific diagnostics (Note 3 of Table E.1)
29.	Fast select rejected	Fast select acceptance not subscribed	# 0
30.	Called DTE out of order	Out of order	# 0 # greater than 127
31.	No logical channel available	Number busy	# 71
32.	Call collision	Number busy	# 71, # 72
33.	The remote DTE/DCE interface or the transit network does not support a function or a facility requested (Note 2)	Incompatible destination	# 0
34.	Procedure error at the remote DTE/DCE interface	Remote procedure error	[see b) and c) below and Annex D]
35.	<i>Incoming call</i> packet being constructed by the DCE at the remote DTE/DCE interface exceeds 259 octets (260 if the <i>super extended packet sequence numbering</i> facility is subscribed to)	Incompatible destination	# 39
36.	Temporary network congestion or fault condition within the network	Network congestion	# 0, # 122 or # greater than 127
37.	ICRD supported by the calling network, requested by the originally called DTE, but prevented by the calling DTE	Access barred	# 85
38.	ICRD not supported by the calling network and requested by the originally called DTE	Incompatible destination	# 85
39.	TOA/NPI address subscription is not subscribed to by the called DTE while needed to transmit an address (see Note 3 of 5.2.1)	Incompatible destination	# 46

NOTES

1 Possible reasons for invalid address are:

- Prefix digit not supported;
- Invalid type of address/numbering plan identification informations (A bit set to 1);
- inability to translate alternative address;
- National address smaller than permitted by the national address format;
- National address larger than permitted by the national address format;
- DNIC less than four digits, etc.

2 Precise definition of error condition 33 necessitates further study, and should take into account the possible non-support of the virtual call service (only permanent virtual circuit) by the destination DTE.

b) Call accepted packet

Error condition		Cause	Specific diagnostics (Note 3 of Table E.1)
1.	Packet not octet aligned (see rule 2 in the introduction of this annex)	Local procedure error	# 82
2.	Address length larger than remainder of packet	Local procedure error	# 38
3.	Address contains a non-BCD digit	Local procedure error	# 67, # 68
4.	Invalid calling DTE address [Note 1 under a)]	Local procedure error	# 68
5.	Invalid called DTE address [Note 1 under a)]	Local procedure error	# 67
6.	Packet exceeds 259 octets (260 if the <i>super extended packet sequence numbering</i> facility is subscribed to)	Local procedure error	# 39
7.	No combination of facilities could equal facility length	Local procedure error	# 69
8.	Facility length larger than remainder of packet	Local procedure error	# 38
9.	Facility code not allowed	Invalid facility request	# 65
10.	Facility value not allowed or invalid	Invalid facility request	# 66
11.	Class coding of the facility corresponding to a length of parameter field larger than remainder of packet	Local procedure error	# 69
12.	Facility code repeated	Local procedure error	# 73
13.	Invalid network user identifier	Invalid facility request	# 84
14.	<i>NUI selection</i> facility expected by the DCE and not provided by the DTE	Local procedure error	# 84
15.	Invalid/unsupported NUI value or missing NUI detected at inter-network interface	Access barred	# 84
16.	Facility value conflict (e.g. a particular combination not supported)	Invalid facility request	# 66
17.	ITU-T specified DTE facility code or parameter not allowed or invalid	Invalid facility request	# 77
18.	Call user data larger than 128 (if <i>fast select</i> facility requested)	Local procedure error	# 39
19.	Call user data present (if <i>fast select</i> facility not requested)	Local procedure error	# 39
20.	The <i>incoming call</i> packet indicated fast select with restriction on response	Local procedure error	# 42
21.	<i>Call connected</i> packet being constructed by the DCE at the calling DTE/DCE interface exceeds 259 octets (260 if the <i>super extended packet sequence numbering</i> facility is subscribed to)	Incompatible destination	# 39
22.	TOA/NPI address subscription is not subscribed to by the calling DTE while needed to transmit an address (see Note 3 of 5.2.1)	Incompatible destination	# 46

Some networks may invoke the ERROR # 74 procedure if the calling and/or called DTE address length fields are not equal to 0 in the *call accepted* packet, except when the *called line address modified notification* facility is present in the facility field.

c) **Clear request packet**

Error condition		Cause	Specific diagnostics (Note 3 of Table E.1)
1.	Packet not octet aligned (see rule 2 in the introduction of this annex)	Local procedure error	# 82
2.	Packet too short	Local procedure error	# 38
3.	Packet length incorrectly larger than 5 octets for modulo 8 or 128 operation, or incorrectly larger than 6 octets for modulo 32 768 operation	Local procedure error	# 39
4.	Calling DTE address length field not set to zero (at any time); called DTE address length field not set to zero except when the <i>called line address modified notification</i> facility is present in clearing a call in state p3	Local procedure error	# 74
5.	Invalid called DTE address when the <i>called line address modified notification</i> facility is present in clearing a call in state p3 [Note 1 under a)]	Local procedure error	# 67
6.	Packet exceeds 259 octets (260 if the <i>super extended packet sequence numbering</i> facility is subscribed to)	Local procedure error	# 39
7.	No combination of facilities could equal facility length	Local procedure error	# 69
8.	Facility length larger than remainder of packet	Local procedure error	# 38
9.	Facility code not allowed	Invalid facility request	# 65
10.	Facility value not allowed or invalid (including inter-network call deflection, when not supported by the network of the deflecting DTE)	Invalid facility request	# 66
11.	Class coding of the facility corresponding to a parameter field length larger than remainder of packet	Local procedure error	# 69
12.	Facility code repeated	Local procedure error	# 73
13.	<i>Call deflection selection</i> facility requested when the maximum number of call redirections and call deflections is reached	Invalid facility request	# 78
14.	<i>Call deflection selection</i> facility requested after timer expiration	Invalid facility request	# 53
15.	Clear user data larger than 128 (if <i>fast select</i> facility requested)	Local procedure error	# 39
16.	Clear user data present (if <i>fast select</i> facility and <i>call deflection selection</i> facility not requested)	Local procedure error	# 39
17.	Clear user data larger than 16 (if <i>fast select</i> facility not requested and <i>call deflection selection</i> facility requested)	Local procedure error	# 39
18.	<i>Clear indication</i> packet being constructed by the DCE at the remote DCE/DTE exceeds 259 octets (260 if the <i>super extended packet sequence numbering</i> facility is subscribed to)	Incompatible destination	# 39

Some networks may invoke the ERROR # 81 procedure if the clearing cause field is not "DTE originated" in the *clear request* packet.

d) DTE clear confirmation packet

Error condition		Cause	Specific diagnostics (Note 3 of Table E.1)
1.	Packet not octet aligned (see rule 2 in the introduction of this Annex)	Local procedure error	# 82
2.	Packet length greater than 3 octets for modulo 8 or 128 operation, or greater than 4 octets for modulo 32 768 operation	Local procedure error	# 39

TABLE C.4/X.25

Action taken by the DCE on receipt of packets in a given state of the packet layer DTE/DCE interface as perceived by the DCE: data transfer (flow control and reset) on assigned logical channels

State of the interface as perceived by the DCE	Data transfer (p4)		
	Flow control ready (d1)	DTE reset request (d2)	DCE reset indication (d3)
Packet from the DTE with assigned logical channel			
Reset request	NORMAL (d2)	DISCARD	NORMAL (d1)
DTE reset confirmation	ERROR (d3) # 27	ERROR (d3) # 28	NORMAL (d1)
Data, interrupt or flow control	NORMAL (d1)	ERROR (d3) # 28	DISCARD
Restart request or DTE restart confirmation with bits 1 to 4 of the octet containing the GFI or bits 1 to 8 of the following octet unequal to zero	ERROR (d3) # 41	ERROR (d3) # 41	DISCARD
Packet having a packet type identifier which is shorter than 1 octet	ERROR (d3) # 38	ERROR (d3) # 38	DISCARD
Packet having a packet type identifier which is undefined or not supported by the DCE (i.e. <i>reject</i> packet)	ERROR (d3) # 33	ERROR (d3) # 33	DISCARD
Invalid packet type on a permanent virtual circuit	ERROR (d3) # 35	ERROR (d3) # 35	DISCARD
<i>Reject</i> packet not subscribed	ERROR (d3) # 37	ERROR (d3) # 37	DISCARD
<p>ERROR (d3) # x: The DCE DISCARDS the received packet, indicates a reset by transmitting to the DTE a <i>reset indication</i> packet, with the cause "Local procedure error" and the diagnostic # x, and enters state d3. The distant DTE is also informed of the reset by a <i>reset indication</i> packet, with the cause "Remote procedure error" (same diagnostic).</p> <p>NORMAL (d1): Provided none of the following error conditions or special situations has occurred, the actions taken by the DCE follows the procedure as defined in clause 4:</p> <ul style="list-style-type: none"> a) if the packet exceeds the maximum permitted length, is too short, is not octet aligned (see rule 2 in the introduction of this annex), the DCE will invoke the ERROR # 39, # 38 or # 82 procedure, respectively; b) some networks may invoke the ERROR # 81 procedure if the resetting cause field in a <i>reset request</i> packet does not have the value "DTE originated"; c) some networks may invoke the ERROR # 83 procedure if the Q bit is not set to the same value within a complete packet sequence; d) if the P(S) or the P(R) received is not valid, the DCE will invoke the ERROR # 1 or # 2 procedure respectively; e) the DCE will consider the receipt of a <i>DTE interrupt confirmation</i> packet which does not correspond to a yet unconfirmed <i>DCE interrupt</i> packet as an error and will invoke the ERROR # 43 procedure. The DCE will consider a <i>DTE interrupt</i> packet received before a previous <i>DTE interrupt</i> packet has been confirmed as an error, and will invoke the ERROR # 44 procedure; f) if the network has a temporary inability to handle data traffic for a permanent virtual circuit (see 4.2), and if the packet is a <i>data</i>, <i>interrupt</i>, <i>flow control</i> or <i>reset request</i> packet received in state d1, the DCE shall transmit to the DTE a <i>reset indication</i> packet with the cause "Network out of order" and enter state d3 (<i>data</i>, <i>interrupt</i> or <i>flow control</i> packet) or d1 (<i>reset request</i> packet); g) if a network or part of the international network not supporting the D-bit procedure receives a data packet with D bit set to 1, it will reset the virtual call or permanent virtual circuit with cause "Incompatible destination" and diagnostic # 40. 			

Annex D

Packet layer DCE time-outs and DTE time-limits

(This annex forms an integral part of this Recommendation)

D.1 DCE time-outs

Under certain circumstances this Recommendation requires the DTE to respond to a packet issued from the DCE within a stated maximum time.

Table D.1 covers these circumstances and the actions that the DCE will initiate upon the expiration of that time.

The time-out values used by the DCE will never be less than those indicated in Table D.1.

D.2 DTE time-limits

Under certain circumstances, this Recommendation requires the DCE to respond to a packet from the DTE within a stated maximum time. Table D.2 gives these maximum times. The actual DCE response times should be well within the specified time-limits. The rare situation where a time-limit is exceeded should only occur when there is a fault condition.

To facilitate recovery from such fault conditions, the DTE may incorporate timers. The time-limits given in Table D.2 are the lower limits of the times a DTE should allow for proper operation. A time-limit longer than the values shown may be used. Suggestions on possible DTE actions upon expiration of the time-limits are given in Table D.2.

NOTES

1 A DTE may use a timer shorter than the value given for T21 in Table D.2. This may be appropriate when the DTE knows the normal response time of the called DTE to an incoming call. In this case, the timer should account for the normal maximum response time of the called DTE and the estimated maximum call set-up time.

2 T21 may time out before the DCE T11 timer at the interface of the called DTE.

TABLE D.1/X.25

DCE time-outs

Time-out number	Time-out value	Started when	State of the logical channel	Normally terminated when	Actions to be taken the first time the time-out expires		Actions to be taken the second time the time-out expires	
					Local side	Remote side	Local side	Remote side
T10	60s	DCE issues a <i>restart indication</i>	r3	DCE leaves the r3 state (i.e. the <i>restart confirmation</i> or <i>restart request</i> is received)	DCE remains in r3, signals a <i>restart indication</i> (local procedure error # 52) again, and restarts time-out T10	For permanent virtual circuits, DCE may enter the d3 state signalling a <i>reset indication</i> (remote procedure error # 52)	DCE enters the r1 state and may issue a <i>diagnostic packet</i> (# 52)	For permanent virtual circuits, DCE may enter the d3 state signalling a <i>reset indication</i> (remote procedure error # 52)
T11	180s	DCE issues an <i>incoming call</i>	p3	DCE leaves the p3 state (e.g. the <i>call accepted</i> , <i>clear request</i> or <i>call request</i> is received)	DCE enters the p7 state signalling a <i>clear indication</i> (local procedure error # 49)	DCE enters the p7 state signalling a <i>clear indication</i> (remote procedure error # 49)		
T12	60s	DCE issues a <i>reset indication</i>	d3	DCE leaves the d3 state (e.g. the <i>reset confirmation</i> or <i>reset request</i> is received)	DCE remains in d3, signals a <i>reset indication</i> (local procedure error # 51) again, and restarts time-out T12	DCE may enter the d3 state signalling a <i>reset indication</i> (remote procedure error # 51)	For virtual calls, DCE enters the p7 state signalling a <i>clear indication</i> (local procedure error # 51). For permanent virtual circuits, DCE enters the d1 state and may issue a <i>diagnostic packet</i> (# 51)	For virtual calls, DCE enters the p7 state signalling a <i>clear indication</i> (remote procedure error # 51). For permanent virtual circuits, DCE may enter the d3 state signalling a <i>reset indication</i> (remote procedure error # 51)
T13	60s	DCE issues a <i>clear indication</i>	p7	DCE leaves the p7 state (e.g. the <i>clear confirmation</i> or <i>clear request</i> is received)	DCE remains in p7, signals a <i>clear indication</i> (local procedure error # 50) again, and restarts the time-out T13		DCE enters the p1 state and may issue a <i>diagnostic packet</i> (# 50)	

TABLE D.2/X.25

DTE Time-limits

Time-out number	Time-limit value	Started when	State of the logical channel	Normally terminated when	Preferred action to be taken when time-limit expires
T20	180s	DTE issues a <i>restart request</i>	r2	DTE leaves the r2 state (i.e. the <i>restart confirmation</i> or <i>restart indication</i> is received)	To retransmit the <i>restart request</i> (Note 1)
T21	200s	DTE issues a <i>call request</i>	p2 (or p5 if a collision occurs)	DTE leaves the p2 state (e.g. the <i>call connected</i> or <i>clear indication</i> is received)	To transmit a <i>clear request</i>
T22	180s	DTE issues a <i>reset request</i>	d2	DTE leaves the d2 state (e.g. the <i>reset confirmation</i> or <i>reset indication</i> is received)	For virtual calls, to retransmit the <i>reset request</i> or to transmit a <i>clear request</i> For virtual permanent call circuits, to retransmit the <i>reset request</i> (Note 2)
T23	180s	DTE issues a <i>clear request</i>	p6	DTE leaves the p6 state (e.g. the <i>clear confirmation</i> or <i>clear indication</i> is received)	To retransmit the <i>clear request</i> (Note 2)
<p>NOTES</p> <p>1 After unsuccessful retries, recovery decisions should be taken at higher layers.</p> <p>2 After unsuccessful retries, the logical channel should be considered out of order. The restart procedure should be invoked for recovery if reinitialization of all logical channels is acceptable.</p>					

Annex E

Coding of X.25 network generated diagnostic fields in clear, reset and restart indication, and diagnostic packets

(This annex forms an integral part of this Recommendation)

TABLE E.1/X.25

(Notes 1, 2 and 3)

Diagnostics	Bits								Decimal
	8	7	6	5	4	3	2	1	
<i>No additional information</i>	0	0	0	0	0	0	0	0	0
Invalid P(S)	0	0	0	0	0	0	0	1	1
Invalid P(R)	0	0	0	0	0	0	1	0	2
	0	0	0	0	1	1	1	1	15
<i>Packet type invalid</i>	0	0	0	1	0	0	0	0	16
For state r1	0	0	0	1	0	0	0	1	17
For state r2	0	0	0	1	0	0	1	0	18
For state r3	0	0	0	1	0	0	1	1	19
For state p1	0	0	0	1	0	1	0	0	20
For state p2	0	0	0	1	0	1	0	1	21
For state p3	0	0	0	1	0	1	1	0	22
For state p4	0	0	0	1	0	1	1	1	23
For state p5	0	0	0	1	1	0	0	0	24
For state p6	0	0	0	1	1	0	0	1	25
For state p7	0	0	0	1	1	0	1	0	26
For state d1	0	0	0	1	1	0	1	1	27
For state d2	0	0	0	1	1	1	0	0	28
For state d3	0	0	0	1	1	1	0	1	29
	0	0	0	1	1	1	1	1	31
<i>Packet not allowed</i>	0	0	1	0	0	0	0	0	32
Unidentifiable packet	0	0	1	0	0	0	0	1	33
Call on one-way logical channel	0	0	1	0	0	0	1	0	34
Invalid packet type on a permanent virtual circuit	0	0	1	0	0	0	1	1	35
Packet on unassigned logical channel	0	0	1	0	0	1	0	0	36
Reject not subscribed to	0	0	1	0	0	1	0	1	37
Packet too short	0	0	1	0	0	1	1	0	38
Packet too long	0	0	1	0	0	1	1	1	39
Invalid general format identifier	0	0	1	0	1	0	0	0	40
Restart packet with non-zero in bits 1 to 4 of octet 1, or bits 1 to 8 of octet 2	0	0	1	0	1	0	0	1	41
Packet type not compatible with facility	0	0	1	0	1	0	1	0	42
Unauthorized interrupt confirmation	0	0	1	0	1	0	1	1	43
Unauthorized interrupt	0	0	1	0	1	1	0	0	44
Unauthorized reject	0	0	1	0	1	1	0	1	45
TOA/NPI address subscription facility not subscribed to	0	0	1	0	1	1	1	0	46
	0	0	1	0	1	1	1	1	47
<i>Time expired</i>	0	0	1	1	0	0	0	0	48
For incoming call	0	0	1	1	0	0	0	1	49
For clear indication	0	0	1	1	0	0	1	0	50
For reset indication	0	0	1	1	0	0	1	1	51
For restart indication	0	0	1	1	0	1	0	0	52
For call deflection	0	0	1	1	0	1	0	1	53
	0	0	1	1	1	1	1	1	63

TABLE E.1/X.25 (concluded)

(Notes 1, 2 and 3)

Diagnostics	Bits								Decimal
	8	7	6	5	4	3	2	1	
<i>Call set-up or call clearing problem</i>	0	1	0	0	0	0	0	0	64
Facility code not allowed	0	1	0	0	0	0	0	1	65
Facility parameter not allowed	0	1	0	0	0	0	1	0	66
Invalid called DTE address	0	1	0	0	0	0	1	1	67
Invalid calling DTE address	0	1	0	0	0	1	0	0	68
Invalid facility length	0	1	0	0	0	1	0	1	69
Incoming call barred	0	1	0	0	0	1	1	0	70
No logical channel available	0	1	0	0	0	1	1	1	71
Call collision	0	1	0	0	1	0	0	0	72
Duplicate facility requested	0	1	0	0	1	0	0	1	73
Non-zero address length	0	1	0	0	1	0	1	0	74
Non-zero facility length	0	1	0	0	1	0	1	1	75
Facility not provided when expected	0	1	0	0	1	1	0	0	76
Invalid ITU-T specified DTE facility	0	1	0	0	1	1	0	1	77
Maximum number of call redirections or call deflections exceeded	0	1	0	0	1	1	1	0	78
	0	1	0	0	1	1	1	1	79
<i>Miscellaneous</i>	0	1	0	1	0	0	0	0	80
Improper cause code from DTE	0	1	0	1	0	0	0	1	81
Not aligned octet	0	1	0	1	0	0	1	0	82
Inconsistent Q-bit setting	0	1	0	1	0	0	1	1	83
NUI problem	0	1	0	1	0	1	0	0	84
ICRD problem	0	1	0	1	0	1	0	1	85
	0	1	0	1	1	1	1	1	95
<i>Not assigned</i>	0	1	1	0	0	0	0	0	96
	0	1	1	0	1	1	1	1	111
<i>International problem</i>	0	1	1	1	0	0	0	0	112
Remote network problem	0	1	1	1	0	0	0	1	113
International protocol problem	0	1	1	1	0	0	1	0	114
International link out of order	0	1	1	1	0	0	1	1	115
International link busy	0	1	1	1	0	1	0	0	116
Transit network facility problem	0	1	1	1	0	1	0	1	117
Remote network facility problem	0	1	1	1	0	1	1	0	118
International routing problem	0	1	1	1	0	1	1	1	119
Temporary routing problem	0	1	1	1	1	0	0	0	120
Unknown called DNIC	0	1	1	1	1	0	0	1	121
Maintenance action (Note 4)	0	1	1	1	1	0	1	0	122
	0	1	1	1	1	1	1	1	127
<i>Reserved for network specific diagnostic information</i>	1	0	0	0	0	0	0	0	128
	1	1	1	1	1	1	1	1	255
NOTES									
1 Not all diagnostic codes need apply to a specific network, but those used are as coded in the table.									
2 A given diagnostic need not apply to all packet types (i.e. <i>reset indication</i> , <i>clear indication</i> , <i>restart indication</i> and <i>diagnostic packets</i>).									
3 The first diagnostic in each grouping is a generic diagnostic and can be used in place of the more specific diagnostics within the grouping. The decimal 0 diagnostic code can be used in situations where no additional information is available.									
4 This diagnostic may also apply to a maintenance action within a national network.									

Annex F

Subscription-time optional user facilities that may be associated with a network user identifier in conjunction with the NUI override facility

(This annex forms an integral part of this Recommendation)

(See 6.21.2)

Subscription-time optional user facility	May be associated with an NUI
TOA/NPI address subscription	No
Extended packet sequence numbering	No
D-bit modification	No
Packet retransmission	No
Incoming calls barred	No
Outgoing calls barred	No
One-way logical channel outgoing	No
One-way logical channel incoming	No
Non-standard default packet sizes	Yes
Non-standard default window sizes	Yes
Default throughput classes assignment	Yes
Flow control parameter negotiation (subscription-time)	Yes
Throughput class negotiation related facilities (subscription-time)	Yes
Closed user group related facilities	
Closed user group	Yes
Closed user group with outgoing access	Yes
Closed user group with incoming access	No
Incoming calls barred within a closed user group	No
Outgoing calls barred within a closed user group	No
Bilateral closed user group related facilities	
Bilateral closed user group	Yes
Bilateral closed user group with outgoing access	Yes
Fast select acceptance	No
Reverse charging acceptance	No
Local charging prevention	No
Charging information (subscription-time)	Yes
ROA subscription	Yes
Hunt group	No
Call redirection and call deflection related facilities	
Call redirection	No
Call deflection subscription	No
ICRD prevention subscription	No
Alternative address registration related facilities	No

Annex G

ITU-T specified DTE facilities to support the OSI Network service and other purposes

(This annex forms an integral part of this Recommendation)

G.1 Introduction

The facilities described in this annex are intended to support end-to-end signalling required by the OSI Network service or other non-OSI services. They follow the ITU-T specified DTE facility marker defined in 7.1. These facilities are passed unchanged between the two packet mode DTEs involved.

Procedures for use of these facilities by DTEs are specified in ISO 8208. Subsequent provision of X.25 facilities to be acted on by public data networks is for further study. Coding of the facilities in this annex is defined here in order to facilitate a consistent facility coding scheme in such future evolution.

G.2 Coding of the facility code fields

Table G.1 gives the coding of the facility code field for each ITU-T specified DTE facility and the packet types in which they may be present. These facilities are conveyed after the ITU-T specified DTE facility marker.

G.3 Coding of the facility parameter field

G.3.1 Calling address extension facility

The octet following the facility code field indicates the length of the facility parameter field in octets. It has a value of $n + 1$, where n is the number of octets necessary to hold the calling address extension. The facility parameter field follows the length and contains the calling address extension.

The first octet of the facility parameter field indicates, in bits 8 and 7, the use of the calling address extension, as shown in Table G.2.

Bits 6, 5, 4, 3, 2 and 1 of this octet indicates the number of semi-octets (up to a maximum of 40) in the calling address extension. This address length indicator is binary coded, where bit 1 is the low-order bit.

The following octets contain the calling address extension.

If bits 8 and 7 of the first octet of the facility parameter field are coded "00", the following octets are encoded using the Preferred Binary Encoding (PBE) defined in Recommendation X.213. Starting from the high-order digit of the Initial Domain Part (IDP), the address is coded in octet 2 and consecutive octets of the facility parameter field. Each digit, with padding digits applied as necessary, is coded in a semi-octet in binary coded decimal, where bit 5 or 1 is the low-order bit of the digit. In each octet, the higher-order digit is coded in bits 8, 7, 6 and 5. The Domain Specific Part (DSP) of the calling OSI NSAP follows the IDP and is coded in decimal or binary, according to the PBE. For example, if the syntax of the DSP is decimal, each digit is coded in binary coded decimal (with the same rules applying to the DSP as to the IDP above). If the syntax of the DSP is binary, each octet of the calling address extension contains an octet of the DSP.

If bits 8 and 7 of the first octet of the facility parameter field are coded "10", each digit of the calling address extension is coded in a semi-octet in binary coded decimal, where bit 5 or 1 is the low-order bit of the digit. Starting from the high-order digit, the address is coded in octet 2 and consecutive octets of the facility parameter field with two digits per octet. In each octet, the higher order digit is coded in bits 8, 7, 6 and 5. When necessary, the facility parameter field shall be rounded up to an integral number of octets by inserting zeros in bits 4, 3, 2 and 1 of the last octet of the field.

TABLE G.1/X.25

Coding of the facility code field

Facility	Packet types in which the facility may be used						Facility code									
	Call request	Incoming call	Call accepted	Call connected	Clear request (Note 1)	Clear indication (Note 1)	8	7	6	Bits		5	4	3	2	1
Calling address extension	X	X			X (Note 2)		1	1	0	0	1	0	1	1		
Called address extension	X	X	X	X	X	X	1	1	0	0	1	0	0	1		
Quality of service negotiation:																
Minimum throughput class																
– basic format	X	X			X (Note 2)		0	0	0	0	1	0	1	0		
– extended format	X	X			X (Note 2)		0	1	0	0	1	1	0	1		
End-to-end transit delay	X	X	X	X	X (Note 2)		1	1	0	0	1	0	1	0		
Priority	X	X	X	X	X (Note 2)		1	1	0	1	0	0	1	0		
Protection	X	X	X	X	X	X	1	1	0	1	0	0	1	1		
Expedited data negotiation	X	X	X	X	X (Note 2)		0	0	0	0	1	0	1	1		

NOTES

1 Only when issued in direct response to an *incoming call* packet (i.e. no *call accepted* packet was transmitted).

2 Only when the *call deflection selection* facility is used (see 6.25.2.2).

TABLE G.2/X.25

Coding of bits 8 and 7 in the first octet of the calling extension facility parameter field

Bits		Use of calling address extension
8	7	
0	0	To carry a calling address assigned according to CCITT Rec. X.213 ISO/IEC 8348
0	1	Reserved
1	0	Other (to carry a calling address not assigned according to CCITT Rec. X.213 ISO/IEC 8348)
1	1	Reserved

G.3.2 Called address extension facility

The octet following the facility code field indicates the length of the facility parameter field in octets. It has a value of $n + 1$, where n is the number of octets necessary to hold the called address extension. The facility parameter field follows the length and indicates the called address extension.

The first octet of the facility parameter field indicates, in bits 8 and 7, the use of the called address extension, as shown in Table G.3.

Bits 6, 5, 4, 3, 2 and 1 of this octet indicate the number of semi-octets (up to a maximum of 40) in the called address extension. This address length indicator is binary coded, where bit 1 is the low-order bit.

The following octets contain the called address extension.

If bits 8 and 7 of the first octet of the facility parameter field are coded “00”, the following octets are encoded using the Preferred Binary Encoding (PBE) defined in Recommendation X.213. Starting from the high-order digit of the Initial Domain Part (IDP), the address is coded in octet 2 and consecutive octets of the facility parameter field. Each digit, with padding digits applied as necessary, is coded in a semi-octet in binary coded decimal, where bit 5 or 1 is the low-order bit of the digit. In each octet, the higher-order digit is coded in bits 8, 7, 6 and 5. The Domain Specific Part (DSP) of the called OSI NSAP follows the IDP and is coded in decimal or binary, according to the PBE. For example, if the syntax of the DSP is decimal, each digit is coded in binary coded decimal (with the same rules applying to the DSP as to the IDP above). If the syntax of the DSP is binary, each octet of the called address extension contains an octet of the DSP.

TABLE G.3/X.25

Coding of bits 8 and 7 in the first octet of the called extension facility parameter field

Bits		Use of called address extension
8	7	
0	0	To carry a called address assigned according to CCITT Rec. X.213 ISO/IEC 8348
0	1	Reserved
1	0	Other (to carry a called address not assigned according to CCITT Rec. X.213 ISO/IEC 8348)
1	1	Reserved

If bits 8 and 7 of the first octet of the facility parameter field are coded “10”, each digit of the called address extension is coded in a semi-octet in binary coded decimal, where bit 5 or 1 is the low-order bit of the digit. Starting from the high-order digit, the address is coded in octet 2 and consecutive octets of the facility parameter field with two digits per octet. In each octet, the higher order digit is coded in bits 8, 7, 6 and 5. When necessary, the facility parameter field shall be rounded up to an integral number of octets by inserting zeros in bits 4, 3, 2 and 1 of the last octet of the field.

G.3.3 Quality of service negotiation facilities

G.3.3.1 Minimum throughput class facility

G.3.3.1.1 Basic format

The minimum throughput class for the direction of data transmission from the calling DTE is indicated in bits 4, 3, 2 and 1. The minimum throughput class for the direction of data transmission from the called DTE is indicated in bits 8, 7, 6 and 5.

The four bits indicating each throughput class are binary coded and correspond to throughput classes as indicated in Table 7-3.

G.3.3.1.2 Extended format

The minimum throughput class for the direction of data transmission from the calling DTE is indicated in bits 6 to 1 of the first octet. The minimum throughput class for the direction of data transmission from the called DTE is indicated in bits 6 to 1 of the second octets.

The bits indicating each throughput class are binary coded and correspond to throughput classes as indicated in Table 7-4.

G.3.3.2 End-to-end transit delay facility

The octet following the facility code field indicates the length in octets of the facility parameter field and has the value 2, 4 or 6.

The first and second octets of the facility parameter field contain the cumulative transit delay. The third and fourth octets are optional and, when present, contain the requested end-to-end transit delay. If the third and fourth octets are present, then the fifth and sixth octets are also optional. The fifth and sixth octets, when present, contain the maximum acceptable end-to-end transit delay. The optional octets are not present in *call accepted* and *call connected* packets.

Transit delay is expressed in milliseconds and is binary-coded, with bit 8 of the first of a pair of octets being the high-order bit and bit 1 of the second of a pair of octets being the low-order bit. The value of all ones for cumulative transit delay indicates that the cumulative transit delay is unknown or exceeds 65 534 milliseconds.

G.3.3.3 Priority facility

The octet following the facility code field indicates the length, in octets, of the facility parameter field. This may take the value 1, 2, 3, 4, 5 or 6.

The first, second and third octets of the facility parameter field contain the target (*call request* packet), available (*incoming call* packet) or selected (*call accepted* and *call connected* packets) values for the priority of data on connection, priority to gain a connection and priority to keep a connection, respectively. The fourth, fifth and sixth octets of the facility parameter field in *call request* and *incoming call* packets contain the lowest acceptable values for the priority of data on connection, priority to gain a connection and priority to keep a connection, respectively. When the facility is present in *call request* and *incoming call* packets, octet 2 through 6 of the facility parameter field are optional. For example, if the only values to be specified are the target and lowest acceptable values for priority to gain a connection, then the facility parameter field will contain at least 5 octets with octets 1, 3 and 4 containing the value “unspecified”, and octets 2 and 5 containing the specified values. When the facility is present in the *call accepted* and *call connected* packets, octets 2 and 3 are optional.

The potential range of specified values for each sub-parameter is 0 (lowest priority) to 14 (highest priority). The value 255 (1111 1111) indicates “unspecified”.

G.3.3.4 Protection facility

The octet following the facility code indicates the length, in octets, of the facility parameter field.

The two highest order bits of the first octet (i.e. bits 8 and 7) of the facility parameter field specify the protection format code as indicated in Table G.4.

TABLE G.4/X.25

Coding of the two highest order bits in the first octet of the protection format code

Bits		Protection format code
8	7	
0	0	Reserved
0	1	Source-address specific
1	0	Destination-address specific
1	1	Globally unique

When bits 8 and 7 are not both set to one, the remaining six bits of the first octet of the facility parameter field are reserved and set to zero.

When bits 8 and 7 are both set to one, the remaining six bits of the first octet of the facility parameter field are used as shown in Table G.5 below.

TABLE G.5/X.25

Coding of the remaining six bits of the first octet of the protection facility parameter field when the first two bits are both set to one

Bits						Protection facility information
6	5	4	3	2	1	
0	0	0	0	0	0	Level of protection information
0	0	0	0	0	1	Authentication and key information
Other values						Reserved

The *protection* facility is used to convey security related informations including level of protection, authentication information and key information. For all these items, the precise field format is for further study.

For the indication of the level of protection, the following format may be used. The second octet of the facility parameter field specifies the length “*n*”, in octets, of the target (*call request* packet), available (*incoming call* packet) or selected (*call accepted* and *call connected* packets) protection level. The actual value is placed in the following “*n*” octets. Optionally, the “*n + 3*” octet of the facility parameter field specifies the length “*m*”, in octets, of the lowest acceptable protection level in *call request* and *incoming call* packets. The actual value is placed in the following “*m*” octets. The optional octets are not present in *call accepted* and *call connected* packets.

NOTE – The values of “*n*” and “*m*” are bound firstly by the overall length of the facility (first octet), and secondly by each other.

When conveying authentication and key information, the second and following octets of the facility parameter field are coded as given in 9.5 of ITU-T Rec. X.273 | ISO/IEC 11577.

G.3.4 Expedited data negotiation facility

The coding of the facility parameter field is:

- bit 1 = 0 for no use of expedited data;
- bit 1 = 1 for use of expedited data.

NOTE – Bits 8, 7, 6, 5, 4, 3 and 2 may be assigned to other facilities in the future; presently, they are set to zero.

Appendix I

Examples of data link layer transmitted bit patterns by the DCE and the DTE

(This appendix does not form an integral part of this Recommendation)

This appendix is provided for explanatory purposes and indicates the bit patterns that will exist in the physical layer for some of the unnumbered frames. It is included for the purpose of furthering the understanding of the transparency mechanism and the frame check sequence implementation. The examples given here are for the synchronous transmission mode.

I.1 The following are examples of the bit patterns that will be transmitted by a DCE for some unnumbered frames.

Example 1: SABM command frame with address = A, P = 1

First bit transmitted				Last bit transmitted
↓				↓
0111 1110	1100 0000	1111 1(0 ¹)100	1101 1010 0011 0111	0111 1110
Flag	Address = A	SABM(P = 1)	Frame check sequence	Flag

Example 2: UA response frame with address = B, F = 1

First bit transmitted				Last bit transmitted
↓				↓
0111 1110	1000 0000	1100 1110	1100 0001 1110 1010	0111 1110
Flag	Address = B	UA(F = 1)	Frame check sequence	Flag

I.2 The following are examples of the bit patterns that should be transmitted by a DTE for some unnumbered frames:

Example 1: SABM command frame with address = B, P = 1

First bit transmitted				Last bit transmitted
↓				↓
0111 1110	1000 0000	1111 1(0 ¹)100	1101 0111 11(0 ¹)11 1011	0111 1110
Flag	Address = B	SABM(P = 1)	Frame check sequence	Flag

Example 2: UA response frame with address = A, F = 1

First bit transmitted				Last bit transmitted
↓				↓
0111 1110	1100 0000	1100 1110	1100 1100 0010 0110	0111 1110
Flag	Address = A	UA(F = 1)	Frame check sequence	Flag

¹) Zero inserted for transparency.

Appendix II

An explanation of how the values for N1 in 2.4.9.5 are derived

(This appendix does not form an integral part of this Recommendation)

Introduction

This appendix provides a description of how the values given for the data link layer parameter N1 in 2.4.9.5 are derived.

II.1 DTE N1

Subclause 2.4.9.5 states that for universal operation a DTE should support a value of DTE N1 which is not less than 1080 bits (135 octets).

For universal operation, a DTE must be capable of accepting at least the largest packet that can be transmitted across a DTE/DCE interface when no options apply. This implies that the DTE may choose not to support, for example, any optional facilities for universal operations, but must support, for example, a *data* packet using the standard default packet size. Therefore, the determining factor for the maximum value of N1 that a DTE must support is the standard default packet size of a *data* packet rather than the size of a call set-up packet. Thus, for universal operation a DTE need not support a value of DTE N1 greater than 135 octets, derived as shown in Table II.1.

TABLE II.1/X.25

Derivation of the value of N1 for a DTE for universal operation

Name of the field	Length of the field (octets)
Packet header (Layer 3)	3
User data (Layer 3)	128
Address (Layer 2)	1
Control (Layer 2)	1
FCS (Layer 2)	2
Total	135

NOTE – A DTE will need to support larger values of N1 when layer 2 options or layer 3 optional facilities will apply.

II.2 DCE N1

Subclause 2.4.9.5 also states that all networks shall offer to a DTE which requires it a value of DCE N1 which is greater than or equal to 2072 bits (259 octets) plus the length of the address field plus the length of the control field and plus the length of the FCS field.

When the maximum length of the data field of a *data* packet supported is less than or equal to the standard default value of 128 octets, the determining factor (for the value of DCE N1) is the call set-up/clearing packets rather than the *data* packet. Therefore, the network shall offer to a DTE, a value of DCE N1 which is not less than the value shown Table II.2.

TABLE II.2/X.25

Derivation of the minimum value of N1 for a DCE

Name of the field	Length of the field (octets)
Header (Layer 3)	3
Rest of the packet (using the fields and their maxima as defined in 5.2)	256
Layer 3 – Total	259
Address (Layer 2)	1
Control (Layer 2)	1 or 2 ^{a)}
Multilink procedure	2 ^{b)}
FCS (Layer 2)	2
Total	263 or 264 ^{a)} or 265 ^{b)} or 266 ^{a), b)}
a) If layer 2 modulo 128 is supported. b) MultiLink Procedures (MLP) are supported.	

When the maximum length of the user data field of a *data* packet supported is greater than the standard default value of 128 octets, the determining factor (for the value of DCE N1) is the *data* packet rather than the call set-up/clearing packet. Therefore, the network shall offer to a DTE, a value of DCE N1 which is greater than or equal to:

[the maximum length of the *data* packet +
 the length of the address field (Layer 2) +
 the length of the control field (Layer 2) +
 the length of the FCS field (Layer 2)].

II.3 General DCE N1 calculations

Table II.3 below indicates the value of DCE N1 for each possible case. The table shows for each case, whether:

- a) Layer 2 Modulo 128 is used;
- b) MultiLink Procedures are used;
- c) Layer 3 Modulo 128 is used; and/or
- d) the maximum length of the data field (p) in a *data* packet is greater than or equal to 256 octets.

TABLE II.3/X.25

Various cases and corresponding minimum N1 values for a DCE

Layer 2 Modulo 128	MLP	Layer 3 Modulo 128	$p \geq 256$	DCE N1 (octets)
				$259 + 4^* = 263$
	X			$259 + 4^* + 2^{*****} = 265$
			X	$p + 3^{**} + 4^* = p + 7$
	X		X	$p + 3^{**} + 4^* + 2^{*****} = p + 9$
		X		$259 + 4^* + 1^{***} = 264$
	X	X		$259 + 4^* + 1^{***} + 2^{*****} = 266$
		X	X	$p + 3^{**} + 1^{***} + 4^* = p + 8$
	X	X	X	$p + 3^{**} + 1^{***} + 4^* + 2^{*****} = p + 10$
X				$259 + 4^* + 1^{****} = 264$
X	X			$259 + 4^* + 1^{****} + 2^{*****} = 266$
X			X	$p + 3^{**} + 1^{****} + 4^* = p + 8$
X	X		X	$p + 3^{**} + 1^{****} + 4^* + 2^{*****} = p + 10$
X		X		$259 + 4^* + 1^{****} = 264$
X	X	X		$259 + 4^* + 1^{****} + 2^{*****} = 266$
X		X	X	$p + 3^{**} + 1^{***} + 4^* + 1^{****} = p + 9$
X	X	X	X	$p + 3^{**} + 1^{***} + 4^* + 1^{****} + 2^{*****} = p + 11$
*	The number of octets for modulo 8 layer 2 frame fields.			
**	The number of octets for layer 3 packet header fields.			
***	Additional octet for layer 3 modulo 128 operations.			
****	Additional octet for layer 2 modulo 128 operations.			
*****	Additional octets for MLP support.			

Appendix III

Examples of multilink resetting procedures

(This appendix does not form an integral part of this Recommendation)

III.1 Introduction

The following examples illustrate application of the multilink resetting procedures in the case of:

- a) MLP reset initiated by either the DCE or the DTE; and
- b) MLP reset initiated by both the DCE and the DTE simultaneously.

III.2 MLP reset initiated by either the DCE or the DTE

See Figure III.1

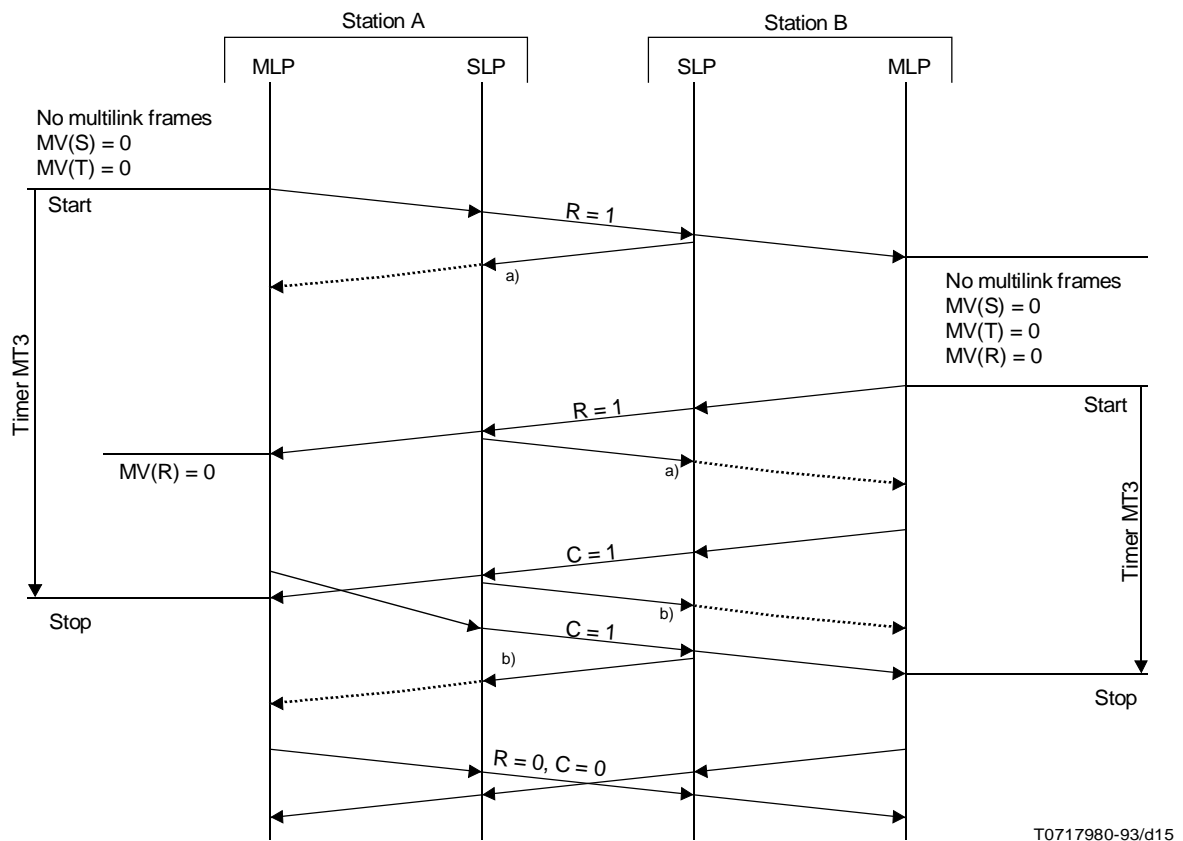

- a) The SLP frame that acknowledges delivery of the multilink frame with R = 1.
- b) The SLP frame that acknowledges delivery of the multilink frame with C = 1.

FIGURE III.1/X.25

III.3 MLP reset initiated by both the DCE and the DTE simultaneously

See Figure III.2

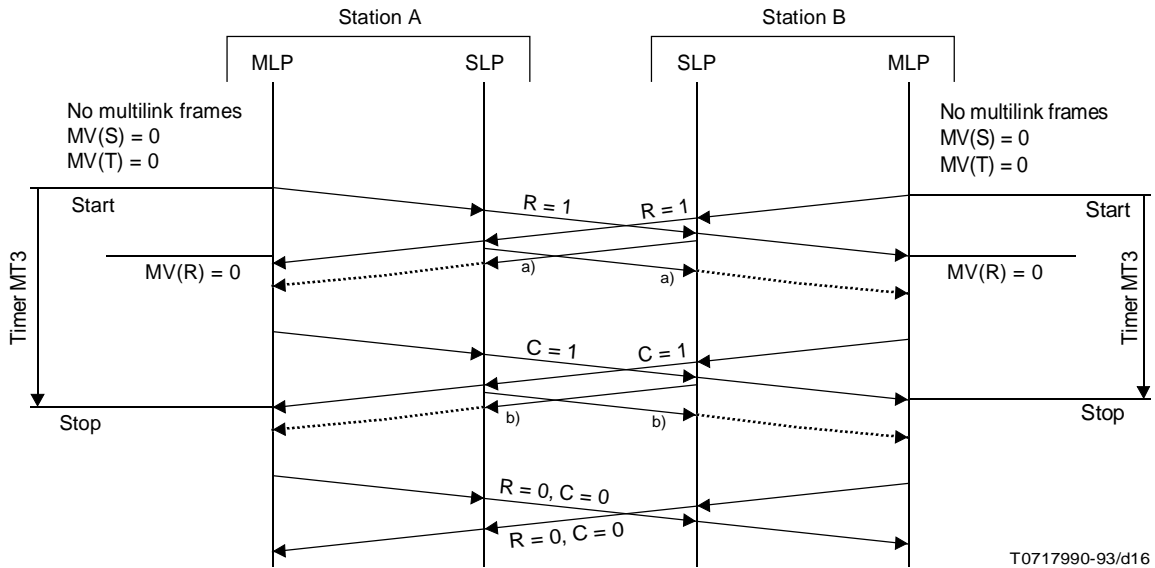

- a) The SLP frame that acknowledges delivery of the multilink frame with R = 1.
- b) The SLP frame that acknowledges delivery of the multilink frame with C = 1.

FIGURE III.2/X.25

Appendix IV

Information on addresses in call set-up and clearing packets

(This appendix does not form an integral part of this Recommendation)

IV.1 Main address and complementary address

A DTE address may include two components: a main address and a complementary address.

IV.1.1 Main address

When the A bit is set to 0, the main address conforms to formats described in Recommendations X.121 and X.301 (including possible prefixes and/or escape codes).

When the A bit is set to 1, the main address has the structure described in Figure IV.1 below. In the called DTE address field of the *call request* packet, the address subfield may either conform to formats described in Recommendations X.121 and X.301 or be an alternative address. In the calling DTE address field of the *call request* packet and in other packets, the address subfield will conform to formats described in Recommendations X.121 and X.301.

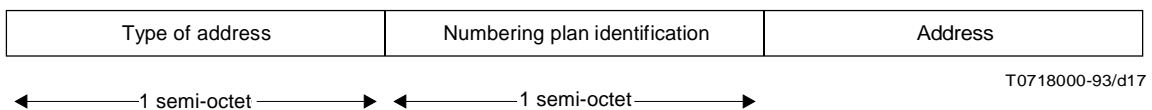

FIGURE IV.1/X.25

Format of the main address when the A bit is set to 1

The possible values and the semantic of the TOA and NPI subfields are described in 5.2.1.2.2. See Tables 5-3, 5-4 and 5-5.

IV.1.2 Complementary address

A complementary address is an address information additional to that defined in Recommendation X.121 (see 6.8.1/X.301).

Some networks allow the DTE to include a complementary address. When a complementary address is permitted by the network, the DTE is not obliged to use this complementary address. The complementary address may be as long as possible in considering the maximum value of the DTE address length fields defined in 5.2.1.1.1 and 5.2.1.2.1.

When a complementary address is contained in a DTE address field of a packet transmitted by the network to the DTE, this complementary address is always passed transparently from the remote DTE: it means that the network never creates a complementary address from itself.

When a complementary address is invoked in the following sections, it is supposed that the network supports the use of complementary addresses.

When the A bit is set to 1 and a complementary address is present alone (i.e. without main address) in DTE address field, it is preceded by the type of address and numbering plan identification subfields.

IV.2 Addresses in call request packet

In the *call request* packet, the called DTE address should be provided in the address block by the calling DTE except when either the *bilateral closed user group selection* is provided in the facility field (see 6.15.3) or, possibly, when the OSI NSAP address in the *called address extension* facility (see Annex G) is used as an alternative address (see 5.2.1.1.1, 5.2.1.2.1 and 6.28.3). Depending on the called network and the DTE, this called DTE address may be made of a main address then a complementary address, or of a main address alone.

Depending on the network, the DTE may have the following possibilities for the calling DTE address:

- i) The DTE may include either no calling DTE address, or a main address optionally followed by a complementary address. When a calling DTE address is provided by the DTE, the network is required to check its validity. If the calling DTE address is not valid, the network may either replace this invalid calling DTE address by a valid one, or clear the call. If the *hunt group* facility has been subscribed to by the calling DTE (see 6.24) and a specific address has been assigned to the calling DTE/DCE interface, the main address provided by the calling DTE may be the hunt group address or the specific address.

NOTE – In this latter case, some networks do not allow the calling DTE to indicate the hunt group address, but only the specific address.

- ii) The DTE may include either no calling DTE address, or a calling complementary address. In this last case, when the A bit is set to 1, this complementary address shall be preceded by the type of address and numbering plan identification subfields.

IV.3 Addresses in incoming call packets

In *incoming call* packet, the calling DTE address should be provided by the DCE except when the *bilateral closed user group selection* is provided in the facility field (see 6.15.3) or in one case described in 6.1. This calling DTE address always includes a main address. This main address is followed by a calling complementary address if such a complementary address had been provided by the calling DTE in the *call request* packet (see IV.2), and the calling DTE address was considered as valid by the network at the calling DTE side. If the *hunt group* facility has been subscribed to by the calling DTE (see 6.24) and a specific address has been assigned to the calling DTE/DCE interface, the main address indicated in the calling DTE address may be the hunt group address (only if the calling DTE had indicated either its hunt group address or no main address, in the calling DTE address field of the *call request* packet) or the specific address (regardless of the contents of the calling DTE address field in the *call request* packet).

Depending on the network, the called DTE address may be made of:

- i) The main called address optionally followed by the called complementary address if this complementary address had been provided by the calling DTE. If the *hunt group* facility has been subscribed to by the called DTE (see 6.24) and a specific address has been assigned to the called DTE/DCE interface, the main address indicated in the called DTE address field may be the hunt group address (only if the calling DTE had indicated this hunt group address or no main address, in the called DTE address field of the *call request* packet) or the specific address (regardless of the contents of the called DTE address field in the *call request* packet).
- ii) The called complementary address alone when provided by the calling DTE, or nothing if the calling DTE had not provided this called complementary address. When a called complementary address is alone and the A bit is set to 1, the called complementary is preceded by the type of address and numbering plan identification subfields.

IV.4 Addresses in call accepted packets

Some networks do not allow any DTE addresses in *call accepted* packets except a called DTE address in conjunction with the *called line address modified notification* facility, when supported by the network and provided by the DTE.

Some other networks allow the DTE to include in the *call accepted* packet none, one or both of the two DTE addresses. When provided by the DTE, the calling DTE address in the *call accepted* packet should be the same as the calling DTE address in the *incoming call* packet. When provided by the DTE, the called DTE address in the *call accepted* packet should be the same as the called DTE address in the *incoming call* packet, except if the *called line address modified notification* facility (when supported by the network) is also provided by the DTE.

When the *called line address modified notification* facility (when supported by the network) is provided by the DTE in the *call accepted* packet, the called DTE address may be made of one of the following exclusive network-dependent possibilities:

- i) A main DTE address identical to that of the *incoming call* packet, followed by a called complementary address different from that of the *incoming call* packet, or another main DTE address valid for the DTE/DCE interface optionally followed by any complementary address.
- ii) A called complementary address, different from that which was possibly present in the called DTE address of the *incoming call* packet. In this case, when the A bit is set to 1, the called complementary address shall be preceded by the type of address and numbering plan identification subfields.

IV.5 Addresses in call connected packets

Some networks do not provide any DTE address in *call connected* packets except a called DTE address in conjunction with the *called line address modified notification* facility.

Some other networks always provide both DTE addresses in *call connected* packets.

Some other networks provide a DTE address in a *call connected* packet only if this DTE address was present in the *call accepted* packet or in conjunction with the *called line address modified notification* facility.

In any case, when an address is provided by the network in the *call connected* packet, this address should be the same as that in the *call request* packet except when the *called line address modified notification* facility is present in the facility field: in this case, the called DTE address contains always a main address optionally followed by a complementary address.

In the case where an alternative address was used in the *call request* packet to establish the call, it is a network option that no called DTE address will be present in the *call connected* packet.

IV.6 Addresses in clear request packets

No DTE address is permitted in *clear request* packets except a called DTE address when the *called line address modified notification* facility (see 6.26) is used in this packet. In this case, the *clear request* packet is transmitted as a direct response to the *incoming call* packet and the called DTE address may be made of one of the following network-dependent possibilities:

- i) A main DTE address identical to that of the *incoming call* packet, followed by a called complementary address different from that of the *incoming call* packet, or another main DTE address valid for the DTE/DCE interface.
- ii) A called complementary address, different from that which was possibly present in the called DTE address of the *incoming call* packet. In this case, when the A bit is set to 1, the called complementary address shall be preceded by the type of address and numbering plan identification subfields.

IV.7 Addresses in clear indication packets

No DTE address is permitted in *clear indication* packets except when the *called line address modified notification* facility (see 6.26) is used in this packet. In this case, the *clear indication* packet is transmitted as a direct response to the *call request* packet and the called DTE address contains always a main address optionally followed by a complementary address.

IV.8 Addresses in clear confirmation packets

DTE addresses are not present in *clear confirmation* packets.

IV.9 Addresses in call redirection and call deflection related facilities

The alternative DTE address, indicated at subscription-time (for the *call redirection* facility) or in the *call deflection selection* facility of the *clear request* packet (see 6.25.1 and 6.25.2), is composed of a main address optionally followed by a complementary address.

If a called complementary address was present in the *call request* packet, some networks may add this called complementary address after the alternative DTE address.

Appendix V

Guidelines for transmission over channels with long round trip delay and/or transmission rates higher than 64 000 bit/s

(This appendix does not form an integral part of this Recommendation)

V.1 Preamble

The default parameters of this Recommendation, viz. data link layer modulo, frame size and window size (k) value, and packet layer modulo, packet size and window size are not optimized for operation over connections in which a long round trip delay will be encountered, such as cables with long delays and satellite links, nor for transmission rates higher than 64 000 bit/s.

NOTES

1 The round trip delay is the time that elapses between sending the first bit of an I frame and receiving the last bit of the corresponding acknowledgement frame. Hence, round trip delay is dependent on the transmission rate, the frame size, the propagation delay of the channel and the queuing/processing delay of the DTE and DCE.

2 Optical fibre cables introduce a round trip delay of approximately 10 ms per 1000 km. A further allowance should be made for transmission and switching equipments. Single hop satellite connections, including transmission equipments, introduce a round trip delay of approximately 600 ms.

This appendix provides guidelines for the appropriate selection of parameters in these cases.

V.2 Common guidelines

To make maximum use of channels with long round trip delay and/or high bandwidth, it is necessary to ensure that a sufficient number of octets are transmitted. This number is a function, first, of the transmission rate (R) and round trip delay (D) and, second, of other factors such as Bit Error Rate (BER). Annex A/X.135 and Annex B/X.138 provide a list of factors to be specified in reporting throughput performance.

Based on the primary factors, the number of octets is:

$$x(\text{octets}) = \frac{D(\text{sec}) * R(\text{bit/s})}{8}$$

Therefore, approximately x octets, depending on the secondary factors, are needed. From the value of x , the following expressions provide the minimum requirements for selection of maximum frame size (N1), maximum number of outstanding I frames (k), and maximum retransmission delay (T1) as a function of x and D :

$$N1 (\text{octets}) * k = x, \text{ and } T1 > D$$

For a given k , N1 is directly derived. However, not all frames and layer 3 packets will be of maximum size. Derivation of an optimal value of k in such cases is beyond the scope of this appendix (the distribution of various sizes of frames/packets being DTE/application dependent).

Where only a single layer 3 logical channel is active, it is recommended that the maximum packet size and the associated window size should be matched with the chosen data link layer values; for example, the layer 3 maximum packet size should be appropriate for the frame size to be used and the associated layer 3 window size should be large enough to fill the round trip delay. Additionally, the layer 2 window size should be larger than the layer 3 window size by at least one, to allow for layer 3 control packets. These values are easier to achieve in the case of this Recommendation with a single logical channel as compared with the case where it is used with multiple logical channels (e.g. a gateway).

V.3 Guidelines for channels with long round trip delays operating at 64 000 bit/s

For the data link layer operating over connections with a maximum round trip delay of 600 ms (which includes one satellite hop), the modulo 8 frame numbering may be used, but a frame size of at least 1024 octets is necessary to maximize efficiency. If a smaller frame is to be used, it is necessary to use modulo 128.

Assuming modulo 128, layer 2 windows (k) can be derived from the allowable maximum packet sizes (maximum frame sizes, N1, are derived from the maximum packet sizes with the addition of 11 octets, for the packet overhead of 4 octets and frame overhead of 7 octets). These are shown in Table V.1:

TABLE V.1/X.25

Layer 2 window (k) – 64 000 bit/s – Round trip delay of 600 ms

Packet data field size (octets)	Frame size (N1) with overhead (octets)	k
128	139	35
256	267	18
512	523	10
1024	1035	5
2048	2059	3
4096	4107	2

V.4 Guidelines for circuits with long round trip delays operating at 1920 kbit/s

For most X.25 terrestrial circuits with transmission rates of 1920 kbit/s, the round trip delay is on the order of 1 ms; therefore, modulo 8 is sufficient. For longer round trip delays operating at 1920 kbit/s assuming modulo 128, the following parameters are suggested:

- a) for cables with nominal delay ($D \sim 10$ ms), see Table V.2;
- b) for cables with long delays ($D \sim 120$ ms), see Table V.3 where appropriate k values for different packet sizes are given;
- c) for satellite links ($D \sim 600$ ms).

The need for an X.25 circuit operating at 1920 kbit/s over a satellite link is yet to be established and, accordingly, appropriate k values have not been suggested. This matter is for further study.

TABLE V.2/X.25

Layer 2 window (k) – 1920 kbit/s – Round trip delay of 10 ms

Packet data field size (octets)	Frame size (N1) with overhead (octets)	k
128	139	18
256	267	9
512	523	5
1024	1035	3
2048	2059	2

TABLE V.3/X.25

Layer 2 window (k) – 1920 kbit/s – Round trip delay of 120 ms

Packet data field size (octets)	Frame size (N1) with overhead (octets)	k
256	267	108
512	523	56
1024	1035	28
2048	2059	14
4096	4107	28

Appendix VI

Format for NUI parameter field

(This appendix does not form an integral part of this Recommendation)

When an Administration wishes to support a standardized NUI format, it is recommended that the following be used.

The first octet of the facility parameter field has one of the two alternative formats:

- a) Standardized default format consists of a control octet followed by the NUI. The control octet is encoded as:

Bit: 8 7 6 5 4 3 2 1
 1 1 V 0 N F V E

The V, NF, VE bits and the remaining octets of parameter field for this case are specified below.

b) Unconstrained format

Bit: 8 7 6 5 4 3 2 1
 Y Y X X X X X X

Where YY = 00, 01 or 10. Neither XXXXXX nor the remaining octets of the parameter field in this case are constrained by this Recommendation.

For the standardized default format [see a) above], all of the following encoding rules apply:

Only the value V = 0 may be passed over an X.25 interface in the DTE to DCE direction. The case where V might be set to 1 is left for further study.

The format option used for the NUI, as contained in the remaining octets of the facility parameter field is encoded in the NF bits:

NF bits: 4 3

0	0	First subfield conforms to Recommendation E.118 and ISO 7812
0	1	No constraints on following octets
1	0	Subfield format; no subfield information constraints
1	1	(Reserved)

The verifying entity is encoded in the VE bits:

VE bits: 2 1

0	0	Originating network (see Note 1)
0	1	Destination network (see Note 2)
1	0	First transit network
1	1	Other/Not specified

NOTES

- 1 The originating network is the network in which the call request phase is initiated.
- 2 The destination network is the network in which the call confirmation phase is initiated.

If NF = 01, the remaining octets of the parameter field are not constrained. If NF = 00 or NF = 10, the remaining octets of the facility parameter field are divided into *m* subfields (*m* greater or equal to 1) where each subfield is defined as follows:

	8	7	6	5	4	3	2	1
I	Type				0	0	0	0
I + 1	Subfield length							
I + 2	Subfield information							
I + J								

where I is the number of the initial octet of the subfield and J – I is the number of octets of information in the subfield. The Type semi-octet specifies the encoding format for the information of the subfield as follows:

	Bits				
	8	7	6	5	
1	1	0	1		BCD semi-octet
1	1	0	0		IA5 (Rec. T.50) with bit 8 = 0
1	1	1	0		Reserved for national use
1	1	1	1		Network specific format
	Other				For future definition

Bits 4 through 1 of the first of each subfield are set to 0. Other values for this semi-octet are reserved for future use.

Subfield length is the number of semi-octets of information in the subfield, and is encoded in binary.

NOTE – For Type = 1100 (IA5), subfield length must be an even value.

For Type = 1101 (BCD), subfield length may be an even or odd value, although an integral number of octets will be assured by inserting zeros in bits 4, 3, 2 and 1 of the last octet of the subfield when necessary.

The DCE must be able to recognize and distinguish between the two format alternatives [a) and b)] specified above, but the network need not support both alternatives nor all of the format options specified for alternative a) (if that alternative is supported). Support refers to the ability to accept and/or verify/use the parameter field format alternative or option in question.

A network may change the value of the V bit received from a DTE to 1 only if it is the verifying entity. A network receiving an NUI value with a VE subfield of “11” (other/not specified) may change the VE value to one of the three specified values (and, depending on the value inserted, designate itself as the verifying entity). Other changes in the VE subfield value received are not permitted.

Appendix VII

Examples of the use of multi-selective reject option

(This appendix does not form an integral part of this Recommendation)

This appendix shows examples of the use of multi-selective reject option.

Figure VII.1 shows the frame exchange between the DCE and the DTE, when I frames are lost and recovered by retransmissions using the SREJ frame with the F bit set to 0.

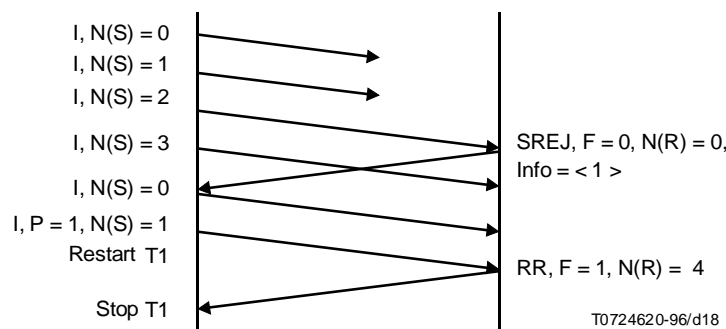

FIGURE VII.1/X.25

I frame recovery due to SREJ frame with F bit set to 0

Figure VII.2 shows the frame exchange between the DCE and the DTE, when I frames are lost and the resulting SREJ frame with the F bit set to 0 is also lost.

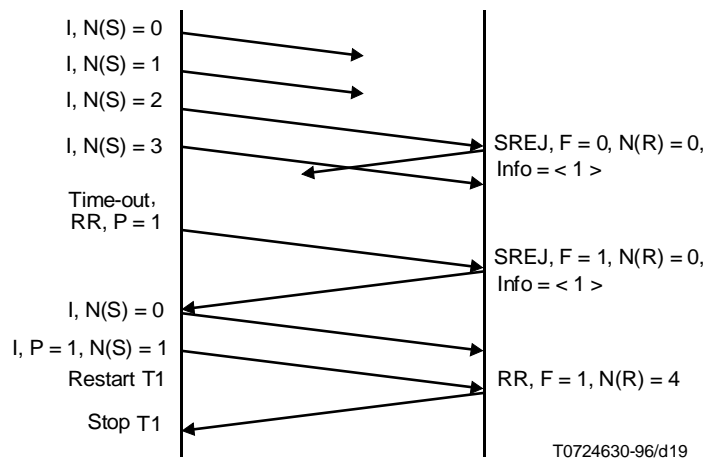

FIGURE VII.2/X.25
I frame recovery, when SREJ frame with F bit set to 0 is lost

Figure VII.3 shows the frame exchange between the DCE and the DTE, when the last few I frames in a sequence of I frames are lost.

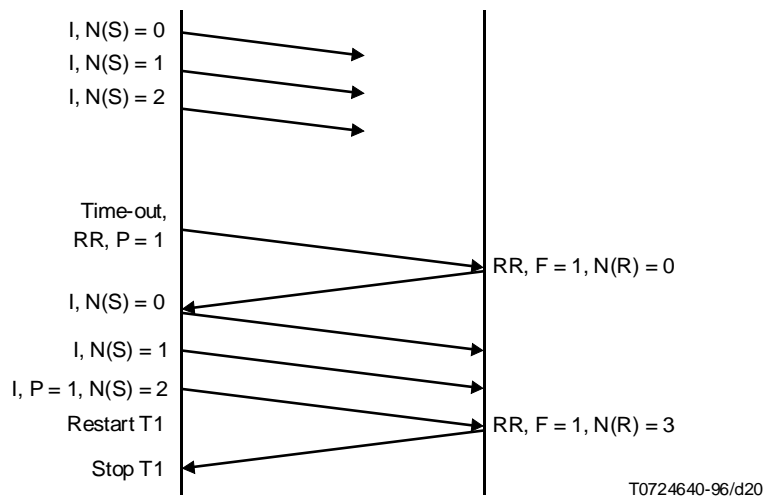

FIGURE VII.3/X.25
I frame recovery, when last few I frames in sequence of I frames are lost

Figure VII.4 shows a more complex exchange of frames between the DCE and the DTE, where retransmitted I frames are lost.

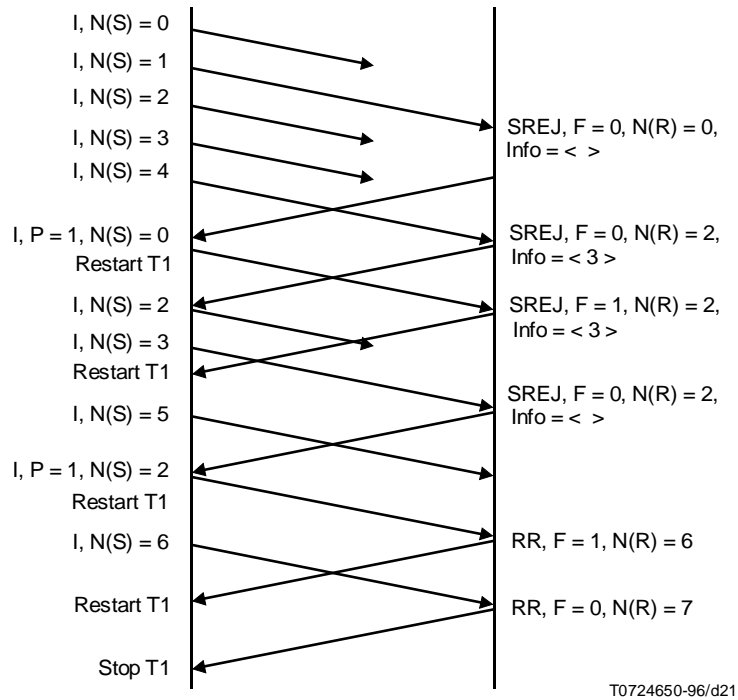

FIGURE VII.4/X.25

I frame recovery, when retransmitted I frames are lost

Figure VII.5 shows a more complex exchange of frames between the DCE and the DTE, where the multiple I frames, including the last I frame in a sequence of I frames, and SREJ frames are lost.

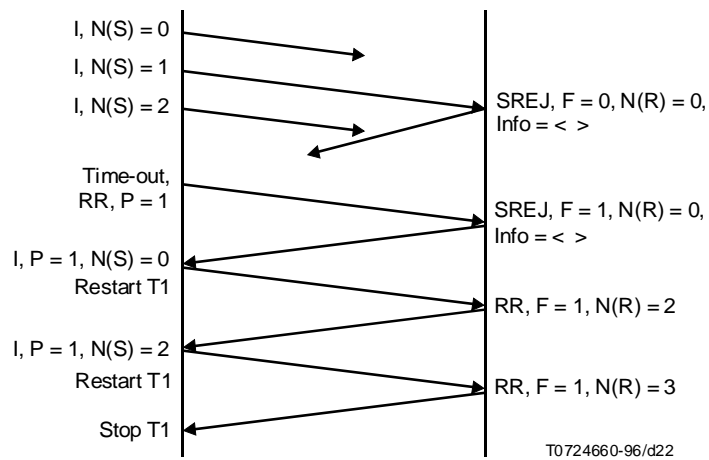

FIGURE VII.5/X.25

I frame recovery, when multiple I frames, last I frame and SREJ frames are lost

ITU-T RECOMMENDATIONS SERIES

- Series A Organization of the work of the ITU-T
- Series B Means of expression
- Series C General telecommunication statistics
- Series D General tariff principles
- Series E Telephone network and ISDN
- Series F Non-telephone telecommunication services
- Series G Transmission systems and media
- Series H Transmission of non-telephone signals
- Series I Integrated services digital network
- Series J Transmission of sound-programme and television signals
- Series K Protection against interference
- Series L Construction, installation and protection of cables and other elements of outside plant
- Series M Maintenance: international transmission systems, telephone circuits, telegraphy, facsimile and leased circuits
- Series N Maintenance: international sound-programme and television transmission circuits
- Series O Specifications of measuring equipment
- Series P Telephone transmission quality
- Series Q Switching and signalling
- Series R Telegraph transmission
- Series S Telegraph services terminal equipment
- Series T Terminal equipments and protocols for telematic services
- Series U Telegraph switching
- Series V Data communication over the telephone network
- Series X Data networks and open system communication**
- Series Z Programming languages