



INTERNATIONAL TELECOMMUNICATION UNION

**ITU-T**

TELECOMMUNICATION  
STANDARDIZATION SECTOR  
OF ITU

**X.7**

(10/96)

SERIES X: DATA NETWORKS AND OPEN SYSTEM  
COMMUNICATION

Public data networks – Services and facilities

---

**Technical characteristics of data transmission  
services**

ITU-T Recommendation X.7

(Previously “CCITT Recommendation”)

---

ITU-T X-SERIES RECOMMENDATIONS  
DATA NETWORKS AND OPEN SYSTEM COMMUNICATION

<b>PUBLIC DATA NETWORKS</b>	<b>X.1-X.199</b>
<b>Services and facilities</b>	<b>X.1-X.19</b>
Interfaces	X.20-X.49
Transmission, signalling and switching	X.50-X.89
Network aspects	X.90-X.149
Maintenance	X.150-X.179
Administrative arrangements	X.180-X.199
<b>OPEN SYSTEM INTERCONNECTION</b>	<b>X.200-X.299</b>
Model and notation	X.200-X.209
Service definitions	X.210-X.219
Connection-mode protocol specifications	X.220-X.229
Connectionless-mode protocol specification	X.230-X.239
PICS proformas	X.240-X.259
Protocol Identification	X.260-X.269
Security Protocols	X.270-X.279
Layer Managed Objects	X.280-X.289
Conformance testing	X.290-X.299
<b>INTERWORKING BETWEEN NETWORKS</b>	<b>X.300-X.399</b>
General	X.300-X.349
Satellite data transmission systems	X.350-X.399
<b>MESSAGE HANDLING SYSTEMS</b>	<b>X.400-X.499</b>
<b>DIRECTORY</b>	<b>X.500-X.599</b>
<b>OSI NETWORKING AND SYSTEM ASPECTS</b>	<b>X.600-X.699</b>
Networking	X.600-X.629
Efficiency	X.630-X.649
Naming, Addressing and Registration	X.650-X.679
Abstract Syntax Notation One (ASN.1)	X.680-X.699
<b>OSI MANAGEMENT</b>	<b>X.700-X.799</b>
Systems Management framework and architecture	X.700-X.709
Management Communication Service and Protocol	X.710-X.719
Structure of Management Information	X.720-X.729
Management functions	X.730-X.799
<b>SECURITY</b>	<b>X.800-X.849</b>
<b>OSI APPLICATIONS</b>	<b>X.850-X.899</b>
Commitment, Concurrency and Recovery	X.850-X.859
Transaction processing	X.860-X.879
Remote operations	X.880-X.899
<b>OPEN DISTRIBUTED PROCESSING</b>	<b>X.900-X.999</b>

*For further details, please refer to ITU-T List of Recommendations.*

## FOREWORD

The ITU-T (Telecommunication Standardization Sector) is a permanent organ of the International Telecommunication Union (ITU). The ITU-T is responsible for studying technical, operating and tariff questions and issuing Recommendations on them with a view to standardizing telecommunications on a worldwide basis.

The World Telecommunication Standardization Conference (WTSC), which meets every four years, establishes the topics for study by the ITU-T Study Groups which, in their turn, produce Recommendations on these topics.

The approval of Recommendations by the Members of the ITU-T is covered by the procedure laid down in WTSC Resolution No. 1 (Helsinki, March 1-12, 1993).

ITU-T Recommendation X.7 was revised by ITU-T Study Group 7 (1993-1996) and was approved under the WTSC Resolution No. 1 procedure on the 5th of October 1996.

---

### NOTE

In this Recommendation, the expression "Administration" is used for conciseness to indicate both a telecommunication administration and a recognized operating agency.

© ITU 1997

All rights reserved. No part of this publication may be reproduced or utilized in any form or by any means, electronic or mechanical, including photocopying and microfilm, without permission in writing from the ITU.

## CONTENTS

	<i>Page</i>
1 Introduction .....	2
2 Scope .....	2
3 Abbreviations .....	3
4 Terminology .....	4
5 Public data transmission services .....	5
6 Optional user facilities .....	19
7 References .....	42

## **SUMMARY**

The new version of this Recommendation takes into account frame relay data transmission service. Access from B-ISDN is included. Concept of port and direct accesses is reflected. Some new definitions are added. The applicability of various optional user facilities is reviewed. The text of this Recommendation is aligned with other new and revised X-Series Recommendations.



## Recommendation X.7

# TECHNICAL CHARACTERISTICS OF DATA TRANSMISSION SERVICES

*(Helsinki, 1993; revised in 1996)*

The ITU-T,

*considering*

- (a) that Recommendation X.1 defines the international user classes of service in Public Data Networks (PDNs) and Integrated Services Digital Networks (ISDNs) and the different categories of access of Data Terminal Equipment (DTE) to public data transmission services;
- (b) that Recommendation X.2 defines the international data transmission services and optional user facilities in PDNs and ISDNs;
- (c) that Recommendations X.3, X.8, X.28 and X.29 define the Packet Assembly/Disassembly (PAD) facility in a PDN;
- (d) that Recommendations X.5, X.38 and X.39 define the Facsimile Packet Assembly/Disassembly (FPAD) facility in a PDN;
- (e) that Recommendation X.6 describes the model for provision of packet multicast services in PDNs;
- (f) that Recommendations X.20, X.20 *bis*, X.21, X.21 *bis*, X.22, X.25, X.30, X.31, X.32 and X.36 specify the detailed procedures applicable to different types of DTE/DCE interfaces on PDNs and ISDNs; that Recommendation X.37 specifies the encapsulation in X.25 packets of various protocols;
- (g) that Recommendations X.60, X.61, X.70, X.71, X.75 and X.76 specify the detailed procedures applicable to call control between two PDNs of the same type and that Recommendation X.75 is also used for interworking between different networks providing packet switched data transmission services;
- (h) that Recommendation X.80 describes the interworking of interexchange signalling systems for circuit switched data services;
- (i) that Recommendation X.81 describes the interworking between an ISDN circuit switched service and a Circuit Switched Public Data Network (CSPDN);
- (j) that Recommendation X.82 describes detailed arrangements for interworking between CSPDNs and Packet Switched Public Data Networks (PSPDNs) based on Recommendation T.70;
- (k) that Recommendation X.92 defines the hypothetical reference connections for public synchronous data networks;
- (l) that Recommendation X.96 defines the call progress signals in PDNs;
- (m) that Recommendation X.110 describes the routing principles for the establishment of circuit switched calls and packet switched calls when interconnecting PDNs;
- (n) that Recommendation X.115 defines the address translation capability in public data networks;
- (o) that Recommendation X.121 specifies the international numbering plan for PDNs, and that Recommendation X.122 specifies the numbering plan interworking between a PSPDN and an ISDN or PSTN;
- (p) that Recommendations X.130 and X.131 define performance parameters and objectives for CSPDNs;
- (q) that Recommendation X.134 specifies portion boundaries and packet layer reference events for defining packet switched performance parameters;
- (r) that Recommendations X.135, X.136 and X.137 specify speed of service, accuracy and dependability, and availability performance values for PDNs when providing international packet switched services;

- (s) that Recommendation X.138 specifies means of measurement of performance values for packet switched data transmission services and Recommendation X.139 defines specific test equipment for making measurements;
- (t) that Recommendation X.140 specifies the user-oriented quality of service parameters for communication via PDNs;
- (u) that Recommendations X.144 and X.145 specify the performance parameters for PDN providing international frame relay data transmission service;
- (v) that Recommendation X.180 describes administrative arrangements for international closed user groups;
- (w) that Recommendation X.181 describes administrative arrangements for the provision of international permanent virtual circuits;
- (x) that Recommendation X.301 defines the general arrangements for call control within a subnetwork and between subnetworks for the provision of data transmission services;
- (y) that Recommendation I.233.1 defines the service involving the transmission of data in the form of frames in ISDN;
- (z) that Recommendation X.328 defines the general arrangements for interworking between PDN providing frame relay data transmission service and ISDN,

*unanimously recommends*

that the technical characteristics of services in public data networks be in accordance with this Recommendation.

## 1 Introduction

The X-Series Recommendations define the wide range of capabilities available in Public Data Networks (PDNs). These capabilities reflect many aspects of using a PDN: available services; user interfaces, including the concepts of *user class of service* and *categories of access*; addressing and routing; performance parameters; status information; optional features that may be available to complement the basic services; and interworking with other networks.

To use the wide range of capabilities of public data networks effectively and efficiently, users need to be well informed. Numerous Recommendations have been developed that define and specify these capabilities. The intent of this Recommendation is to provide a concise, high-level overview of the capabilities available in public data networks and the associated Recommendations in which they are discussed. It is suggested that readers of this Recommendation consult the referenced Recommendations for further details.

## 2 Scope

The scope of this Recommendation is to provide a summary of the family of Recommendations that discuss technical characteristics of data transmission services in public data networks. Technical characteristics include access attributes, interfaces, and quality of service parameters. The X-Series Recommendations within the scope of this Recommendation cover the following:

- services and facilities;
- interfaces;
- transmission, signalling and switching;
- network aspects;
- administrative arrangements; and
- interworking between networks.

In addition to defining the data transmission capabilities available in PDNs as listed above, the X-Series Recommendations specify many other aspects of data communications which are beyond the scope of this Recommendation. These aspects are:

- X.200-Series: Open Systems Interconnection (OSI), including protocol-testing methodology;
- X.400-Series: Message Handling Systems;
- X.500-Series: Directory;



- X.600-Series: OSI Networking and System aspects;
- X.700-Series: OSI Management;
- X.800-Series: OSI Distributed Applications including Security; and
- X.900-Series: Open Distributed Processing.

### 3 Abbreviations

For the purposes of this Recommendation, the following abbreviations are used:

BCUG	Bilateral Closed User Group
BCUGOA	Bilateral Closed User Group with Outgoing Access
CSPDN	Circuit Switched Public Data Network
CUG	Closed User Group
DCE	Data Circuit-Terminating Equipment
DTE	Data Terminal Equipment
EETDN	End-to-End Transit Delay Negotiation
FAX	Facsimile
FPAD	Facsimile Packet Assembly/Disassembly
FRBS	Frame Relaying Bearer Service
FRDTS	Frame Relay Data Transmission Service
FRPDN	Frame Relay Public Data Network
IA	Incoming Access
ICRD	Inter-network Call Redirection and Deflection
ISDN	Integrated Services Digital Network
IWF	InterWorking function
MAP	Multi-Aspect Packet Assembly/Disassembly
MLP	Multilink Procedure
NUI	Network User Identification
OA	Outgoing Access
OSI	Open Systems Interconnection
PAD	Packet Assembly/Disassembly
PDN	Public Data Network
PSDN	Packet Switched Data Network
PSN	Public Switched Network
PSPDN	Packet Switched Public Data Network
PSTN	Public Switched Telephone Network
PVC	Permanent Virtual Circuit
ROA	Recognized Operating Agency
SLP	Single Link Procedure
SVC	Switched Virtual Circuit
TDSAI	Transit Delay Selection and Indication
VC	Virtual Call

## 4 Terminology

The terminology introduced below spans the Recommendations mentioned in clause 2 and listed in clause 7. When the primary source of definition and or usage can be found in a related Recommendation, the source is indicated with a reference after the title.

**4.1 data transmission service:** A data service established and operated by an Administration or a Recognized Operating Agency (ROA) provided by means of a public data network. Four types of data transmission services are identified: circuit switched, packet switched, frame relay and leased circuit.

**4.1.1 circuit switched data transmission service:** A service requiring the establishment of a circuit switched data connection before data can be transferred between Data Terminal Equipment (DTEs).

**4.1.2 packet switched data transmission service:** A service involving the transmission and, if necessary, the assembly and disassembly of data in the form of packets.

**4.1.2.1 virtual circuit:** A virtual circuit is a bidirectional, transparent transmission path through a packet switched network between logical or physical ports of two DTEs. All users' data will be delivered from the packet network in the same order in which they are received by the network. Inherent in the virtual circuit service is the throughput of user data for each direction of transmission – this can be expressed as a *throughput class* or *user information transfer rate*.

**4.1.2.1.1 virtual call:** A service of the packet switched virtual circuit services in which a call set-up procedure and a call clearing procedure will determine a period of communication between two DTEs in which users' data will be transferred in the network in the packet mode of operation.

**4.1.2.1.2 permanent virtual circuit:** A service of the packet switched virtual circuit services in which a permanent association exists between two DTEs which is identical to the data transfer phase of a virtual call. No call set-up or clearing procedure is possible or necessary.

**4.1.2.2 packet assembly/disassembly facility:** A Packet Assembly/Disassembly (PAD) Facility is a facility which offers a start/stop-mode DTE the opportunity to use the packet switched public data network to communicate with another start/stop-mode DTE or a packet-mode DTE<sup>1)</sup>. It has the following functions, among many others:

- assembly of characters into packets;
- disassembly of the user data field of packets into characters;
- handling of virtual call set-up and clearing, resetting and interrupt procedures;
- a mechanism for forwarding packets when proper conditions exist;
- a mechanism for transmitting data characters, including start, stop and parity elements as appropriate to the start/stop-mode DTE.

**4.1.2.3 facsimile packet assembly/disassembly facility:** A Facsimile Packet Assembly/Disassembly (FPAD) Facility is a facility which offers a Group-3 (G3) facsimile equipment the opportunity to use a packet switched public data network to convey facsimile control and image data to another G3 facsimile equipment or to an application DTE. The FPAD also allows an application DTE to establish a connection and to send control and image data to a G3 facsimile equipment.

An FPAD has the following functions, among many others:

- assembly of facsimile image data into packets;
- disassembly of the user data field of packets into facsimile image data;
- handling of virtual call set-up and clearing;
- a mechanism for forwarding packets when proper conditions exist;
- a mechanism for transmitting facsimile image data to the G3 facsimile equipment.

---

<sup>1)</sup> With the inclusion of DTEs that use start/stop framing in Recommendation X.25, the term “packet-mode” DTE is taken to include DTEs that use either synchronous framing or start/stop framing.

**4.1.3 frame relay data transmission service (FRDTS):** A service involving the transmission of data in the form of frames on user interface.

**4.1.3.1 permanent virtual circuit:** A service of the frame relay public data network in which a permanent association exists between the DTEs. No call set-up or clearing procedure is possible or necessary.

**4.1.3.2 switched virtual circuit:** A service of the frame relay public data network in which a call set-up procedure and clearing procedure will determine a period of communication between two DTEs in which user' data will be transferred in the network in the frame mode of operation.

**4.1.4 leased circuit data transmission service:** A service whereby a circuit (or circuits) of a public network is (are) made available to a user or group of users for its exclusive use.

NOTE – Where only two data circuit-terminating equipment are involved, it is known as a point-to-point facility and where more than two are involved, it is known as a multipoint facility.

**4.2 communication service:** A communication service consists of the means of communication between systems, related to functions above a data transmission capability. A communication capability may be defined by ITU-T; it may also be privately defined by users themselves.

**4.3 public data network:** A network established and operated by an Administration or an ROA for the specific purpose of providing data transmission services. Circuit switched, packet switched, frame relay and leased circuit data transmission services are feasible within these networks.

**4.4 user class of service (international):** An international user class of service is a category of public data transmission service in a certain network in which the data signalling rates, call control signalling rates and other parameters are specified with reference to the services, the interfaces, and the DTE operating mode.

**4.5 categories of access:** A DTE can, by various means, access the data transmission services provided by PDNs and ISDNs:

- by a direct access of the DTE to the PDN providing the service without an intermediate public switched network of another type (including a PDN, PSTN or ISDN);
- by a port access from the DTE to a PDN via an intermediate public network of another type (including a PDN, PSTN or ISDN).

**4.6 optional user facility:** An optional user facility modifies or complements the basic data transmission service. Consequently, it cannot be offered to a user as a stand-alone service. It must be offered together or in association with a data transmission service. An optional user facility may be applicable to a number of data transmission services.

**4.7 call progress signals:** Call progress signals provide information relating to the ability to use the data transmission service or the ability to progress a new or existing call.

## 5 Public data transmission services

This clause identifies public data networks and ISDNs considered in this Recommendation for the provision of data transmission services and the associated CCITT Recommendations describing their technical characteristics. The data transmission services are as follows:

- circuit switched data transmission service;
- packet switched data transmission service;
- frame relay data transmission service; and
- leased circuit data transmission service.

Figures 1 and 2 depict various networks that provide data transmission services discussed in this Recommendation.

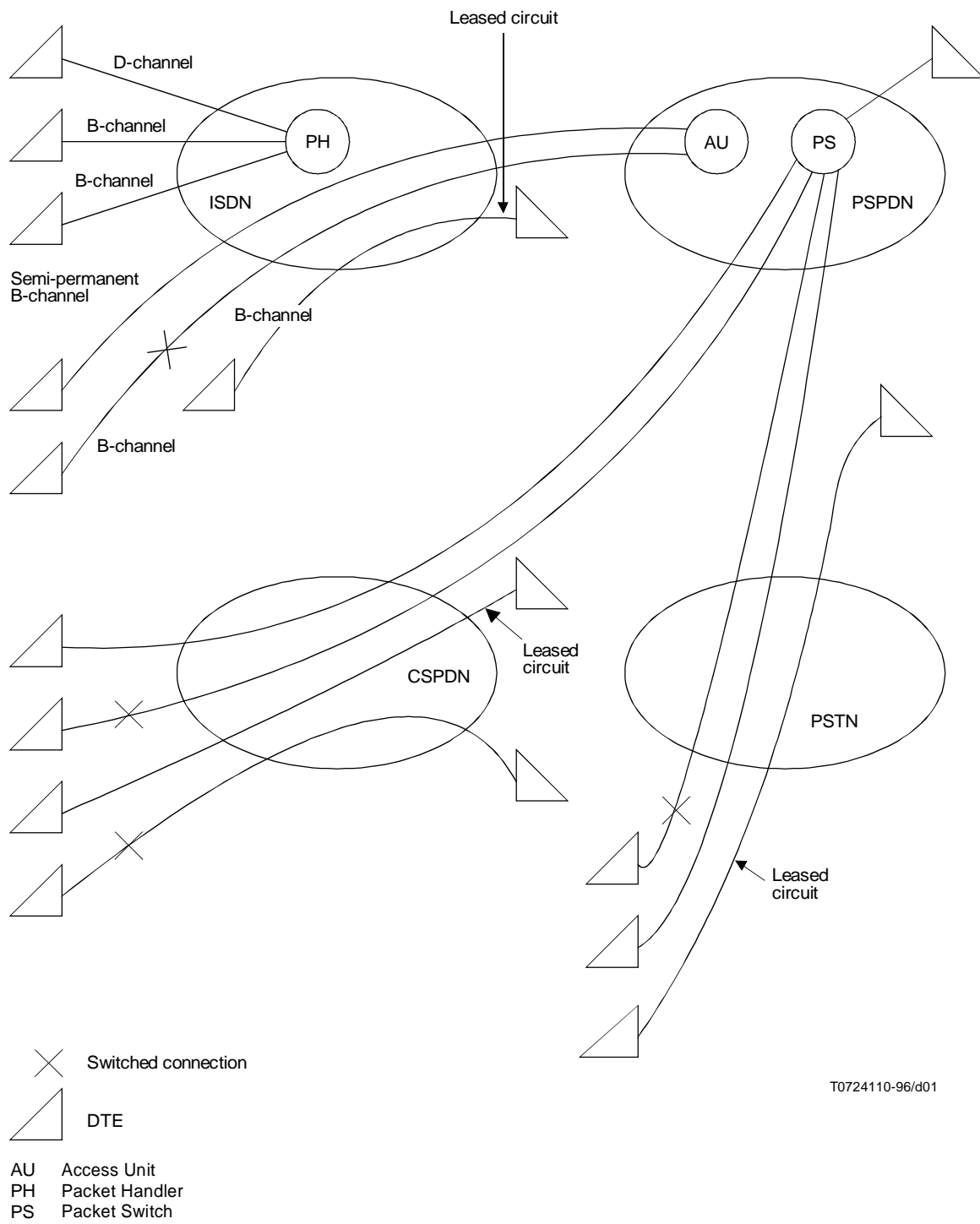

NOTES

- 1 Other methods of access to data transmission services, such as ISDN H-channels and other leased circuit arrangements, are also possible.
- 2 PADs not shown.

FIGURE 1/X.7

Various networks providing circuit switched, packet switched and leased circuit data transmission services

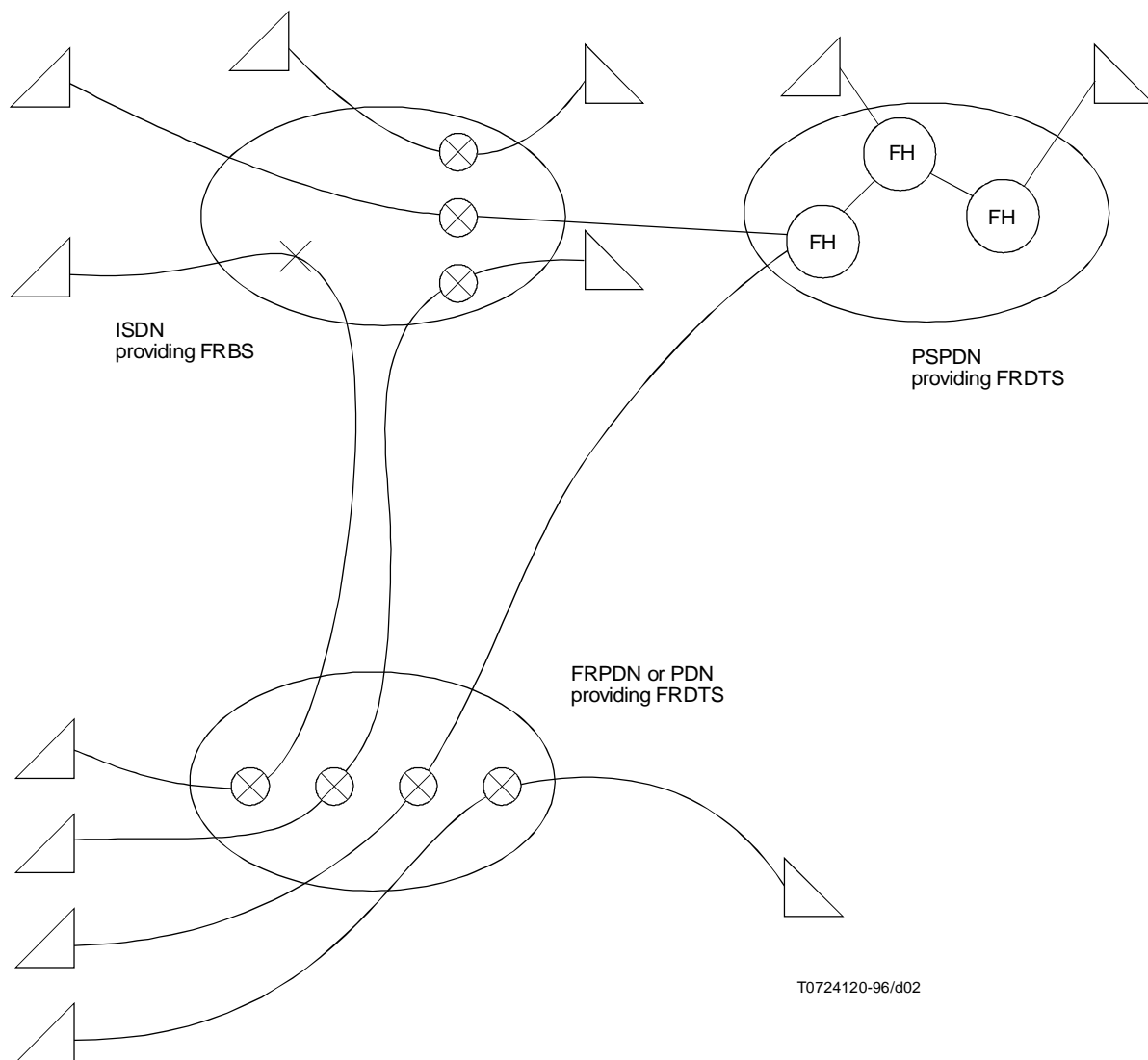

T0724120-96/d02

- ⊗ Switched connection
- △ DTE
- ⊗ Frame relay connection
- FH Frame handler

FIGURE 2/X.7  
**Various networks providing Frame Relay Data Transmission Service (FRDTS)  
 and Frame Relaying Bearer Service (FRBS)**

## 5.1 General aspects of data transmission services

### 5.1.1 Access attributes

Recommendation X.1 describes user classes of service for data transmission services for Data Terminal Equipment (DTEs) operating in start/stop-mode and for DTEs operating in synchronous-mode. It also describes different categories of access for DTEs accessing various data transmission services.

The data transmission services and optional user facilities offered by public data networks are described in Recommendation X.2. It also describes which optional user facilities are available with each data transmission service on an international basis. Some of the optional user facilities are available on a per-call basis and others may be assigned for an agreed contractual period. Recommendation X.2 also discusses DTE services and identification methods when accessing a packet switched data transmission service through a switched connection.

User services and optional user facilities are further categorized as “E” (for essential) or “A” (for additional). An essential user facility or service should be made available internationally. An additional user facility or service may be available in certain PDNs and may also be available internationally. It must be noted that not all user facilities are available for all user classes of service or categories of access.

### 5.1.2 Addressing and routing aspects

Recommendation X.121 describes the International Numbering Plan for PDNs. That Recommendation makes provisions to identify a DTE by an International Data Number of up to 14 digits. An International Data Number can be represented in one of two formats as shown in Figure 3.

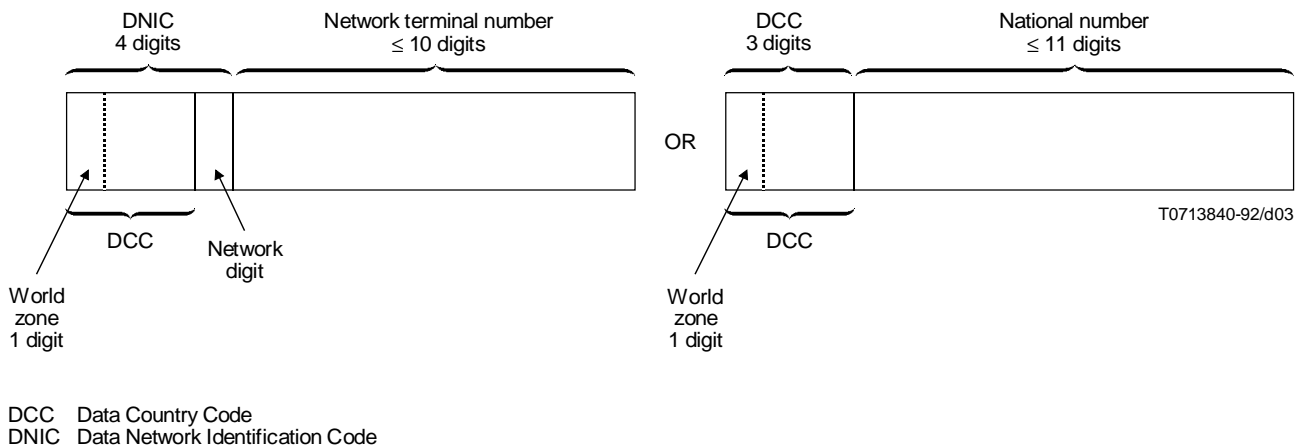

FIGURE 3/X.7  
International data number X.121 format

In both cases depicted in Figure 3, the first three digits identify a country and are known as a Data Country Code (DCC). The first digit of the DCC identifies the world zone and is a single digit in the range of 2-7 (e.g. 3 represents North America). DCCs are assigned by ITU-T and are recorded in Annex D/X.121. The fourth digit, when used to indicate a specific data network in a country, in conjunction with the DCC together are known as a Data Network Identification Code (DNIC). In this case, the remaining ten digits are used as a network terminal number. Alternatively, when the fourth digit is not used to identify a network, the digits after the DCC are used as a national number.

The first digit of the International Data Number outside of the 2-7 range is used to indicate special cases, e.g. DNICs assigned to public mobile satellite systems.

Provision is also made for DTEs to be identified by numbers from other numbering plans (i.e. E.163/E.164 and F.69). Recommendation X.121 makes allowance for these plans to be identified in address signals carried in PDNs. This is accomplished by defining an *escape digit* to be inserted before the first digit of the non-X.121 number.

Provision is also made for the use of *prefixes* to allow for selection of different types of address formats. Prefixes are not part of the international X.121 format and are not signalled from one network to another.

Recommendation X.122 defines the numbering plan interworking between PSPDNs and ISDNs or PSTNs. It illustrates how addresses are carried from one network to another.

Specific aspects of addressing relative to the different data transmission services and use of optional user facilities are discussed below.

Recommendation X.110 specifies the routing principles that should be applied for the establishment of circuit switched calls or packet switched virtual calls when interconnecting PDNs.

### **5.1.3 Performance aspects**

Recommendation X.92 defines five hypothetical *reference connections* for circuit switched, packet switched and leased circuit services in public synchronous data networks. Reference connections provide a basis for assessing the overall customer-to-customer performance objectives, for determining data characteristics requirements of the various items in the connections, and for setting limits to the impairments these may introduce.

Recommendation X.140 defines a set of general quality of service parameters for public data networks. The parameters defined are independent of application, network, and service. These parameters can be applied to circuit switched and packet switched data transmission services.

### **5.1.4 Call progress signals**

Recommendation X.96 categorizes and defines call progress signals. Call progress signals are transmitted from the DCE to the calling DTE to indicate the progress made in the establishment of the call or the reason why the connection could not be established or any other network condition. Additionally, in a packet switched service, call progress signals are also transmitted during the data transfer phase to indicate:

- if a problem is detected at a DTE/DCE interface which may have an effect on data integrity;
- for virtual call service, to the calling and called DTEs when the call is reset or cleared after having been established;
- for permanent virtual circuit service, to both DTEs when the permanent virtual circuit is reset.

By noting the category of a call progress signal, a DTE can determine the reason for the signal and what further action, if any, is warranted. For example, one category of call progress signal indicates that a call has been cleared due to conditions of a temporary nature. In this case, the DTE may try to establish the call again after a suitable delay.

NOTE – Use of the call progress signals in frame relay public data networks is for further study.

### **5.1.5 Interworking aspects**

As mentioned above, there are four services provided by PDNs: circuit switched, packet switched, frame relay and leased circuit. Additionally, ISDNs can also provide these services. The interworking of two networks (PDNs and ISDNs) that provide the same or different data transmission service is discussed in the X.300-Series Recommendations. Detailed procedures for various cases of interworking are discussed in Recommendations X.60, X.61, X.70, X.71, X.75, X.76, X.80, X.81 and X.82.

## 5.2 Technical characteristics of circuit switched data transmission services

This subclause summarizes additional features available to the users of circuit switched data transmission services and the Recommendations that discuss these features. Figure 4 provides a graphical representation of relevant Recommendations for the provision of circuit switched data transmission services.

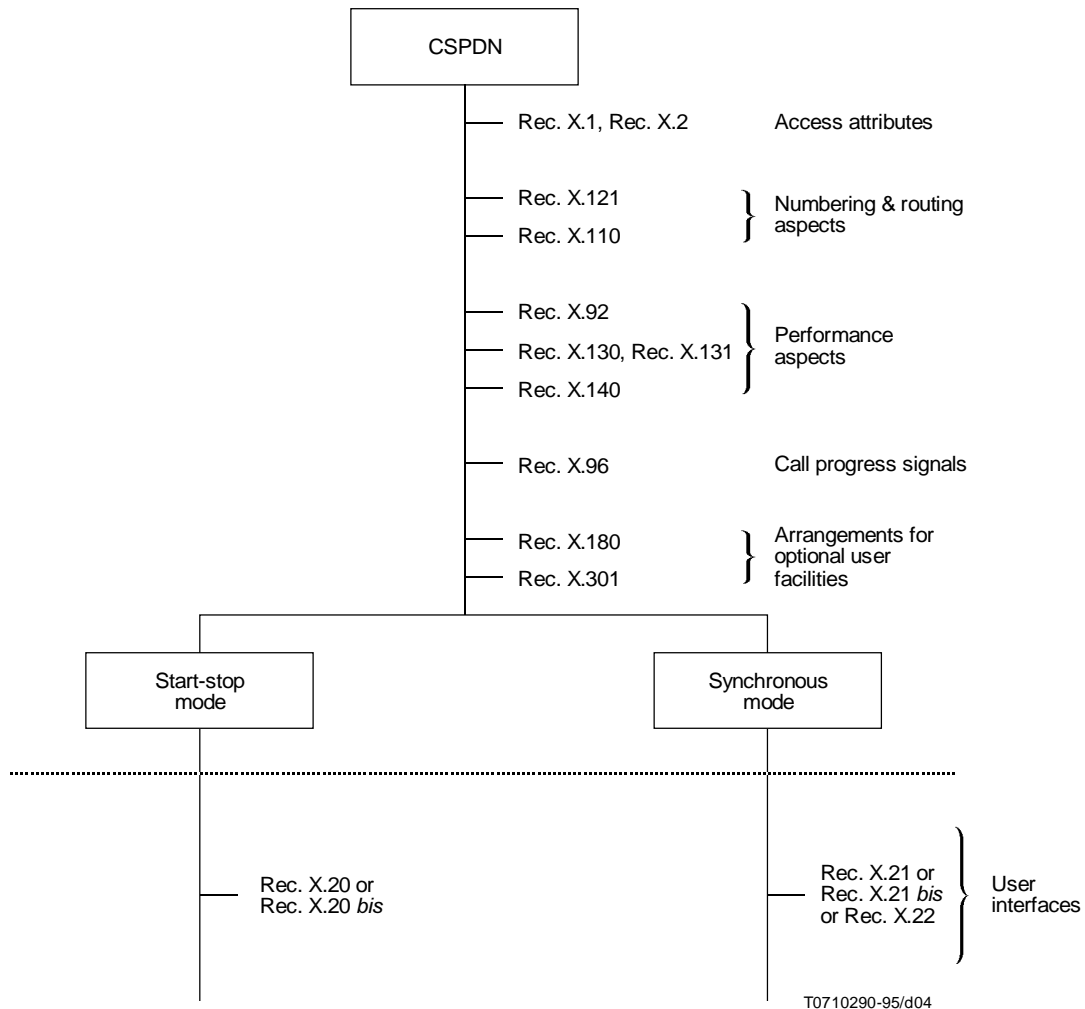

FIGURE 4/X.7

### X-Series Recommendations discussing technical characteristics of circuit switched data transmission services in CSPDNs

#### 5.2.1 User interfaces

Various DTE/DCE interfaces have been specified for accessing data transmission services provided by CSPDNs. These are described in Recommendations X.20, X.20 *bis*, X.21, X.21 *bis*, and X.22. These Recommendations are briefly discussed in this subclause. Figure 5 provides a graphical representation of various accessing mechanisms.

Recommendation X.21 defines the physical characteristics and call control procedures for a general purpose interface between a DTE and a DCE for synchronous operation on PDNs. The formats and procedures for selection, call progress and DCE-provided information for operation on CSPDNs are also included in Recommendation X.21.



Recommendation X.21 *bis* specifies the connection of DTEs designed for interfacing to synchronous V-Series modems for use on public data networks. It also specifies the operational modes and optional features which apply when V-Series DTEs are used on CSPDNs.

Recommendation X.20 defines the physical characteristics and call control procedures for a general purpose interface between DTE and DCE for user classes of service, as defined in Recommendation X.1, employing start/stop transmission. The formats and procedures for selection, call progress and DCE-provided information are also included in Recommendation X.20.

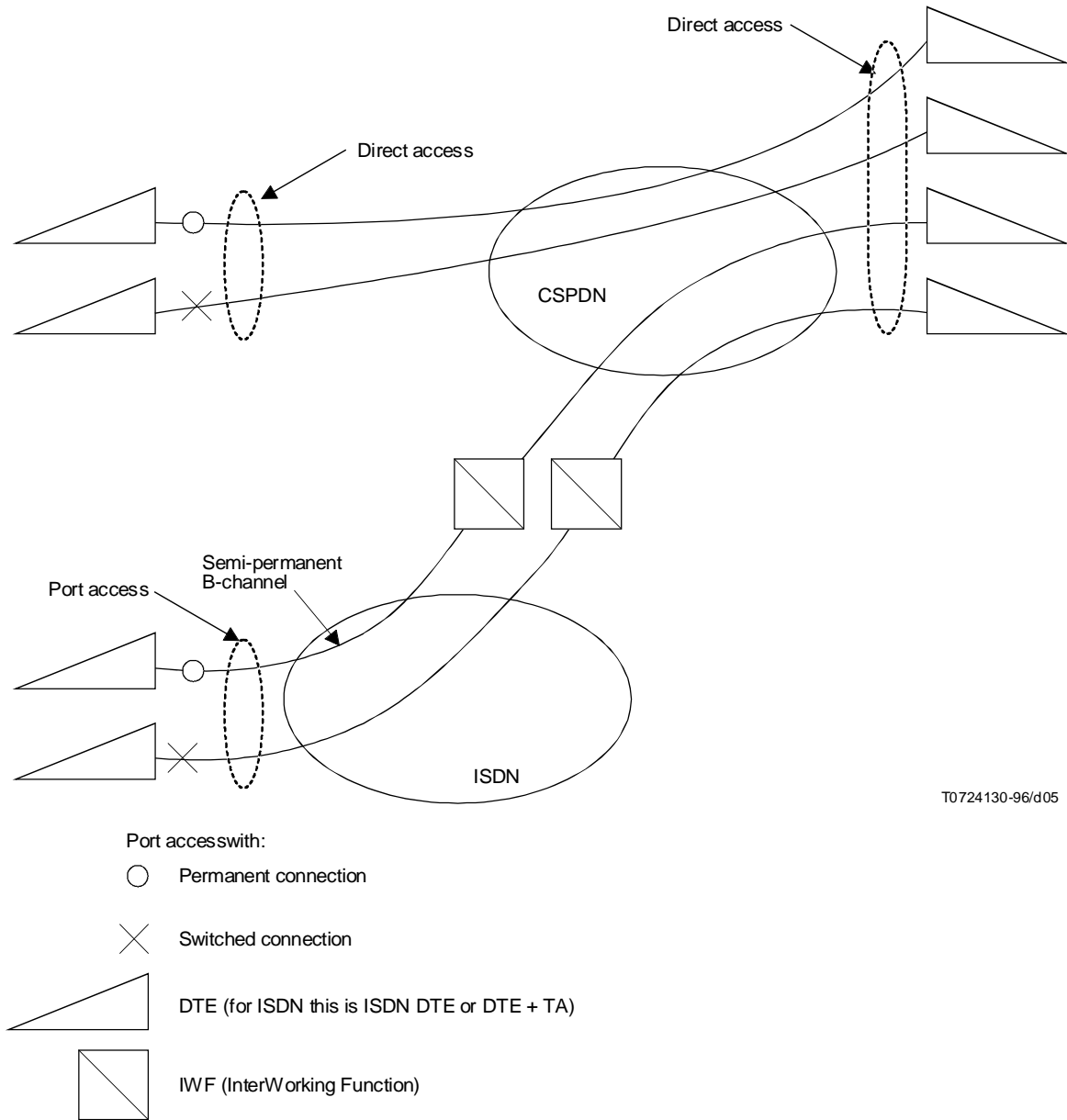

T0724130-96/d05

FIGURE 5/X.7

**Access mechanisms for circuit switched data transmission services provided by CSPDN**

Recommendation X.20 *bis* recommends the connection of start/stop-mode DTEs designed for interfacing to asynchronous V-Series modems for start/stop transmission on CSPDNs. The operation is limited to data signalling rates and character structures specified for start/stop transmission in Recommendation X.1.

Recommendation X.22 defines the interface between a DTE and a multiplex DCE, operating at 48 000 bit/s and multiplexing a number of Recommendation X.21 subscriber channels employing synchronous transmission.

Recommendation X.30/I.461 describes the support of X.21, X.21 *bis* and X.20 *bis* based DTEs by an ISDN. It also discusses the functions of a terminal adaptor to support X.21, X.21 *bis* and X.20 *bis* based DTEs.

### 5.2.2 Quality of Service

Quality of Service in CSPDNs has been considered in the following five basic areas:

- call processing delays;
- failures due to congestion (blocking);
- failures due to malfunction;
- loss of service;
- transmission performance (including throughput).

Recommendation X.130 specifies the objectives for call processing delays.

Recommendation X.131 specifies the objectives for call blocking when providing international synchronous circuit switched data transmission services.

## 5.3 Technical characteristics of packet switched data transmission services provided by PSPDN or ISDN

This subclause summarizes additional features available to the users of packet switched data transmission services and the Recommendations that discuss these features. These services are offered by PSPDNs and include the Virtual Call (VC) service and the Permanent Virtual Circuit (PVC) service (the administrative procedures associated with the establishment of international PVCs in PSPDNs are specified in Recommendation X.181). A PSPDN may also offer PAD/FPAD service. Figure 6 provides a graphical representation of relevant Recommendations for the provision of packet switched data transmission services. Similarly, Figure 7 provides a graphical representation of applicable Recommendations when packet switched data transmission service is offered by an ISDN.

### 5.3.1 User interfaces

Various DTE/DCE interfaces have been specified for accessing data transmission services provided by PSPDNs. For packet-mode operations, these are described in Recommendations X.21, X.21 *bis*, X.22, X.25, X.31 and X.32. The packet-mode interfaces support synchronous and, optionally, start/stop framing. The DTE/DCE interface for a start/stop-mode DTE operating in start/stop mode and accessing the PAD facility is specified in Recommendation X.28. In addition, the interface for a G3 facsimile equipment accessing the FPAD facility is specified in Recommendation X.38. Figure 8 provides a graphical representation of various accessing mechanisms.

Recommendations specifying various DTE/DCE interfaces are summarized in this subclause.

Recommendation X.25 specifies the interface between DTE and DCE for terminals operating in the packet-mode on PDNs and connected by dedicated circuit. Recommendation X.25 describes the procedures for the Physical Layer, Data Link Layer and Packet Layer. It also describes the packet formats, procedures for optional user facilities, and formats for facility fields and registration formats.

Recommendation X.21 defines the physical characteristics and call control procedures for a general purpose interface between a DTE and a DCE for synchronous operation on public data networks. The formats and procedures for selection, call progress and DCE-provided information are also included in Recommendation X.21.

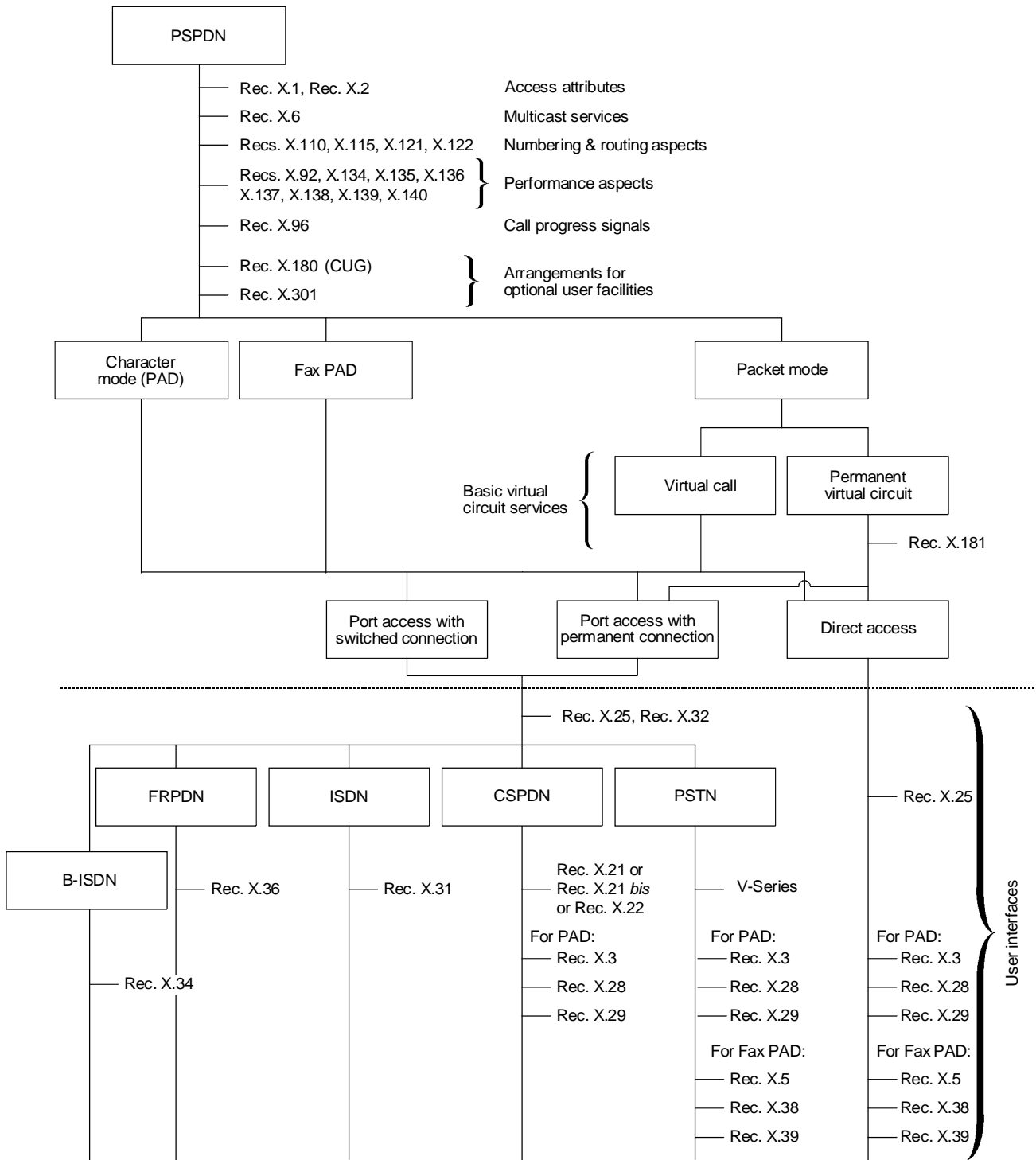

T0724140-96/d06

FIGURE 6/X.7  
**X-Series Recommendations discussing technical characteristics  
of packet switched data transmission services in PSPDNs**

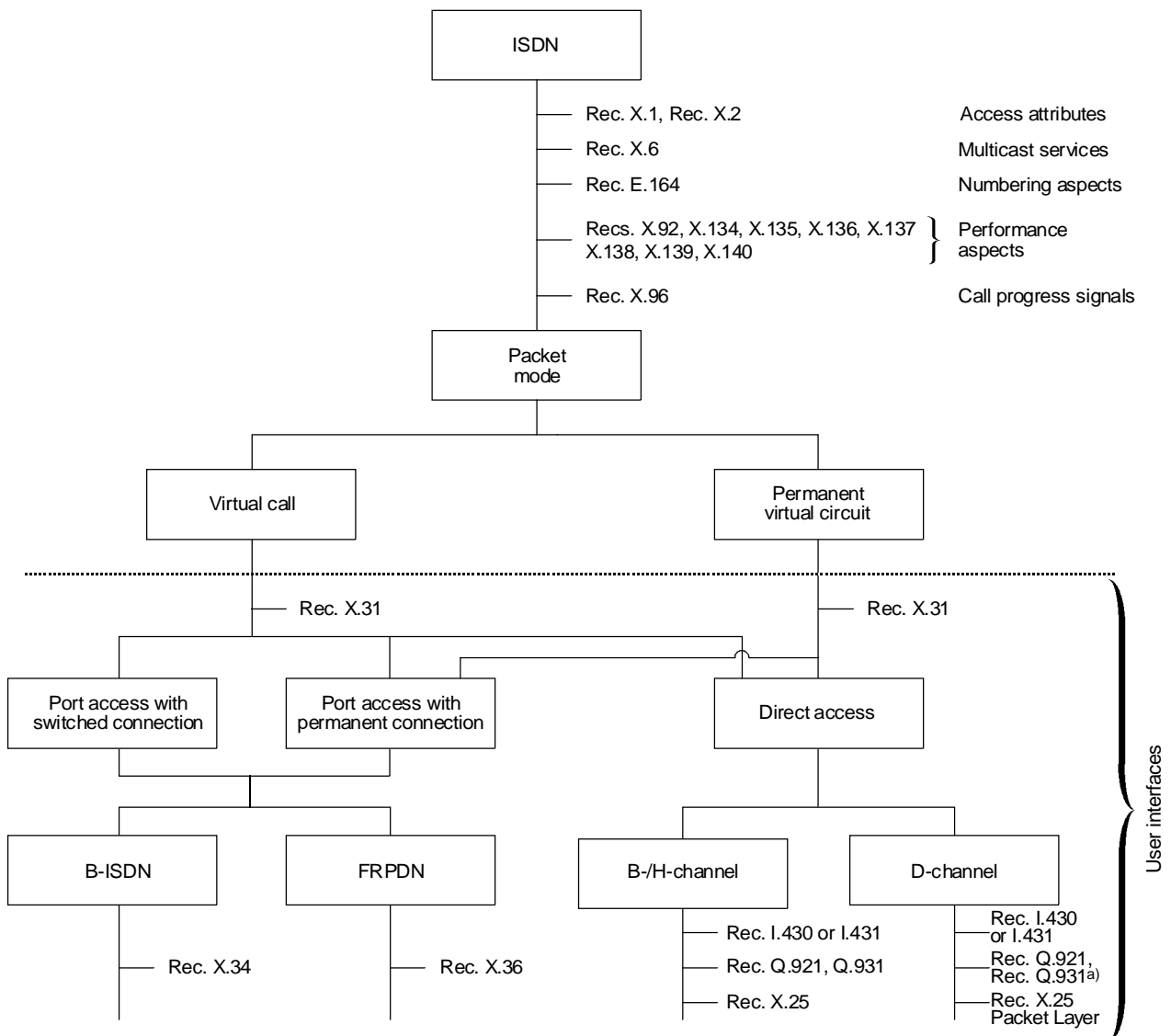

<sup>a)</sup> May be used for call offering depending on notification class.

T0724150-96/d07

FIGURE 7/X.7  
**Recommendations discussing technical characteristics  
of packet switched data transmission services in ISDNs**

Recommendation X.21 *bis* specifies the connection of DTEs designed for interfacing to synchronous V-Series modems for use on public data networks. It also specifies the operational modes and optional features which apply when V-Series DTEs are used on PDNs.

Recommendation X.22 defines the interface between a DTE and a multiplex DCE, operating at 48 000 bit/s and multiplexing a number of Recommendation X.21 subscriber channels employing synchronous transmission.

Recommendation X.31 defines the aspects of the packet-mode services provided to the ISDN users in accordance with the bearer services defined in I-Series Recommendations. It also discusses the procedures at the ISDN user-network interface for accessing packet-mode services in alignment with Recommendations I.430, I.431, Q.921 and Q.931. Recommendation X.31 defines two cases for the provision of packet-mode services. *Case A* provides for an access to a packet handling function in a PSPDN. *Case B* deals with packet-mode services provided by an ISDN. In addition, it discusses the functions of Terminal Adaptors for adapting existing X.25 terminals.

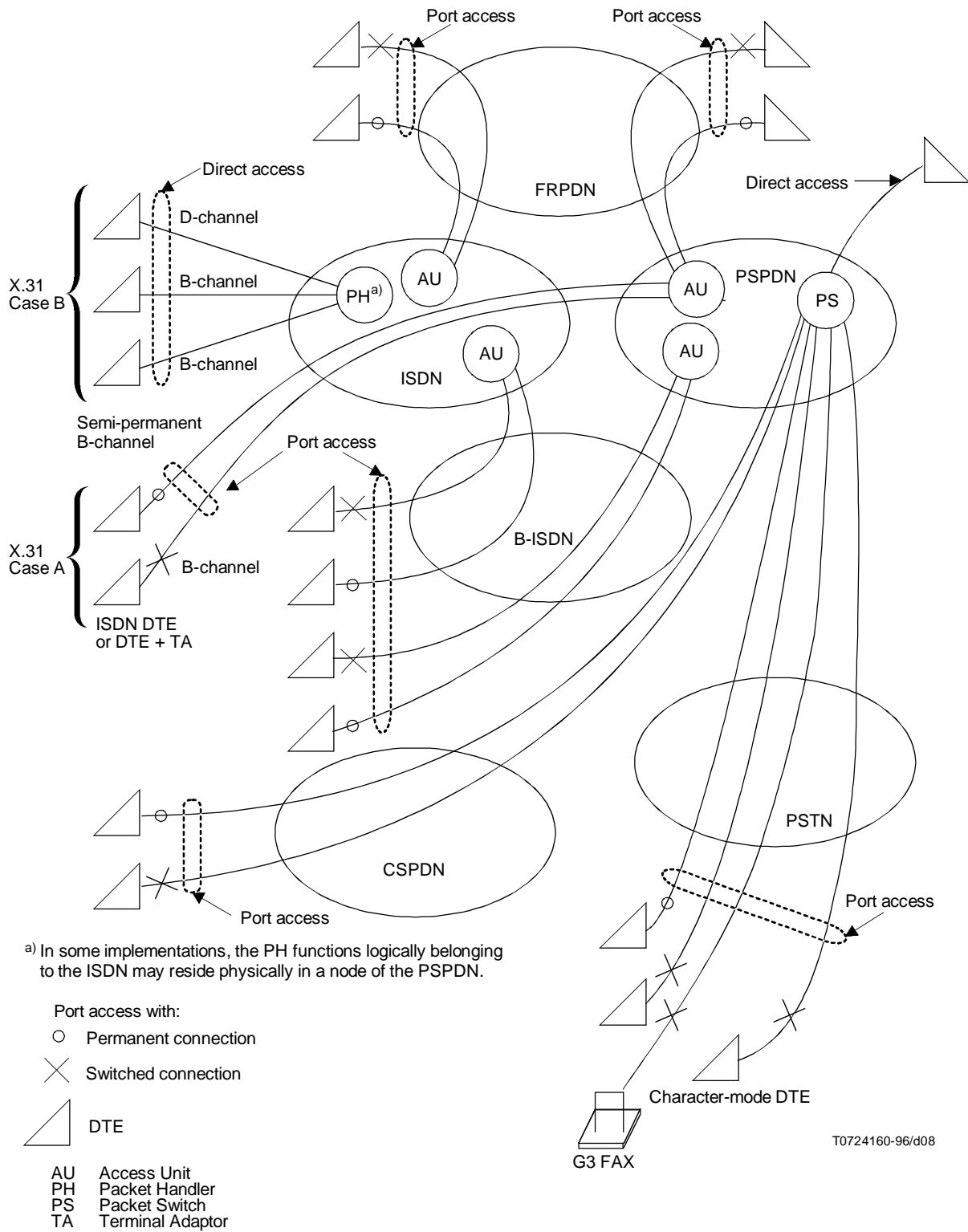

**NOTES**

- 1 Direct access to PSPDN specified in Recommendation X.25.
- 2 Port access to PSPDN specified in Recommendation X.32.
- 3 PSPDN access through PAD and FPAD specified in Recommendations X.28 and X.38 respectively, may be through PSTN or ISDN or FRPDN.

**FIGURE 8/X.7**  
**Access mechanisms for packet switched data transmission services provided by PSPDN or ISDN**

Recommendation X.28 specifies the DTE/DCE interface for a start/stop-mode DTE accessing the PAD facility in a PSPDN situated in the same country. It also discusses the procedures for the establishment of an access path between a start/stop-mode DTE and a PAD, character interchange and service initialization, exchange of control information, and exchange of user data. The operation of the PAD is specified in Recommendation X.3.

Recommendation X.37 defines the encapsulation in X.25 packets of various protocols including frame relay and Local Area Network protocols. It specifies call set-up, call clearing and data transfer procedures for this mode of network operation. The encapsulation function may also reside inside an X.25 DTE (outside the PSPDN).

Recommendation X.38 specifies the procedures for the establishment of an access path between a G3 facsimile equipment and an FPAD, procedures for service initialization, exchange of control information and exchange of user data. The operation of the FPAD is specified in Recommendation X.5.

### 5.3.1.1 Port access to packet switched data transmission services

DTEs can have port access to data transmission services provided by PSPDNs. When a DTE accesses a PSPDN through a PSN (dial-in-by-the-DTE) or when a DTE is accessed by a PSPDN through a PSN (dial-out-by-the-PSPDN), there may be a requirement for identification of the DTE to the DCE. In addition, when a network supports dial-out-by-the-PSPDN access to DTEs, there may be a requirement for identification of the network (i.e. DCE) to the DTE. Recommendation X.32 describes requirements, in addition to those in Recommendation X.25, for access to/from a PSPDN when using a switched access path. These include various DTE identification and DCE identification methods as well as various DTE services. Three DTE services are specified:

- non-identified;
- identified; and
- customized.

The service offered to an unidentified DTE is called *non-identified DTE service*. In the non-identified DTE service, the DTE:

- is not required to use any optional procedures;
- is able to operate with different networks without subscribing to any of them;
- is not permitted to make paid calls or receive reverse charge calls.

The services offered to *identified DTEs* provide a set of capabilities/facilities different from and/or enhanced beyond the non-identified DTE service. In addition, the DTE can make calls for which it assumes responsibility for all charges as well as receive reverse charge calls.

The services offered to *customized DTEs* provide a much richer set of capabilities/facilities and, in many cases, can provide a service tailored to its requirements. This is possible because the DTE identity is explicitly agreed to with the Administration (or ROA).

### 5.3.2 Multicast operations

PSPDNs may offer a multicast service, in which a single data unit transmitted by a source is received by multiple destinations. Recommendation X.6 describes the capabilities of a connection-oriented multicast service. A user establishes a connection (virtual call or permanent virtual circuit) to a logical entity, called the multicast server, before it is able to send or receive multicast data. The multicast server may be a single entity or a distributed entity, and may reside inside or outside a network. The server (or servers when distributed) may be on the same network as the members accessing it or on different networks. An example of a multicast server implementation is shown in Figure 9.

The multicast service may require an inter-networking capability to allow multicast servers on separate networks to communicate with each other. The server-to-server communication is provided in such a manner that the individual members perceive the service as being provided by a single multicast server logical entity.

PSPDNs may use the existing protocols (e.g. Recommendation X.25, Recommendation X.28) with no modifications to provide a basic multicast service which supports a subset of the capabilities specified in Recommendation X.6 (see Recommendation X.48). The full set of Recommendation X.6 multicast capabilities may be provided by PSPDNs by using extensions to the existing protocols (see Recommendation X.49).

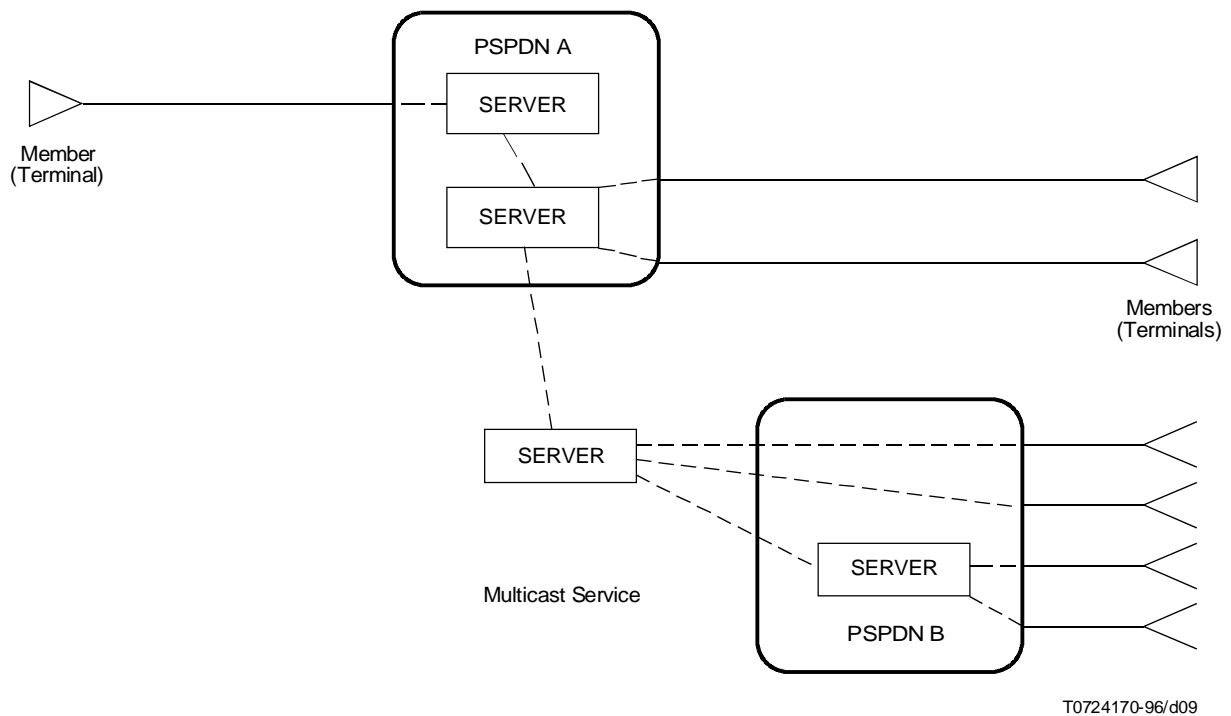

FIGURE 9/X.7  
**Example of multicast server implementation**

The multicast service specified in Recommendation X.6 may be used by a broad range of applications. Some examples are the following:

- News service – A news service provides continuous updates on current stories. There is a single feed of information and no feedback is allowed from the subscribers to the service. The PSPDNs could provide this application by using capabilities specified in Recommendation X.6. One-way data transfer with a single sender would be needed. A call is established and subscribers join and leave as they wish. The sender passes data into the call continuously.
- Distributed data base – A distributed data base may have multiple partitions across multiple systems in multiple locations. An example of this application is the OSI Network Layer Routing Information Base (RIB). PSPDNs could implement this capability by using services specified in Recommendation X.6. N-way data transfer would be required. The routing tables would all participate as peers in a call, with any updates passed among all them.
- Real-time Simulation – A number of simulators may participate in a training exercise. Protocol Data Units (PDUs) are used to simulate the exchange of actual exercise objects among the training sites. A multicast server replicates a PDU sent by a participant simulator and transmits the copies to all members of the exercise. PSPDNs could support this application by using capabilities specified in Recommendation X.6. N-way data transfer would be required. The simulators would all participate as peers in a multicast call.

### 5.3.3 Addressing

When the virtual call service is used, each DTE receives addressing information that identifies the other DTE. That is, the called DTE receives the identity of the calling DTE while the calling DTE is informed of the identity of the called DTE to which it is connected. Some exceptions occur when a DTE is accessed through a PSN (see Recommendation X.32).

As mentioned in 5.1.2, Recommendation X.121 defines the numbering plan to be used in PSPDNs. When the PSPDN does not use all ten digits of the Network Terminal Number (NTN), some PSPDNs may allow the remaining digits to be used by DTEs as a *complementary address*. Further description of complementary addresses is given in Appendix IV/X.25.

A PSPDN allows the customers to use the address formats described in Recommendation X.121, or in Recommendation E.164, or an alternative address formats. A PSPDN can provide a service (Address Translation Service) that enables a network to route calls to X.121/E.164 address when the called address is not specified by an X.121/E.164 address format. Address Translation Service is defined in Recommendation X.115.

Address translation capability requires the usage of Address Resolution Entity (ARE), which performs the functions of address translation. ARE may be on the same network as the DTE accessing or in different networks. In some cases distributed ARE may be used.

### **5.3.4 Performance parameters**

Various service parameters have been defined and values identified for international packet switched data transmission services. In order to measure the performance of packet switched data transmission services with the values identified, it is necessary to divide a virtual circuit into basic sections. The performance of collections of these basic sections can be measured using the packet switched performance parameters defined in Recommendations X.135 through X.137.

Recommendation X.134 specifies how to divide a virtual circuit into basic sections whose boundaries are associated with X.25 and X.75 interfaces. Recommendation X.134 is also used in apportioning the performance of an international packet switched data transmission service. It also specifies packet layer reference events that are to be used in the definition of packet switched performance parameters for data communications services provided in accordance with Recommendations X.25 and X.75.

Recommendation X.135 defines five speed of service parameters: one access parameter (call set-up delay), two user information transfer parameters (data packet transfer delay and throughput capacity), and two disengagement parameters (clear indication delay and clear confirmation delay). These parameters can be applied to any basic section or portion of a virtual circuit.

Recommendation X.136 defines accuracy and dependability parameters which can be used in the planning and operation of international packet switched data transmission services provided in accordance with Recommendations X.25 and X.75. Eight such parameters are defined: two access parameters, five user information transfer parameters, and two disengagement parameters.

Recommendation X.137 defines availability parameters which can be used in the planning and operation of international packet switched data transmission services provided in accordance with Recommendations X.25 and X.75. Recommendation X.137 defines two availability parameters: service availability and mean time between service outages.

Recommendation X.138 defines means of measurement of performance values for packet switched data transmission services including calculation of network performance statistics.

Recommendation X.139 defines specific test equipment for making measurements.

### **5.3.5 Interworking with private X.25 networks**

A PSPDN and a private PSDN may elect to interwork based upon X.25 procedures. There are two options available when this type of interworking is undertaken. The first of these uses Recommendation X.25 without any modifications. It has the roles assumed by the public and private networks corresponding to DCE for the PSPDN and DTE for the private PSDN respectively, with the interworking function residing in the private PSDN. The second option is based on modified X.25 procedures and specifies a gateway function that is provided in the PSPDN.

This option discussed in Recommendation X.35 permits private networks to create a Virtual Private Network across the PSPDN resources. Users in such Virtual Private Network may have optional user facilities which are not used in the private network itself.



## **5.4 Technical characteristics of frame relay data transmission services provided by FRPDN**

This subclause summarizes additional features available to the users of frame relay data transmission services and the Recommendations that discuss these features. These services are offered by PDN (including PSPDN) and ISDN. Figure 10 provides a graphic representation of relevant Recommendations for the provision of frame relay data transmission services in the dedicated networks (PDN including PSPDN). These networks called Frame Relay Public Data Networks (FRPDNs) are represented in Figure 10.

NOTE – Services provided by an ISDN Frame Relaying Bearer Service (FRBS) are the responsibility of Study Group 13.

### **5.4.1 User interfaces**

Various DTE/DCE interfaces have been specified for accessing for accessing frame relay data transmission services provided by PDN or ISDN. These are described in Recommendations X.36 for PDN and I.430, I.431, Q.921, Q.922, Q.933 for ISDN. Figure 11 provides a graphic representation of various accessing mechanisms.

Recommendations specifying various DTE/DCE interfaces for PDN are summarized in this subclause.

Recommendation X.36 specifies the interface between DTE and DCE for PDN providing frame relay data transmission service connected by the dedicated circuit. Recommendation X.36 describes the procedures for the Physical Layer and data Link Layer. It also describes the frame formats and service parameters.

### **5.4.2 Quality of Service**

Various service parameters have been defined for data networks providing frame relay data transmission service.

Recommendation X.144 defines speed, accuracy, dependability and availability parameters for frame relay Permanent Virtual Circuit (PVC) service.

Recommendation X.145 defines speed, accuracy, dependability and availability parameters for frame relay Switched Virtual Circuit (SVC) service.

## **6 Optional user facilities**

This clause briefly describes optional user facilities available to users on PDNs and ISDNs when providing data transmission services. These optional user facilities can be grouped into the following categories:

- data transfer related facilities;
- facilities to convey user data other than during the data transfer phase;
- addressing related facilities;
- routing related facilities;
- charging related facilities;
- protection related facilities; and
- other optional capabilities/facilities.

Table 1 contains the summary of these optional user facilities and their availability in different services. Not all optional user facilities are available for each user class of service associated with each data transmission service (e.g. in the packet switched data transmission service, some optional user facilities apply to the user classes of service associated with start/stop-mode DTEs, some to packet mode DTEs and others to both). In addition, within the packet switched data transmission service, not all facilities are available for PVCs.

The procedures and encoding for these optional user facilities for CSPDNs and PSPDNs are described in Recommendations X.20, X.21, X.25, X.28, X.32 and X.38.

The procedures and encoding for these optional user facilities for FRPDNs are described in Recommendation X.36.

Additional capabilities provided by multicast services are defined in Recommendations X.6, X.48 and X.49.

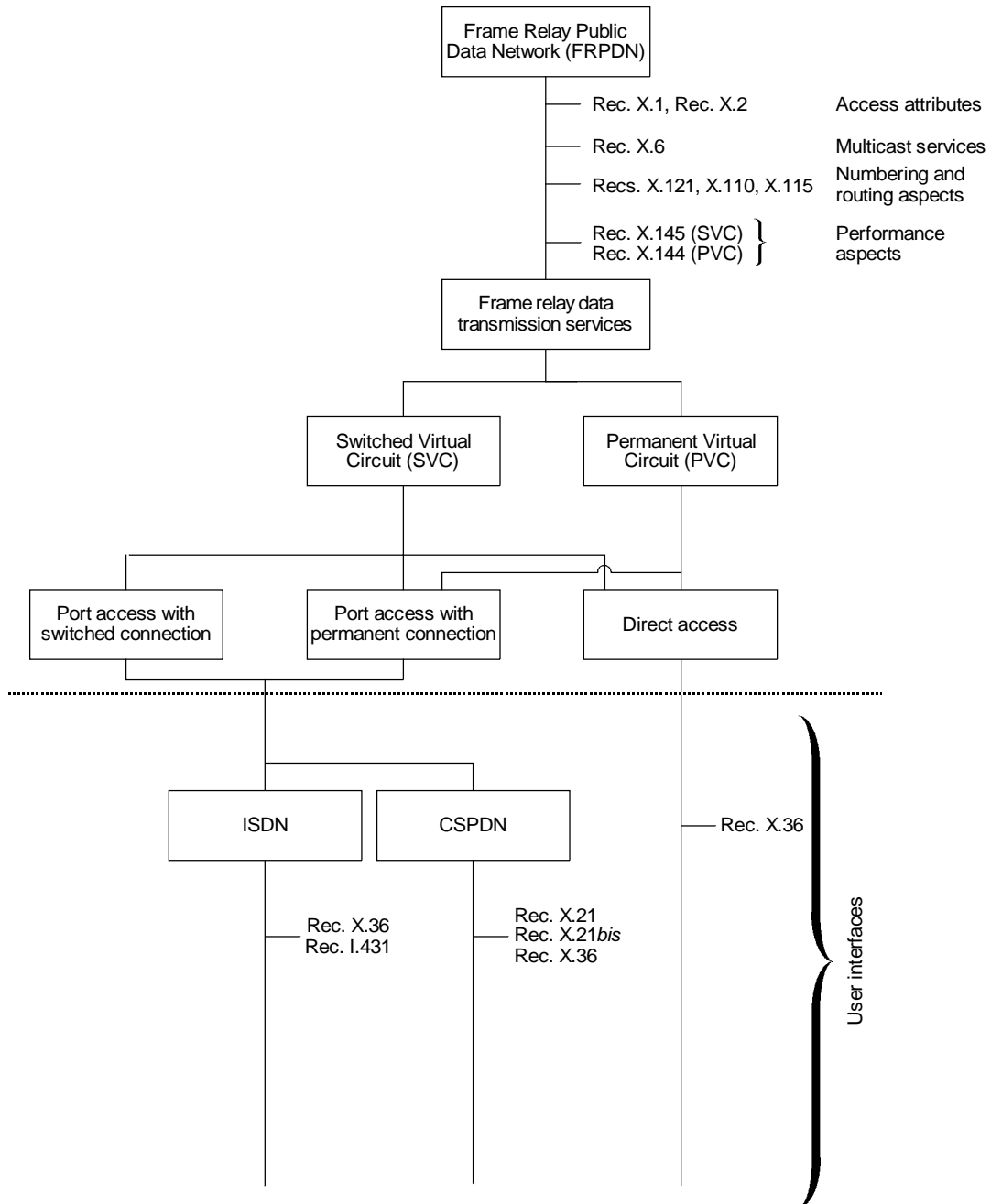

T0724180-96/d10

FIGURE 10/X.7

**Recommendations discussing technical characteristics of frame relay data transmission services in FRPDN**

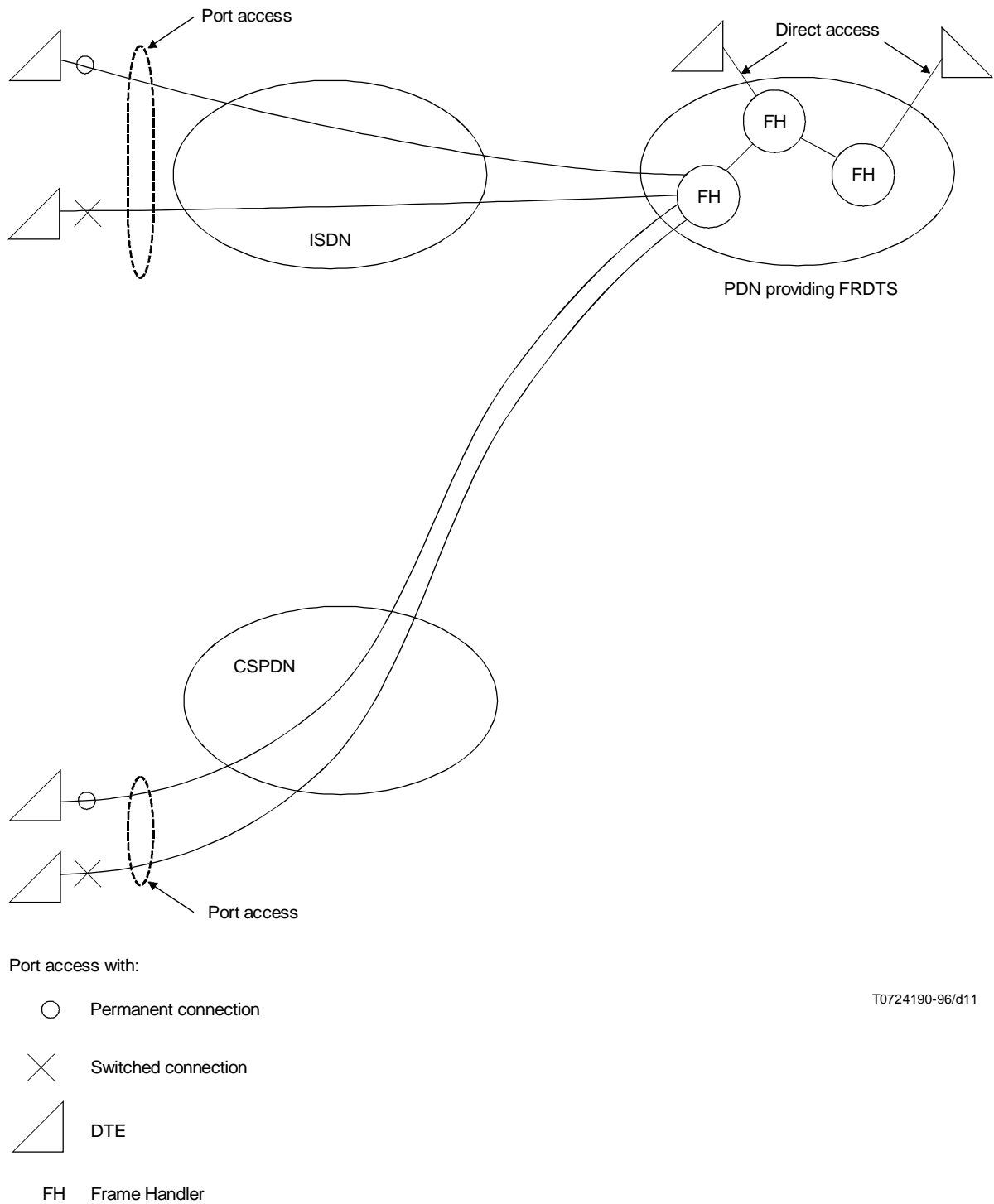

T0724190-96/d11

FIGURE 11/X.7  
Access mechanisms for frame relay data transmission services

TABLE 1/X.7 (1 of 4)

**Optional user facilities**

Optional user facilities	Arrangements for use				Availability with service <sup>a)</sup>			
	Subscription only	Dynamic invocation	Subscription followed by dynamic invocation	Subscription or dynamic invocation	Circuit switched	Packet switched	Leased Circuit	Frame relay
Data transfer related facilities:								
– Throughput facilities:								
• Default throughput classes assignment	Yes	–	–	–	–	Yes	–	–
• Basic throughput class negotiation	–	–	Yes	–	–	Yes	–	–
• Extended throughput class negotiation	–	–	Yes	–	–	Yes	–	–
• Minimum throughput class negotiation	–	Yes	–	–	–	Yes	–	–
– Flow control parameter facilities:								
• Non-standard default packet sizes	Yes	–	–	–	–	Yes	–	–
• Non-standard default window sizes	Yes	–	–	–	–	Yes	–	–
• Flow control parameter negotiation	–	–	Yes	–	–	Yes	–	–
– Extended packet sequence numbering	–	–	Yes <sup>a)</sup>	–	–	Yes	–	–
– Super-extended packet sequence numbering	–	–	Yes <sup>a)</sup>	–	–	Yes	–	–
– Transit delay facilities:								
• Transit delay selection and indication	–	Yes	–	–	–	Yes	–	–
• End-to-end transit delay negotiation	–	Yes	–	–	–	Yes	–	–

TABLE 1/X.7 (1 of 4 – end)

**Optional user facilities**

Optional user facilities	Arrangements for use				Availability with service <sup>a)</sup>			
	Subscription only	Dynamic invocation	Subscription followed by dynamic invocation	Subscription or dynamic invocation	Circuit switched	Packet switched	Leased Circuit	Frame relay
– D-bit modification	Yes	–	–	–	–	Yes	–	–
– Packet retransmission	–	–	Yes <sup>a)</sup>	–	–	Yes	–	–
– Expedited data negotiation	–	Yes	–	–	–	Yes	–	–
– Priority	–	Yes	–	–	–	Yes	–	–
– Committed burst size	Yes	–	–	–	–	–	–	Yes
– Committed burst size negotiation	–	Yes	–	–	–	–	–	Yes
– Excess burst size	Yes	–	–	–	–	–	–	Yes
– Excess burst size negotiation	–	Yes	–	–	–	–	–	Yes
– Committed information rate	Yes	–	–	–	–	–	–	Yes
– Committed information rate negotiation	–	Yes	–	–	–	–	–	Yes
Facilities to convey user data other than during the data transfer phase								
– Fast select related facilities:								
• Fast select	–	Yes	–	–	–	Yes	–	–
• Fast select acceptance	Yes	–	–	–	–	Yes	–	–
– Addressing related facilities:								
• Address extension	–	Yes	–	–	–	Yes	–	–
• Calling line identification	–	–	Yes <sup>a)</sup>	–	Yes	–	–	–
• Called line identification	–	Yes	–	–	Yes	–	–	–
• Abbreviated address calling	–	–	Yes <sup>a)</sup>	–	Yes	–	–	–

TABLE 1/X.7 (2 of 4)

**Optional user facilities**

Optional user facilities	Arrangements for use				Availability with service <sup>a)</sup>			
	Subscription only	Dynamic invocation	Subscription followed by dynamic invocation	Subscription or dynamic invocation	Circuit switched	Packet switched	Leased Circuit	Frame relay
– Alternative addressing:								
• Global alternative address registration	Yes	–	–	–	–	Yes	–	–
• Interface specific alternative address registration	–	–	Yes <sup>a)</sup>	–	–	Yes	–	–
• Alternative address usage subscription	–	–	Yes <sup>a)</sup>	–	–	Yes	–	–
• Alternative address selection	–	Yes	–	–	–	Yes	–	–
– Direct call	–	–	Yes <sup>a)</sup>	–	Yes	Yes	–	–
– Multi-address calling	–	–	Yes <sup>a)</sup>	–	Yes	–	–	–
– Hung group	Yes	–	–	–	Yes	Yes	–	–
– Called line address modified notification	–	Yes	–	–	–	Yes	–	–
– TOA/NPI address subscription	Yes	–	–	–	–	Yes	–	–
– Extended address field	Yes	–	–	–	–	–	–	Yes
Routing registered facilities								
– Call redirection	Yes	–	–	–	Yes	Yes	–	Yes
– Deflection of calls:								
• Call deflection subscription	–	–	Yes <sup>a)</sup>	–	–	Yes	–	–
• Call deflection selection	–	Yes <sup>c)</sup>	–	–	–	Yes	–	–
– Inter-network Call Redirection and Deflection (ICRD) control:								
• ICRD prevention subscription	Yes	–	–	–	–	Yes	–	–

TABLE 1/X.7 (2 of 4 – end)

**Optional user facilities**

Optional user facilities	Arrangements for use				Availability with service <sup>a)</sup>			
	Subscription only	Dynamic invocation	Subscription followed by dynamic invocation	Subscription or dynamic invocation	Circuit switched	Packet switched	Leased Circuit	Frame relay
• ICRD status selection	–	Yes	–	–	–	Yes	–	–
– Call redirection or call deflection notification	–	Yes	–	–	–	Yes	–	–
– Transit network selection	–	–	Yes	–	–	–	–	Yes
– ROA related facilities:								
• ROA subscription	Yes	–	–	–	–	Yes	–	–
• ROA selection	–	Yes	–	–	Yes	Yes	–	–

TABLE 1/X.7 (3 of 4)

**Optional user facilities**

Optional user facilities	Arrangements for use				Availability with service <sup>a)</sup>			
	Subscription only	Dynamic invocation	Subscription followed by dynamic invocation	Subscription or dynamic invocation	Circuit switched	Packet switched	Leased Circuit	Frame relay
<b>Charging facilities</b>								
– Reverse charging related facilities:								
• Reverse charging	–	Yes	–	–	Yes	Yes	–	–
• Reverse charging acceptance	Yes	–	–	–	Yes	Yes	–	–
• Reverse charging prevention	Yes	–	–	–	Yes	Yes	–	Yes
– Local charging prevention	Yes	–	–	–	–	Yes	–	–
– Network user identification:								
• NUI subscription	–	–	Yes <sup>a)</sup>	–	–	Yes	–	–
• NUI override	–	–	Yes <sup>a)</sup>	–	–	Yes	–	–
• NUI selection	–	Yes <sup>c)</sup>	–	–	–	Yes	–	–
– Charging information	–	–	–	Yes	Yes	Yes	–	Yes
<b>Protection related facilities</b>								
– Incoming calls barred	Yes	–	–	–	Yes	Yes	–	Yes
– Outgoing calls barred	Yes	–	–	–	Yes	Yes	–	Yes
– One-way logical channel incoming	Yes	–	–	–	–	Yes	–	–
– One-way logical channel outgoing	Yes	–	–	–	–	Yes	–	–
<b>Closed user group related facilities</b>								
– Closed user group	–	–	Yes	–	Yes	Yes	–	Yes <sup>d)</sup>
– Closed user group with outgoing access	–	–	Yes <sup>b)</sup>	–	Yes	Yes	–	Yes
– Closed user group with incoming access	–	–	Yes <sup>b)</sup>	–	Yes	Yes	–	Yes



TABLE 1/X.7 (3 of 4 – end)

**Optional user facilities**

Optional user facilities	Arrangements for use				Availability with service <sup>a)</sup>			
	Subscription only	Dynamic invocation	Subscription followed by dynamic invocation	Subscription or dynamic invocation	Circuit switched	Packet switched	Leased Circuit	Frame relay
– Incoming calls barred within a closed user group	Yes	–	–	–	Yes	Yes	–	–
– Outgoing calls barred within a closed user group	Yes	–	–	–	Yes	Yes	–	–
– Closed user group selection	–	Yes <sup>c)</sup>	–	–	Yes	Yes	–	Yes
– Closed user group with outgoing access selection	–	Yes <sup>c)</sup>	–	–	–	Yes	–	Yes
Bilateral closed user group related facilities								
– Bilateral closed user group	–	–	Yes <sup>a)</sup>	–	Yes	Yes	–	–
– Bilateral closed user group with outgoing access	–	–	Yes <sup>a)</sup>	–	Yes	Yes	–	–
– Bilateral closed user group selection	–	Yes <sup>c)</sup>	–	–	Yes	Yes	–	–
Protection	–	Yes	–	–	–	Yes	–	–
Secure dial-back	Yes	–	–	–	–	Yes	–	–

TABLE 1/X.7 (4 of 4)

**Optional user facilities**

Optional user facilities	Arrangements for use				Availability with service <sup>a)</sup>			
	Subscription only	Dynamic invocation	Subscription followed by dynamic invocation	Subscription or dynamic invocation	Circuit switched	Packet switched	Leased Circuit	Frame relay
Data link layer capabilities								
– Extended frame sequence numbering	Yes	–	–	–	–	Yes	–	–
– Super frame sequence numbering	Yes	–	–	–	–	Yes	–	–
– Multilink procedure	Yes	–	–	–	–	Yes	–	–
Other facilities								
– On-line facility registration	–	–	Yes <sup>a)</sup>	–	Yes	Yes	–	–
– Connect when free	Yes	–	–	–	Yes	–	–	–
– Waiting allowed	Yes	–	–	–	Yes	–	–	–
– DTE inactive registration/cancellation	–	–	Yes <sup>a)</sup>	–	Yes	–	–	–
– Date and time indication	–	–	Yes	–	Yes	–	–	–
– Manual answer	Yes	–	–	–	Yes	–	–	–
– Point-to-point	Yes	–	–	–	–	–	Yes	–
Multipoint related facilities								
– Centralized multipoint	Yes	–	–	–	–	–	Yes	–
– Decentralized multipoint	Yes	–	–	–	–	–	Yes	–
– Broadcasting multipoint	Yes	–	–	–	–	–	Yes	–
a)	Dynamic invocation requires use of the corresponding request in appropriate message/packet (e.g. requested in a call request packet). If not requested, an optional user facility is not in effect (e.g. for that call).							
b)	The operation of these optional user facilities depends on whether a preferential CUG has been chosen. If a preferential CUG has been chosen, then these facilities are always in effect (they can be either implicitly invoked without a specific request or explicitly invoked). If a preferential CUG has not been chosen, then these facilities are only in effect if an explicit request is made dynamically.							
c)	Prior to dynamic invocation, a corresponding optional user facility must have been agreed to contractually in order to use this optional user facility.							
d)	In frame relay optional user facility “Closed User Group” (CUG) is presented as “simple CUG” and “CUG selection”. Simple CUG enables DTE to belong to only one CUG. CUG selection enables DTE to belong to several CUG(s). Both simple CUG and CUG selection enable DTE to have outgoing or incoming access or not.							

## **6.1 Data transfer related facilities**

### **6.1.1 Throughput**

For assignment and negotiation of throughput for a virtual circuit, a set of three optional user facilities is available.

NOTE – Throughput capacity, as defined in Recommendation X.135, requires that an optimal set of negotiated or user-selected parameters has been chosen.

#### **6.1.1.1 Default throughput classes assignment**

Default throughput classes assignment is an optional user facility agreed for a period of time. This facility, if subscribed to, provides for the selection of default throughput classes from the list of throughput classes supported by the Administration (or ROA). Values other than the default throughput classes may be negotiated for a virtual call by means of the throughput class negotiation facility.

#### **6.1.1.2 Basic throughput class negotiation, extended throughput class negotiation**

Basic throughput class negotiation and extended throughput class negotiation are optional user facilities agreed for a period of time and then involved for virtual calls. These facilities permit negotiation on a per-call basis of the throughput class for each direction of data transmission.

#### **6.1.1.3 Minimum throughput class negotiation**

Minimum throughput class negotiation is an optional “ITU-T-specified DTE” facility which may be used for a given virtual call. This facility allows the calling DTE to indicate, for each direction of data transmission, a minimum-acceptable value for the throughput class in a call request packet.

### **6.1.2 Flow control parameters**

Two flow control parameters are used in conjunction with virtual circuits: packet size and window size. The standard default values for these parameters, in the absence of any of the three following optional user facilities, are 128 octets and 2, respectively.

#### **6.1.2.1 Non-standard default packet sizes**

Non-standard default packet sizes is an optional user facility agreed for a period of time. This facility, if subscribed to, provides for the selection of a default packet size for each direction of data transmission from the list of packet sizes supported by the Administration (or ROA). Values other than the default packet sizes may be negotiated for a virtual call by means of the flow control parameter negotiation facility.

#### **6.1.2.2 Non-standard default window sizes**

Non-standard default window sizes is an optional user facility agreed for a period of time. This facility, if subscribed to, provides for the selection of default window sizes from the list of window sizes supported by the Administration (or ROA). Values other than the default window sizes may be negotiated for a virtual call by means of the flow control parameter negotiation facility.

#### **6.1.2.3 Flow control parameter negotiation**

Flow control parameter negotiation is an optional user facility agreed for a period of time and then invoked by a DTE for virtual calls. This facility permits negotiation on a per-call basis of the flow control parameters. The flow control parameters are the packet and the window sizes at the DTE/DCE interface for each direction of data transfer.

### **6.1.3 Extended packet sequence numbering**

Extended packet sequence numbering is an optional user facility which provides sequence numbering of data packets performed modulo 128 (normally 8). This allows more data packets to be sent across the DTE/DCE interface (i.e. larger window sizes).

#### **6.1.3.1 Super extended packet sequence numbering**

Super extended packet sequence numbering is an optional user facility which provides sequence numbering of data packets performed modulo 32768 (normally 8, extended 128).

### **6.1.4 Transit delay**

For calculation and negotiation of transit delay, two optional user facilities can be utilized: Transit Delay Selection and Indication (TDSAI) and End-to-End Transit Delay Negotiation (EETDN). These are further discussed in Recommendations X.223, which shows the relationships of these facilities and parameters, and X.135.

#### **6.1.4.1 Transit delay selection and indication**

Transit delay selection and indication is an optional user facility that permits selection and indication, on a per-call basis, of the nominal maximum permissible transit delay applicable to the virtual call.

End-to-end data packet transfer delay is defined in Recommendation X.135.

#### **6.1.4.2 End-to-end transit delay negotiation**

End-to-end transit delay negotiation is an optional "ITU-T-specified DTE" user facility that permits conveyance, on a per-call basis of:

- cumulative transit delay;
- target transit delay (optional); and
- maximum acceptable transit delay (optional).

### **6.1.5 D-bit modification**

D-bit modification is an optional user facility agreed for a period of time. This facility is only intended for use by those pre-D-bit DTEs which were designed for operation that support end-to-end acknowledgement of data packets. It allows these DTEs to continue to operate with networks that allow both local and end-to-end operation.

### **6.1.6 Packet retransmission**

Packet retransmission is an optional user facility agreed for a period of time by the DTE and DCE. It applies in common to all logical channels at the DTE/DCE interface. This facility permits a DTE to request retransmission of data packets.

### **6.1.7 Expedited data negotiation**

Expedited data negotiation is an optional "ITU-T-specified DTE" facility which may be used for a given virtual call. The calling DTE uses the expedited data negotiation facility in the call request packet to indicate if it wishes to use the expedited data transfer procedures (i.e. the *interrupt* procedures).

### **6.1.8 Priority**

Priority is an optional "ITU-T-specified DTE" facility which may be used for a given virtual call. The calling DTE may indicate in the call request packet the target and lowest acceptable values for the priority of data on a connection, priority to gain a connection, and priority to keep a connection.

### **6.1.9 Committed burst size (Bc); Committed burst size negotiation**

The committed burst size in FRDTS is the amount of data for a particular virtual circuit that the network agrees to transfer under normal conditions during interval  $T_c$  (see Note). The values of this service parameter for a given direction of transmission (i.e. outgoing direction from the DTE to the DCE and incoming direction from the DCE to the DTE) is set to a value selected from a set supported by the network and agreed to for a period of time. The value of this service parameter for a given direction of transmission can also be negotiated at call set-up.

NOTE – The committed rate measurement interval  $T_c$  is the time interval during which the network may expect committed burst size and excess burst size data. For each direction of transmission, it is defined according to the following formula:

- 1) if  $CIR > 0$ ; (see 6.1.11)  $T_c = Bc/CIR$ ;
- 2) if  $CIR = 0$ ,  $T_c$  is set to a value selected by the user from a set supported by the network. This value is agreed for a period of time.

### **6.1.10 Excess burst size (Be); Excess burst size negotiation**

The excess burst size in FRDTS is the amount of uncommitted data that the network shall endeavor to accept in addition to the committed burst size ( $B_c$ ) from a DTE for a particular virtual circuit during interval  $T_c$  (see Note 6.1.9). The value of this service parameter for a given direction of transmission (i.e. outgoing direction from the DTE to the DCE and incoming direction from the DCE to DTE) is set to a value selected from a set supported by the network and agreed to for a period of time. The value of this service parameter for a given direction of transmission can also be negotiated at call set-up.

### **6.1.11 Committed Information Rate (CIR); Committed information rate negotiation**

The information transfer rate for a particular PVC which the network is committed to transfer under normal conditions in FRDTS. The rate is averaged over a minimum time interval of  $T_c$ . The value of this service parameter for a given direction of transmission (i.e. outgoing direction from the DTE to the DCE and incoming direction from the DCE to the DTE) is set to a value selected from a set supported by the network and agreed to for a period of time. The value of this service parameter for a given direction of transmission can also be negotiated at call set-up.

## **6.2 Facilities to convey user data other than during the data transfer phase**

In PSPDNs and ISDNs, user data can be conveyed in addition to the normal data flow in the data transfer phase. User data can be conveyed in the following phases of a call:

- call request phase (calling DTE to called DTE);
- call confirmation phase (called DTE to calling DTE); and
- call clearing phase (clearing DTE to cleared DTE).

The definition of these phases can be found in Recommendation X.301.

Up to 16 octets of user data can be sent by the calling DTE to the called DTE in the call request phase without invoking any optional user facilities. The fast select capability increases the number of octets that can be sent and extends this to all phases of a call.

### **6.2.1 Fast select**

Fast select is an optional user facility which may be requested by a DTE for a given virtual call.

The fast select facility allows conveyance from the calling DTE to the called DTE of up to 128 octets of user data. The called DTE can issue as a direct response to the incoming call packet a call accepted or clear request packet with up to 128 octets of user data. If the call is connected, 128 octets of user data may also be sent by a DTE during the call clearing phase.

When requested in a call request packet, the fast select facility can also indicate that there is a restriction on the response allowed by the called DTE. That is, the called DTE may only respond with a clear request to the call request.

## **6.2.2 Fast select acceptance**

Fast select acceptance is an optional user facility agreed for a period of time. This facility, if subscribed to, authorizes the DCE to transmit incoming calls which request the fast select facility to the called DTE. The DCE clears a call request with fast select if the called DTE has not subscribed to fast select acceptance.

## **6.3 Addressing related facilities**

### **6.3.1 Address extension**

Calling and called address extension facilities are optional "ITU-T-specified DTE" facilities which may be used for a given virtual call. They provide for transparent conveyance in call request and incoming call packets of additional calling and called addressing information (e.g. OSI Network Service Access Point Addresses).

The called address extension facility also provides for transparent conveyance of additional responding addressing information in call accepted/call connected packets and in clear request/clear indication packets.

### **6.3.2 Calling line identification**

Calling line identification is an optional user facility agreed for a period of time and standardized for circuit switched data transmission services on a CSPDN. The calling line identification facility enables a user to be informed of the identity of the calling user for all incoming calls. (Calling line identification is part of the basic packet switched data transmission service – no optional user facility is needed.)

### **6.3.3 Called line identification**

Called line identification is an optional user facility which may be requested by the DTE on a per-call basis in CSPDNs. This facility, when used, requires the DCE to indicate the identity of the called line to the calling DTE. (Called line identification is part of the basic packet switched data transmission service – no optional user facility is needed.)

### **6.3.4 Abbreviated address calling**

Abbreviated address calling is an optional user facility which may be requested by the DTE on a per-call basis. This facility enables the DTE to define a full address by an abbreviated address and then use that abbreviated address for a particular call.

### **6.3.5 Alternative addressing**

The set of alternative addressing related facilities enables a DTE to use an alternative address to identify the called DTE when establishing a call. An alternative address is defined as one that does not conform to the formats in Recommendation X.121, such as an OSI NSAP (Network Service Access Point) address or a mnemonic address. The DCE translates an alternative address to the format defined in Recommendation X.121 as the basis on which to route the call. This capability provides for registration of alternative addresses, agreement to use an alternative address, and then selection of an alternative address at the time of setting up a virtual call.

#### **6.3.5.1 Global alternative address registration; Interface specific alternative address registration**

Registration enables users to register alternative addresses and their translations. Translations can allow a single alternative address to be mapped to several X.121 addresses (for example, to allow a DTE to be multi-homed with several X.121 addresses all reachable by a single alternative address) or several alternative addresses can all map to the same X.121 address (for example, to allow multiple systems to be reached through the same gateway).

Global registration allows DTEs to register alternative addresses for use by other DTEs. These addresses are unique within a network.

Interface-specific registration allows a DTE to register translations that pertain only to its interface.

### **6.3.5.2 Alternative address usage subscription**

This optional user facility allows a DTE to use an alternative address in call request packets or clear request packets with call deflection selection facility. The decision to use an alternative address is made on a per-call basis by the DTE.

### **6.3.5.3 Alternative address selection**

Having agreed to the alternative address usage facility, a DTE may identify the called DTE by specifying an alternative address. The PSPDN translates the alternative address during the call request phase based on the rules established at the time of registration.

### **6.3.6 Direct call**

Direct call is an optional user facility. When subscribed to, this facility allows a DTE to designate the address to which all calls will be established. When used on a per-call basis, this facility allows a DTE to designate the address to which this call will be established when the called address is absent during the call establishment phase.

### **6.3.7 Multi-address calling**

Multi-address calling is an optional user facility which may be requested by the DTE on a per-call basis in CSPDNs. This facility provides the calling DTE with the capability to request point to multipoint service.

### **6.3.8 Hunt group**

Hunt group is an optional user facility agreed for a period of time. This user facility, if subscribed to, distributes incoming calls having an address associated with the hunt group across a designated grouping of DTE/DCE interfaces. The lines of the hunt group may connect to a single DTE or to several DTEs.

Individual access lines within the hunt group may also have specific addresses. In this case, the called address returned to the calling DTE may reflect this address in the called line address modified notification facility (to allow the calling DTE to reconnect to the interface, should it be necessary).

### **6.3.9 Called line address modified notification**

Called line address modified notification is an optional user facility used in the call confirmation or call clearing phase to inform the calling DTE as to why the called address in this phase is different from that specified by the calling DTE in the call request phase. Reasons for this change in called address are:

- hunt group distribution (see 6.3.8);
- call redirection/deflection operation (see 6.4.1 and 6.4.2 and Figure 12).

### **6.3.10 TOA/NPI address subscription**

TOA/NPI address subscription is an optional user facility agreed for a period of time for virtual calls.

When this facility is subscribed to, the DCE is permitted to transmit call set-up and clearing packets to the DTE using the TOA/NPI address format.

### **6.3.11 Extended address field**

This is an optional user facility agreed for a period of time. This facility in FRDTS if subscribed to permit choice of extended address field length (3 octets and/or 4 octets).

## **6.4 Routing related facilities**

### **6.4.1 Call redirection**

Call redirection is an optional user facility agreed for a period of time. This facility, if subscribed to, enables a user to have calls that were addressed to it redirected to a predetermined address. Operation of this and related facilities for PSPDNs is depicted in Figure 12 (the packets represented by 2A and 2B do not apply for redirection).

In the case of circuit switched data transmission service in CSPDNs, redirection applies to all calls to the address. In the case of packet switched data transmission service in PSPDNs and ISDNs, it applies to calls which encounter the out-of-order condition or, optionally, other conditions such as number busy.

### 6.4.2 Deflection of calls

The call deflection capability allows a DTE to respond to an incoming call by requesting that it be sent to another DTE. This is depicted in Figure 12 (the redirection represented by 2 does not apply to deflection).

#### 6.4.2.1 Call deflection subscription

Call deflection subscription is an optional user facility agreed for a period of time. This facility, if subscribed to, enables the DTE to indicate that it wishes to have the ability to deflect an incoming call that it receives to an alternate DTE.

#### 6.4.2.2 Call deflection selection

Call deflection selection is an optional user facility which may be used on a per-call basis. This facility may be used by a DTE only if it has subscribed to the call deflection subscription facility.

The call deflection selection facility may be used by the called DTE in a clear request packet only in response to an incoming call packet to specify the alternate DTE address to which the call is to be deflected.

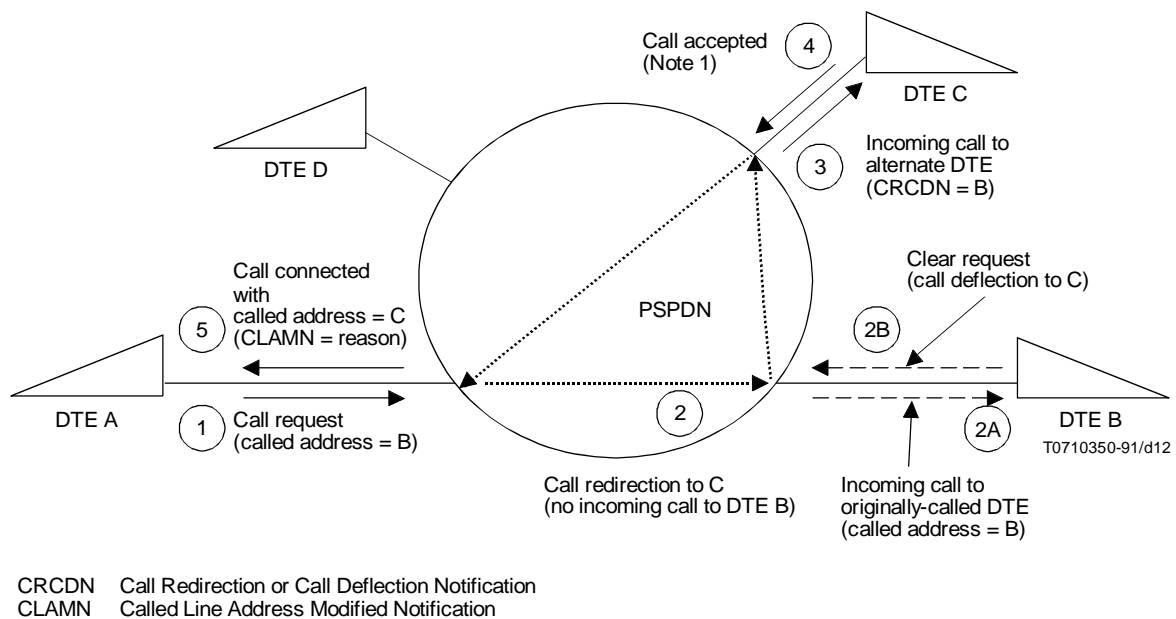

#### NOTES

- DTE C may also clear the call, in which case ⑤ is a clear indication.
- Redirections may be logically chained. If DTE C has subscribed to call redirection to DTE D, a call redirection from DTE B to DTE C may be redirected to DTE D.

FIGURE 12/X.7  
 Use of call redirection deflection and related facilities



### **6.4.3 Inter-network Call Redirection and Deflection (ICRD) control**

Call redirection or call deflection is considered to be inter-network when the originally-called DTE and the alternate DTE are on different PSPDNs. Because the tariff between the calling DTE and the alternate DTE may be more expensive than between the calling DTE and the originally-called DTE, optional user facilities are defined to prevent ICRD from taking place in all cases of ICRD except for one. The exception case is when the calling DTE and the alternate DTE are served by the same PSPDN.

When a PSPDN supports ICRD, it will allow ICRD to take place unless the user subscribes to the ICRD prevention subscription facility or uses the per-call ICRD status selection facility to signal that ICRD should be prevented for that call. If a PSPDN does not support ICRD, ICRD is prevented by default.

#### **6.4.3.1 Inter-network Call Redirection and Deflection (ICRD) prevention subscription**

ICRD prevention subscription is an optional user facility agreed for a period of time for virtual calls. This facility, if subscribed to, will prevent calls originated by the subscribed DTE from undergoing ICRD except in the case where the alternate DTE is served by the same PSPDN as that of the subscribed DTE. This facility applies to all virtual calls unless overridden for a single virtual call by the ICRD status selection facility.

#### **6.4.3.1 Inter-network Call Redirection and Deflection (ICRD) status selection**

ICRD status selection is an optional user facility which may be used on a per virtual call basis. This facility may be requested by a calling DTE during call establishment phase to indicate whether ICRD should be allowed or prevented. If signalled by the calling DTE, it overrides the default status of the interface concerning whether ICRD should be allowed or prevented.

### **6.4.4 Call redirection or call deflection notification**

Call redirection or call deflection notification is an optional user facility used by the DCE in the incoming call packet to inform the alternate DTE that the call to it is a result of redirection or deflection, the reason for the redirection/deflection, and the address of the originally-called DTE.

### **6.4.5 ROA designation**

The set of ROA optional user facilities provides for the calling DTE's designation of a sequence of one or more ROA transit network(s) within the originating country through which the call is to be routed when more than one ROA transit network exists at a sequence of one or more gateways.

#### **6.4.5.1 ROA subscription**

ROA subscription is an optional user facility agreed for a period of time for virtual calls. This facility, if subscribed to, applies to all virtual calls unless overridden for a single virtual call by the ROA selection facility.

#### **6.4.5.2 ROA selection**

This facility is an optional user facility which may be requested by a DTE on a per-call basis for use on either circuit switched or packet switched virtual call services.

## **6.5 Charging related facilities**

### **6.5.1 Reverse charging related facilities**

The reverse charging related facilities provide a capability to set up reverse-charged virtual calls. Without the use of these facilities, the calling DTE is normally charged for the call.

#### **6.5.1.1 Reverse charging**

Reverse charging is an optional user facility that may be requested by the DTE on a per-call basis. It allows a calling DTE to request that the call be charged to the called DTE. The called DTE may still refuse the call by clearing it.

### **6.5.1.2 Reverse Charging Acceptance**

Reverse charging acceptance is an optional user facility agreed for a period of time. This user facility, if subscribed to, authorizes the DCE to transmit to the DTE incoming calls which request the reverse charging facility. The DCE clears a call request with reverse charging if the called DTE has not subscribed to Reverse Charging Acceptance.

### **6.5.2 Local charging prevention**

Local charging prevention is an optional user facility agreed for a period of time. This user facility, if subscribed to, authorizes the DCE to prevent the establishment of calls to/by a DTE which it must pay for by:

- not transmitting to the DTE incoming calls which request the reverse charging facility; and
- insuring that the charges are made to another party whenever a call is requested by the DTE (this other party can be determined by using any of a number of actions, both procedural and administrative).

### **6.5.3 Network user identification**

The set of Network User Identification (NUI) related facilities enables the DTE to provide information to the network for billing, security and network management purposes on a per-call basis.

This set is composed of three optional user facilities. NUI subscription and NUI override may be agreed for a period of time for virtual calls; a DTE may subscribe to one or both these facilities. When one or both of these facilities are subscribed to, one or several network user identifiers are also agreed for a period of time. A given network user identifier may be either specific or common to the NUI subscription facility and the NUI override facility. The network user identifier is transmitted by the DTE to the DCE in the NUI selection facility during call set-up.

#### **6.5.3.1 NUI subscription**

NUI subscription is an optional user facility agreed for a period of time. This facility, if subscribed to, enables the DTE to provide information to the network for billing, security and network management purposes on a per-call basis. This information may be provided by the calling DTE in the call request phase or by the called DTE in the call confirmation phase.

#### **6.5.3.2 NUI override**

NUI override is an optional user facility agreed for a period of time. When this facility is subscribed, each network user identifier associated with NUI override is also associated with a set of subscription-time optional user facilities (see Annex H/X.25 for which optional user facilities apply). When one of these network user identifiers is provided in a call request packet by means of an NUI selection facility, the set of subscription-time optional user facilities associated with that identifier overrides the facilities which apply to the interface.

#### **6.5.3.3 NUI selection**

NUI selection is an optional user facility which may be requested by a DTE for a given virtual call. This user facility may be requested by a DTE only if it has subscribed to the NUI subscription facility and/or NUI override facility. The NUI selection facility permits the DTE to specify which network user identifier is to be used for this call in conjunction with the NUI subscription facility and/or override facility.

### **6.5.4 Charging information**

Charging information is an optional user facility which may be either agreed for a period of time or requested for a given call.

If the DTE is the DTE to be charged, the DTE can request the charging information facility on a per-call basis by means of an appropriate facility request in the call request or the call confirmation phase.

If a DTE agrees to the charging information facility for a period of time, the facility is in effect for the DTE whenever the DTE is the DTE to be charged, without sending the facility request in the call request or call confirmation phase.

During the call clearing phase, the DCE will send to the DTE, if it is to be charged for the call, information about the charge for the call or other information which makes it possible for the user to calculate the charge.

## **6.6 Protection related facilities**

### **6.6.1 Incoming calls barred**

Incoming calls barred is an optional user facility agreed for a period of time. This facility applies to all calls at the DTE/DCE interface. This optional user facility, if subscribed to, prevents incoming calls from being presented to the DTE. The DTE may originate outgoing calls. This facility allows a DTE to reserve logical channels from receiving virtual calls from other DTEs (i.e. they cannot be used by the DTE to originate new virtual calls).

### **6.6.2 Outgoing calls barred**

Outgoing calls barred is an optional user facility agreed for a period of time. This facility applies to all calls at the DTE/DCE interface. This optional user facility, if subscribed to, prevents the DCE from accepting outgoing calls from the DTE. The DTE may receive incoming calls. This facility allows a DTE to reserve logical channels from originating virtual calls to other DTEs (i.e. they cannot be used by the network to place a new virtual call to the DTE).

### **6.6.3 One-way logical channel incoming**

One-way logical channel incoming is an optional user facility agreed for a period of time. This facility, if subscribed to, restricts call origination on the logical channel to receiving incoming virtual calls only. This facility allows a DTE to reserve logical channels for receiving calls from other DTEs (i.e. they cannot be used by the DTE to originate new virtual calls).

### **6.6.4 One-way logical channel outgoing**

One-way logical channel outgoing is an optional user facility agreed for a period of time. This facility, if subscribed to, restricts call origination on the logical channel to making outgoing virtual calls only. This facility allows a DTE to reserve logical channels for originating calls to other DTEs (i.e. they cannot be used by the network to place a new virtual call to the DTE).

### **6.6.5 Closed user group**

The Closed User Group (CUG) related facilities enable users to form groups with different combinations of restrictions for access from or to users having one or more of these facilities. A DTE can belong to one or more CUGs. Some PSPDNs also allow a user to choose not to designate a CUG as its *preferential CUG* (i.e. specification of a preferential CUG is always allowed).

The following CUG facilities are all optional user facilities that are agreed for a period of time:

- a) Closed user group – This is the basic facility that enables a DTE to belong to one or more CUGs and to make/receive calls only to/from other DTEs in the same CUG.
- b) Closed user group with outgoing access – This is an extension of a) which also enables the DTE to make outgoing calls to the open part of the network (i.e. to DTEs not belonging to any CUG) and to DTEs having the incoming access capability.
- c) Closed user group with incoming access – This is an extension of a) which also enables the DTE to receive incoming calls from the open part of the network and from DTEs having the outgoing access capability.
- d) Incoming calls barred within the closed user group – This is a supplementary facility to a), b) or c) which, when used, applies per CUG and prohibits the DTE from receiving calls from other members of that CUG.
- e) Outgoing calls barred within the closed user group – This is a supplementary facility to a), b) or c) which, when used, applies per CUG and prohibits the DTE from originating calls to other members of that CUG.

During the call request phase, it may be necessary to identify the CUG pertaining to the call. The following optional facilities are used for this:

- Closed user group selection – This facility may be used when the closed user group facility, the closed user with outgoing access facility and/or the closed user with incoming access facility apply; it is used to identify the CUG pertaining to the call.
- Closed user group with outgoing access selection – This facility may be used when either or both of the closed user group with outgoing access and closed user group with incoming access facilities apply and the DTE has chosen not to have a preferential CUG; it is used to identify the CUG pertaining to the call and that access to/from the open part of the network also applies to the call.

Figure 13 illustrates a hypothetical CUG environment and indicates the allowed connectivity.

The realization of CUG facilities is done by the association of an *international interlock code* with a CUG and is based on various validation checks during the call request phase to determine whether a requested call to or from a user having a CUG facility is allowed. Discussion on CUG screening can be found in Recommendation X.301.

Membership in closed user groups is controlled by the Administration or an ROA in conjunction with user requests. Assignment of international interlock codes is controlled by the Administration or ROA and cannot be controlled by the user. The international interlock code expresses the international CUG number assigned to the CUG in accordance with the administrative rules defined in Recommendation X.180.

### **6.6.6 Bilateral closed user group**

Bilateral Closed User Group (BCUG) and bilateral closed user group with outgoing access are optional user facilities agreed for a period of time.

The bilateral closed user group facility enables a pair of DTEs to form a bilateral association that allows access between each other while excluding access to or from other DTEs with which such an association has not been formed. A DTE may belong to more than one BCUG.

The bilateral closed user group with outgoing access facility enables a DTE to form BCUGs as with the bilateral closed user group facility, but at the same time allows the user to access, via outgoing calls, open users not having the bilateral closed user group or bilateral closed user with outgoing access facilities.

Bilateral closed user group selection is an optional user facility which may be used on a per-call basis. This facility can be requested by the DTE or received by a DTE if it has subscribed to bilateral closed user group facility or the bilateral closed user group with outgoing access facility. This facility enables the DTE to specify the BCUG selected for a call.

A user may simultaneously have the bilateral closed user group or bilateral closed user group with outgoing access facility and one or more of the closed user group facilities.

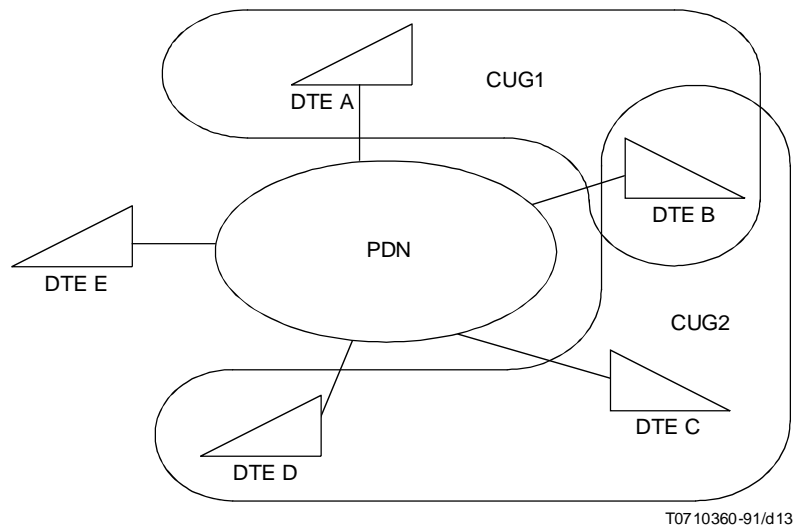

DTE	Subscription	Can make calls to	Can receive calls from
A	CUG with outgoing access • CUG1	B, D, E	B
B	CUG with incoming access • CUG1 • CUG2 with outgoing calls barred	A	A, C, D, E
C	CUG • CUG2	B	D
D	CUG with incoming access • CUG2 with incoming calls barred	B, C	A, E
E	No CUG subscription	B, D	A

FIGURE 13/X.7

**Illustration of closed user group environment**

**6.6.7 Protection**

Protection is an optional “ITU-T-specified DTE” facility which may be used for a given virtual call. The calling DTE may indicate in the call request packet the target and lowest acceptable values for protection.

**6.6.8 Secure dial-back**

Secure dial-back is an optional user facility that may be provided by networks that offer both dial-in-by-the-DTE and dial-out-by-the-PSPDN operations for switched access to PSPDNs. If subscribed, this facility combines the dial-in-by-the-DTE operation with the dial-out-by-the-PSPDN operation to offer additional protection when the identity of the DTE becomes known to the PSPDN. After the DTE has correctly identified itself to the DCE during dial-in-by-the-DTE, the DCE disconnects the switched access path and then performs a dial-out-by-PSPDN to the DTE.

## **6.7 Data link layer capabilities**

The following optional capabilities are standardized for the data link layer:

- extended frame sequence numbering; and
- super-extended frame sequence numbering; and
- multilink procedure.

### **6.7.1 Extended frame sequence numbering**

Extended frame sequence numbering is an optional capability which provides sequence numbering of frames performed modulo 128 (normally 8). This allows more frames to be sent across the DTE/DCE interface (i.e. larger window sizes). This feature may be useful for DTE/DCE interfaces that use satellite links.

### **6.7.2 Super-extended frame sequence numbering**

Super-extended frame sequence numbering is an optional capability which provides sequence numbering of frames performed modulo 32768 (normally 8, extended 128). This feature may be useful for DTE/DCE interfaces that use satellite links.

### **6.7.3 Multilink Procedure**

Multilink Procedure (MLP) is an optional capability of the packet switched service that may be agreed for a period of time. If agreed, the multilink procedure is used for data interchange over one or more Single Link Procedures (SLPs) between a DTE and a DCE. This feature can be used to provide a backup capability for a single link or to increase the throughput available with a single link. Figure 14 illustrates how the MLP relates to the DTE/DCE interface for packet switched service. The multilink procedure exists as an added upper sublayer of the Data Link Layer, operating between the Packet Layer and a multiplicity of single data link protocol functions (SLPs) in the Data Link Layer. A multilink procedure performs the functions of accepting packets from the Packet Layer, distributing those packets across the available SLPs for transmission to the remote SLPs, and resequencing the packets received from the SLPs for delivery to the Packet Layer, respectively. Distribution of packets to SLPs can be done in any desired fashion (e.g. “round robin” for balancing traffic or to more than one SLP for redundancy).

## **6.8 Facilities offered by leased circuit services**

The following optional user facilities have been standardized:

- centralized multipoint;
- decentralized multipoint;
- broadcasting multipoint.

Definitions of these facilities are for further study.

## **6.9 Other optional facilities**

The following optional user facilities are also standardized:

- on-line facility registration;
- connect when free;
- waiting allowed;
- DTE inactivity registration/cancellation;
- date and time indication;
- manual answer.

These are discussed below.

### **6.9.1 On-line facility registration**

On-line facility registration is an optional user facility which permits the DTE at any time to request registration of facilities (i.e. make changes to optional user facilities applicable to the interface) or obtain current values of facilities as understood by the DCE.

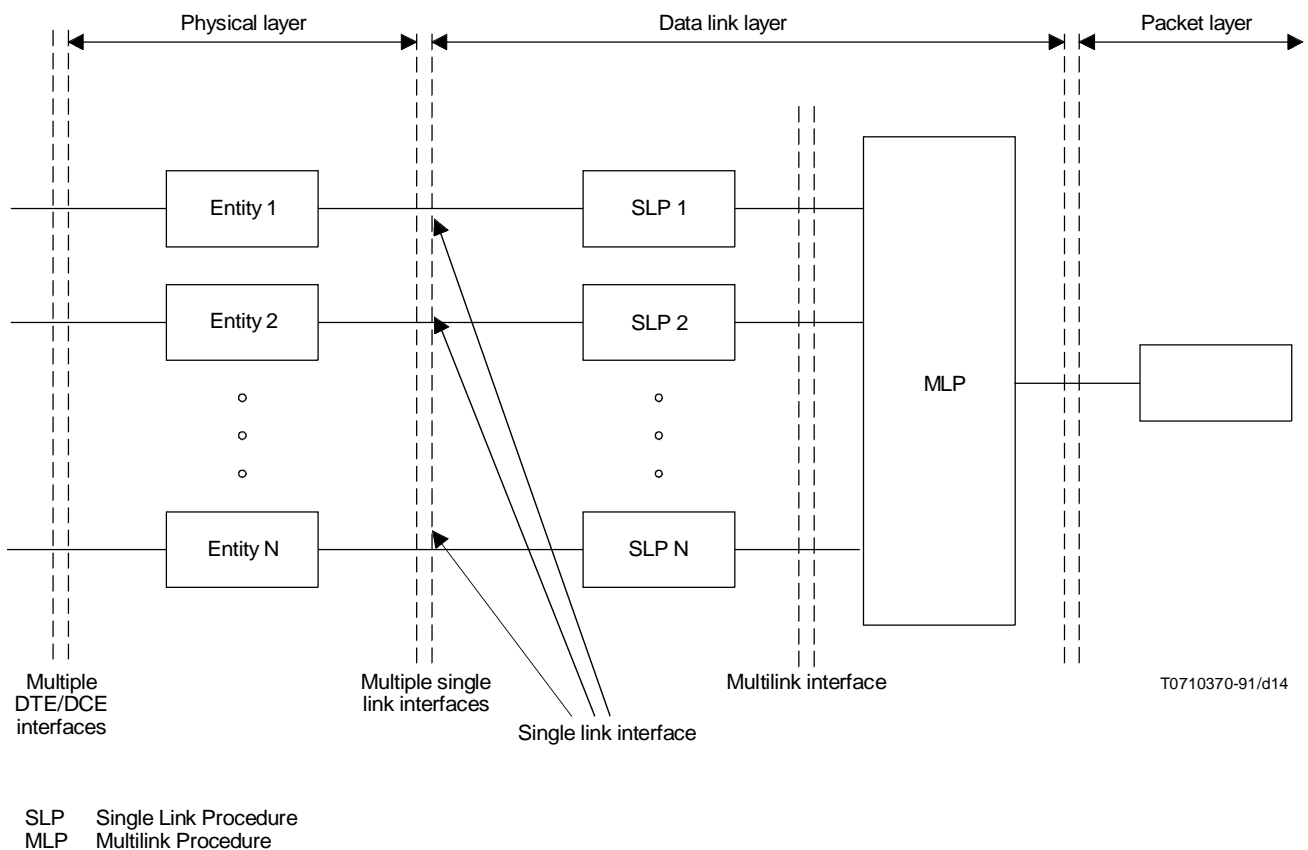

FIGURE 14/X.7  
**Multilink functional organization**

### 6.9.2 Connect when free; Waiting allowed

Connect when free and waiting allowed are optional user facilities agreed for a period of time.

A DTE subscribing to the connect when free facility is assigned a number of waiting positions at which incoming calls received can wait when the access line(s) to the called DTE is busy. The waiting allowed facility enables a DTE calling a busy DTE having the connect when free facility to wait for the completion of the call when the called DTE becomes free. During waiting, the connection is maintained between the calling DTE and the remote DCE.

### 6.9.3 DTE inactivity registration/cancellation

DTE inactivity registration/cancellation is an optional user facility that enables the DTE inform the network about a period of time during which the DTE is unable to accept incoming calls for a circuit-switched data transmission service.

### 6.9.4 Date and time indication

Date and time indication is an optional user facility agreed for a period of time. This facility, if subscribed to, informs the DTE, for every call, of the date and time the call is established.

## 6.9.5 Manual answer

Manual answer is a DTE operating mode allowed by some CSPDNs. DTEs operating in this mode, when called, delay sending a call accepted signal. This enables the network to send a call progress signal indicating terminal called to the calling terminal. The call is completed when the call accepted signal is received from the called terminal.

## 7 References

The following Recommendations and other references contain provisions which, through reference in this text, constitute provisions of this Recommendation. At the time of publication, the editions indicated were valid. All Recommendations and other references are subject to revision; all users of this Recommendation are therefore encouraged to investigate the possibility of applying the most recent edition of the Recommendations and other references listed below. A list of the currently valid ITU-T Recommendations is regularly published.

- [1] ITU-T Recommendation X.1 (1993), *International user classes of service in, and categories of access to, public data networks and Integrated Services Digital Networks (ISDNs)*.
- [2] ITU-T Recommendation X.2 (1993), *International data transmission services and optional user facilities in public data networks and ISDNs*.
- [3] ITU-T Recommendation X.3 (1993), *Packet Assembly/Disassembly facility (PAD) in a public data network*.
- [4] ITU-T Recommendation X.5 (1996), *Facsimile Packet Assembly/Disassembly facility (FPAD) in a public data network*.
- [5] ITU-T Recommendation X.6 (1993), *Multicast service definition*.
- [6] CCITT Recommendation X.20 (1988), *Interface between Data Terminal Equipment (DTE) and Data Circuit-terminating Equipment (DCE) for start-stop transmission services on public data networks*.
- [7] CCITT Recommendation X.20 bis (1988), *Use on public data networks of Data Terminal Equipment (DTE) which is designed for interfacing to asynchronous duplex V-Series modems*.
- [8] CCITT Recommendation X.21 (1992), *Interface between data terminal equipment and data circuit-terminating equipment for synchronous operation on public data networks*.
- [9] CCITT Recommendation X.21 bis (1988), *Use on public data networks of Data Terminal Equipment (DTE) which is designed for interfacing to synchronous V-Series modems*.
- [10] CCITT Recommendation X.22 (1988), *Multiplex DTE/DCE interface for user classes 3-6*.
- [11] ITU-T Recommendation X.25 (1993), *Interface between Data Terminal Equipment (DTE) and Data Circuit-terminating Equipment (DCE) for terminals operating in the packet mode and connected to public data networks by dedicated circuit*.
- [12] ITU-T Recommendation X.28 (1993), *DTE/DCE interface for a start-stop mode data terminal equipment accessing the packet assembly/disassembly facility (PAD) in a public data network situated in the same country*.
- [13] ITU-T Recommendation X.29 (1993), *Procedures for the exchange of control information and user data between a Packet Assembly/Disassembly facility (PAD) facility and a packet mode DTE or another PAD*.
- [14] ITU-T Recommendation X.30 (1993), *Support of X.21, X.21 bis and X.20 bis based Data Terminal Equipments (DTEs) by an integrated services digital network (ISDN)*.



- [15] ITU-T Recommendation X.31 (1995), *Support of packet mode terminal equipment by an ISDN.*
- [16] ITU-T Recommendation X.32 (1993), *Interface between Data Terminal Equipment (DTE) and Data Circuit-terminating Equipment (DCE) for terminals operating in the packet mode and accessing a packet switched public data network through a public switched telephone network or an integrated services digital network or a circuit switched public data network.*
- [17] CCITT Recommendation X.38 (1992), *G3 facsimile equipment/DCE interface for G3 facsimile equipment accessing the Facsimile Packet Assembly/Disassembly facility (FPAD) in a public data network situated in the same country.*
- [18] CCITT Recommendation X.39 (1992), *Procedures for the exchange of control information and user data between a Facsimile Packet Assembly/Disassembly (FPAD) facility and a packet mode Data Terminal Equipment (DTE) or another FPAD.*
- [19] CCITT Recommendation X.60 (1988), *Common channel signalling for circuit switched data applications.*
- [20] CCITT Recommendation X.61 (1988), *Signalling System No. 7 – Data user part.*
- [21] CCITT Recommendation X.70 (1988), *Terminal and transit control signalling system for start-stop services on international circuits between anisochronous data networks.*
- [22] CCITT Recommendation X.71 (1988), *Decentralized terminal and transit control signalling system on international circuits between synchronous data networks.*
- [23] ITU-T Recommendation X.75 (1993), *Packet-switched signalling system between public networks providing data transmission services.*
- [24] CCITT Recommendation X.80 (1988), *Interworking of interexchange signalling systems for circuit switched data services.*
- [25] CCITT Recommendation X.81 (1988), *Interworking between an ISDN circuit-switched and a Circuit-Switched Public Data Network (CSPDN).*
- [26] CCITT Recommendation X.82 (1988), *Detailed arrangements for interworking between CSPDNs and PSPDNs based on Recommendation T.70.*
- [27] CCITT Recommendation X.92 (1988), *Hypothetical reference connections for public synchronous data networks.*
- [28] ITU-T Recommendation X.96 (1993), *Call progress signals in public data networks.*
- [29] CCITT Recommendation X.110 (1988), *International routing principles and routing plan for public data networks.*
- [30] ITU-T Recommendation X.116 (1996), *Address translation registration and resolution protocol.*
- [31] CCITT Recommendation X.121 (1992), *International numbering plan for public data networks.*
- [32] CCITT Recommendation X.122 (1992), *Numbering plan interworking for the E.164 and X.121 numbering plans.*
- [33] ITU-T Recommendation X.123 (1996), *Mapping between escape codes and TOA/NPI for E.164/X.121 numbering plan interworking during the translation period.*
- [34] CCITT Recommendation X.130 (1988), *Call processing delays in public data networks when providing international synchronous circuit-switched data services.*
- [35] CCITT Recommendation X.131 (1988), *Call blocking in public data networks when providing international synchronous circuit-switched data services.*
- [36] CCITT Recommendation X.134 (1992), *Portion boundaries and packet layer reference events: basis for defining packet-switched performance parameters.*

- [37] CCITT Recommendation X.135 (1992), *Speed of service (delay and throughput) performance values for public data networks when providing international packet-switched services.*
- [38] CCITT Recommendation X.136 (1992), *Accuracy and dependability performance values for public data networks when providing international packet-switched services.*
- [39] CCITT Recommendation X.137 (1992), *Availability performance values for public data networks when providing international packet-switched services.*
- [40] CCITT Recommendation X.138 (1992), *Measurement of performance values for public data networks when providing international packet-switched services.*
- [41] CCITT Recommendation X.139 (1992), *Echo, drop, generator and test DTEs for measurement of performance values in public data networks when providing international packet-switched services.*
- [42] CCITT Recommendation X.140 (1992), *General quality of service parameters for communication via public data networks.*
- [43] CCITT Recommendation X.180 (1988), *Administrative arrangements for international Closed User Groups (CUGs).*
- [44] CCITT Recommendation X.181 (1988), *Administrative arrangements for the provision of international Permanent Virtual Circuits (PVCs).*
- [45] ITU-T Recommendation X.223 (1993), *Use of X.25 to provide the OSI connection-mode network service for ITU-T applications.*
- [46] ITU-T Recommendation X.301 (1993), *Description of general arrangements for call control within a subnetwork and between subnetworks for provision of data transmission services.*
- [47] CCITT Recommendation E.164 (1991), *Numbering plan for the ISDN era.*
- [48] ITU-T Recommendation F.69 (1994), *The international telex service – Service and operational provisions of telex destination codes and telex network identification codes.*
- [49] ITU-T Recommendation I.430 (1995), *Basic user-network interface – Layer 1 specification.*
- [50] ITU-T Recommendation I.431 (1993), *Primary rate user-network interface – Layer 1 specification.*
- [51] ITU-T Recommendation Q.921 (1993), *ISDN user-network interface – Data link layer specification.*
- [52] ITU-T Recommendation Q.931 (1993), *Digital Subscriber Signalling System No. 1 (DSS1) – ISDN user-network interface layer 3 specification for basic call control.*
- [53] CCITT Recommendation I.233.1 (1991), *ISDN frame relaying bearer.*
- [54] CCITT Recommendation Q.922 (1992), *ISDN data link layer specification for frame mode bearer services.*
- [55] ITU-T Recommendation X.35 (1993), *Interface between a PSPDN and a private PSDN which is based on X.25 procedures and enhancements to define a gateway function that is provided in the PSPDN.*
- [56] ITU-T Recommendation X.36 (1995), *Interface between Data Terminal Equipment (DTE) and Data Circuit-terminating Equipment (DCE) for public data networks providing frame relay data transmission service by dedicated circuit.*
- [57] ITU-T Recommendation X.37 (1995), *Encapsulation in X.25 packets of various protocols including frame relay.*
- [58] ITU-T Recommendation X.33 (1996), *Access to packet switched data transmission services via frame relaying data transmission services.*

- [59] ITU-T Recommendation X.76 (1995), *Network-to-network interface between public data networks providing the frame relay data transmission service.*
- [60] ITU-T Recommendation X.115 (1995), *Definition of address translation capability in public data networks.*
- [61] ITU-T Recommendation X.144 (1995), *User information transfer performance parameters for data networks providing international frame relay PVC service.*
- [62] ITU-T Recommendation X.145 (1996), *Performance for data networks providing international frame relay SVC service.*
- [63] ITU-T Recommendation X.8 (1994), *Multi-aspect PAD (MAP) framework and service definition.*
- [64] ITU-T Recommendation X.45 (1996), *Interface between data terminal equipment (DTE) and Data Circuit-terminating Equipment (DCE) for terminals operating in the packet mode and connected to public data networks, designed for efficiency at higher speeds.*
- [65] ITU-T Recommendation X.34 (1996), *Access to packet switched data transmission services via B-ISDN.*
- [66] ITU-T Recommendation X.48 (1996), *Procedures for the provision of a basic multicast service for Data Terminal Equipments (DTEs) using Recommendation X.25.*
- [67] ITU-T Recommendation X.49 (1996), *Procedures for the provision of an extended multicast service for Data Terminal Equipments (DTEs) using Recommendation X.25.*



## ITU-T RECOMMENDATIONS SERIES

- Series A Organization of the work of the ITU-T
- Series B Means of expression
- Series C General telecommunication statistics
- Series D General tariff principles
- Series E Telephone network and ISDN
- Series F Non-telephone telecommunication services
- Series G Transmission systems and media
- Series H Transmission of non-telephone signals
- Series I Integrated services digital network
- Series J Transmission of sound-programme and television signals
- Series K Protection against interference
- Series L Construction, installation and protection of cables and other elements of outside plant
- Series M Maintenance: international transmission systems, telephone circuits, telegraphy, facsimile and leased circuits
- Series N Maintenance: international sound-programme and television transmission circuits
- Series O Specifications of measuring equipment
- Series P Telephone transmission quality
- Series Q Switching and signalling
- Series R Telegraph transmission
- Series S Telegraph services terminal equipment
- Series T Terminal equipments and protocols for telematic services
- Series U Telegraph switching
- Series V Data communication over the telephone network
- Series X Data networks and open system communication**
- Series Z Programming languages