



INTERNATIONAL TELECOMMUNICATION UNION

**ITU-T**

TELECOMMUNICATION  
STANDARDIZATION SECTOR  
OF ITU

**Q.714**

(07/96)

SERIES Q: SWITCHING AND SIGNALLING

Specifications of Signalling System No. 7 – Signalling  
connection control part

---

**Signalling connection control part procedures**

ITU-T Recommendation Q.714

(Previously CCITT Recommendation)

---

ITU-T Q-SERIES RECOMMENDATIONS  
**SWITCHING AND SIGNALLING**

SIGNALLING IN THE INTERNATIONAL MANUAL SERVICE	Q.1–Q.3
INTERNATIONAL AUTOMATIC AND SEMI-AUTOMATIC WORKING	Q.4–Q.59
FUNCTIONS AND INFORMATION FLOWS FOR SERVICES IN THE ISDN	Q.60–Q.99
CLAUSES APPLICABLE TO ITU-T STANDARD SYSTEMS	Q.100–Q.119
SPECIFICATION OF SIGNALLING SYSTEMS No. 4 AND No. 5	Q.120–Q.249
SPECIFICATIONS OF SIGNALLING SYSTEM No. 6	Q.250–Q.309
SPECIFICATIONS OF SIGNALLING SYSTEM R1	Q.310–Q.399
SPECIFICATIONS OF SIGNALLING SYSTEM R2	Q.400–Q.499
DIGITAL EXCHANGES	Q.500–Q.599
INTERWORKING OF SIGNALLING SYSTEMS	Q.600–Q.699
SPECIFICATIONS OF SIGNALLING SYSTEM No. 7	Q.700–Q.849
General	Q.700
Message transfer part	Q.701–Q.709
Simplified message transfer part	Q.710
<b>Signalling connection control part</b>	<b>Q.711–Q.719</b>
Telephone user part	Q.720–Q.729
ISDN supplementary services	Q.730–Q.739
Data user part	Q.740–Q.749
Signalling System No. 7 management	Q.750–Q.759
ISDN user part	Q.760–Q.769
Transaction capabilities application part	Q.770–Q.779
Test specification	Q.780–Q.799
Q3 interface	Q.800–Q.849
DIGITAL SUBSCRIBER SIGNALLING SYSTEM No. 1	Q.850–Q.999
PUBLIC LAND MOBILE NETWORK	Q.1000–Q.1099
INTERWORKING WITH SATELLITE MOBILE SYSTEMS	Q.1100–Q.1199
INTELLIGENT NETWORK	Q.1200–Q.1999
BROADBAND ISDN	Q.2000–Q.2999

*For further details, please refer to ITU-T List of Recommendations.*

## **ITU-T RECOMMENDATION Q.714**

### **SIGNALLING CONNECTION CONTROL PART PROCEDURES**

#### **Summary**

This Recommendation describes the procedures performed by the Signalling Connection Control Part (SCCP) of Signalling System No. 7 to provide connection-oriented and connectionless network services, as well as SCCP management services as defined in Recommendation Q.711. These procedures make use of the messages and information elements defined in Recommendation Q.712, whose formatting and coding aspects are specified in Recommendation Q.713.

#### **Source**

ITU-T Recommendation Q.714 was revised by ITU-T Study Group 11 (1993-1996) and was approved under the WTSC Resolution No. 1 procedure on the 9th of July 1996.

## FOREWORD

ITU (International Telecommunication Union) is the United Nations Specialized Agency in the field of telecommunications. The ITU Telecommunication Standardization Sector (ITU-T) is a permanent organ of the ITU. The ITU-T is responsible for studying technical, operating and tariff questions and issuing Recommendations on them with a view to standardizing telecommunications on a worldwide basis.

The World Telecommunication Standardization Conference (WTSC), which meets every four years, establishes the topics for study by the ITU-T Study Groups which, in their turn, produce Recommendations on these topics.

The approval of Recommendations by the Members of the ITU-T is covered by the procedure laid down in WTSC Resolution No. 1.

In some areas of information technology which fall within ITU-T's purview, the necessary standards are prepared on a collaborative basis with ISO and IEC.

## NOTE

In this Recommendation, the expression "Administration" is used for conciseness to indicate both a telecommunication administration and a recognized operating agency.

## INTELLECTUAL PROPERTY RIGHTS

The ITU draws attention to the possibility that the practice or implementation of this Recommendation may involve the use of a claimed Intellectual Property Right. The ITU takes no position concerning the evidence, validity or applicability of claimed Intellectual Property Rights, whether asserted by ITU members or others outside of the Recommendation development process.

As of the date of approval of this Recommendation, the ITU had/had not received notice of intellectual property, protected by patents, which may be required to implement this Recommendation. However, implementors are cautioned that this may not represent the latest information and are therefore strongly urged to consult the TSB patent database.

© ITU 1997

All rights reserved. No part of this publication may be reproduced or utilized in any form or by any means, electronic or mechanical, including photocopying and microfilm, without permission in writing from the ITU.

## CONTENTS

	<b>Page</b>
1 Introduction .....	1
1.1 General characteristics of signalling connection control procedures.....	1
1.1.1 Purpose.....	1
1.1.2 Protocol classes .....	1
1.1.3 Signalling connections .....	2
1.1.4 Compatibility and handling of unrecognized information.....	3
1.2 Overview of procedures for connection-oriented services.....	4
1.2.1 Connection establishment .....	4
1.2.2 Data transfer .....	4
1.2.3 Connection release .....	5
1.3 Overview of procedures for connectionless services .....	5
1.3.1 General .....	5
1.3.2 Segmentation/reassembly.....	5
1.4 Structure of the SCCP and contents of this Recommendation.....	5
2 Addressing and routing .....	7
2.1 SCCP addressing principles .....	7
2.2 SCCP routing principles.....	7
2.2.1 Receipt of SCCP message transferred by the MTP.....	7
2.2.2 Messages passed from connection-oriented or connectionless control to SCCP routing control .....	8
2.3 SCCP routing procedures .....	9
2.3.1 Receipt of SCCP messages transferred by the MTP.....	9
2.3.2 Messages from connectionless or connection-oriented control to SCCP routing control.....	10
2.4 Global title translation.....	12
2.4.1 General characteristics of the GTT .....	12
2.4.2 Terminology definitions.....	12
2.4.3 Input of the GTT function .....	14
2.4.4 Output of the GTT function .....	14
2.4.5 Global title translation function .....	15
2.5 Compatibility test .....	17
2.6 Traffic limitation mechanism .....	17
2.6.1 General .....	18
2.6.2 Importance of a message.....	18
2.6.3 Handling of messages to a congested node.....	19
2.7 Calling party address treatment.....	19

	<b>Page</b>
2.7.1	Address indicator ..... 19
2.7.2	Calling party address in the international network..... 19
2.7.3	Routing indicator..... 20
2.7.4	Screening..... 20
2.7.5	Inclusion of OPC in the calling party address..... 20
2.8	Routing failures ..... 22
2.8.1	No translation for an address of such nature ..... 22
2.8.2	No translation for this specific address ..... 22
2.8.3	MTP/SCCP/subsystem failure ..... 23
2.8.4	MTP/SCCP/subsystem congestion..... 23
2.8.5	Unequipped user..... 24
2.8.6	Hop counter violation..... 24
3	Connection-oriented procedures..... 24
3.1	Connection establishment ..... 24
3.1.1	General ..... 24
3.1.2	Local reference numbers ..... 24
3.1.3	Negotiation procedures ..... 25
3.1.4	Actions at the originating node ..... 26
3.1.5	Actions at a relay node with coupling..... 27
3.1.6	Actions at the destination node ..... 28
3.2	Connection refusal..... 29
3.2.1	Actions at node initiating connection refusal..... 29
3.2.2	Actions at a relay node not initiating connection refusal..... 30
3.2.3	Actions at the originating node not initiating connection refusal ..... 30
3.3	Connection release ..... 30
3.3.1	General ..... 30
3.3.2	Frozen reference..... 31
3.3.3	Actions at an end node initiating connection release..... 31
3.3.4	Actions at a relay node..... 31
3.3.5	Actions at an end node not initiating connection release..... 32
3.4	Inactivity control ..... 32
3.5	Data transfer ..... 33
3.5.1	General ..... 33
3.5.2	Flow control ..... 34
3.5.3	Segmenting and reassembly..... 36
3.6	Expedited data transfer..... 36
3.6.1	General ..... 36
3.6.2	Actions at the originating node ..... 37

	<b>Page</b>
3.6.3	Actions at a relay node..... 37
3.6.4	Actions at the destination node ..... 37
3.7	Reset..... 37
3.7.1	General..... 37
3.7.2	Action at an end node initiating the reset procedure..... 37
3.7.3	Actions at a relay node..... 38
3.7.4	Actions at an end node not initiating the reset procedure..... 39
3.7.5	Handling of messages during the reset procedures..... 39
3.8	Restart..... 40
3.8.1	General..... 40
3.8.2	Actions at the recovered node..... 40
3.8.3	Actions at the non-failed far end node..... 40
3.8.4	Syntax error..... 42
3.8.5	Action tables..... 42
3.8.6	Actions upon the reception of an ERR message..... 42
4	Connectionless procedures..... 42
4.1	Data transfer..... 43
4.1.1	Segmentation/reassembly..... 44
4.1.2	Message change..... 48
4.2	Message return procedure..... 48
4.3	Syntax error..... 49
5	SCCP management procedures..... 49
5.1	General..... 49
5.2	Signalling point status management..... 52
5.2.1	General..... 52
5.2.2	Signalling point prohibited..... 52
5.2.3	Signalling point allowed..... 52
5.2.4	Signalling point congested..... 53
5.2.5	Local MTP network availability..... 54
5.2.6	Local MTP network unavailability..... 54
5.2.7	SCCP reports of SCCP and nodal congestion..... 54
5.2.8	Inter- and Intra- SCMG congestion reports procedure..... 55
5.3	Subsystem status management..... 55
5.3.1	General..... 55
5.3.2	Subsystem prohibited..... 56
5.3.3	Subsystem allowed..... 56
5.3.4	Subsystem status test..... 57

	<b>Page</b>
5.3.5 Coordinated state change .....	58
5.3.6 Local broadcast .....	59
5.3.7 Broadcast.....	60
5.4 MTP/SCMG restart .....	61
6 References .....	61
6.1 Normative references.....	61
6.2 Informative references.....	62
Annex A – State diagrams for the signalling connection control part of Signalling System No. 7 .....	62
A.1 Introduction .....	62
A.2 Symbol definition of the state diagrams at the message interface.....	62
A.3 Symbol definition of the state diagrams.....	63
Annex B – Action tables for the SCOC.....	66
B.1 Introduction .....	66
B.2 Symbol definition of the action tables.....	66
B.3 Table of contents .....	67
Annex C – State Transition Diagrams (STD) for the signalling connection control part of Signalling System No. 7.....	71
C.1 General .....	71
C.2 Drafting conventions .....	71
C.3 Figures.....	72
C.4 Abbreviations and timers.....	72
Annex D – State transition diagrams (STD) for SCCP management control.....	138
D.1 General .....	138
D.2 Drafting conventions .....	139
D.3 Figures.....	139
D.4 Abbreviations and timers.....	139



## **Recommendation Q.714**

### **SIGNALLING CONNECTION CONTROL PART PROCEDURES**

*(revised in 1996)*

#### **1 Introduction**

##### **1.1 General characteristics of signalling connection control procedures**

###### **1.1.1 Purpose**

This Recommendation describes the procedures performed by the Signalling Connection Control Part (SCCP) of Signalling System No. 7 to provide connection-oriented and connectionless network services, as well as SCCP management services as defined in Recommendation Q.711. These procedures make use of the messages and information elements defined in Recommendation Q.712, whose formatting and coding aspects are specified in Recommendation Q.713.

###### **1.1.2 Protocol classes**

The protocol used by the SCCP to provide network services is subdivided into four protocol classes, defined as follows:

- Class 0: Basic connectionless class
- Class 1: Sequenced connectionless class
- Class 2: Basic connection-oriented class
- Class 3: Flow control connection-oriented class

The connectionless protocol classes provide those capabilities that are necessary to transfer one Network Service Data Unit (NSDU) in the "data" field of an XUDT, LUDT or UDT message.

When one connectionless message is not sufficient to convey the user data contained in one NSDU making use of MTP services provided by an MTP-SAP that supports a maximum MTP SDU size of 272 octets including the MTP routing label, a segmenting/reassembly function for protocol classes 0 and 1 is provided. In this case, the SCCP at the originating node or in a relay node provides segmentation of the information into multiple segments prior to transfer in the "data" field of XUDT (or as a network option LUDT) messages. At the destination node, the NSDU is reassembled.

If it is certain that only MTP services according to Recommendation Q.2210 are used in the network, then no segmentation information is needed.

The connection-oriented protocol classes (protocol classes 2 and 3) provide the means to set up signalling connections in order to exchange a number of related NSDUs. The connection-oriented protocol classes also provide a segmenting and reassembling capability. If an NSDU is longer than 255 octets, it is split into multiple segments at the originating node, prior to transfer in the "data" field of DT messages. Each segment is less than or equal to 255 octets. At the destination node, the NSDU is reassembled.

NOTE – Enhancements to protocol classes 2 and 3 for the SCCP capable of supporting long messages are for further study.

### **1.1.2.1 Protocol class 0**

Network Service Data Units passed by higher layers to the SCCP in the originating node are delivered by the SCCP to higher layers in the destination node. They are transferred independently of each other. Therefore, they may be delivered to the SCCP user out-of-sequence. Thus, this protocol class corresponds to a pure connectionless network service.

### **1.1.2.2 Protocol class 1**

In protocol class 1, the features of class 0 are complemented by an additional feature (i.e. the sequence control parameter contained in the N-UNITDATA request primitive) which allows the higher layer to indicate to the SCCP that a given stream of NSDUs shall be delivered in-sequence. The Signalling Link Selection (SLS) parameter in the MTP-TRANSFER request primitive is chosen by the originating SCCP based on the value of the sequence control parameter. The SLS shall be identical for a stream of NSDUs with the same sequence control parameter. The MTP then encodes the Signalling Link Selection (SLS) field in the routing label of MTP messages relating to such NSDUs, so that their sequence is, under normal conditions, maintained by the MTP and SCCP. With the above constraints, the SCCP and MTP together ensure in-sequence delivery to the user. Thus, this protocol class corresponds to an enhanced connectionless service, where an additional in-sequence delivery feature is included.

### **1.1.2.3 Protocol class 2**

In protocol class 2, bidirectional transfer of NSDUs between the user of the SCCP in the originating node and the user of the SCCP in the destination node is performed by setting up a temporary or permanent signalling connection consisting of one or more connection sections. A number of signalling connections may be multiplexed onto the same signalling relation. Each signalling connection in such a multiplexed stream is identified by using a pair of reference numbers, referred to as "local reference numbers". Messages belonging to a given signalling connection shall contain the same value of the SLS field to ensure sequencing as described in 1.1.2.2. Thus, this protocol class corresponds to a simple connection-oriented network service, where SCCP flow control and loss or mis-sequence detection are not provided.

### **1.1.2.4 Protocol class 3**

In protocol class 3, the features of protocol class 2 are complemented by the inclusion of flow control, with its associated capability of expedited data transfer. Moreover, an additional capability of detection of message loss or mis-sequencing is included for each connection section; in such a circumstance, the signalling connection is reset and a corresponding notification is given by the SCCP to the higher layers.

## **1.1.3 Signalling connections**

In all connection-oriented protocol classes, a signalling connection between the nodes of origin and destination may consist of:

- a single connection section; or
- a number of connection sections in tandem, which may belong to different interconnected signalling networks.

In the former case, the originating and destination nodes of the signalling connection coincide with the originating and destination nodes of a connection section.

In the latter case, at any relay point with coupling where a message is received from a connection section and has to be sent on another connection section, the SCCP routing and relaying functions are involved during connection establishment. In addition, SCCP functions are required at these points during Data Transfer and Connection Release to provide coupling of connection sections.

During the connection establishment phase, SCCP routing and relaying functions, as described in clause 2, may be required at one or more relay points without coupling. Once the signalling connection section has been established, SCCP functions are not required at these points.

A signalling connection between two SCCP users in the same node is an implementation dependent matter.

#### **1.1.4 Compatibility and handling of unrecognized information**

##### **1.1.4.1 Rules for compatibility**

An implementation according to this Recommendation shall support all message types parameters and parameter values applicable to the protocol classes and capabilities specified for use in the place of the network(s) in which the implementation is required to operate.

An implementation may recognize all or some message types applicable to other protocol classes, capabilities or networks that it is not required to support and can reject these messages using the appropriate mechanisms, e.g. invoking the return message on error, refusal or error procedures.

All other message types not defined in the current version of this Recommendation, or not supported by the implementation, are discarded with a report to OMAP ("syntax error").

General rules for forward compatibility are specified in Recommendation Q.1400.

##### **1.1.4.2 Handling of unrecognized messages or parameters**

Any message with an unrecognized message type value shall be discarded. Unrecognized parameters within a message are not acted upon. When the unrecognized parameter is an optional parameter, and the message is relayed, the optional parameter shall be transported transparently.

##### **1.1.4.3 Handling of non-mandatory, unsupported parameter values**

Unrecognized parameter values which are syntactically correctly constructed are passed transparently by a relay node if they are carried in optional parameters that need not be evaluated in the relay node. Other values may be reset to default values or acted upon by invoking error procedures as applicable for the semantics of the parameter.

##### **1.1.4.4 Treatment of spare fields**

The SCCP shall handle spare fields in SCCP messages in the following manner:

- spare fields are set to zero on message creation;
- spare fields are not examined at relay nodes nor at the destination node;
- spare fields shall remain unchanged in relay nodes.

##### **1.1.4.5 Handling of gaps**

Gaps (refer to 1.5/Q.713) can exist without causing errors, but they are not desirable. Implementations complying with previous versions of SCCP Recommendations may create gaps. Implementations which comply with the requirements specified in this version of the SCCP shall not introduce gaps at the originating node. It is an objective that a relay node does not introduce gaps. For compatibility reasons the SCCP shall not make any specific checks for gaps, but if any gaps are detected, the message shall be processed as though the gaps were not present. The gaps are considered not to be part of the message and may be deleted or modified when processing the message.

## 1.2 Overview of procedures for connection-oriented services

### 1.2.1 Connection establishment

When the SCCP functions at the originating node receive a request to establish a signalling connection, the "called address" is analysed to identify the node towards which a signalling connection section should be established. If the node is not the same, the SCCP forwards a CR message to that node using the MTP routing functions.

The SCCP in the node receiving the CR message via the MTP functions examines the "called party address" and one of the following actions takes place at the node:

- a) If the "called party address" contained in the CR message corresponds to a user located in that node and if the signalling connection can be established (i.e. establishment of a signalling connection is agreed to by the SCCP and local user), then a CC message is returned.
- b) If the "called party address" does not correspond to a user at that node, then information available in the message and at the node is examined to determine whether a coupling of two connection sections is required at that node. The criteria for determining when a coupling is required is implementation dependent.
  - If a coupling is required, then the SCCP establishes an (incoming) connection section. Establishment of another (outgoing) connection section is initiated by sending a CR message towards the next node and this connection section is logically linked to the incoming connection section.
  - If a coupling of connection sections is not required in this node, then no incoming or outgoing connection section is established. A CR message is forwarded towards the next node using the MTP routing functions.

If the SCCP receives a CR message and either the SCCP or the SCCP user cannot establish the connection, then a CREF message is returned.

On receipt of a CC message, the SCCP completes the setup of a connection section. Furthermore, if coupling of two adjacent connection sections is needed, a further CC message is forwarded to the preceding node.

If no coupling of adjacent connection sections was needed during connection setup in the forward direction, then the CC message is sent directly to the originating node of the connection section, even if a number of relay points without coupling was passed in the forward direction.

When the CR and CC messages have been exchanged between all the involved nodes as described above, and the corresponding indications have been given to the higher layer functions in the nodes of origin and destination, then the signalling connection is established and transmission of messages may commence.

### 1.2.2 Data transfer

Transfer of each NSDU is performed by one or more DT messages; a more-data indication is used if the NSDU is to be split among more than one DT message. If protocol class 3 is used, then SCCP flow control is utilized over each connection section of the signalling connection. If, in this protocol class, abnormal conditions are detected, then the appropriate actions are taken on the signalling connection (e.g. reset). Moreover, in this protocol class, expedited data may be sent using one ED message that bypasses the flow control procedures applying to DT messages.

A limited amount of data may also be transferred in the CR, CC, CREF and RLSD messages.

### **1.2.3 Connection release**

When the signalling connection is terminated, a release sequence takes place on all connection sections by means of two messages called RLSD and RLC. Normally, in reaction to the receipt of an RLSD message the RLC message is sent.

## **1.3 Overview of procedures for connectionless services**

### **1.3.1 General**

When the SCCP functions at the originating node receive from an SCCP user an NSDU to be transferred by the protocol class 0 or 1 connectionless service, the "called address" and other relevant parameters, if required, are analysed to identify the node towards which the message should be sent. The NSDU is then included as the "data" parameter in an XU DT, LU DT or UD T message, which is sent towards that node using the MTP routing functions. If the network structure is such that both LU DT(S) and (X)UD T(S) messages may apply, then the routing may transmit a message other than LU DT(S) (see 2.5). Upon receipt of the XU DT, LU DT or UD T message, the SCCP functions at that node perform the routing analysis as described in clause 2 and, if the destination of the XU DT, LU DT or UD T message is a local user, deliver the NSDU to the local higher layer functions. If the destination of the XU DT, LU DT or UD T message is not at that node, then the XU DT, LU DT or UD T message is forwarded to the next node after a possible change of the type of message (see 2.5). This process continues until the destination is reached.

### **1.3.2 Segmentation/reassembly**

"SCCP connectionless segmentation" is a service provided transparently to the SCCP user, which allows connectionless transfer of a block of user data larger than can be contained in a single (X)UD T message. The SCCP provides this service by segmenting a large block of user data into smaller blocks (called segments), transmitting the segments as user data in XU DT messages (the use of LU DT messages for this purpose is for further study), and reassembling the segments in the destination node before passing the original block of user data to the (remote) destination SCCP user. At the destination SCCP, this reassembling process is called reassembly.

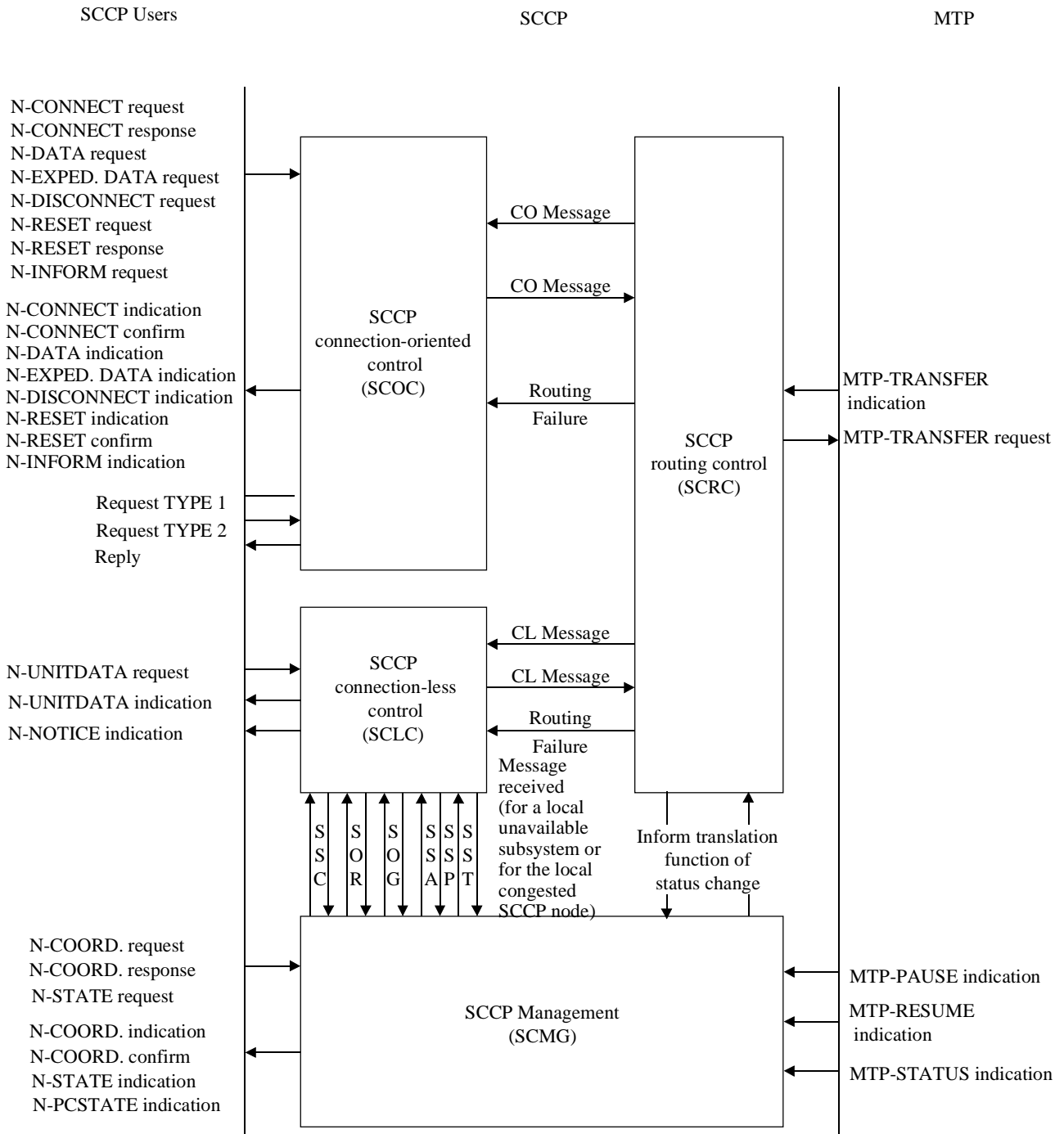
## **1.4 Structure of the SCCP and contents of this Recommendation**

The basic structure of the SCCP appears in Figure 1. It consists of four functional blocks as follows:

- a) SCCP connection-oriented control (SCOC): its purpose is to control the establishment and release of signalling connections and to provide for data transfer on signalling connections.
- b) SCCP connectionless control (SCLC): its purpose is to provide to an SCCP user and the SCCP management a service for the connectionless transfer of data units inside SCCP-SDUs and to support connectionless procedures. Connectionless messages which convey SCCP management information have the SSN "SCCP management".
- c) SCCP management (SCMG): its purpose is to provide capabilities, in addition to the Signalling Route Management and flow control functions of the MTP, to handle the congestion or failure of the SCCP, the SCCP user or the signalling route to the SCCP/SCCP user. The current procedures are limited to entities within the same MTP network.
- d) SCCP routing control (SCRC): upon receipt of a message from the MTP or from functions a) or b) above, SCCP routing provides the necessary routing functions to either forward the message to the MTP for transfer, or pass the message to functions a) or b) above. If the "called address" or "called party address" is a local user, then the message is passed to functions a) or b), while one destined for a remote user is forwarded to the selected MTP-SAP instance for transfer to a distant SCCP user unless a compatibility test occurs

which results in passing the message to function b). Routing control identifies the MTP-SAP instance through which the message is delivered to an MTP network.

The contents of this Recommendation are as follows. Clause 2 describes the addressing and routing functions performed by the SCCP. Clause 3 specifies the procedures for the connection-oriented services (protocol classes 2-3). Clause 4 specifies the procedures for the connectionless services (protocol classes 0-1). Clause 5 specifies the SCCP management procedures.



T1178440-96

Figure 1/Q.714 – SCCP overview

## 2 Addressing and routing

### 2.1 SCCP addressing principles

The "called and calling addresses" and the "called and calling party addresses" normally contain the information necessary, but not always sufficient, for the SCCP to determine an originating and destination node.

In the case of the connectionless procedures, the addresses are normally the originating and destination nodes of the message.

In the case of the connection-oriented procedures, the addresses are normally the originating and destination nodes of the signalling connection section. However, the called party address of a CR message identifies the destination node and the calling party address of the CR message may identify the originating node of the signalling connection (see 2.7 for more detail on calling party addresses).

For the transfer of the CR message or connectionless messages, two basic categories of addresses are distinguished by the SCCP, addresses requiring translation and addresses requiring no translation:

- 1) When a translation is required, then a Global Title shall be present – A global title is an address, such as dialled-digits, which does not explicitly contain information that would allow routing in the signalling network, that is, the translation function of the SCCP is required. This translation function could be performed on a distributed basis or on a centralized basis. The latter case, where a request for translation is sent to a centralized database, may be accomplished, for example, with Transaction Capabilities (TC).
- 2) When a translation is not required, then the DPC + SSN shall be present – A Destination Point Code and Subsystem Number allows direct routing by the SCCP and MTP, that is, the translation function of the SCCP is not required.

If a reply, a message return, or segmentation in connectionless mode is required, then the "calling party address" plus the OPC in the MTP routing label shall contain sufficient information (together with the identity of the incoming MTP-SAP instance) to uniquely identify the originator of the message.

### 2.2 SCCP routing principles

The SCCP routing control (SCRC) receives messages from an MTP-SAP instance for routing, after they have been received by the MTP from another node in the signalling network. SCRC also receives internal messages from SCCP connection-oriented control (SCOC) or from SCCP connectionless control (SCLC) and performs any necessary routing functions (e.g. address translation) before passing them to the selected MTP-SAP instance for transport in the signalling network or back to the SCCP connection-oriented, or SCCP connectionless control.

The routing functions consist of:

- 1) determining a SCCP node towards which the message is allowed to be sent;
- 2) performing the compatibility test;
- 3) providing a traffic limitation mechanism.

#### 2.2.1 Receipt of SCCP message transferred by the MTP

A message transferred by the MTP that requires routing will include the "called party address" parameter giving information for routing the message. The messages which require to invoke a routing function are the CR message and all types of connectionless messages. All connection-oriented messages except the CR message are passed directly to SCOC.

NOTE – The called party address in the CREF or CC messages shall not be used for routing.

If the "called party address" parameter is used for routing, then the routing indicator determines whether routing is based on:

- 1) Subsystem Number (SSN) – This indicates that the receiving SCCP is the destination node of the message. The SSN is used to determine the local subsystem.
- 2) Global Title (GT) – This indicates that translation is required. Translation of the Global Title results normally in a Destination Point Code (DPC and an internal identification of the MTP-SAP instance to which the MTP-TRANSFER primitive shall be issued) for routing the message, the routing indicator and possibly a new SSN or GT or both. The SCCP routing function also provides additional information needed for the MTP-TRANSFER (OPC, SLS and SIO; this information is passed to the MTP in the form of parameters in the MTP-TRANSFER request primitive).

Even if an SPC is present in the "called party address" parameter, it shall not be used by SCRC.

### **2.2.2 Messages passed from connection-oriented or connectionless control to SCCP routing control**

Addressing information, indicating the destination of the message, is provided in every internal message the SCCP routing control receives from connection-oriented or connectionless control.

For XUDT, LUDT or UDT messages, this addressing information is obtained from the "called address" parameter contained in the N-UNITDATA request primitive.

For CR messages received by SCCP routing, the addressing information is obtained from the "Called address" parameter contained in the N-CONNECT request primitive or from the addressing information contained in the received CR message and made available to SCOC (the latter case refers to relay node with coupling).

For connection-oriented messages other than a CR message, the addressing information is that associated with the connection section over which the message is to be sent.

The addressing information can take the following forms:

- 1) DPC + MTP-SAP instance;
- 2) DPC + MTP-SAP instance + one of the following cases;
  - a) SSN different from zero;
  - b) GT or GT + SSN equal to zero;
  - c) GT + SSN different from zero;
  - d) SSN equal to zero.
- 3) GT with or without SSN.

The first form applies to connection-oriented messages except the CR message. The last two forms apply to connectionless messages and to the CR message.

#### **2.2.2.1 DPC present**

If the DPC is present in the addressing information and the DPC is not the node itself, then the message is passed to the selected MTP-SAP instance using the MTP-TRANSFER request primitive with addressing information as follows:

- 1) if no other addressing information is available (case 1 of 2.2.2), no "called party address" is provided in the message;
- 2) if a non-zero SSN is present but not the GT [case 2 a) of 2.2.2], then the called party address provided shall contain this SSN and the routing indicator shall be set to "Route on SSN";



- 3) if the GT is present but no SSN or a zero SSN is present [case 2 b) of 2.2.2], then the DPC identifies where the global title translation occurs. The called party address provided shall contain this GT and the routing indicator shall be set to "Route on GT";
- 4) if a non-zero SSN and the GT are both present [case 2 c) of 2.2.2], then the called party provided shall contain both the SSN and the GT. The Routing Indicator could be set to either "Route on GT" or "Route on SSN". The mechanism for the selection of the Routing Indicator is outside the scope of this Recommendation;
- 5) if an SSN equal to zero is present but not a GT [case 2 d) of 2.2.2], then the address information is incomplete and the message shall be discarded. This abnormality is similar to the one described in 3.10.1, item 1) b6.

If the DPC is the node itself, and:

- 1) if a non-zero SSN is present but not the GT [case 2 a) of 2.2.2], then the message is passed based on the message type to either connection-oriented control or connectionless control and based on the availability of the subsystem;
- 2) if the GT is present but no SSN or a zero SSN is present [case 2 b) of 2.2.2], then the message is passed to the translation function;
- 3) if a non-zero SSN and the GT are both present [case 2 c) of 2.2.2], then it is an implementation dependent matter whether or not the message is passed to the translation function;
- 4) if an SSN equal to zero is present but not a GT [case 2 d) of 2.2.2], then the address information is incomplete and the message shall be discarded. This abnormality is similar to the one described in 3.10.1, item 1) b6.

#### **2.2.2.2 DPC not present**

If the DPC is not present, (case 3 of 2.2.2), then a global title translation is required before the message can be sent out. Translation results in a DPC and possibly a new SSN or new GT or both. If the GT and/or SSN resulting from a global title translation is different from the GT and/or SSN previously included in the called address or called party address, the newly produced GT and/or SSN replaces the existing one. The translation function of the SCRC will also set the RI, select the appropriate MTP-SAP instance and provide information needed for the MTP transfer (OPC, SLS and SIO). The routing procedures then continue as per 2.2.2.1.

### **2.3 SCCP routing procedures**

The SCCP routing functions are based on information contained in the "called party address" or "called address".

#### **2.3.1 Receipt of SCCP messages transferred by the MTP**

When a message is received in SCRC from the MTP, and if the local SCCP or node is in an overload condition, SCRC shall inform SCMG.

One of the following actions shall be taken by SCRC upon receipt of a message from the MTP. The message is received by the SCCP when the MTP invokes an MTP-TRANSFER indication primitive.

- 1) If the message is a connection-oriented message other than a CR message, then SCRC passes the message to SCOC.
- 2) If it is a CR message or a connectionless message and the routing indicator in the "called party address" indicates "Route on SSN", then SCRC checks the status of the local subsystem:

- a) if the subsystem is available, the message is passed, based on the message type, to either SCOC or SCLC;
- b) if the subsystem is unavailable, and:
  - the message is a connectionless message, then the message return procedure is initiated;
  - the message is a CR message, then the connection refusal procedure is initiated.

In addition, SCCP management is notified that a message was received for an unavailable subsystem.

- 3) If it is a CR message or a connectionless message and the routing indicator in the "called party address" indicates "Route on GT", then a translation of the global title must be performed.

The SCCP Hop Counter (if present) is decremented and if a Hop Counter violation is encountered (i.e. the value zero is reached), then:

- if the message is a connectionless message, then the message return procedure is initiated;
- if the message is a CR message, then the connection refusal procedure is initiated.

In addition, maintenance functions are alerted.

- a) If the translation of the global title is successful (see 2.4.4), then:
  - i) if the DPC is the node itself, then the message is passed, based on the message type, to either SCOC or SCLC;
  - ii) if the DPC is not the node itself and the message is a connectionless message, then the MTP-TRANSFER request primitive is invoked unless the compatibility test sends the message to SCLC or unless the message is discarded by the traffic limitation mechanism;
  - iii) if the DPC is not the node itself and the message is a CR message, then:
    - if a coupling of connection sections is required, the message is passed to SCOC;
    - if no coupling of connection sections is required, the MTP-TRANSFER request primitive is invoked unless the message is discarded by the traffic limitation mechanism.
- b) In all other cases:
  - if the message is a connectionless message, then the message return procedure is initiated;
  - if the message is a CR message, then the connection refusal procedure is initiated.

### **2.3.2 Messages from connectionless or connection-oriented control to SCCP routing control**

One of the following actions is taken by SCCP routing upon receipt of a message from connectionless control or connection-oriented control.

- 1) If the message is a CR message at a relay node with coupling (where connection sections are being associated), then the MTP-TRANSFER request primitive is invoked taking into account the result of the global title translation already done.
- 2) If the message is a connection-oriented message other than a CR message, and:
  - the DPC and remote SCCP are available, then the MTP-TRANSFER request primitive is invoked unless the message is discarded by the traffic limitation mechanism;
  - the DPC and/or remote SCCP are not available, then the connection release procedure is initiated.

- 3) If the "Called address" in the primitive associated with a CR message or connectionless message includes one of the following combinations from Table 1, then one of the four actions described below is taken.

**Table 1/Q.714 – Actions upon receipt of a message from connectionless control or a CR from connection-oriented control**

	<b>No GT No SSN or SSN = 0</b>	<b>GT No SSN or SSN = 0</b>	<b>No GT SSN</b>	<b>GT SSN</b>
No DPC	(4)	(2)	(4)	(2)
DPC = own node	(4)	(2)	(1)	(1), (2) (Note)
DPC = remote node	(4)	(3)	(1)	(1), (3) (Note)
NOTE – The choice of the appropriate action is outside the scope of this Recommendation.				

**Action (1)**

- a) If the DPC is not the node itself and the remote DPC, SCCP and SSN are available, then the MTP-TRANSFER request primitive is invoked unless the compatibility test returns the message to SCLC or unless the message is discarded by the traffic limitation mechanism;
- b) If the DPC is not the node itself and the remote DPC, SCCP and/or SSN are not available, then:
  - for connectionless messages, the message return procedure is initiated;
  - for CR messages, the connection refusal procedure is initiated.
- c) If the DPC is the node itself, then the procedures in Section 2.3.1, item 2) above are followed<sup>1</sup>.

**Action (2)**

- a) If the translation of the global title is successful (see 2.4.4), then:
  - if the DPC is the node itself, then the message is passed, based on the message type, to either SCOC or SCLC;
  - if the DPC is not the node itself, then the MTP-TRANSFER request primitive is invoked unless the compatibility test returns the message to SCLC or unless the message is discarded by the traffic limitation mechanism.
- b) If the translation of the global title is unsuccessful (see 2.4.4), and:
  - the message is a connectionless message, then the message return procedure is initiated;
  - the message is a CR message, then the connection refusal procedure is initiated.

**Action (3)**

The same actions as Action (1) apply, without checking the SSN.

<sup>1</sup> The function of routing between local subsystems is implementation dependent.

## **Action (4)**

The "called address" contains insufficient information. If:

- the message is a connectionless message, then the message return procedure is initiated;
- the message is a CR message, then the connection refusal procedure is initiated.

## **2.4 Global title translation**

### **2.4.1 General characteristics of the GTT**

The Global Title Translation (GTT) function shall be invoked within the SCCP routing control (SCRC) under the routing procedures described in 2.3.

If the GTT function results in a "routing indicator" (see 3.4.1/Q.713) equal to "Route on GT", then the GTT function must provide a global title and the DPC of the SCCP node where that global title will be translated. This process shall be repeated until the GTT function results in a "routing indicator" equal to "Route on SSN", which means that the final destination has been determined.

The global title addressing capability and the GTT function allow diverse groups of the SCCP addressable entities associated with different applications to establish their own addressing schemes. All the application-specific addressing schemes requiring the GTT shall be specified within the GTT procedural framework stated in this subclause.

### **2.4.2 Terminology definitions**

#### **2.4.2.1 GT information**

The GT information is made up of the Global Title Indicator (GTI) and the Global Title (GT).

##### **1) Global Title Indicator (GTI)**

Refer to 3.4.1/Q.713 and 3.4.2.3/Q.713 for the list of global title indicators recognized by the SCCP. The global title indicator is used to determine the content and format of the global title.

##### **2) Global Title (GT)**

The global title consists of the mandatory Global Title Address Information (GTAI) and one or more of the following information elements depending on the GTI:

###### **a) Encoding Scheme (ES)**

Refer to 3.4.2.3/Q.713 for the list of encoding schemes recognized by the SCCP. The encoding scheme indicates how the global title address information is encoded. If the encoding scheme is included, then the global title address information shall be decoded accordingly. If the encoding scheme is not included but translation type is included, then the translation rules associated with the translation type should specify the encoding scheme. Refer to d) and 3) for the description of the translation type and translation rules. The meaning of each encoding scheme value is identical for all the GTI values indicating that the encoding scheme is included.

###### **b) Numbering Plan (NP)**

Refer to 3.4.2.3.3/Q.713 for the list of numbering plans recognized by the SCCP. The numbering plan indicates how the global title address information is constructed from different parts (e.g. country codes, subscriber number or national significant number) according to the syntax and semantic defined for that particular numbering plan. The semantic of each numbering plan value is identical for all the GTI values indicating that the numbering plan is included.

c) **Nature of Address Indicator (NAI)**

Refer to 3.4.2.3.1/Q.713 for the list of nature of address indicator values recognized by the SCCP. The nature of address indicator defines the "scope" of the global title address information for a specific numbering plan. The semantic of the nature of address indicator value depends only on the numbering plan. In particular, it does not depend on GTI values.

d) **Translation Type (TT)**

Refer to 3.4.2.3.2/Q.713 for the list of translation types recognized by the SCCP, and refer to Annex B/Q.713 for the TT values recognized by SCCP when GTI is set to 4. The translation type together with the numbering plan and the nature of address indicator determines a specific translator which defines a specific set of translation rules.

A particular TT value shall implicitly specify the encoding scheme of the GTAI value if the encoding scheme is not included for a particular GTI.

A TT value is unique only within the context of a GTI.

3) **Translation rules**

A set of rules specifies which type of SCCP addressable entities, associated with some service/application must be unambiguously addressed with the global title address information, and how the global title address information should be interpreted by the GTT function.

The translation rules should specify which portion of the GTAI is required to unambiguously identify or distinguish one SCCP addressable entity from another pertaining to the applications. However, the rules should not specify which GTAI portion is to be translated to which DPC or DPC + SSN. The determination of the DPC and SSN is implementation-specific and requires local information (see 2.4.3.1) specific to the destination network. The translation rules may specify if the SSN is to be determined from the translation.

4) **Identification of translation rules**

The translation rules shall be uniquely identified by the GTI and its associated TT, NP and NAI values.

**2.4.2.2 Other definitions used in the GTT function**

1) **SCCP Entity**

An SCCP Entity is a local MTP-SAP + a DPC + possibly an SSN.

NOTE – An SCCP Entity with an SSN equal to zero (SSN not known or not used) is different from an SCCP Entity without an SSN value.

2) **SCCP Entity Set**

An SCCP Entity Set is made of one SCCP Entity or is made of two SCCP Entities of the same type (if an SSN is present in one SCCP Entity, then an SSN shall also be present in the other). In the latter case the two SCCP Entities may be considered either as a "primary" SCCP Entity and a "backup" SCCP Entity or may be interpreted as two equal SCCP Entities that can be used for a loadsharing purpose.

3) **DPC**

A DPC is significant only in a given MTP network. Because an SCCP gateway manages several MTP networks, a DPC, as a result of the global title translation, could be accompanied by an identification of the concerned MTP network that is the MTP-SAP instance.

### **2.4.3 Input of the GTT function**

The following types of information can be an input for the GTT function.

#### **2.4.3.1 Local information (mandatory input)**

The local information contains firstly the routing information and secondly the management information.

- The routing information is specific to the implementation network and is administratively input to the GTT function. They are static data implementing the "translation rules" required to translate the global title address information for the applications.
- The management information is specific to the state of the network in terms of availability. They are dynamic data reflecting the accessibility of the SCCP nodes (accessibility at the MTP and SCCP level) and the accessibility of the subsystems handled by the different SCCP nodes.

#### **2.4.3.2 GT information (mandatory input)**

The GT information is a required input for the GTT function. It contains:

- the GTI value;
- the TT, NP, NAI and ES values depending on the GTI;
- the GTAI value.

#### **2.4.3.3 SSN (mandatory input if present)**

Even if SSN equals zero, the SSN is a mandatory input of the GTT function.

#### **2.4.3.4 Loadsharing information**

If the GTT function is able to handle a loadsharing mechanism, then the SLS may be an input for the GTT function.

### **2.4.4 Output of the GTT function**

Three types of output are possible for the GTT function:

- A "successful" output which contains the required parameters to route the message forward in the network or to distribute the message.
- An "unsuccessful" output where no translation exists for the given input (see steps 1, 2 and 4 described in 2.4.5). The failure causes are "no translation for an address of such nature" or "no translation for this specific address".
- An "unsuccessful" output where the translation exists but no available destination can be found (see step 4 described in 2.4.5). The failure causes may be "MTP failure", "SCCP failure" or "subsystem failure".

Refer to 2.6 for the causes used in RLSD, CREF, XUDTS, LUDTS or UUDTS messages.

The two key outputs for the "normal" output of the GTT function are the DPC and the routing indicator.

If the routing indicator is set to "Route on SSN" then the SSN is a required output of GTT function. The subsystem defined by DPC + SSN is expected to be accessible from SCRC. The DPC may be a local DPC in the case of a GT translation in the destination node. The GT information as an output is optional.

If the routing indicator is set to "Route on GT", then the GT information is a required output of the GTT function and the DPC provided is expected to be accessible. The GT information is made up of the GTAI and TT, NP, NAI, ES with the corresponding GTI. The SSN is an optional output.

#### **2.4.5 Global title translation function**

When the GTT function is invoked by the SCRC, the GTT function shall perform the following steps:

- 1) Step 1: the GTI and the three optional parameters TT, NP and NAI should be unambiguously associated to a translator which defines a set of translation rules. If this translator cannot be determined, the GTT function shall be aborted with the cause "no translation for an address of such nature".
- 2) Step 2: the set of translation rules determined by step 1 is used to analyse the GTAI possibly accompanied by the encoding scheme. If no output exists for this GTAI, then the GTT function shall be aborted with the cause "no translation for this specific address". Otherwise the output of this step 2 is at least the Routing Indicator (RI) and an SCCP Entity Set. In addition, if the routing indicator is set to "Route on GT", then a GT information is a mandatory output otherwise the GT information as an output is optional.
- 3) Step 3: if an SSN is available as a GTT function input, then the step 3 consists of using this input SSN as a default value if some SSN are missing in the SCCP Entity Set. It may happen that the value zero appears as an SSN value in the SCCP Entity Set: this is a correct value which overwrites the SSN given as input of the GTT function.
- 4) Step 4: this is where the management information is taken into account and where a loadsharing mechanism can be implemented.

By definition an SCCP Entity is declared accessible when the two following conditions are fulfilled:

- The DPC concerned is accessible (at MTP and SCCP level) or the DPC corresponds to the local node.
- If the routing indicator is set on "Route on SSN", then an SSN is present and different from zero and this subsystem is accessible in the node defined by the DPC:
  - a) If the SCCP Entity Set contains only one SCCP Entity and this SCCP Entity is inaccessible, then the result of the GTT function is "MTP failure", "SCCP failure" or "subsystem failure". When the routing indicator is set to "Route on SSN" and if the inaccessibility is due to the absence of SSN in the SCCP Entity or due to an SSN value equal to zero, then the result of the GTT function shall be "no translation for this specific address".

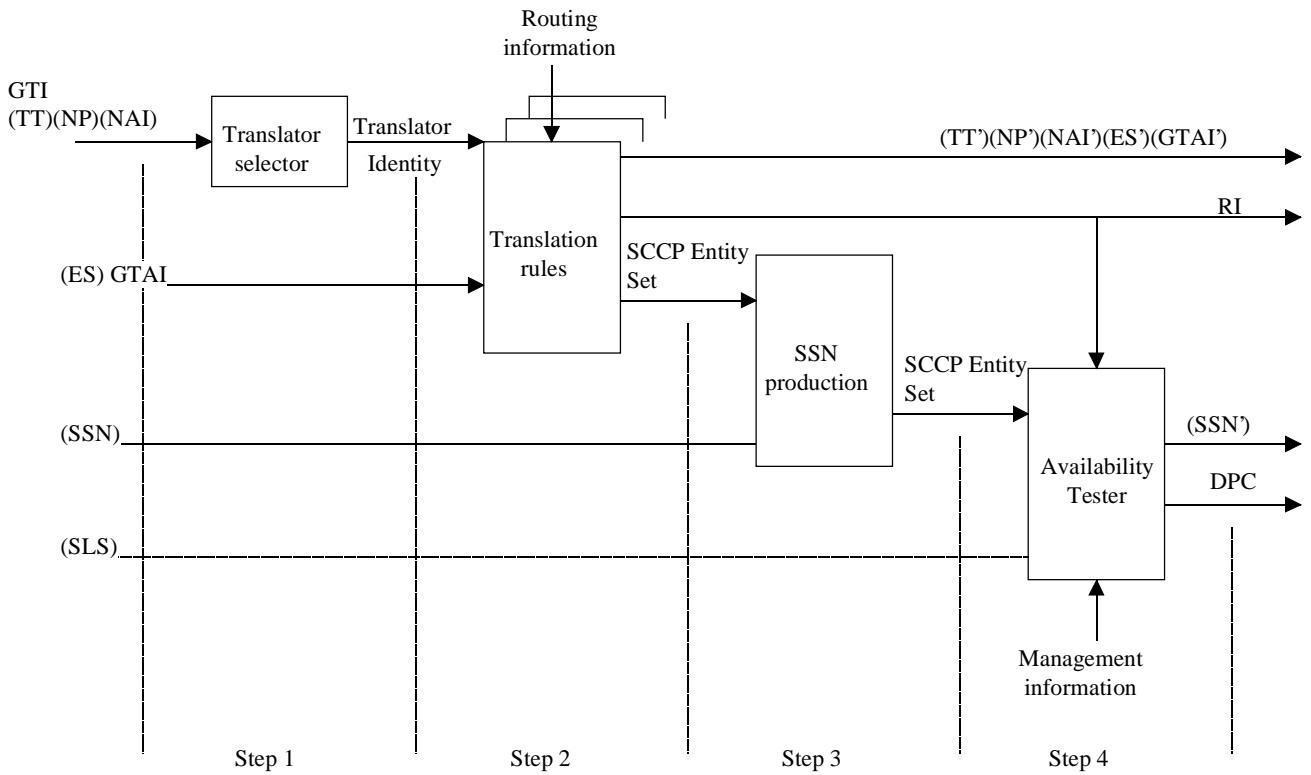
- b) If the SCCP Entity Set contains only one SCCP Entity and this SCCP Entity is accessible, then:
  - If the routing indicator is set to "Route on GT", then the outputs of the GTT function are the RI and the GT information as an output of step 2, the DPC found in the SCCP Entity and possibly the associated SSN as an output of step 3;
  - If the routing indicator is set to "Route on SSN", then the outputs of the GTT function are the RI and possibly the GT information as an output of step 2, and the DPC and SSN found in the SCCP Entity as an output of step 3.
- c) If the SCCP Entity Set contains two SCCP Entities and if there is no loadsharing mechanism, then the accessibility of the "primary" SCCP Entity is checked. If this "primary" SCCP Entity is accessible, then this "primary" SCCP Entity is selected as part of the GTT function result. If the "primary" SCCP Entity is inaccessible, then the accessibility of the "backup" SCCP Entity is checked. If this "backup" SCCP Entity is accessible, then this "backup" SCCP Entity is selected as part of the GTT function result. If the "backup" SCCP Entity is inaccessible, then the result of the GTT function is "MTP failure", "SCCP failure" or "Subsystem failure" (if the refusal or return causes are different for both SCCP Entities it is an implementation dependent matter which one is selected). If the inaccessibility is due to the absence of SSN in the two SCCP Entities or due to SSN values equal to zero when the routing indicator is set to "Route on SSN", then the result of the GTT function shall be "no translation for this specific address".
- d) If the SCCP Entity Set contains two SCCP Entities and if there is a loadsharing mechanism implemented, then one of the two SCCP Entities is chosen depending on the loadsharing information and on the accessibility of the SCCP Entities. If one SCCP Entity can be chosen, then this SCCP Entity is selected as part of the GTT function result. If the SCCP Entities are both inaccessible, then the result of the GTT function is "MTP failure", "SCCP failure" or "Subsystem failure" (if the refusal or return causes are different for both SCCP Entities it is an implementation dependent matter which one is selected). If the inaccessibility is due to the absence of SSN in the two SCCP Entities or due to SSN values equal to zero when the routing indicator is set to "Route on SSN", then the result of the GTT function shall be "no translation for this specific address".

Figure 2 shows the different steps of the global title translation function as well as the parameters used in this global title translation function.

In this figure:

- an in-bracket parameter means an optional parameter;
- the dashed line with the SLS parameter means that the loadsharing functionality itself is not required in a given implementation. If this functionality is present, then the SLS parameter may be an input parameter.





T1178450-96

**Figure 2/Q.714 – Steps and parameters of the global title translation function**

## 2.5 Compatibility test

The compatibility test defined in this subclause applies to connectionless procedures only.

If the network structure is such that incompatibilities requiring segmentation, truncation or message type change are never present, then the compatibility test is not required.

Based on the available knowledge at the local node, the compatibility test ensures that:

- 1) The SCRC never attempts to send a message that cannot be understood by the recipient SCCP node.
- 2) The outgoing messages are of the appropriate length to be carried by the underlying MTP.

The compatibility test in SCRC determines whether:

- 1) An LUDT message needs to be segmented.
- 2) An LUDTS message needs to be truncated.
- 3) The message type needs to be changed. In some cases, a message may be changed to a type preferred by the recipient node (see 4.1.2).

If no segmentation, truncation or message type change is required, then the MTP-TRANSFER primitive is invoked unless the message is discarded by the traffic limitation mechanism (see 2.6). Otherwise, the message is passed to SCLC for the necessary changes.

## 2.6 Traffic limitation mechanism

The SCCP congestion control procedures may be subject to improvement pending further analysis of the impact of these procedures in different network scenarios and based on the results of operational experience.

### 2.6.1 General

The MTP notifies the SCCP of unavailable or congested remote signalling points or remote SCCP unavailability using the appropriate MTP-PAUSE indication or MTP-STATUS indication primitive. The SCCP then informs its users.

Each destination (DPC + MTP-SAP instance) is associated with a Restriction Level (RL) and a RestrictionSubLevel (RSL) which are reported by SCMG (see 5.2.4).

These levels, together with the importance of the message to be sent, allow the reduction of the traffic towards a congested node by discarding a portion of the concerned traffic.

### 2.6.2 Importance of a message

Whenever a message is to be sent, its importance is the minimum of the permitted maximum importance value for the message type (See Table 2), and:

- a) at the originating node the importance value (if provided) in the request or response primitive (otherwise the default value from Table 2 applies);
- b) at a relay node:
  - the importance value received in the incoming message contained in the optional parameter "importance" (CR, CC, CREF, RLSD, XUDT, XUDTS, LUDT or LUDTS);  
or
  - a value derived from the national option of the priority field in the SIO in the MTP field;  
otherwise
  - a default value assigned from Table 2.

If there is a conflict between the importance parameter and a value derived from the SIO in a received message then the importance value used is a network choice.

**Table 2/Q.714 – Default and maximum importance value**

Message type	Default importance	Max importance	Message type	Default importance	Max importance
CR	2	4	RSC	6	–
CC	3	4	ERR	7	–
CREF	2	4	RLC	4	–
DT1	4	6	RLSD	6	6
DT2	4	6	UDT	4	6
AK	6	–	UDTS	3	–
IT	6	–	XUDT	4	6
ED	7	–	XUDTS	3	–
EA	7	–	LU DT	4	6
RSR	6	–	LU DTS	3	–

The "-" means that the message type is not generated as a result of a primitive from the SCCP user therefore the default importance value always applies.

NOTE – The values in Table 2 might be revised as operational experiences are gained. How these default and maximum values should be administered is implementation dependent.

When in a national network the importance information is carried in the priority level in the SIO, then it is the task of the gateway between a national network and the international network to provide the mapping between the importance parameter in the SCCP message and the priority in the SIO.

### 2.6.3 Handling of messages to a congested node

When a message has to be sent towards a remote SCCP node, the importance of the message is compared to the restriction level of that remote SCCP node:

- If the importance of the message is greater than RL, then the MTP-TRANSFER primitive is invoked.
- If the importance of the message is lower than RL, then the message is discarded.
- If the importance of a message is equal to RL, then the message shall be discarded proportionately as determined by the RSL value. The portion of traffic reduction is considered to be network specific. For the international network, the following values are provisionally assigned:
  - RSL = 0 ⇒ 0% of traffic discarded.
  - RSL = 1 ⇒ 25% of traffic discarded.
  - RSL = 2 ⇒ 50% of traffic discarded.
  - RSL = 3 ⇒ 75% of traffic discarded.

When a message has to be discarded then:

- for connectionless messages, the message return procedure is initiated;
- for CR messages, the connection refusal procedure is initiated;

- for CO messages other than the CR message no additional actions are taken. If the message was locally originated, the SCCP may inform the user of the discard by issuing an N-INFORM primitive.

## **2.7 Calling party address treatment**

### **2.7.1 Address indicator**

The segmenting/reassembly process of connectionless messages requires that an unambiguous calling party address is passed in each segment. The practice of "deleting" the calling party address from an XUDT or LUDT or UDT message by coding its "Address Indicator" bit 1...7 to zero shall not be used for evolving applications, because at some time their messages may grow beyond the limit supported by one (X)UDT message.

### **2.7.2 Calling party address in the international network**

It is the task of the outgoing international gateway<sup>2</sup> (or originating international node) to make sure that the calling party address or responding address (i.e. called party address parameter in a CC or CREF message) satisfies the following rules:

- If routing is based on SSN, the DPC, if present, is one as defined in Recommendation Q.708, the SSN must be present and should be internationally standardized.
- If routing is based on GT, the GTI must be equal to 4, the SSN is either one of the internationally standardized numbers, or, if there is no SSN standardized for the application, the SSN must be coded "unknown". SSN allocated for national use should not be passed over the international network. Such SSNs might interfere with the SSN used in following networks, and also with the traffic measurements, accounting or screening mechanisms.
- The Global Title must have international significance. Within a national network, it is a national option to decide on the scope ("significance") of the calling/responding party addresses. However, when the address is only locally or nationally significant, it may be necessary to change the address in relay or gateway nodes by adding a trunk code or country code. This is the case whenever the message is routed outside the domain where the address is valid.

The incoming international gateway (or possibly any other node) may, as part of its optional screening procedures, provide tests to verify the principles specified above. The screening procedures are further specified in 2.7.4.

### **2.7.3 Routing indicator**

When the called party address in an XUDT or LUDT or UDT message has the routing indicator set on "Route on GT", the routing indicator in the calling party address shall also be set to "Route on GT", unless the destination is in the same MTP network and that its MTP routing tables allows the message to be routed back.

For a CR message, the calling party address may be of the form "Route on SSN" because the subsequent messages will be routed section by section.

### **2.7.4 Screening**

Screening is an optional network specific function.

---

<sup>2</sup> An international gateway is an SCCP node having an MTP-SAP instance for the international network and at least one MTP-SAP instance for a national network.

Further screening of the received calling party address may be performed in a node to check, for example, whether a valid translator for NP/TT/NAI is available and/or whether the calling party digits are allowable.

### 2.7.5 Inclusion of OPC in the calling party address

The rules described in the following subclauses apply.

#### 2.7.5.1 LUDT or XUDT or UDT message

a) *Originating node*

When the routing indicator of the called party address is set on "Route on GT" and the routing indicator of the calling party address is set on "Route on SSN", the SCCP routing function should include the OPC in the calling party address. In all other cases the inclusion of the OPC in the calling party address is irrelevant.

b) *Relay node*

When the routing indicator of the calling party address is set on "Route on SSN", and no SPC is present in it, then the OPC from the MTP routing label shall be taken and inserted into the calling party address before sending the message to the next node. When crossing MTP boundaries the value "Route on SSN" is however not allowed (refer to 2.7.2).

c) *Terminating node*

When the routing indicator of the calling party address is set on "Route on SSN" and an SPC is present in the calling party address, then this SPC identifies the originating SCCP node.

When the routing indicator of the calling party address is set on "Route on SSN" and no SPC is present in the calling party address, then the OPC in the MTP routing label identifies the originating SCCP node.

#### 2.7.5.2 CR message

a) *Originating node*

If the routing indicator of the called party address is set on "Route on GT" and it is known that no coupling will take place in the next relay node, then the SCCP routing function should include a calling party address (also when not given by the local SCCP subsystem), and in the calling party address the OPC is included.

In this case:                    Routing indicator = Route on SSN  
    SPC = OPC of the originating node  
    SSN = SSN of local subsystem

b) *Relay node without coupling*

The SCCP routing function shall check the calling party address parameters in the received CR message:

- When a calling party address parameter is included and an SPC is present, then the calling party address parameter to be sent to the next SCCP node shall be identical to the calling party address parameter of the received CR message.
- When a calling party address parameter is included and the SPC is absent, then the OPC of the MTP routing label of the received CR message shall be inserted in the calling party address parameter of the CR message to be sent to the next SCCP node. If no SSN is present it may be added with value "unknown".

In this case:                    Routing indicator is unchanged  
    SPC = OPC of the received MTP routing label

SSN and GT are unchanged

- When the calling party address parameter is absent, then a calling party address parameter containing the OPC of the MTP routing label of the received CR message shall be inserted in the CR message to be sent to the next SCCP node. An SSN may be added with value "unknown".

In this case:      Routing indicator = "Route on SSN"  
                          SPC = OPC of the received MTP routing label  
                          SSN = unknown  
                          no GT

c) *Relay node with coupling*

The OPC of the calling party address of the received CR message identifies the originating SCCP node of the incoming connection section. If the calling party address is absent or if no OPC is available in the calling party address, then the OPC of the MTP routing label of the received CR message is taken for identifying the originating SCCP node of the incoming connection section.

The SCCP routing function shall check the calling party address parameter in the received CR message:

- When a calling party address parameter is included and an SPC is present, then the SCCP routing function shall replace the SPC of the received CR message by the OPC of its own node and corresponding to the outgoing MTP network, or shall delete the SPC field from the received calling party address parameter. Deleting the SPC is not advisable, because it means reformatting the message, and it may have to be re-included in the next relay node if no coupling is done there. If no SSN is present it may be added with value "unknown".

In this case:      Routing indicator is unchanged  
                          SPC = OPC of relay node with coupling  
                          SSN and GT are not changed

- When a calling party address parameter is included and the SPC is absent, then the calling party address parameter of the CR message to be sent to the next SCCP node may be identical to the calling party address parameter of the CR message received.

However, if it is known that no coupling will take place in the next relay node, then the SCCP routing function should include an SPC in the calling party address parameter. The SPC is the OPC of its own node and corresponding to the outgoing MTP network.

- When the calling party address parameter is absent no special actions are necessary.

However, if it is known that no coupling will take place in the next relay node, the SCCP routing function should include a calling party address parameter containing an SPC. The SPC is the OPC of its own node and corresponding to the outgoing MTP network.

d) *Terminating node*

The SPC of the calling party address of the received CR message identifies the originating SCCP node of the incoming connection section. If the calling party address is absent or if no SPC is available in the calling party address, then the OPC of the MTP routing label of the received CR message is taken for identifying the originating SCCP node of the incoming connection section.

## **2.8 Routing failures**

When SCCP routing is unable to transfer a message, one of the causes described in 2.8.1 to 2.8.6 is indicated in the RLSA message (refer to 3.11/Q.713, Release cause), the CREF message (refer to 3.15/Q.713, Refusal cause), the XUDTS, the LUDTS or the UDTA message (refer to 3.12/Q.713, Return cause).

When an end node is informed of a routing failure, this information is forwarded towards the SCCP user by using the N-DISCONNECT primitive (refer to reason for release in 2.1.1.2.4/Q.711) or the N-NOTICE primitive (refer to reason for return in 2.2.2.2.4/Q.711). Annex A/Q.713 describes the mapping between the causes found in the messages ( RLSA, CREF, XUDTS, LUDTS or UDTA) and the reasons found in primitives (N-DISCONNECT, N-NOTICE).

### **2.8.1 No translation for an address of such nature**

The translation was invoked for a combination of Translation Type, Numbering Plan and Nature of Address for which no translation exists in this exchange (refer to 2.4.5, Step 1).

The following causes apply:

- Release cause: not applicable.
- Refusal cause: no translation for an address of such nature.
- Return cause: no translation for an address of such nature.

### **2.8.2 No translation for this specific address**

The translation was invoked for a sequence of digits for which no matching (sub)sequence can be found in the translation table, hence translation is inconclusive (refer to 2.4.5, Step 2). The same reason applies also when the RI determined by the GTT is set to "Route on SSN" and an SSN is present neither in the SCCP Entity Set, nor as input of the GTT (refer to 2.4.5, Step 4).

The following causes apply:

- Release cause: not applicable.
- Refusal cause: destination address unknown.
- Return cause: no translation for this specific address.

### **2.8.3 MTP/SCCP/subsystem failure**

The translation fails because no available route could be found for the concerned destination address (refer to 2.4.5, Step 4). This may be due to failures in:

- 1) MTP (destination point inaccessible);
- 2) SCCP (SCCP user part unavailable in relay node or end node);
- 3) SCCP subsystem (subsystem prohibited or unavailable);
- 4) a combination of two of the three above reasons when an alternative route exists and both the normal and the backup routes are unavailable.

The following causes apply:

- for 1:
  - Release cause: MTP failure.
  - Refusal cause: destination inaccessible.
  - Return cause: MTP failure.
- for 2:
  - Release cause: SCCP failure.

- Refusal cause: SCCP failure.
- Return cause: SCCP failure.
- for 3:
  - Release cause: subsystem failure.
  - Refusal cause: subsystem failure.
  - Return cause: subsystem failure.
- for 4:
  - Release cause: MTP failure, SCCP failure or Subsystem failure.
  - Refusal cause: MTP failure, SCCP failure or Subsystem failure.
  - Return cause: MTP failure, SCCP failure or Subsystem failure.

#### **2.8.4 MTP/SCCP/subsystem congestion**

Routing failures due to Subsystem congestion are for further study.

When a routing failure due to MTP/SCCP/nodal congestion is detected the following causes apply:

- In the N-DISCONNECT primitive: QOS not available, transient condition.
- In the N-NOTICE primitive: network congestion.
- In the N-INFORM primitive: network service congestion.
- In the CREF message: QOS unavailable/transient.
- In the XUDTS or LUDTS or UDTS message: network congestion.

#### **2.8.5 Unequipped user**

A local unequipped user is determined by SCRC.

The following causes apply:

- Release cause: not relevant.
- Refusal cause: unequipped user.
- Return cause: unequipped user.

#### **2.8.6 Hop counter violation**

The hop counter reaches zero. It is an indication that an excessive routing could be present.

The following causes apply:

- Release cause: irrelevant.
- Refusal cause: hop counter violation.
- Return cause: hop counter violation.

### **3 Connection-oriented procedures**

#### **3.1 Connection establishment**

##### **3.1.1 General**

The connection establishment procedures consist of the functions required to establish a temporary signalling connection between two users of the SCCP.

The connection establishment procedures are initiated by an SCCP user by invoking the N-CONNECT request primitive.



The ISUP may initiate an SCCP connection in the same way as any other user, but may also request the SCCP to initiate a connection and return the information to the ISUP for transmission in an ISUP message.

The signalling connections between two users of the SCCP, which are referred to by the "Called/Calling address" parameters in the N-CONNECT request primitive, may be realized by the establishment of one or more connection sections. The SCCP user is not aware of how the SCCP provides the signalling connection (e.g. by one or more than one connection sections).

The realization of a signalling connection between two SCCP users then can be described by the following components:

- 1) one or more connection sections;
- 2) an originating node, where the "Calling address" is located;
- 3) zero or more relay nodes with coupling, where, for this signalling connection, there is no distribution to an SCCP user; and
- 4) a destination node, where the "Called address" is located.

The CR message and the CC message are used to set up connection sections.

### **3.1.2 Local reference numbers**

During connection establishment both a source and destination local reference number are assigned independently to a connection section.

Source and destination local reference numbers are assigned at connection section setup for a permanent connection section.

Once the destination reference number is known, it is a mandatory field for all messages transferred on that connection section.

Each node will select the local reference that will be used by the remote node as the destination local reference number field on a connection section for data transfer.

The local reference numbers remain unavailable for use on other connection sections until the connection section is released and the reference numbers are removed from their frozen state. See also 3.3.2.

### **3.1.3 Negotiation procedures**

#### **3.1.3.1 Protocol class negotiation**

During connection establishment, it is possible to negotiate the protocol class of a signalling connection between two SCCP users.

The N-CONNECT request primitive contains a parameter, the "quality of service parameter set", with the preferred quality of service proposed by the SCCP user for the signalling connection.

The SCCP at the originating, relay and destination nodes may alter the protocol class on a signalling connection so that the quality of service assigned to the signalling connection is less restrictive (i.e. a protocol class 2 connection may be provided if a protocol class 3 connection is proposed). Information concerning the present proposed protocol class within the SCCP is carried in the CR message and the assigned protocol class appears in the CC message.

At the destination node the SCCP user is notified of the proposed protocol class using the N-CONNECT indication primitive.

The protocol class of a signalling connection may also be altered by the Called SCCP user in the same manner when invoking the N-CONNECT response primitive.

The Calling SCCP user is informed of the quality of service selected on the signalling connection using the N-CONNECT confirm primitive.

### **3.1.3.2 Flow control credit negotiation**

During connection establishment, it is possible to negotiate the window size to be used on a signalling connection for the purpose of flow control. This window size remains fixed for the life of the signalling connection. The credit field in the CR and CC messages is used to indicate the maximum window size.

The N-CONNECT request primitive contains a parameter, the "quality of service parameter set", with the preferred quality of service proposed by the SCCP user for the signalling connection.

The SCCP at the originating, relay and destination nodes may alter the window size on a signalling connection so that the quality of service assigned to the signalling connection is less restrictive (i.e. a smaller window size may be provided). Information concerning the present proposed window size within the SCCP is carried in the CR message and the assigned maximum window size appears in the credit field of the CC message.

At the destination node the SCCP user is notified of the proposed window size using the N-CONNECT indication primitive.

The window size of a signalling connection may also be altered by the Called SCCP user in the same manner when invoking the N-CONNECT response primitive.

The Calling SCCP user is informed of the quality of service selected on the signalling connection using the N-CONNECT confirm primitive.

### **3.1.4 Actions at the originating node**

#### **3.1.4.1 Initial actions**

The N-CONNECT request primitive is invoked by the SCCP user at the originating node to request the establishment of a signalling connection to the "Called address" contained in the primitive. The node determines if resources are available.

If resources are not available, then the connection refusal procedure is initiated.

If resources are available, then the following actions take place at the originating node:

- 1) A source local reference number and an SLS code are assigned to the connection section.
- 2) The proposed protocol class is determined for the connection section. If this protocol class provides for flow control, then an initial credit is determined.
- 3) A CR message is then forwarded to SCRC for transfer.
- 4) A timer T(conn est) is started.

The ISUP may request the SCCP to set up an SCCP signalling connection and return the information normally carried in a CR message to the ISUP for transmission in an ISUP message.

When the ISUP notifies the SCCP of the need for the connection, using the REQUEST Type 1 interface element, the SCCP determines if resources are available.

If resources are not available, then the connection refusal procedure is initiated.

If resources are available, then the following actions take place at the originating node:

- 1) A source local reference number and an SLS code are assigned to the connection section.
- 2) The proposed protocol class is determined for the connection section. If the protocol class provides for flow control, then an initial credit is determined.
- 3) An indication that the call request is from the ISUP is associated with the connection section.

- 4) The information that would normally be included in a CR message is passed to the ISUP, for transfer, using the REPLY interface element.
- 5) A timer T(conn est) is started.

#### **3.1.4.2 Subsequent actions**

When an originating node receives a CC message, the following actions are performed:

- 1) The received local reference number is associated with the connection section.
- 2) The protocol class and initial credit for flow control of the connection section are updated if necessary.
- 3) The node sending the CC message (identified by the OPC in the MTP label plus the MTP-SAP instance) is associated with the connection section.
- 4) The SCCP user is informed of the successful establishment of the signalling connection using the N-CONNECT confirm primitive.
- 5) The timer T(conn est) is stopped.
- 6) The inactivity control timers, T(ias) and T(iar), are started.

When the SCCP user at an originating node invokes the N-DISCONNECT request primitive, no action is taken prior to receipt of a CC or a CREF message or expiration of the connection establishment timer.

When an originating node receives a CREF message, the connection refusal procedure is completed at the originating node (see 3.2.3).

When the connection establishment timer at the originating node expires or when SCOC is informed of a routing failure, then the N-DISCONNECT indication primitive is invoked, the resources associated with the connection section are released, and the local reference number is frozen.

#### **3.1.5 Actions at a relay node with coupling**

##### **3.1.5.1 Initial actions**

When a CR message is received at a node and the SCCP routing and discrimination function determines that the "called party address" is not a local SCCP user and that a coupling is required at this node, the relay node determines if resources are available to establish the connection section.

If resources are not available at the node or if SCOC is informed of a routing failure, then the connection refusal procedure is initiated.

Otherwise the following actions are performed:

- 1) A local reference number and an SLS code are assigned to the incoming connection section.  
NOTE – As an implementation option, a local reference number and an SLS code may be assigned later upon reception of a CC message.
- 2) The node sending the CR message (identified by the OPC in the calling party address or by default by the OPC in the MTP label, and the MTP-SAP instance) is associated with the incoming connection section.
- 3) An outgoing connection section is initialized:
  - A local reference number and an SLS code are assigned to the outgoing connection section.
  - A protocol class is proposed. If the proposed protocol class provides for flow control, then an initial credit for flow control is determined.
  - The CR message is forwarded to SCRC.

- The timer T(conn est) is started.

4) A coupling is made between the incoming and outgoing connection sections.

The ISUP informs the SCCP that a CR has been received, using the REQUEST Type 2 interface element. The ISUP passes the information contained in the ISUP message to the SCCP and indicates that a coupling is required at this node. The SCCP at the relay node then determines if resources are available to establish the connection section.

If resources are not available at the node, then the connection refusal procedure is initiated.

If resources are available at the node, then the following actions are performed:

- 1) A local reference number and an SLS code are assigned to the incoming connection section.
- 2) A local reference number and an SLS code are assigned to an outgoing connection section.
- 3) A protocol class is proposed.
- 4) An initial credit for flow control is assigned if appropriate.
- 5) A coupling is made between the incoming and outgoing connection sections.
- 6) The information that would normally be included in a CR message is passed to the ISUP for transfer in the REPLY interface element.
- 7) The timer T(conn est) is started.

### **3.1.5.2 Subsequent actions**

When a relay node receives a CC message, the following actions are performed:

- 1) The source local reference number in the CC message is associated with the outgoing connection section.
- 2) The protocol class and initial credit for flow control of the incoming and outgoing connection sections are updated if necessary.
- 3) The originating node of the CC message (identified by the OPC in the MTP label plus the MTP-SAP instance) is associated with the outgoing connection section.
- 4) The CC message is transferred, using the SCCP routing function, to the originating node of the associated connection section. The protocol class and credit are identical to those indicated in the received CC message.
- 5) The timer T(conn est) is stopped.
- 6) The inactivity control timers, T(ias) and T(iar), are started on both connection sections.

When a relay node receives a CREF message, the connection refusal procedure is completed at that node (see 3.2.2).

When the connection establishment timer expires at a relay node, the following actions are performed:

- 1) The resources associated with the connection are released.
- 2) The local reference number is frozen (see 3.3.2).
- 3) If the connection section was established using a REQUEST interface element, then the N-DISCONNECT indication primitive is invoked.
- 4) The connection refusal procedure is initiated on the associated connection section (see 3.2.1).

### **3.1.6 Actions at the destination node**

#### **3.1.6.1 Initial actions**

When a CR message is received at a node, and the SCCP routing and discrimination function determines that the "called party address" is a local user, the destination node determines if resources are available to establish the connection section.

If resources are not available at the node or if SCOC is informed of a routing failure, then the connection refusal procedure is initiated.

If the resources are available at the node, then the following actions are performed:

- 1) A local reference number and an SLS code are assigned to the incoming connection section. (NOTE – As an implementation option, a local reference number may be assigned later upon reception of an N-CONNECT response primitive).
- 2) The originating node of the CR message (identified by the OPC in the calling party address or by default by the OPC in the MTP label, and the MTP-SAP instance) is associated with the incoming connection section.
- 3) A protocol class is proposed. If the proposed protocol class provides for flow control, then an initial credit for flow control is determined.
- 4) The node informs the SCCP user of a request to establish a connection using the N-CONNECT indication primitive.

When the ISUP informs the SCCP that a CR has been received, using the REQUEST Type 2 interface element, the ISUP passes the information contained in the ISUP message to the SCCP, and informs the SCCP that the information is for a local user. The SCCP at the destination node determines if resources are available to establish the connection section.

If resources are not available at the node, then the connection refusal procedure is initiated.

If resources are available at the node, then the following actions are performed:

- 1) The protocol class is determined for the connection section.
- 2) An initial credit for flow control is assigned if appropriate.
- 3) The node informs the ISUP of the request to establish a connection using the N-CONNECT indication primitive.

#### **3.1.6.2 Subsequent actions**

When an N-CONNECT response primitive is invoked by the SCCP user at a destination node, the following actions are performed:

- 1) The protocol class and credit are updated for the connection section if necessary.
- 2) A CC message is transferred to the originating node of the incoming connection section. The protocol class and credit are identical to those indicated in the N-CONNECT response primitive.
- 3) The inactivity control timers, T(ias) and T(iar), are started.

### **3.2 Connection refusal**

The purpose of the connection refusal procedure is to indicate to the Calling SCCP user that the attempt to set up a signalling connection section was unsuccessful.

#### **3.2.1 Actions at node initiating connection refusal**

The connection refusal procedure is initiated by either the SCCP user or the SCCP itself:

- 1) The SCCP user at the destination node:
  - a) uses the N-DISCONNECT request (originator indicates "network service user initiated") after the SCCP has invoked an N-CONNECT indication primitive. This is the case when the SCCP at the destination node has received the CR directly from a preceding SCCP;
  - b) uses the refusal indicator in the REQUEST Type 2 interface element when the SCCP user has received the CR embedded in a user part message.
- 2) The SCCP initiates connection refusal (originator indicates "network service provider initiated") due to:
  - a) limited resources at an originating, relay or destination node;
  - b) expiration of the connection establishment timer at an originating or relay node;
  - c) routing failure.

### **3.2.1.1 Initiating connection refusal at the destination node**

At the destination node, the connection refusal procedure is initiated by either the SCCP (due to lack of resources or routing failure) or the user (by means of an N-DISCONNECT REQUEST primitive). This connection refusal procedure results in the transfer of a CREF message on the connection section. The refusal cause contains the value of the originator in the primitives; if the refusal procedure has been initiated by using the refusal indicator in the REQUEST Type 2 interface element, then the refusal cause contains "SCCP user originated".

### **3.2.1.2 Initiating connection refusal at a relay node**

If the connection refusal procedure is initiated at a relay node due to lack of resources or routing failure, then a CREF message is transferred on the incoming connection section.

If the connection refusal procedure is initiated at a relay node due to expiration of the connection establishment timer, then the connection release procedure is initiated on that connection section (see 3.3.4.1) and a CREF message is transferred on the associated connection section.

In either of the two above cases at a relay node, if the connection setup was initiated using a REQUEST interface element, then the SCCP user is informed by invoking the N-DISCONNECT indication primitive.

### **3.2.1.3 Initiating connection refusal at the originating node**

At the originating node, the connection refusal procedure is initiated by the SCCP (due to lack of resources or routing failure) and the SCCP user is informed by invoking the N-DISCONNECT indication primitive.

## **3.2.2 Actions at a relay node not initiating connection refusal**

When a CREF message is received on a connection section, the following actions are performed:

- 1) The resources associated with the connection section are released and the timer T(conn est) is stopped.
- 2) If the connection was established using a REQUEST interface element, then the SCCP user is informed by invoking the N-DISCONNECT indication primitive.
- 3) A CREF message is transferred on the associated connection section.
- 4) The resources associated with the associated connection section are released.

## **3.2.3 Actions at the originating node not initiating connection refusal**

When a CREF message is received on a connection section, the following actions are performed:

- 1) The resources associated with the connection section are released and the timer T(conn est) is stopped.
- 2) The SCCP user is informed by invoking the N-DISCONNECT indication primitive.

### **3.3 Connection release**

#### **3.3.1 General**

The connection release procedures consist of the functions required to release a temporary signalling connection between two users of the SCCP. Two messages are required to initiate and complete connection release: RLSD and RLC.

The release may be performed:

- a) by either or both of the SCCP users to release an established connection;
- b) by the SCCP to release an established connection.

All failures to maintain a connection are indicated in this way.

#### **3.3.2 Frozen reference**

The purpose of the frozen reference function is to prevent the initiation of incorrect procedures on a connection section due to receipt of a message which is associated with a previously established connection section.

When a connection section is released, the local reference number associated with the connection section is not immediately available for reuse on another connection section. A mechanism should be chosen to sufficiently reduce the probability of erroneously associating a message with a connection section. This particular mechanism is implementation dependent.

#### **3.3.3 Actions at an end node initiating connection release**

##### **3.3.3.1 Initial actions**

When a connection release is initiated at an end node of a signalling connection, by the SCCP user invoking an N-DISCONNECT request primitive or by the SCCP itself, the following actions are performed at the initiating node:

- 1) An RLSD message is transferred on the connection section.
- 2) A release timer T(rel) is started.
- 3) If the release was initiated by the SCCP, then an N-DISCONNECT indication primitive is invoked.
- 4) The inactivity control timers, T(ias) and T(iar), if still running, are stopped.

##### **3.3.3.2 Subsequent actions**

The following actions are performed at the originating node on a connection section for which an RLSD message has been previously transferred:

- 1) When an RLC or RLSD message is received, the resources associated with the connection are released, the timer, T(rel), is stopped, and the local reference number is frozen.
- 2) When the release timer expires, an RLSD message is transferred on the connection section. The sending of the RLSD message is repeated periodically.

When the T(rel) timer expires, T(int) and T(repeat rel) timers are started. An RLSD message is transferred on the connection section. When T(repeat rel) expires during the duration of T(int), it is restarted. An RLSD message is sent each time T(repeat rel) is restarted. Note that if congestion occurs, a longer value of T(repeat rel) might be applied.

When T(int) expires stop T(repeat rel) if still running, release connection resources and freeze the local reference number.

### **3.3.4 Actions at a relay node**

The connection release procedure is initiated at a relay node by the SCCP or by reception of an RLSD message on a connection section.

#### **3.3.4.1 Initial actions**

When an RLSD message is received on a connection section, the following actions then take place:

- 1) An RLC message is transferred on the connection section, the resources associated with the connection are released and the local reference number is frozen.
- 2) An RLSD message is transferred on the associated connection section; the reason is identical to the reason in the received message.
- 3) If the connection was established using a REQUEST interface element, then an N-DISCONNECT indication primitive is invoked.
- 4) The release timer, T(rel), is started on the associated connection.
- 5) The inactivity control timers, T(ias) and T(iar), if still running, are stopped on both connection sections.

When the connection release procedure is initiated by the SCCP at a relay node during the data transfer phase, the following actions take place on both of the connection sections:

- 1) An RLSD message is transferred on the connection section.
- 2) If the connection section was established using an interface element, then an N-DISCONNECT indication primitive is invoked.
- 3) The release timer, T(rel), is started.
- 4) The inactivity control timers, T(ias) and T(iar), if still running, are stopped.

#### **3.3.4.2 Subsequent actions**

The following actions are performed at a relay node during connection release:

- 1) When an RLC or RLSD message is received on a connection section, the resources associated with the connection are released, the timer T(rel) is stopped, and the local reference number is frozen.
- 2) When the release timer expires, an RLSD message is transferred on the connection section. The sending of the RLSD message is repeated periodically.

When the T(rel) timer expires, T(int) and T(repeat rel) timers are started. An RLSD message is transferred on the connection section. When T(repeat rel) expires during the duration of T(int), it is restarted. An RLSD message is sent each time T(repeat rel) is restarted. Note that if congestion occurs a longer value of T(repeat rel) might be applied.

When T(int) expires, stop T(repeat rel) if it is still running, release connection resources and freeze the local reference number.

### **3.3.5 Actions at an end node not initiating connection release**

When an RLSD message is received at an end node of a signalling connection, the following actions are performed on the connection section:

- 1) An RLC message is sent on the connection section.



- 2) The resources associated with the connection section are released, the SCCP user is informed that a release has occurred by invoking the N-DISCONNECT indication primitive, and the local reference number is frozen.
- 3) The inactivity control timers, T(ias) and T(iar), if still running, are stopped.

### 3.4 Inactivity control

The purpose of the inactivity control is to recover from:

- 1) loss of a CC message during connections establishment;
- 2) the unsignalled termination of a connection section during data transfer; and
- 3) a discrepancy in the connection data held at each end of a connection.

Two inactivity control timers, the receive inactivity control timer T(iar) and the send inactivity control timer T(ias), are required at each end of a connection section. The length of the receive inactivity timer must be longer than the length of the longest inactivity timer in the surrounding nodes. It might be advantageous to make sure that the inactivity receive timer T(iar) is at least twice the inactivity send timer T(ias). This avoids that the loss of one single IT message (e.g. due to short term MTP congestion) causes the inadvertent release of an otherwise inactive SCCP connection. Loss of more messages, (e.g. due to SP failure), will however still cause the connection to be released.

When any message is sent on a connection section, the send inactivity control timer is reset.

When any message is received on a connection section, the receive inactivity control timer is reset.

When the send inactivity timer, T(ias), expires, an IT message is sent on the connection section.

The receiving SCCP checks the information contained in the IT message against the information held locally. If a discrepancy is detected, then the following actions (Table 3) are taken:

**Table 3/Q.714**

<b>Discrepancy</b>	<b>Action</b>
Source reference number	Release connection
Protocol class	Release connection
Sequencing/segmenting (Note)	Reset connection
Credit (Note)	Reset connection
NOTE – Does not apply to class 2 connection.	

When the receive inactivity control timer, T(iar), expires, the connection release procedure is initiated on a temporary connection section and OMAP is informed for a permanent connection section.

### 3.5 Data transfer

#### 3.5.1 General

The purpose of data transfer is to provide the functions necessary to transfer user information on a temporary or permanent signalling connection.

##### 3.5.1.1 Actions at the originating node

The SCCP user at the originating node requests transfer of user data on a signalling connection by invoking the N-DATA request primitive.

The DT message is then generated, which must be transferred on the connection section. If flow control procedures apply to the connection section, then these procedures must be enacted before the message can be forwarded on the connection section.

#### **3.5.1.2 Actions at a relay node**

If a signalling connection consists of more than one connection section, then one or more relay nodes are involved in the transfer of DT messages on the signalling connection.

When a valid DT message is received on an incoming connection section at a relay node, the associated outgoing connection section is determined. The relay node then forwards the DT message to the associated outgoing connection section for transfer to the distant node. If flow control procedures apply to the connection sections, then the appropriate procedures must be enacted on both connection sections. On the incoming connection section, these procedures relate to the reception of a valid DT message and on the outgoing connection section, the procedures control the flow of DT messages on the connection section.

#### **3.5.1.3 Actions at the destination node**

When the destination node receives a valid DT message, the SCCP user is notified by invoking the N-DATA indication primitive. If flow control procedures apply to the signalling connection, then the flow control procedures relating to the reception of a valid DT message are enacted.

### **3.5.2 Flow control**

#### **3.5.2.1 General**

The flow control procedures apply during data transfer only, and are used to control the flow of DT messages on each connection section.

The flow control procedures apply only to protocol class 3.

The reset procedure causes reinitialization of the flow control procedure.

The expedited data procedure is not affected by this flow control procedure.

#### **3.5.2.2 Sequence numbering**

For protocol class 3, for each direction of transmission on a connection section, the DT messages are numbered sequentially.

The sequence numbering scheme of the DT messages is performed modulo 128 on a connection section.

Upon initialization or reinitialization of a connection section, message send sequence numbers, P(S), are assigned to DT messages on a connection section beginning with P(S) equal to 0. Each subsequent DT message sequence number is obtained by incrementing the last assigned value by 1. The sequence numbering scheme assigns sequence numbers up to 127.

#### **3.5.2.3 Flow control window**

A separate window is defined, for each direction of transmission, on a connection section in order to control the number of DT messages authorized for transfer on a connection section. The window is an ordered set of W consecutive message send sequence numbers associated with the DT messages authorized for transfer on the connection section.

The lower window edge is the lowest sequence number in the window.

The sequence number of the first DT message not authorized for transfer on the connection is the value of the lower window edge plus W.

The maximum window size is set during connection establishment for temporary connection sections. For permanent connection sections, the window size is fixed at establishment. The maximum size shall not exceed 127.

Negotiation procedures during connection establishment allow for the negotiation of the window size.

### **3.5.2.4 Flow control procedures**

#### **3.5.2.4.1 Transfer of DT2 messages**

If flow control procedures apply to a connection section, then all DT2 messages on the connection section contain a send sequence number, P(S), and a receive sequence number, P(R). The procedure for determining the send sequence number to be used in a DT2 message is described in 3.5.2.2. The receive sequence number, P(R), is set equal to the value of the next send sequence number expected on the connection section and P(R) becomes the lower window edge of the receiving window.

An originating or relay node is authorized to transmit a DT2 message if the message send sequence number of the message is within the sending window. That is, if P(S) is greater than or equal to the lower window edge and less than the lower window edge plus W. When the send sequence number of a DT2 message is outside of the sending window, the node is not authorized to transmit the message.

#### **3.5.2.4.2 Transfer of AK messages**

AK messages may be sent when there are no DT2 messages to be transferred on a connection section<sup>3</sup>.

When a node transfers an AK message on a connection section, it is indicating that the node is ready to receive W DT2 messages within the window starting with the receive sequence number, P(R), found in the AK message. That is, P(R) is the next send sequence number expected at the remote node on the connection section. Furthermore, P(R) also becomes the lower window edge of the receiving window.

An AK message must be sent when a valid DT2 message, as per 3.5.2.4.3 on P(S) and P(R), is received and P(S) is equal to the upper edge of the receiving window and there are no DT2 messages to be transferred on the connection section. Sending of AK messages before having reached the upper edge of the receiving window is also allowed during normal operation.

AK messages may also be sent by a node encountering congestion on a connection section as described below:

Assuming nodes X and Y are the two ends of a connection section, the following procedures apply:

- When a node Y experiences congestion on a connection section, it informs the remote node X using the AK message with the credit set to zero.
- Node X stops transferring DT2 messages on the connection section.
- Node X updates the window on the connection section using the value of the receive sequence number, P(R), in the AK message.
- Node X begins transfer of DT2 message when it receives an AK message with a credit field greater than zero or when an RSR message is received on a connection section for which an AK message with a credit field equal to zero had previously been received.

---

<sup>3</sup> Further study is required to determine criterion to be used to decide when Data Acknowledgement messages are sent for cases other than the congestion situation described in this subclause.

- Node X updates the window on the connection section using the credit value. The credit value in an AK message must either equal zero or equal the initial credit agreed to at connection establishment.

#### **3.5.2.4.3 Reception of a Data or AK message**

When a relay or destination node receives a DT2 message, it performs the following test on the send sequence number, P(S), contained in the DT2 message:

- 1) If P(S) is the next send sequence number expected and is within the window, then the node accepts the DT2 message and increments by one the value of the next sequence number expected on the connection section.
- 2) If P(S) is not the next send sequence number expected, then the reset procedure is initiated on the connection section.
- 3) If P(S) is not within the window, then this is considered a local procedure error and the connection reset procedure is initiated.
- 4) If P(S) is not equal to 0 for the first DT2 message received after initialization or reinitialization of the connection section, then this is considered a local procedure error and the connection reset procedure is initiated.

The message receive sequence number, P(R), is included in DT2 and AK messages. When a node receives a Data or AK message on a connection section, the value of the receive sequence number, P(R), implies that the remote node has accepted at least all DT2 messages numbered up to and including P(R) – 1. That is, the next expected send sequence number at the remote node is P(R). The receive sequence number, P(R), contains information from the node sending the message, which authorizes the transfer of a limited number of DT2 messages on the connection section. When a node receives a DT2 or AK message:

- a) the receive sequence number, P(R), contained in the message becomes the lower window edge of the sending window:
  - 1) if the value of P(R) is greater than or equal to the last P(R) received by the node on that connection section; and also
  - 2) if the value of the received P(R) is less than or equal to the P(S) of the next DT2 message to be transferred on that connection section;
- b) the node initiates the reset procedure on the connection section if the receive sequence number, P(R), does not meet conditions 1) and 2).

#### **3.5.3 Segmenting and reassembly**

During the data transfer phase, the N-DATA request primitive is used to request transfer of octet-aligned data (NSDUs) on a signalling connection. NSDUs longer than 255 octets must be segmented before insertion into the "data" field of a DT message.

The more-data indicator (M-bit) is used to reassemble an NSDU that has been segmented for conveyance in multiple DT messages. The M-bit is set to 1 in all DT messages except the last message whose data field relates to a particular NSDU. In this way, the SCCP can reassemble the NSDU by combining the data fields of all DT messages with the M-bit set to 1 with the following DT message with the M-bit set to 0. The NSDU is then delivered to the SCCP user using the N-DATA indication. DT messages in which the M-bit is set to 1 do not necessarily have the maximum length.

Segmentation and reassembly are not required if the length of the NSDU is less than or equal to 255 octets.

## **3.6 Expedited data transfer**

### **3.6.1 General**

The expedited data procedure applies only during the data transfer phase and is applicable to protocol class 3.

For the case of expedited data transfer, each message contains one NSDU, and no segmenting and reassembly is provided.

If an ED or EA message is lost, then subsequent ED messages cannot be forwarded on the connection section.

### **3.6.2 Actions at the originating node**

The expedited data transfer procedure is initiated by the user of the SCCP using the N-EXPEDITED-DATA request primitive, which contains up to 32 octets of user data.

When the SCCP user invokes the N-EXPEDITED-DATA request primitive, an ED message with up to 32 octets of user data is transferred on the connection section once all previous ED messages for the connection section have been acknowledged.

### **3.6.3 Actions at a relay node**

Upon receiving a valid ED message, a relay node confirms this message by transferring an EA message on the incoming connection section. Withholding of the EA message is a means of providing flow control of ED messages.

If a node receives another ED message on the incoming connection section before sending the EA message, then the node shall discard the subsequent message and reset the connection.

The relay node determines the associated outgoing connection section. An ED message is then transferred on the associated outgoing connection section, once all previous ED messages on that connection section have been acknowledged.

The EA message must be sent before acknowledging subsequent DT or ED messages received on the incoming connection section.

### **3.6.4 Actions at the destination node**

The destination node of the connection section confirms a valid ED message by transferring an EA message on the connection section. Withholding of the EA message is a means of providing flow control of ED messages.

If a node receives another ED message on a connection section before sending the EA message, then the node shall discard the subsequent message and reset the connection.

The destination node then invokes the N-EXPEDITED DATA indication primitive.

The N-EXPEDITED-DATA indication must be issued to the SCCP user at the destination node before N-DATA or N-EXPEDITED-DATA indications resulting from any subsequently issued N-DATA or N-EXPEDITED-DATA requests at the originating node of that signalling connection. The initiation of the EA message is implementation dependent.

## **3.7 Reset**

### **3.7.1 General**

The purpose of the reset procedure is to reinitialize a connection. It is applicable only to protocol class 3. It is noted that the time sequence of the primitives in the reset procedure may be varied as long as it is consistent with Recommendation X.213.

For a connection reset initiated by the SCCP, DT or ED messages shall not be transferred on the connection section prior to the completion of the reset procedure.

### **3.7.2 Action at an end node initiating the reset procedure**

#### **3.7.2.1 Initial actions**

When a connection reset is initiated in an end node, by the SCCP user invoking an N-RESET request primitive or by the SCCP itself, the following actions are performed at the initiating node:

- 1) An RSR message is transferred on the connection section.
- 2) The send sequence number, P(S), for the next DT message is set to 0. The lower window edge is set to 0. The window size is reset to the initial credit value.
- 3) The SCCP user is informed that a reset has taken place by:
  - invoking the N-RESET indication primitive if the reset is network originated.
- 4) The reset timer T(reset) is started.
- 5) Pending expedited data processes must be cleared.
- 6) All DT2, AK, ED and EA messages waiting for transmission are discarded.

#### **3.7.2.2 Subsequent actions**

The following actions are performed at the initiating node on a connection section for which an RSR message has been previously transferred:

- 1) When a DT, AK, ED, or EA message is received, the message is discarded. When an N-DATA request or N-EXPEDITED DATA request primitive is received, the primitive is discarded or stored up to the completion of the reset procedure. The choice between these two is implementation dependent.
- 2) When the reset timer expires, the connection release procedure is initiated on a temporary connection section and OMAP is informed for a permanent connection section.
- 3) When an RSC or an RSR message is received on the connection section, the reset is completed provided the SCCP has previously received an N-RESET request or response primitive from the SCCP user and, therefore, data transfer is resumed and the timer T(reset) is stopped. The SCCP user is informed that the reset is completed by invoking the N-RESET confirm primitive.
- 4) When an RLSD message is received on a temporary connection section, the release procedure is initiated and the timer, T(reset), is stopped.

### **3.7.3 Actions at a relay node**

#### **3.7.3.1 Initial actions**

The connection reset procedure is initiated at the relay node either by the SCCP at the node itself or by the reception of an RSR message.

When an RSR message is received on a connection section, the following actions take place:

- 1) An RSC message is transferred on the connection section.
- 2) An RSR message is transferred on the associated connection section; the reason for reset is identical to the reason in the RSR message.
- 3) On both the connection section and the associated connection section, the send sequence number, P(S), for the next DT message to be transmitted is set to 0 and the lower window edge is set to 0. The window size is reset to the initial credit value on both connection sections.

- 4) The data transfer procedure is initiated on the connection section.
- 5) The reset timer, T(reset), is started on the associated connection section.
- 6) Pending expedited data processes must be cleared.
- 7) All DT2, AK, ED and EA messages waiting for transmission are discarded.

When the connection reset procedure is initiated by the SCCP at the relay node, the following actions take place on both of the connection sections:

- 1) An RSR message is transferred.
- 2) The send sequence number, P(S), for the next DT message is set to 0. The lower window edge is set to 0. The window size is reset to the initial credit value.
- 3) The reset timer T(reset) is started.

### **3.7.3.2 Subsequent actions**

If the connection reset was initiated by reception of an RSR message on a connection section, then the following actions are performed after initial actions are completed:

- 1) When a DT, AK, ED or EA message is received on the associated connection section, the message is discarded.
- 2) When the reset timer expires on the associated connection section, the connection release procedure is initiated on a temporary connection section and the maintenance function is alerted on a permanent connection section.
- 3) When an RLSD message is received on a temporary connection section, the connection release procedure is initiated and the timer, T(reset), is stopped.
- 4) When an RSC or RSR message is received on the associated connection section, the data transfer procedure is resumed and the timer, T(reset), is stopped.

If the connection reset was initiated by the SCCP at the relay node, then the following actions are performed once the initial actions are completed:

- 1) When a DT, AK, ED or EA message is received on either connection section, the message is discarded.
- 2) When the reset timer expires on a temporary connection section, the connection release procedure is initiated, and on a permanent connection a maintenance function is alerted.
- 3) When an RLSD message is received on a temporary connection section, then the connection release procedure is initiated, and the reset timer, T(reset), is stopped.
- 4) When an RSC or RSR message is received on a connection section, data transfer is resumed on that connection and the timer, T(reset), is stopped.

### **3.7.4 Actions at an end node not initiating the reset procedure**

When an RSR message is received at an end node, the following actions are performed on the connection section:

- 1) The send sequence number, P(S), for the next DT message is set to 0, the lower window edge is set to 0. The window size is reset to the initial credit value.
- 2) The SCCP user is informed that a reset has occurred by invoking the N-RESET indication primitive.
- 3) An RSC message is transferred on the connection section after an N-RESET response or request primitive is invoked by the user.
- 4) An N-RESET confirm primitive is invoked to inform the SCCP user that the reset is completed and the data transfer can be resumed.

### 3.7.5 Handling of messages during the reset procedures

Once the reset procedure is initiated, the following actions are taken with respect to DT messages:

- those that have been transmitted, but for which an acknowledgement has not been received, are discarded;
- those that have not been transmitted, but are contained in an M-bit sequence for which some DT messages have been transmitted, are discarded; and
- those DT messages that have been received, but which do not constitute an entire M-bit sequence, are discarded.

## 3.8 Restart

### 3.8.1 General

The purpose of the restart procedure is to provide a recovery mechanism for signalling connection sections in the event of a node failure.

### 3.8.2 Actions at the recovered node

#### 3.8.2.1 Initial actions

When a node recovers from its failure, the following actions are performed:

- 1) A guard timer,  $T(\text{guard})^4$ , is started.
- 2) If the recovered node has knowledge about the local reference numbers in use before failure, then the normal procedures for temporary signalling connections are resumed with the assumption that the local reference numbers which were in use before the node failure are not assigned at least during  $T(\text{guard})$ .
- 3) A maintenance function is informed for the re-establishment of permanent signalling connections.

#### 3.8.2.2 Subsequent actions

The following actions are performed at the recovered node, on every temporary signalling connection section if the node does not know the local reference numbers in use before failure, or only on the temporary signalling connection sections in operation before failure if the node has such knowledge:

- a) Before the guard timer,  $T(\text{guard})$ , expires:
  - 1) When an RLSD message is received with both source and destination local reference numbers, an RLC message, with reversed local reference numbers, is returned to the originating point code.
  - 2) Any other connection-oriented messages received are discarded.
- b) When the guard timer,  $T(\text{guard})$ , expires, normal procedures are resumed.

### 3.8.3 Actions at the non-failed far end node

The inactivity control procedure, described in 3.4, is used by the non-failed far end node to recover from the unsignalled termination of a connection section during data transfer.

---

<sup>4</sup> The guard timer must be large enough, so that all the non-failed far end nodes can detect the failure and can safely release the affected temporary signalling connection sections. This implies  $T(\text{guard}) > T(\text{iar}) + T(\text{int}) + T(\text{rel})$ .



### 3.8.3.1 Permanent signalling connections

Permanent signalling connections are set up administratively and connection establishment procedures and connection release procedures are not initiated by the SCCP user.

Permanent signalling connections are realized using one or more connection sections.

A permanent signalling connection is either in the data transfer phase or the reset phase. Therefore, all procedures relating to the data transfer phase for connection-oriented protocol classes and the reset procedures are applicable to permanent signalling connections.

### 3.8.3.2 Abnormalities

#### 3.8.3.3 General

Errors can be classified into the three categories listed below. Examples of each category are included for clarification:

- 1) Syntax errors – In general, two kinds of syntax errors can be distinguished:
  - a) Value errors – Invalid values for a single information element that lead to the impossibility to decode the message.
  - b) Construction errors – Errors in the sequence or length of information elements or inconsistencies between announced and actual contents of an information element.

For SCCP, the following errors could be considered to be syntax errors:

- a) *Value errors*
  - a1 unknown message type;
  - a2 invalid value of protocol class;
  - a3 invalid value of global title indicator;
  - a4 invalid value for the encoding scheme.
  - a5 unassigned local reference number.

All other "value errors" are not considered to be syntax failures. They are either ignored (as spare fields or spare values) or treated as (unknown) routing failures. The former four errors make it impossible to treat the message in any sensible way and are therefore syntax errors.
- b) *Construction errors*
  - b1 minimum and maximum length of a parameter according to Recommendation Q.713 is not respected;
  - b2 pointers to variable or first optional parameter point beyond end of message;
  - b3 length of an optional parameter extends beyond end of message (may be because EOP is forgotten);
  - b4 the combination of pointer values and length of parameters (or sum of length of optional parameters) results in overlapping parameters;
  - b5 length of a calling or called party address is not compatible with contents as indicated in the address indicator of the address;
  - b6 in an address, no SSN is included although the routing indicator indicates "Route on SSN";
  - b7 in an address, no GT is included although the routing indicator indicates "Route on GT" (except as indicated in 3.5/Q.713).

- 2) Logical errors – This type of error occurs when a node receives a message that is not an acceptable input to the current state of the connection section, or whose value of P(S) or P(R) is invalid. Examples of logical errors are:
  - reception of an acknowledgement message when the corresponding request message has not been sent;
  - reception of a DT message whose data field length exceeds the maximum data field permitted on the connection section;
  - reception of a second ED message before an EA message has been sent; and
  - reception of message whose value of P(R) is not greater than or equal to the last P(R) received and is not less than or equal to the next value of P(S) to be transmitted.
- 3) Transmission errors – This type of error occurs when a message is lost or delayed. An example of transmission error is:
  - expiration of a timer before reception of the appropriate acknowledgement message.

### **3.8.4 Syntax error**

When syntax errors are detected (see 3.8.3.3) in a connection-oriented message, the message is discarded. Checking for syntax errors beyond the processing required for the SCCP connection-oriented message routing is not mandatory.

### **3.8.5 Action tables**

The action tables found in Annex B, include information, in addition to that found in the text of this Recommendation, regarding the actions to be performed upon receipt of a message. In particular, these tables are helpful in determining the actions to be performed upon receipt of a message resulting in a logical error.

### **3.8.6 Actions upon the reception of an ERR message**

Upon the reception of an ERR message at a node, the following actions are performed on the connection section for error causes other than "service class mismatch":

- 1) The resources associated with the connection are released.
- 2) The local reference number is frozen (see 3.3.2).

Upon the reception of an ERR message at a node with the error cause "service class mismatch", the connection release procedure is initiated by the SCCP at that node (see 3.3).

## **4 Connectionless procedures**

An overview of these procedures is given in 1.3 and the properties of the protocol classes (class 0 and 1) applicable to connectionless procedures are described in 1.1.2.

The SCCP connectionless control (SCLC), in combination with the SCCP routing control (SCRC) (see Figure 1) support the connectionless SCCP procedures, and provide to a SCCP user the services defined in 6.2/Q.711. The SCLC and SCRC rely on services provided by MTP at MTP-SAPs, as defined in clause 7/Q.711.

This clause specifies the requirements SCLC and SCRC shall meet for the support of connectionless procedures with protocol classes 0 and 1, and how the elements for layer to layer communication shall be used.

It is the objective to operate the connectionless protocol in various SCCP network environments. These may be:

- a) an environment with only MTP network(s) according to Recommendation Q.704 (pure Q.704);
- b) an environment with only MTP network(s) according to Recommendation Q.2210 (pure Q.2210);
- c) an environment where interworking occurs between MTP networks according to Recommendations Q.704 and Q.2210.

All environments must support all SCCP management messages.

An implementation shall support all message types, parameters, and parameter values (see Recommendation Q.713) applicable to the connectionless protocol classes and capabilities of this Recommendation. But the network may allow lesser functionality according to the place of the network(s) in which the implementation is required to operate.

The connectionless procedures allow a user of the SCCP to request transfer of up to 2560–3952 octets<sup>5</sup> of user data without first requesting establishment of a signalling connection.

The N-UNITDATA request and indication primitives are used by the user of the SCCP to request transfer of user data by the SCCP and for the SCCP to indicate delivery of user data to the destination user. Parameters associated with the N-UNITDATA request primitive must contain all information necessary for the SCCP to deliver the user data to the destination.

Transfer of the user data is accomplished by including the user data in XU DT or LU DT or UD T messages.

When the user of the SCCP requests transfer of user data by issuing an N-UNITDATA request primitive, there are two classes of service that can be provided by the SCCP, protocol classes 0 and 1. These protocol classes are distinguished by their message sequencing characteristics.

When the user of the SCCP requests transfer of several messages by issuing multiple N-UNITDATA request primitives, the probability of these messages being received in-sequence at the destination point depends on the protocol class designated in the request primitives.

For protocol class 0 the sequence control parameter is not included in the N-UNITDATA request primitive and the SCCP may generate a different SLS for each of these messages.

For protocol class 1 the sequence control parameter is included in the N-UNITDATA request primitive and, if the parameter is the same in each request primitive, then the SCCP will generate the same SLS for these messages. If a Global Title Translation is being performed, then the translation shall yield identical results for every translation of the same Global Title.

The SCCP relies on the services of the MTP for transfer of SCCP messages. Based on the characteristics of the MTP, the protocol class 1 service may be used in such a way that it provides a quality of service that has a lower probability of out-of-sequence messages than that provided by protocol class 0.

#### **4.1 Data transfer**

The N-UNITDATA request primitive is invoked by the SCCP user at an originating node to request connectionless data transfer service.

The user data is then transferred in XU DT or LU DT or UD T message(s), using SCCP and MTP routing functions, to the "Called address" indicated in the N-UNITDATA request primitive.

---

<sup>5</sup> The maximum value depends on the length of the called and calling party addresses, and on whether or not segmentation may occur (see 8.3.2/Q.715).

The connectionless data transfer service is also used to transport SCCP management messages, which are transferred in the "data" field of XU DT or LU DT or UD T messages.

SCCP routing and relaying functions are required at relay nodes, because complete translation and routing tables for all addresses are not required at every node.

When the user data cannot be transferred to its destination, the message return procedure is initiated.

NOTE – The SCCP uses the services of the MTP and the MTP may, under severe network conditions, discard messages (see 2.3.5.1/Q.704). Therefore, the user of the SCCP may not always be informed of non-delivery of user data.

The MTP notifies the SCCP of unavailable or congested remote signalling points or remote SCCP unavailability using the MTP-PAUSE indication or MTP-STATUS indication primitives. The SCCP then informs its users.

When a UD T or XU DT or LU DT message is received at the destination node, an N-UNITDATA indication primitive is invoked, after possible reassembly of all segments, except for the SCCP management messages. The SCCP management (SCMG) messages are passed to the SCMG entity instead.

For protocol class 1, the originating node shall make provision that SLS values preserve the sequence of SCCP-SDUs received from the SCCP user with the same sequence control and called address.

In addition, for protocol class 1, the relay nodes, and destination node shall maintain the sequence of messages as received from the SCCP in the previous SCCP node with the same SLS value and called party address.

#### **4.1.1 Segmentation/reassembly**

##### **4.1.1.1 Segmentation**

###### **4.1.1.1.1 General**

The connectionless segmentation mechanism is provided by the SCLC block. It is used in two situations:

- 1) When an SCCP user generates an N-UNITDATA request primitive and SCLC is able to segment the message before passing it to SCRC.
- 2) When the compatibility test in SCRC sends a message to SCLC for segmentation.

The actions of SCLC depends on the length of the user data as follows:

- If the length of the user data is lower than Z octets<sup>6</sup>, then SCLC shall avoid segmentation and an XU DT or LU DT or UD T message is passed to SCRC.
- If the length of the user data is between Z (lower limit) and Y (upper limit, see Table 19/Q.713) octets, then the SCCP may decide to segment the message, based on locally stored information regarding network performance and configuration.
- If the length of the user data is between Y octets and 3952 octets inclusive, then the SCCP shall segment the message. If segmentation is not possible, then the error treatment is initiated.
- If the length of the user data is greater than 3952 octets then the error treatment shall apply.

---

<sup>6</sup> The exact specification of the Z is network operator specific and shall obey the relation:  $160 \leq Z \leq Y$ .

#### 4.1.1.1.2 Normal procedures

If the SCCP determines that segmentation is needed, it shall segment the original block of user data into smaller blocks of data that can be carried as user data in XUDT messages (the use of LUDT messages is for further study). The size of the segments should be chosen so that a minimum number of segments is sent, subject to local knowledge of the network status. A maximum of 16 segments can be sent for one N-UNITDATA request primitive. The size of the first segment shall be selected so that the total message size is less than or equal to the size of the first segment multiplied by the number of segments. This provides for an effective buffer management capability at the destination SCCP.

After segmenting the user data into smaller segments, the SCCP shall form a sequence of XUDT messages, as described below:

- The SCCP shall place each segment of user data into separate XUDT messages, each with the same Called Party Address and identical MTP routing information (DPC, SLS).
- The Calling Party Address and the OPC in each XUDT message shall be coded identically, in the manner described in 2.1, SCCP Addressing.
- Each segmented XUDT message shall include the segmentation parameter.
- The Segment Number field of the segmentation parameter shall be coded with the remaining number of segments in the segmentation process. For example, in the first segment, this field shall be set to one less than the total number of segments.
- The Segmentation Local Reference field of the segmentation parameter shall be coded with a unique local reference, which shall be frozen until the completion of the reassembly process<sup>7</sup>. In the case where segmentation follows the reception of an LUDT message, then the Segmentation Local Reference put in each segment shall be identical to the Segmentation Local Reference received in the segmentation parameter of this corresponding LUDT message. If the segmentation parameter was not present in the received LUDT message, then the message return procedure is initiated with the return cause "segmentation failure".
- The F-bit in the first segment shall be coded as one; the F-bit in each remaining segment shall be coded as zero.
- The protocol class for each segmented XUDT message shall be set to 1. At the originating node the In-Sequence Delivery Option field of the segmentation parameter shall be set as indicated in the N-UNITDATA request primitive. If the segmentation is performed at a relay node the In-Sequence Delivery Option field shall be set in each segment to the value of the protocol class received in the incoming message.
- When an N-UNITDATA REQUEST primitive results in a single LUDT message, but there is a possibility that the data parameter will be segmented at an SCCP relay node, then the segmentation parameter is included in the message.

#### 4.1.1.1.3 Message return procedure

If message return is requested by the SCCP user, then it is an implementation decision that determines which XUDT or LUDT messages have return message on error requested. If an XUDTS message is subsequently received then it is an implementation decision that determines how the SCCP should deal with the returned XUDTS or LUDTS message.

When the return option is set to return message on error in a received LUDT message and this message is segmented, the return option will only be set in the first segment.

---

<sup>7</sup> The freezing mechanism is implementation dependent.

The following errors may occur during segmenting:

- segmentation not supported;
- segmentation failed.

#### **4.1.1.1.3.1 Segmentation not supported**

An LUDT message arrives at an interworking node, and the segmentation function is not implemented.

The following cause applies:

- Return Cause: segmentation non-supported.

#### **4.1.1.1.3.2 Segmentation failed**

An LUDT message arrives at an interworking node, and the segmentation fails for lack of resources or another transient condition in the interworking node.

The following cause applies:

- Return Cause: segmentation failed.

### **4.1.1.2 Reassembly**

#### **4.1.1.2.1 General**

Upon receipt of an LUDT or XUDT message with the F-bit set to one and the "remaining segment" field different from zero in the segmentation parameter, the destination SCCP shall initiate a new reassembly process, using the Calling Party Address, MTP routing information and the Segmentation Local Reference to uniquely identify the reassembly process. Initiating a reassembly process involves the following steps:

- The SCCP shall start the reassembly timer. If the reassembly timer expires before all segments are received and reassembled, the SCCP shall discard the message and stop the reassembly process.
- The SCCP shall determine the upper bound on the total message length by multiplying the length of the first segment by one more than the number of segments indicated in the remaining segment field of the first segment.
- The SCCP should extract the user data of the segment, and buffer it so that it can be concatenated with subsequent segments.

When an LUDT or XUDT message is received with the F-bit set to one and the "remaining segment" field different from zero, referring to an already existing reassembly process, then the already received segments for that existing reassembly process are discarded and the SCCP initiates the message return procedure for the newly received message.

#### **4.1.1.2.2 Normal procedures**

Upon receipt of an LUDT or XUDT message with the F-bit set to zero in the segmentation parameter, the SCCP shall perform the following steps when reassembling the message:

- The SCCP shall associate the received XUDT or LUDT message with a particular reassembly process, using the unique combination of the Calling Party Address, MTP routing information, and the Segmentation Local Reference field of the segmentation parameter. If no association is possible, the SCCP shall discard the message.
- The SCCP shall verify that the segment is received in-sequence by examining the Remaining Segments field of the segmentation parameter, which shall be one less than the previous

segment. If a segment is received out of sequence, or a duplicate segment is received, the SCCP shall initiate the message return procedure. The received segments are discarded.

- The SCCP should extract the user data of the segment, and concatenate it with the other segments, in the order received. Segments can be any length, and not all segments of a particular segmentation process need be the same length. Thus, the destination SCCP shall be able to deal with segments of any length.
- When the Remaining Segments field of the segmentation parameter is zero, and all segments are properly reassembled, the SCCP shall pass the message to the appropriate SCCP user as user data in an N-UNITDATA indication primitive. The destination SCCP shall examine the In-Sequence Delivery Option field of the segmentation parameter to determine if sequencing is needed between the reassembled message and any other received message, because the protocol class will always be set to one in a XU DT or LU DT segment.

#### **4.1.1.2.3 Message return procedure**

If an error occurs during reassembly, the SCCP shall return an XU DTS or LU DTS message containing a "first" segment of user data, if return message on error was requested in an XU DT or LU DT message received as part of the reassembly process. The amount of user data contained in the message is an implementation decision, but it shall correspond to the first block or blocks of user data received. In some cases, this will be the first segment transmitted by the segmentation process, in other situations, it will not.

The reassembly function will never change the segment number of the segments to be returned. No specific indication will be given that there is only a "first" segment.

The following errors can occur during reassembly:

- destination cannot perform reassembly;
- error in message transport;
- error in local processing;
- no buffer space to perform reassembly.

##### **4.1.1.2.3.1 Destination cannot perform reassembly**

The reassembly function is not implemented at this node.

This may be the case when a segmented LU DT message would be received, necessitating reassembly of more than the maximum supported data length (see clause 4).

The following cause applies:

- Return Cause: destination cannot perform reassembly.

##### **4.1.1.2.3.2 Error in message transport**

The reassembly fails because of message loss (e.g. in case of congestion), duplication, corruption or mis-sequencing of one or more segments. This will be detected by the fact that the "remaining segments" field does not decrease monotonically, a non first segment is received for an idle segmenting reference/calling party address combination or a first segment arrives for a busy segmenting reference/calling party address combination or the timer T(reass) expires. Or: the message length received exceeds the number of segments times the length of the first segment.

The following cause applies:

- Return Cause: error in message transport.

#### **4.1.1.2.3.3 Error in local processing**

The reassembly process fails due to lack of resources or any other transient condition in the destination node performing the reassembly.

The following cause applies:

- Return Cause: error in local processing.

#### **4.1.1.2.3.4 No buffer space to perform reassembly**

The reassembly function cannot allocate sufficient memory resources to store all the user data that will arrive in the subsequent segments.

The following cause applies:

- Return Cause: network congestion.

### **4.1.2 Message change**

When the compatibility test in SCRC sends a message to SCLC to change the message type, SCLC should pass a message of the requested type, containing all the parameters of the received message, to SCRC.

The insertion of optional parameters without message type change is permitted, their values may be network dependent. Where an optional parameter is present in a message received at an interworking node, and the resulting outgoing message is of the same type, then the optional parameter may either be deleted or its value transcribed according to the need of the outgoing network. Such parameter manipulation can also occur when the message type changes.

Where interworking between narrow-band and broadband environments exist, the minimum required format conversions are the following:

LUDT  $\Rightarrow$  XUDT (2-N segments, message type change with or without segmentation).

LUDTS  $\Rightarrow$  XUDTS (message type change and truncation).

The other allowed format conversions are the following (optional):

LUDT  $\Rightarrow$  LUDT (2-N segments, no message type change but segmentation).

XUDT  $\Rightarrow$  LUDT (message type change without reassembly).

LUDTS  $\Rightarrow$  XUDTS (message type change without truncation).

XUDTS  $\Rightarrow$  LUDTS (message type change without truncation).

UDT  $\Rightarrow$  XUDT (1-N segments, message type change with or without segmentation).

XUDT  $\Rightarrow$  UDT ( message type change).

UDTS  $\Rightarrow$  XUDTS ( message type change with possible truncation).

XUDTS  $\Rightarrow$  UDTS ( message type change).

Other format conversions are for further study.

### **4.2 Message return procedure**

The purpose of the message return procedure is to discard or return messages which encounter routing failure and cannot be delivered to their final destination. The message return procedure is also used in cases of error during connectionless reassembly.

The message return procedure is initiated:

- a) When SCCP routing is not able to deliver the message (see 2.8 for specific reasons).
- b) When SCCP encounters resources problems.



- c) When errors occur during segmentation/reassembly (see 4.1.1.1.3 and 4.1.1.2.3).

The procedures are as follows:

- a) If the message is an XUDT or LUDT or UDT message; and
- the option field is set to return message on error, then an XUDTS or LUDTS or UDTS message is transferred to the originating point (an LUDTS message should be used in response to an LUDT message, a UDTS message should be used in response to a UDT message and an XUDTS message should be used in response to an XUDT message). The called party address of the non-deliverable XUDT or LUDT or UDT message shall become the calling party address of the XUDTS or LUDTS or UDTS message, and the calling party address of the undeliverable XUDT or LUDT or UDT message shall be interpreted, for the XUDTS or LUDTS or UDTS message, as a called party address (it might be changed by a global title translation process). If the message is originated locally, then an N-NOTICE indication primitive is invoked.
  - the option field is not set to return message on error, then the received message is discarded.
- b) If the undeliverable message is an XUDTS or LUDTS or UDTS message, then it is discarded.

The "data" field of the XUDT or LUDT or UDT message and the reason for return are included in the XUDTS or LUDTS or UDTS message.

When an XUDTS or LUDTS or UDTS message is received at the destination node, after possible reassembly, an N-NOTICE indication primitive is invoked.

Reassembly of received XUDTS or LUDTS messages is an implementation dependent option. When the XUDTS/LUDTS is a result of a reassembly error (see 4.1.1.2.3), then only one XUDTS/LUDTS message will be sent, containing the first part of the message (which does not necessarily correspond to the first segment of the original XUDT or LUDT received).

When the XUDTS message is the result of a routing failure of an LUDT message, which could only be return in an XUDTS, the user data will be truncated to fit into one XUDTS message. When the XUDTS message is the result of a routing failure of the first XUDT segment resulting from segmenting an LUDT message, the user data will contain only the first segment of data.

### **4.3 Syntax error**

When syntax errors are detected (see 3.8.3.3) for a connectionless message, the message is discarded. Checking for syntax errors beyond the processing required for the SCCP connectionless message routing is not mandatory.

## **5 SCCP management procedures**

### **5.1 General**

The purpose of SCCP management is to provide procedures to maintain network performance by rerouting or throttling traffic in the event of failure in the network.

Although SCCP management has its own subsystem number, the procedures in this clause do not apply to the SCCP management as an SCCP user. For the cases where the SCCP management's SSN is used to indicate the availability/unavailability of the SCCP, the applicable procedures are explicitly stated as applying to SSN=1. "1" is assigned to SCCP management, whereas the remaining SSNs are assigned to SCCP users, except SSN=0. The status of SSN=1 is assumed to reflect the status of the entire SCCP at a node.

SCCP management is organized into two subfunctions: signalling point status management and subsystem status management. Signalling point status management and subsystem status management allow SCCP management to use information concerning the accessibility of remote signalling points and subsystems, respectively, to permit the network to adjust to failure, and recovery.

SCCP management procedures rely on:

- 1) failure, recovery, and congestion information provided in the MTP-PAUSE indication, MTP-RESUME indication and MTP-STATUS indication primitives; and
- 2) subsystem failure and recovery information, and SCCP (SSN=1) congestion received in SCCP management messages.

SCCP management information is currently defined to be transferred using the SCCP connectionless service with no return on error requested. The formats of these messages appear in Recommendation Q.713.

SCCP management maintains the status of remote SCCP nodes; and the status of remote or local subsystems. It cooperates with the SCCP routing control (including translation function) to stop traffic to inaccessible destinations and to provide rerouting of traffic through alternate routing or through selection of alternate remote subsystems.

From the perspective of SCCP routing control, the remote SCCP nodes addressed by certain ranges of Global Titles can be operated in several modes; and the SCCP routing control (translation function) are supported by the signalling point status management procedures (5.2):

- 1) *solitary mode*: The destination subsystem or next translation node is chosen from the one single SCCP node. When that node or its SCCP fails, the SCCP management will notify the SCCP routing control; and the traffic towards the solitary nodes will be discarded or returned if return-option is set. In the case of connection-oriented procedures, the connection section will be refused or released.
- 2) *replicated service in dominant mode*: The next translation node or destination subsystem can be chosen from two SCCP nodes. Traffic towards a specific subdomain (characterized by ranges of Global Titles) is normally sent to the SCCP of a "primary" node. When the "primary" node is inaccessible, the SCCP management will notify the routing control and this traffic is routed to the SCCP of a "backup" node. As soon as the "primary" node becomes accessible again, the traffic is again routed to it.
- 3) *replicated service in dynamically loadshared mode*: The next translation node or destination subsystem is chosen from two SCCP nodes. The traffic is dynamically distributed to the next two nodes by the traffic-sending node. The next pair of SCCP nodes receiving the traffic will backup each other. If one of the nodes becomes inaccessible, the SCCP management will notify the routing control and the traffic will be routed to the other one. As soon as the previously inaccessible node becomes accessible again, the traffic is dynamically distributed to those two nodes again.

Remote SCCP-subsystems capable of providing the same application service for, as an example, the same subset of service subscribers can be grouped in "subsystem services". Several modes of operation for such a "subsystem service" can be distinguished and are supported by the subsystem status management procedures (5.3); when final translation results in "route on SSN."

- 1) *solitary subsystems*: When the solitary subsystem fails, the SCCP management will notify the SCCP routing control; and the traffic towards the solitary subsystem will be discarded or returned if the return-option is set. In the case of connection-oriented procedure, the connection section will be refused or released.

- 2) *replicated subsystems in dominant mode*: the destination subsystem is chosen from two replicated subsystems. The traffic is normally sent to the "primary" subsystem. When the "primary" subsystem is inaccessible, the SCCP management will notify the routing control and this traffic is sent to the "backup" subsystem. As soon as the "primary" subsystem becomes accessible again, the traffic is again routed to it.
- 3) *replicated subsystem in dynamically loadshared mode*: The destination subsystem is chosen from two replicated subsystems. The traffic is dynamically distributed to the two replicated subsystems. The replicated subsystems receiving the traffic will back up each other. If one of the subsystems becomes inaccessible, the SCCP management will notify the routing control and the traffic will be distributed to the other subsystem. As soon as the previously inaccessible subsystem becomes accessible again, the traffic is dynamically sent to those two subsystems again.

In cases 2) and 3) above, sequences of messages that must go to the same replicated subsystem (e.g. all messages of a TCAP transaction after initial transaction set-up) should use an unambiguous address, so only the initial set-up message (e.g. TCAP:BEGIN) can use the modes 2 and 3.

SCCP management procedures utilize the concept of a "concerned" subsystem or signalling point. In this context, a "concerned" entity means an entity with an immediate need to be informed of a particular signalling point/subsystem status change, independently of whether SCCP communication is in progress between the "concerned" entity and the affected entity with the status change<sup>8</sup>.

In some situations, the number of concerned subsystem or signalling points for a given subsystem may be zero. In this case, when the subsystem fails, or becomes unavailable, no broadcast of the subsystem prohibited message is performed. Similarly, no broadcast of the subsystem allowed message is performed for that given subsystem when it recovers.

For nodes/subsystems that are not explicitly notified of status changes, i.e. they are not marked as "concerned", the SSA/SSP messages directed to them is lost or no broadcast will take place after recovering from a MTP or SCCP failure, the response method is used. The response method ensures that an SSP message is returned for a message to an unavailable subsystem, or an SSA message is returned as a result of the SST when the subsystem is available again.

The signalling point prohibited, signalling point allowed and signalling point congested procedures, specified in 5.2.2, 5.2.3 and 5.2.4 respectively, deal with the accessibility of a signalling point.

The local MTP network availability and unavailability procedures are described in 5.2.5 and 5.2.6, respectively.

The SCCP reports of SCCP and nodal congestion procedure is specified in 5.2.7

The inter- and intra- SCCP Management congestions reporting procedure is specified in 5.2.8.

The subsystem prohibited and subsystem allowed procedures, detailed in 5.3.2 and 5.3.3 respectively, deal with the accessibility of a subsystem or the SCCP.

An audit procedure to ensure that necessary subsystem management information is always available is specified in the subsystem status test procedure in 5.3.4.

A subsystem may request to go out of service, using the coordinated state change control procedure specified in 5.3.5.

Local subsystems are informed of any related subsystem status by the local broadcast procedure specified in 5.3.6.

---

<sup>8</sup> The definition of "concerned" subsystems or signalling points is network/architecture/application dependent.

Concerned signalling points are informed of any related subsystem status by the broadcast procedure specified in 5.3.7.

## **5.2 Signalling point status management**

NOTE – The SCCP congestion control procedures may be subject to improvement pending further analysis of the impact of these procedures in different network scenarios and based on the results of operational experience.

### **5.2.1 General**

Signalling point status management updates translation and status based on the information of network failure, recovery, or congestion provided by the MTP-PAUSE indication, MTP-RESUME indication, or MTP-STATUS indication primitives. This allows alternative routing to back up signalling points and/or backup subsystems.

### **5.2.2 Signalling point prohibited**

When SCCP management receives an MTP-PAUSE indication primitive relating to a destination that becomes inaccessible, or an MTP-STATUS indication primitive relating to an SCCP that becomes unavailable, SCCP management performs the following actions.

- 1) Informs the translation function to update the translation tables.
- 2) In the case where the SCCP has received an MTP-PAUSE indication primitive, SCCP management marks as "prohibited" the status of the remote signalling point, the remote SCCP and each subsystem at the remote signalling point.

In the case where the SCCP has received an MTP-STATUS indication primitive relating to an unavailable SCCP, the SCCP marks the status of the SCCP and each SSN for the relevant destination to "prohibited" and initiates a subsystem status test with SSN=1. If the cause in the MTP-STATUS indication primitive indicates "unequipped user", then no subsystem status test is initiated.

- 3) Discontinues all subsystem status tests (including SSN=1) if an MTP-PAUSE or MTP-STATUS indication primitive is received with a cause of "unequipped SCCP". The SCCP discontinues all subsystem status tests, except for SSN=1, if an MTP-STATUS indication primitive is received with a cause of either "unknown" or "inaccessible".
- 4) Initiates a local broadcast (5.3.6.2) of "User-out-of-service" information for each subsystem at that destination.
- 5) Initiates a local broadcast (5.3.6.4) of "signalling point inaccessible" information for that destination if an MTP-PAUSE indication primitive is received.
- 6) Initiates a local broadcast of "remote SCCP unavailable" if either an MTP-PAUSE indication primitive or an MTP-STATUS indication primitive is received.

### **5.2.3 Signalling point allowed**

When SCCP management receives an MTP-RESUME indication primitive relating to a destination that becomes accessible, or when it receives a subsystem allowed message relating to SSN=1 at a remote destination which had been considered "prohibited", or when timer T(stat info) expires, SCCP management performs the following actions:

- 1) Sets the congestion state of that signalling point if an MTP-RESUME indication primitive is received.
- 2) Instructs the translation function to update the translation tables.
- 3) Marks as "allowed" the status of that destination, and the SCCP, if a MTP-RESUME indication primitive is received.

- 4) Marks as "allowed" the status of the SCCP if a subsystem allowed message is received for SSN=1 or if timer T(stat info) expires. The subsystem status test for SSN=1, if running, is stopped.
- 5) Marks as "allowed" the status of remote subsystems. As a national network provider option, the subsystem status can be marked as "prohibited" for a list of selected subsystems. For such subsystems, the subsystem status test procedure is initiated<sup>9</sup>.
- 6) Initiates a local broadcast (5.3.6.4) of "signalling point accessible" information for that destination if a MTP-RESUME indication primitive is received.
- 7) Initiates a local broadcast of "remote SCCP accessible" if either an MTP-RESUME indication primitive or a subsystem status allowed message is received for SSN=1 or if timer T(stat info) expires.
- 8) Initiates a local broadcast of "User-in-service" information for a subsystem associated with the MTP-RESUME indication primitive.

#### 5.2.4 Signalling point congested

When SCCP management receives an MTP-STATUS indication primitive relating to signalling network congestion to a signalling point, SCCP management:

- 1) Determines the severity of the congestion in the remote signalling point and updates that signalling point status to reflect the congestion as follows:
  - MTP provides a single level congestion indication (international method)<sup>10</sup>.  
The severity is reflected by a local internal status variable referred to as "restriction level"  $RL_M$ . Each of the  $N+1$  restriction levels except the highest level is further divided into  $M$  restriction sublevels,  $RSL_M$ , where:  

$$N = 8$$

$$M = 4$$
 The method to compute these levels uses an attack timer  $T_a$  and a decay timer  $T_d$ .
    - a) When timer  $T_a$  is not running, then:  
 Timer  $T_a$  is started and  $T_d$  is (re)started.  
 if  $RL_M$  is equal to  $N$ , then no further action is taken.  
 $RSL_M$  is incremented.  
 If  $RSL_M$  reaches  $M$ , then  $RSL_M$  is set to zero and  $RL_M$  is incremented.
    - b) When timer  $T_a$  is running, the MTP-STATUS indication primitive is ignored.
- 2) Initiates the procedure of 5.2.8.

When congestion abates, the traffic is gradually resumed. SCCP management:

- 1) Decreases the restriction level ( $RL_M$ ) in a time-controlled manner as follows:  
 When timer  $T_d$  expires, then  $RSL_M$  is decremented and:
  - a) if  $RSL_M$  reaches  $-1$  and  $RL_M$  is not zero, then  $RSL_M$  is reset to  $M-1$  and  $RL_M$  is decreased by one;
  - b) if either  $RSL_M$  or  $RL_M$  is not zero, then timer  $T_d$  is restarted again.

<sup>9</sup> This may under certain circumstances be used to solve the problem of message loss when switching back from a backup to a primary node (in case of replicated subsystems in dominant mode), where the status of the subsystem in the primary node is still unknown.

<sup>10</sup> The congestion method for national option is for further study.

- 2) Initiates the procedure of 5.2.8.

When an indication of the end of MTP-RESTART is received, the associated  $RL_M$  and  $RSL_M$  are set to zero.

The values of  $M$ ,  $N$ ,  $T_a$  and  $T_d$  parameters are administratable and provisional.

### 5.2.5 Local MTP network availability

When SCCP management receives an indication reporting the end of a MTP Restart, then it:

- 1) resets the congestion level of the associated signalling points;
- 2) instructs the translation function to update the translation tables, taking into account the accessibility given by the MTP indicating the end of MTP Restart;
- 3) marks as allowed the status of the SCCP and all subsystems for each accessible point;
- 4) initiates a local broadcast (5.3.6.4) of "signalling point accessible" information for the signalling points becoming accessible;
- 5) initiates a local broadcast of "remote SCCP accessible" for the remote SCCPs becoming accessible; and
- 6) initiates a local broadcast of "User-in-service" information for a subsystem associated with the end of the MTP-RESTART.

### 5.2.6 Local MTP network unavailability

Any action taken is implementation dependent.

### 5.2.7 SCCP reports of SCCP and nodal congestion

This subclause describes procedures related to congestion conditions that are experienced by the SCCP or node and reported by the SCCP. The SCCP notifies the originating/relay nodes sending/relaying traffic towards a congested node of the congestion. A time-controlled procedure is run at the originating/relaying node using a status variable,  $CL_S$ , which indicates the level of congestion at the remote node.

If the congestion is due to a general congestion state of the node, the application of this procedure should be synchronized with equivalent measures of other affected MTP-Users (e.g. ISUP, B-ISUP). Any procedure to synchronize or coordinate these equivalent measures is outside the scope of this Recommendation.

#### 5.2.7.1 Actions in the congested SCCP node

When a message arrives at a congested SCCP node, SCCP Routing Control informs SCCP management (see 2.3.1). SCMG shall return a *SCCP/Subsystem-Congested* message (SSC) to the signalling point identified by the OPC in the MTP-routing label of the MTP-TRANSFER indication primitive and the MTP-SAP from which the message is received. The *SCCP/Subsystem-Congested* message shall indicate the SPC of this congested SCCP node in the "affected PC" parameter, SSN of the SCMG; (1) in the "affected SSN" parameter and a value in the "congestion level" parameter to indicate the severity of the congestion. Any reaction towards a local originator is implementation dependent. The detection of SCCP or nodal congestion is implementation dependent.

After reception of the first message by the congested SCCP node, the SSC message will be repeated only on the reception of every P-th message regardless of the OPC.

P is provisionally set to 8.

### 5.2.7.2 Action in a relay or originating node

When a *SCCP/Subsystem-Congested* message is received from the congested SCCP, and the affected signalling point has been marked as "prohibited", no further action is taken. When a *SCCP/Subsystem-Congested* message is received from the congested SCCP, and the affected point code has not been marked as "prohibited", SCCP management shall compare the value of  $CL_S$  associated with the congested SCCP node with the congestion level parameter indicated in the *SCCP/Subsystem-Congested* message. If the  $CL_S$  has been marked with a higher congestion level, the value shall remain unchanged, or else the  $CL_S$  shall be updated with the value of the congestion level parameter of the received *SCCP/Subsystem-Congested*. If the  $CL_S$  has been marked with a higher or same level, the timer  $T_{con}$  shall be restarted.

If the  $T_{con}$  timer expires and the  $CL_S$  has not yet reached zero, the  $CL_S$  shall be decremented by one and timer  $T_{con}$  shall be restarted. If the  $CL_S$  is reduced to zero, the timer  $T_{con}$  is stopped.

Whenever a remote SCCP is marked as accessible (MTP-RESUME, SSA, indication of the end of MTP-restart received), the congestion level  $CL_S$  stored by SCCP may be changed (network dependent).

The SCMG shall initiate the procedure of 5.2.8 when the value of  $CL_S$  changes.

The congestion levels  $CL_S$  is within the range 0 through 8, with 0 indicating that no congestion is present.

### 5.2.8 Inter- and Intra- SCMG congestion reports procedure

This SCMG procedure uses the values of the following internal status variables:

- 1)  $RL_M$ , restriction level due to receipt of the MTP-STATUS indication of congestion for each affected SP (5.2.4).
- 2)  $RSL_M$ , restriction sublevel per  $RL_M$  due to receipt of the MTP-STATUS indication of congestion for each affected SP (5.2.4).
- 3)  $CL_S$ , SCCP congestion level due to receipt of the congestion level parameter of SSC message for each affected SP and  $SSN=1$  (5.2.7).

The above values are used as inputs to compute the values of the following variables:

- a)  $RL$ , SCRC traffic restriction level for each affected SP.
- b)  $RSL$ , restriction sublevel per  $RL$  for each affected SP.
- c)  $RIL$ , restricted importance level parameter reported to SCCP users for each affected SP.

If there is any change in  $RL$  or  $RSL$ , SCRC is informed of the new values of  $RL$  and  $RSL$ .

If there is any change in restricted importance level, the local broadcast procedure (5.3.6.6) is initiated to report the new value of restricted importance level.

NOTE – The computation is left for further study.

## 5.3 Subsystem status management

NOTE – The SCCP congestion control procedures may be subject to improvement pending further analysis of the impact of these procedures in different network scenarios and based on the results of operational experience.

### 5.3.1 General

Subsystem status management updates the subsystem status based on the information of failure, withdrawal, and recovery of subsystems. This allows alternative routing to back up subsystems, if

appropriate. Concerned local users are informed of the status changes of other backup subsystems. Subsystem status management procedures are also used to convey the status of the SCCP as a whole.

### **5.3.2 Subsystem prohibited**

A subsystem prohibited message with SSN=1 is not allowed.

#### **5.3.2.1 Receipt of messages for a prohibited subsystem (response method)**

If SCCP routing control receives a message, whether originated locally or not, for a prohibited local system, then SCCP routing control invokes subsystem prohibited control. A *Subsystem-Prohibited* message is sent to the signalling point identified by the OPC in the MTP-TRANSFER indication primitive, and the MTP-SAP instance if the originating subsystem is not local. If the originating subsystem is local, any action taken is implementation dependent. When many indications "message for a prohibited subsystem" are received, the number of SSPs sent out per time-interval may be reduced by implementation dependent mechanisms.

#### **5.3.2.2 Receipt of Subsystem-Prohibited message or N-STATE request primitive or local user failed**

Under one of the following conditions:

- a) SCCP management receives a *Subsystem-Prohibited* message about a subsystem marked allowed; or
- b) an N-STATE request primitive with "User-out-of-service" information is invoked by a subsystem marked allowed; or
- c) SCCP management detects that a local subsystem has failed,

then SCCP management does the following:

- 1) Instructs the translation function to update the translation tables.
- 2) Marks as "prohibited" the status of that subsystem.
- 3) Initiates a local broadcast (5.3.6.2) of "User-out-of-service" information for the prohibited subsystem.
- 4) Initiates the subsystem status test procedure (5.3.4) if the prohibited subsystem is not local.
- 5) Initiates a broadcast (5.3.7) of *Subsystem-Prohibited* messages to concerned signalling points.
- 6) Cancels "ignore subsystem status test" and the associated timer if they are in progress and if the newly prohibited subsystem resides at the local node.

### **5.3.3 Subsystem allowed**

Under one of the following conditions:

- a) SCCP management receives a *Subsystem-Allowed* message about a subsystem other than SSN=1, marked prohibited; or
- b) an N-STATE request primitive with "User-in-Service" information is invoked by a subsystem marked prohibited,

then SCCP management does the following:

- 1) Instructs the translation function to update the translation tables.
- 2) Marks as "allowed" the status of that subsystem.
- 3) Initiates as a local broadcast (5.3.6.3) of "User-in-service" information for the allowed subsystem.



- 04) Discontinues the subsystem status test relating to that subsystem if such a test was in progress.
- 5) Initiates a broadcast (5.3.7) of *Subsystem-Allowed* messages to concerned signalling points.

If the remote SCCP, at which the subsystem reported in the SSA message resides, is marked inaccessible, then the message is treated as an implicit indication of SCCP restart, and the procedures in 5.2.3 are executed.

### 5.3.4 Subsystem status test

#### 5.3.4.1 General

The subsystem status test procedure is an audit procedure to verify the status of a SCCP or subsystem marked as prohibited.

#### 5.3.4.2 Actions at the initiating node

- a) A subsystem status test is initiated when a *Subsystem-Prohibited* message is received (5.3.2.2). For a list of selected subsystems, the subsystems status test may also be initiated on receipt of an MTP\_RESUME indication primitive, a subsystem allowed message with SSN=1 or the time-out of timer T(stat.info). [See 5.2.3 5).]

A subsystem status test associated with a prohibited subsystem is commenced by starting a timer (stat.info) and marking a test in progress. No further actions are taken until the timer expires.

Upon expiration of the timer, a *Subsystem-Status-Test* message is sent to SCCP management at the node of the prohibited subsystem and the timer is reset.

The cycle continues until the test is terminated by another SCCP management function at that node. Termination of the test causes the timer and the "test progress mark" to be cancelled.

- b) A subsystem status test for SSN=1 is initiated when an MTP-STATUS indication primitive is received with "remote user inaccessibility" or "unknown" information for the SCCP at a remote signalling point.

After sending an SST(SSN=1), the node should receive either an SSA(SSN=1) from the restarting node or it should receive an MTP-STATUS indication primitive stating User Part Unavailable. In the case where the SST receiving node has the User Part availability control and its SCCP has not yet recovered, MTP sends a User Part Unavailable (UPU) message to the SST sending node. If neither a SSA(SSN=1) nor a MTP-STATUS indication primitive (User Part Unavailable) is received by the SST sending SCCP during the duration of the T(stat info) timer, then the node should assume that the previously unavailable SCCP has recovered. (This ensures backward compatibility with previous versions of this Recommendation.) If the MTP-STATUS indication primitive stating User Part Unavailable is received before timer T(stat info) expires, then an SST(SSN=1) is sent to the unavailable node when timer T(stat info) expires. A subsystem status test associated with an inaccessible SCCP is done in the same way as for the one associated with a prohibited subsystem, the only difference being that it refers to SSN=1.

#### 5.3.4.3 Actions at the receiving node

When SCCP management receives a *Subsystem-Status-Test* message and there is no "ignore subsystem status test" in progress, it checks the status of the named subsystem. If the subsystem is allowed, then a *Subsystem-Allowed* message is sent to the SCCP management at the node conducting the test. If the subsystem is prohibited, no reply is sent.

In the case where the Subsystem-Status-Test message is testing the status of SCCP management (SSN=1), if the SCCP at the destination node is functioning, then a Subsystem Allowed message with SSN=1 is sent to SCCP management at the node conducting the test. If the SCCP is not functioning, then the MTP cannot deliver the SST message to the SCCP. A UPU message is returned to the SST initiating node by the MTP.

As soon as its SCCP has recovered, the restarting SCCP should broadcast a Subsystem Allowed message for SSN=1 to all concerned nodes. The restarting SCCP should set the status to "allowed" for the SCCP and all subsystems of remote signalling points that it considers available, based on the MTP information at the node.

### **5.3.5 Coordinated state change**

#### **5.3.5.1 General**

A duplicated subsystem may be withdrawn from service without degrading the performance of the network by using the coordinated state change procedure described below when its backup is not local. The procedure, in the case that the primary and the backup subsystems are co-located, is implementation dependent.

#### **5.3.5.2 Actions at the requesting node**

When a duplicated subsystem wishes to go out of service, it invokes a N-COORD request primitive. SCCP management at that node sends a *Subsystem-Out-of-Service-Request* message to the backup system, sets a timer (coord.chg) and marks the subsystem as "waiting for grant".

Arrival of a *Subsystem-Out-of-Service-Grant* message at the requesting SCCP management causes the timer (coord.chg) to be cancelled, the "waiting for grant" state to be cancelled, and a N-COORD confirm primitive to be invoked to the requesting subsystem. *Subsystem-Prohibited* messages are broadcast (5.3.7) to concerned signalling points.

In addition, an "ignore subsystem status test" timer is started and the requesting subsystem is marked as "ignore subsystem status test". Subsystem status tests are ignored until the "ignore subsystem status test" timer expires or the marked subsystem invokes a N-STATE request primitive with "User-out-of-service" information.

If no "waiting for grant" is associated with the subsystem named in the *Subsystem-Out-of-Service-Grant* message, then the *Subsystem-Out-of-Service-Grant* message is discarded and no further action is taken.

If the timer associated with the subsystem waiting for the grant expires before a *Subsystem-Out-of-Service-Grant* message is received, then the "waiting for grant" is cancelled and the request is implicitly denied.

#### **5.3.5.3 Actions at the requested node**

When the SCCP management at the node at which the backup subsystem is located receives the *Subsystem-Out-of-Service-Request* message, it checks the status of local resources<sup>11</sup>. If the SCCP has sufficient resources to assume the increased load, then it invokes a N-COORD indication primitive to the backup subsystem. If the SCCP does not have sufficient resources, no further action is taken.

If the backup system has sufficient resources to allow its duplicate to go out of service, then it informs SCCP management by invoking a N-COORD response primitive. A *Subsystem-Out-of-Service Grant* message is sent to SCCP management at the requesting node. If the backup subsystem does not have sufficient resources, no reply is returned<sup>11</sup>.

---

<sup>11</sup> Local resources critical to this particular node are implementation dependent.

## 5.3.6 Local broadcast

### 5.3.6.1 General

The local broadcast procedure provides a mechanism to inform local allowed concerned subsystems of any related SCCP/subsystem/signalling point status information received.

### 5.3.6.2 User-out-of-service

A local broadcast of "User-out-of-service" information is initiated when:

- a) a *Subsystem-Prohibited* message is received about a subsystem marked allowed (5.3.2.2);
- b) an N-STATE request primitive with "User-out-of-service" information is invoked by a subsystem marked allowed (5.3.2.2)<sup>12</sup>;
- c) a local subsystem failure is detected by SCCP management (5.3.2.2)<sup>12</sup>;
- d) an MTP-PAUSE indication primitive is received (5.2.2); or
- e) an MTP-STATUS indication primitive with cause "inaccessible" is received (5.2.2).

SCCP management then informs local allowed concerned SCCP subsystems about the subsystem status by invoking N-STATE indication primitive with "User-out-of-service" information.

### 5.3.6.3 User-in-service

A local broadcast of "subsystem-in-service" information is initiated when:

- a) a *Subsystem-Allowed* message is received about a subsystem marked prohibited (5.3.3);
- b) an N-STATE request primitive where "User-in-service" information is invoked by a subsystem marked prohibited (5.3.3);
- c) an MTP-RESUME indication primitive is received (see 5.2.3, SCMG action 8);
- d) a Subsystem Allowed message is received with SSN=1; about a remote SCCP marked prohibited (see 5.2.3, SCMG action 4);
- e) timer T(stat info) expires, or; (see 5.2.3, SCMG action 4);
- f) an indication of the end of MTP Restart is received (see 5.2.5, SCMG action 6).

SCCP management then informs local allowed concerned SCCP subsystems, except the newly allowed one in case d) above, about the subsystem status by invoking an N-STATE indication primitive with "User-in-service" information.

### 5.3.6.4 Signalling point inaccessible

A local broadcast of "signalling point inaccessible" or "remote SCCP inaccessible" information is initiated when an MTP-PAUSE primitive or MTP-STATUS primitive (with "user part unavailable" information for a SCCP) is received. SCCP management then informs local allowed concerned SCCP subsystems about the signalling point status by invoking an N-PC-STATE indication primitive with "signalling point inaccessible" or "remote SCCP inaccessible" information.

### 5.3.6.5 Signalling point or remote SCCP accessible

A local broadcast of "signalling point accessible" or "remote SCCP accessible" information is initiated when an MTP-RESUME primitive, an SSA(with SSN=1) message or an indication of the end of the MTP restart is received or when timer T(stat info) expires. SCCP management then informs local allowed concerned SCCP subsystems about the signalling point status by invoking an

---

<sup>12</sup> These cases are applicable when the SCCP is used for routing between local subsystems. This function is implementation dependent.

N-PC-STATE indication primitive with "signalling point accessible" or "SCCP accessible information.

#### **5.3.6.6 Restricted importance level reporting**

A local broadcast of "signalling point congested" information is initiated when there is any change in the "restricted importance level" (see 5.2.8). SCCP management then informs local allowed concerned SCCP subsystems about the signalling point status by invoking an N-PC-STATE indication primitive with "restricted importance level" and the new value of the restricted importance level.

### **5.3.7 Broadcast**

#### **5.3.7.1 General**

The broadcast procedure provides a mechanism that may be used to inform concerned signalling points of any related SCCP/subsystem status change at local or adjacent signalling points. It is a procedure supplementary to that defined in 5.3.2.1.

The procedure to inform nodes that are not "concerned" of status change is described in 5.3.2.1 and 5.3.4.

#### **5.3.7.2 Subsystem prohibited**

A broadcast of *Subsystem-Prohibited* messages is initiated when:

- a) a *Subsystem Prohibited* message is received about a subsystem presently marked allowed (5.3.2.2), and the affected point code identified in the SSP message is the same as that of the informer signalling point;
- b) an N-STATE request primitive where "User-out-of-service" information is invoked by a subsystem marked allowed (5.3.2.2); or
- c) a local subsystem failure is detected by SCCP management (5.3.2.2).

This broadcast permits SCCP management to inform all concerned signalling points, except the informer signalling point, about the subsystem status by *Subsystem-Prohibited* messages. SCCP management does not broadcast if the point code of the prohibited subsystem is different from that of the informer signalling point which originates the *Subsystem-Prohibited* message.

#### **5.3.7.3 Subsystem allowed**

A broadcast of *Subsystem-Allowed* messages is initiated when:

- a) a *Subsystem-Allowed* message is received about a subsystem presently marked prohibited and not equal to one (SCMG) (5.3.3), and the affected point code identified in the SSA message is the same as that of the informer signalling point; or
- b) an N-STATE request primitive where "User-in-service" information is invoked by a subsystem marked prohibited (5.3.3).

At the end of the SCCP restarting process, the restarting SCCP should broadcast a Subsystem Allowed message for SSN=1 to all concerned nodes. The restarting SCCP should set the status to "allowed" for the SCCP and all subsystems of the remote signalling points that it considers available based on MTP information at the node.

Broadcast of Subsystem Allowed messages permits SCCP management to inform all concerned signalling points, except the informer signalling point, about the subsystem status. SCCP management does not broadcast if the point code of the allowed subsystem is different from that of the informer signalling point which originates the *Subsystem-Allowed* message.

## 5.4 MTP/SCMG restart

NOTE – Whether or not the scope of this subclause is restricted to SCCP restart is for further study.

On a signalling point restart, an indication is given to the SCCP by the MTP about the signalling points which are accessible after the restart actions. For each accessible signalling point known by the SCCP, all subsystems and the SCCP are marked as allowed. The response method is used to determine the status of the SCCP and the SCCP subsystems in those signalling points, in the absence of subsystem prohibited messages.

At the restarted signalling point, the status of its own subsystems are not broadcast to concerned signalling points. In this case, the response method is used to inform other nodes attempting to access prohibited subsystems at the restarted signalling points. At the completion of SCCP restart, the status of the SCCP is broadcast to concerned signalling points. The actions to be taken in the case of a local MTP restart are described in 5.2.5.

## 6 References

The following ITU-T Recommendations and other references contain provisions which, through reference in this text, constitute provisions of this Recommendation. At the time of publication, the editions indicated were valid. All Recommendations and other references are subject to revision: all users of this Recommendation are therefore encouraged to investigate the possibility of applying the most recent edition of the Recommendations and other references listed below. A list of the currently valid ITU-T Recommendations is regularly published.

The references contained in 6.1 and 6.2 contain the reference list for the ITU-T Recommendations Q.711, Q.712, Q.713 and Q.714.

### 6.1 Normative references

- CCITT *Blue Book*, Fascicle VI.7 (1988), *Glossary of terms used in Signalling System No. 7*.
- ITU-T Recommendation Q.701 (1993), *Functional description of the Message Transfer Part (MTP) of Signalling System No. 7*.
- ITU-T Recommendation Q.704 (1996), *Signalling network functions and messages*.
- ITU-T Recommendation Q.711 (1996), *Functional description of the Signalling Connection Control Part*.
- ITU-T Recommendation Q.712 (1996), *Definition and function of signalling connection control part messages*.
- ITU-T Recommendation Q.713 (1996), *Signalling connection control part, formats and codes*.
- ITU-T Recommendation Q.714 (1996), *Signalling connection control part procedures*.
- ITU-T Recommendation Q.2210 (1996), *Message transfer part level 3 functions and messages using the services of ITU-T Recommendation Q.2140*.
- ITU-T Recommendation X.210 (1993), *Information technology – Open Systems Interconnection – Basic Reference Model: Conventions for the definition of OSI services*.

### 6.2 Informative references

- ITU-T Recommendation Q.700 (1993), *Introduction to CCITT Signalling System No. 7*.
- ITU-T Recommendation Q.706 (1993), *Message transfer part signalling performance*.

- ITU-T Recommendation Q.715 (1996), *Signalling connection control part user guide*.
- ITU-T Recommendation Q.716 (1993), *Signalling Connection Control Part (SCCP), performance*.
- ITU-T Recommendation Q.1400 (1993), *Architecture framework for the development of signalling and OA&M protocols using OSI concepts*.
- ITU-T Recommendation Q.2110 (1994), *B-ISDN ATM adaptation layer – Service Specific Connection Oriented Protocol (SSCOP)*.
- ITU-T Recommendation Q.2140 (1995), *B-ISDN signalling ATM adaptation layer – Service Specific Coordination Function for signalling at the Network Node Interface (SSCF at NNI)*.
- ITU-T Recommendation X.200 (1994), *Open Systems Interconnection – Basic reference model: The basic model*.
- ITU-T Recommendation X.213 (1995), *Information technology – Open Systems Interconnection – Network service definition (Note)*.

NOTE – Further study is required to see which new parts of SCCP can use this Recommendation normatively.

## ANNEX A

### **State diagrams for the signalling connection control part of Signalling System No. 7**

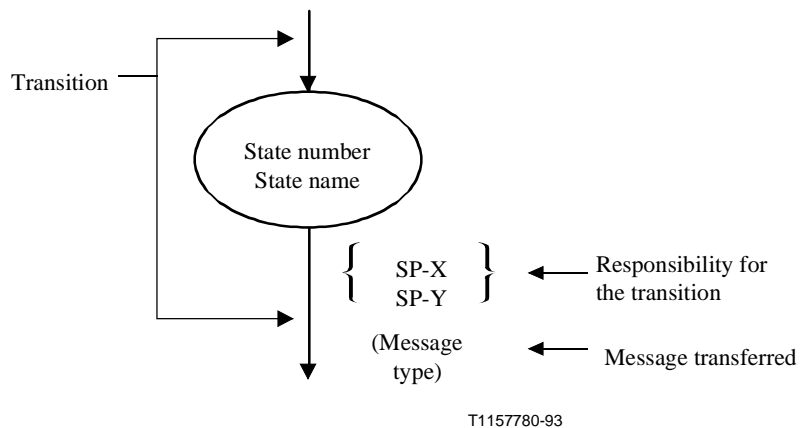
#### **A.1 Introduction**

This Annex contains the definitions for the symbols used and defines the states of the signalling point X/Y interface and the transitions between states in the normal case.

Annex B contains the full definition of actions, if any, to be taken on the receipt of messages by a signalling point.

#### **A.2 Symbol definition of the state diagrams at the message interface**

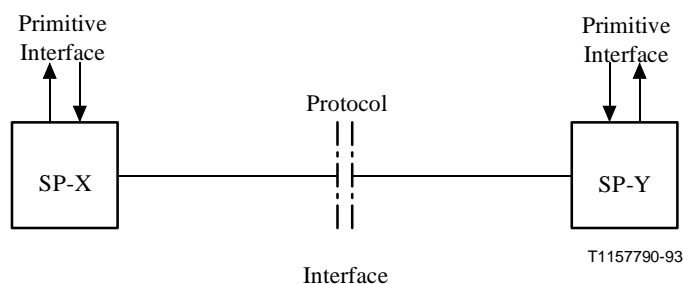
Symbol definition of the state diagrams at the message interface between two nodes (signalling points: X and Y) (see Figures A.1 and A.2).



NOTE 1 – Each state is represented by an ellipse wherein the state name and number are indicated.

NOTE 2 – Each state transition is represented by an arrow. The responsibility for the transition (SP-X or SP-Y) and the message that has been transferred is indicated beside that arrow.

**Figure A.1/Q.714 – Symbol definition of the state diagram**



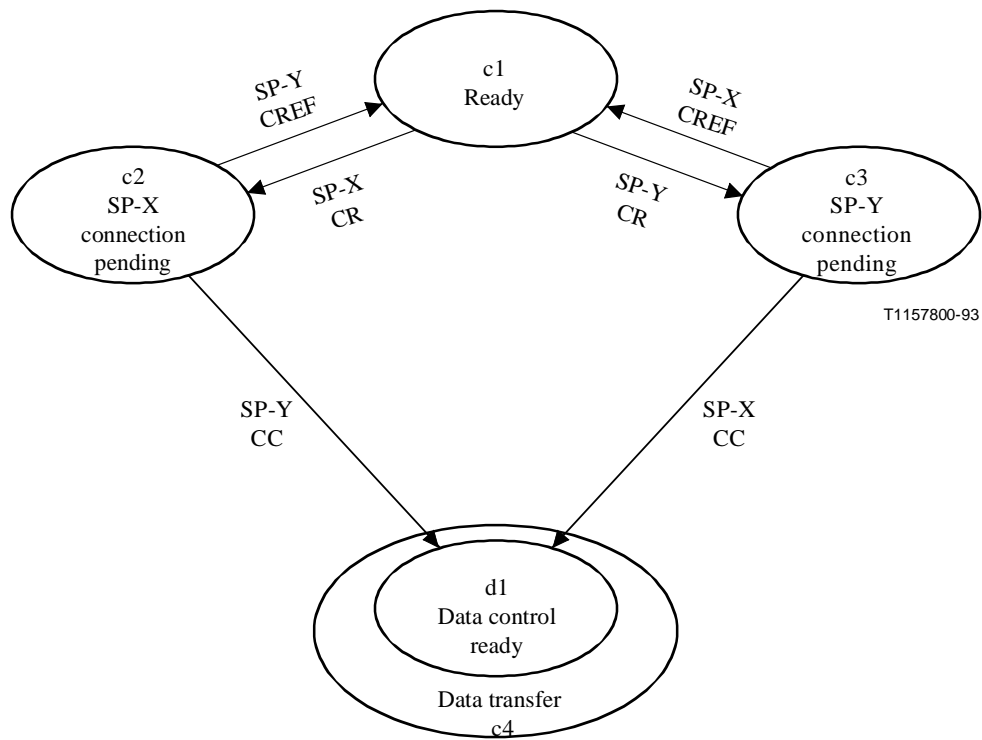
NOTE – SP-X and SP-Y are the signalling points X and Y denoting respectively the origin and destination of the connection section concerned.

**Figure A.2/Q.714 – Primitive and protocol interface**

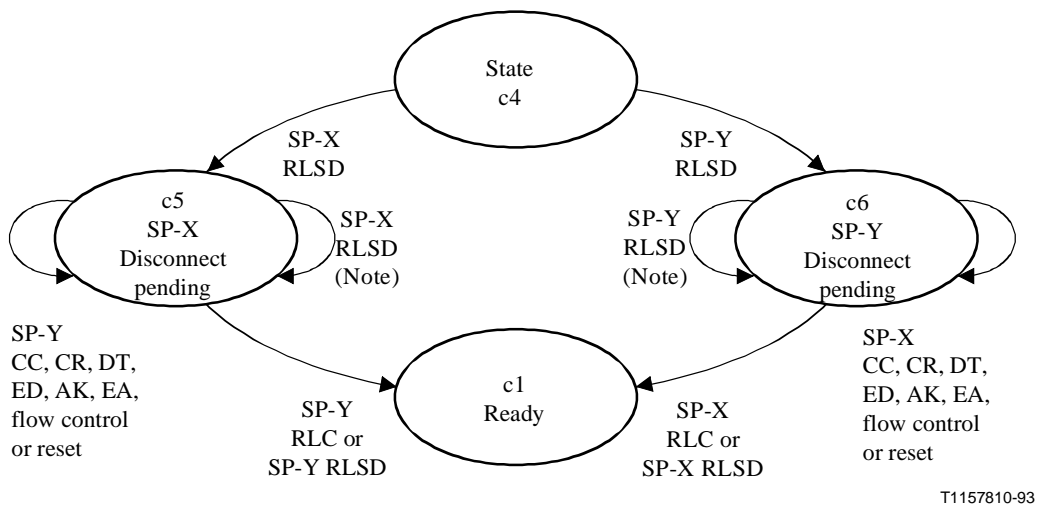
### A.3 Symbol definition of the state diagrams

For the sake of clarity, the normal procedure at an interface is described in a number of small state diagrams. In order to describe the normal procedure fully, it is necessary to allocate a priority to the different figures and to relate a higher order diagram with a lower one. This has been done by the following means:

- Figures A.3, A.4, A.5 and A.6 are arranged in order of priority, with Figure A.3 having the highest priority and subsequent figures having lower priority. Priority means that when a message belonging to a higher order diagram is transferred, that diagram is applicable and the lower order one is not.
- The relation with a state in a lower order diagram is given by including that state inside an ellipse in the higher order diagram.
- The message abbreviations are those defined in Recommendation Q.712.



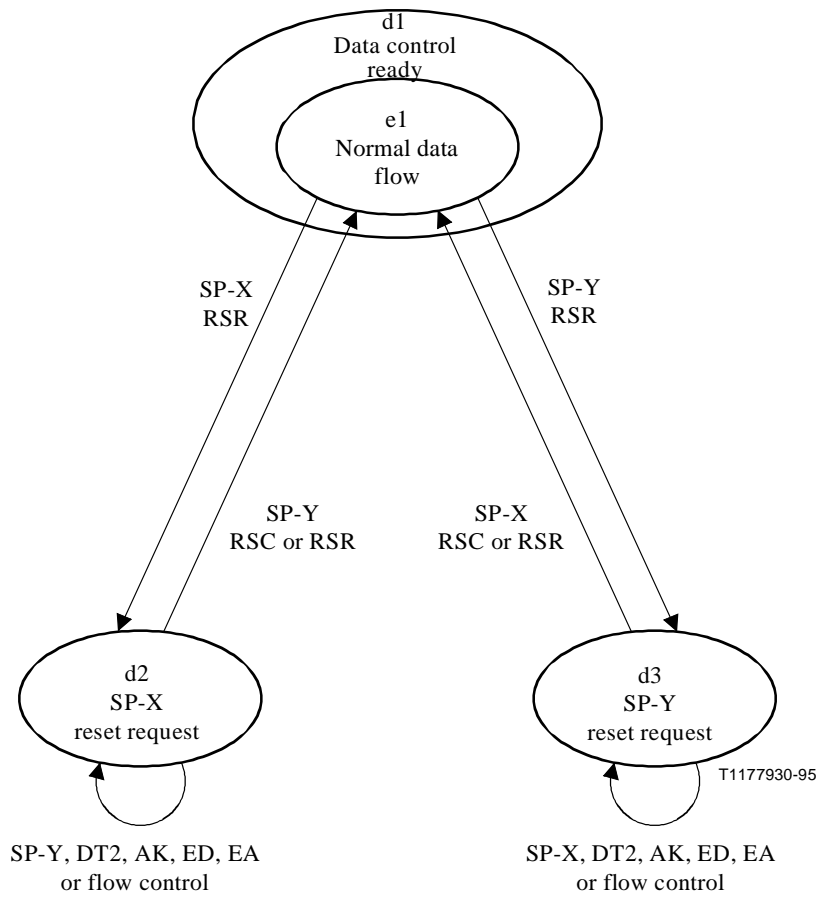
**Figure A.3/Q.714 – State transition diagram for sequences of messages during connection establishment**



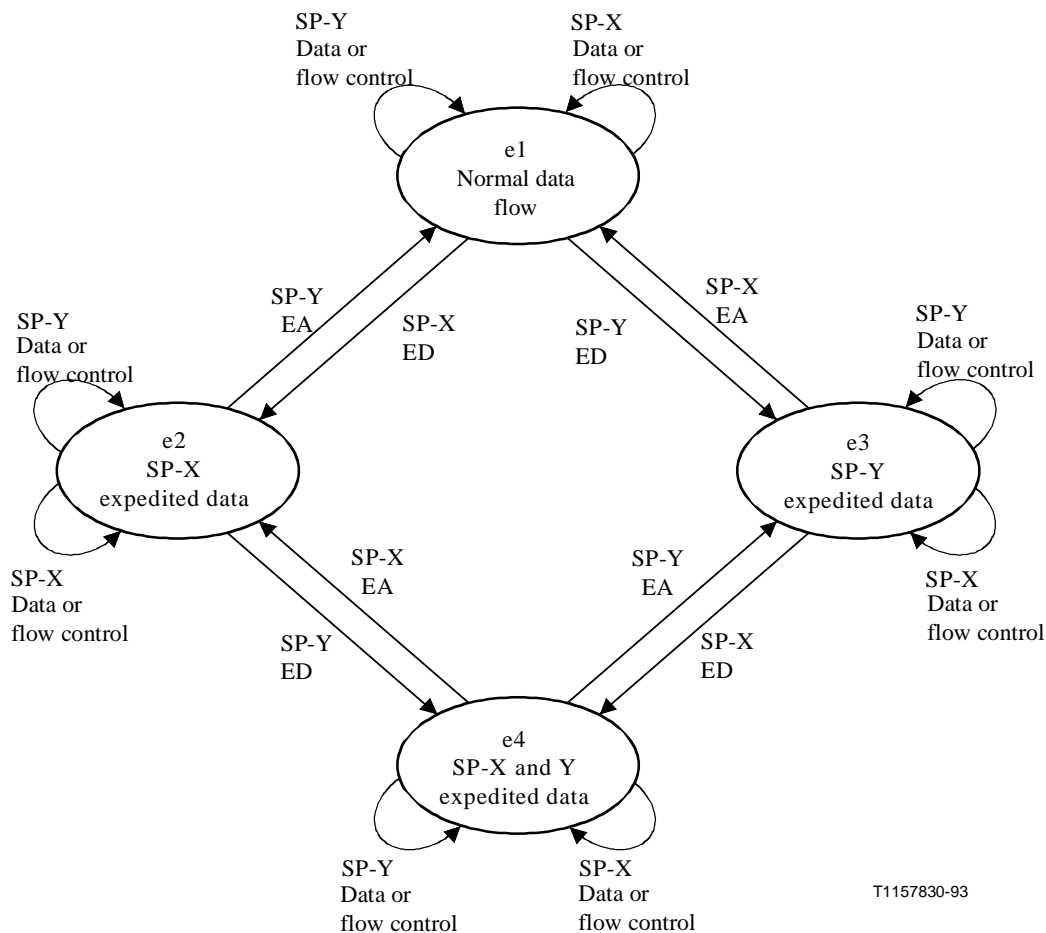
NOTE – This transition may take place after time-out.

**Figure A.4/Q.714 – State transition diagram for sequences of messages during connection release**





**Figure A.5/Q.714 – State transition diagram for the transfer of reset messages within the data transfer (c4) state**



T1157830-93

**Figure A.6/Q.714 – State transition diagram for the transfer of data, expedited data and flow control within the data control ready (d1) state**

## ANNEX B

### Action tables for the SCOC

#### B.1 Introduction

This Annex contains the definitions for the symbols used and contains the full definition of actions, if any, to be taken on the receipt of messages by a signalling point (node).

Annex A contains the full definition of states of the signalling point X/Y interface and the transitions between states in the normal case.

#### B.2 Symbol definition of the action tables

The entries given in Tables B.1 and B.2 indicate the action, if any, to be taken by a SP on receipt of any kind of message, and the state that the SP enters, which is given in parentheses, following the action taken.

In any state, it is possible to receive an Error message (ERR). The reaction, if any, depends on the contents (error cause) of the message and is specified in 3.8.6.

The reaction to messages received with procedure errors are normal actions and will be described in the text. Therefore, they are covered by the actions indicated as NORMAL in the action table.

### B.3 Table of contents

Table B.1: Actions taken by SP-Y on receipt of messages.

Table B.2: Actions taken by SP-Y on receipt of message with known message type and containing mismatch information.

Table B.3: Actions taken by SP-Y on receipt of messages during connection establishment, data transfer and release phases.

Table B.4: Actions taken by SP-Y on receipt of messages during the data transfer phase in a given state: reset.

Table B.5: Actions taken by SP-Y on receipt of messages during the data transfer phase in a given state: data, expedited data, flow control.

**Table B.1/Q.714 – Action taken by SP-Y on receipt of messages**

<b>Message received by node SP-Y</b> / <b>State of the interface as perceived by node SP-Y</b>	<b>Any state</b>
Any message with unknown message type (Note)	DISCARD
Any message with known message type and: <ul style="list-style-type: none"> <li>a) unassigned destination local reference number; or</li> <li>b) originating Point Code received not equal to the PC stored locally; or</li> <li>c) source local reference number received not equal to the remote local reference number stored locally</li> </ul>	See Table B.2
Any other message	See Table B.3
DISCARD: SP-Y discards the received message and takes no subsequent action. NOTE – This notion of unknown message type depends upon the implemented protocol class.	

**Table B.2/Q.714 – Action taken by SP-Y on receipt of messages with known message type and containing mismatch information as in Table B.1 in any state**

Message received by node SP-Y \ Type of mismatch information	Unassigned destination local reference number	Source local reference number received not equal to the one stored locally	Originating Point Code received not equal to the PC stored locally (Note 1)
CR (X)	N/A	N/A	N/A
CC (Y, X)	Send ERR (X) (Note 2)	N/A	N/A
CREF (Y)	DISCARD	N/A	N/A
RLSD (Y, X)	Send RLC (X, Y) (Note 2)	Send ERR (X) (Note 2)	Send ERR (X) (Note 2)
RLC (Y, X)	DISCARD	DISCARD	DISCARD
DT1 (Y)	DISCARD	N/A	DISCARD
DT2 (Y)	DISCARD	N/A	DISCARD
AK (Y)	DISCARD	N/A	DISCARD
ED (Y)	DISCARD	N/A	DISCARD
EA (Y)	DISCARD	N/A	DISCARD
RSR (Y, X)	Send ERR (X) (Note 2)	Send ERR (X) (Note 2)	Send ERR (X) (Note 2)
RSC (Y, X)	Send ERR (X) (Note 2)	Send ERR (X) (Note 2)	Send ERR (X) (Note 2)
ERR (Y)	DISCARD	N/A	DISCARD
IT (Y, X)	DISCARD	(Note 3) RLSD (X, Y) RLSD (X', Y)	DISCARD

DISCARD: SP-Y discards the received message and takes no subsequent action.

N/A Not Applicable

NAME (d, s): NAME = abbreviation of message

d = destination local reference number

s = source local reference number.

NOTE 1 – Performing this check is implementation dependent and applicable to whole column.

NOTE 2 – In this situation no action is taken locally on any existing connection section. Information in any message sent back is taken from the received message.

NOTE 3 – One released message contains information from the received message. Second released message contains information stored locally.

**Table B.3/Q.714 – Action taken by SP-Y on receipt of messages during connection establishment, data transfer and release phases**

State of the interface as perceived by node SP-Y  Message received by node SP-Y	Signalling connection control ready:					
	Ready (c1)	SP-X connection pending (c2)	SP-Y connection pending (c3)	Data transfer (c4)	SP-X disconnect pending (c5)	SP-Y disconnect pending (c6)
Connection request (CR)	NORMAL (c2)	(Note)				
Connection confirm (CC)	See Table B.2	DISCARD (c2)	NORMAL (c4)	DISCARD (c4)	ERROR 1 (c6)	DISCARD (c6)
Connection refused (CREF)		DISCARD (c2)	NORMAL (c1)	DISCARD (c4)	ERROR 1 (c6)	DISCARD (c6)
Released (RLSD)		DISCARD (c2)	ERROR 3 (c1)	NORMAL (c5)	DISCARD (c5)	NORMAL (c1)
Release complete (RLC)		DISCARD (c2)	ERROR 3 (c1)	DISCARD (c4)	ERROR 1 (c6)	NORMAL (c1)
ERROR (ERR)		DISCARD (c2)	ERROR3 (c1)	See 3.8.6	ERROR3 (c1)	ERROR3 (c1)
Other messages		DISCARD (c2)	ERROR 3 (c1)	See Table B.4	ERROR 1 (c6)	DISCARD (c6)
<p>NORMAL: The action taken by SP-Y follows the normal procedures as defined in the appropriate sections of the procedure text.</p> <p>DISCARD: SP-Y discards the received message and takes no subsequent action.</p> <p>ERROR 1: SP-Y discards the received message and initiates a connection release by sending a RLSD message with the proper invalid type cause.</p> <p>NOTE – Reception of CR in these states is not possible because CR does not contain a destination local reference number (no search is performed).</p>						

**Table B.4/Q.714 – Action taken by node SP-Y as receipt of message during the data transfer state**

State of the interface as perceived by node SP-Y  Message received by node SP-Y	Data transfer control ready: c4		
	Data transfer control ready (d1)	SP-X reset request (d2)	SP-Y reset request (d3)
Reset Request (RSR) (Note 2)	NORMAL (d2)	DISCARD (d2)	NORMAL (d1)
Reset confirmation (RSC) (Note 2)	ERROR (d3)	ERROR (d3)	NORMAL (d1)
Other messages	See Table B.5	ERROR (d3) (Note 1)	DISCARD (d3)
<p><b>NORMAL:</b> The action taken by SP-Y follows the normal procedures as defined in the appropriate sections of the procedure text.</p> <p><b>DISCARD:</b> Signalling point Y discards the received message and takes no subsequent action.</p> <p><b>ERROR:</b> Signalling point Y discards the received message and initiates a reset by transmitting a reset request message with the appropriate cause indication.</p> <p><b>NOTE 1 –</b> If signalling point Y issues a reset by transmitting a reset request message as a result of an error condition in state d2, then it should finally consider the interface to be in the data control ready state (d1).</p> <p><b>NOTE 2 –</b> Reception of these messages for a class 2 connection section may trigger the sending of an ERR message back if these message types are known by the receiving SCCP.</p>			

**Table B.5/Q.714 – Action taken by node SP-Y on receipt of messages during the data control ready state**

State of the interface as perceived by node SP-Y  Message received by node SP-Y	Signalling connection data control ready: d1			
	Normal data flow e1	SP-X expedited data e2	SP-Y expedited data e3	SP-X and SP-Y expedited data e4
Expedited data (ED)	NORMAL (e2)	ERROR (d3)	NORMAL (e4)	ERROR (d3)
Expedited data acknowledge (EA)	DISCARD (e1)	DISCARD (e2)	NORMAL (e1)	NORMAL (e2)
DT, AK, IT	NORMAL (e1)	NORMAL (e2)	NORMAL (e3)	NORMAL (e4)
<p>NORMAL: The action taken by signalling point Y follows the normal procedures as defined in the appropriate sections of the procedure text.</p> <p>DISCARD: Signalling point Y discards the received message and takes no subsequent action as a direct result of receiving that message.</p> <p>ERROR: Signalling point Y discards the received message and indicates a reset by transmitting a Reset Request (RSR) message with the appropriate cause indication (e.g. procedure error).</p> <p>NOTE – Reception of an ED, EA, DT2 or AK message for a class 2 connection section will cause the receiving SCCP to DISCARD any of these messages. A DT1 message received for a class 3 connection section will also be discarded.</p>				

## ANNEX C

### State Transition Diagrams (STD) for the signalling connection control part of Signalling System No. 7

#### C.1 General

This Annex contains the description of the main SCCP functions [except SCCP management (SCMG) which is contained in Annex D] according to the CCITT Specification and Description Language (SDL).

For the SCCP as a whole, Figure 1 illustrates a subdivision into functional blocks, showing their functional interactions as well as the functional interactions with the other major functions of Signalling System No. 7 (e.g. MTP).

The functional breakdown shown in this diagram is intended to illustrate a reference model, and to assist interpretation of the text of the SCCP procedures. The state transition diagrams are intended to show precisely the behaviour of the signalling system under normal and abnormal conditions as viewed from a remote location. It must be emphasized that the functional partitioning shown in the following diagrams is used only to facilitate understanding of the system behaviour, and is not intended to specify the functional partitioning to be adopted in a practical implementation of the signalling system.

#### C.2 Drafting conventions

Each major function is designated by its acronym (e.g. SCOC = SCCP connection-oriented control).

External inputs and outputs are used for interactions between different functional blocks. Included within each input and output symbol in the state transition diagrams are acronyms which identify the functional blocks which are the source and the destination of the message, e.g.:

SCRC → SCOC indicates that the message is sent from SCCP routing control to SCCP connection-oriented control.

Internal inputs and outputs are only used to indicate control of timers.

### C.3 Figures

The list of figures is as follows:

- Figure C.1: SCCP routing control procedures (SCRC).
- Figure C.2: Connection establishment and release procedures at originating node for SCCP Connection-Oriented Control (SCOC).  
(Sheets 1, 3 and 7: connection establishment, and sheets 4 to 6: connection release procedures).
- Figure C.3: Connection establishment and release procedures at destination node for SCCP Connection-Oriented Control (SCOC).  
(Sheets 1 to 2: connection establishment, and sheets 3 to 6: connection release procedures).
- Figure C.4: Data transfer procedures at originating and destination nodes for SCCP Connection-Oriented Control (SCOC).
- Figure C.5: Expedited data transfer procedures at originating and destination nodes for SCCP Connection-Oriented Control (SCOC).
- Figure C.6: Reset procedures at originating and destination nodes for SCCP Connection-Oriented Control (SCOC).
- Figure C.7: Connection establishment and release procedures at intermediate node for SCCP Connection-Oriented Control (SCOC).  
(Sheets 1 to 4: connection establishment, and sheets 5 to 9: connection release procedures).
- Figure C.8: Data transfer procedures at intermediate node for SCCP Connection-Oriented Control (SCOC).
- Figure C.9: Expedited data transfer procedures at intermediate node for SCCP Connection-Oriented Control (SCOC).
- Figure C.10: Reset procedures at intermediate node for SCCP Connection-Oriented Control (SCOC).
- Figure C.11: Restart procedure for SCCP Connection-Oriented Control (SCOC).
- Figure C.12: SCCP connectionless control (SCLC).
- Figure C.13: Restart control for SCCP Connection-Oriented Control (SCOR).

### C.4 Abbreviations and timers

Abbreviations and timers used in Figures C.1 to C.11 are listed below.



## Abbreviations

CR	Connection Request
DPC	Destination Point Code
GT	Global Title
IT	Inactivity Test
MSG	Message
MTP	Message Transfer Part
NPDU	Network Protocol Data Unit
NSDU	Network Service Data Unit
PC	Point Code
SCCP	Signalling Connection Control Part
SCLC	SCCP Connectionless Control
SCMG	SCCP Management
SCOC	SCCP Connection-Oriented Control
SCRC	SCCP Routing Control
SLS	Signalling Link Selection
SS	SubSystem
SSN	SubSystem Number
SSPC	SubSystem Prohibited Control

## Timers

T(conn est)	Waiting for connection confirm message	1 to 2 minutes
T(ias)	Delay to send a message on a conn IT on a connection section when there are no messages to send	5 to 10 minutes
T(iar)	Waiting to receive a message on a connection section	11 to 21 minutes
T(rel)	Waiting for release complete message	10 to 20 seconds
T(repeat rel)	Waiting for release complete message; or to repeat sending released message after the initial T(rel) expiry	10 to 20 seconds
T(int)	Waiting for release complete message; or to release connection resources, freeze the LRN and alert a maintenance function after the initial T(rel) expiry	extending to 1 minute
T(guard)	Waiting to resume normal procedure for temporary connection sections during the restart procedure (see 3.8)	23 to 25 minutes

T(reset)	Waiting to release temporary connection section or alert maintenance function after reset request message is sent	10 to 20 seconds
T(reassembly)	Waiting to receive all the segments of the remaining segments single segmented message after receiving the first segment	10 to 20 seconds

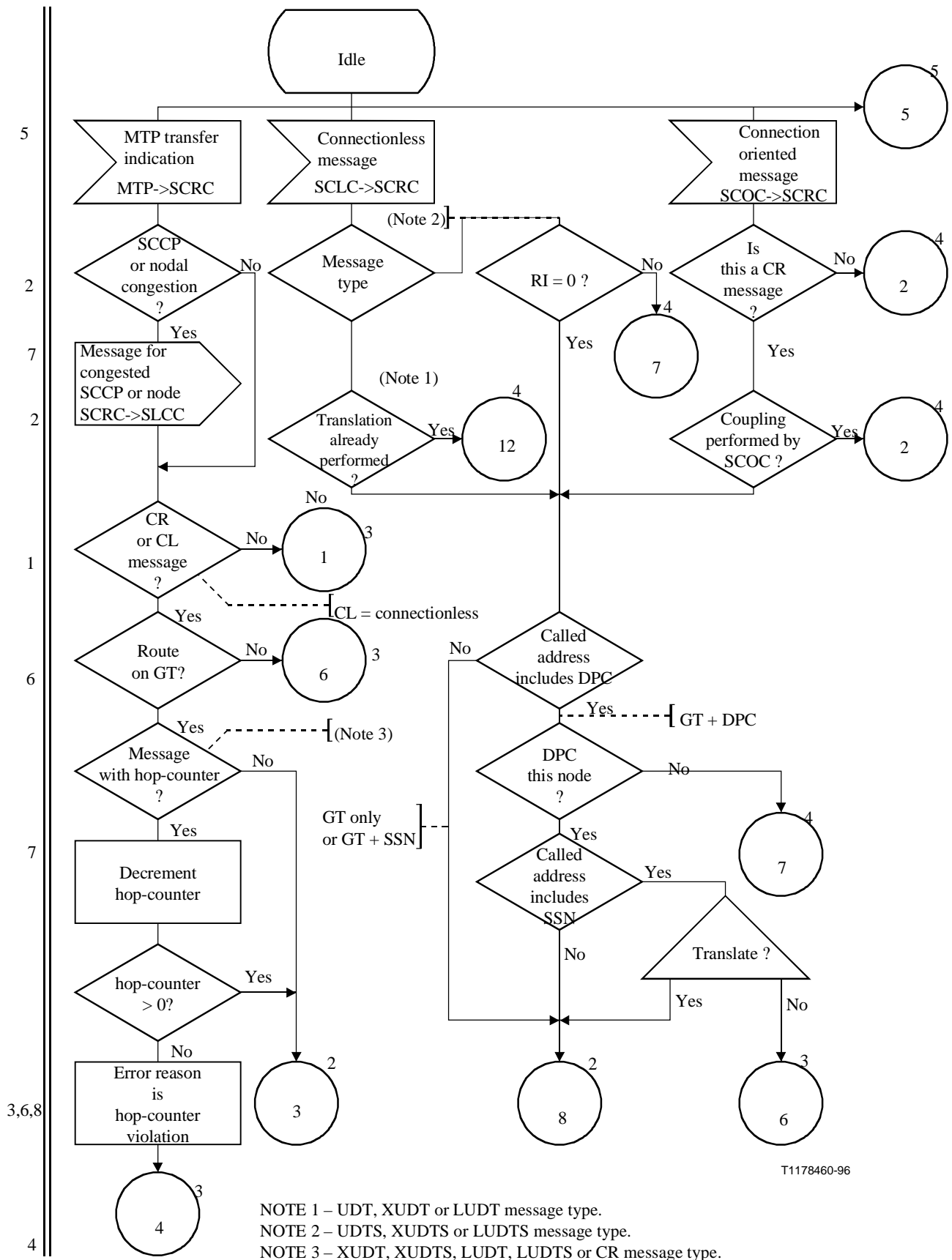
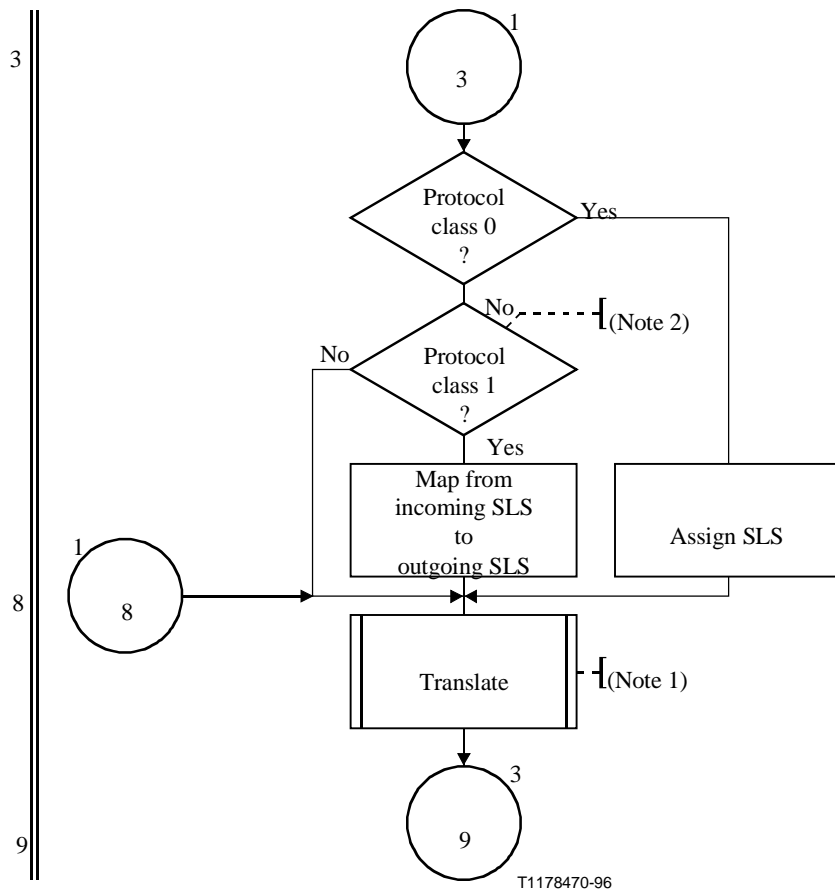
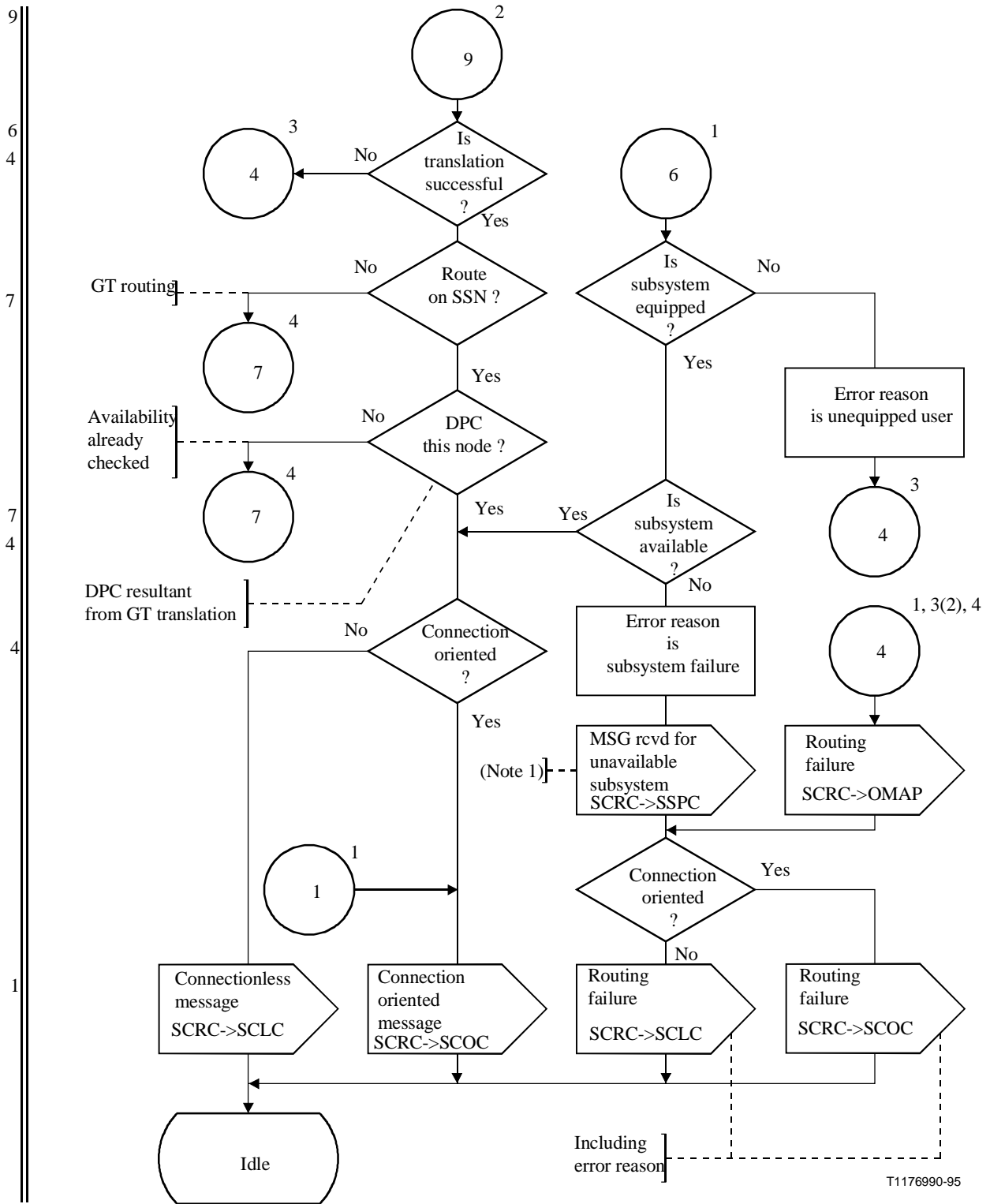


Figure C.1/Q.714 (sheet 1 of 11) – SCCP routing control procedures (SCRC)



NOTE 1 – The optional screening function could be done before or after translation.  
 NOTE 2 – It is implicit that XUDTS message type is treated as protocol class 1.

**Figure C.1/Q.714 (sheet 2 of 11) – SCCP routing control procedures (SCRC)**



NOTE 1 – For messages routed on GT, an SSP message will not be effective, but in any case, inform OMAP.  
 NOTE 2 – Actions for a congested DPC are for further study.

Figure C.1/Q.714 (sheet 3 of 11) – SCCP routing control procedures (SCRC)

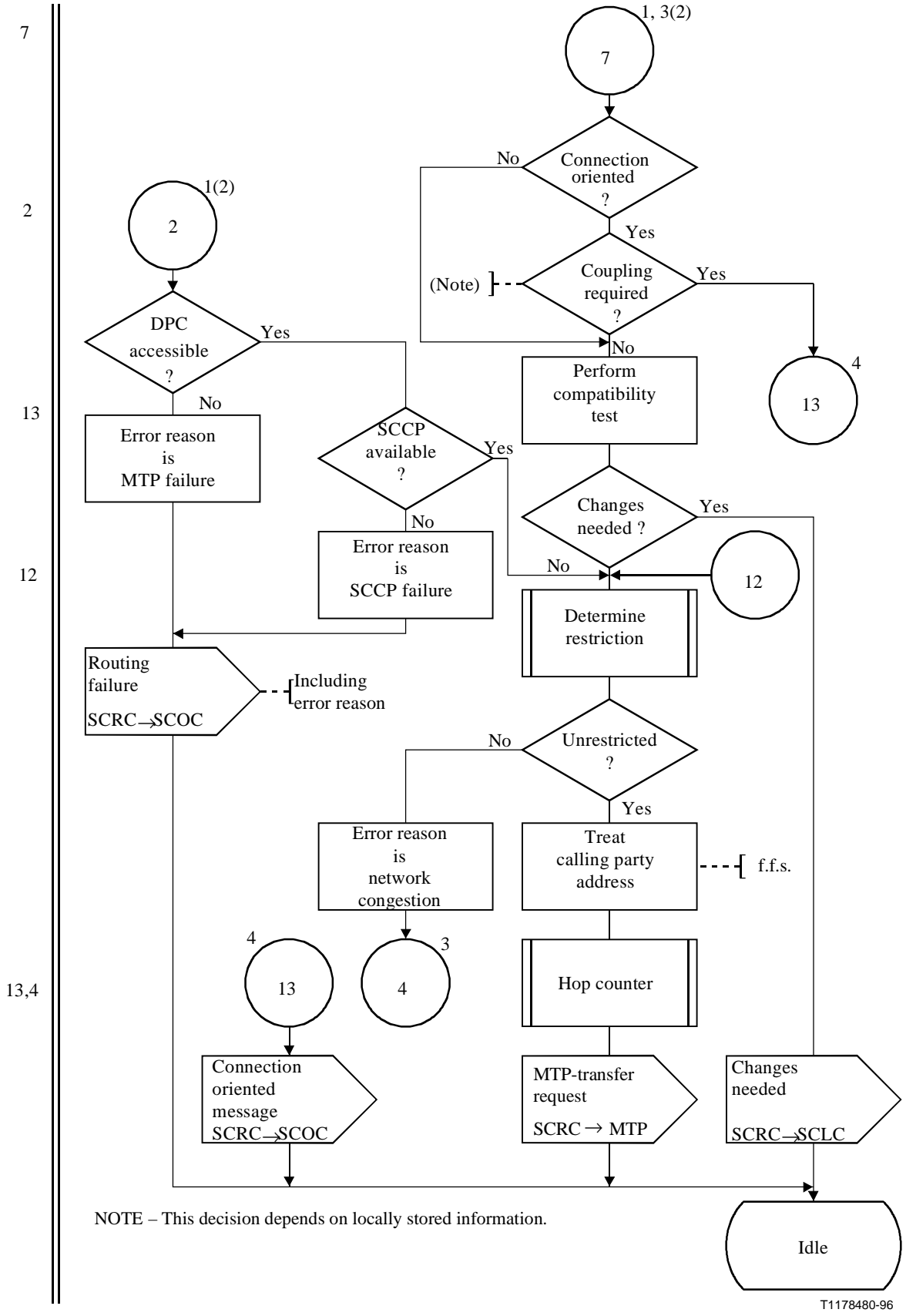


Figure C.1/Q.714 (sheet 4 of 11) – SCCP routing control procedures (SCRC)

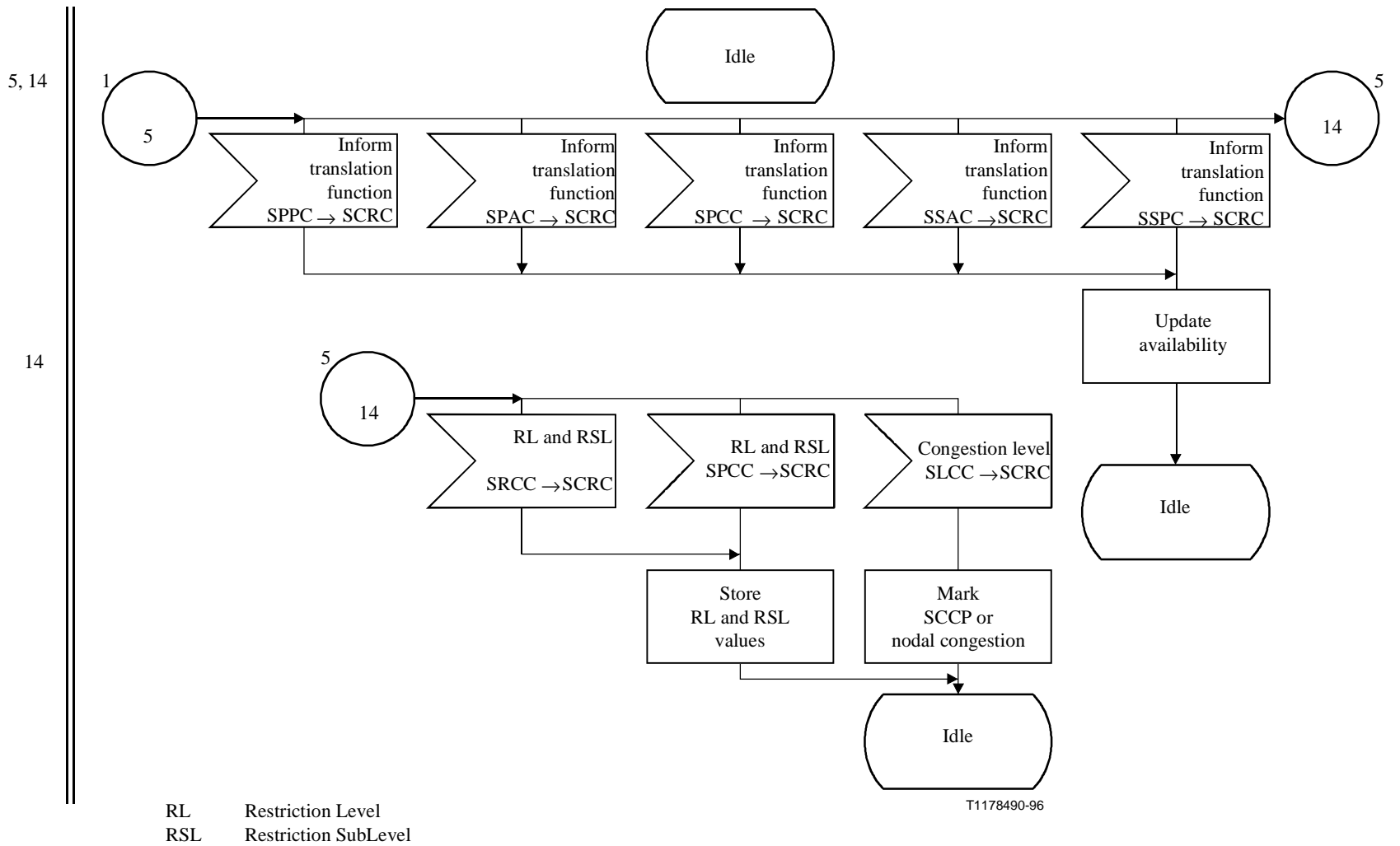


Figure C.1/Q.714 (sheet 5 of 11) – SCCP routing control procedures (SCRC)

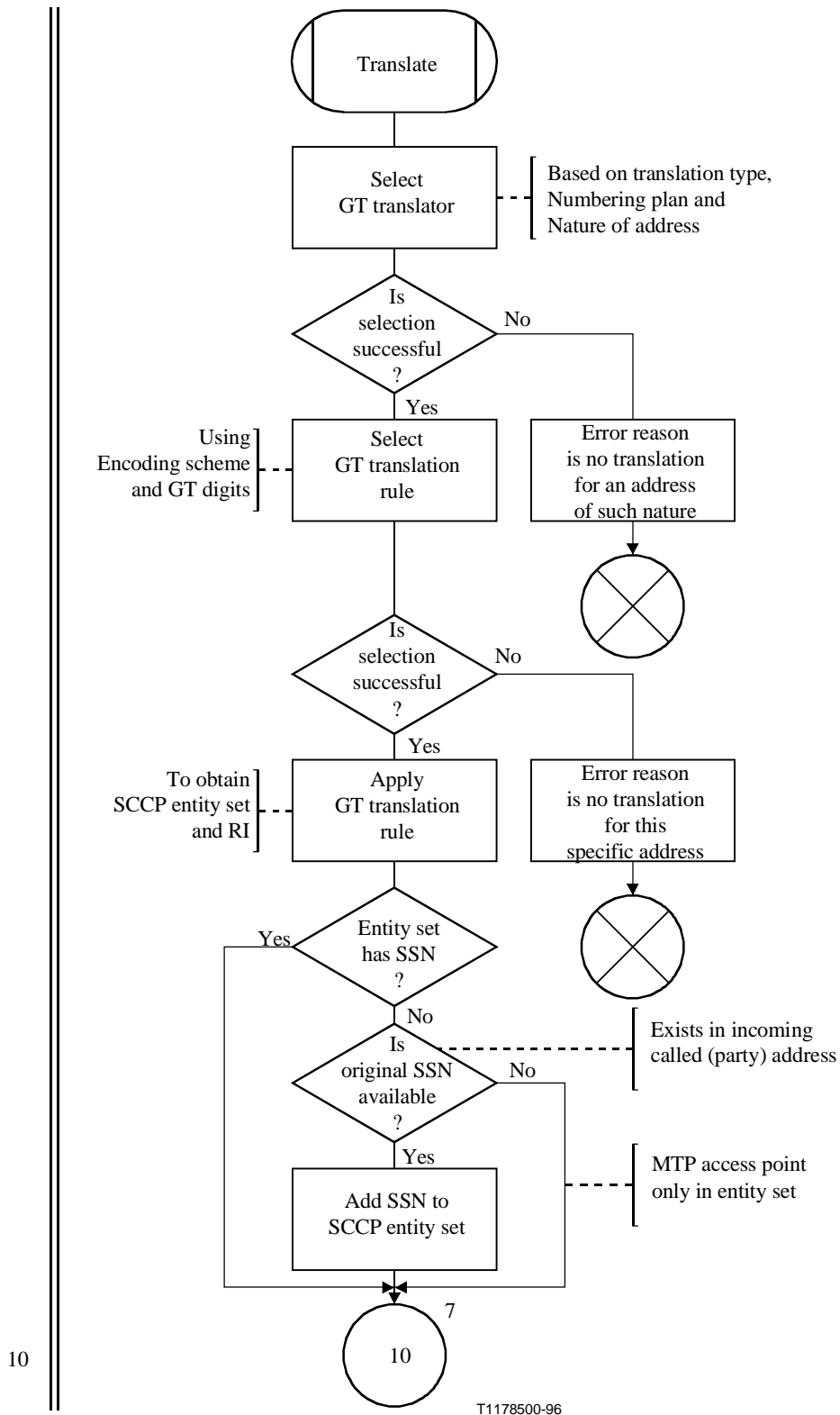


Figure C.1/Q.714 (sheet 6 of 11) – SCCP routing control procedures (SCRC)



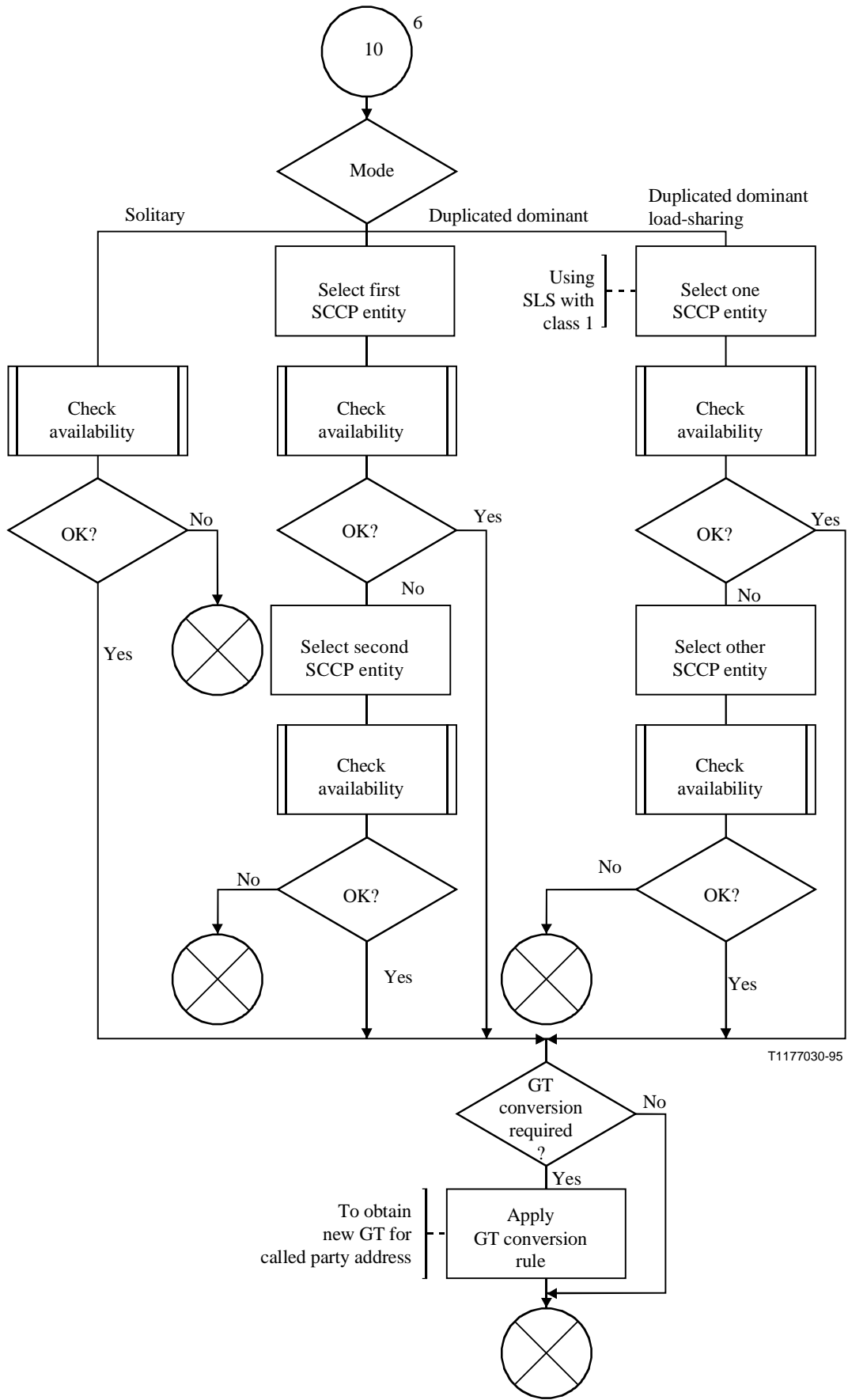


Figure C.1/Q.714 (sheet 7 of 11) – SCCP routing control procedures (SCRC)

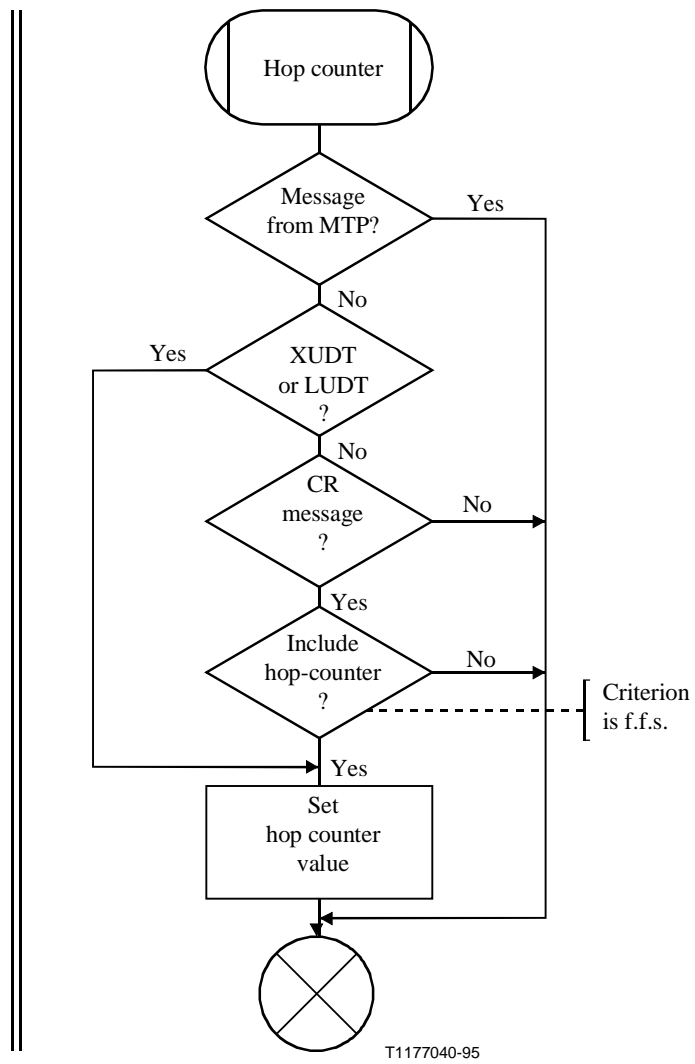
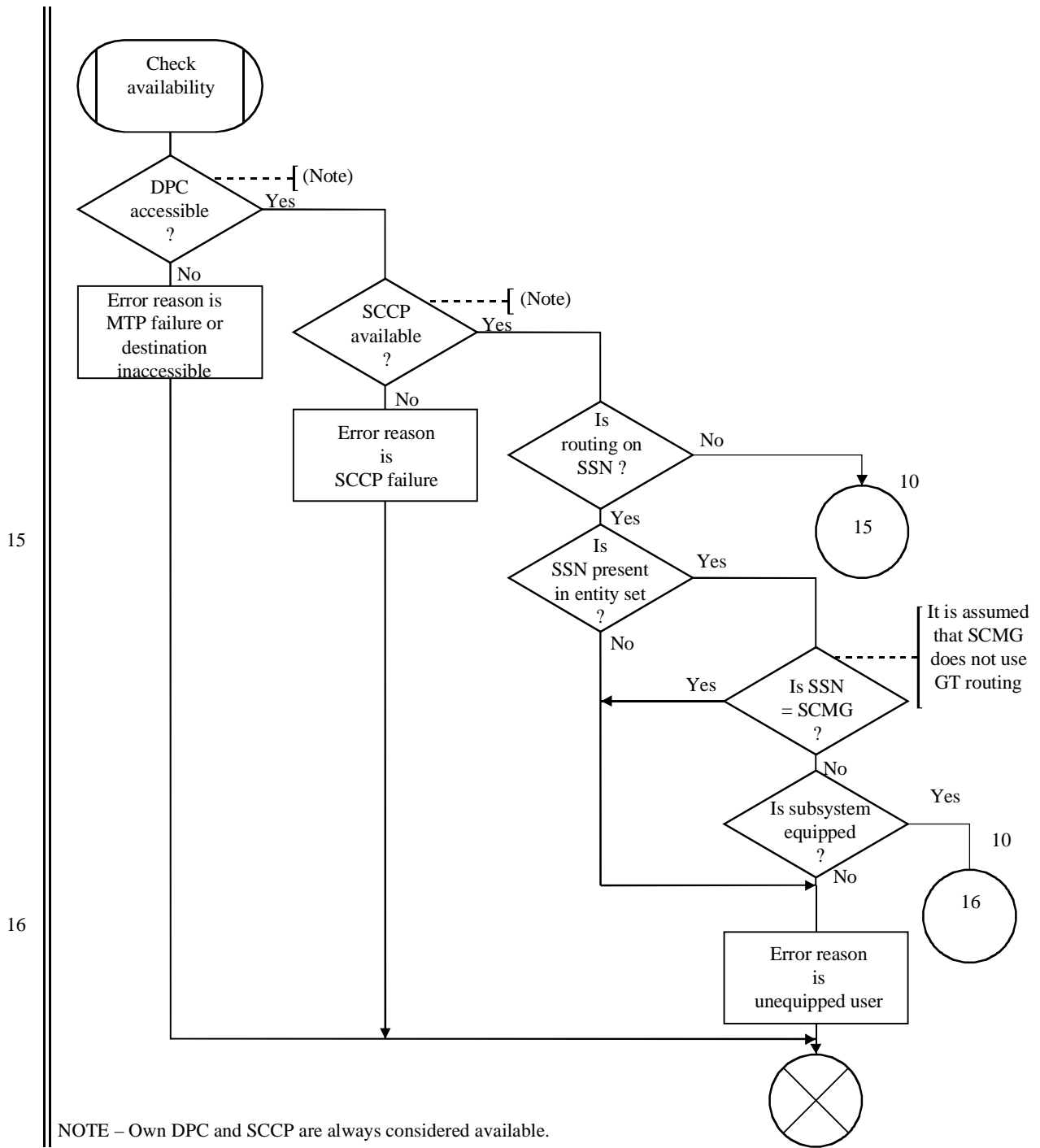
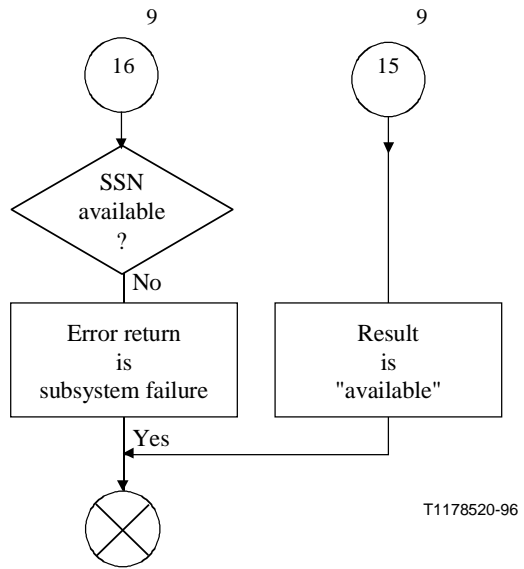


Figure C.1/Q.714 (sheet 8 of 11) – SCCP routing control procedures (SCRC)



T1178510-96

**Figure C.1/Q.714 (sheet 9 of 11) – SCCP routing control procedures (SCRC)**



**Figure C.1/Q.714 (sheet 10 of 11) – SCCP routing control procedures (SCRC)**

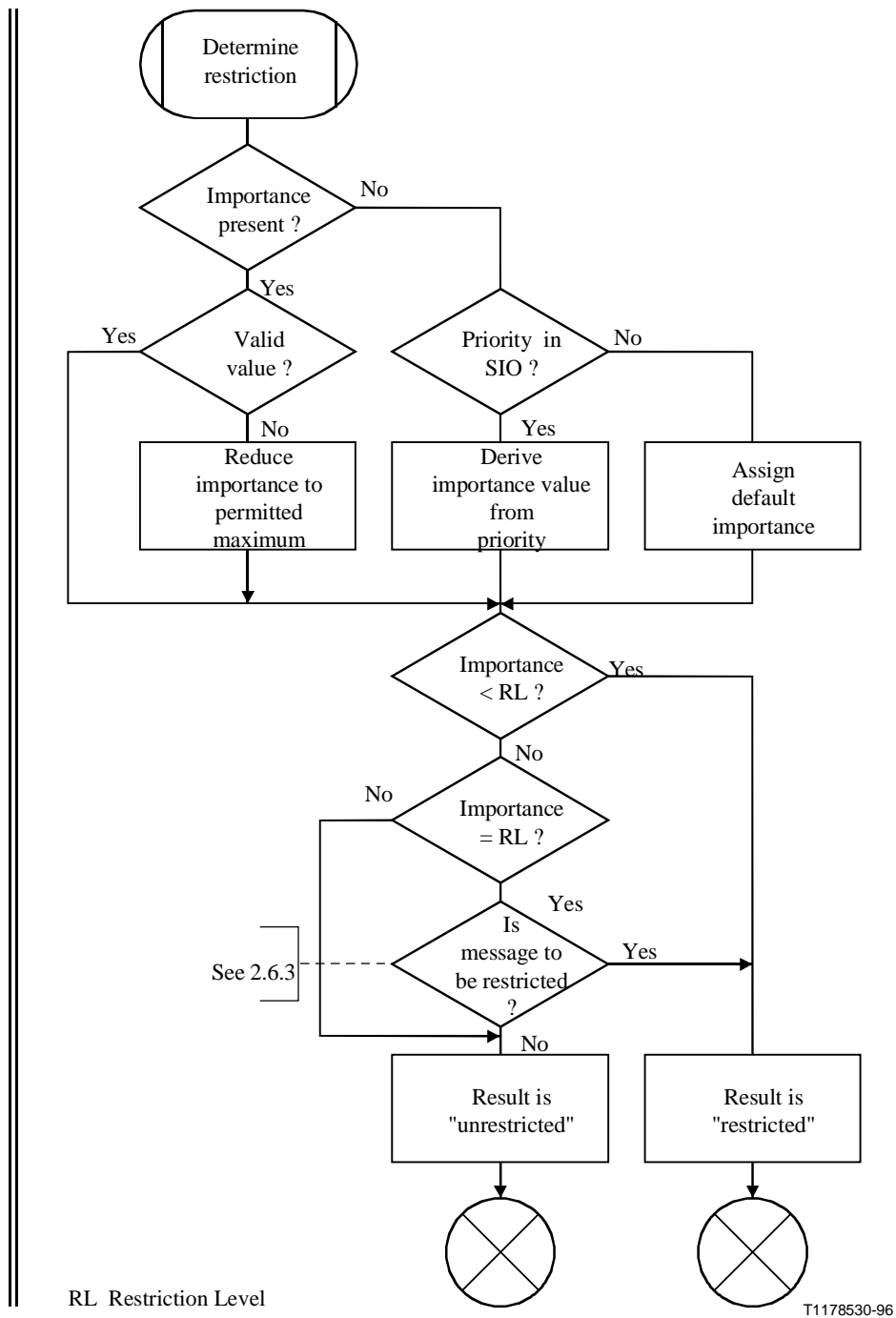


Figure C.1/Q.714 (sheet 11 of 11) – SCCP routing control procedures (SCRC)

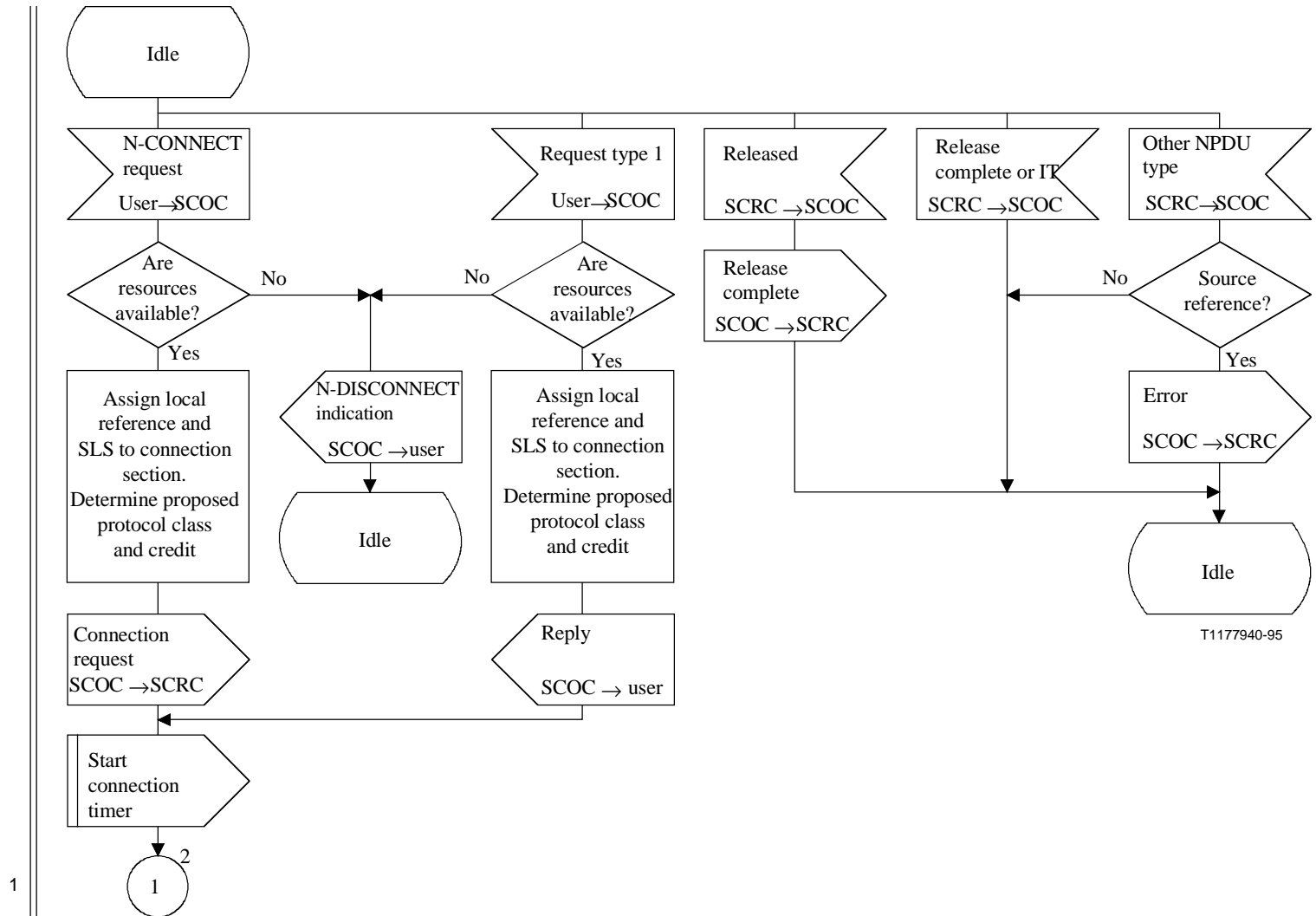
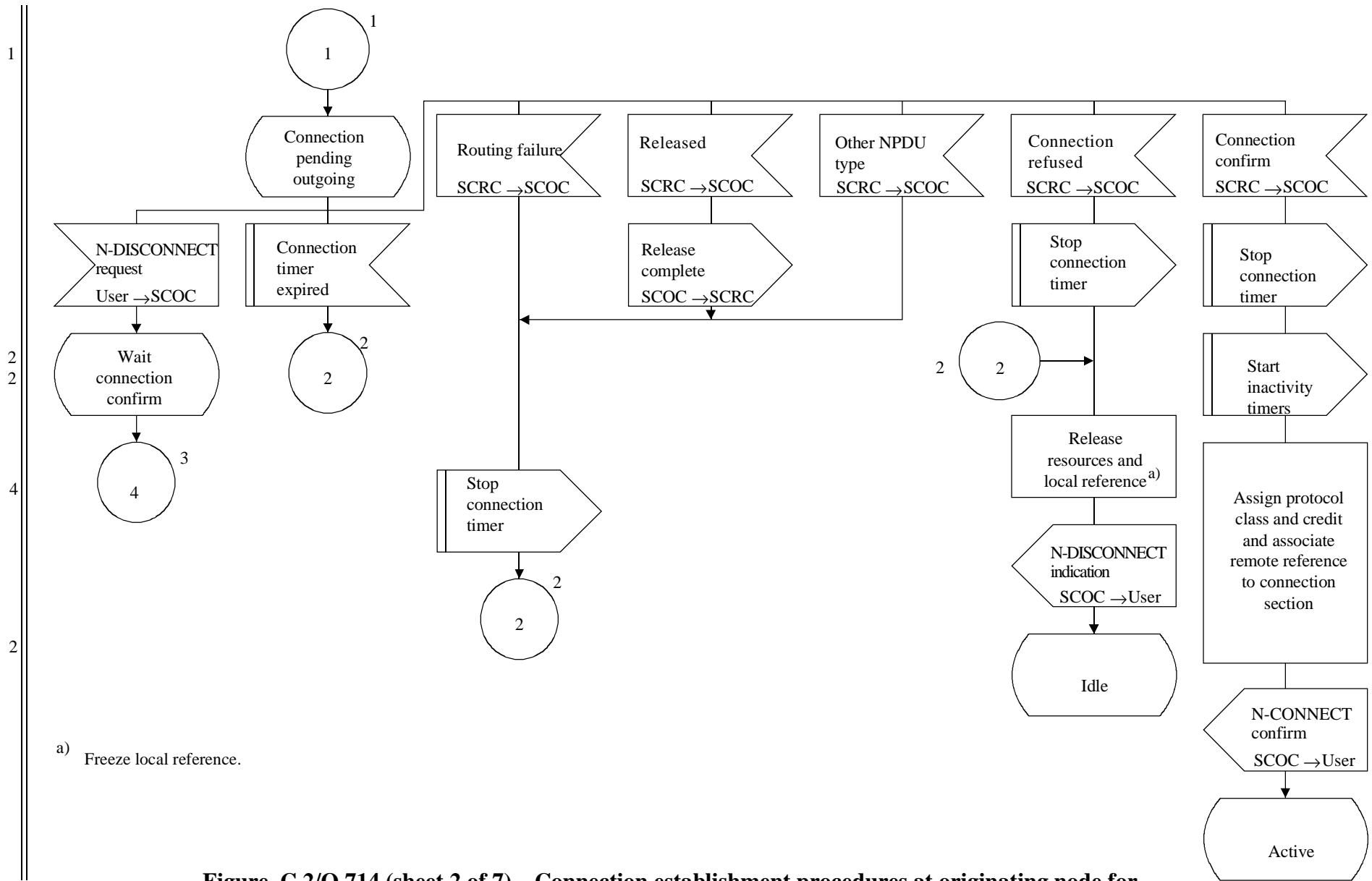
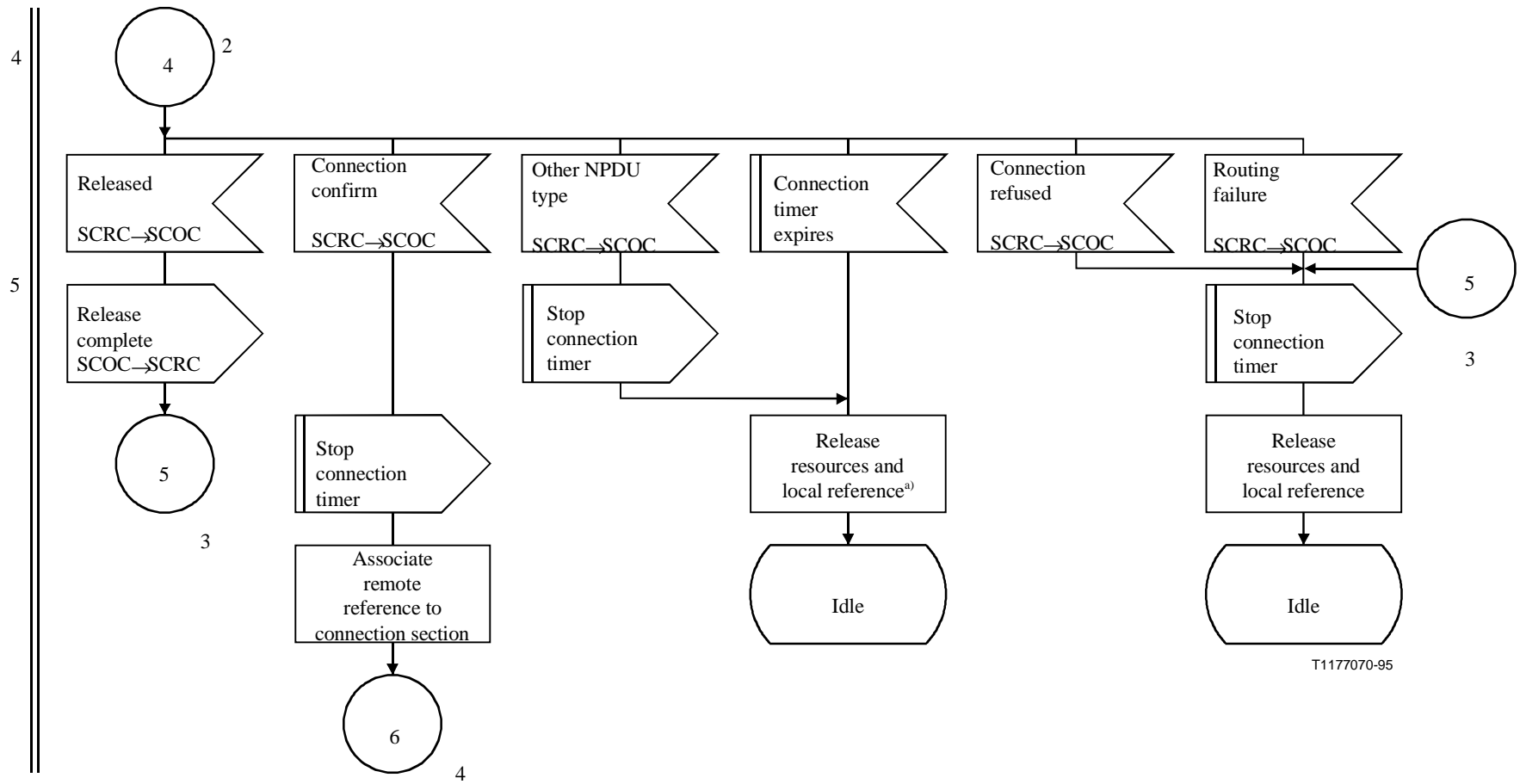


Figure C.2/Q.714 (sheet 1 of 7) – Connection establishment procedures at originating node for SCCP Connection-Oriented Control (SCOC)



T1178540-96

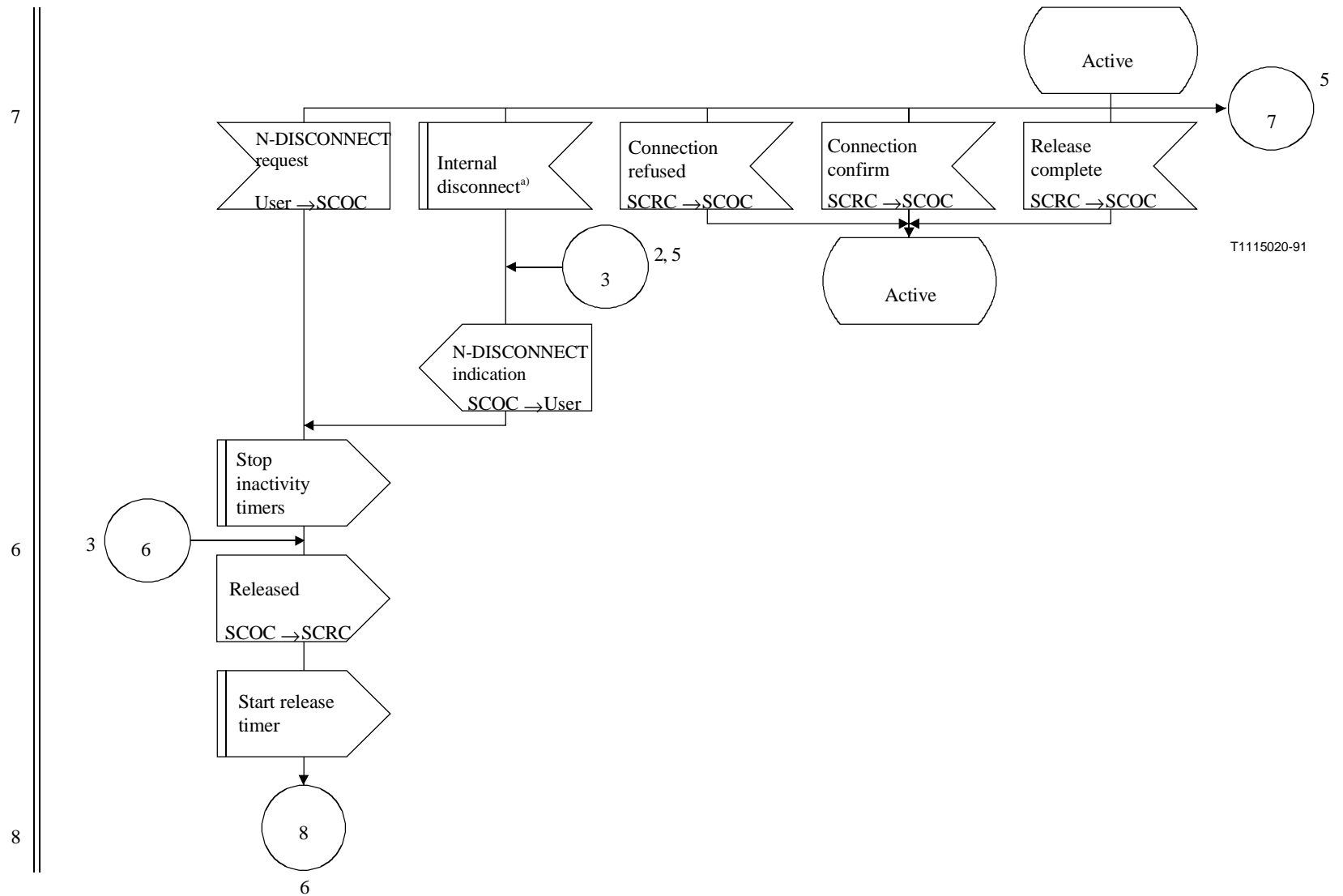
Figure C.2/Q.714 (sheet 2 of 7) – Connection establishment procedures at originating node for SCCP Connection-Oriented Control (SCOC)



<sup>a)</sup> Freeze local reference.

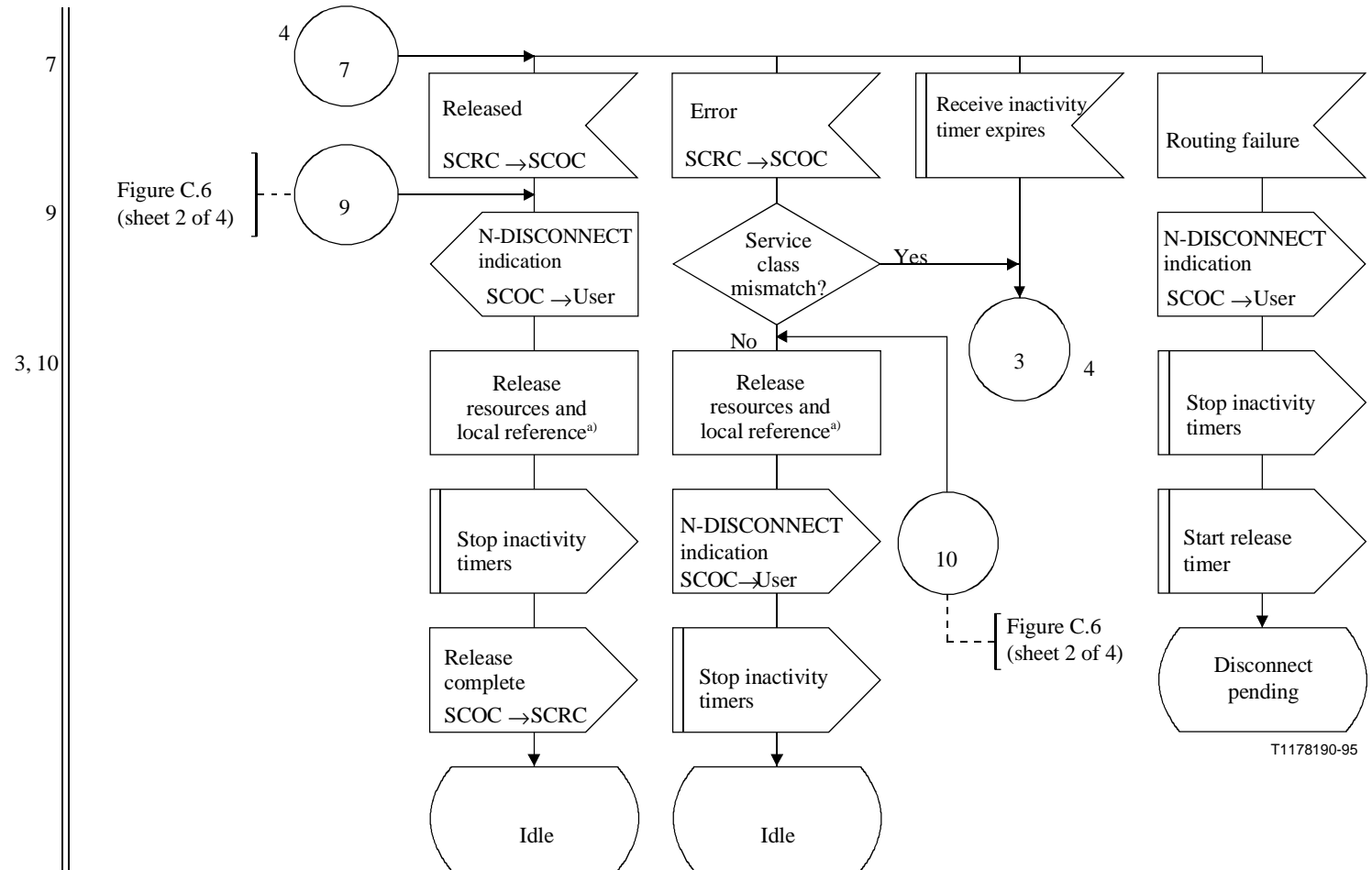
**Figure C.2/Q.714 (sheet 3 of 7) – Connection establishment procedures at originating node for SCCP Connection-Oriented Control (SCOC)**





<sup>a)</sup> To cater for abnormal disconnect conditions (i.e. Table B.34).

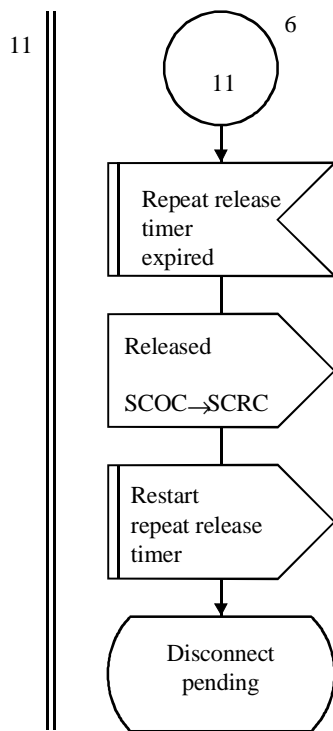
**Figure C.2/Q.714 (sheet 4 of 7) – Connection release procedures at originating node for SCCP Connection-Oriented Control (SCOC)**



<sup>a)</sup> Freeze local reference.

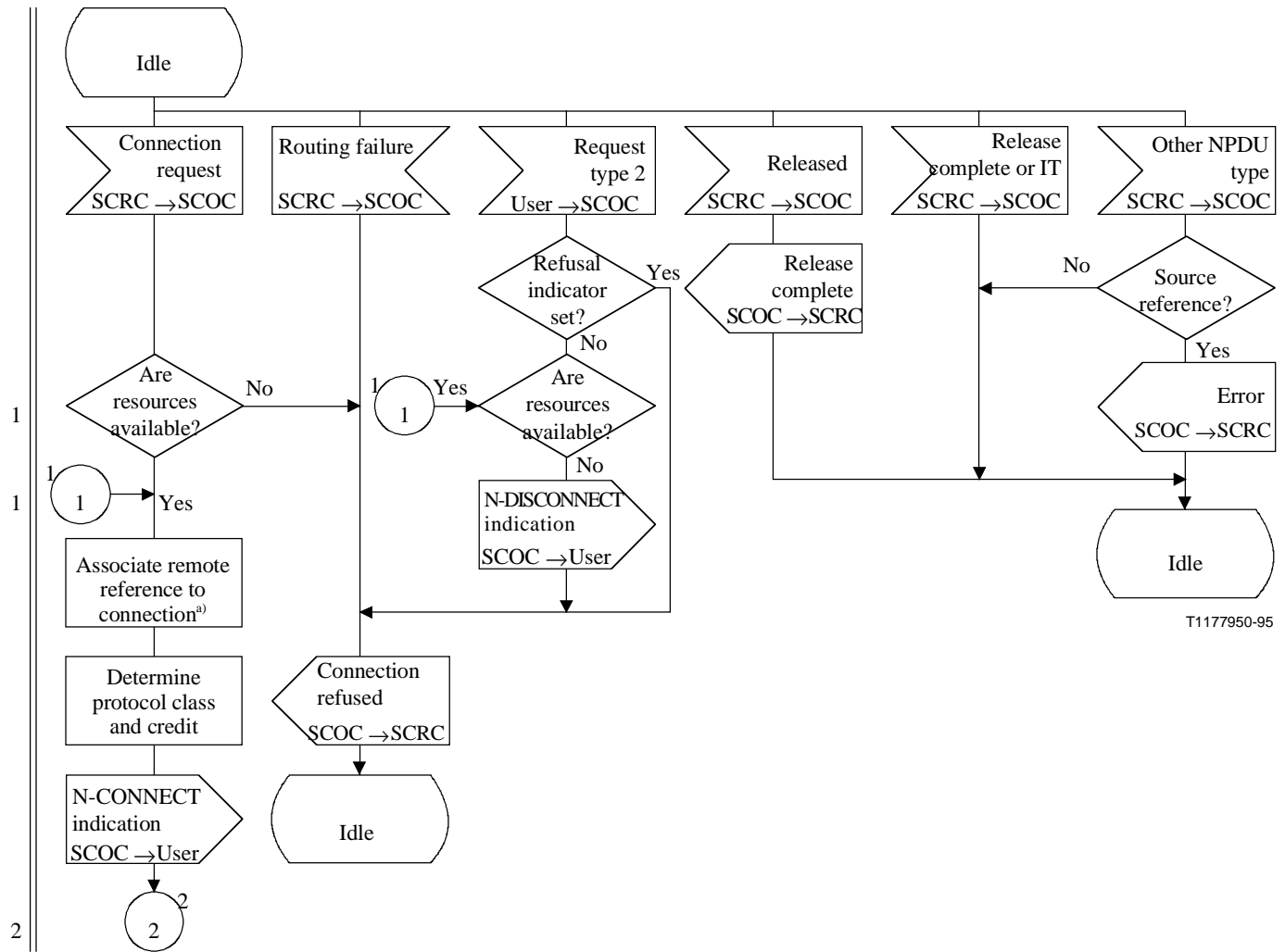
**Figure C.2/Q.714 (sheet 5 of 7) – Connection release procedures at originating node for SCCP Connection-Oriented Control (SCOC)**





T1177080-95

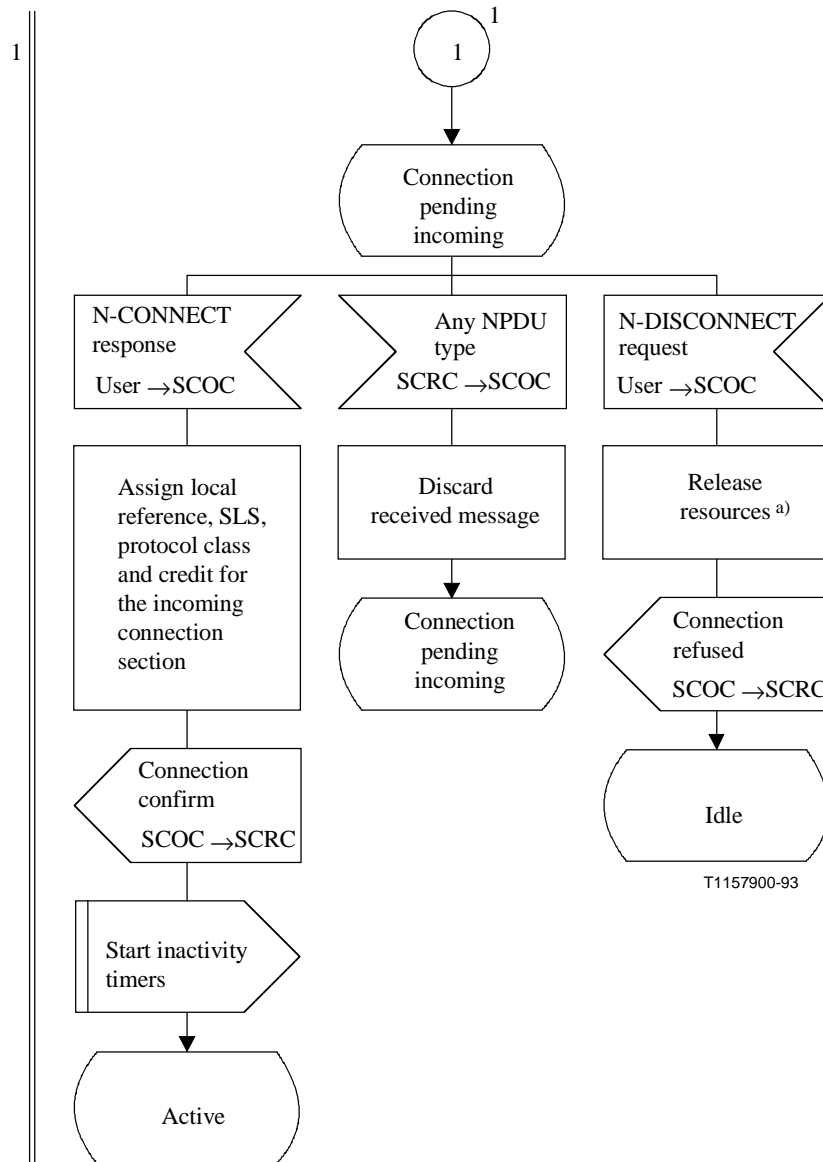
**Figure C.2/Q.714 (sheet 7 of 7) – Connection establishment procedures at originating node for SCCP Connection-Oriented Control (SCOC)**



T1177950-95

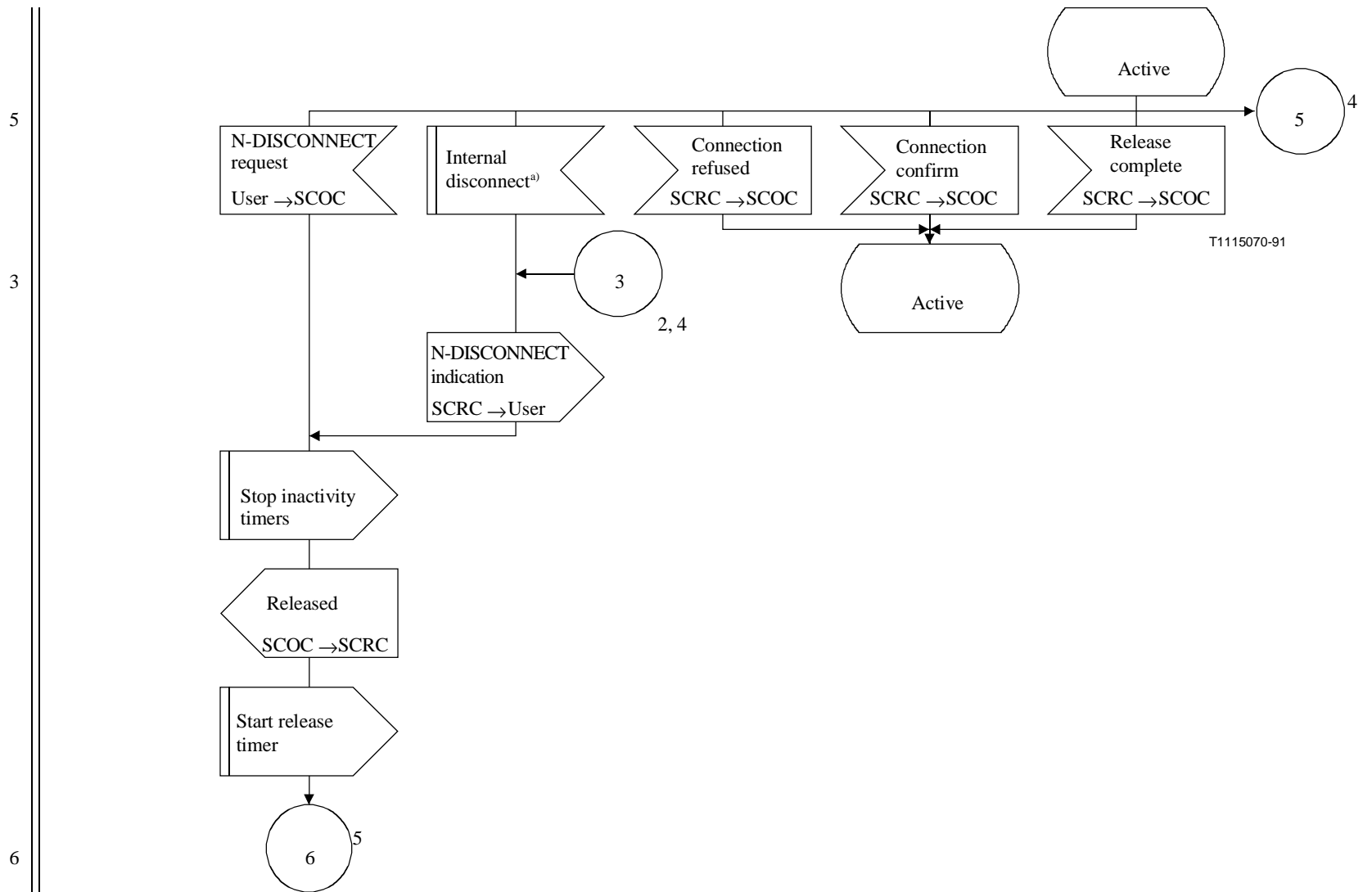
<sup>a)</sup> The assignment of the local reference can be done at this point or as shown in Figure C.3 (sheet 2 of 6): this is implementation dependent.

Figure C.3/Q.714 (sheet 1 of 6) – Connection establishment procedures at destination node for SCCP Connection-Oriented Control (SCOC)



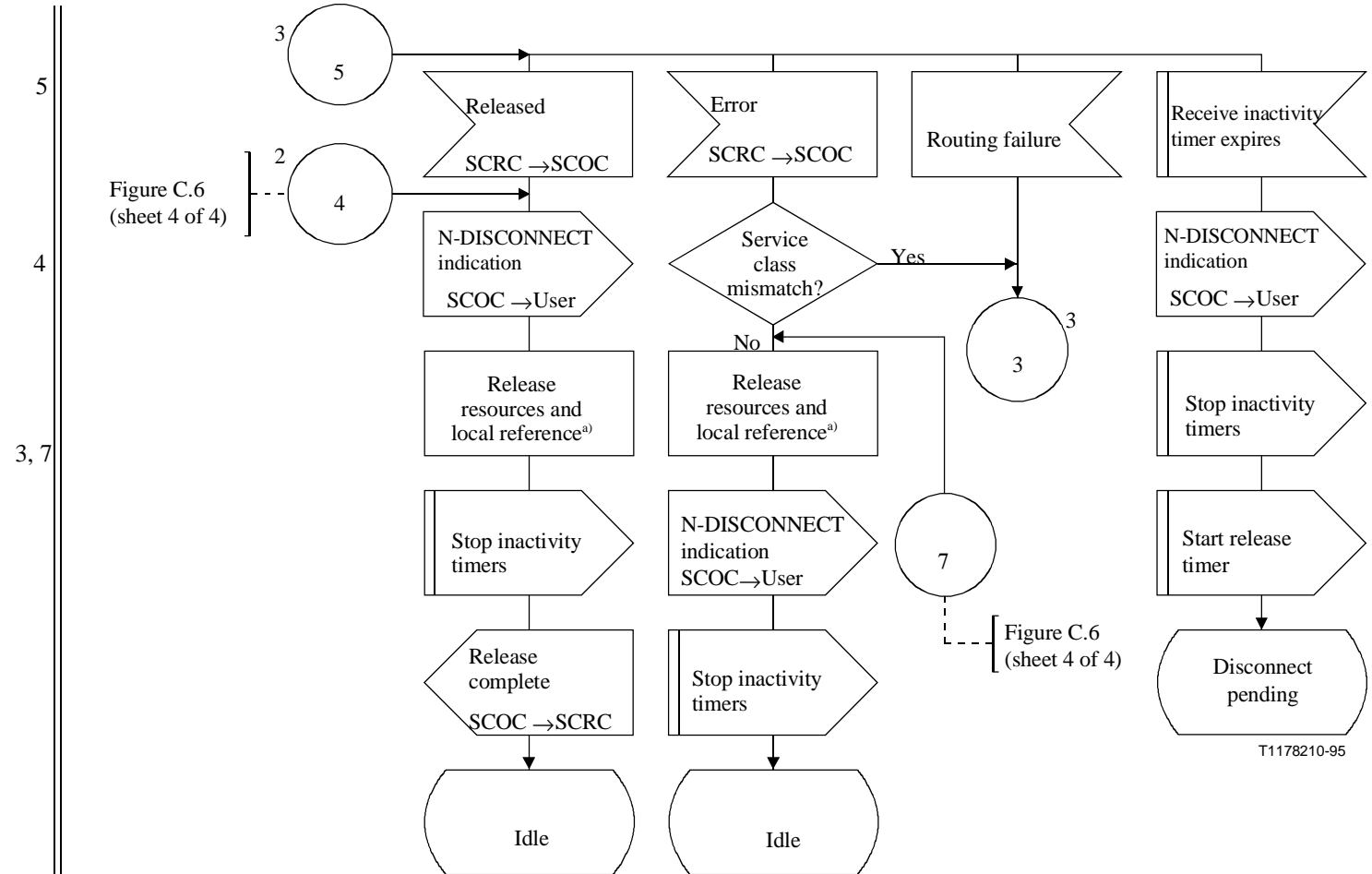
a) The local reference may have to be released and frozen if it has been previously assigned.

**Figure C.3/Q.714 (sheet 2 of 6) – Connection establishment procedures at destination node for SCCP Connection-Oriented Control (SCOC)**



<sup>a)</sup> To cater for abnormal disconnect conditions (i.e. Table B.3).

**Figure C.3/Q.714 (sheet 3 of 6) – Connection release procedures at destination node for SCCP Connection-Oriented Control (SCOC)**



<sup>a)</sup> Freeze local reference.

**Figure C.3/Q.714 (sheet 4 of 6) – Connection release procedures at destination node for SCCP Connection-Oriented Control (SCOC)**



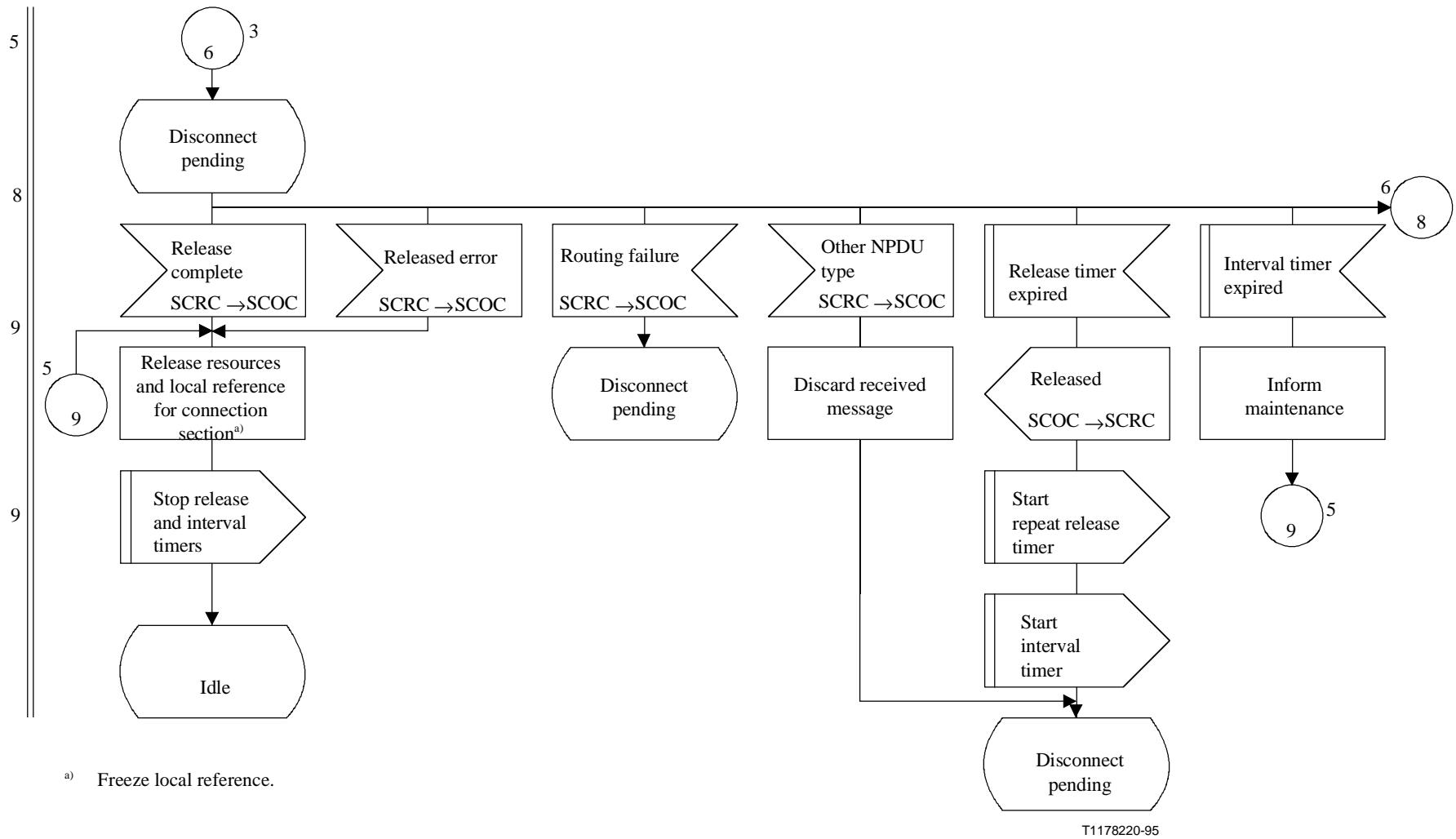
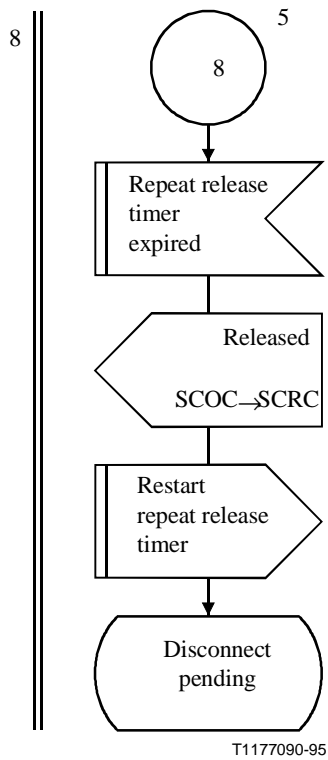
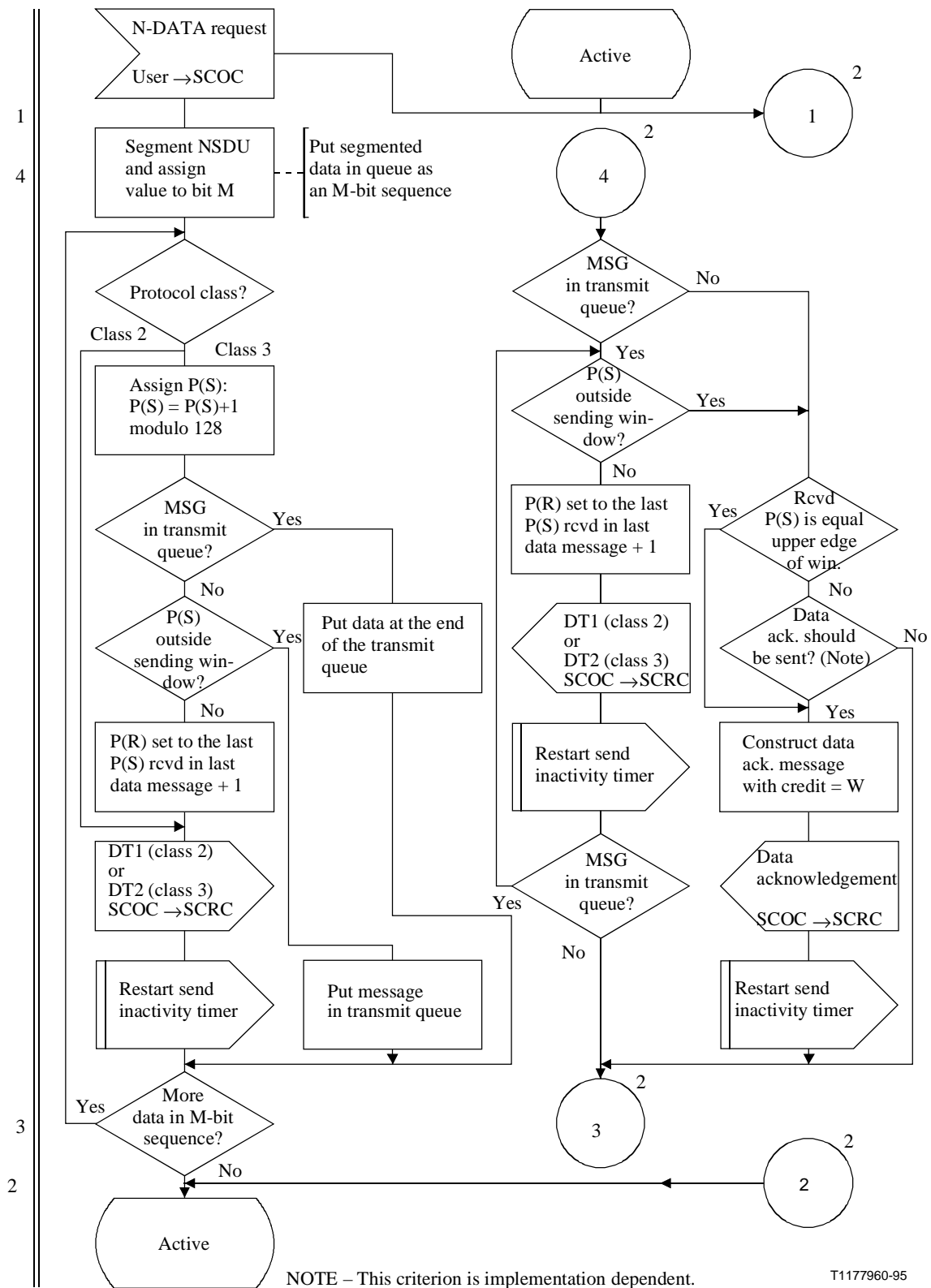


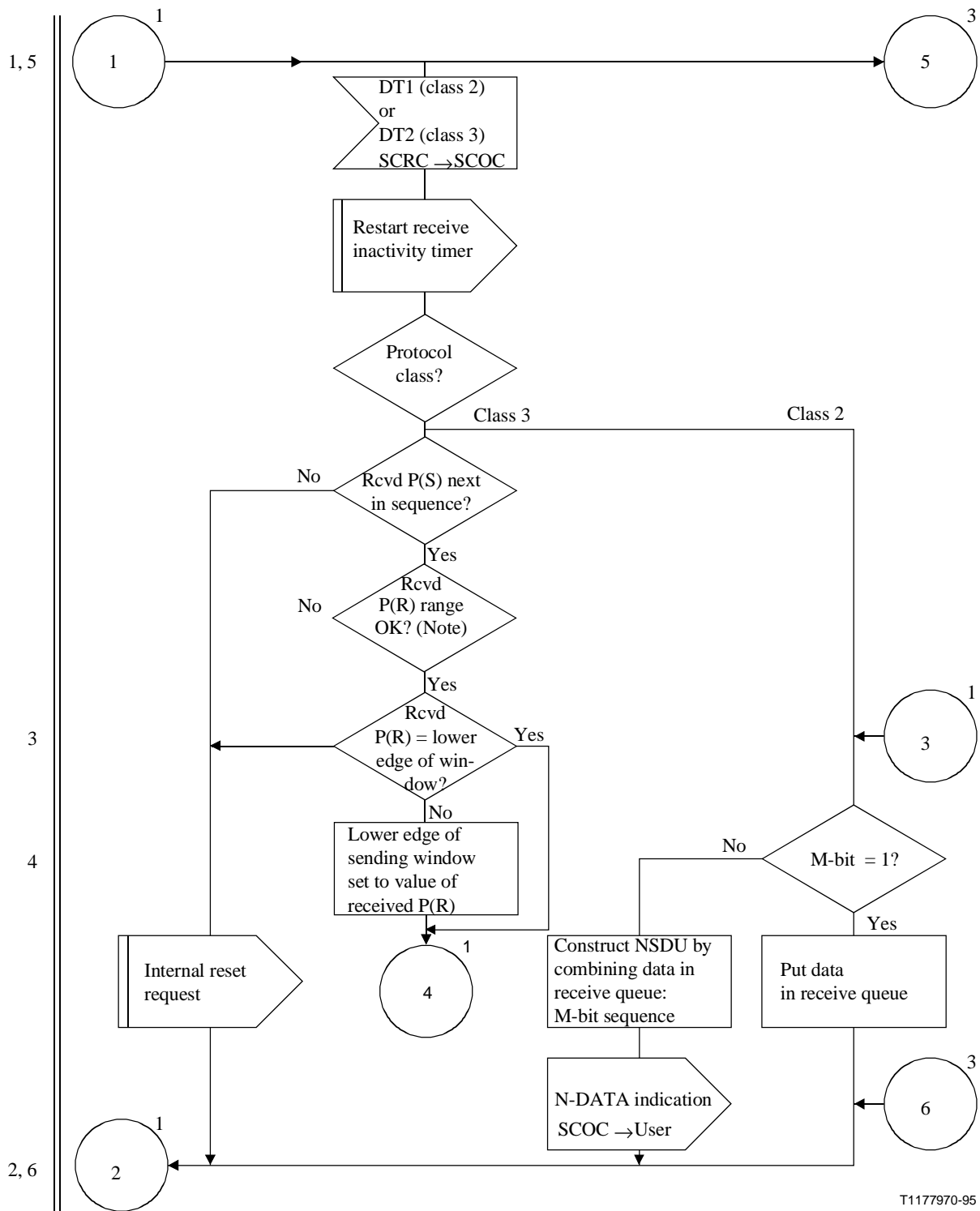
Figure C.3/Q.714 (sheet 5 of 6) – Connection release procedures at destination node for SCCP Connection-Oriented Control (SCOC)



**Figure C.3/Q.714 (sheet 6 of 6) – Connection release procedures at destination node for SCCP Connection-Oriented Control (SCOC)**



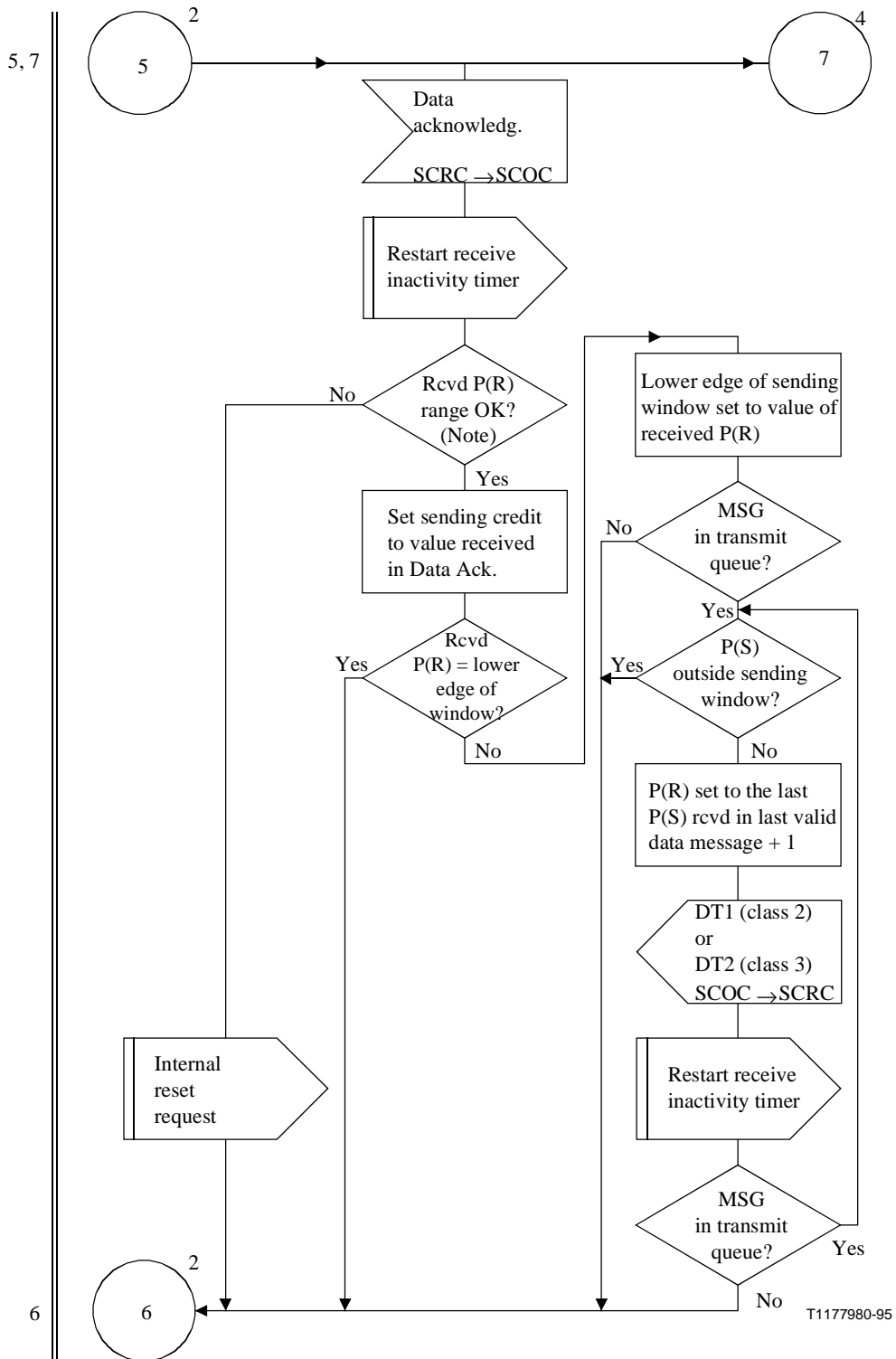
**Figure C.4/Q.714 (sheet 1 of 4) – Data transfer procedures at originating and destination nodes for SCCP Connection-Oriented Control (SCOC)**



NOTE – Value of P(R) received must be within the range from the last P(R) received up to including the send sequence number of next message to be transmitted.

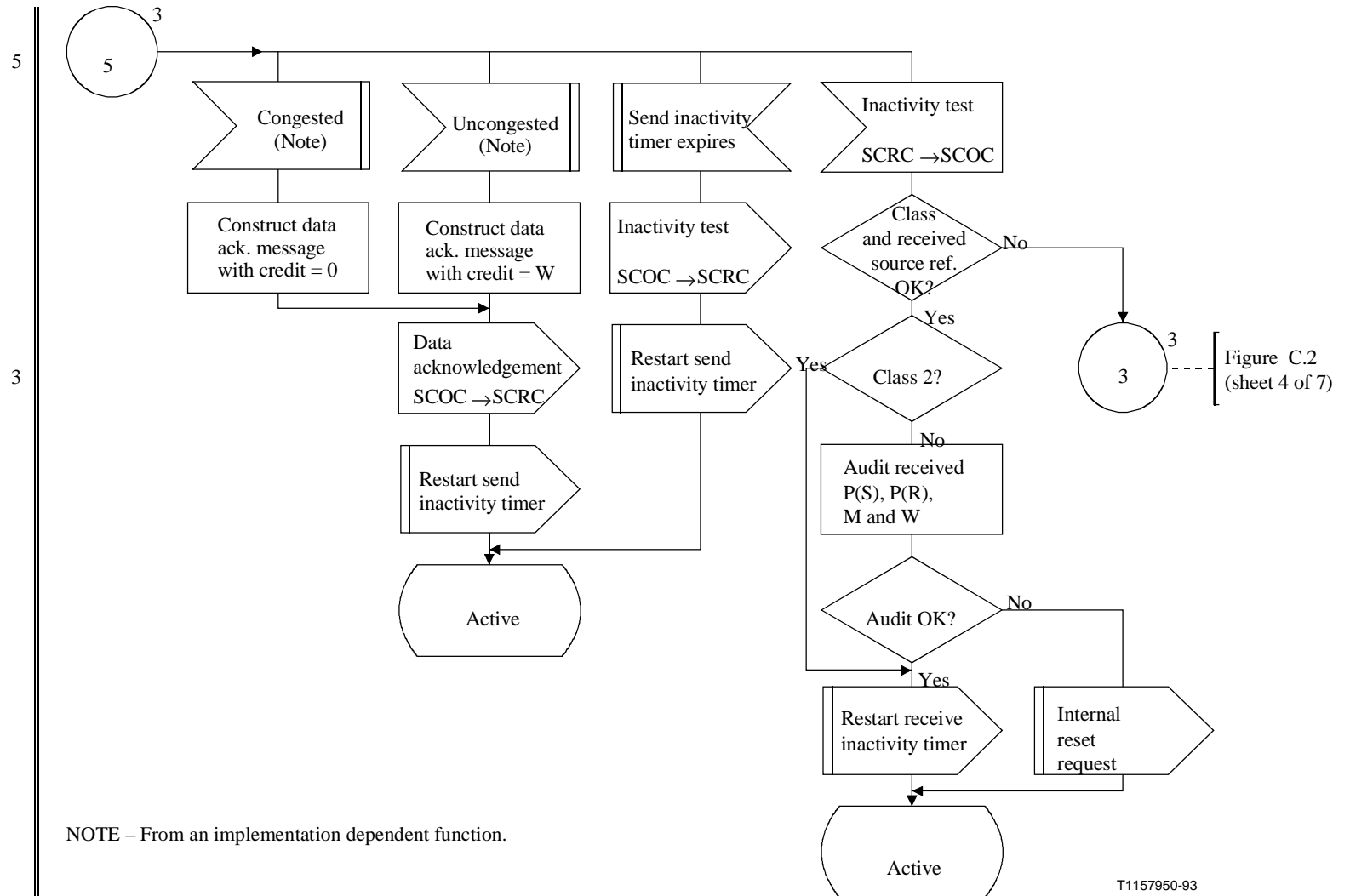
T1177970-95

**Figure C.4/Q.714 (sheet 2 of 4) – Data transfer procedures at originating and destination nodes for SCCP Connection-Oriented Control (SCOC)**



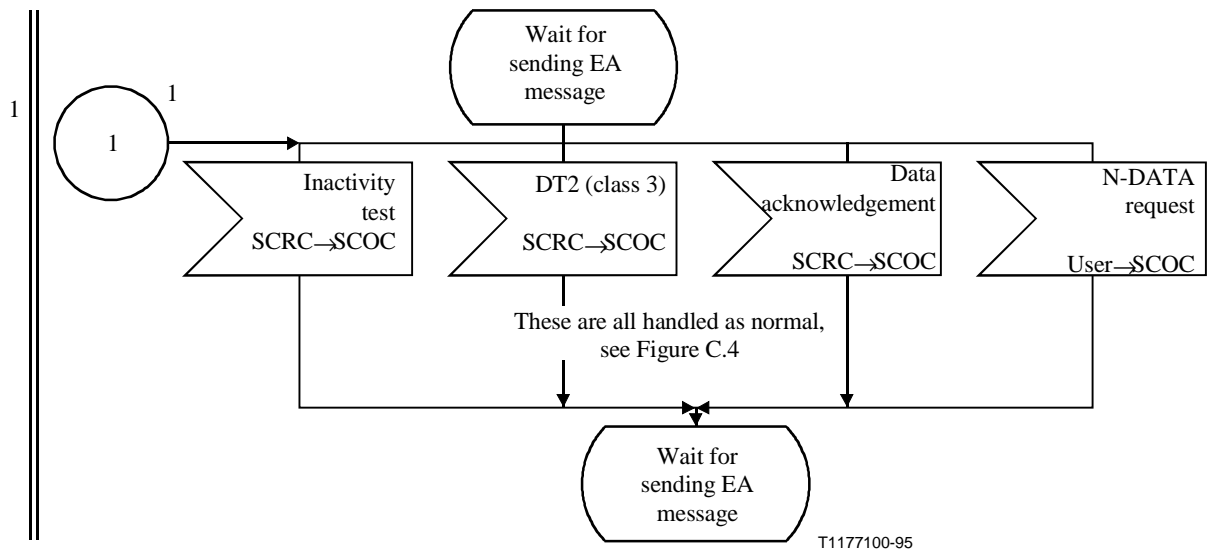
NOTE – Value of P(R) received must be within the range from the last P(R) received up to including the send sequence number of next message to be transmitted.

**Figure C.4/Q.714 (sheet 3 of 4) – Data transfer procedures at originating and destination nodes for SCCP Connection-Oriented Control (SCOC)**



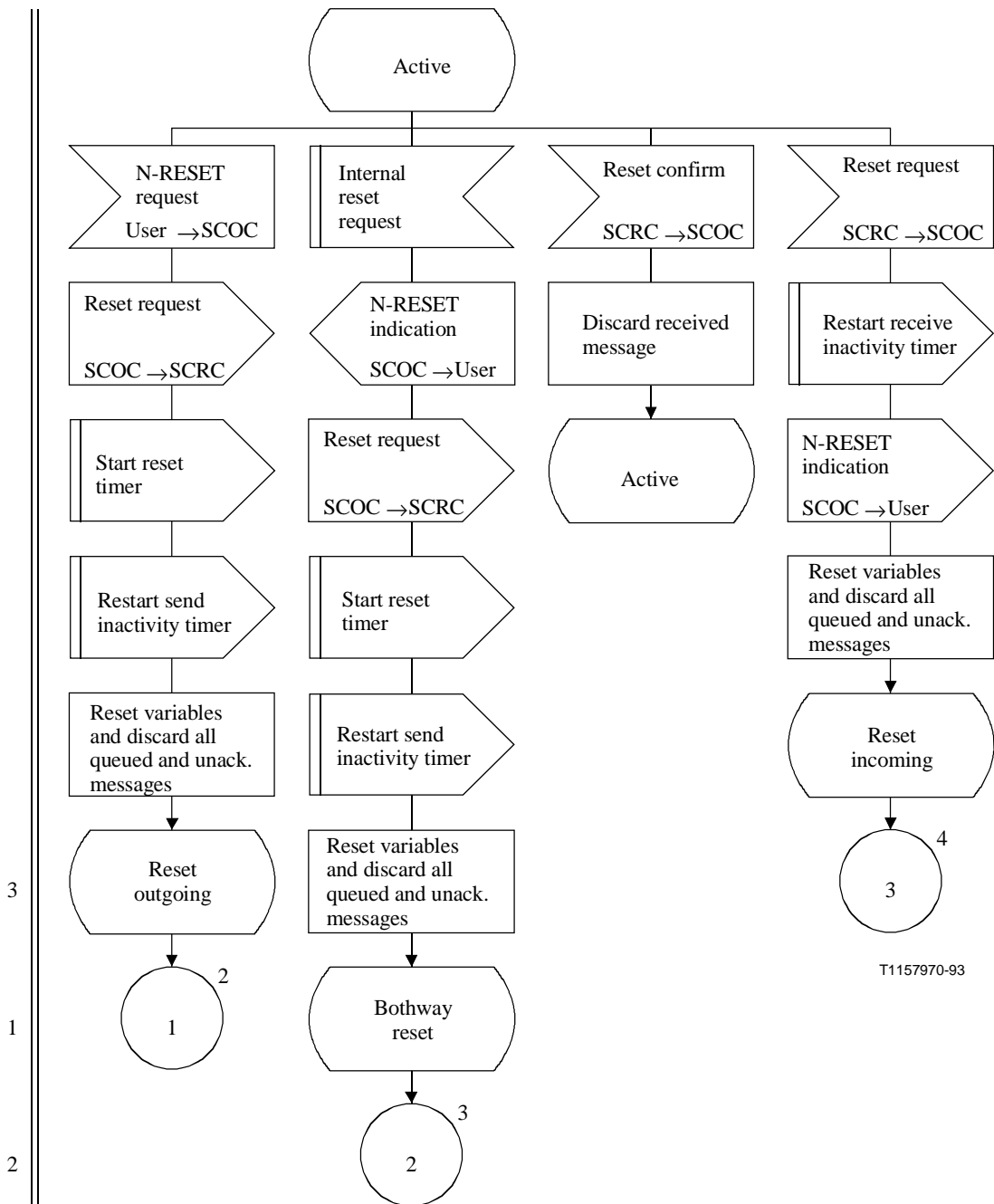
**Figure C.4/Q.714 (sheet 4 of 4) – Data transfer procedures at originating and destination nodes for SCCP Connection-Oriented Control (SCOC)**



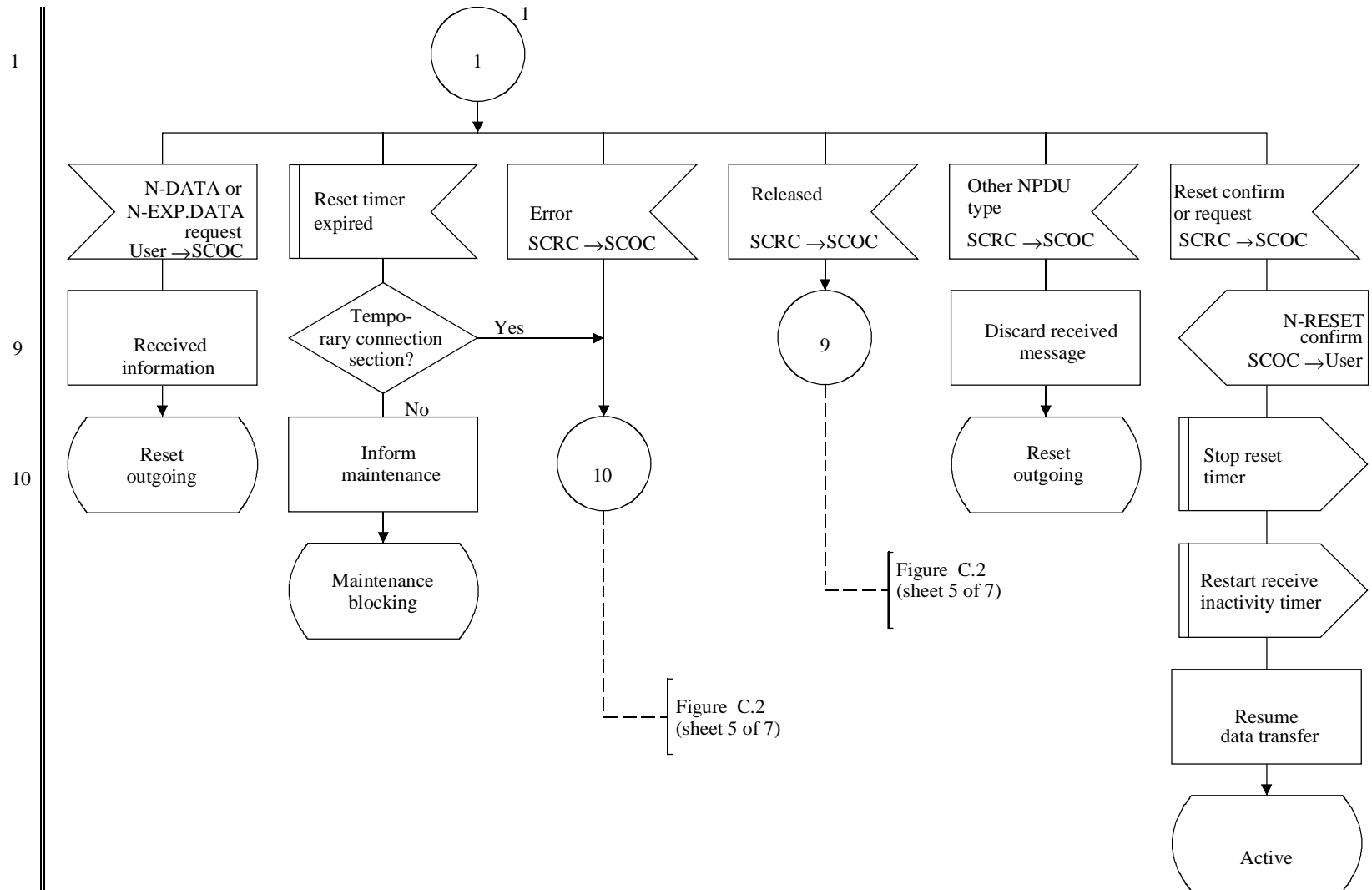


**Figure C.5/Q.714 (sheet 2 of 2) – Expedited data transfer procedures at originating and destination node for SCCP Connection-Oriented Control (SCOC)**





**Figure C.6 (sheet 1 of 4) – Reset procedures at originating and destination node for SCCP Connection-Oriented Control (SCOC)**



T1178550-96

Figure C.6/Q.714 (sheet 2 of 4) – Reset procedures at originating and destination node for SCCP Connection-Oriented Control (SCOC)

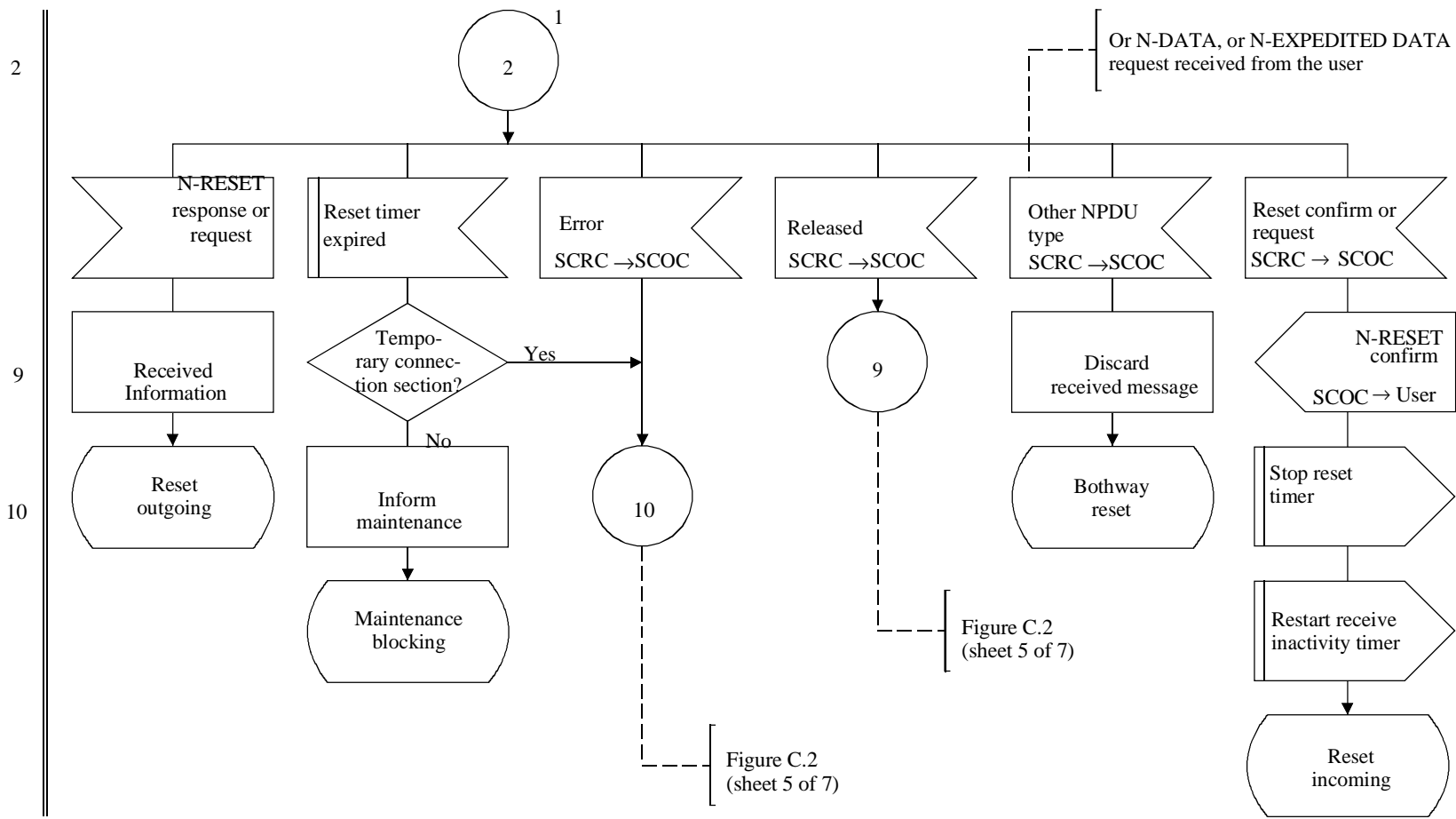
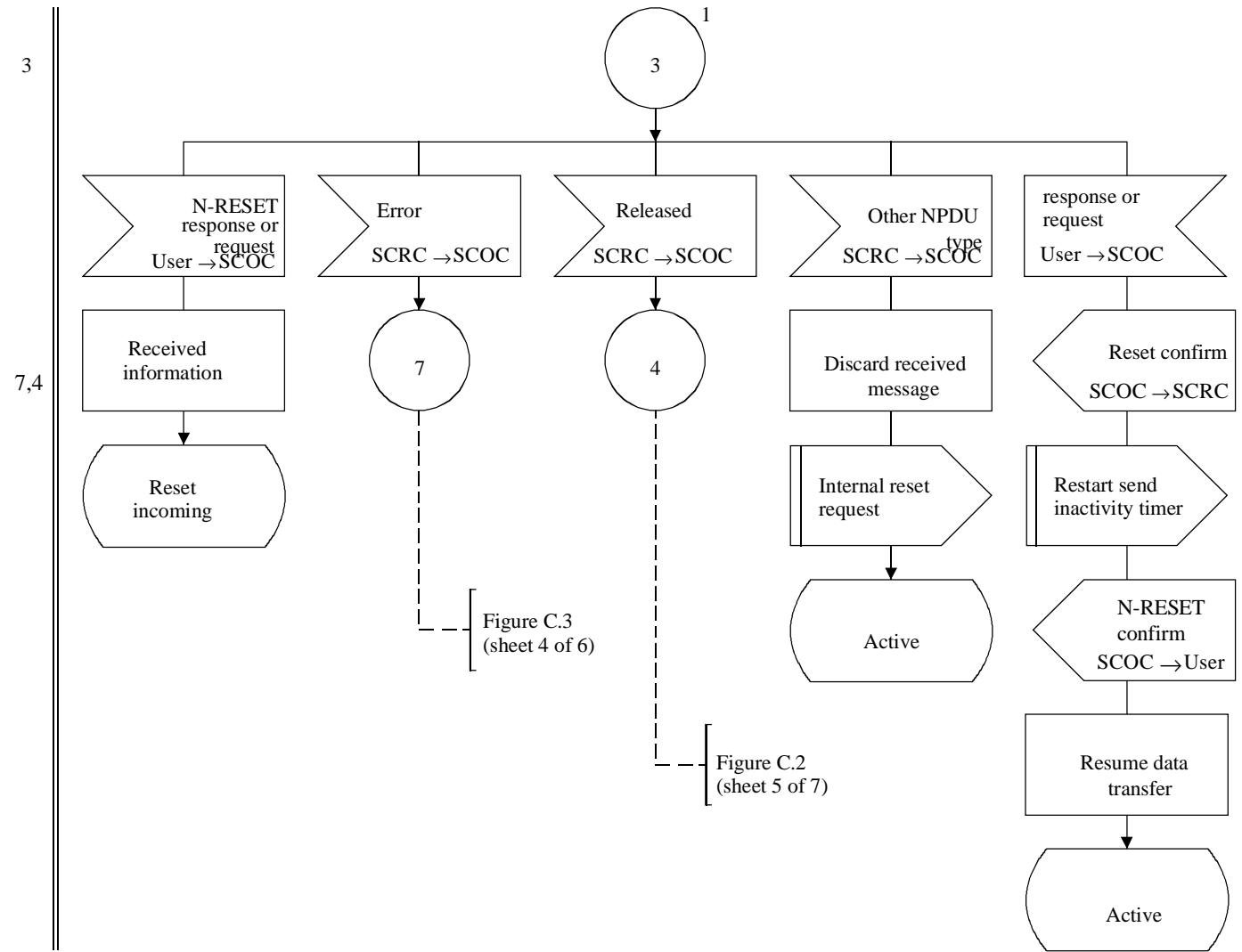


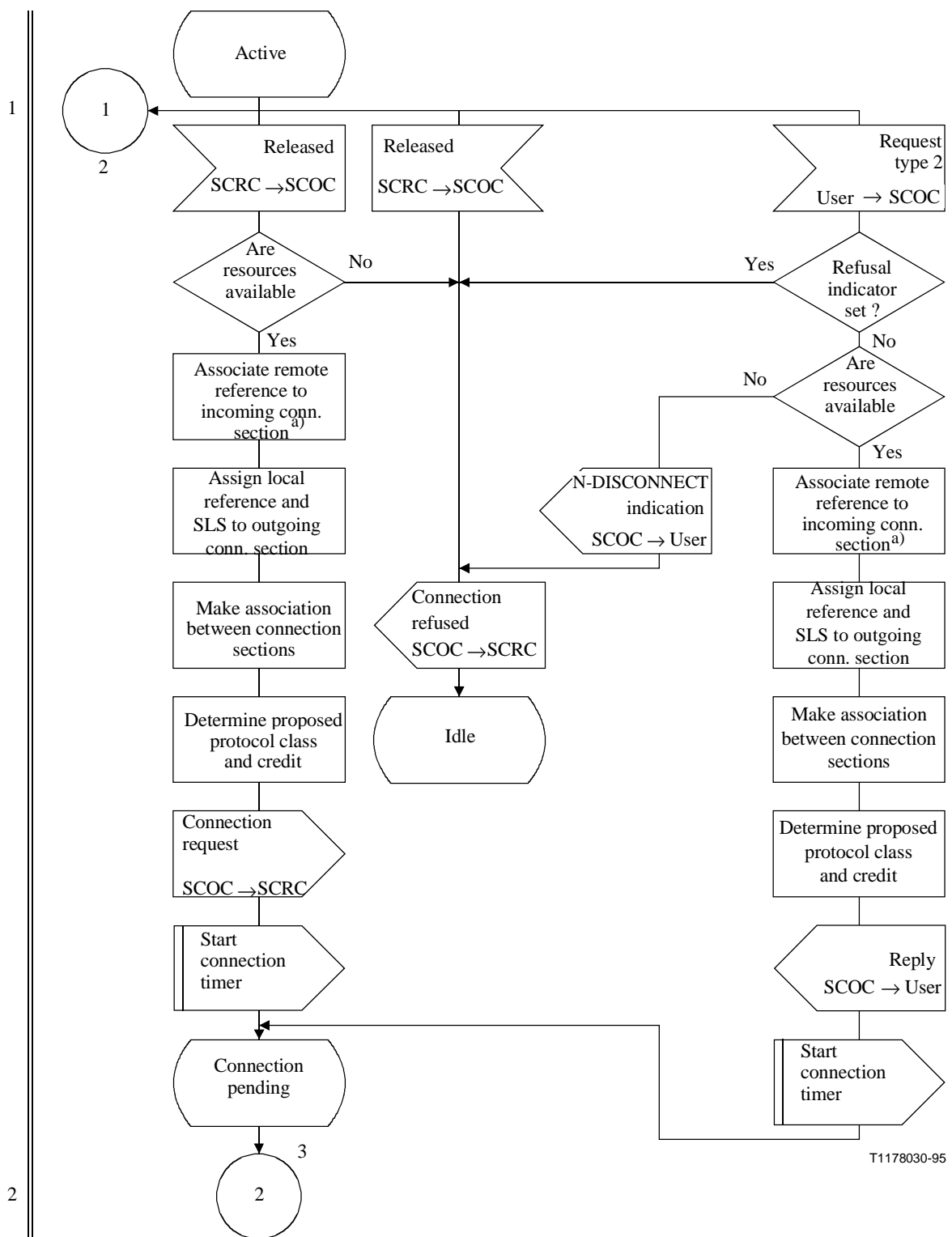
Figure C.6/Q.714 (sheet 3 of 4) – Reset procedures at originating and destination node for SCCP Connection-Oriented Control (SCOC)

T1178560-96



T1178570-96

Figure C.6/Q.714 (sheet 4 of 4) – Reset procedures at originating and destination node for SCCP Connection-Oriented Control (SCOC)



a) The assignment of the local reference can be done at this point or as shown in Figure C.7 (sheet 3 of 9); this is implementation dependent.

**Figure C.7/Q.714 (sheet 1 of 9) – Connection establishment procedures at intermediate node with coupling for SCCP Connection-Oriented Control (SCOC)**

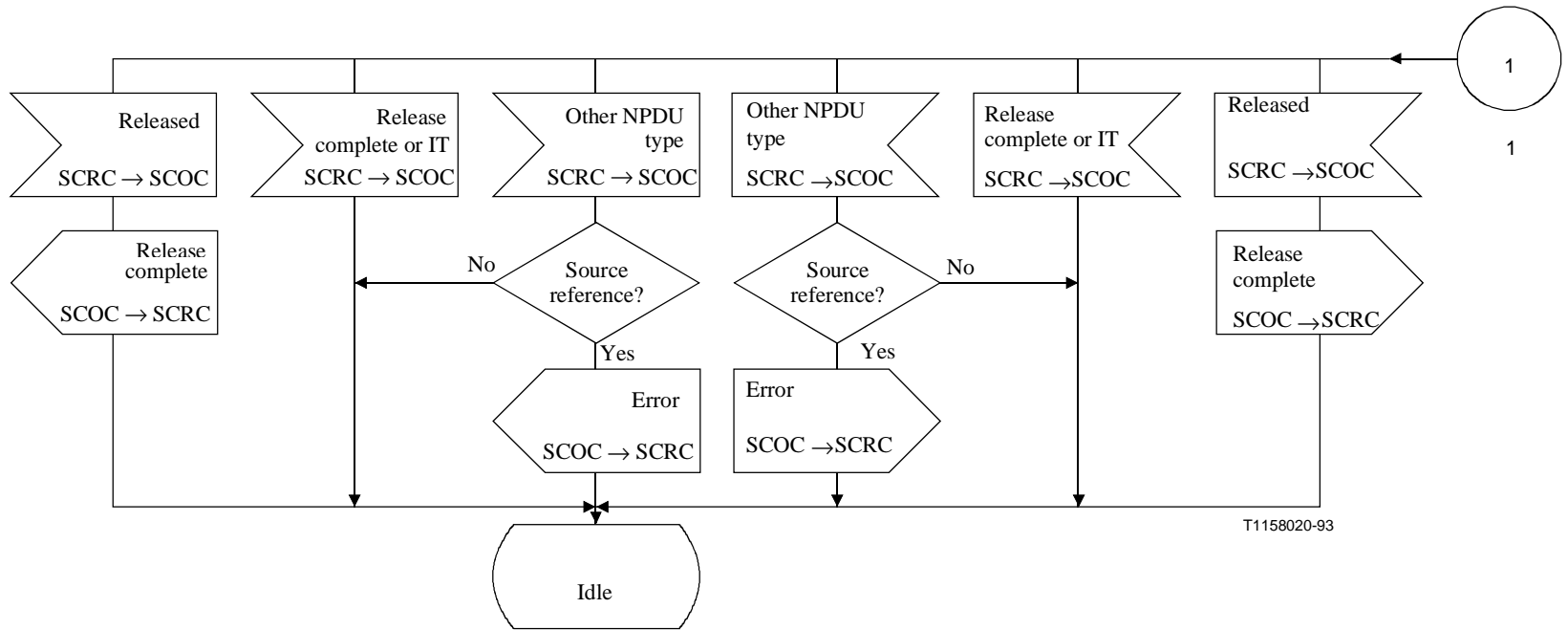
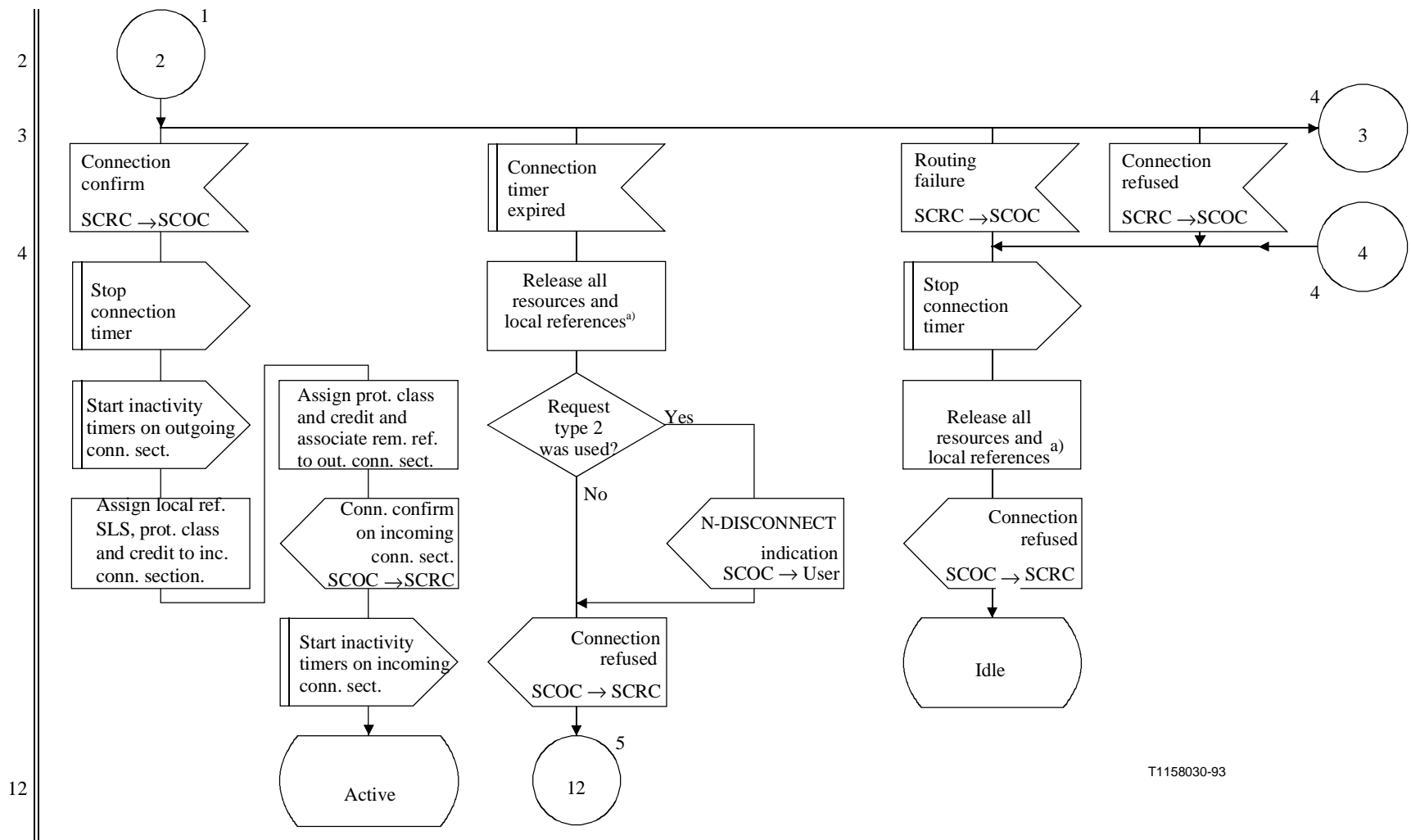


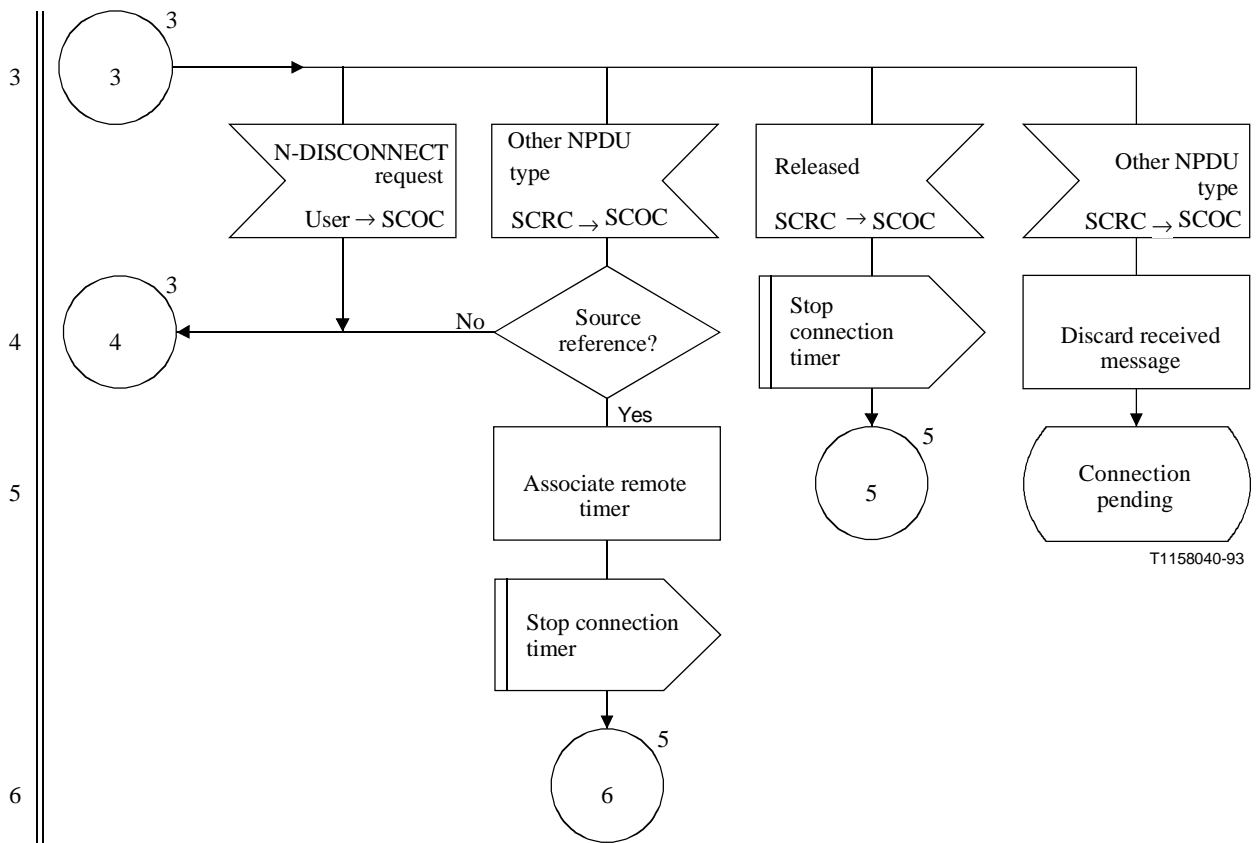
Figure C.7/Q.714 (sheet 2 of 9) – Connection establishment procedures at intermediate node with coupling for SCCP Connection-Oriented Control (SCOC)



T1158030-93

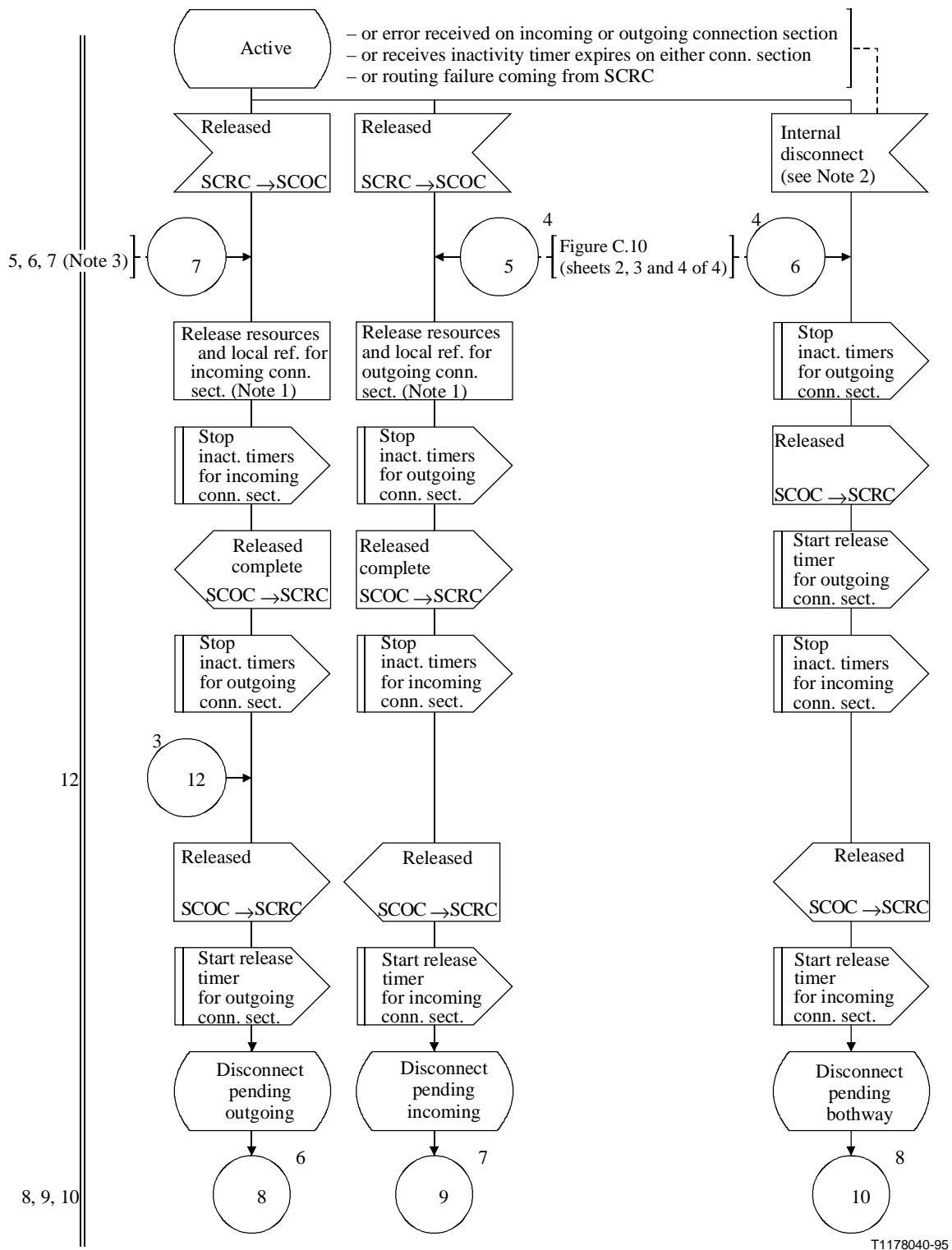
a) Freeze local references.

**Figure C.7/Q.714 (sheet 3 of 9) – Connection establishment procedures at intermediate node with coupling for SCCP Connection-Oriented Control (SCOC)**



**Figure C.7/Q.714/(sheet 4 of 9) – Connection establishment procedures at intermediate node with coupling for SCCP Connection-Oriented Control (SCOC)**



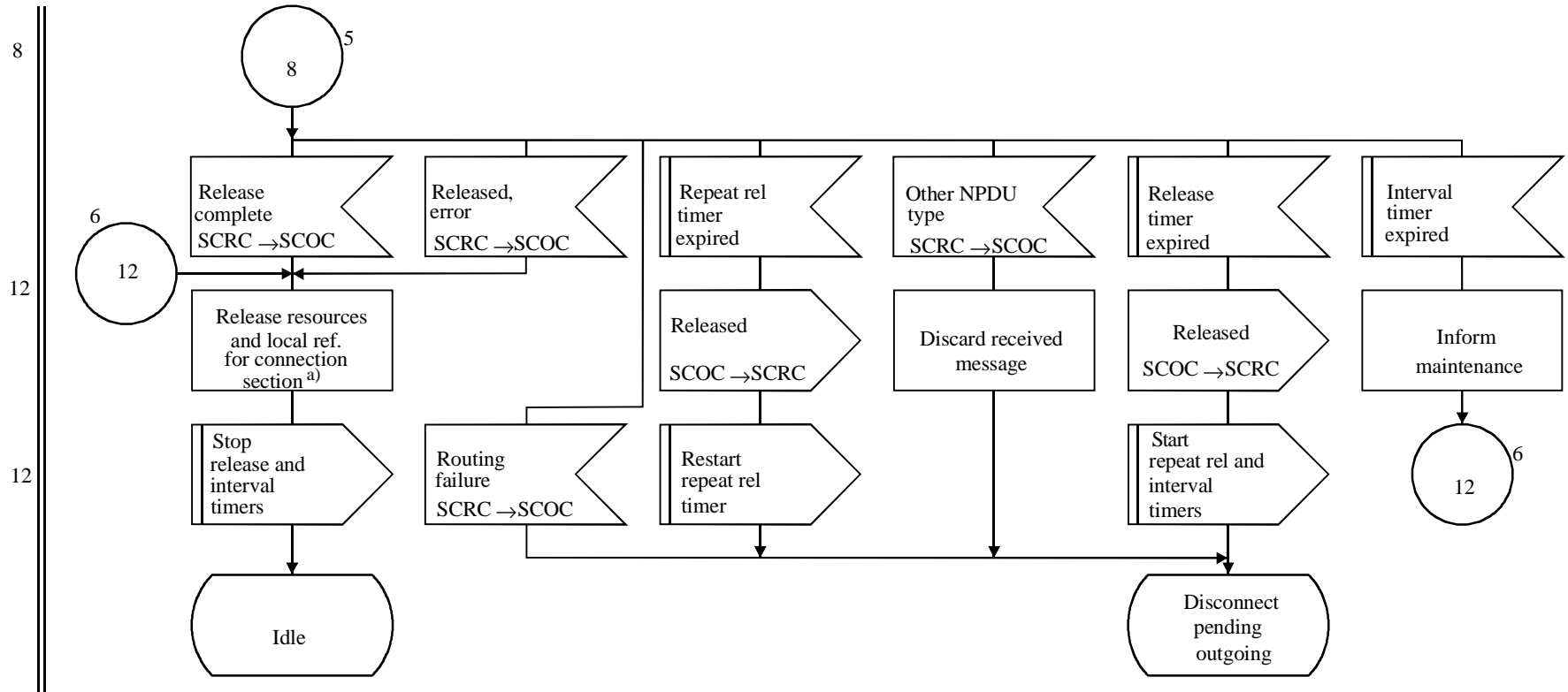


NOTE 1 – Freeze local references.

NOTE 2 – To cater for abnormal disconnect conditions (i.e. Table B.3).

NOTE 3 – Figure C.10 (sheets 2, 3 and 4 of 4).

**Figure C.7/Q.714 (sheet 5 of 9) – Connection release procedures at intermediate node with coupling for SCCP Connection-Oriented Control (SCOC)**

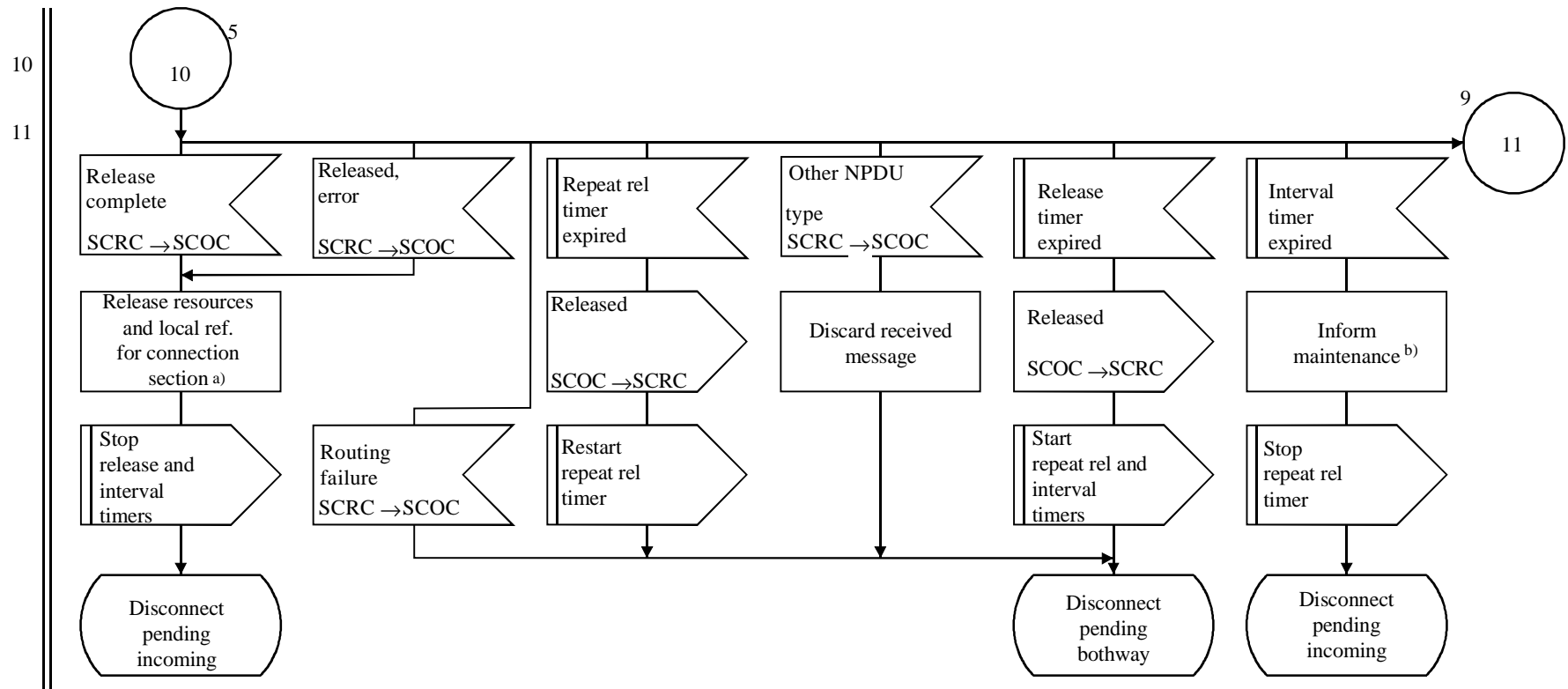


T1177110-95

<sup>a)</sup> Freeze local reference.

**Figure C.7/Q.714 (sheet 6 of 9) – Connection release procedures at intermediate node with coupling for SCCP Connection-Oriented Control (SCOC)**

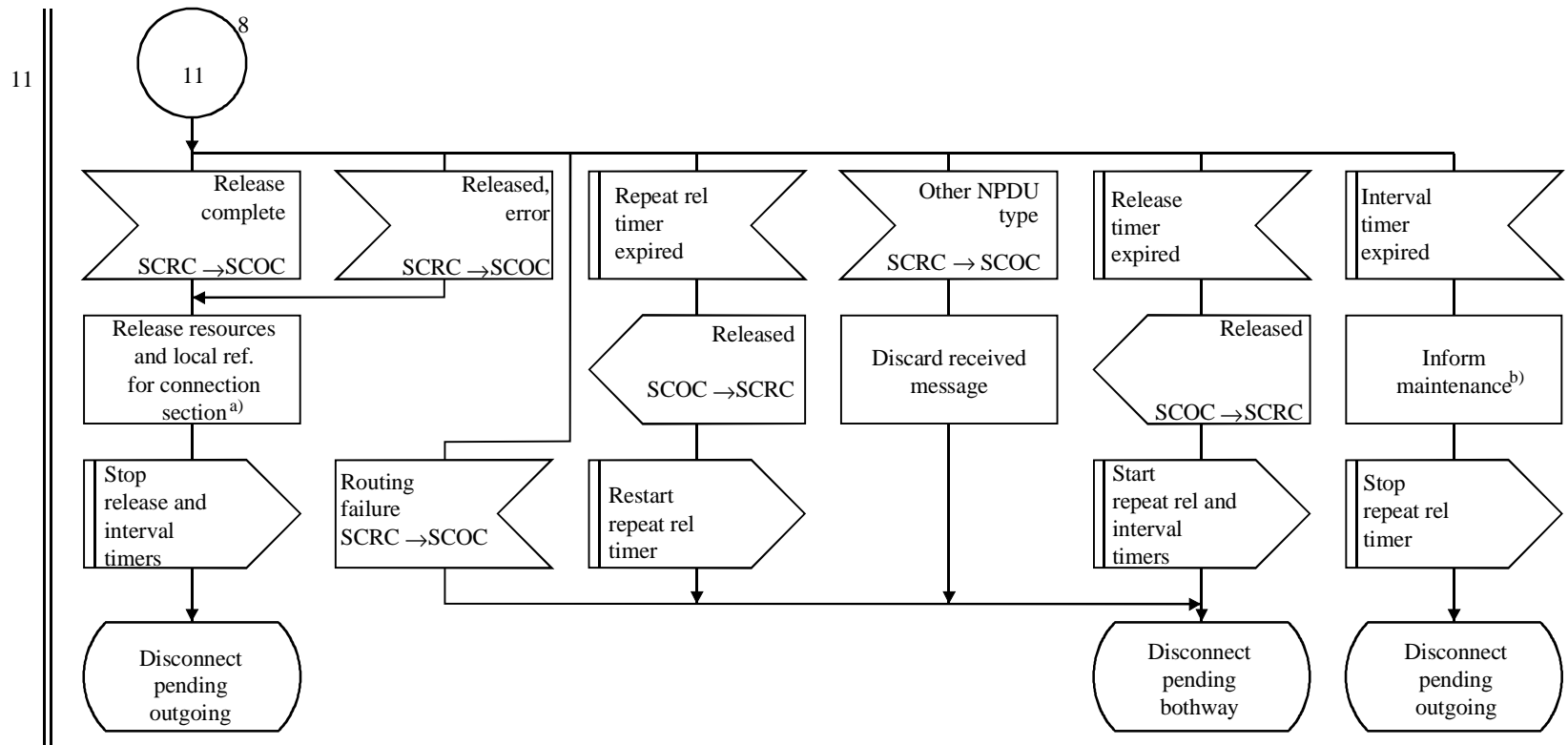




a) Freeze local reference.  
 b) Maintenance functions are for further study.

T1177130-95

**Figure C.7/Q.714 (sheet 8 of 9) – Connection release procedures at intermediate node with coupling for SCCP Connection-Oriented Control (SCOC)**

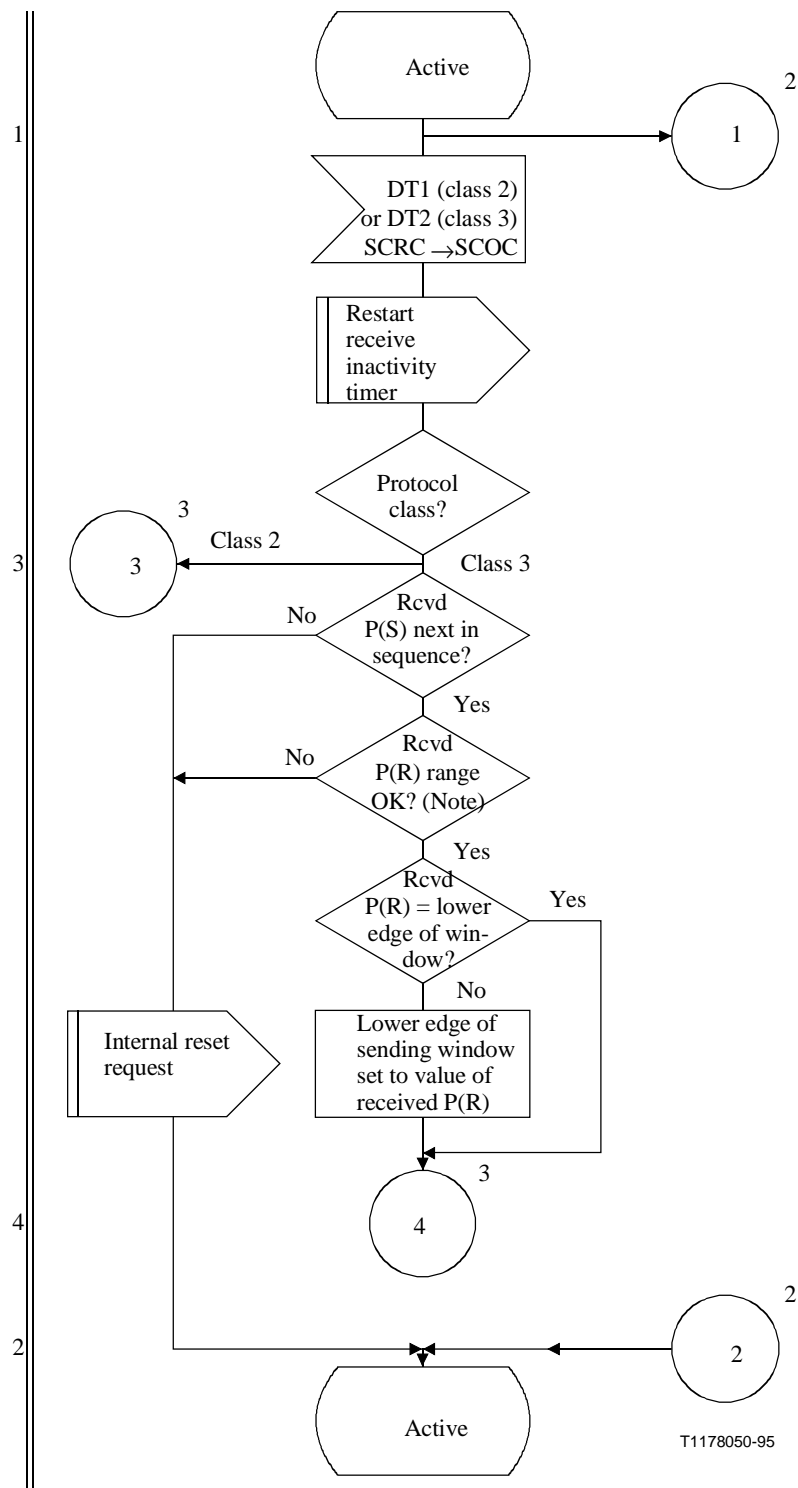


a) Freeze local reference.

b) Maintenance functions are for further study.

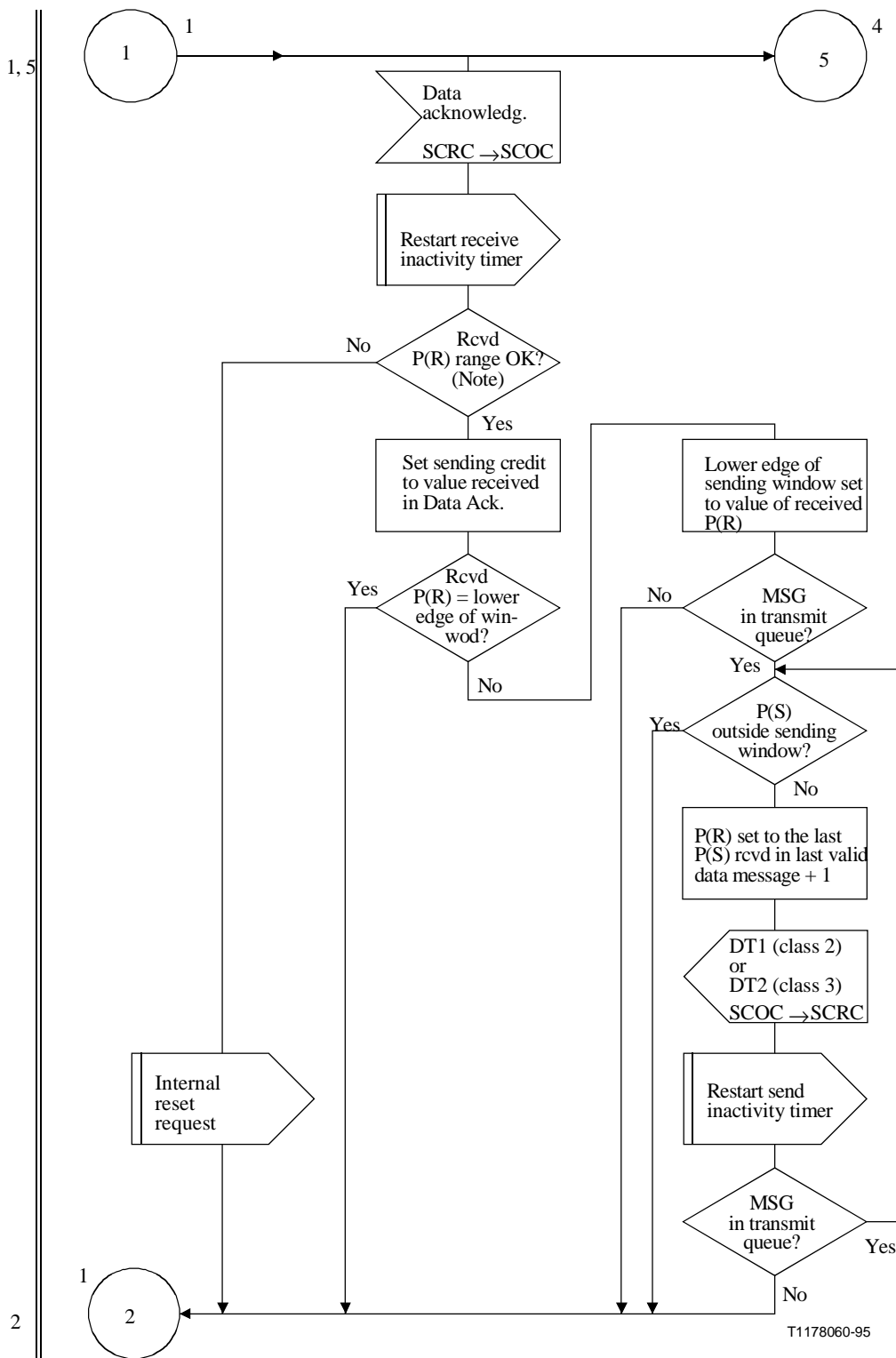
T1178580-96

**Figure C.7/Q.714 (sheet 9 of 9) – Connection release procedures at intermediate node with coupling for SCCP Connection-Oriented Control (SCOC)**



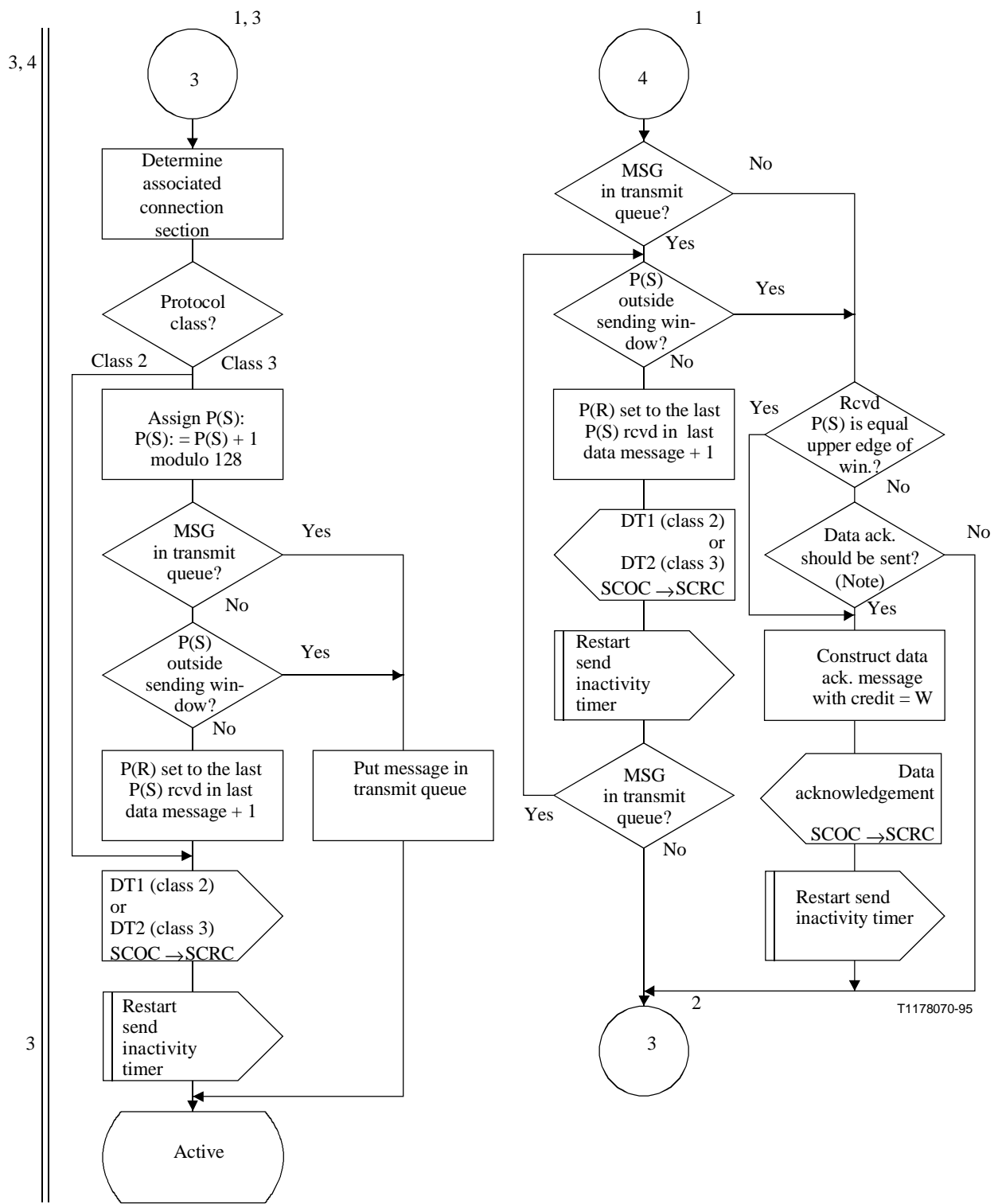
NOTE – Value of P(R) received must be within the range from the last P(R) received up to including the send sequence number of next message to be transmitted.

**Figure C.8/Q.714 (sheet 1 of 4) – Data transfer procedures at intermediate node with coupling for SCCP Connection-Oriented Control (SCOC)**



NOTE – Value of P(R) received must be within the range from the last P(R) received up to including the send sequence number of next message to be transmitted.

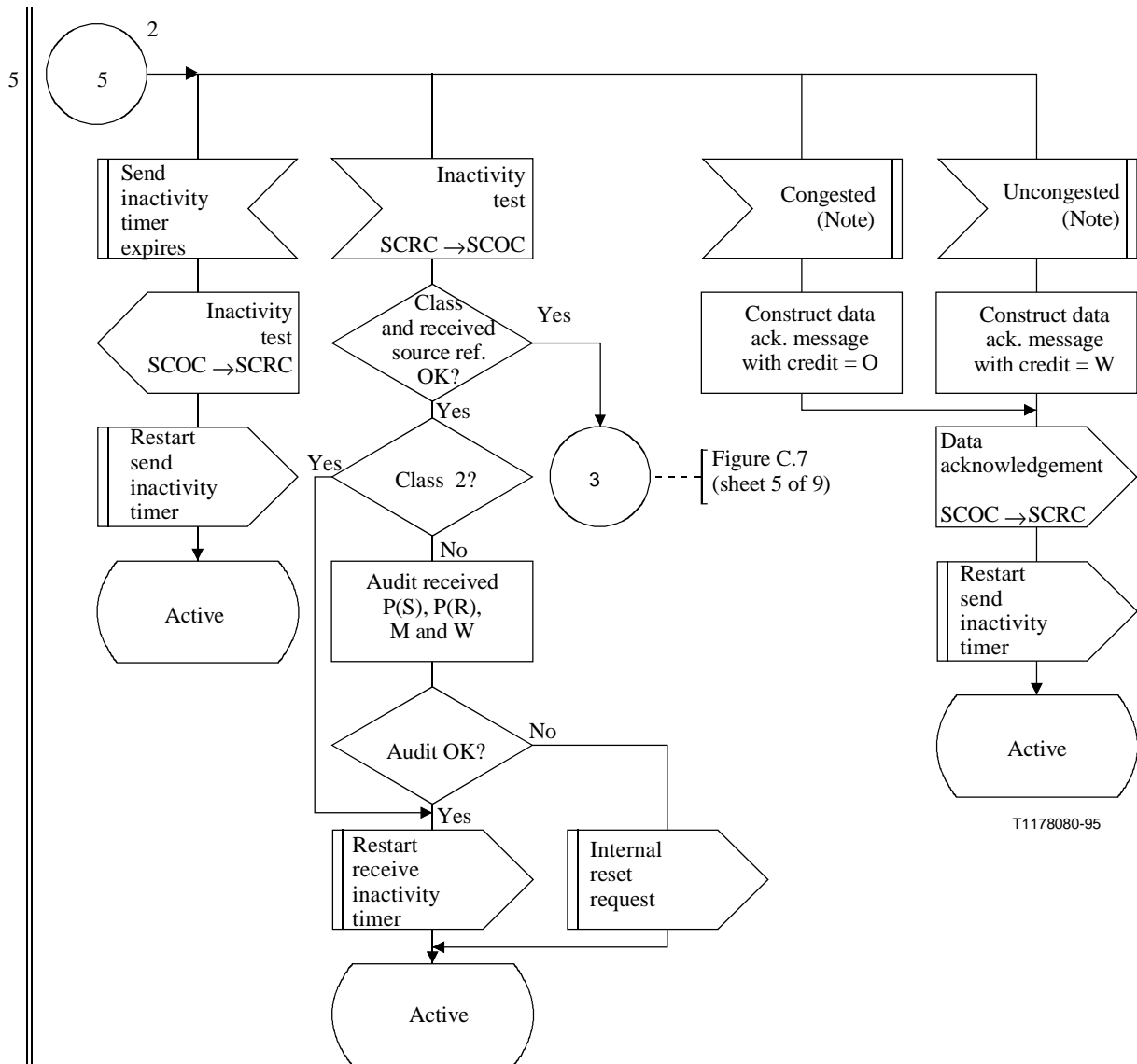
**Figure C.8/Q.714 (sheet 2 of 4) – Data transfer procedures at intermediate node with coupling for SCCP Connection-Oriented Control (SCOC)**



NOTE – This criterion is implementation dependent.

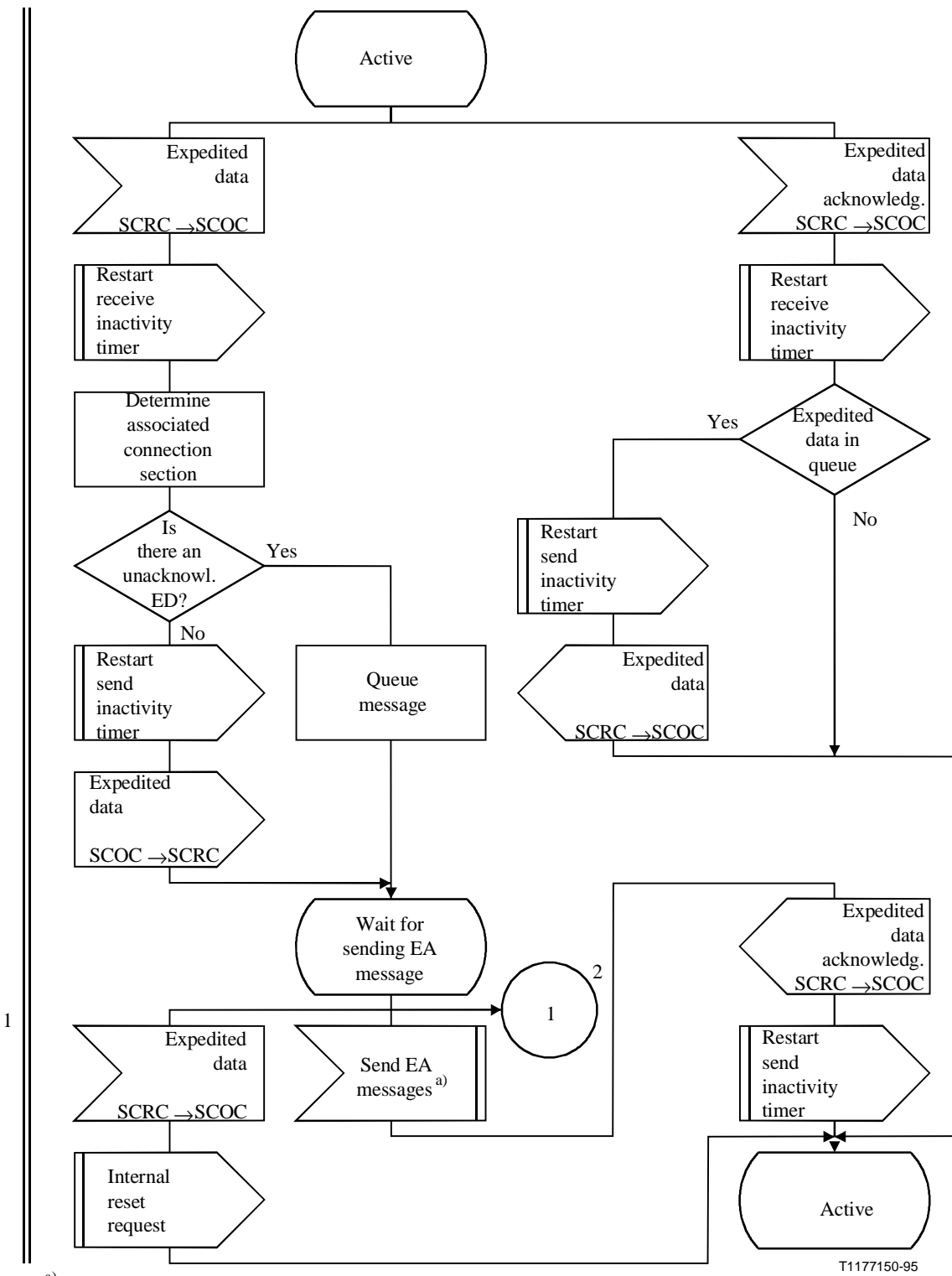
Figure C.8/Q.714 (sheet 3 of 4) – Data transfer procedures at intermediate node with coupling for SCCP Connection-Oriented Control (SCOC)



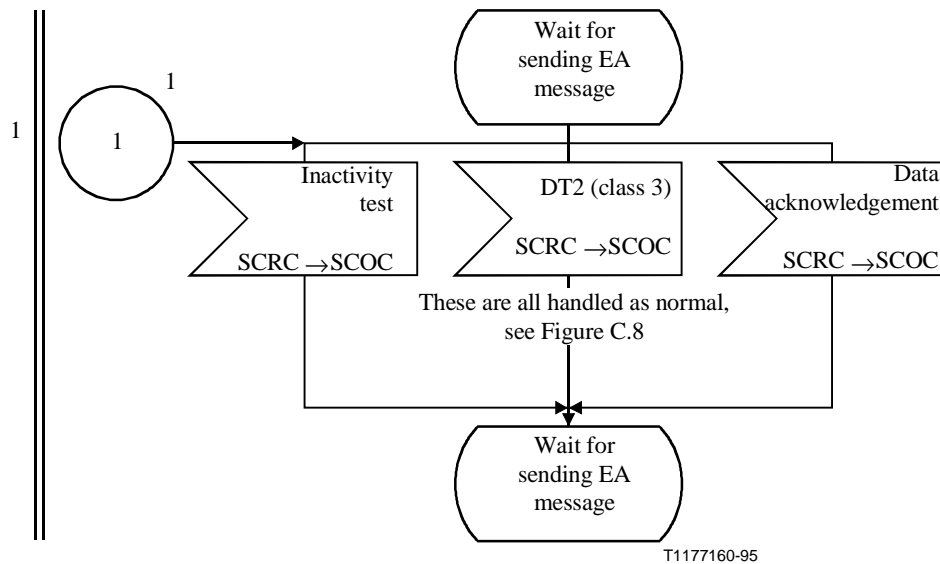


NOTE – From an implementation dependent function.

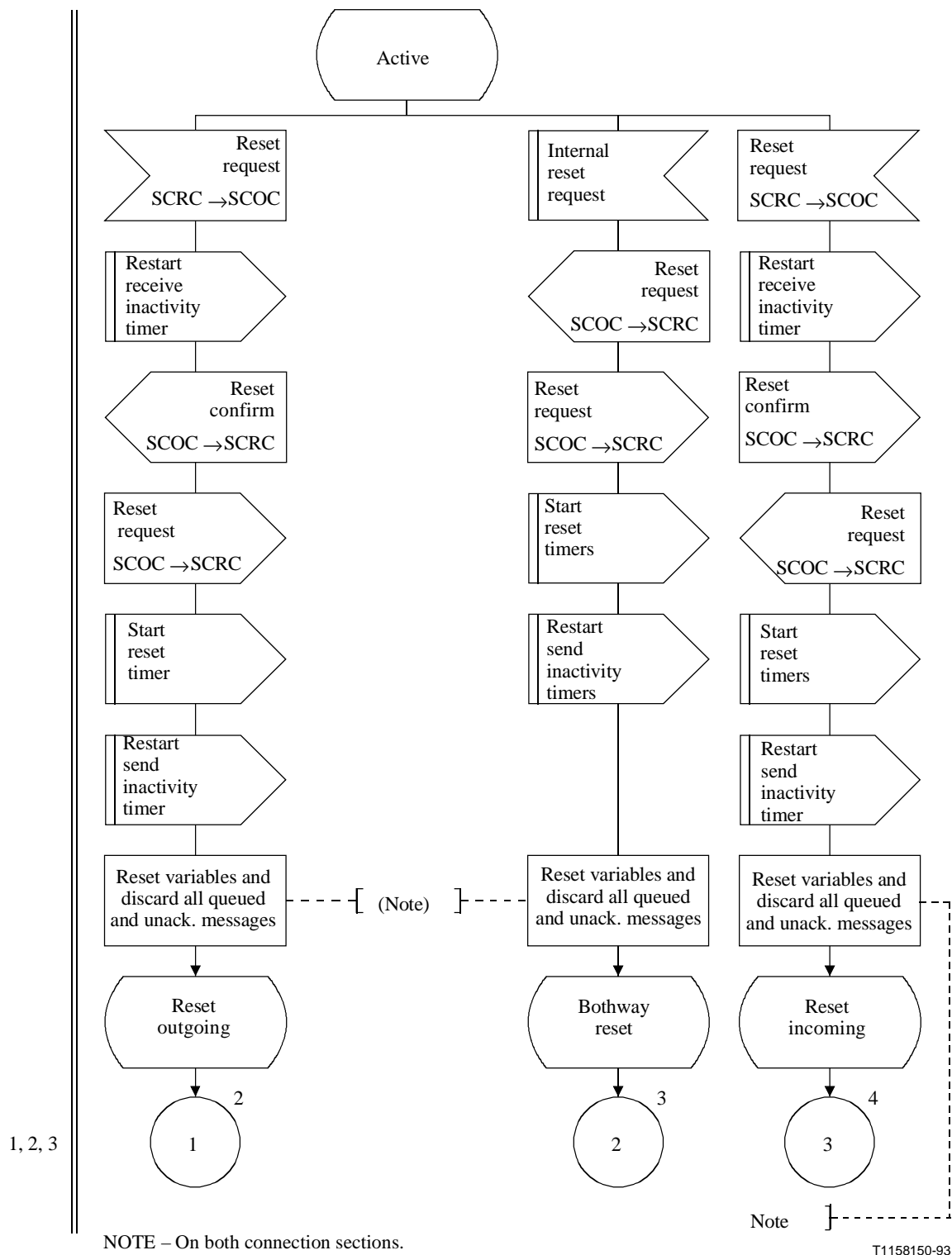
**Figure C.8/Q.714 (sheet 4 of 4) – Data transfer procedures at intermediate node with coupling for SCCP Connection-Oriented Control (SCOC)**



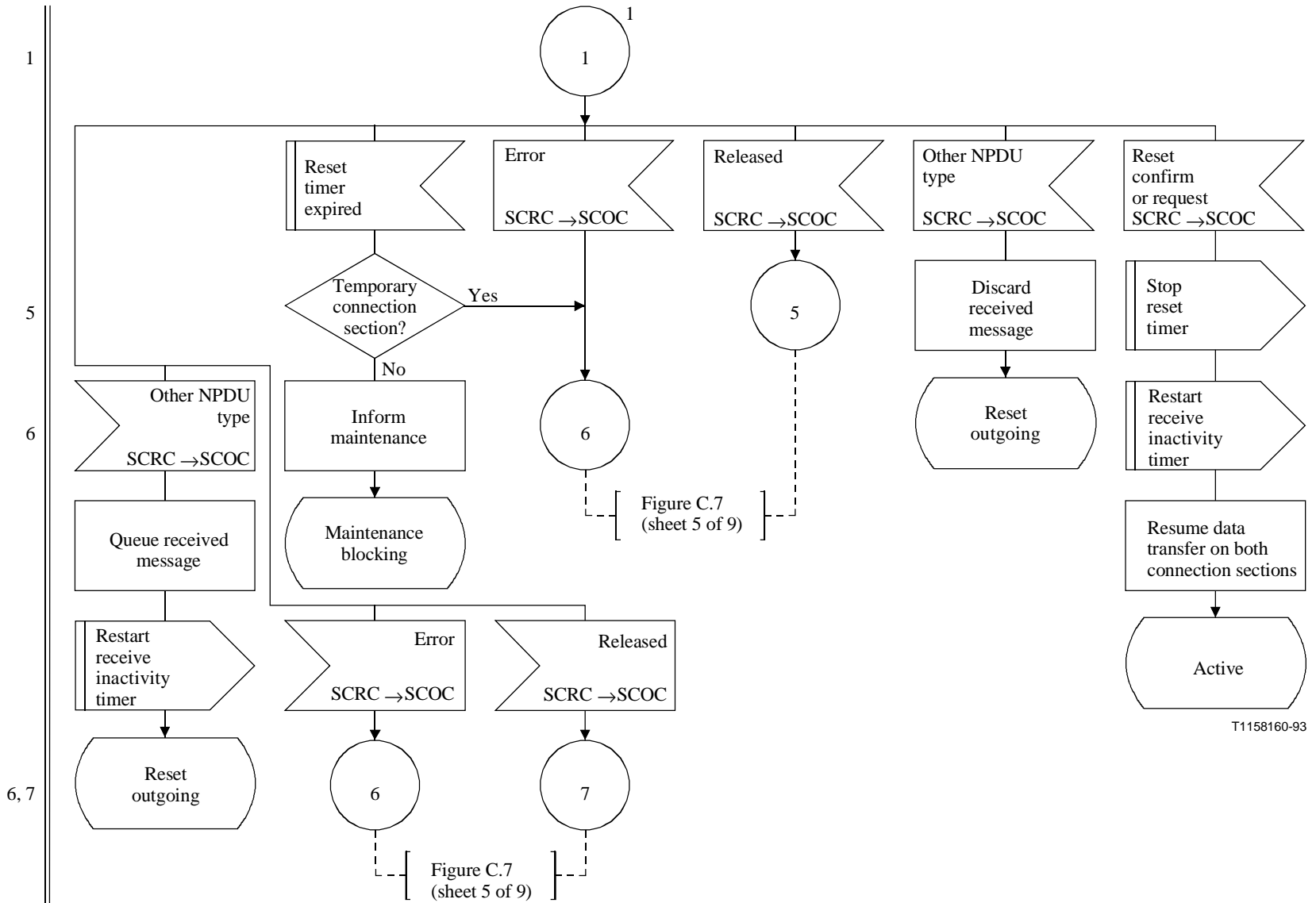
**Figure C.9/Q.714 (sheet 1 of 2) – Expedited data transfer procedures at intermediate node with coupling for SCCP Connection-Oriented Control (SCOC)**



**Figure C.9/Q.714 (sheet 2 of 2) – Expedited data transfer procedures at intermediate node with coupling for SCCP Connection-Oriented Control (SCOC)**

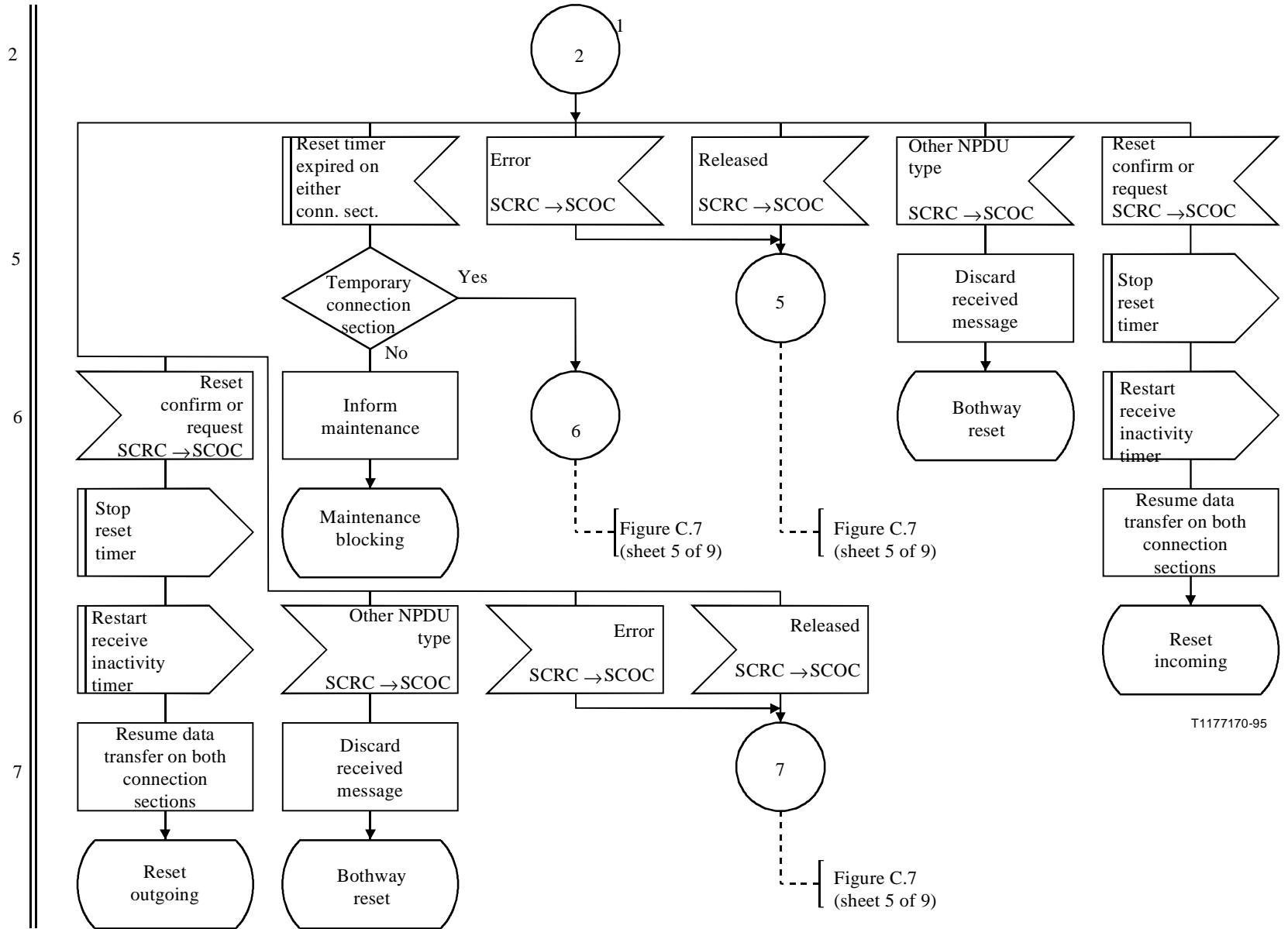


**Figure C.10/Q.714 (sheet 1 of 4) – Reset procedures at intermediate node with coupling for SCCP Connection-Oriented Control (SCOC)**



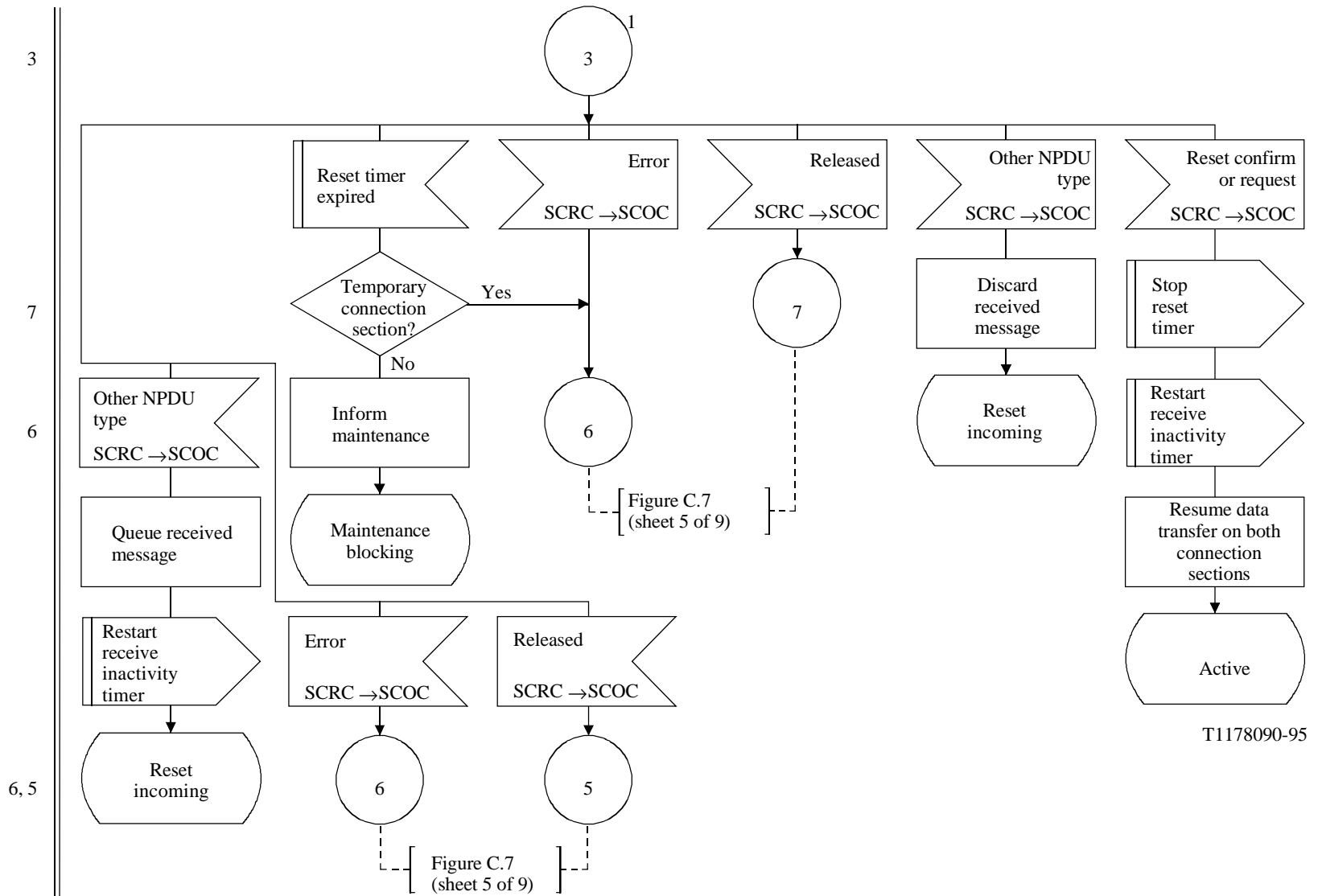
T1158160-93

**Figure C.10/Q.714 (sheet 2 of 4) – Reset procedures at intermediate node with coupling for SCCP Connection-Oriented Control (SCOC)**



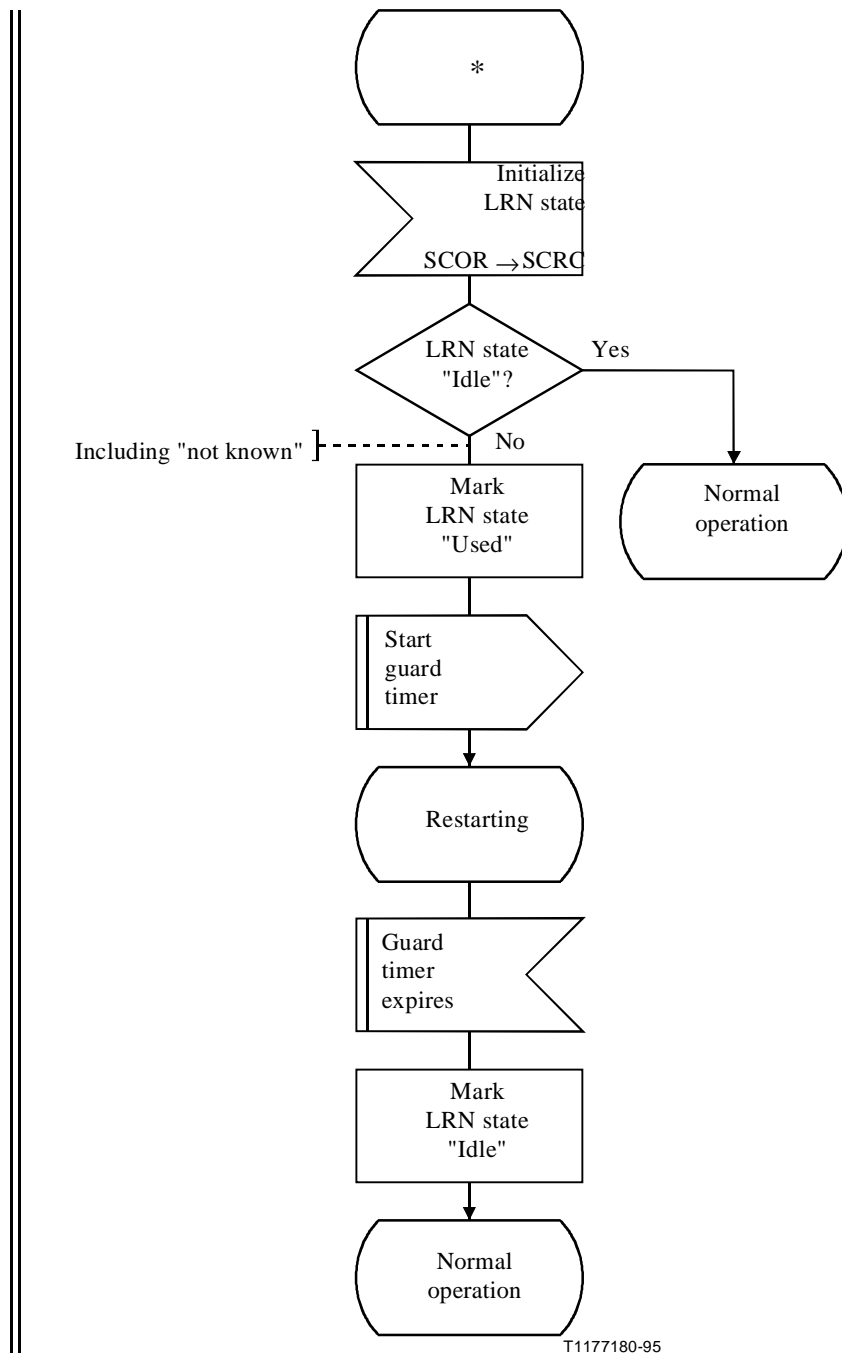
T1177170-95

Figure C.10/Q.714 (sheet 3 of 4) – Reset procedures at intermediate node with coupling for SCCP Connection-Oriented Control (SCOC)



T1178090-95

Figure C.10/Q.714 (sheet 4 of 4) – Reset procedures at intermediate node with coupling for SCCP Connection-Oriented Control (SCOC)

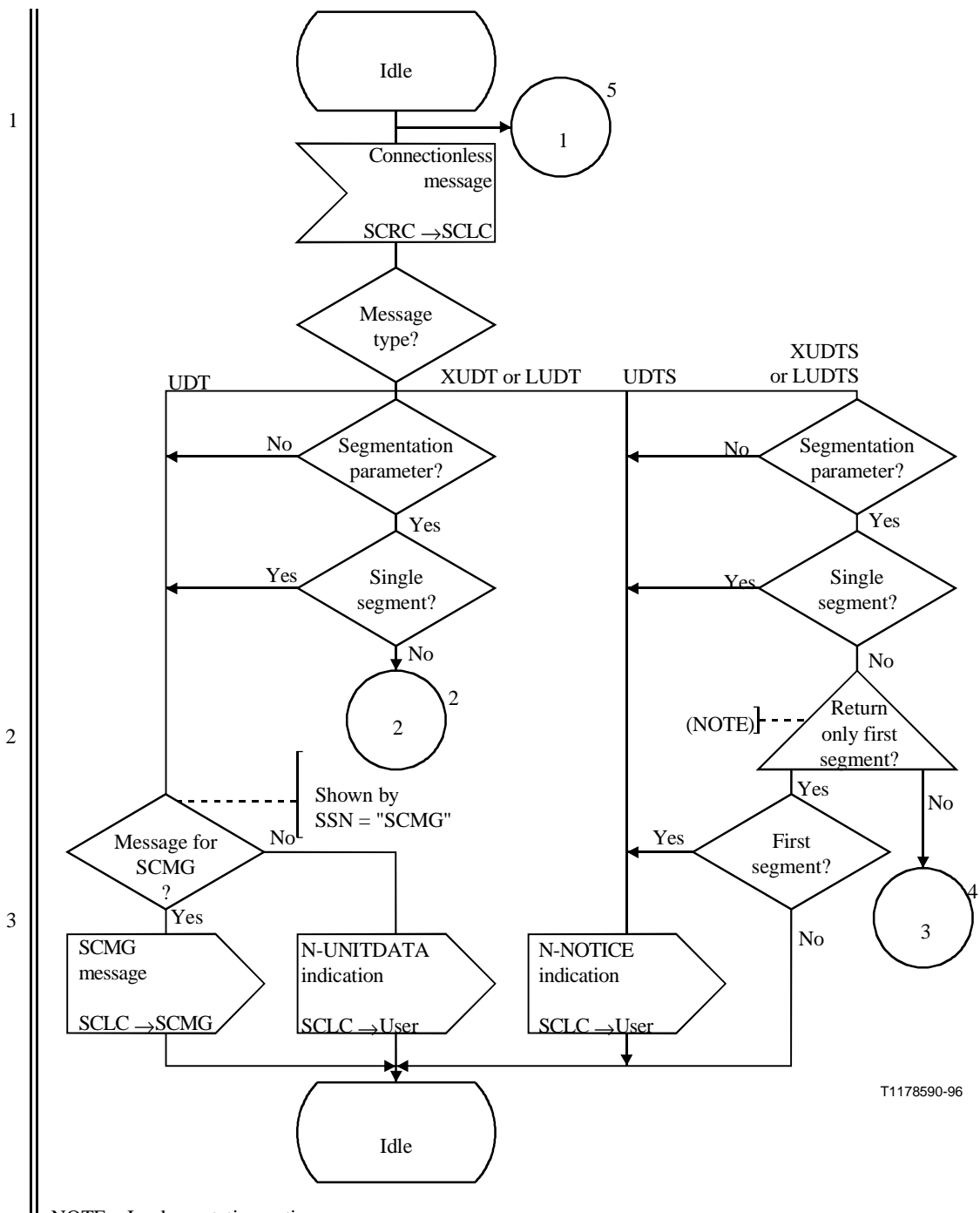


LRN Local Reference Number

NOTE – In the "restarting" state, messages arriving for a LRN marked "used" are treated in the same way as messages with an unassigned destination local reference.

**Figure C.11/Q.714 – Restart procedure for SCCP Connection-Oriented Control (SCOC)**





T1178590-96

NOTE – Implementation option.

Figure C.12/Q.714 (sheet 1 of 9) – SCCP Connectionless Control (SCLC)

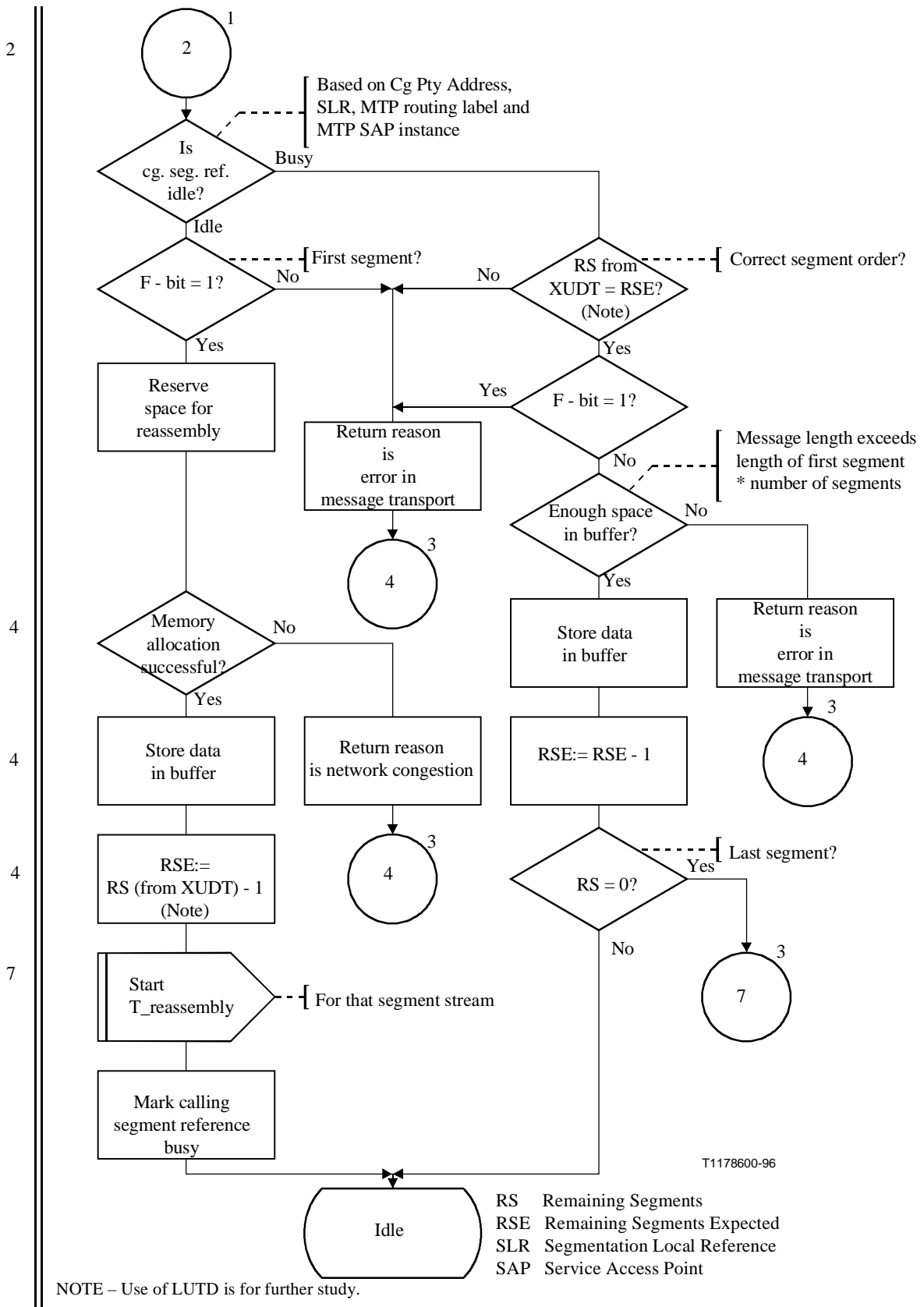
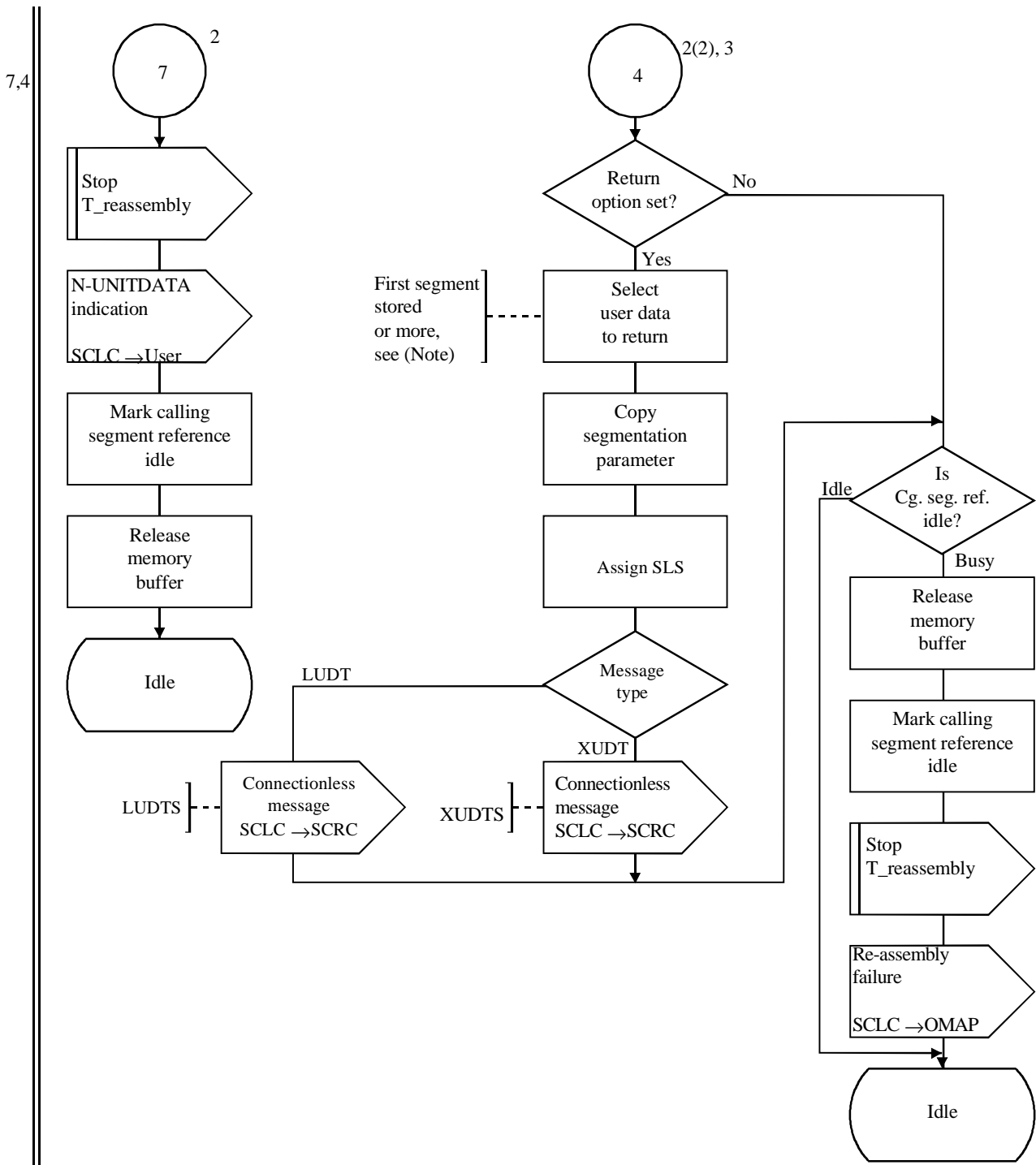


Figure C.12/Q.714 (sheet 2 of 9) – SCCP Connectionless Control (SCLC)

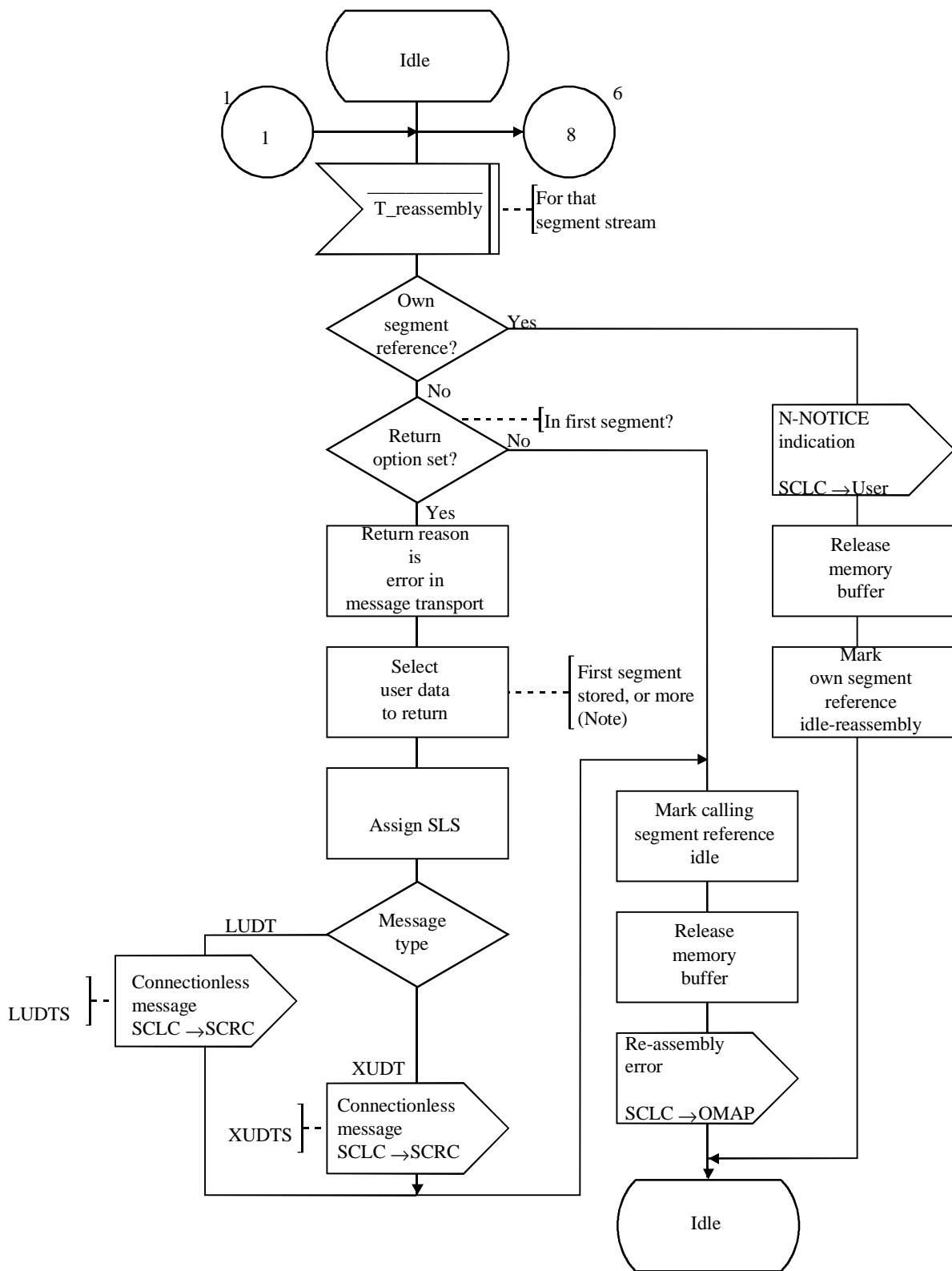


T1178610-96

NOTE – The amount of data is implementation dependent subject to the total capacity of a single XUDTS message.

Figure C.12/Q.714 (sheet 3 of 9) – SCCP Connectionless Control (SCLC)

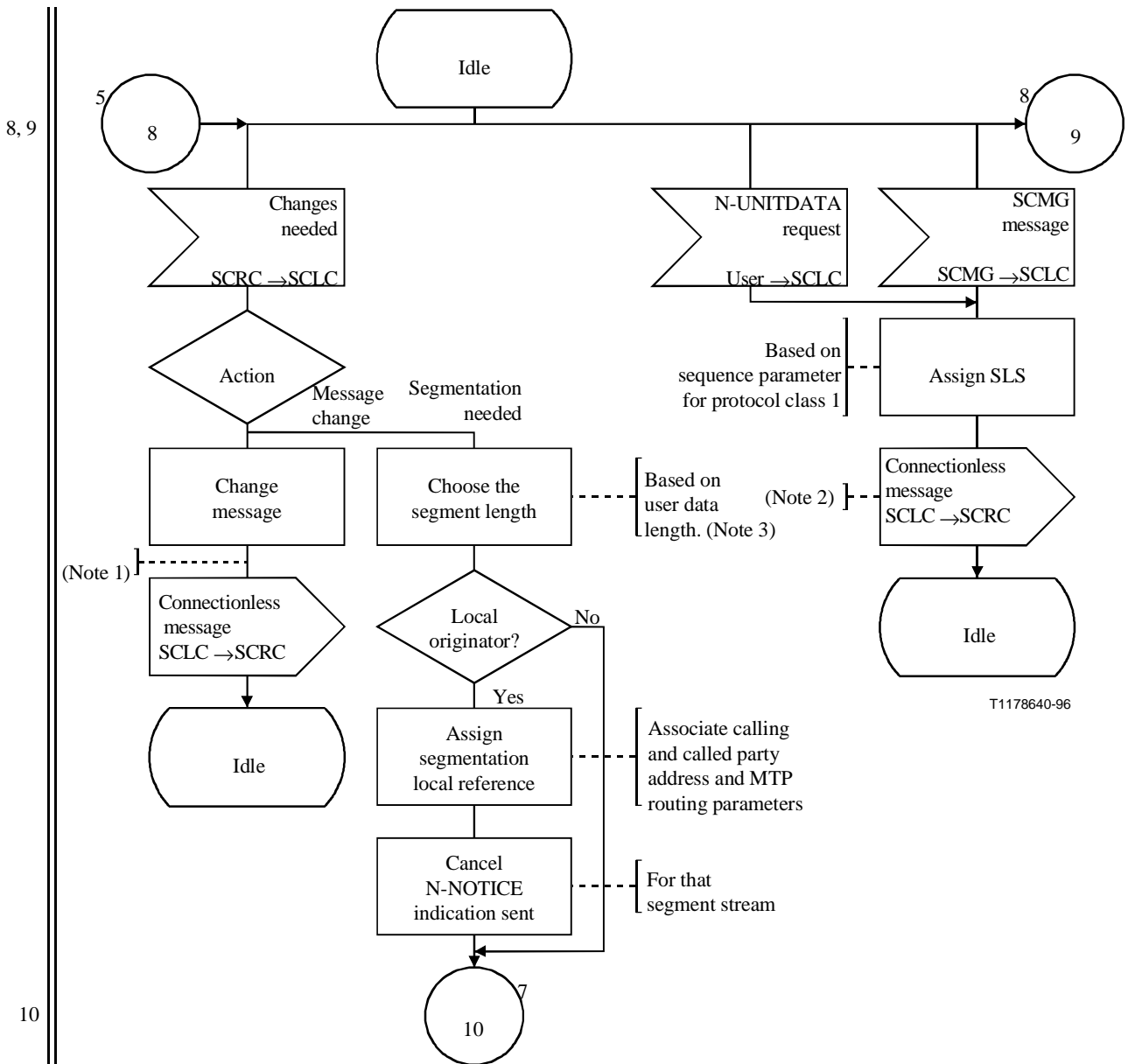




NOTE – The amount of data is implementation dependent subject to the total capacity of a single XUDTS message.

T1178630-96

Figure C.12/Q.714 (sheet 5 of 9) – SCCP Connectionless Control (SCLC)

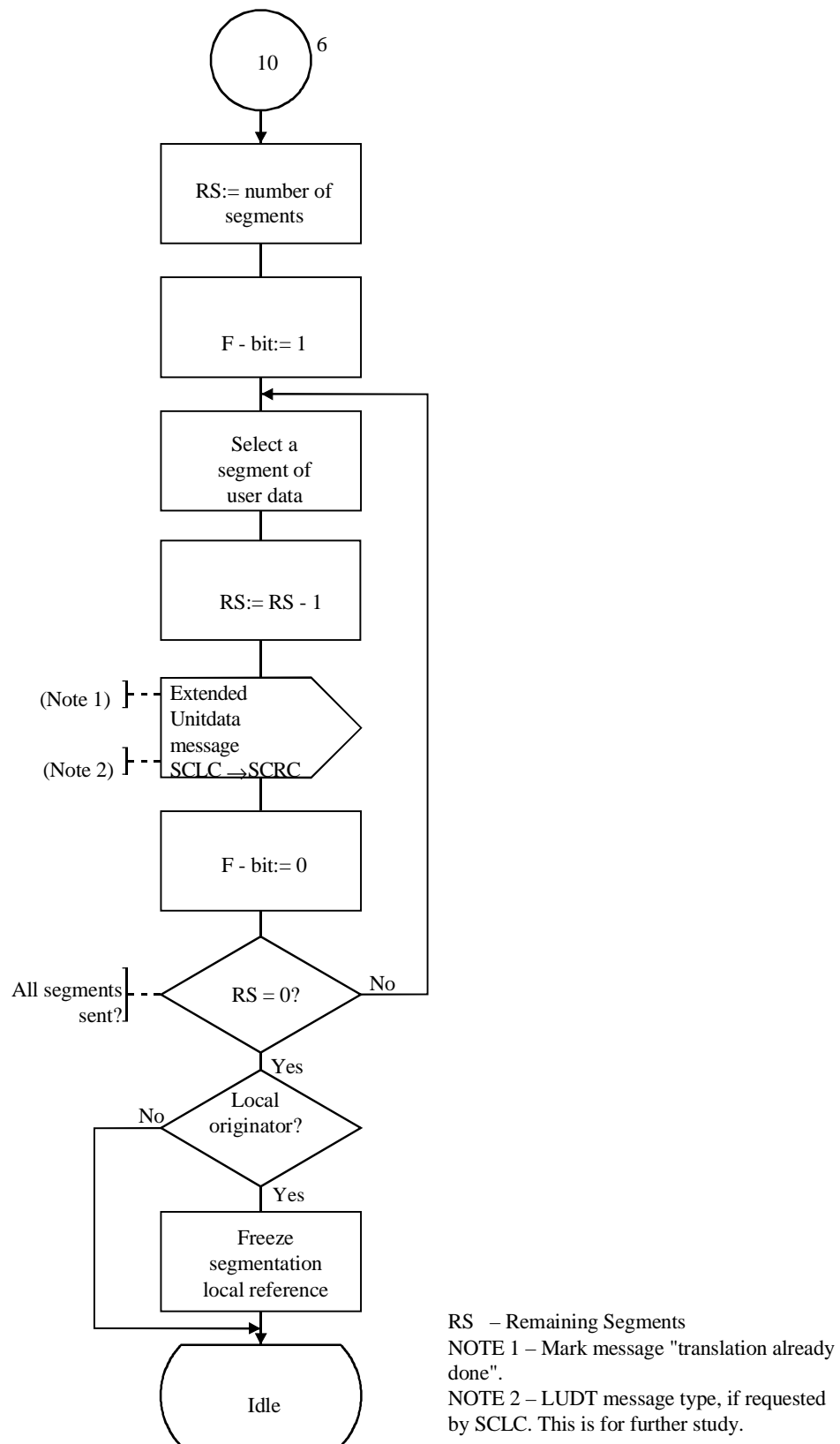


NOTE 1 – Mark message "translation already done".

NOTE 2 – UDT, XUDDT or LUDT is used, depending on local knowledge.

NOTE 3 – In any case the total user data length must be less than 3 952 octets.

**Figure C.12/Q.714 (sheet 6 of 9) – SCCP Connectionless Control (SCLC)**



T1178650-96

Figure C.12/Q.714 (sheet 7 of 9) – SCCP Connectionless Control (SCLC)

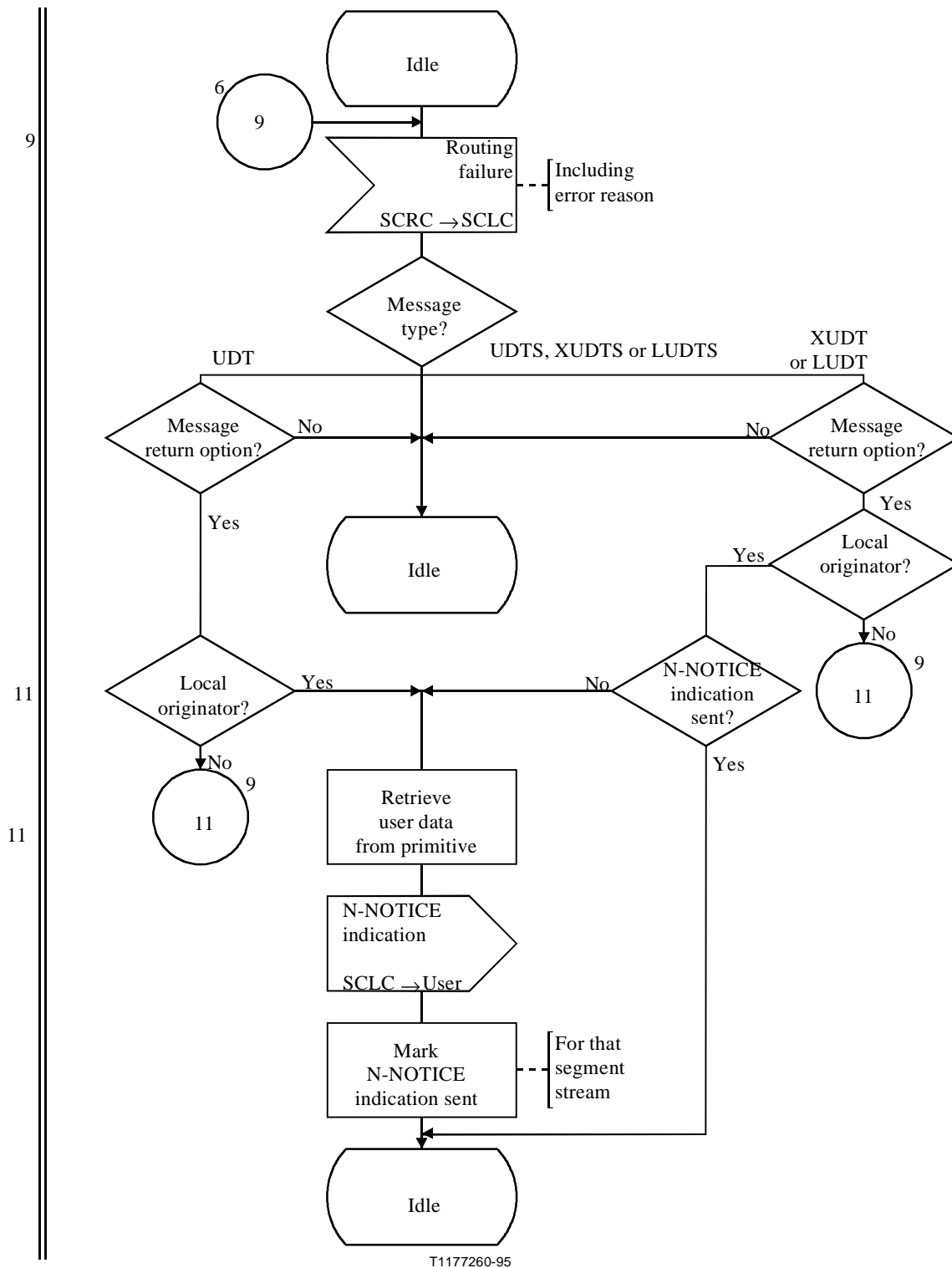


Figure C.12/Q.714 (sheet 8 of 9) – SCCP Connectionless Control (SCLC)



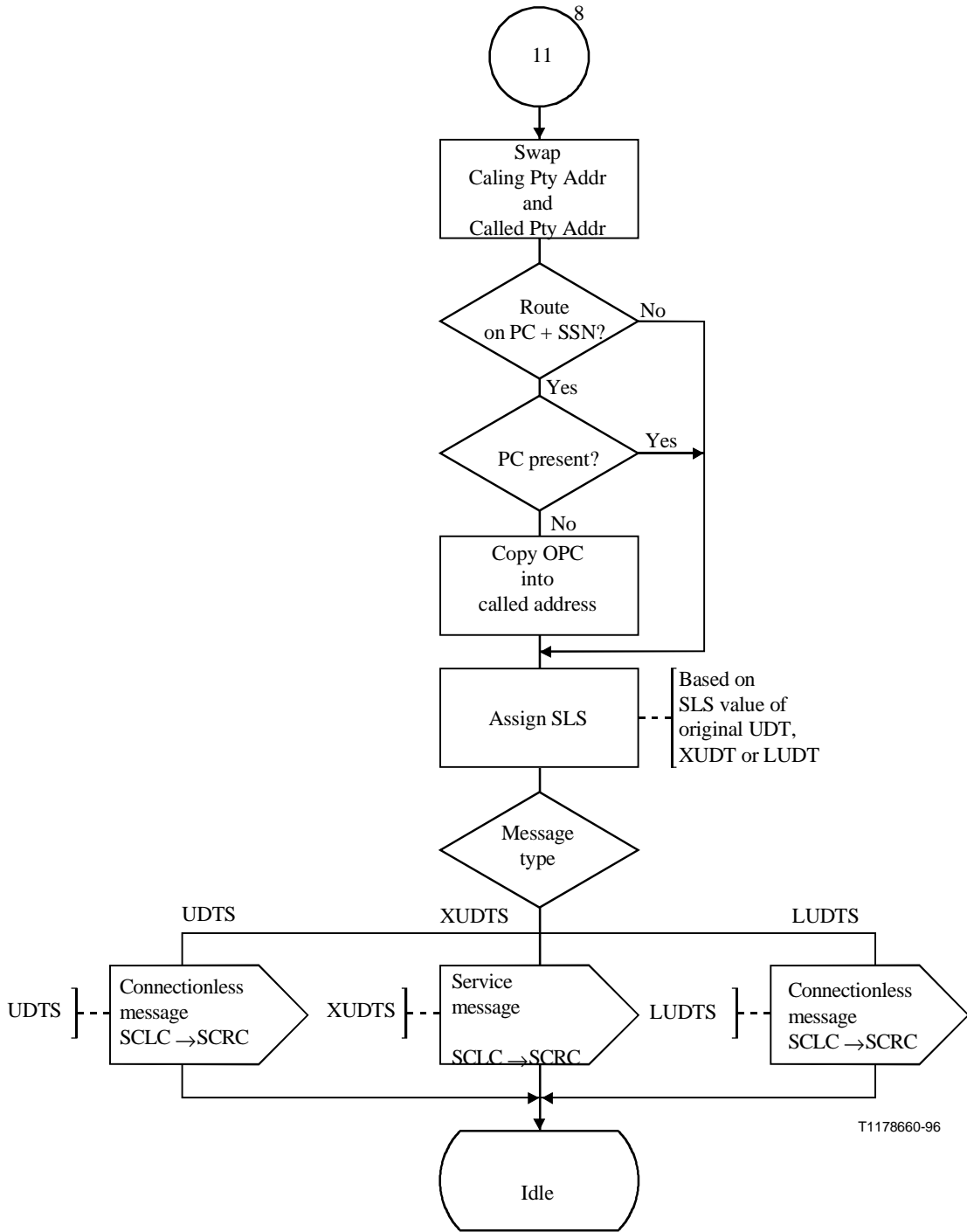
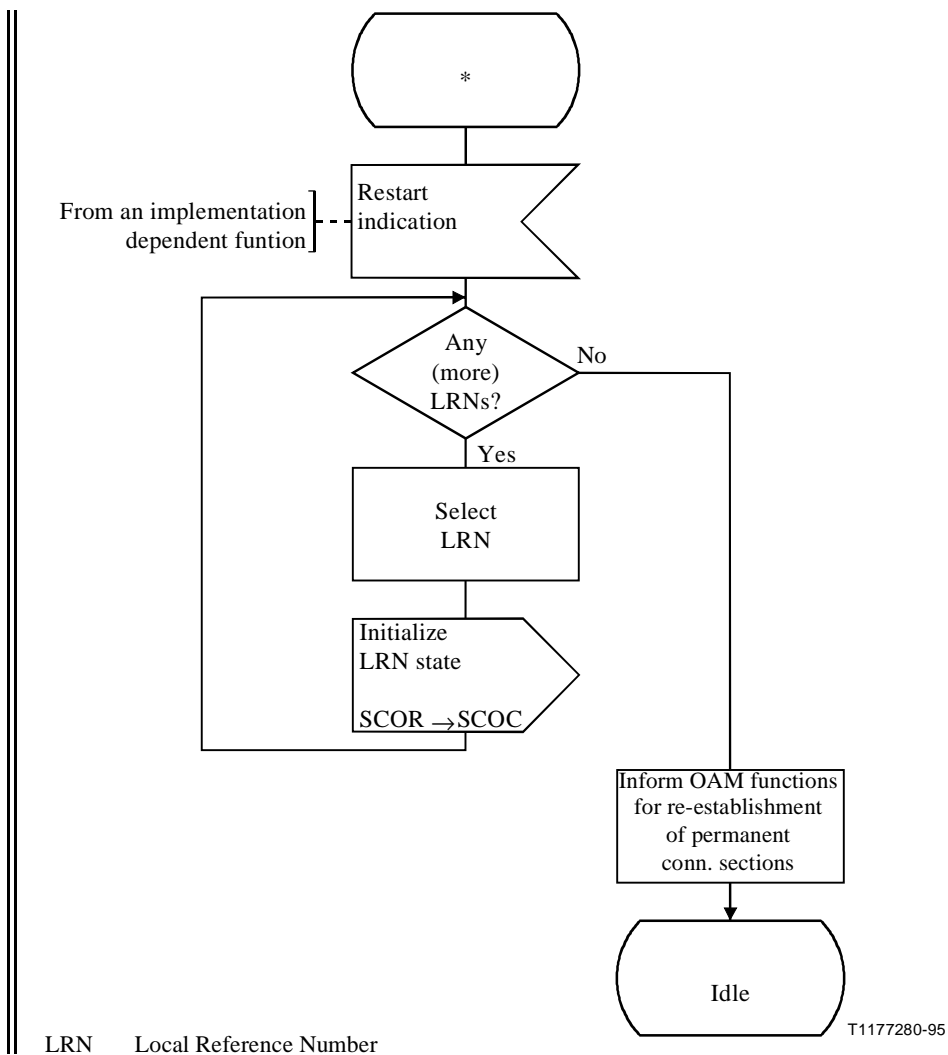


Figure C.12/Q.714 (sheet 9 of 9) – SCCP Connectionless Control (SCLC)



**Figure C.13/Q.714 – Restart control for SCCP connection-oriented control (SCOR)**

## ANNEX D

### State transition diagrams (STD) for SCCP management control

#### D.1 General

This Annex contains the description of the SCCP management (SCMG) function according to the CCITT Specification and Description Language (SDL).

For the SCCP management function, Figure D.1 illustrates a subdivision into functional blocks, showing their functional interactions as well as the functional interactions with the other major functions [e.g. SCCP connectionless control (SCLC)]. This is followed by Figures D.2 to D.10 showing state transition diagrams for each of the functional blocks.

The detailed functional breakdown shown in the following diagrams is intended to illustrate a reference model, and to assist interpretation of the text of the SCCP management procedures. The state transition diagrams are intended to show precisely the behaviour of the signalling system under normal and abnormal conditions as viewed from a remote location. It must be emphasized that the functional partitioning shown in the following diagrams is used only to facilitate understanding of

the system behaviour, and is not intended to specify the functional partitioning to be adopted in a practical implementation of the signalling system.

## D.2 Drafting conventions

Each major function is designated by its acronym (e.g. SCMG = SCCP management).

Each functional block is also designated by an acronym which identifies it (e.g. SSAC = Subsystem Allowed Control).

External inputs and outputs are used for interactions between different functional blocks. Included within each input and output symbol in the state transition diagrams are acronyms which identify the functional blocks which are the source and the destination of the message, e.g.:

SSAC→SSTC indicates that the message is sent from Subsystem Allowed Control to Subsystem Test Control.

Internal inputs and outputs are only used to indicate control of timers.

## D.3 Figures

Figure D.1 shows a subdivision of the SCCP management function (SCMG) into smaller functional blocks, and also shows the functional interactions between them. Each of these functional blocks is described in detail in a state transition diagram as follows:

- a) Signalling Point Prohibited Control (SPPC) is shown in Figure D.2;
- b) Signalling Point Allowed Control (SPAC) is shown in Figure D.3;
- c) Signalling Point Congested Control (SPCC) is shown in Figure D.4;
- d) SubSystem Prohibited Control (SSPC) is shown in Figure D.5;
- e) SubSystem Allowed Control (SSAC) is shown in Figure D.6;
- f) SubSystem Status Test Control (SSTC) is shown in Figure D.7;
- g) Coordinated State Change Control (CSCC) is shown in Figure D.8;
- h) Local Broadcast (LBCS) is shown in Figure D.9;
- i) Broadcast (BCST) is shown in Figure D.10;
- j) SCCP Restart Control (SRTC) is shown in Figure D.11;
- k) Local SCCP and nodal congestion control (SLCC) is shown in Figure D.12;
- l) Remote SCCP and nodal congestion control (SRCC) is shown in Figure D.13.

## D.4 Abbreviations and timers

Abbreviations and timers used in Figures D.1 to D.13 are listed below.

### Abbreviations

BCST	Broadcast
CSCC	Coordinated State Change Control
DPC	Destination Point Code
LBCS	Local Broadcast
MSG	Message
MTP	Message Transfer Part
SCCP	Signalling Connection Control Part

SCLC	SCCP Connectionless Control
SCMG	SCCP Management
SCOC	SCCP Connection-Oriented Control
SCRC	SCCP Routing Control
SOG	Subsystem Out of Service Grant
SOR	Subsystem Out of Service Request
SP	Signalling Point
SPAC	Signalling Point Allowed Control
SPCC	Signalling Point Congested Control
SPPC	Signalling Point Prohibited Control
SRTC	SCCP Restart Control
SS	Subsystem
SSA	Subsystem Allowed
SSAC	Subsystem Allowed Control
SSP	Subsystem Prohibited
SSPC	Subsystem Prohibited Control
SST	Subsystem Status Test
SSTC	Subsystem Status Test Control
UIS	User In Service
UOS	User Out of Service

### Timers

T(stat info)	Delay between requests for subsystem status information	Increasing value, starting from 5 to 10 seconds to a maximum of 10 to 20 minutes
T(coord chg)	Waiting for grant for subsystem to go out of service	1 to 2 minutes
T(ignore SST)	Delay for subsystem between receiving grant to go out of service and actually going out of service	Selected by management
T <sub>a</sub>	Time during which the MTP-STATUS primitives are ignored for setting the RL <sub>M</sub> and RSL <sub>M</sub>	60 .. 600 ms
T <sub>d</sub>	Delay for decrementing the MTP restriction level RL <sub>M</sub> and restriction sub-level RSL <sub>M</sub> after congestion has abated	1 sec .. 10 sec
T <sub>con</sub>	Delay for decrementing the SCCP congestion level CL <sub>S</sub> after congestion has abated	1 sec .. 10 sec

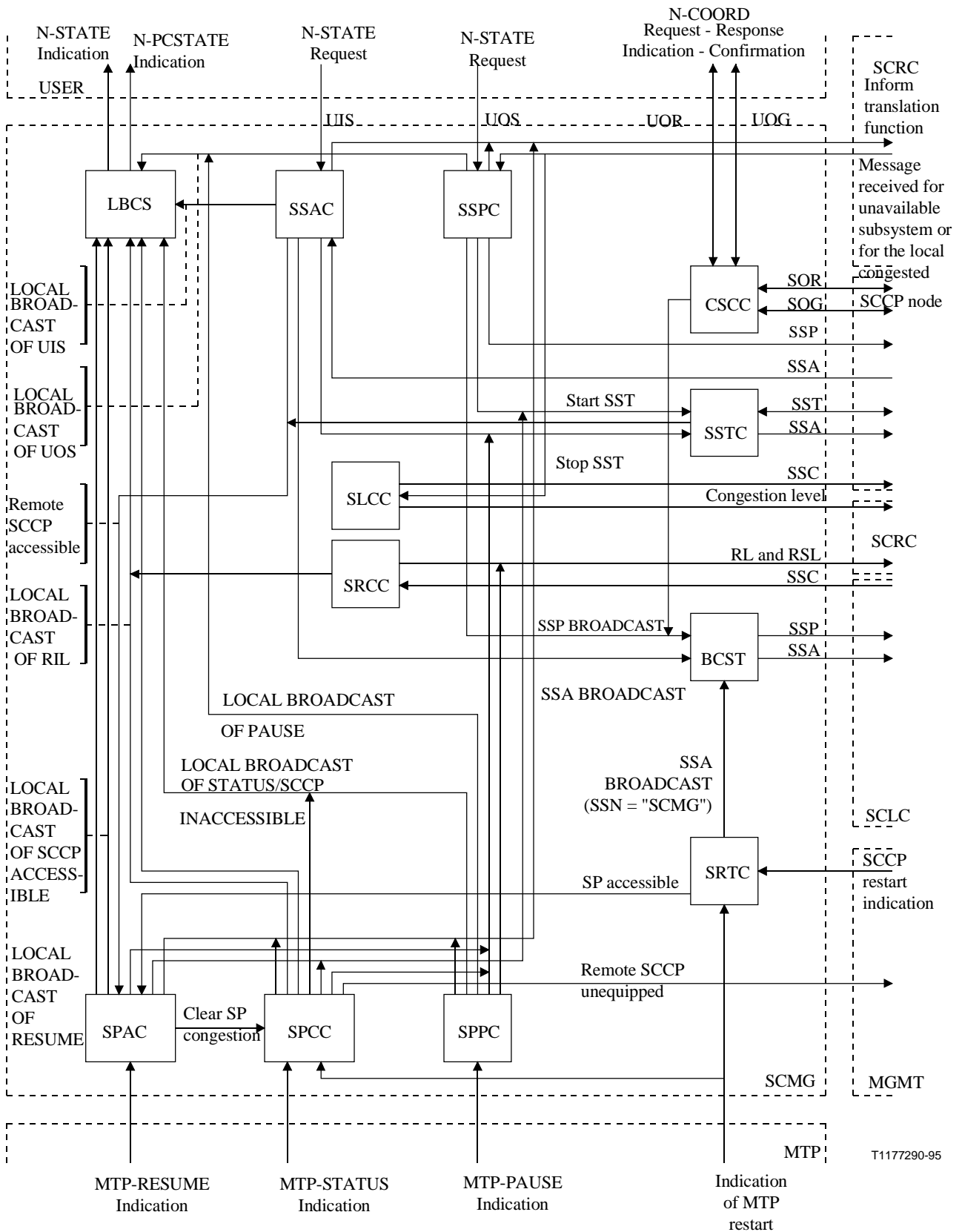


Figure D.1/Q.714 – SCCP management overview (SCMG)

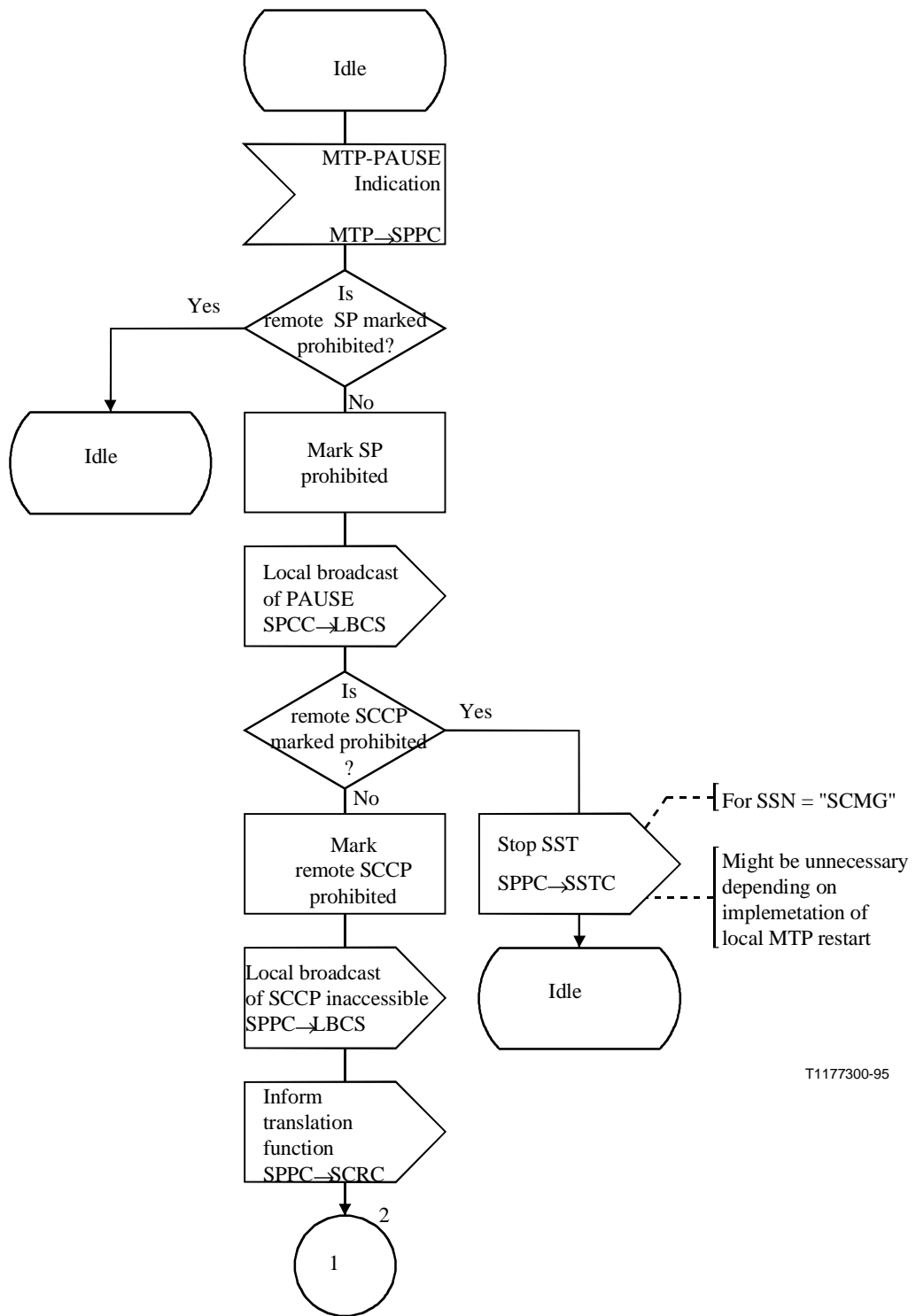


Figure D.2/Q.714 (sheet 1 of 2) – Signalling point prohibited control (SPPC)

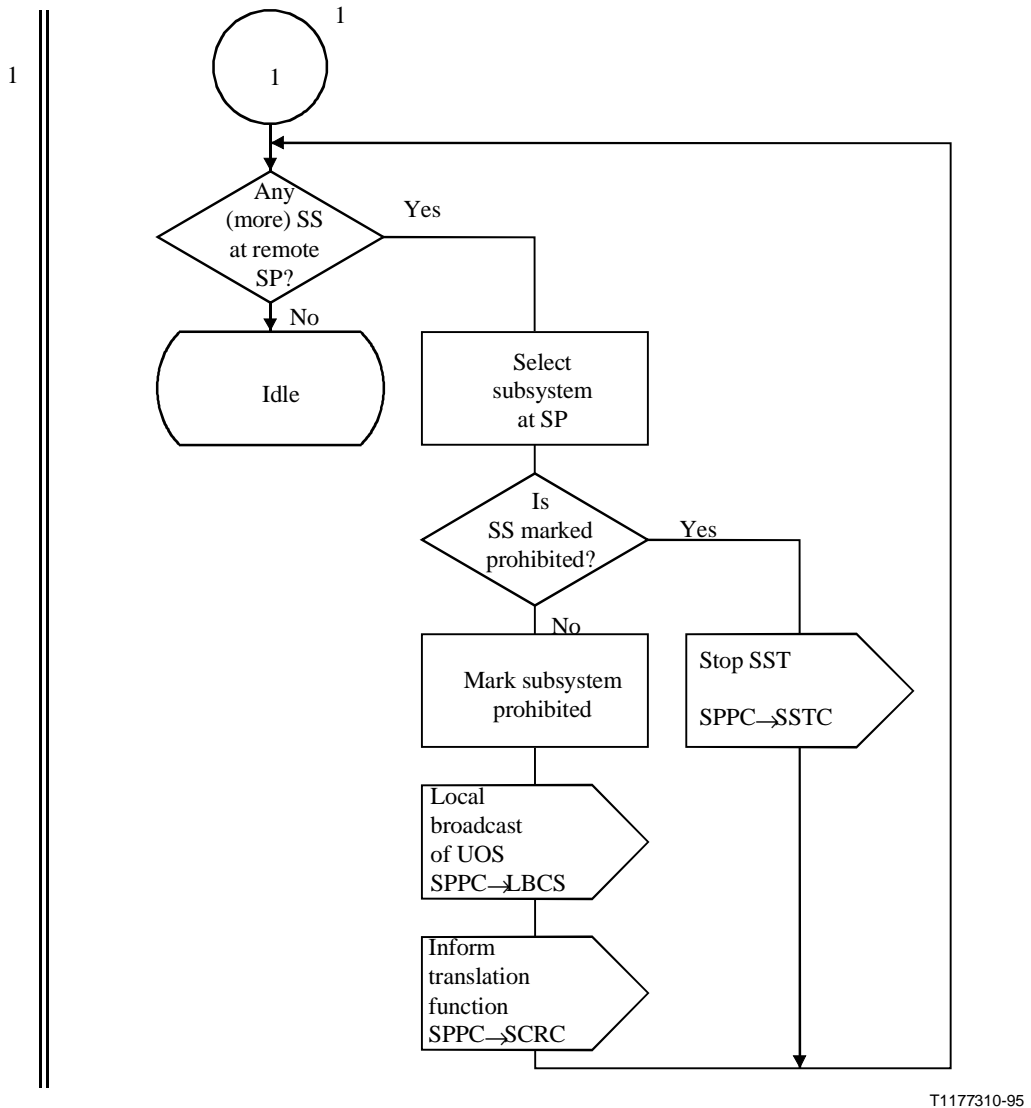


Figure D.2/Q.714 (sheet 2 of 2) – Signalling point prohibited control (SPPC)

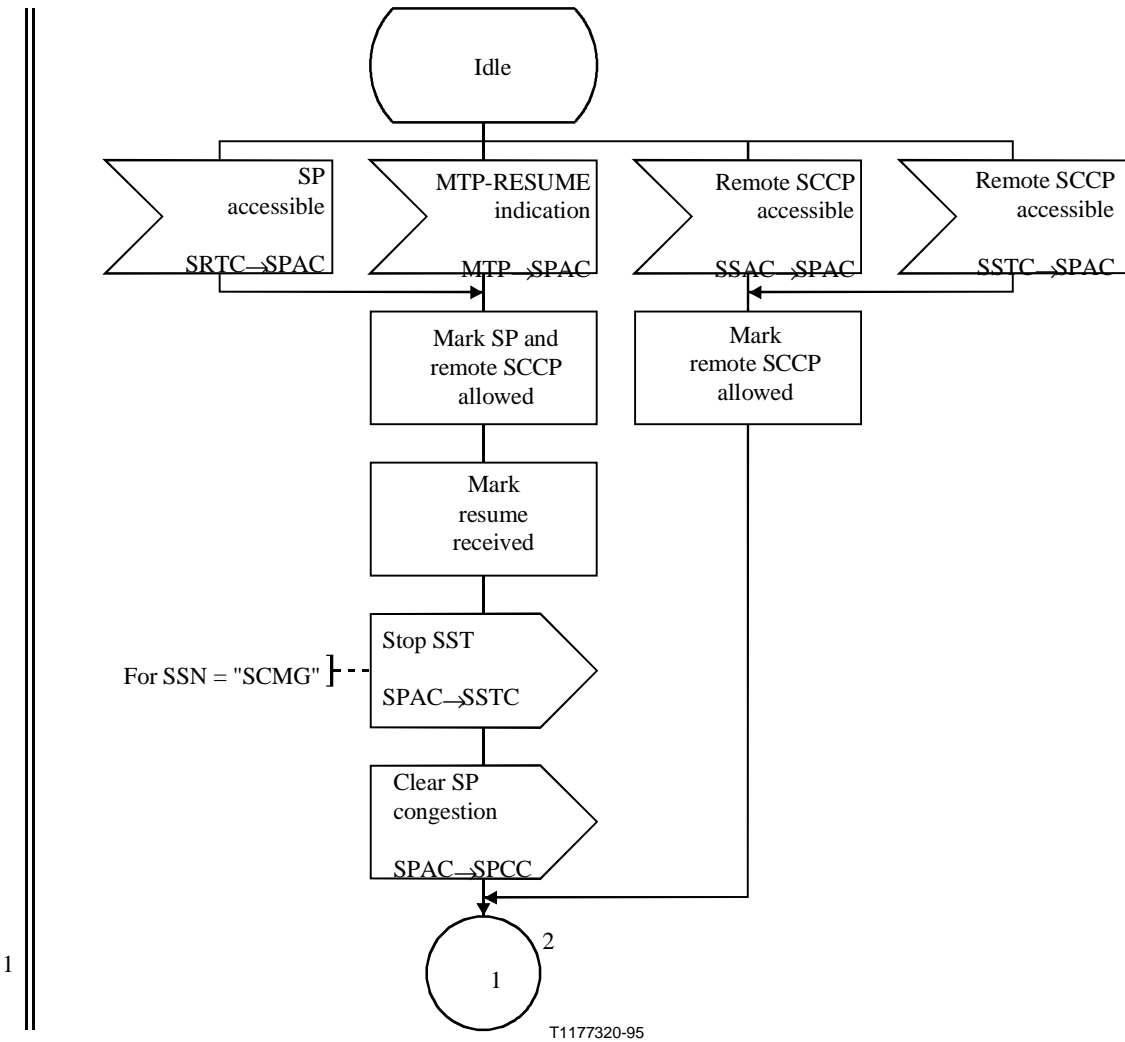
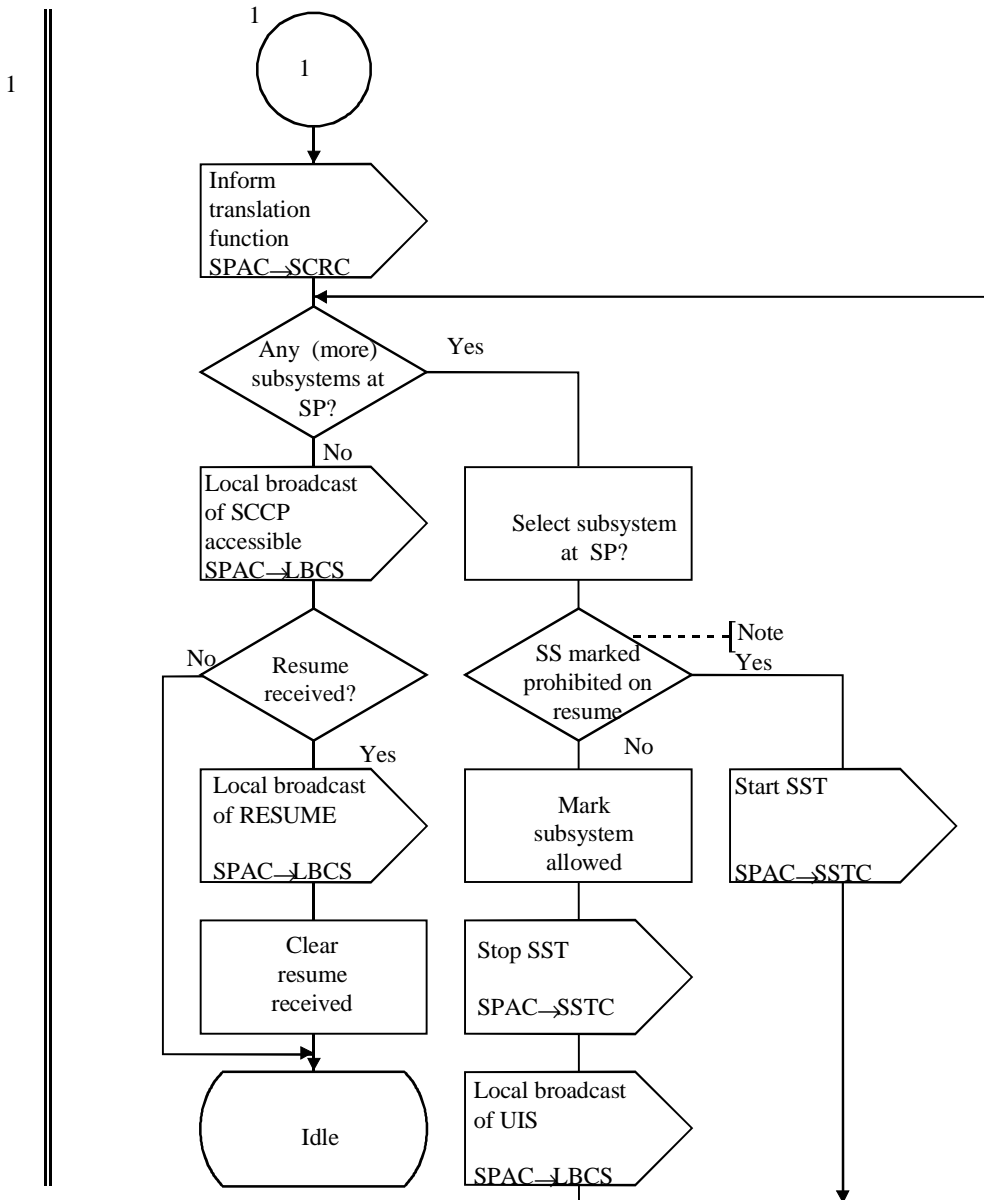


Figure D.3/Q.714 (sheet 1 of 2) – Signalling Point Allowed Control (SPAC)

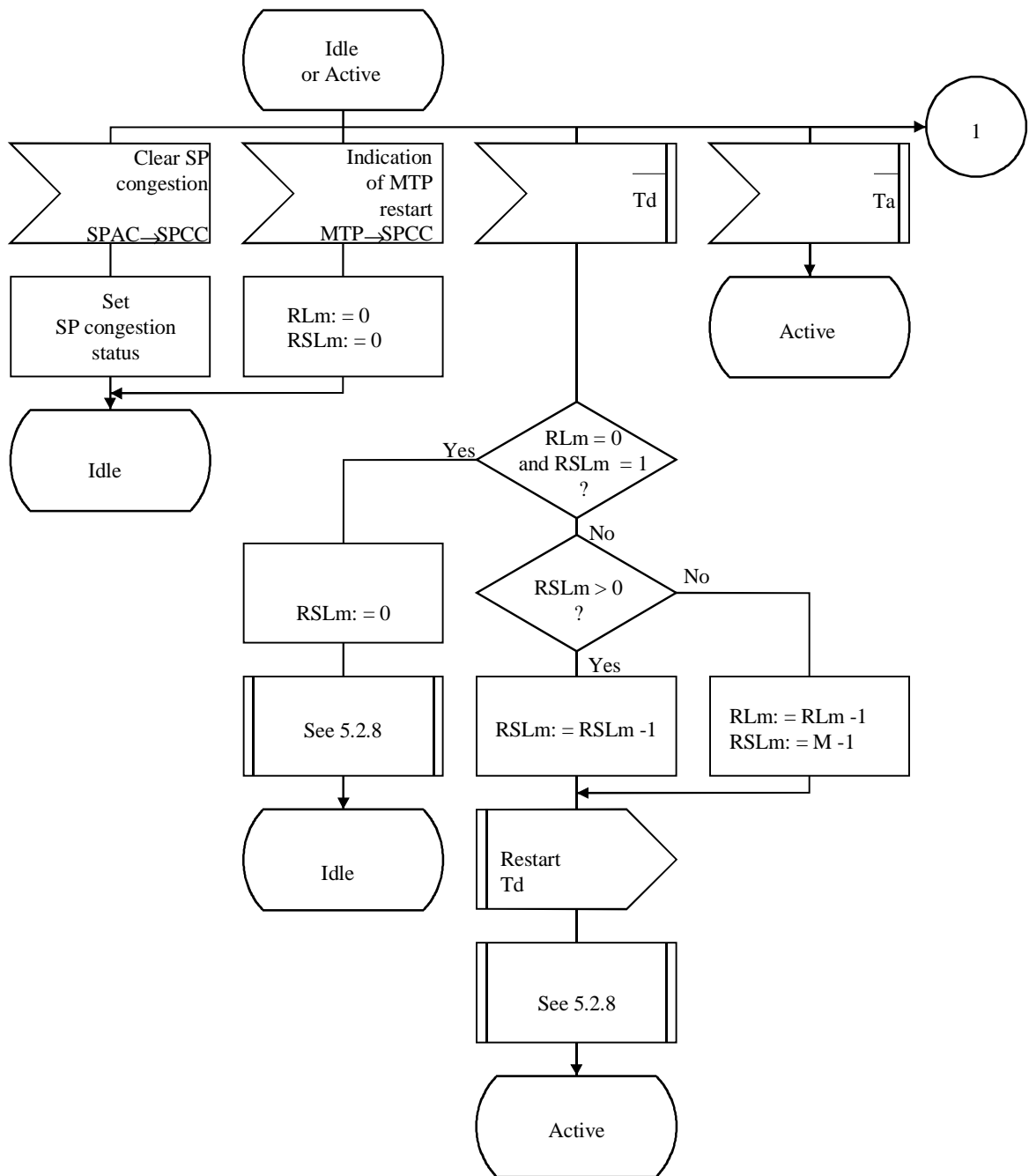




NOTE – Subsystems are optionally marked prohibited as a network provider option.

T1178670-96

**Figure D.3/Q.714 (sheet 2 of 2) – Signalling Point Allowed Control (SPAC)**



T1177340-95

Figure D.4/Q.714 (sheet 1 of 4) – Signalling Point Congested Control (SPCC)

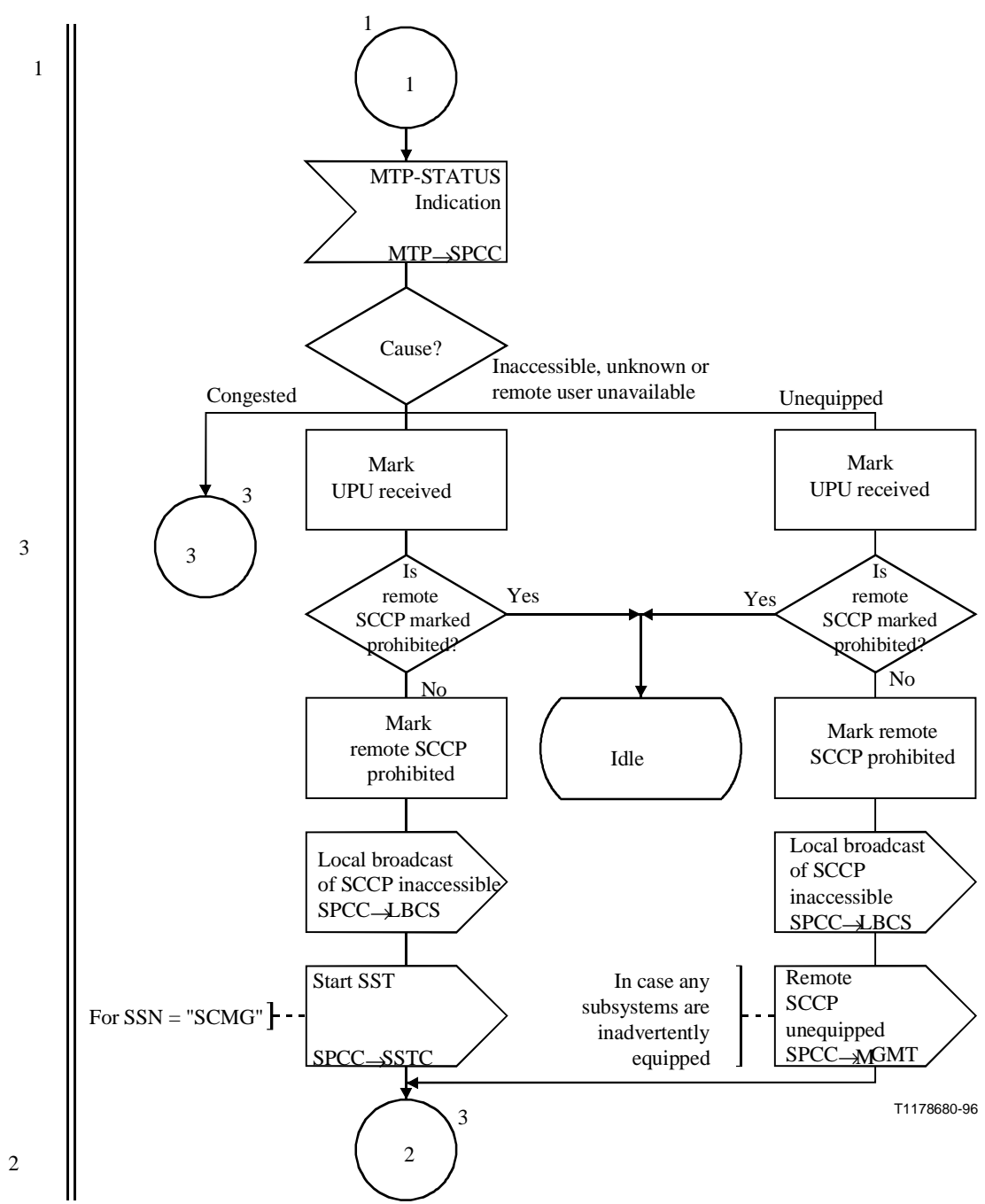
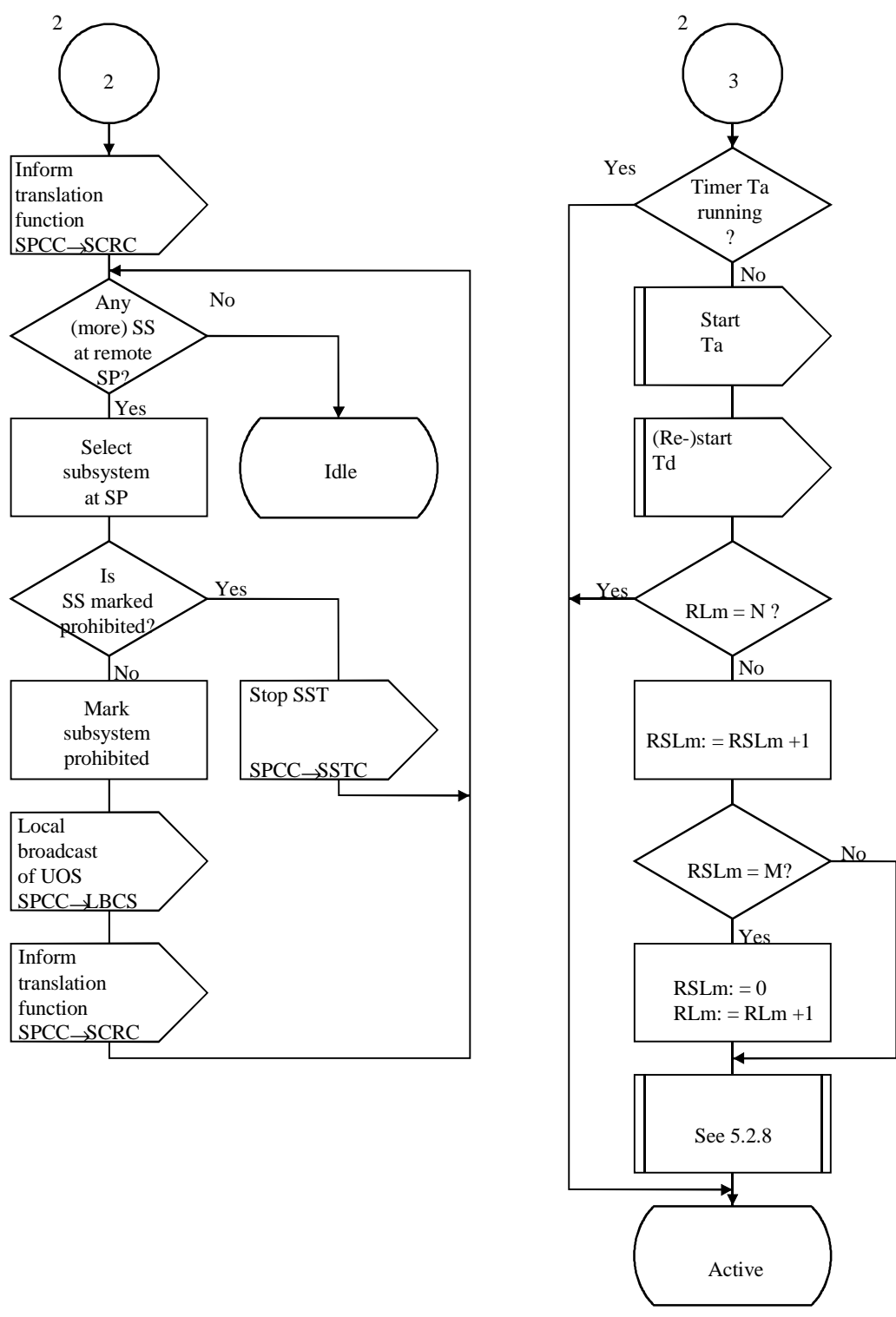


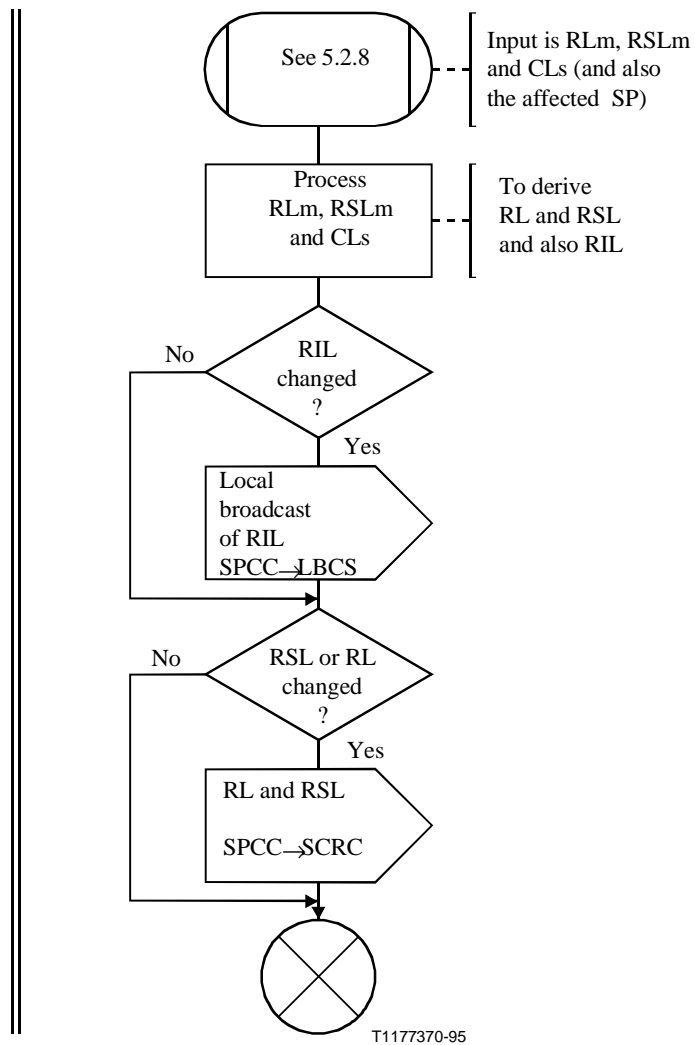
Figure D.4/Q.714 (sheet 2 of 4) – Signalling Point Congested Control (SPCC)

3  
2



T1177360-95

Figure D.4/Q.714 (sheet 3 of 4) – Signalling Point Congested Control (SPCC)



**Figure D.4/Q.714 (sheet 4 of 4) – Signalling Point Congested Control (SPCC)**

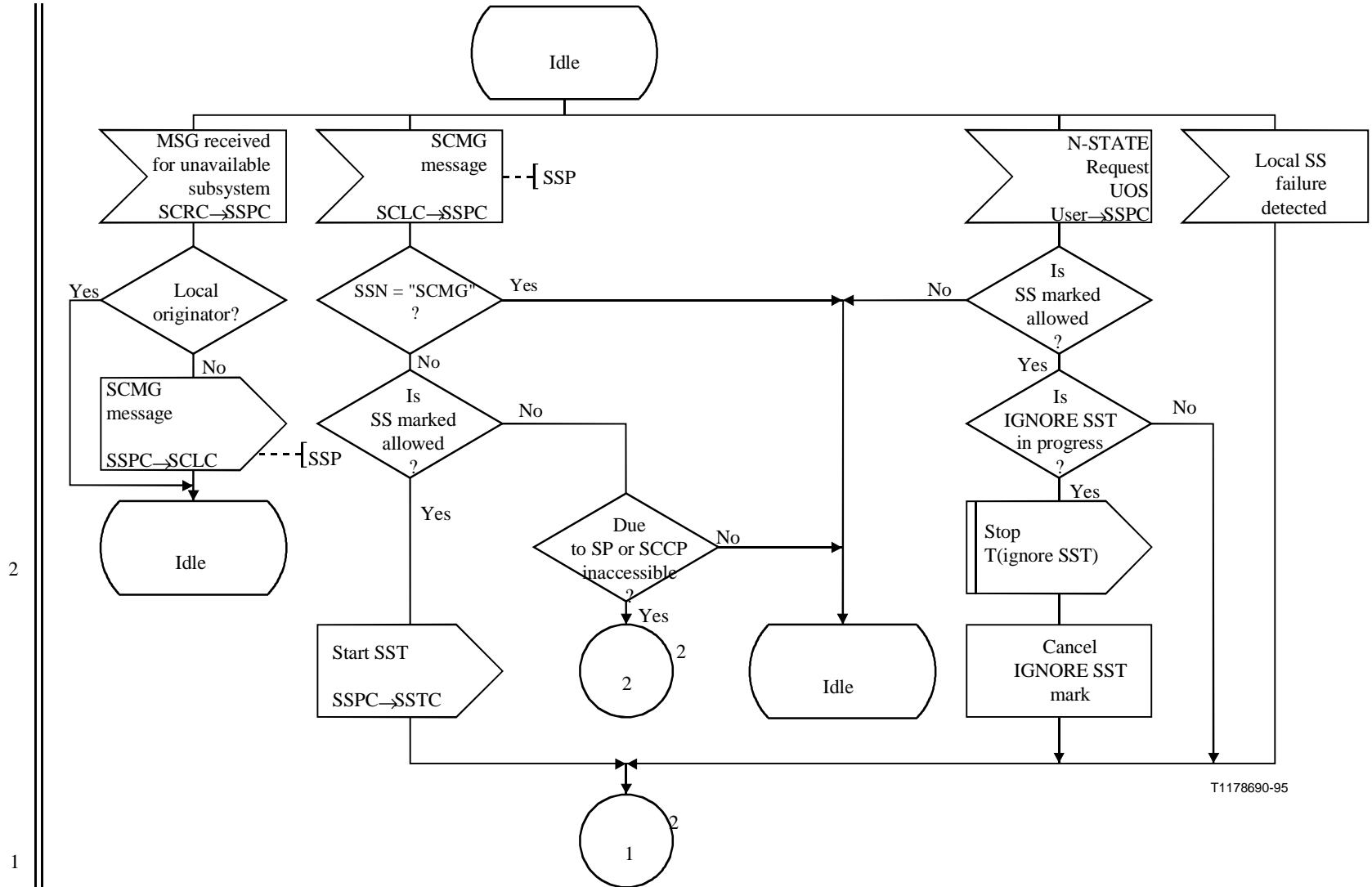
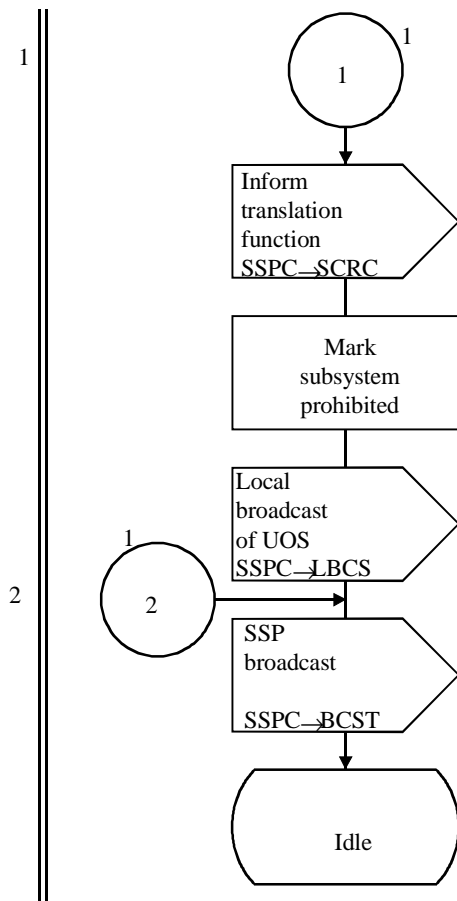


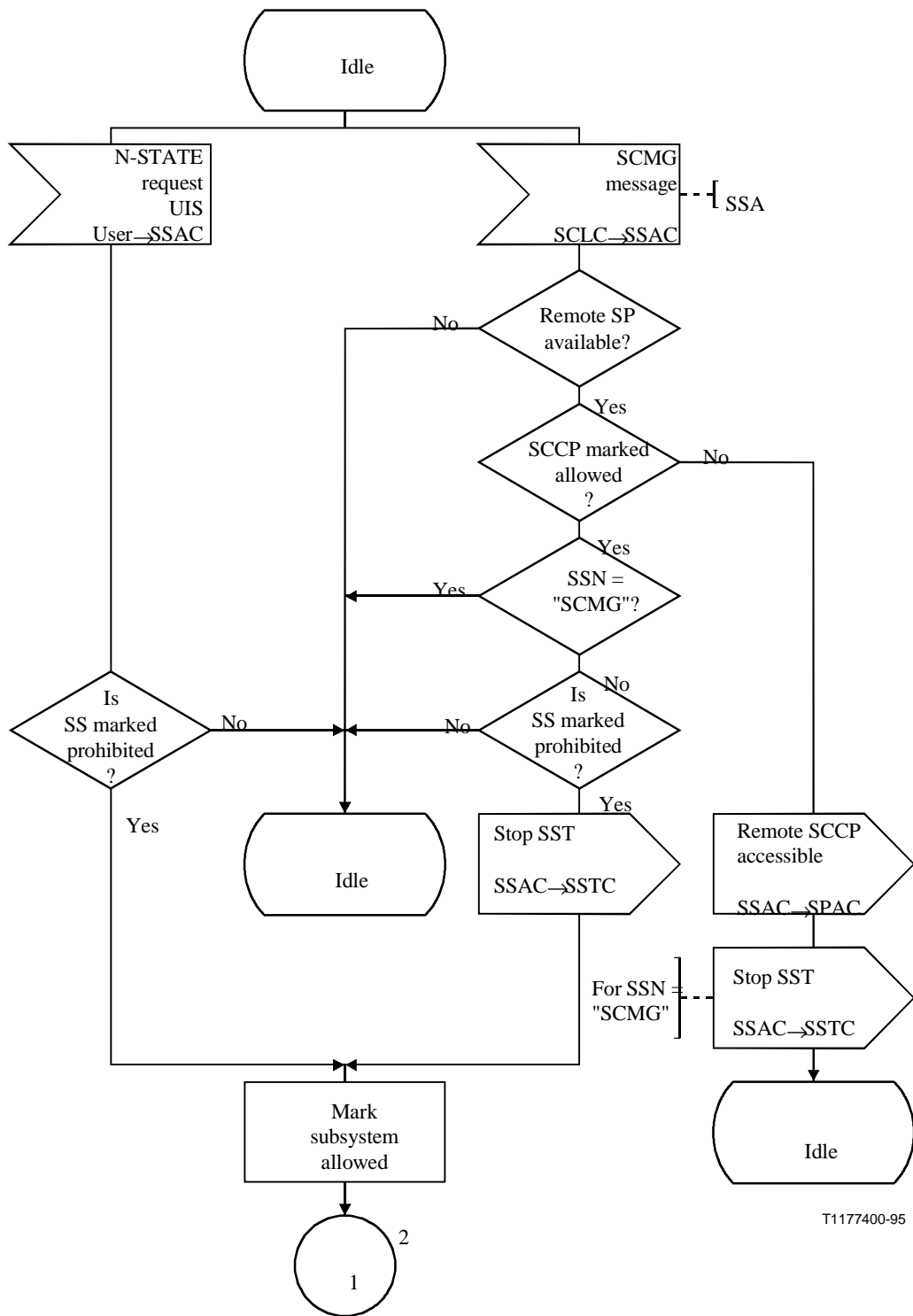
Figure D.5/Q.714 (Sheet 1 of 2) – SubSystem Prohibited Control (SSPC)

2  
1



T1177390-95

**Figure D.5/Q.714 (sheet 2 of 2) – SubSystem Prohibited Control (SSPC)**

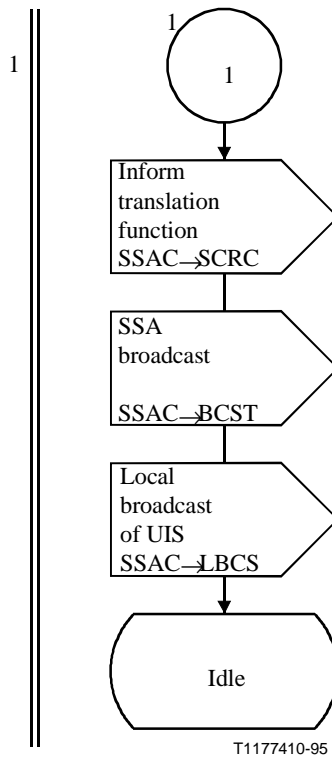


T1177400-95

1

Figure D.6/Q.714 (sheet 1 of 2) – SubSystem Allowed Control (SSAC)





**Figure D.6/Q.714 (sheet 2 of 2) – SubSystem Allowed Control (SSAC)**

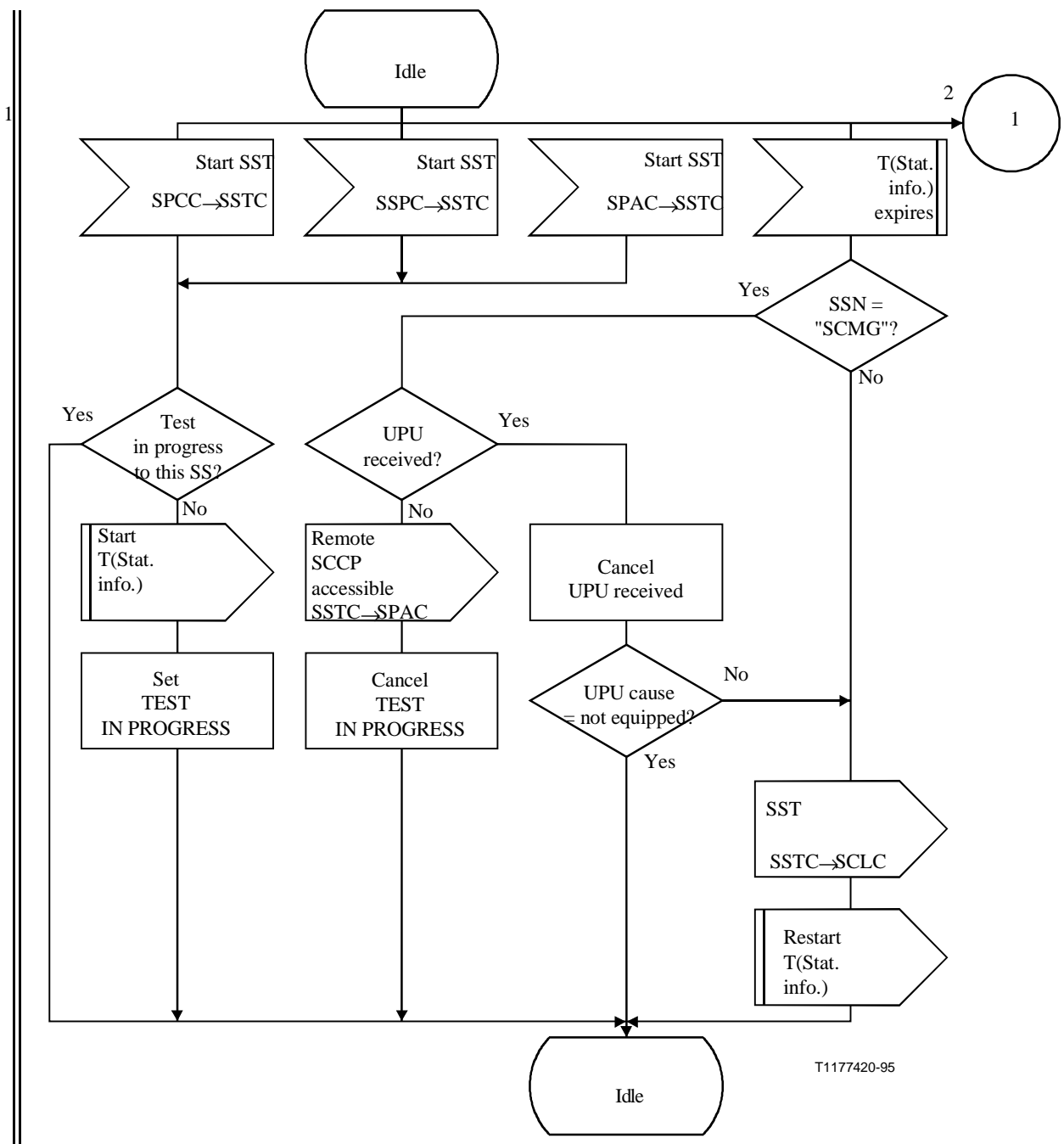
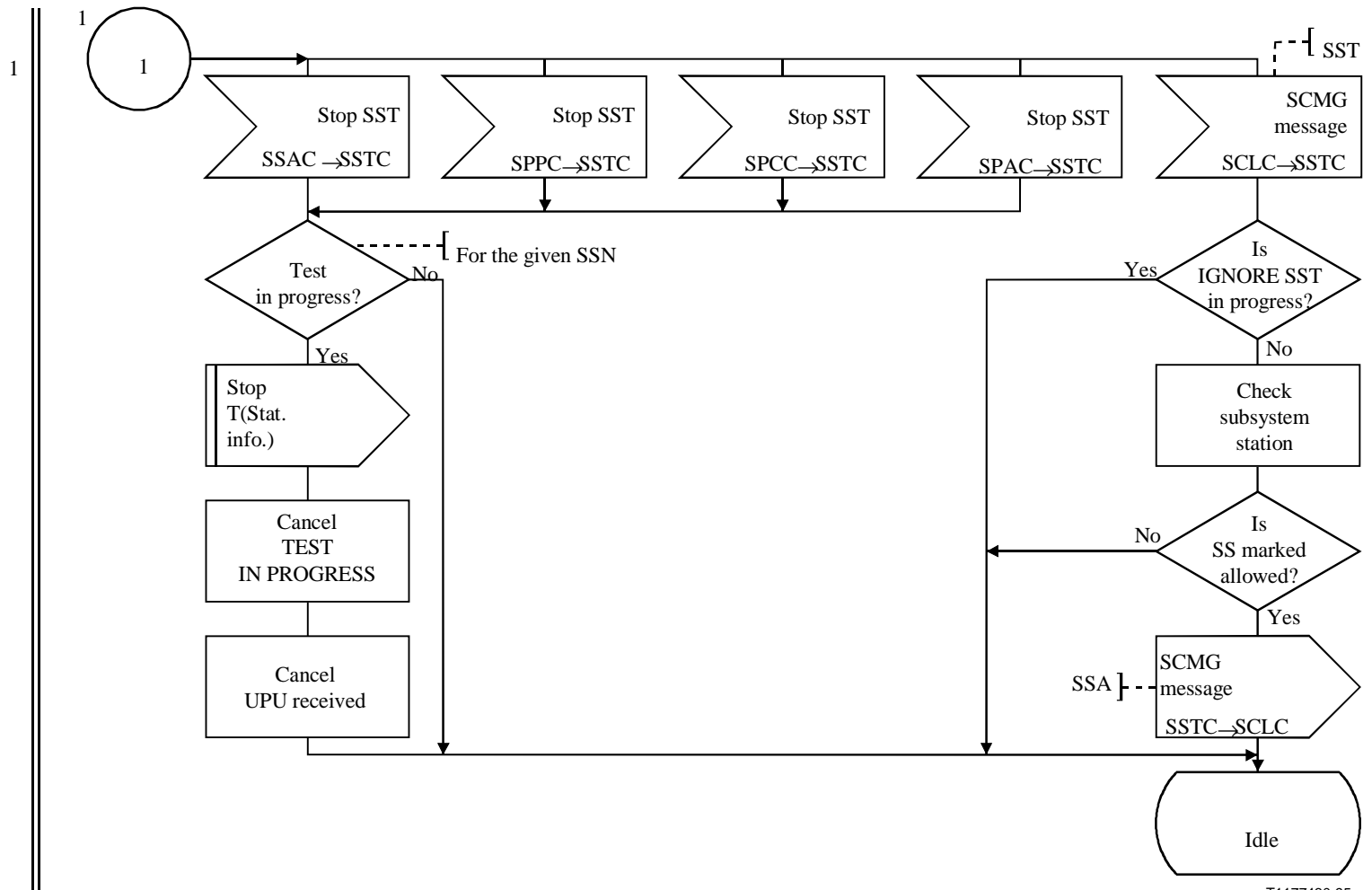
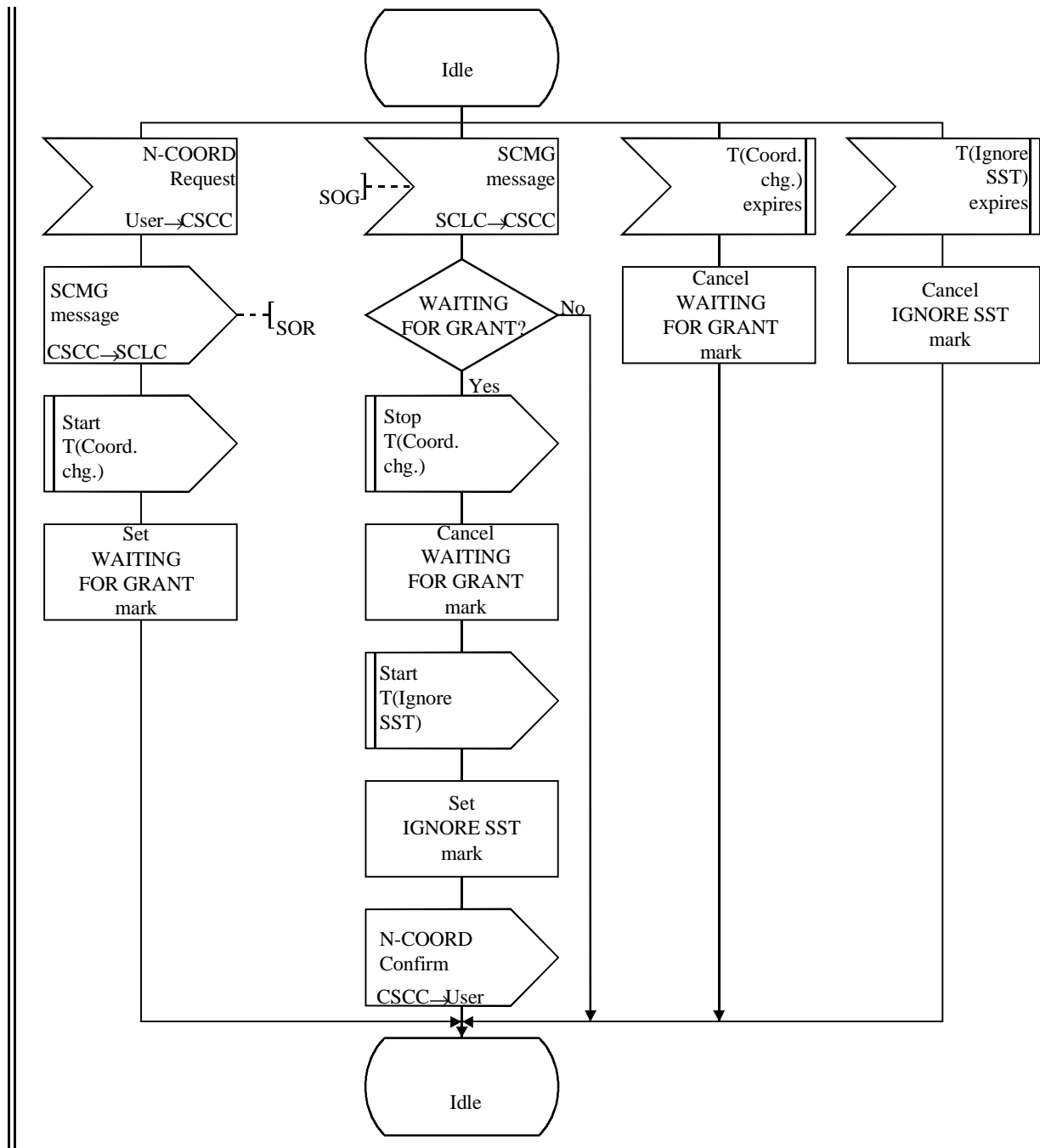


Figure D.7/Q.714 (sheet 1 of 2) – Subsystem Status Test Control (SSTC)

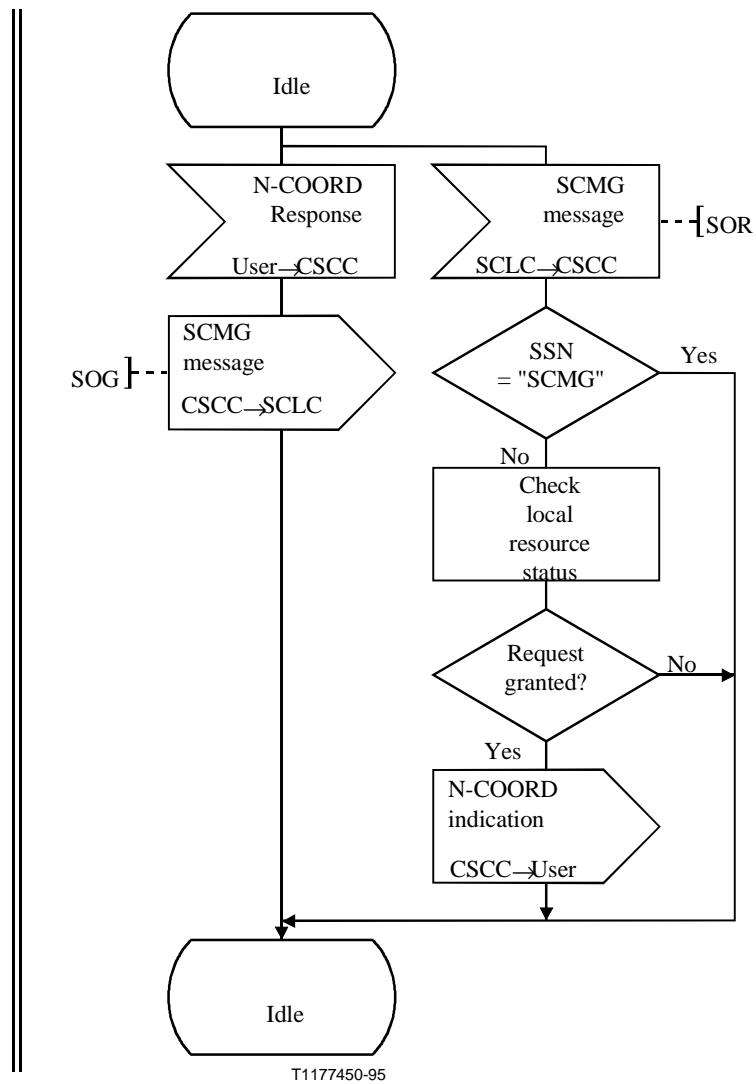


T1177430-95

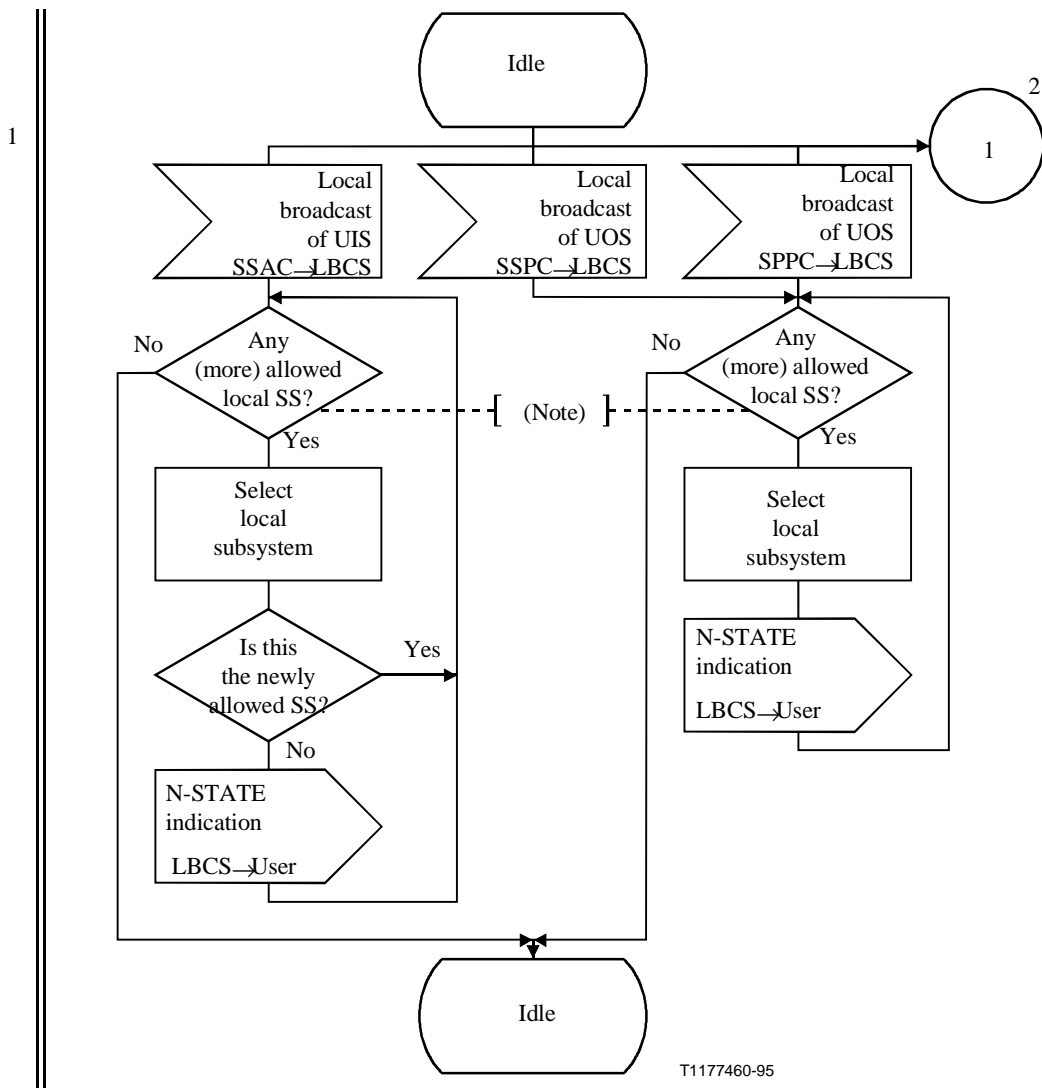
Figure D.7/Q.714 (sheet 2 of 2) – Subsystem Status Test Control (SSTC)



**Figure D.8/Q.714 (sheet 1 of 2) – Coordinated State Change Control (CSCC) at the requesting node**

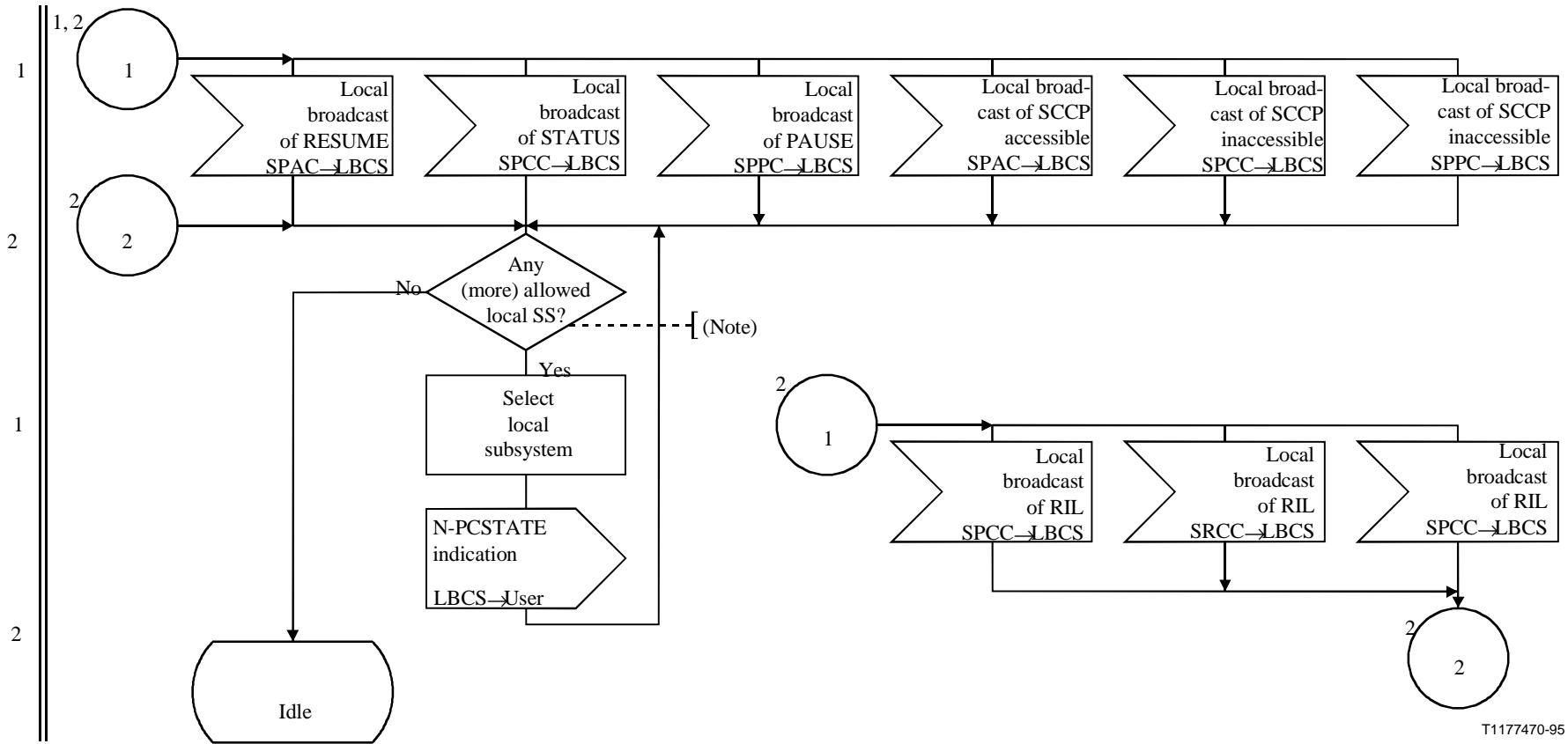


**Figure D.8/Q.714 (sheet 2 of 2) – Coordinated State Change Control (CSCC) at the granting node**



NOTE – As specified in 5.3.6.1, only concerned subsystems are informed.

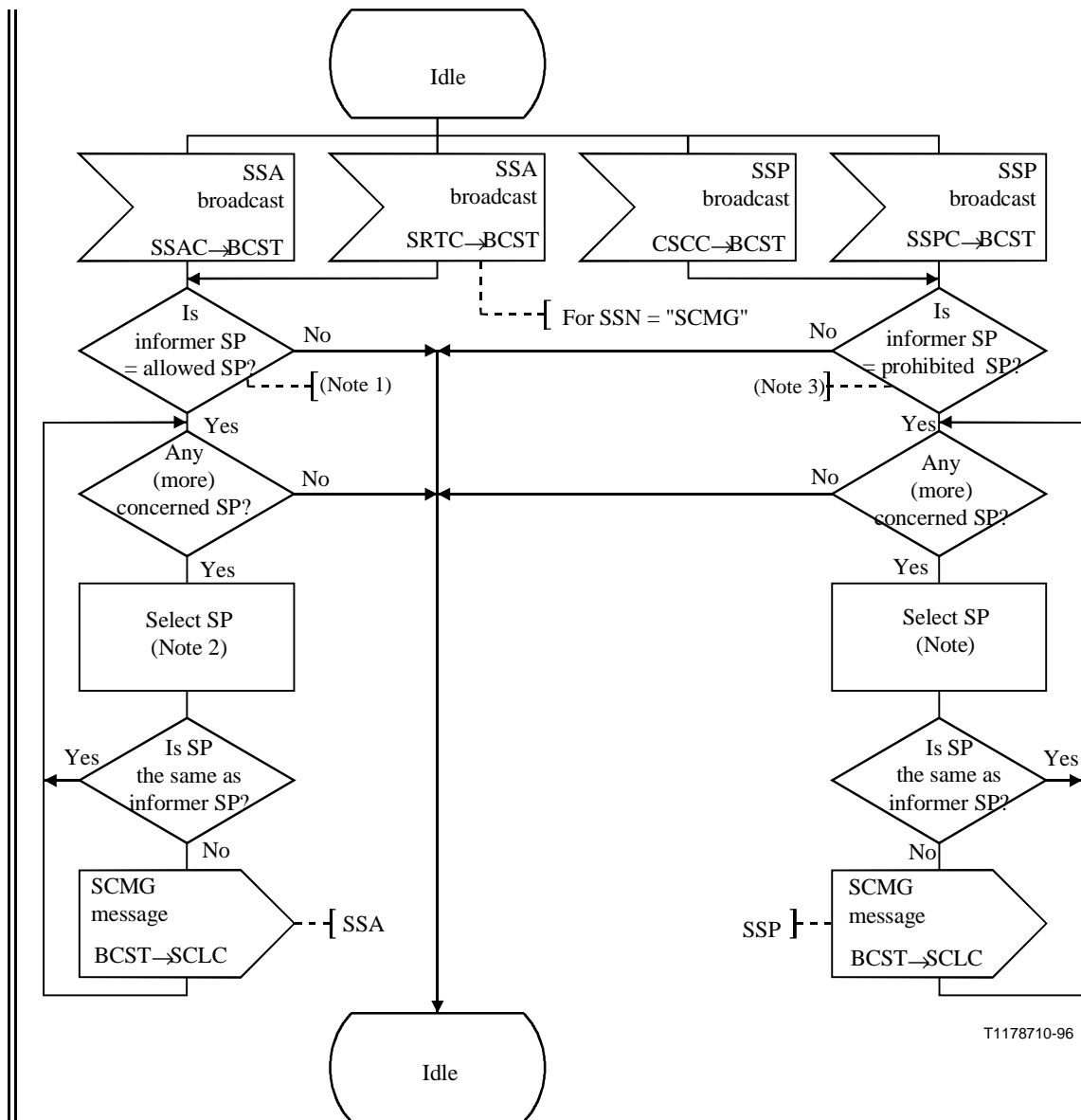
**Figure D.9/Q.714 (sheet 1 of 2) – Local broadcast (LBCS)**



T1177470-95

NOTE – As specified in 5.3.6.1, only concerned subsystems are informed.

Figure D.9/Q.714 (sheet 2 of 2) – Local broadcast (LBCS)



T1178710-96

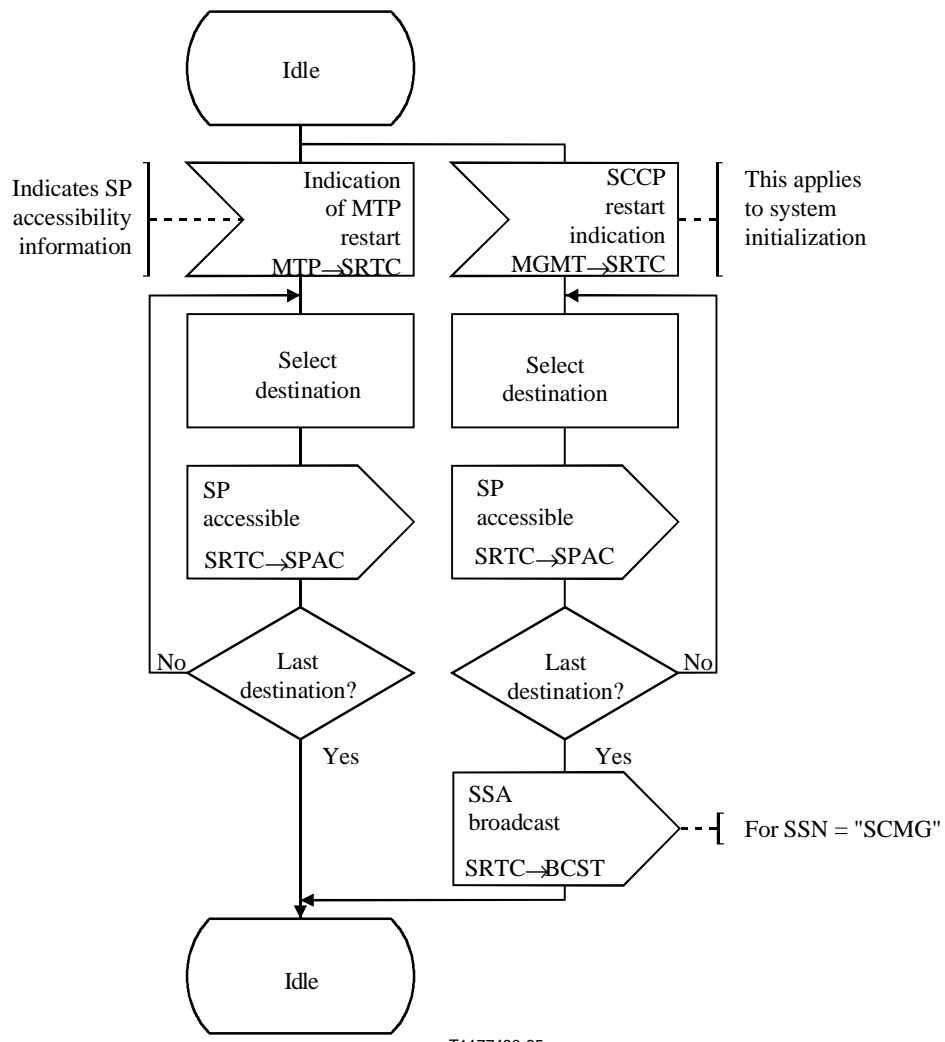
NOTE 1 – Is informer SP pointcode = allowed subsystem pointcode.

NOTE 2 – Consider all MTP networks, if caused by N-STATE indication; consider one MTP network, if caused by SSA or SSP.

NOTE 3 – Is informer SP pointcode = prohibited subsystem pointcode.

**Figure D.10/Q.714 – Broadcast (BCST)**





T1177490-95

Figure D.11/Q.714 – SCCP restart control (SRTC)

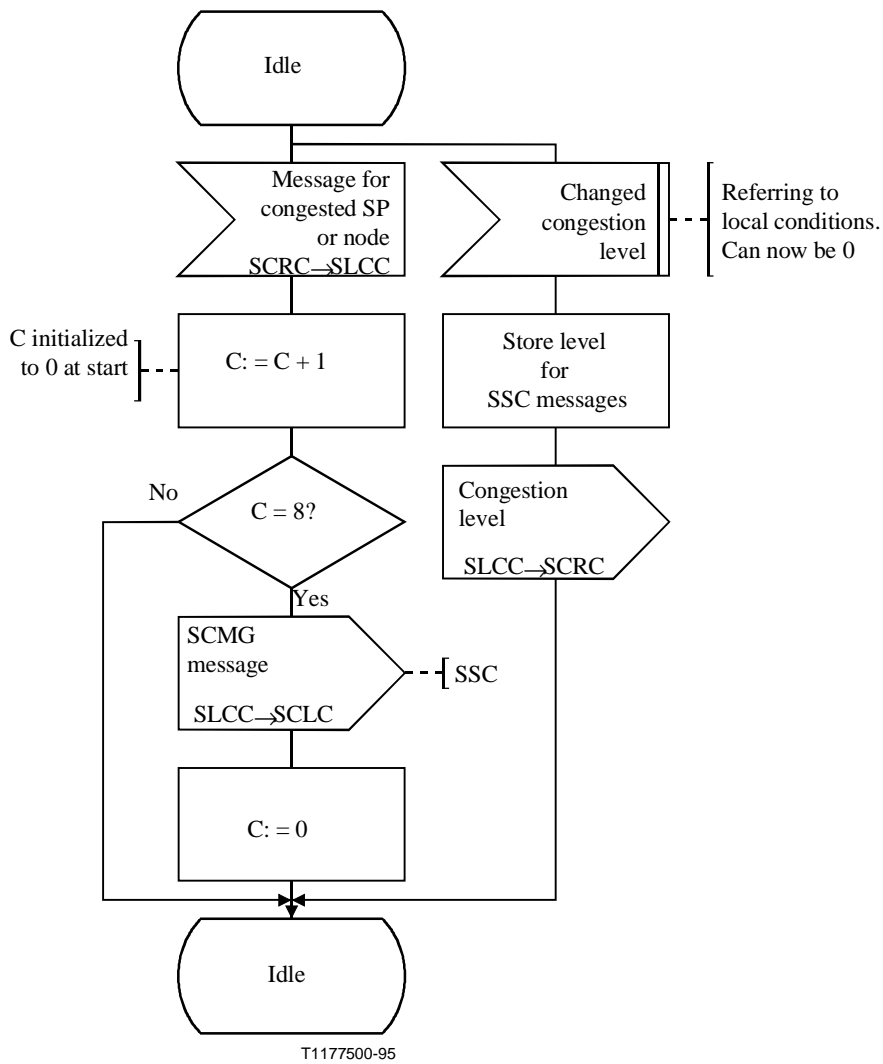
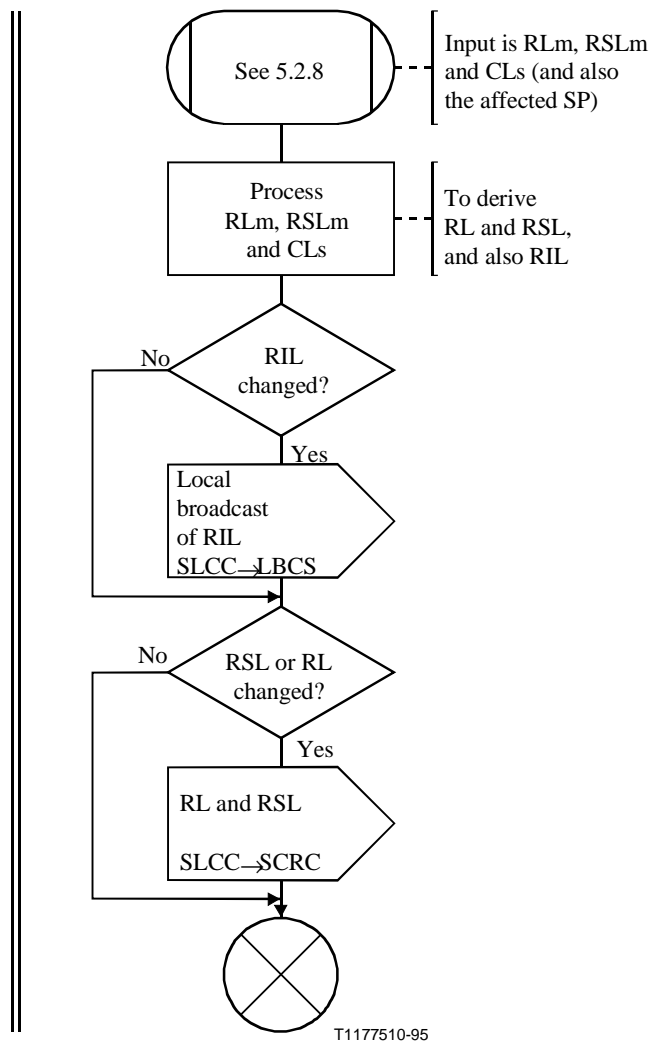


Figure D.12/Q.714 (sheet 1 of 2) – Local SCCP and nodal congestion control (SLCC)



**Figure D.12/Q.714 (sheet 2 of 2) – Local SCCP and nodal congestion control (SLCC)**

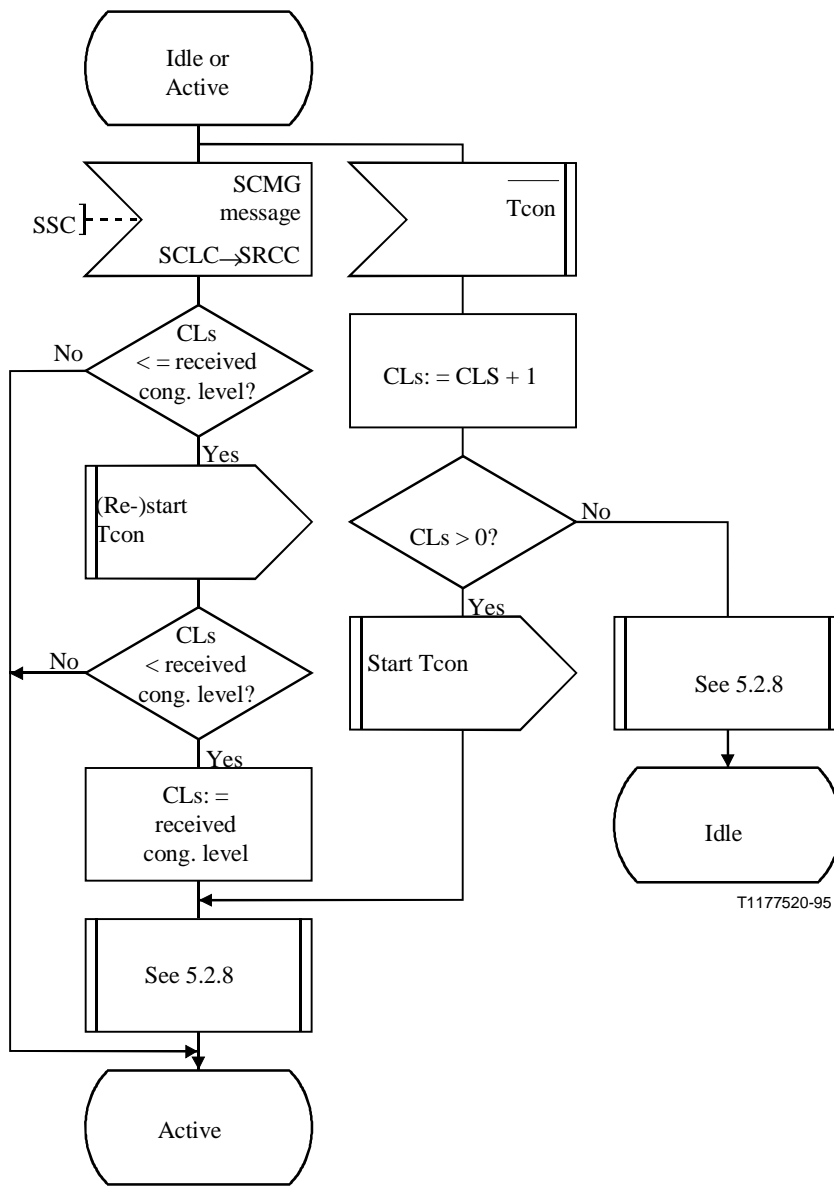


Figure D.13/Q.714 (sheet 1 of 2) – Remote SCCP and nodal congestion control (SRCC)

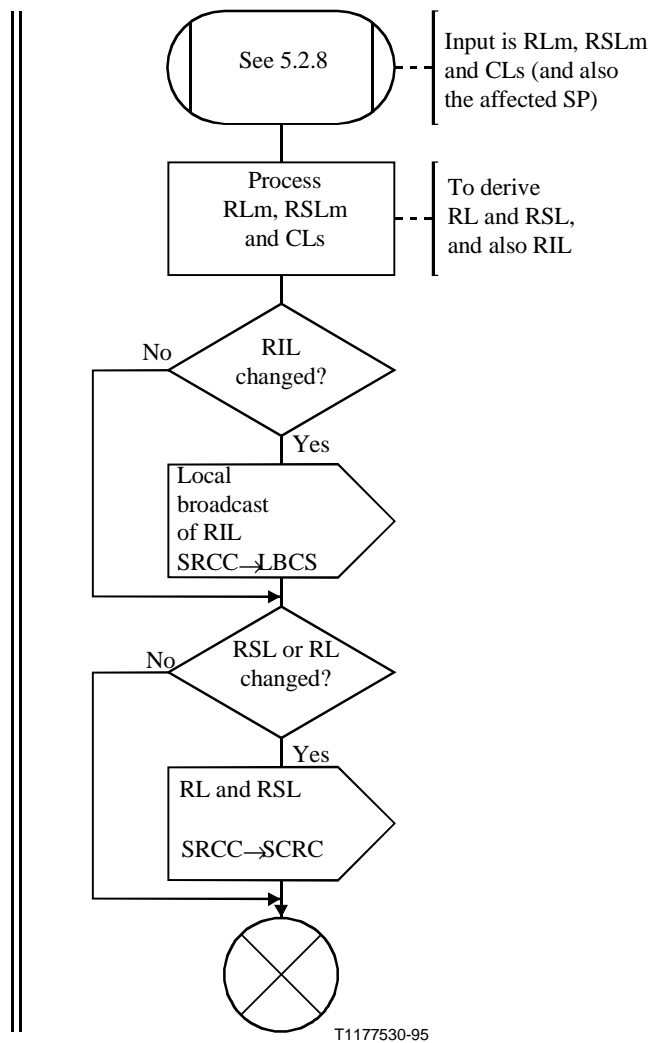


Figure D.13/Q.714 (sheet 2 of 2) – Remote SCCP and nodal congestion control (SRCC)



## ITU-T RECOMMENDATIONS SERIES

Series A	Organization of the work of the ITU-T
Series B	Means of expression
Series C	General telecommunication statistics
Series D	General tariff principles
Series E	Telephone network and ISDN
Series F	Non-telephone telecommunication services
Series G	Transmission systems and media
Series H	Transmission of non-telephone signals
Series I	Integrated services digital network
Series J	Transmission of sound-programme and television signals
Series K	Protection against interference
Series L	Construction, installation and protection of cables and other elements of outside plant
Series M	Maintenance: international transmission systems, telephone circuits, telegraphy, facsimile and leased circuits
Series N	Maintenance: international sound-programme and television transmission circuits
Series O	Specifications of measuring equipment
Series P	Telephone transmission quality
<b>Series Q</b>	<b>Switching and signalling</b>
Series R	Telegraph transmission
Series S	Telegraph services terminal equipment
Series T	Terminal equipments and protocols for telematic services
Series U	Telegraph switching
Series V	Data communication over the telephone network
Series X	Data networks and open system communication
Series Z	Programming languages