



INTERNATIONAL TELECOMMUNICATION UNION

ITU-T

TELECOMMUNICATION
STANDARDIZATION SECTOR
OF ITU

Q.705

(03/93)

**SPECIFICATIONS OF SIGNALLING
SYSTEM No. 7**

**SIGNALLING SYSTEM No. 7 –
SIGNALLING NETWORK STRUCTURE**

ITU-T Recommendation Q.705

(Previously “CCITT Recommendation”)

FOREWORD

The ITU Telecommunication Standardization Sector (ITU-T) is a permanent organ of the International Telecommunication Union. The ITU-T is responsible for studying technical, operating and tariff questions and issuing Recommendations on them with a view to standardizing telecommunications on a worldwide basis.

The World Telecommunication Standardization Conference (WTSC), which meets every four years, established the topics for study by the ITU-T Study Groups which, in their turn, produce Recommendations on these topics.

ITU-T Recommendation Q.705 was revised by the ITU-T Study Group XI (1988-1993) and was approved by the WTSC (Helsinki, March 1-12, 1993).

NOTES

1 As a consequence of a reform process within the International Telecommunication Union (ITU), the CCITT ceased to exist as of 28 February 1993. In its place, the ITU Telecommunication Standardization Sector (ITU-T) was created as of 1 March 1993. Similarly, in this reform process, the CCIR and the IFRB have been replaced by the Radiocommunication Sector.

In order not to delay publication of this Recommendation, no change has been made in the text to references containing the acronyms "CCITT, CCIR or IFRB" or their associated entities such as Plenary Assembly, Secretariat, etc. Future editions of this Recommendation will contain the proper terminology related to the new ITU structure.

2 In this Recommendation, the expression "Administration" is used for conciseness to indicate both a telecommunication administration and a recognized operating agency.

© ITU 1994

All rights reserved. No part of this publication may be reproduced or utilized in any form or by any means, electronic or mechanical, including photocopying and microfilm, without permission in writing from the ITU.

CONTENTS

	<i>Page</i>
1 Introduction	1
2 Network components	1
2.1 Signalling links	1
2.2 Signalling points	1
3 Structural independence of international and national signalling networks	2
4 Considerations common to both international and national signalling networks	3
4.1 Availability of the network	3
4.2 Message transfer delay	3
4.3 Message sequence control	3
4.4 Number of signalling links used in load sharing	3
4.5 Satellite working	3
5 International signalling network	4
5.1 General	4
5.2 Number of signalling transfer points in signalling relations	4
5.3 Numbering of signalling points	4
5.4 Routing rules	4
5.5 Structures	4
5.6 Procedures	4
6 Signalling network for cross-border traffic	5
6.1 General	5
6.2 Use of international hierarchical level	5
6.3 Integrated numbering of national signalling networks	5
6.4 Interworking of national signalling networks	5
7 National signalling network	5
8 Procedures prevent unauthorized use of an STP (optional)	5
8.1 General	5
8.2 Identifying unauthorized SS No. 7 messages	6
8.3 Treatment of unauthorized SS No. 7 messages	6
8.4 Measurements	6
8.5 Notification to unauthorized user	6
9 SS No. 7 Planning Tools	7
Annex A – Mesh signalling network examples	7
A.1 General	7
A.2 Basic network structures (example)	7
A.3 Routing	9
A.4 Actions relating to failure conditions	17
A.5 Explanatory note from the implementors forum for clarification of load sharing	22

SIGNALLING SYSTEM No. 7 – SIGNALLING NETWORK STRUCTURE

(Geneva, 1980; modified at Helsinki, 1993)

1 Introduction

This Recommendation describes aspects which are pertinent to and should be considered in the design of international Signalling System No. 7 (SS No. 7) signalling networks. Some or all of these aspects may also be relevant to the design of national networks. Some aspects are dealt with for both international and national networks (e.g. availability), others are discussed in the context of the international network only (e.g. the number of *signalling transfer points* in a signalling relation). A number of aspects require further study for national networks. This Recommendation also gives in Annex A examples of how the signalling network procedures may be applied to the mesh network representation.

The national and international networks are considered to be structurally independent and, although a particular *signalling point* may belong to both networks, signalling points are allocated *signalling point codes* according to the rules of each network.

The signalling network procedures are provided in order to effectively operate a signalling network having different degrees of complexity. They provide for reliable message transfer across the network and for reconfiguration of the network in the case of failures.

The most elementary signalling network consists of *originating and destination signalling points* connected by a single *signalling link*. To meet availability requirements this may be supplemented by additional links in parallel which may share the signalling load between them. If, for all signalling relations, the originating and destination signalling points are directly connected in this way in a network, then the network operates in the *associated mode*.

For technical or economic reasons a simple associated network may not be suitable and a *quasi-associated network* may be implemented in which the information between originating and destination signalling points may be transferred via a number of signalling transfer points. Such a network may be represented by a *mesh network* such as that given in Annex A, as other networks are either a subset of the mesh network or are structured using this network or its subsets as components.

2 Network components

2.1 Signalling links

Signalling links are basic components in a signalling network connecting together signalling points. The signalling links encompass the *level 2* functions which provide for message error control (detection and subsequent correction). In addition, provision for maintaining the correct message sequence is provided (see Recommendation Q.703).

2.2 Signalling points

Signalling links connect signalling points at which signalling network functions such as message routing are provided at *level 3* and at which the user functions may be provided at *level 4* if it is also an originating or destination point (see 2.4/Q.704).

A signalling point that only transfers messages from one signalling link to another at level 3 serves as a signalling transfer point (STP).

The signalling links, signalling transfer points, and signalling (originating or destination) points may be combined in many different ways to form a *signalling network*.

3 Structural independence of international and national signalling networks

The worldwide signalling network is structured into two functionally independent levels, namely the international and national levels, as illustrated in Figure 1. This structure makes possible a clear division of responsibility for signalling network management and allows numbering plans of signalling points of the international network and the different national networks to be independent of one another.

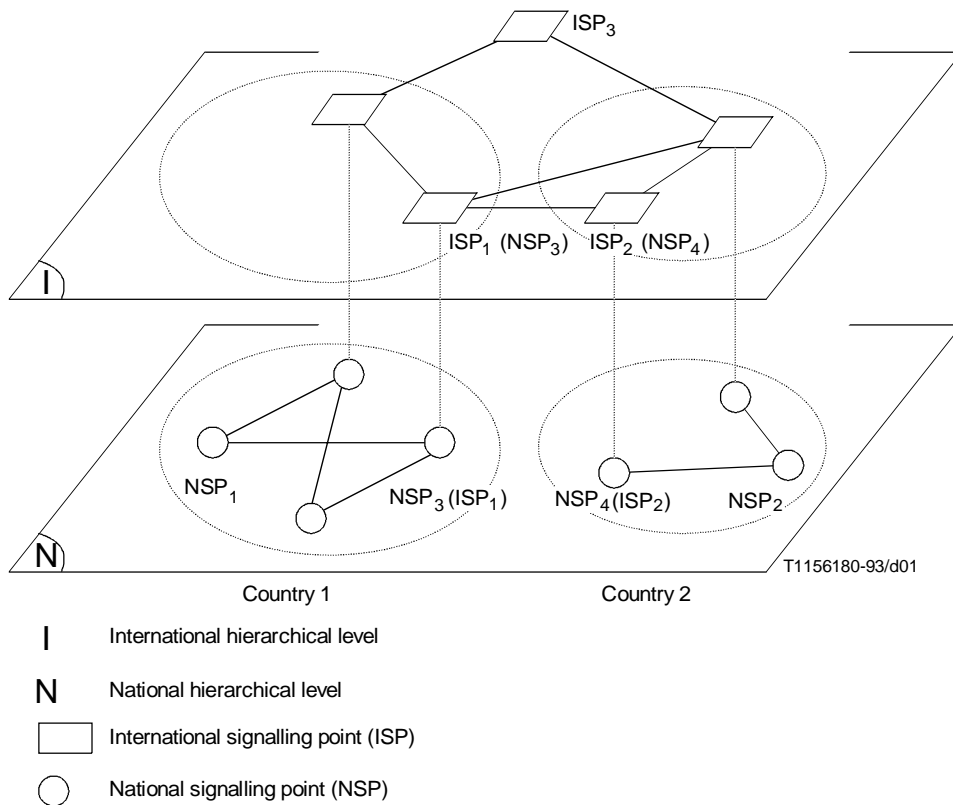

FIGURE 1/Q.705

International and national signalling networks

A signalling point (SP), including a signalling transfer point (STP), may be assigned to one of three categories:

- national signalling point (NSP) (signalling transfer point) which belongs to the national signalling network only (e.g. NSP₁) and is identified by a signalling point code (OPC or DPC) according to the national numbering plan of signalling points;
- international signalling point (ISP) (signalling transfer point) which belongs to the international signalling network only (e.g. ISP₃) and is identified by a signalling point code (OPC or DPC) according to the international numbering plan of signalling points;
- a node that functions both as an international signalling point (signalling transfer point) and a national signalling point (signalling transfer point) and therefore belongs to both the international signalling network and a national signalling network and accordingly is identified by a specific signalling point code (OPC or DPC) in each of the signalling networks.

If a discrimination between international and national signalling point codes is necessary at a signalling point, the network indicator is used (see 14.2/Q.704).

4 Considerations common to both international and national signalling networks

4.1 Availability of the network

The signalling network structure must be selected to meet the most stringent availability requirements of any User Part served by a specific network. The availability of the individual components of the network signalling links (signalling points and signalling transfer points) must be considered in determining the network structure (see Recommendation Q.709).

Considerable attention is required to STP routing tables to ensure that circular routing does not occur. (See Annex A/Q.780 – Testing and Planning Tools.)

4.2 Message transfer delay

In order to take account of signalling message delay considerations, regard should be given, in the structuring of a particular signalling network, to the overall number of signalling links (where there are a number of signalling relations in tandem) related to a particular user transaction (e.g. to a specific call in the telephone application) (see Recommendation Q.709).

4.3 Message sequence control

For all messages for the same transaction (e.g. a telephone call) the MTP will maintain the same routing provided that the same *signalling link selection* code is used in the absence of failure. However, a transaction does not necessarily have to use the same signalling route for both forward and backward messages.

4.4 Number of signalling links used in load sharing

The number of signalling links used to share the load of a given flow of signalling traffic typically depends on

- the total traffic load;
- the availability of the links;
- the required availability of the path between the two signalling points concerned; and
- the bit rate of the signalling links.

Load sharing requires at least two signalling links for all bit rates, but more may be needed at lower bit rates.

When two links are used, each of them should be able to carry the total signalling traffic in case of failure of the other link. When more than two links are used, sufficient reserve link capacity should exist to satisfy the availability requirements specified in Recommendation Q.706.

4.5 Satellite working

The service performance criteria and network operation aspects require balanced consideration in structuring SS No. 7 networks. Despite the relatively long delay of satellite connections, these connections can also be suitable for providing signalling data links.

Especially for long distance international operation, transmission diversity (including satellites) is an important criterion in structuring SS No. 7 networks from a network availability and reliability point of view.

In international operation, a terrestrial signalling data link using the basic error correction method may be restored, in exceptional circumstances and with bilateral agreement, by using a satellite data link. If this is done, the following precautions should be taken into account:

- in order to ensure in these circumstances the correct operation of the basic error correction method over the satellite data link, timer T7 (12.3/Q.703), at both ends of the restored signalling link, should have a value of at least 800 ms;
- in order to take into account the additional delay caused by the satellite data link, the minimum values of the timers T1–T6, specified in 16.8/Q.704, should take the specified values for routes with long propagation delays;
- the bit error rate guaranteed by the satellite link used is of significant influence. If the bit error rate is worse than 10^{-7} , the dimensioning of the link loads should consider from the beginning the possibly lower loading potential of a satellite link (see 5/Q.706).

The calculation of the value N2 (the number of message signal unit octets available for retransmission in the PCR error correction method (see 6.4.2/Q.703) should take a signalling loop delay $T_{(L)}$ range, depending on the geographical conditions, between a minimum of 480 ms and a maximum of 600 ms.

5 International signalling network

5.1 General

The international signalling network will use the procedures to be defined in the SS No. 7 Recommendations. The international network structure to be defined can also serve as a model for the structure of national networks.

5.2 Number of signalling transfer points in signalling relations

In the international signalling network the number of signalling transfer points between an originating and a destination signalling point should not exceed two in a normal situation. In failure situations, this number may become three or even four for a short period of time. This constraint is intended to limit the complexity of the administration of the international signalling network.

5.3 Numbering of signalling points

A 14-bit code is used for the identification of signalling points. The allocation scheme of international signalling point codes is defined in Recommendation Q.708.

5.4 Routing rules

5.4.1 In order to ensure full flexibility for the routing of signalling in the SS No. 7 international signalling network it appears desirable that at least one signalling point in each country should provide means for the international STP function. Such an approach should ease the use of SS No. 7 on small traffic routes.

5.4.2 Other routing rules

For further study.

5.5 Structures

Requires further study.

5.6 Procedures

Requires further study.

6 Signalling network for cross-border traffic

6.1 General

For cross-border traffic between signalling points, the need for a special signalling network configuration is identified, because their common interests are such as to generate a considerable volume of traffic between them.

Two alternative arrangements of the signalling network for cross-border traffic are provided so that Administrations may adopt either alternative upon a bilateral agreement.

6.2 Use of international hierarchical level

6.2.1 This arrangement could be applied in the case that there are only a relatively small number of signalling points in a country which serve for cross-border traffic.

6.2.2 The signalling points and the signalling transfer points which are involved in a signalling of cross-border traffic should belong to the international hierarchical level described in 3. When those signalling points or signalling transfer points are also involved in signalling of national traffic, they should belong to their national hierarchical level as well. Therefore the double numbering of signalling point codes based on both the international and national numbering schemes should be required.

6.2.3 A discrimination between international and national point codes is made by the network indicator in the service information octet (see 14.2/Q.704).

6.2.4 Signalling network management procedures in this network arrangement require further study.

6.3 Integrated numbering of national signalling networks

6.3.1 By this arrangement the signalling points, which serve cross-border traffic, should be identified by common national signalling point codes.

6.3.2 Common block of national signalling point codes is provided by bilateral agreement (further study is required).

6.4 Interworking of national signalling networks

At the cross-border signalling network interface, the international specification of SS No. 7 should be preferred without exclusion of bilateral agreements.

7 National signalling network

No specific structures for national signalling networks are included in this Recommendation; however, Administrations should cater for the requirements imposed on a national network for the protection of international services in terms of network related user requirements, such as availability and performance of the network perceived by users (see Recommendation Q.709).

8 Procedures prevent unauthorized use of an STP (optional)

8.1 General

Administrations may make bilateral agreements to operate SS No. 7 between their networks. These agreements may place restrictions on the SS No. 7 messages authorized for one Administration to send to the other. Restrictions could be made, for example, in the interest of network security or as a result of service restrictions. Unauthorized signalling traffic may be, for example, STP traffic for calls set-up via networks other than that containing the STP, which has not been agreed bilaterally.

An Administration making an agreement with restrictions may wish to identify and provide special treatment to unauthorized SS No. 7 messages.

The measurements in Table 6/Q.752 provide some capability to identify unauthorized SS No. 7 messages. The procedures described in this clause for identifying and responding to unauthorized traffic are additional options for use at an STP with signalling links to other networks.

8.2 Identifying unauthorized SS No. 7 messages

In addition to the normal signalling message handling, procedures specified in Recommendation Q.704, it shall be possible to inhibit/allow messages destined for another signalling point (SP) based on any one or combination of the following options:

- i) To inhibit/allow STP access by a combination of designated incoming link sets to designated DPCs.

This combination of DPC/incoming link set shall effectively operate in the form of a single matrix. This matrix shall consist of a maximum of 128 DPCs and a maximum of 64 incoming link sets. (These values are for guidance and may be adjusted to satisfy the requirements of the concerned Operator/Administration.)

- ii) To inhibit/allow STP access by a combination of designated outgoing link sets to designated DPCs.

This combination of DPC/outgoing link set shall effectively operate in the form of a single matrix. This matrix shall consist of a maximum of 128 DPCs and a maximum of 64 outgoing link sets. (These values are for guidance and may be adjusted to satisfy the requirements of the concerned Operator/Administration.)

- iii) To inhibit/allow STP access by examination of OPC and DPC combination in the incoming STP message.

This combination of DPC/OPC shall effectively operate in the form of a single matrix. This matrix shall consist of a maximum of 128 DPCs and a maximum of 128 OPCs. (These values are for guidance and may be adjusted to satisfy the requirements of the concerned Operator/Administration.)

8.3 Treatment of unauthorized SS No. 7 messages

An STP identifying unauthorized SS No. 7 messages should be able, on a per link set or per signalling point code basis, to

- i) provide all unauthorized SS No. 7 messages with the same handling as authorized traffic; or
- ii) discard all unauthorized SS No. 7 messages.

In addition, an STP should be able to

- i) allow all STP messages outside the designated ranges as given in 8.2;
- ii) bar (discard) all STP messages outside the designated ranges as given in 8.2.

8.4 Measurements

An STP identifying unauthorized SS No. 7 messages incoming from another network should be able to count and record details of the unauthorized messages on a per link set and/or signalling point code basis.

8.5 Notification to unauthorized user

An STP identifying unauthorized SS No. 7 messages from another network may wish to notify the Administration originating the unauthorized message(s).

This notification should be undertaken by administrative means and not involve any mechanism in SS No. 7.

In addition, a violation fault report shall be issued giving the unauthorized message content. It shall be possible to selectively restrict the number of violation reports on a per link set and/or signalling point code basis.

It shall also be possible to inhibit the violation reporting mechanism on a point code/link set basis, nodally, or on a message direction, i.e. if an inhibited message is destined for an ROA, then it shall be possible to suppress the violation reports whilst allowing violation reports on inhibited messages from the ROA.

9 SS No. 7 Planning Tools

Annex A/Q.780 contains brief descriptions of some SS No. 7 Planning Tools.

Annex A

Mesh signalling network examples

(This annex forms an integral part of this Recommendation)

A.1 General

This annex is provided to demonstrate the procedures defined in Recommendation Q.704. While the example uses a specific *mesh* network to demonstrate the procedures, it is not the intent of this annex to recommend either implicitly or explicitly, the network described.

The *mesh* network is used to demonstrate the MTP level 3 procedures because it is thought to be a possible international network implementation as shown on it, or subsets of it, may be used to construct other network structures.

A.2 Basic network structures (example)

Figure A.1 shows the basic mesh network structure, while three simplified versions derived from this basic network structure are shown in Figure A.2. More complex signalling networks can be built, using these as building components.

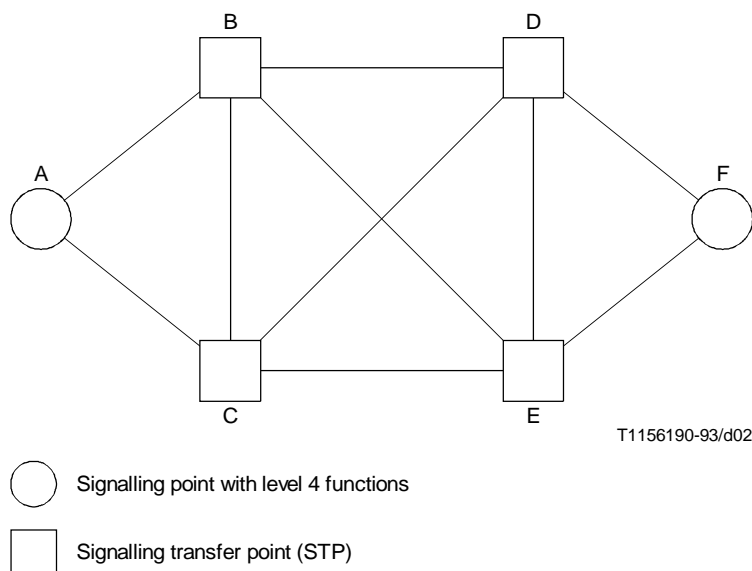
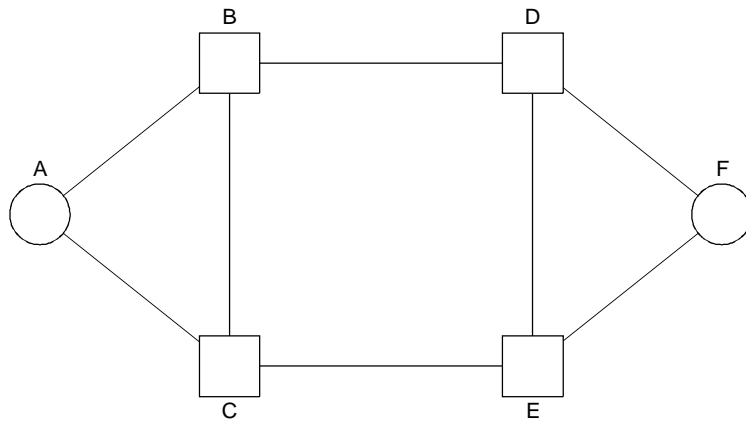
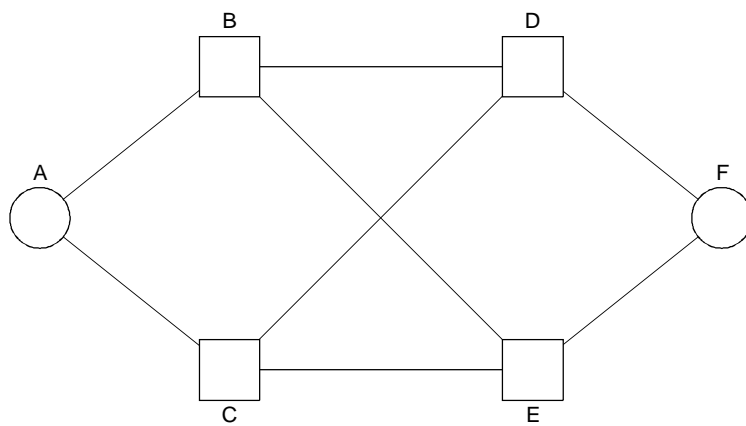

FIGURE A.1/Q.705
Basic mesh network



a) Two out of four inter-STP link sets deleted



b) Link sets between STPs of the same pair deleted

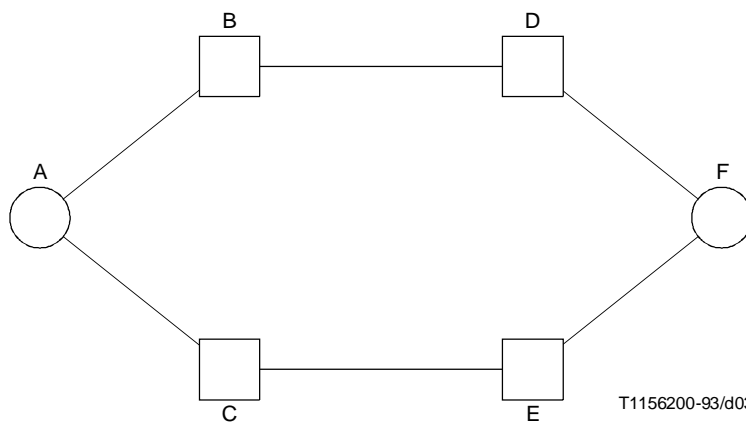

c) Two out of four inter-STP link sets and link sets between STPs of the same pair deleted

FIGURE A.2/Q.705
Simplified versions of the basic mesh network

In the following, the basic mesh network Figure A.1 is taken as an example to explain the procedures defined in Recommendation Q.704.

In this network, each signalling point with level 4 functions is connected by two link sets to two signalling transfer points. Each pair of signalling transfer points is connected to each other pair by four link sets. Moreover, there is a link set between the two signalling transfer points of each pair.

The simplified versions a), b) and c) of the basic signalling network are obtained by deleting respectively:

- a) two out of four intersignalling transfer point link sets;
- b) link sets between signalling transfer points of the same pair; and
- c) a) and b) together.

It should be noted that for a given signalling link availability, the more signalling link sets removed from the basic signalling network (e.g. in going from Figure A.1 to Figure A.2), the lower the availability of the signalling network. However, an increase in the availability of the simplified signalling networks may be attained by adding one or more parallel signalling links to each of the remaining signalling link sets.

A.3 Routing

A.3.1 General

This subclause gives some routing examples in the basic mesh network in Figure A.1. Routing actions required to change message routes under failure conditions are described in A.4. The following routing principles are assumed for the examples in this subclause:

- Message routes should pass through a minimum number of intermediate signalling transfer points.
- Routing at each signalling point will not be affected by message routes used up to the concerned signalling transfer points.
- When more than one message route is available, signalling traffic should be load-shared by such message routes.
- Messages relating to a given user transaction and sent in a given direction will be routed over the same message route to ensure correct message sequence.

A.3.2 Routing in the absence of failures

Figure A.3 illustrates an example of routing in the absence of failures for messages from signalling point A to signalling point F.

The following points are worthy of note:

- a) In distributing traffic for load-sharing at the originating signalling point and intermediate signalling transfer points, care should be taken in the use of signalling link selection (SLS) codes so that traffic will be distributed over four available routes evenly. In the example, originating signalling point A uses the second least significant bit of the signalling link selection code, and signalling transfer points B and C the least significant bit.
- b) Other than that described above, the choice of a particular link for a given signalling link selection code can be made at each signalling point independently. As a result, message routes for a given user transaction (e.g. SLS = 0010) in two directions may take different paths (e.g. A -> C -> D -> F and F -> E -> B -> A).
- c) Links BC and DE are not used in the absence of failures. They will be used in certain failure situations described in A.4.
- d) When the number of links in a link set is not a power of 2 (i.e. 1, 2, 4, 8), SLS load sharing does not achieve even distribution of traffic across the individual links.

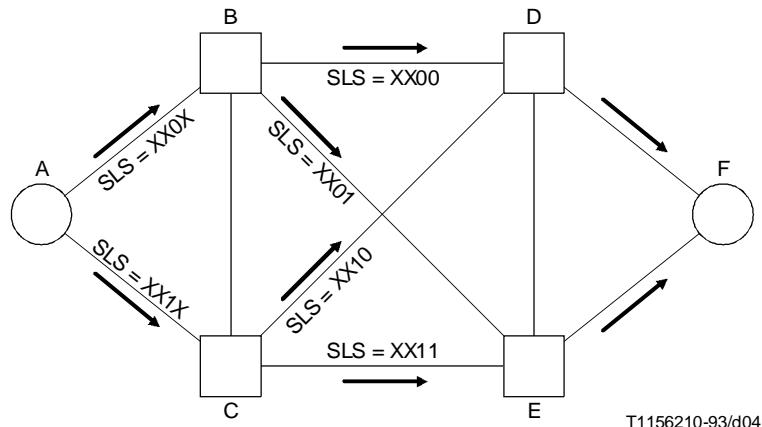

T1156210-93/d04

Normal message routes from A to F:

- A → B → D → F (SLS = XX00)
- A → C → D → F (SLS = XX10)
- A → B → E → F (SLS = XX01)
- A → C → E → F (SLS = XX11)

SLS Signalling link selection code in the routing label
 Assumption There is only one link between adjacent signalling points

FIGURE A.3/Q.705
 An example of routing in the absence of failures

A.3.3 Routing under failure conditions

A.3.3.1 Alternative routing information

In order to cope with failure conditions that may arise, each signalling point has alternative routing information which specifies, for each normal link set, alternative link set(s) to be used when the former become(s) unavailable (see 4.2/Q.704).

Table A.1 gives, as an example, a list of alternative link sets for all normal link sets at signalling point A and at signalling transfer point B. In the basic mesh network, all link sets except those between signalling transfer points of the same pair are normal links which carry signalling traffic in the absence of failures. In case a normal link set becomes unavailable, signalling traffic formerly carried by that link set should be diverted to the alternative link set with priority 1. Alternative link sets with priority 2 (i.e. link sets between signalling transfer points of the same pair) will be used only when both the normal link set and alternative link set(s) with priority 1 become unavailable.

Subclauses A.3.3.2 to A.3.3.5 present some typical examples of the consequences of faults in signalling links and signalling points on the routing of signalling traffic. For the sake of simplicity, link sets are supposed to consist of only one link each.

A.3.3.2 Single link failure examples

Example 1: Failure of a link between a signalling point and a signalling transfer point (e.g. link AB) (see Figure A.4).

As indicated in Table A.1, A diverts traffic formerly carried by link AB to link AC, while B diverts such traffic to link BC. It should be noted that the number of signalling transfer points traversed by signalling messages from F to A which passes through B is increased by one and becomes three in this case.

TABLE A.1/Q.705

List of alternative link sets at signalling points A and B

	Normal link set	Alternative link set	Priority ^{a)}
Signalling point A	AB AC	AC AB	1 1
Signalling transfer point B	BA	BC	2
	BC	None	
	BE	BD	1
	BD	BC	2
<p>a) <i>Priority 1</i> – Used with normal link set on load-sharing basis in the absence of failures.</p> <p><i>Priority 2</i> – Used only when all the link sets with priority 1 become unavailable.</p>			

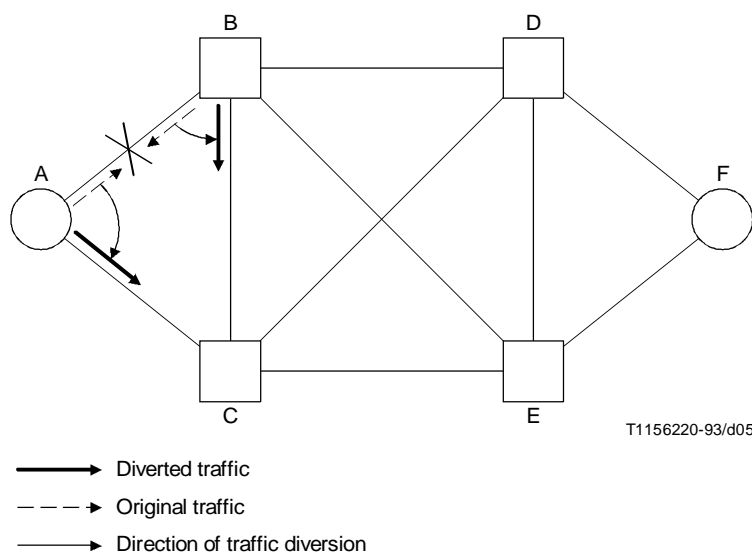

FIGURE A.4/Q.705

Failure of link AB

The principle to minimize the number of intermediate signalling transfer points in A.3.1 is applied in this case at signalling transfer point B to get around the failure. In fact, the procedures defined in Recommendation Q.704 assume that traffic is diverted at a signalling point only in the case of a signalling link being unavailable on the route outgoing from that signalling point. Therefore, the procedures do not provide for sending an indication that traffic routed via signalling transfer point B will traverse a further signalling transfer point.

Example 2: Failure of an intersignalling transfer points link (e.g. link BD) (see Figure A.5).

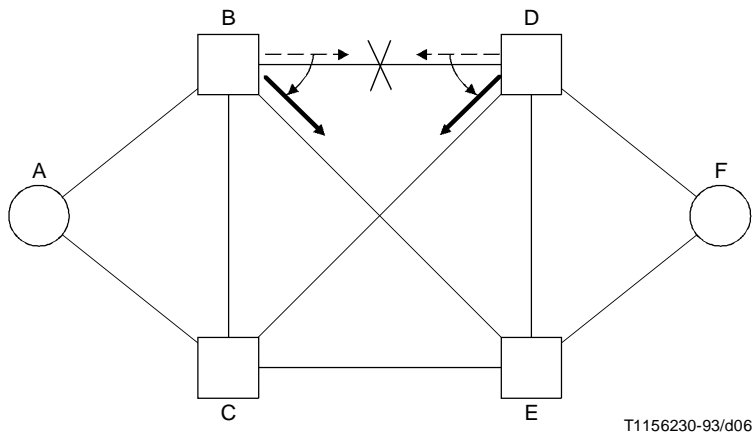

FIGURE A.5/Q.705
Failure of link BD

As indicated in Table A.1, B diverts traffic carried by link BD to link BE. In the same sense, D diverts traffic carried by link DB to link DC.

Example 3: Failure of a link between signalling transfer points of the same pair (e.g. link BC) (see Figure A.6).

No routing change is required as a result of this kind of failure. Only B and C take note that the link BC has become unavailable.

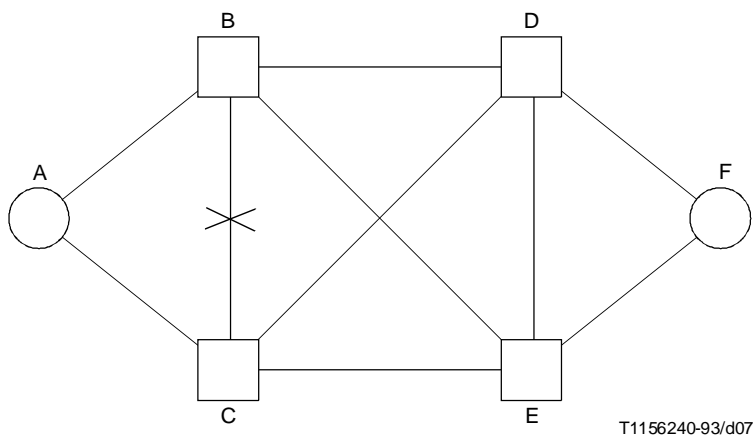

FIGURE A.6/Q.705
Failure of link BC

A.3.3.3 Multiple link failure examples

As there are a variety of cases in which more than one link set becomes unavailable, only some typical cases are given as examples in the following.

Example 1: Failure of a link between a signalling point and a signalling transfer point, and of the link between that signalling transfer point and that of the same pair (e.g. links DF, DE) (see Figure A.7).

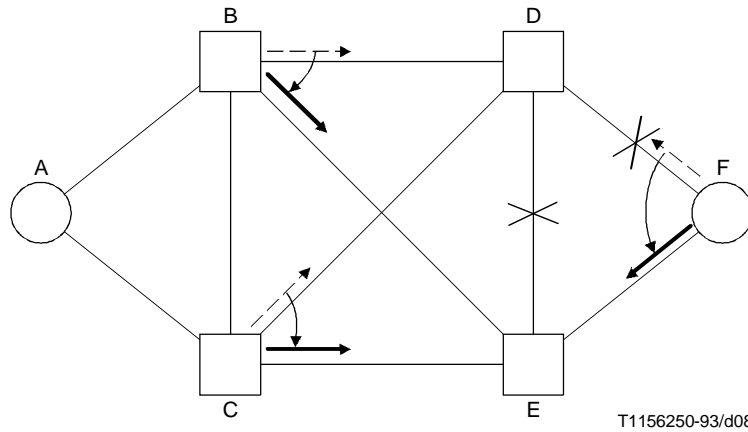

FIGURE A.7/Q.705
Failure of links DE and DF

B diverts traffic destined to F from link BD to link BE, because destination F becomes inaccessible via D. It should be noted that only the traffic destined to F is diverted from link BD to link BE, and not all the traffic on link BD. The same applies to C, which diverts traffic destined to F from link CD to link CE. F diverts all the traffic formerly carried by link FD to link FE in the same way as the single link failure example in A.3.3.2.

Example 2: Failure of two intersignalling transfer point links (e.g. links BD, BE) (see Figure A.8).

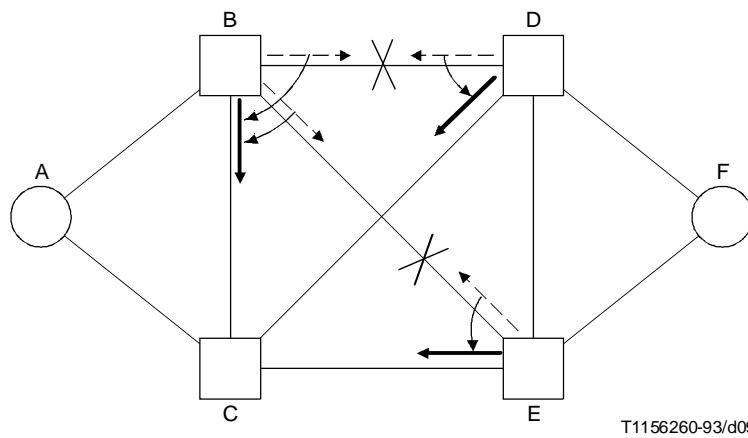

FIGURE A.8/Q.705
Failure of links BD and BE

B diverts traffic formerly carried by link BD to link BC, because its alternative link set with priority 1, i.e. link BE, is also unavailable. The same applies to traffic formerly carried by link BE, and B diverts it to link BC. D and E divert traffic formerly carried by links DB and EB respectively to links DC and EC in the same way as the single link failure example in A.3.3.2.

Example 3: Failure of a link between a signalling point and a signalling transfer point, and of an intersignalling transfer point link (e.g. links DF and BD) (see Figure A.9).

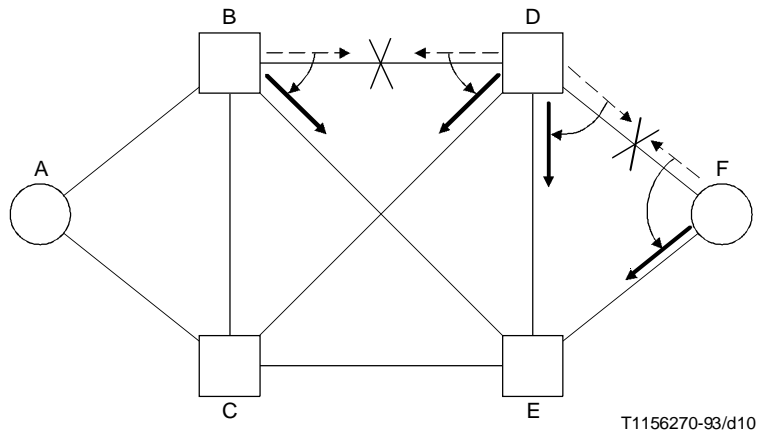

FIGURE A.9/Q.705
Failure of links BD and DF

This example is a combination of Examples 1 and 2 in A.3.3.2. D diverts traffic formerly carried by link DF to link DE, while F diverts it to link FE. Moreover D diverts traffic formerly carried by link DB to link DC (this traffic will be that generated by signalling points other than F connected to D). In the same sense, B diverts traffic carried by link BD to link BE.

It should be noted that in this case only the portion of traffic sent by C to F via D traverses three signalling transfer points (C, D and E), while all the other portions continue to traverse two.

Example 4: Failure of the two links between a signalling point and its signalling transfer points (e.g. DF and EF) (see Figure A.10).

In this case the signalling relations between F and any other signalling point of the network are blocked. Therefore F stops all outgoing signalling traffic, while A stops only traffic destined to F.

A.3.3.4 Single signalling point failure examples

Example 1: Failure of a signalling transfer point (e.g. D) (see Figure A.11).

B diverts all the traffic formerly carried by link BD to link BE. The same applies to C which diverts all the traffic carried by link CD to link CE. Originating point F diverts all the traffic carried by link FD to link FE as in the case of the link FD failure (see Example 1 in A.3.3.2).

Attention is drawn to the difference to Example 1 in A.3.3.3 where only a part of the traffic previously carried by links BD and CD was diverted.

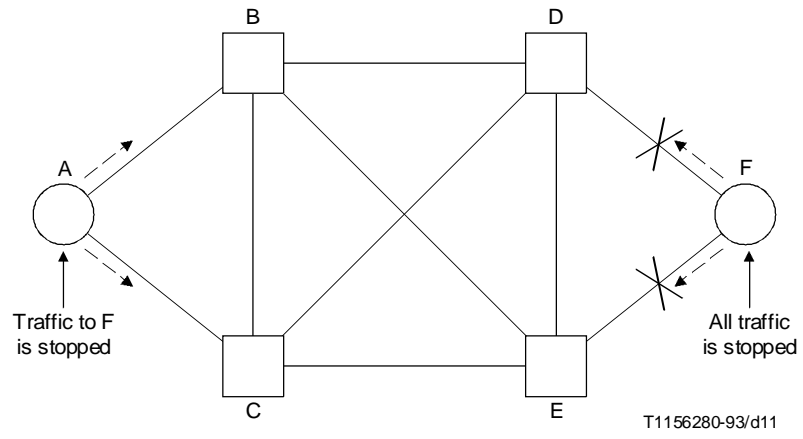

FIGURE A.10/Q.705
Failure of links DF and EF

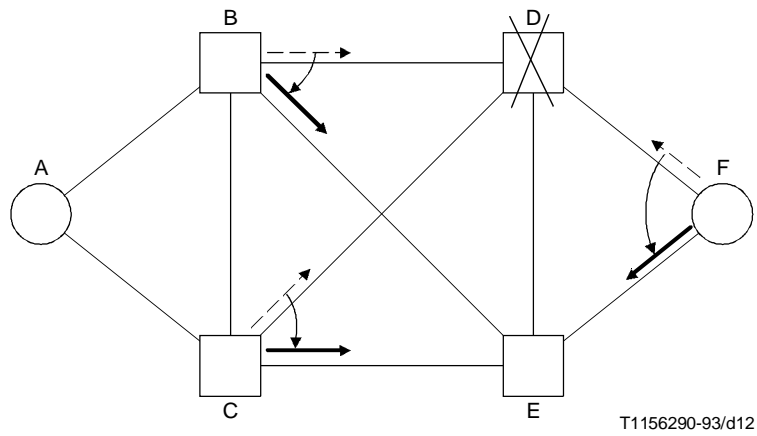

FIGURE A.11/Q.705
Failure of signalling transfer point D

Example 2: Failure of a destination point (e.g. F) (see Figure A.12).

In this case A stops all the traffic to F formerly carried on links AB and AC.

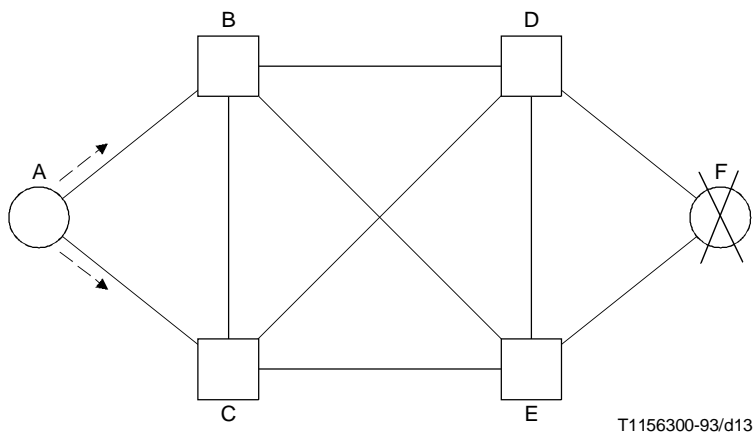

FIGURE A.12/Q.705
Failure of signalling point F

A.3.3.5 Multiple signalling transfer point failure examples

Two typical cases of two signalling transfer points failing together are presented in the following examples:

Example 1: Failure of two signalling transfer points not pertaining to the same pair (e.g. B and D) (see Figure A.13).

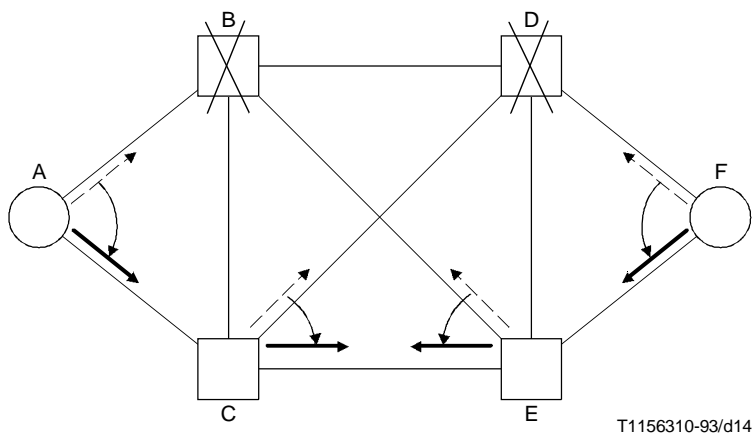

FIGURE A.13/Q.705
Failure of signalling transfer points B and D

As a result of the failure of B, A diverts traffic formerly carried by link AB to link AC, while E diverts traffic formerly carried by link EB to link EC. Similarly, as a result of the failure of D, F diverts traffic formerly carried by link FD to link FE, while C diverts traffic formerly carried by link CD to link CE.

It should be noted that, in this example, all the traffic between A and F is concentrated on only one intersignalling transfer point link, since failure of a signalling transfer point has an effect similar to a simultaneous failure of all the signalling links connected to it.

Example 2: Failure of two signalling transfer points pertaining to the same pairs (e.g. D and E) (see Figure A.14).

This example is equivalent to Example 4 in A.3.3.3 as far as the inaccessibility of F is concerned, but in this case any other signalling point connected by its links to D and E also becomes inaccessible. In this case A stops signalling traffic destined to F, while F stops all outgoing signalling traffic.

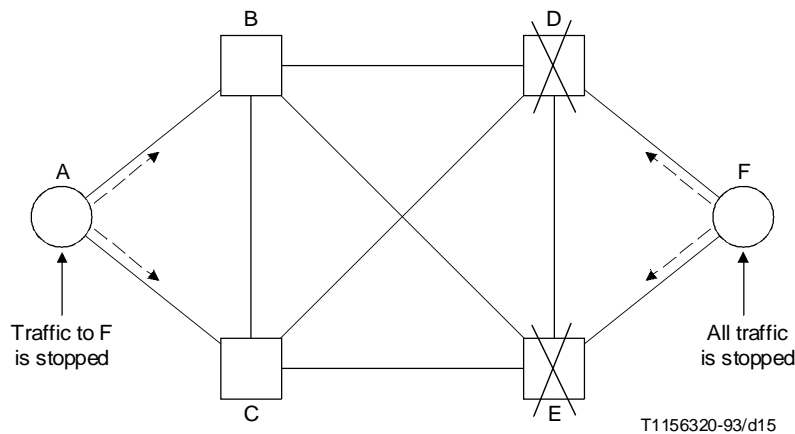

FIGURE A.14/Q.705
Failure of signalling transfer points D and E

A.4 Actions relating to failure conditions

In the following, four typical examples of the application of signalling network management procedures to the failure cases illustrated in A.3.3 are shown. In the case of multiple failures, an arbitrary failure (and restoration) sequence is assumed for illustrative purpose.

A.4.1 Example 1: Failure of a link between a signalling point and a signalling transfer point (e.g. link AB) (see Figure A.15)

(Same as A.3.3.2, Example 1.)

A.4.1.1 Failure of link AB

- a) When the failure of link AB is detected in A and in B, they initiate the changeover procedure, by exchanging changeover messages via C. Once buffer updating is completed, A restarts the traffic originally carried by the failed link on link AC; similarly, B restarts traffic destined to A on link BC.
- b) In addition, B sends a transfer-prohibited message to C referred to destination A (according to the criterion indicated in 13.2.2/Q.704).
- c) On the reception of the transfer-prohibited message, C starts the periodic sending of signalling-route-set-test messages, referred to A, to B (see 13.5.2/Q.704).

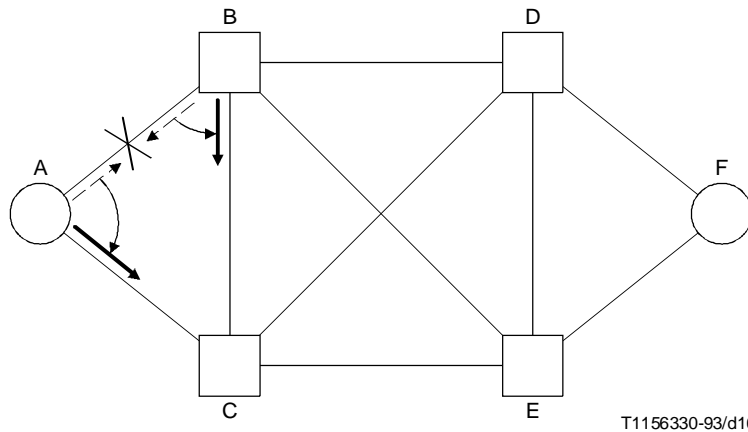

T1156330-93/d16

FIGURE A.15/Q.705
Failure of link AB

A.4.1.2 Restoration of link AB

When the restoration of link AB is completed, the following applies:

- a) B initiates the changeback procedure, by sending a changeback declaration to A via C. Once it has received the changeback acknowledgement, it restarts traffic on the restored link. Moreover, it sends to C a transfer-allowed message, referred to destination A (see 13.3.2/Q.704). When C receives the transfer-allowed message, it stops sending signalling-route-set-test messages to B.
- b) A initiates the changeback procedure, by sending a changeback declaration to B via C; once it has received the changeback acknowledgement, it restarts traffic on the normal link. The only traffic to be diverted is that for which link AB is the normal link set according to the load sharing rule (see A.3.3.1). It must be pointed out, however, that if there is load sharing on parallel links between B and C, there is the possibility of missequencing. Concerning b), for example, the changeback declaration sent from A to B via C might overrun messages still buffered at signalling point C (due to, e.g. retransmissions on the parallel link CB).

A.4.2 Example 2: Failure of signalling transfer point D (see Figure A.16)

(Same as A.3.3.4, Example 1.)

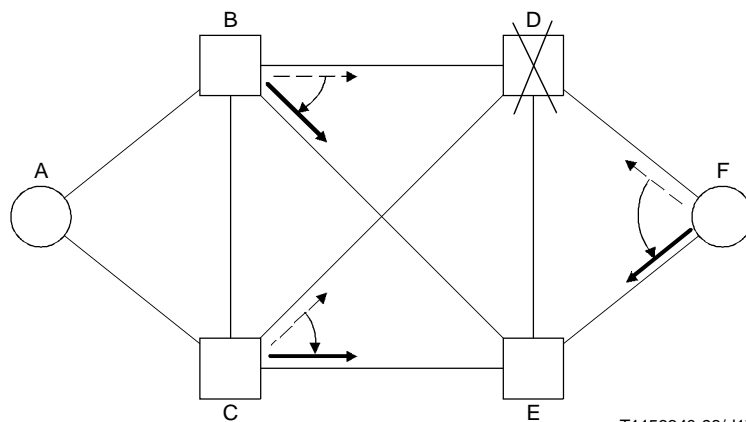

T1156340-93/d17

FIGURE A.16/Q.705
Failure of signalling transfer point D

A.4.2.1 Failure of signalling transfer point D

- a) Changeover is initiated at signalling points B, C and F from blocked links BD, CD and FD to the first priority alternative links BE, CE and FE respectively. Due to the failure of D, the concerned signalling points will receive no changeover acknowledgement message in response, and therefore they will restart traffic on alternative links at the expiry of the time T2 (see Recommendation 5.7.2/Q.704). In addition E will send to B, C and F transfer-prohibited messages referred to destination D. These signalling points (B, C and F) will thus start periodic sending to E of signalling-route-set-test messages referred to D.
- b) When B receives a transfer-prohibited message from E referred to D, it updates its routing information so that traffic to D will be diverted to C, thus sending a transfer-prohibited message to C referred to D. The same applies to C, and C sends a transfer-prohibited message to B.
- c) So, when B receives a transfer-prohibited message from C, it finds that destination D has become inaccessible and sends a transfer-prohibited message to A. The same applies to C and thus C also sends a transfer-prohibited message to A. Having received transfer-prohibited messages from both B and C, A recognizes that D has become inaccessible and stops traffic to D.
- d) In the same manner, i.e. link-by-link transmission of transfer-prohibited messages referred to D, other signalling points B, C, E and F will finally recognize that destination D has become inaccessible. Each signalling point will, therefore, start periodic sending of signalling-route-set-test messages referred to D to their respective adjacent signalling points.

A.4.2.2 Recovery of signalling transfer point D

- a) Signalling points B, C, E send traffic restart allowed messages to signalling point D, as soon as signalling point D becomes accessible.
- b) Signalling transfer point D broadcasts traffic restart allowed messages, after T20 (see 16.8/Q.704) has stopped or expired, to all adjacent SPs.
- c) Changeback at signalling points B, C and F from the alternative to their normal links is performed. In all the three cases changeback includes the time-controlled diversion procedure (see 6.4/Q.704), since D is still inaccessible via E at B, C and F (as a result of previous reception of transfer-prohibited message from E).
- d) E sends to B, C and F transfer-allowed messages referred to destination D. These signalling points will thus send transfer allowed messages to their respective adjacent signalling points. Thus, the link-by-link transmission of transfer-allowed messages will declare to all signalling points that destination D has become accessible.
- e) On reception of a transfer-allowed message, each signalling point stops periodic sending of signalling-route-set-test messages to their respective adjacent signalling points.
- f) On recovery of the previously unavailable links BD, CD and FD, signalling points B, C and F will restart all the traffic normally routed via signalling transfer point D after T21 (see 16.8/Q.704) has stopped or expired. (They would restart any traffic terminating at D, if D had an endpoint function as well as being an STP, immediately D becomes accessible, that is after successful signalling link tests to D.)

A.4.3 Example 3: Failure of link between a signalling point and a signalling transfer point, and of the link between that signalling transfer point and that of the same pair (e.g. links DF, DE) (see Figure A.17)

(Same as A.3.3.3, Example 1.)

A.4.3.1 Failure of link DE

On failure of link DE, this link is marked unavailable at both signalling transfer points D and E. Since in the absence of failures, link DE does not carry signalling traffic, no change in message routing takes place at this time.

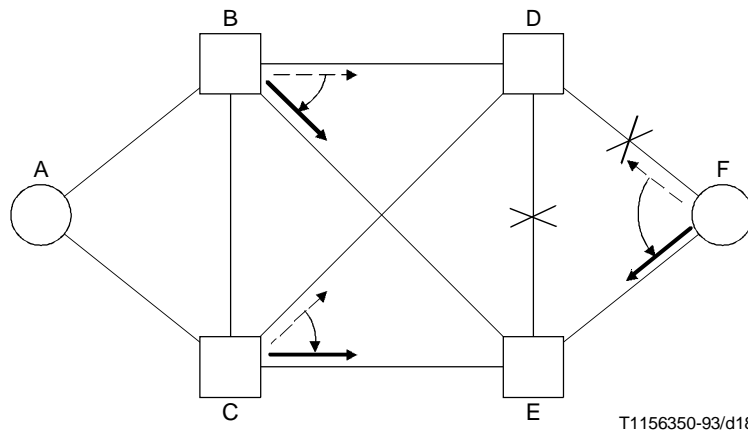

FIGURE A.17/Q.705
Failure of links DE and DF

However, D and E send to signalling points B, C and F transfer-prohibited messages referred to destination E or D respectively. These signalling points will thus start periodic sending of signalling-route-set-test messages, referred to D or E, to E and D respectively.

A.4.3.2 Failure of link DF in the presence of failure of link DE

- a) On failure of link DF the following actions occur:
 - i) Signalling point D which no longer has access to signalling point F indicates this condition to signalling transfer points B and C by sending transfer-prohibited messages. B and C will thus start the periodic sending of signalling-route-set-test messages referred to F, to D.
 - ii) Emergency changeover from link FD to link FE is initiated at signalling point F, since D becomes inaccessible to F due also to the previous failure.
- b) On receiving the transfer-prohibited messages forced rerouting is initiated at points B and C. This causes traffic destined to F to be diverted from links terminating on D to links terminating on E. Forced rerouting thus permits recovery from a failure condition caused by a fault in a remote part of the network.

A.4.3.3 Restoration of link FD in the presence of failure of link DE

- a) On recovery of link FD the following actions occur:
 - i) Signalling point D sends a transfer-allowed message to B and C to indicate that D once again has access to F. B and C will thus stop the sending of signalling-route-set-test messages referred to F to D.
 - ii) F initiates changeback with time controlled diversion from link FE to link FD. This procedure permits changeback to be executed at one end of a link, when it is impossible to notify the other end of the link (in this example, because link DE is unavailable). Traffic in this case is not diverted from the alternative link until a time interval has elapsed, in order to minimize the danger of missequencing messages (see 6.4/Q.704).
- b) On receiving the transfer-allowed message, controlled rerouting of traffic from the alternative routes (BEF, CEF) to the normal routes (BDF, CDF) is initiated at points B and C. Controlled rerouting involves diversion of traffic to a route which has become available after a time interval (see 8.2.1/Q.704), provisionally set at one second to minimize the danger of missequencing messages.

A.4.3.4 Restoration of link DE

On recovery of link DE it is marked available at signalling transfer points D and E. Signalling points D and E send to B, C and F transfer-allowed messages referred to destination E or D respectively. These signalling transfer points will thus stop sending of signalling-route-set-test messages.

A.4.4 Example 4: Failure of links DF and EF (see Figure A.18)

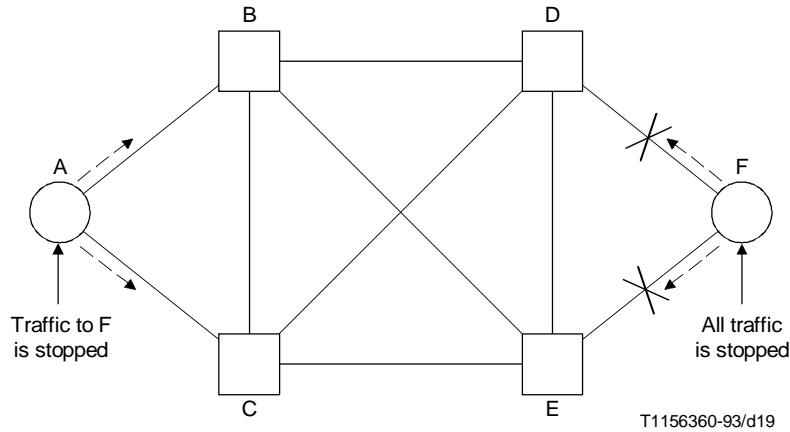

FIGURE A.18/Q.705
Failure of links DF and EF

A.4.4.1 Failure of link DF

When the failure of link DF is detected, D and F perform the changeover procedure; D diverts traffic, destined to F, to link DE, while F concentrates all the outgoing traffic on link FE.

In addition, D sends to E a transfer-prohibited message, referred to destination F; E will thus start sending of signalling-route-set-test messages, referred to F, towards D (see also A.4.1.1).

A.4.4.2 Failure of link EF in the presence of failure of link DF

- a) When the failure of link EF is detected, the following applies:
 - i) Since all destinations become inaccessible F stops sending all signalling traffic.
 - ii) E sends to B, C and D a transfer-prohibited message, referred to destination F. B, C and D start periodic sending of signalling-route-set-test messages referred to F to E.
- b) When D receives the transfer-prohibited message, it sends to B and C a transfer-prohibited message, referred to destination F [see 13.2.2 ii)/Q.704]. B and C start periodic sending of test messages referred to F to D.
- c) When B receives the transfer-prohibited messages from D and E, it sends a transfer-prohibited message to C; the same applies for C (it sends the message to B). As soon as B and C have received the transfer-prohibited messages from all the three possible routes (BD, BE and BC, or CD, CE and CB respectively), they send a transfer-prohibited message to A.

NOTE – Depending on the sequence of reception of transfer-prohibited messages at B or C, they may start a forced rerouting procedure on a route not yet declared to be unavailable; such procedure is then aborted as soon as a transfer-prohibited message is received also from that route.

- d) As soon as A receives the transfer-prohibited messages from B and C, it declares destination F inaccessible and stops sending traffic towards it. Moreover, it starts the periodic sending of signalling-route-set-test messages, referred to F, to B and C.

A.4.4.3 Restoration of link EF in the presence of failure on link DF

- a) When restoration of link EF is completed, the following applies:
 - i) Signalling point F restarts traffic on link EF.
 - ii) E sends a transfer-allowed message, referred to destination F, to B, C and D; moreover, it restarts traffic on the restored link.
- b) When B and C receive the transfer-allowed message, they send a transfer-allowed message to A and C or A and B, respectively and they stop sending signalling-route-set-test messages to E; moreover, they restart the concerned traffic on link BE or CE respectively.
- c) When D receives the transfer-allowed message from E, it sends transfer-allowed messages to B and C and stops sending signalling-route-set-test messages to E; moreover, it starts the concerned traffic on link DE. On receipt of the transfer-allowed message, B and C will divert to links BD and CD, by means of a controlled rerouting procedure, traffic carried by links BE and CE for which they are the normal links (see A.3.3). Moreover, they will stop sending signalling-route-set-test messages to D.

NOTE – According to the rules stated in 13.3.2/Q.704, on receipt of transfer-allowed messages from E [phase b) above], B and C should send transfer-allowed messages also to D and E. However, this is not appropriate in the network configurations such as the one here considered, taking into account that

- there is no route, for example, from D (or E) to F via B (or C) and therefore the transfer-allowed messages would be ignored by D and E;
 - on restarting traffic to F on links BD, BE, CD and CE it would anyway be necessary that B and C send transfer-prohibited messages to D and E, which would contradict the previous transfer-allowed messages.
- d) As soon as A receives a transfer-allowed message from B or C, it restarts signalling traffic to B and C. If traffic has already been restarted on one link when the transfer-allowed message is received on the other link, a changeback procedure is performed to establish the normal routing situation on both links (i.e. to divert part of the traffic on the latter link).

A.4.4.4 Restoration of link DF

When the restoration of link DF is completed, the following applies:

- a) D initiates the changeback procedure to link DF; moreover, it sends to E a transfer-allowed message, referred to destination F.
- b) F sends signalling-route-set-test message to D referred to the destination points it normally accesses via D. It initiates the changeback procedure to link DF; this procedure refers only to the traffic for which link DF is the normal one, according to the routing rules.

A.5 Explanatory note from the implementors forum for clarification of load sharing

A.5.1 In general, to improve the distribution of traffic, load sharing at a particular signalling point (amongst link sets to a given destination) will be on the basis of a part of the signalling link selection field which is different than that part used for load sharing amongst signalling links within a selected link set. In the example represented in Figure 5/Q.704, if link set DF contains more than one signalling link, then the least significant bit of the signalling link selection field is not used in sharing traffic within link set DF amongst the signalling links. Similar considerations can apply to link set DE.

A.5.2 At an originating signalling point it is assumed that for a given signalling relation, signalling link selection field values are evenly distributed and traffic is shared over the appropriate link sets and signalling links within each link set on this basis. In general, to achieve this a different load sharing rule is needed for each number of link sets, and each number of signalling links within a link set, over which traffic is to be shared. The intention is to attain, for a given signalling relation, as soon as possible, a traffic balance over the link sets and the signalling links within each

link set, based on the signalling link selection field and the numbers of link sets and signalling links within each link set; such an even traffic balance may result if the fixed part of the signalling link selection field is not excluded from consideration by the load sharing rules.

A.5.3 At a signalling transfer point, for a given signalling relation, signalling link selection field values may not be evenly distributed (see Figure 5/Q.704, signalling transfer point E). A different set of load sharing rules to those for originating signalling points may be provided to deal with this possibility. These are again based on the signalling link selection field and the numbers of link sets and signalling links within each link set, but assume that a particular part of the signalling link selection field is fixed. The fixed part of the signalling link selection field may be different at different signalling transfer points. Where signalling messages for different signalling relations arriving at a particular signalling transfer point do not have the same part of the signalling link selection field fixed, an uneven sharing of traffic for a particular signalling relation amongst the relevant link sets and signalling links within each link set may result.