



INTERNATIONAL TELECOMMUNICATION UNION

**ITU-T**

TELECOMMUNICATION  
STANDARDIZATION SECTOR  
OF ITU

**Q.690**

(03/93)

**INTERWORKING OF SIGNALLING SYSTEMS**

---

**INTERWORKING OF SIGNALLING SYSTEMS –  
LOGIC PROCEDURES FOR INTERWORKING  
OF SIGNALLING SYSTEM No. 7 (ISUP)  
TO No. 5**

**ITU-T Recommendation Q.690**

(Previously "CCITT Recommendation")

---

## FOREWORD

The ITU Telecommunication Standardization Sector (ITU-T) is a permanent organ of the International Telecommunication Union. The ITU-T is responsible for studying technical, operating and tariff questions and issuing Recommendations on them with a view to standardizing telecommunications on a worldwide basis.

The World Telecommunication Standardization Conference (WTSC), which meets every four years, established the topics for study by the ITU-T Study Groups which, in their turn, produce Recommendations on these topics.

ITU-T Recommendation Q.690 was prepared by the ITU-T Study Group XI (1988-1993) and was approved by the WTSC (Helsinki, March 1-12, 1993).

---

## NOTES

1 As a consequence of a reform process within the International Telecommunication Union (ITU), the CCITT ceased to exist as of 28 February 1993. In its place, the ITU Telecommunication Standardization Sector (ITU-T) was created as of 1 March 1993. Similarly, in this reform process, the CCIR and the IFRB have been replaced by the Radiocommunication Sector.

In order not to delay publication of this Recommendation, no change has been made in the text to references containing the acronyms "CCITT, CCIR or IFRB" or their associated entities such as Plenary Assembly, Secretariat, etc. Future editions of this Recommendation will contain the proper terminology related to the new ITU structure.

2 In this Recommendation, the expression "Administration" is used for conciseness to indicate both a telecommunication administration and a recognized operating agency.

© ITU 1994

All rights reserved. No part of this publication may be reproduced or utilized in any form or by any means, electronic or mechanical, including photocopying and microfilm, without permission in writing from the ITU.

**INTERWORKING OF SIGNALLING SYSTEMS –  
LOGIC PROCEDURES FOR INTERWORKING  
OF SIGNALLING SYSTEM No. 7 (ISUP) TO No. 5**

(Helsinki, 1993)

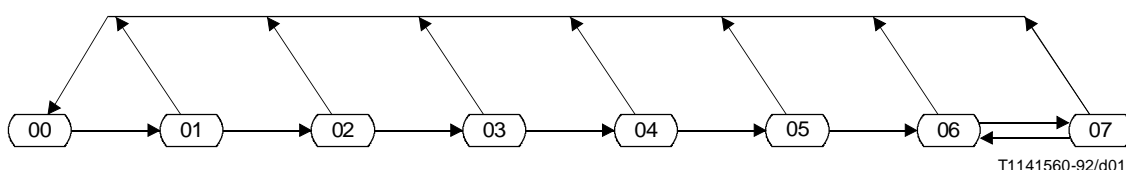

State number	State description	Sheet reference
00	Idle	1, 4, 5
01	Wait for CPCI-FITE	1
02	Wait for COT	1
03	Wait for address-complete COT received	3
04	Wait for register deactivation	4
05	Wait for answer	4
06	Answered	5
07	Clear-back	6

FIGURE 1/Q.690

**State overview diagram for interworking of  
Signalling System No. 7 (ISUP) to No. 5**

FIGURE 2/Q.690

**(Reserved for future notes)**

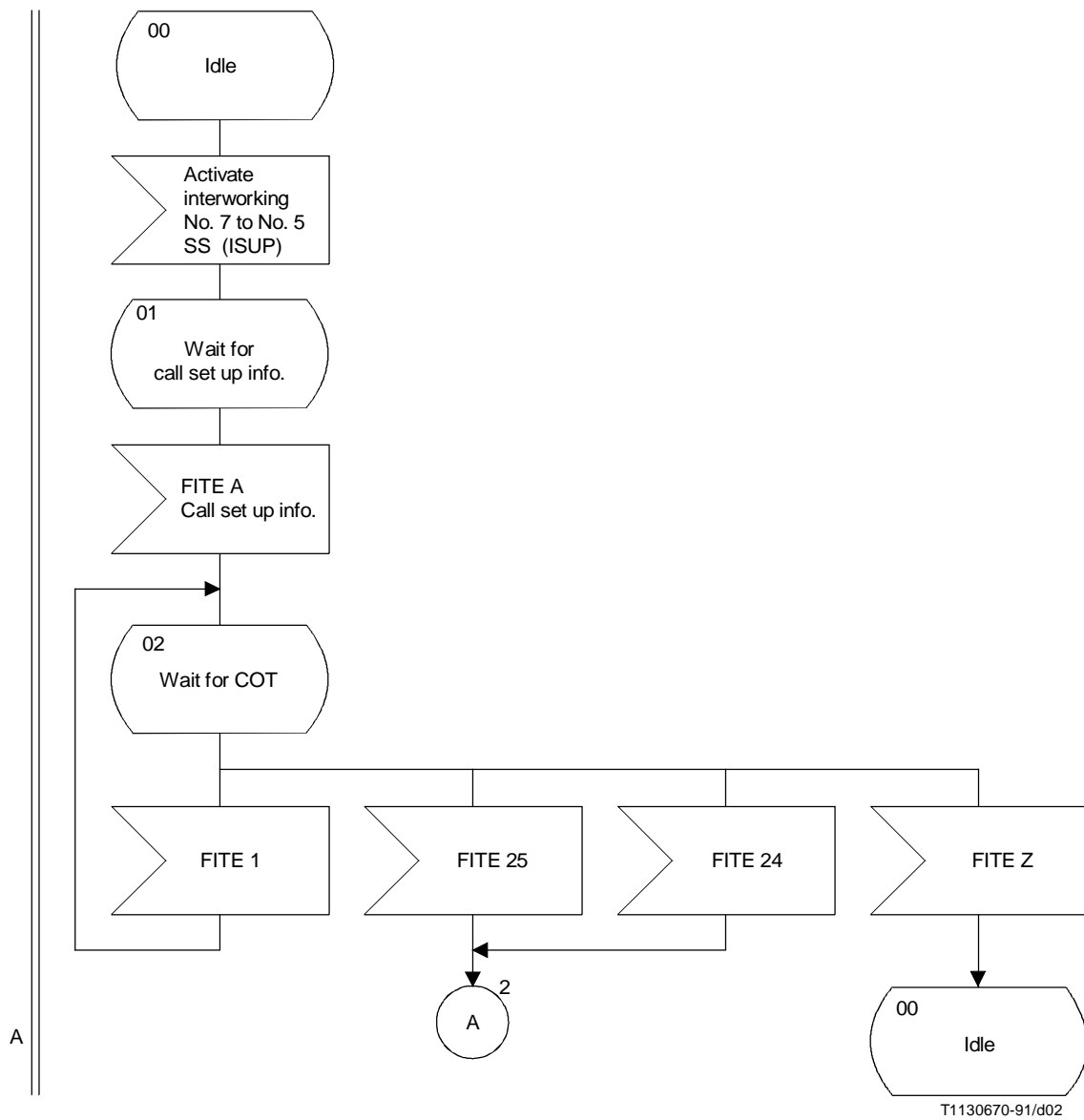

FIGURE 3/Q.690 (sheet 1 of 6)  
**Interworking of Signalling System No. 7 (ISUP) to No. 5**

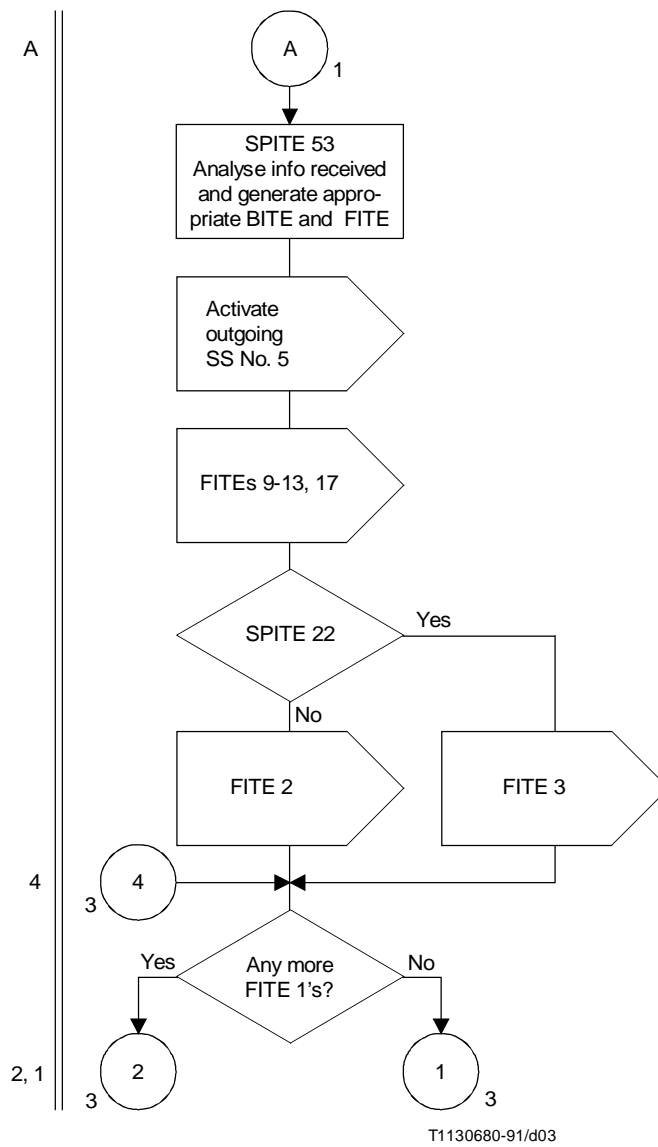

FIGURE 3/Q.690 (sheet 2 of 6)  
Interworking of Signalling System No. 7 (ISUP) to No. 5

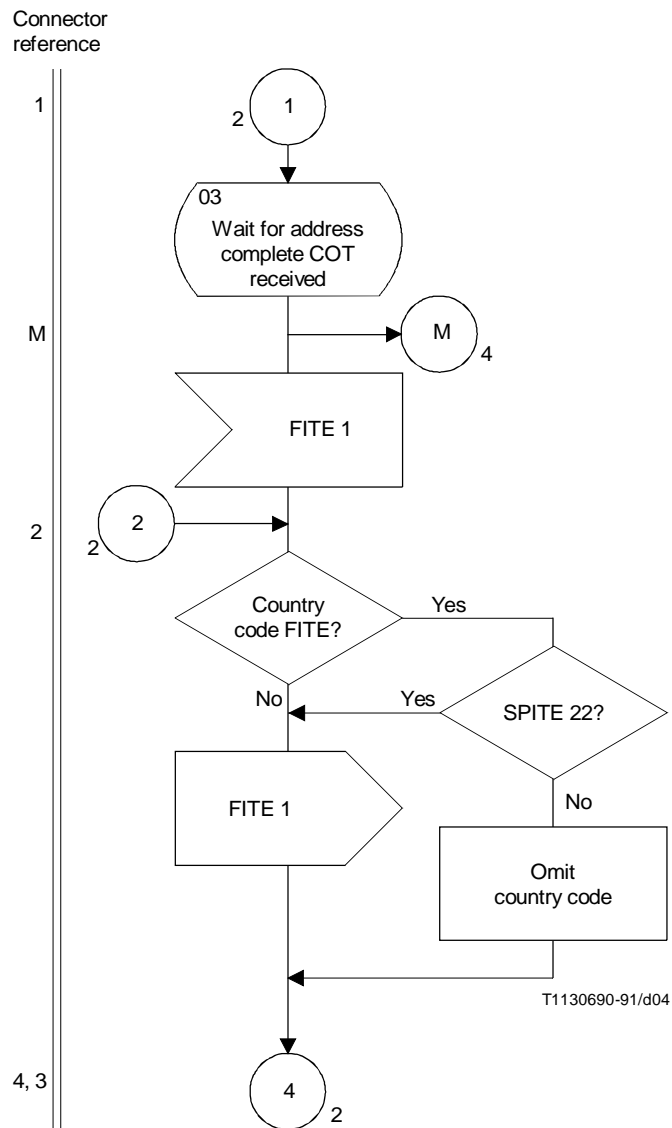

FIGURE 3/Q.690 (sheet 3 of 6)  
**Interworking of Signalling System No. 7 (ISUP) to No. 5**

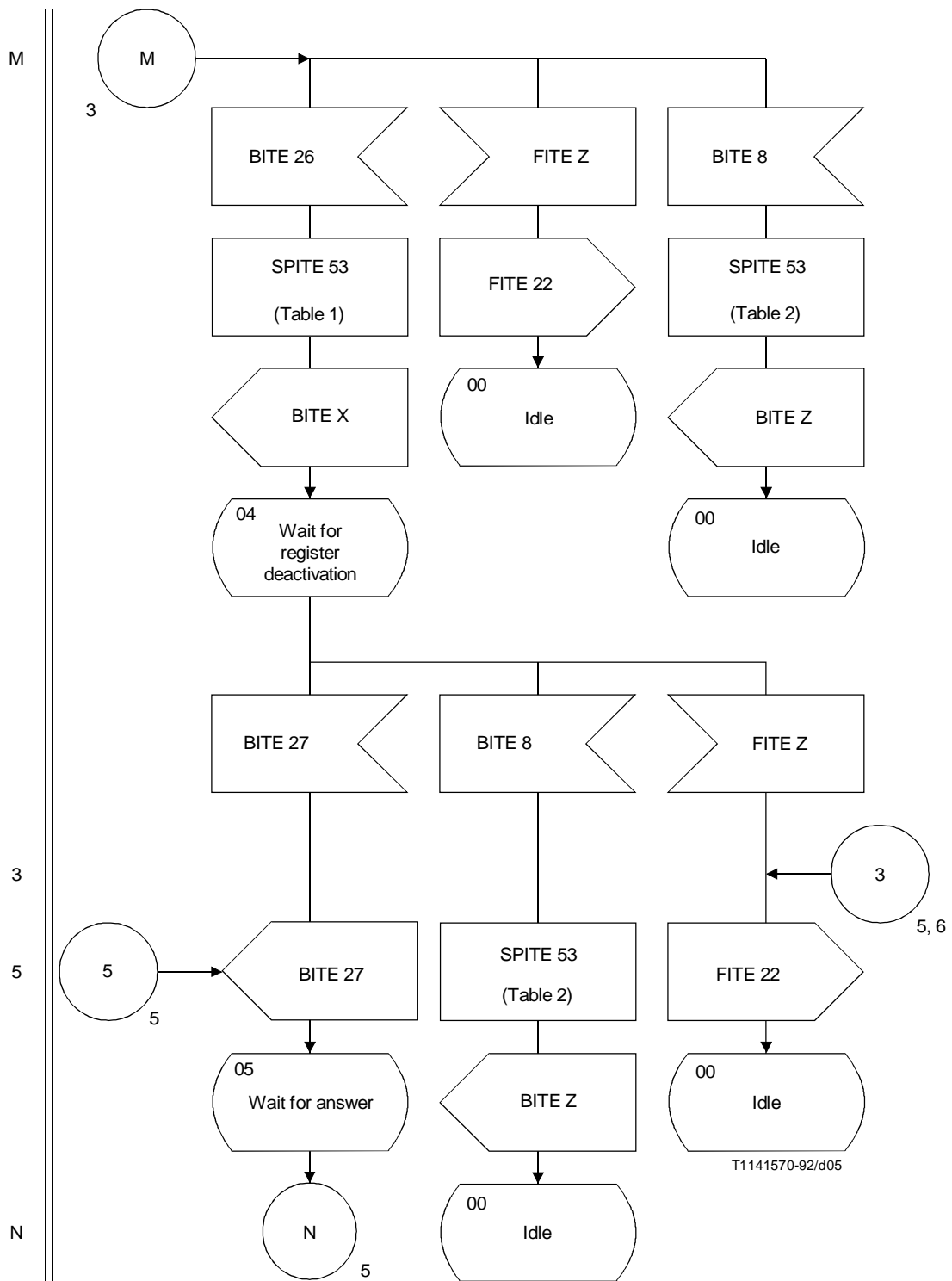

FIGURE 3/Q.690 (sheet 4 of 6)  
**Interworking of Signalling System No. 7 (ISUP) to No. 5**

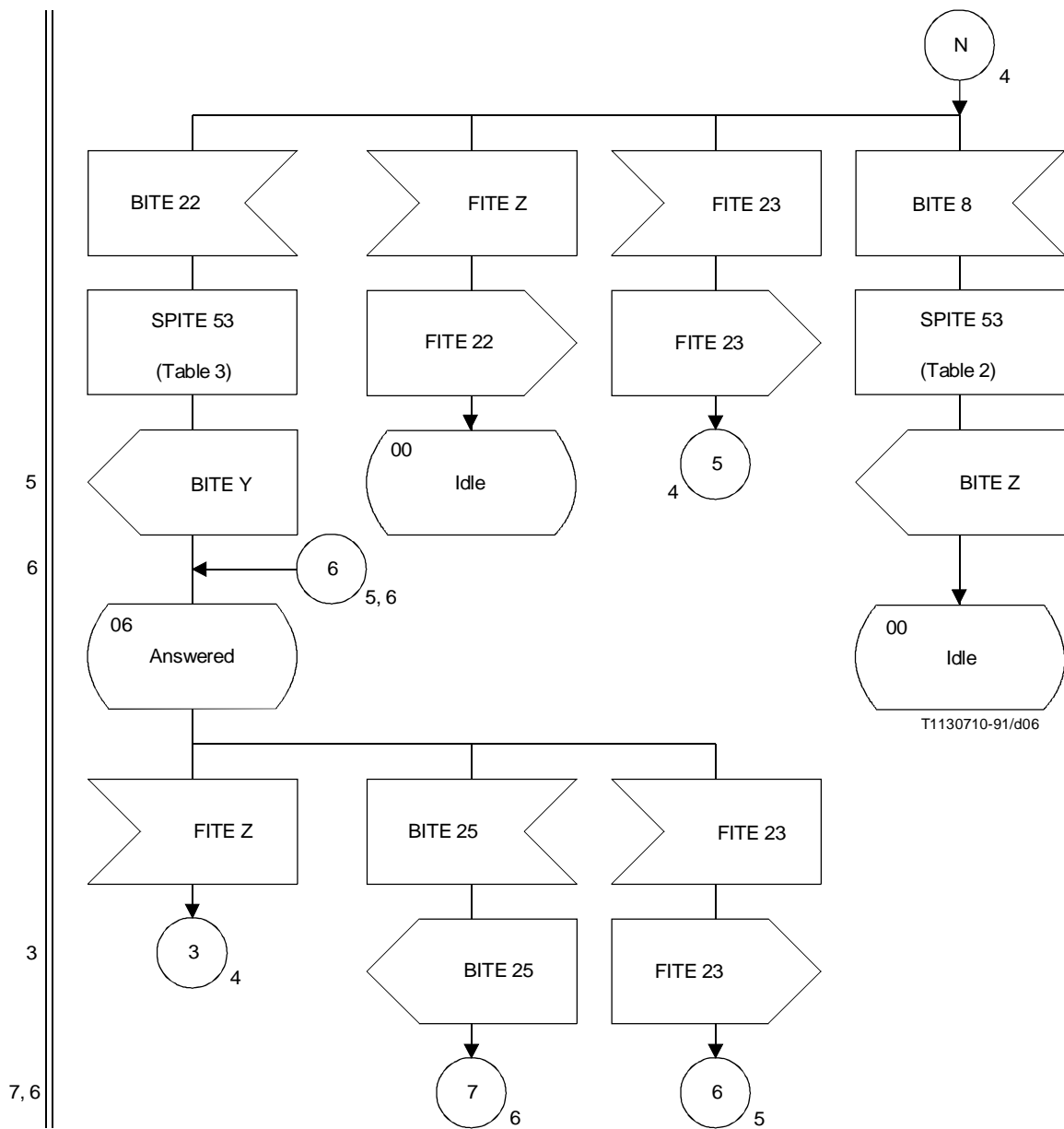

FIGURE 3/Q.690 (sheet 5 of 6)  
 Interworking of Signalling System No. 7 (ISUP) to No. 5



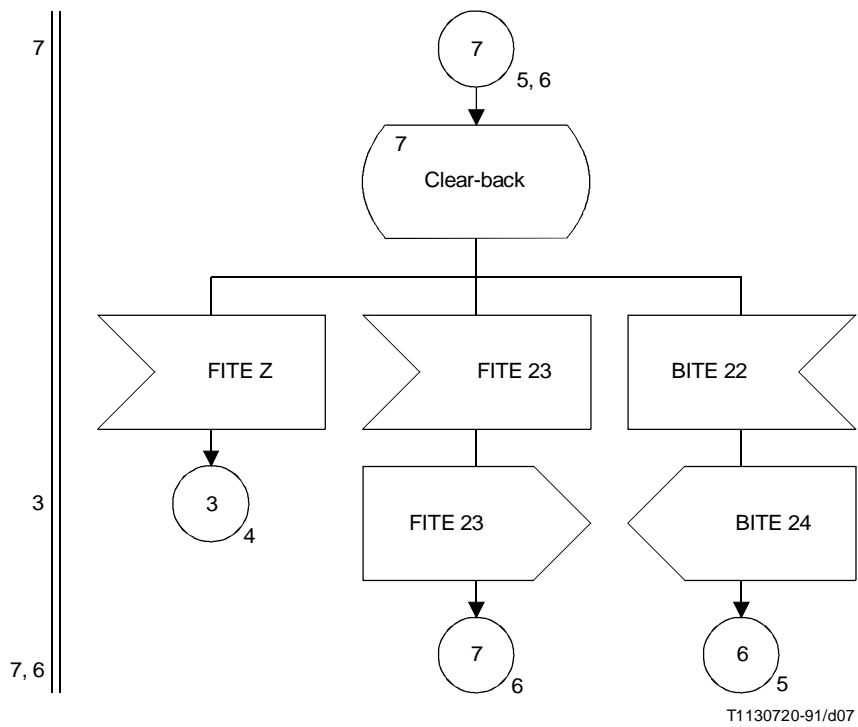

FIGURE 3/Q.690 (sheet 6 of 6)  
**Interworking of Signalling System No. 7 (ISUP) to No. 5**

TABLE 1/Q.690

	Received BITE
Backward call indicators in ACM	26
Charging indicator	10
Called party's status	00
Called party's category	00
Interworking indicator	1

TABLE 2/Q.690

Received BITE (Release)	Cause sent	Location.
8	34	1010
Failure due to SS No. 5 (timeout expiry)	127	0111

TABLE 3/Q.690

Backward call indicators in ANM
ANM without backward call indicators is to be sent