



INTERNATIONAL TELECOMMUNICATION UNION

**ITU-T**

TELECOMMUNICATION  
STANDARDIZATION SECTOR  
OF ITU

**Q.76**

(02/95)

**GENERAL RECOMMENDATIONS ON TELEPHONE  
SWITCHING AND SIGNALLING**

**FUNCTIONS AND INFORMATION FLOWS  
FOR SERVICES IN THE ISDN**

---

**SERVICE PROCEDURES FOR UNIVERSAL  
PERSONAL TELECOMMUNICATION –  
FUNCTIONAL MODELLING AND  
INFORMATION FLOWS**

**ITU-T Recommendation Q.76**

(Previously “CCITT Recommendation”)

---

## FOREWORD

The ITU-T (Telecommunication Standardization Sector) is a permanent organ of the International Telecommunication Union (ITU). The ITU-T is responsible for studying technical, operating and tariff questions and issuing Recommendations on them with a view to standardizing telecommunications on a worldwide basis.

The World Telecommunication Standardization Conference (WTSC), which meets every four years, establishes the topics for study by the ITU-T Study Groups which, in their turn, produce Recommendations on these topics.

The approval of Recommendations by the Members of the ITU-T is covered by the procedure laid down in WTSC Resolution No. 1 (Helsinki, March 1-12, 1993).

ITU-T Recommendation Q.76 was prepared by ITU-T Study Group 11 (1993-1996) and was approved under the WTSC Resolution No. 1 procedure on the 7th of February 1995.

---

## NOTE

In this Recommendation, the expression "Administration" is used for conciseness to indicate both a telecommunication administration and a recognized operating agency.

© ITU 1995

All rights reserved. No part of this publication may be reproduced or utilized in any form or by any means, electronic or mechanical, including photocopying and microfilm, without permission in writing from the ITU.

## CONTENTS

		<i>Page</i>
1	Introduction .....	1
	1.1 Scope of Recommendation .....	1
	1.2 References .....	3
	1.3 Definition of terms .....	3
	1.3.1 Terms defined in Recommendation F.851 .....	3
	1.3.2 Terms not defined in Recommendation F.851 .....	4
	1.4 Description of UPT .....	4
	1.5 Glossary of abbreviations .....	4
	1.6 Conventions .....	6
2	Functional model for UPT Service Set 1 .....	6
	2.1 Functional model .....	6
	2.2 Descriptions of the functional entities .....	6
3	Information flows for UPT Service Set 1 .....	9
	3.1 UPT elementary procedures and common sequences .....	11
	3.1.1 Access, identification and authentication .....	11
	3.1.1.1 Outline description .....	11
	3.1.1.2 Information flow diagrams .....	11
	3.1.2 Call release sequences .....	16
	3.1.2.1 Information flow diagrams .....	18
	3.1.3 Procedure identification including global follow-on .....	21
	3.1.3.1 Outline description .....	21
	3.1.3.2 Information flow diagrams .....	22
	3.2 Procedures for personal mobility .....	23
	3.2.1 Registration and deregistration .....	23
	3.2.1.1 Outline description .....	24
	3.2.1.2 Information flow diagrams .....	24
	3.3 UPT call handling procedures .....	27
	3.3.1 Outgoing calls .....	27
	3.3.1.1 Outline description .....	28
	3.3.1.2 Information flow diagrams .....	28
	3.3.2 Incoming call to UPT user .....	28
	3.3.2.1 Outline description .....	28
	3.3.2.2 Information flow diagrams .....	28
	3.4 Procedures for UPT service profile management .....	31
	3.4.1 Outline description .....	31
	3.4.2 Information flow diagrams .....	31
	3.5 Third-party procedures .....	34
	3.5.1 Outline description .....	34
	3.5.2 Information flow diagrams .....	36
	3.6 Definition of individual information flows .....	36
	3.6.1 Relationship $r_a$ (SSF-SCF) .....	36
	3.6.1.1 SSF to SCF flows .....	36
	3.6.1.2 SCF to SSF flows .....	37
	3.6.2 Relationship $r_b$ (SCF-SDF) .....	38
	3.6.2.1 SCF to SDF flows .....	38
	3.6.2.2 SDF to SCF flows .....	38
	3.6.3 Relationship $r_c$ (SCF-SRF) .....	38
	3.6.3.1 SCF to SRF flows .....	38
	3.6.3.2 SRF to SCF flows .....	38

	<i>Page</i>
4	SDL diagrams for functional entities ..... 39
5	Functional Entity Actions..... 57
5.1	Functional Entity – FE2 (SSF/CCF) ..... 57
5.2	Functional Entity – FE6 (SCF) ..... 59
5.3	Functional Entity – FE7 [SDF(o)] ..... 66
5.4	Functional Entity – FE8 (SRF) ..... 67
5.5	Functional Entity – FE9 [SDF(h)] ..... 67
6	Mapping of functional entities to physical entities..... 67
Annex A	– Outgoing call follow-on ..... 69
A.1	Initiation of follow-on ..... 69
A.2	Release of resources..... 70
A.2.1	Release of B-party..... 70
A.2.2	A-party resources ..... 71
A.3	Description and diagrams..... 71
A.3.1	Outline description..... 71
A.3.2	Information flow diagrams..... 71
A.3.3	Functional entity actions ..... 74
A.3.3.1	Functional Entity – FE2 (SSF/CCF) ..... 74
A.3.3.2	Functional Entity – FE6 (SCF) ..... 74

## SUMMARY

This Recommendation provides an Intelligent Network Capability Set 1 compliant description of UPT Service Set 1 features and procedures. It does not provide an implementation or technology independent description. The Q.76 functional model, information flows, logic for sequencing of information flows and Intelligent Network functional entity actions are those of Intelligent Network Capability Set 1, as described in the 1993 Q.121x-Series of Recommendations of ITU-T Study Group 11.

The service basis of this Recommendation is provided by UPT Service Set 1 as described in Recommendation F.851 [2], "Universal Personal Telecommunication – Service Description. Version 10". In relation to Version 10 of Recommendation F.851 [2], includes procedures for the following features which are achievable in Intelligent Network Capability Set 1:

### Features

#### Essential

- UPT user identity authentication
- InCall registration
- Outgoing UPT call
- InCall delivery

#### Optional

- Remote InCall registration
- OutCall follow-on
- Global follow-on
- UPT-specific indications
- UPT service profile interrogation
- UPT service profile modification

#### Third-party protection

##### Optional

Reset of registrations for incoming UPT calls.

This Recommendation includes the essential features of Service Set 1 and other features which can be expected to be achievable in current networks with the addition of Intelligent Network capabilities such as CS-1. Other Service Set 1 features are outside the scope of initial standardization in this Recommendation, but may be added later as Addenda.



# **SERVICE PROCEDURES FOR UNIVERSAL PERSONAL TELECOMMUNICATION – FUNCTIONAL MODELLING AND INFORMATION FLOWS**

*(Geneva, 1995)*

## **1 Introduction**

### **1.1 Scope of Recommendation**

This Recommendation defines an Intelligent Network Capability Set 1 (IN CS-1) compliant service description of Universal Personal Telecommunication (UPT). It does not in any way provide an implementation or technology independent description. It identifies the functional capabilities and information flows from IN CS-1 needed to support the service for UPT Service Set 1, the initial phase of UPT introduction, as defined in Recommendations F.850 [1] and F.851 [2]. Recommendation F.851 [2] categorizes the functionality into **essential** and **optional**. Not all the features of Recommendation F.851 [2] can be supported by existing networks. This Recommendation includes only those service features achievable with current ITU-T signalling Recommendations. Networks not supporting existing ITU-T signalling Recommendations may be unable to provide all the features in this Recommendation.

This Recommendation employs a methodology based on that specified in Recommendation Q.65 [3], appropriately modified to take account of the facts that the functional model, information flows, logic for sequencing of information flows and IN functional entity actions are defined in Recommendation Q.1214 [4] and Recommendation Q.1218 [5], and are not defined within this Recommendation.

All UPT procedures described in this Recommendation are associated with a call, as required by IN CS-1 capabilities, and are invoked by interruption of call processing.

Only the relationships related to IN service execution are addressed in this Recommendation.

This Recommendation does not address the relationship between UPT service and basic call. This relationship is as prescribed for IN CS-1 services and is described in Recommendation Q.1214 [4]. It should be noted that the definitions of CCAF and CCF are based on corresponding Q.71 [6] ISDN definitions but are modified for use in IN. In particular, the enhanced basic call state model of the IN defines standard detection points (DPs) at which IN service feature logic instances can be invoked. These DPs correspond to the Q.71 “hooks” where an ISDN supplementary service interfaces to the Q.71 basic call model. Call modelling and the SSF/CCF functional entity are described in detail in clauses 3/Q.1214 and 4/Q.1214 [4]. In CS-1, the SSF/CCF functional entity is treated as indivisible, i.e. the interface between CCF and SSF is not a matter for CS-1 standardization.

The procedures, functional entities and information flows described in this Recommendation relate to service provision across multiple networks, to the level of Intelligent Network CS-1 capabilities, by allowing access to the UPT user’s home service provider’s database from the originating network across a network boundary. It is assumed throughout this Recommendation that the UPT user is a visitor on the originating network and no UPT service profile transfer is provided from the UPT user’s home database to the originating network database. All interactions with SDF(h) are controlled by the SCF in the originating network, in conformance with CS-1 guidelines.

The relationship between this Recommendation and UPT Service Set 1 as defined in Recommendation F.851 [2] is as follows:

*Service provided* – Telephone (i.e. voice-grade connection)

*Networks involved* – All voice networks (e.g. PSTN, ISDN, PLMN)

## **Features**

### **Included in this Recommendation**

#### **Essential**

- UPT user identity authentication
- InCall registration
- Outgoing UPT call
- InCall delivery

#### **Optional**

- Remote InCall registration
- OutCall follow-on
- Global follow-on
- UPT-specific indications
- UPT service profile interrogation
- UPT service profile modification

### **Not included in this Recommendation**

#### **Optional**

- OutCall registration
- Remote OutCall registration
- AllCall registration
- Remote AllCall registration
- Linked registration
- Remote Linked registration
- Multiple Terminal Address registration
- Call Pick-up
- Variable default InCall registration
- Intended Recipient Identity Presentation
- Access to groups of UPT service profiles
- UPT service assistance
- Called party specified secure answering of incoming UPT calls
- UPT service provider authentication

*Numbering* – UPT numbering is based on a personal UPT number which uniquely identifies the UPT user.

## **Charging**

#### **Optional**

Location related charges based on the caller's location and the current location of the called UPT user (see Note).

*Service profiles* – Personalized UPT service profile to enable UPT user and subscriber control and flexibility in the selection of the UPT user telecommunication services.

### **Third-party protection mechanisms**

#### **Essential**

None identified in Recommendation F.851 [2].

### **Included in this Recommendation**



## Optional

Reset of registrations for incoming UPT calls.

## Not included in this Recommendation

## Optional

Exemption from any UPT usage

Indications of UPT registrations

Blocking/deblocking of registrations for incoming UPT calls

Blocking/deblocking of incoming UPT calls

Reset of registration for outgoing UPT calls

Suspension of registration for outgoing UPT calls

NOTE – The charging information flows in this Recommendation are independent of the method of determination of charges.

This Recommendation includes procedures for the essential and optional features as indicated and for reset of registration for incoming UPT calls.

## 1.2 References

The following Recommendations and other references contain provisions which, through reference in this text, constitute provisions of this Recommendation. At the time of publication, the editions indicated were valid. All Recommendations and other references are subject to revision: all users of this Recommendation are therefore encouraged to investigate the possibility of applying the most recent edition of the Recommendations and other references listed below. A list of the currently valid ITU-T Recommendations is regularly published.

- [1] ITU-T Recommendation F.850 (1993), *Principles of Universal Personal Telecommunication (UPT)*.
- [2] ITU-T Recommendation F.851 (1995), *Universal Personal Telecommunication (UPT) – Service description (service set 1)*.
- [3] CCITT Recommendation Q.65 (1988), *Stage 2 of the method for the characterization of services supported by an ISDN*.
- [4] ITU-T Recommendation Q.1214 (1993), *Distributed functional plane for intelligent network CS-1*.
- [5] ITU-T Recommendation Q.1218 (1993), *Interface Recommendation for intelligent network CS-1*.
- [6] ITU-T Recommendation Q.71 (1993), *ISDN circuit mode switched bearer services*.
- [7] ITU-T Recommendation Q.1219 (1994), *Intelligent network users guide for capability set 1*.
- [8] ITU-T Recommendation D.280 (1995), *Principles for charging and billing, accounting and reimbursements for Universal Personal Telecommunication*.

## 1.3 Definition of terms

For the purposes of this Recommendation, the following terms and definitions apply.

### 1.3.1 Terms defined in Recommendation F.851 [2]

The following terms are defined in Recommendation F.851 [2]:

UPT (Universal Personal Telecommunication)

UPT subscriber

UPT user

UPT service provider

UPT number

UPT access code

UPT environment  
UPT service profile  
UPT service profile management  
Terminal address  
Network limitations

### 1.3.2 Terms not defined in Recommendation F.851 [2]

The following terminology is used in this Recommendation:

**1.3.2.1 home network:** The network with which the user's UPT service provider is associated is described as the "home network". The UPT service provider may not be the network provider but must be associated with a network. The UPT user's default registration locations need not be on the home network.

**1.3.2.2 originating network:** The network from which any user originates a UPT service request or outgoing call is the "originating" network. It is assumed that there is at least one UPT service provider associated with this network.

**1.3.2.3 terminating network:** The called party's current network is the "terminating" network.

**1.3.2.4 home SDF:** The "home SDF" is the UPT service provider's SDF, where the UPT user's service profile is stored. It is designated SDF(h).

**1.3.2.5 originating SDF:** The "originating SDF" is the SDF of the UPT service provider associated with the originating network. It is designated SDF(o).

**1.3.2.6 SDF(h)A and SDF(h)B:** A UPT user who is the called party may be a visitor on the terminating network. Where it is necessary to distinguish between SDFs of the A and B parties, the notation SDF(h)A and SDF(h)B is used.

## 1.4 Description of UPT

UPT introduces the concept of UPT number. In fixed telecommunication networks, a user or subscriber is associated with the network access point of the terminal, the point of attachment of the terminal. In certain mobile telecommunication networks, a user or subscriber is associated with the specific terminal in use.

In the UPT environment, the fixed association between terminal and user identification is removed. In order to offer users the capability of establishing and receiving calls on any terminal and at any location, the identification of UPT users is treated separately from the addressing of terminals and network access points. UPT user identification is achieved by use of a UPT number. The UPT user is therefore personally associated with his or her own UPT number, which is used as the basis for making and receiving calls. The UPT number is diallable on a global basis and routable from any fixed or mobile terminal, across multiple networks irrespective of geographical location, limited only by the terminal and network capabilities and any restrictions imposed by the network operator. The UPT user may be assigned one or more UPT numbers.

UPT also allows the UPT user to participate in a user-defined set of subscribed services, from amongst which the user defines personal requirements, to form a UPT service profile.

## 1.5 Glossary of abbreviations

For the purposes of this Recommendation, the following abbreviations are used:

AD	Adjunct
BCP	Basic Call Process SIB
BCSM	Basic Call State Model (see Recommendation Q.1214 [4])
CCAF	Call Control Agent Function
CCF	Call Control Function
CHG	Charge SIB

CLI	Calling Line Identification
CS-1	Capability Set 1
DP	Detection Point (in BCSM)
EDP	Event Detection Point (in BCSM)
EDP-N	Event Detection Point – Notification (in BCSM)
EDP-R	Event Detection Point – Request (in BCSM)
FE	Functional Entity
FEA	Functional Entity Action
IE	Information Element
IF	Information Flow
IN	Intelligent Network
IP	Intelligent Peripheral
ISDN	Integrated Services Digital Network
LCI	Log Call Information SIB
NAP	Network Access Point
PE	Physical Entity
PIC	Point in Call (in BCSM)
PLMN	Public Land Mobile Network
PSTN	Public Switched Telephone Network
SCF	Service Control Function
SCP	Service Control Point
SDF	Service data function
SDF(h)	Home Service Data Function
SDF(o)	Originating Service Data Function
SDM	Service Data Management SIB
SDP	Service Data Point
SIB	Service Independent Building Block
SN	Service Node
SRF	Specialized Resource Function
SSCP	Service Switching and Control Point
SSF	Service Switching Function
SSP	Service Switching Point
TDP	Trigger Detection Point (in BCSM)
TDP-N	Trigger Detection Point – Notification (in BCSM)
TDP-R	Trigger Detection Point – Request (in BCSM)
Trans.	Translate SIB
UI	User Interaction SIB
UPT	Universal Personal Telecommunication

## 1.6 Conventions

The following notations and styles are used in the text of this Recommendation:

- The names of CS-1 SIBs from Recommendation Q.1214 [4] are written with each component word capitalized and spaces between the words, e.g. Log Call Information.
- The names of CS-1 information flows from Recommendation Q.1214 [4] are written with each component word capitalized and spaces between the words and the appropriate type descriptor is included, e.g. Call Information Report req. ind.
- The names of information elements in CS-1 information flows from Recommendation Q.1214 [4] are written with each component word capitalized and spaces between the words, e.g. Requested Information.
- The abbreviation for the word identity in a CS-1 information element from Recommendation Q.1214 [4] is written ID.
- The names of CS-1 detection points from Recommendation Q.1214 [4] are written with each component word capitalized and underscores between the words, e.g. O\_Disconnect.
- Other names defined in Recommendation Q.1214 [4] are not capitalized, e.g. detection point.
- The names of information flows defined in Recommendation Q.71 [6] are written in upper case and the appropriate type descriptor is included, e.g. SETUP req. ind.
- The names of the personal mobility procedures defined in Recommendation F.851 [2] are written as InCall, OutCall and AllCall registration and deregistration.

The following notations and styles are used in the information flow diagrams of this Recommendation:

- The names of the CS-1 information flows from Recommendation Q.1214 [4] are written with each component word capitalized and spaces between the words but the appropriate type descriptor is omitted, e.g. Call Information Report, not Call Information Report req. ind.
- The names of information flows defined in Recommendation Q.71 [6] are written in upper case italics and the appropriate type descriptor is included, e.g. *SETUP req. ind.*

## 2 Functional model for UPT Service Set 1

### 2.1 Functional model

The functional entities (FEs) and information flows (IFs) defined for Intelligent Network Capability Set 1 (IN CS-1) are the basis in this Recommendation for the modelling of UPT, and are described in Recommendation Q.1214 [4]. The functional model is that of clause 3/Q.1214 [4]. Two forms of the functional model are shown in Figures 2-1 and 2-2. Modelling of entities and information flows which relate to the service provider's service management are not shown. Modelling of the assist and handoff procedures (see Recommendation 5.2.12.5/Q.1214 and 5.2.12.6/Q.1214 [4]) is not included, as implementation of UPT service will require no change to the information flows and actions described there.

### 2.2 Descriptions of the functional entities

In Figures 2-1 and 2-2 the functional entities (FEs) have the following meanings:

- |     |  |
|-----|--|
| FE1 | Originating CCAF                                   |
| FE2 | Originating CCF; associated with SSF in Figure 2-1 |
| FE3 | Transit CCF; associated with SSF in Figure 2-2     |
| FE4 | Terminating CCF                                    |
| FE5 | Terminating CCAF                                   |

- FE6 SCF
- FE7 SDF(o) (SDF in the originating network)
- FE8 SRF
- FE9 SDF(h) (SDF in the home network)

where the terms are as follows:

- SSF Service Switching Function
- SRF Specialized Resource Function
- CCF Call Control Function
- CCAF Call Control Agent Function
- SCF Service Control Function
- SDF Service Data Function

In CS-1 the CCF and SSF are assumed to have a relationship which is not externally visible and which is therefore not a subject for standardization in CS-1. The two forms of the functional model shown in Figures 2-1 and 2-2 differ only in that Figure 2-1 shows the case where UPT service can be invoked from the originating exchange and Figure 2-2 shows the case where the call must be routed to another exchange with UPT service capability. In the second case, bearer and call control information flows as defined in Recommendation Q.71 [6] or other means may be used for the  $r_2$  relationship. The two forms of the model are identical as far as the relationships  $r_a$  through  $r_c$  are concerned. The first form of the functional model (Figure 2-1) has been used exclusively for the information flows in this Recommendation.

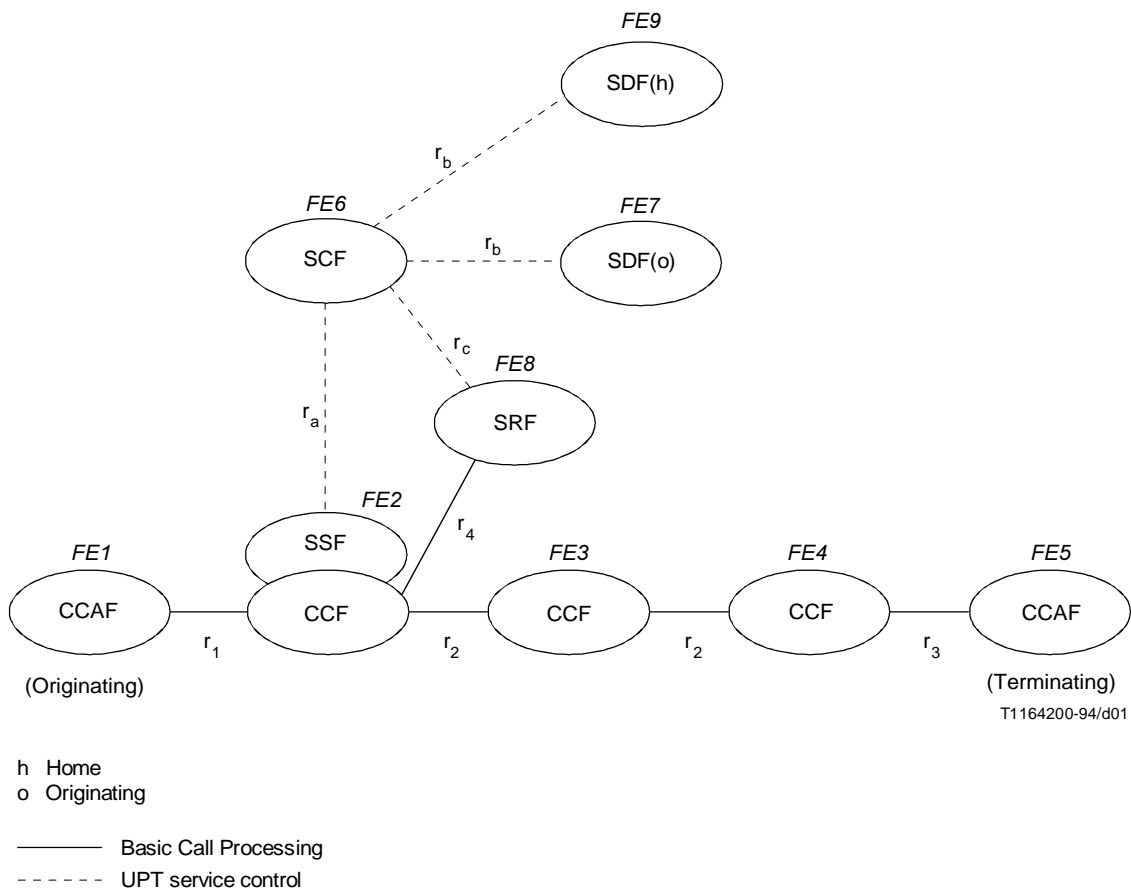

FIGURE 2-1/Q.76

Functional model for UPT Service Set 1 provision - SSF associated with originating CCF

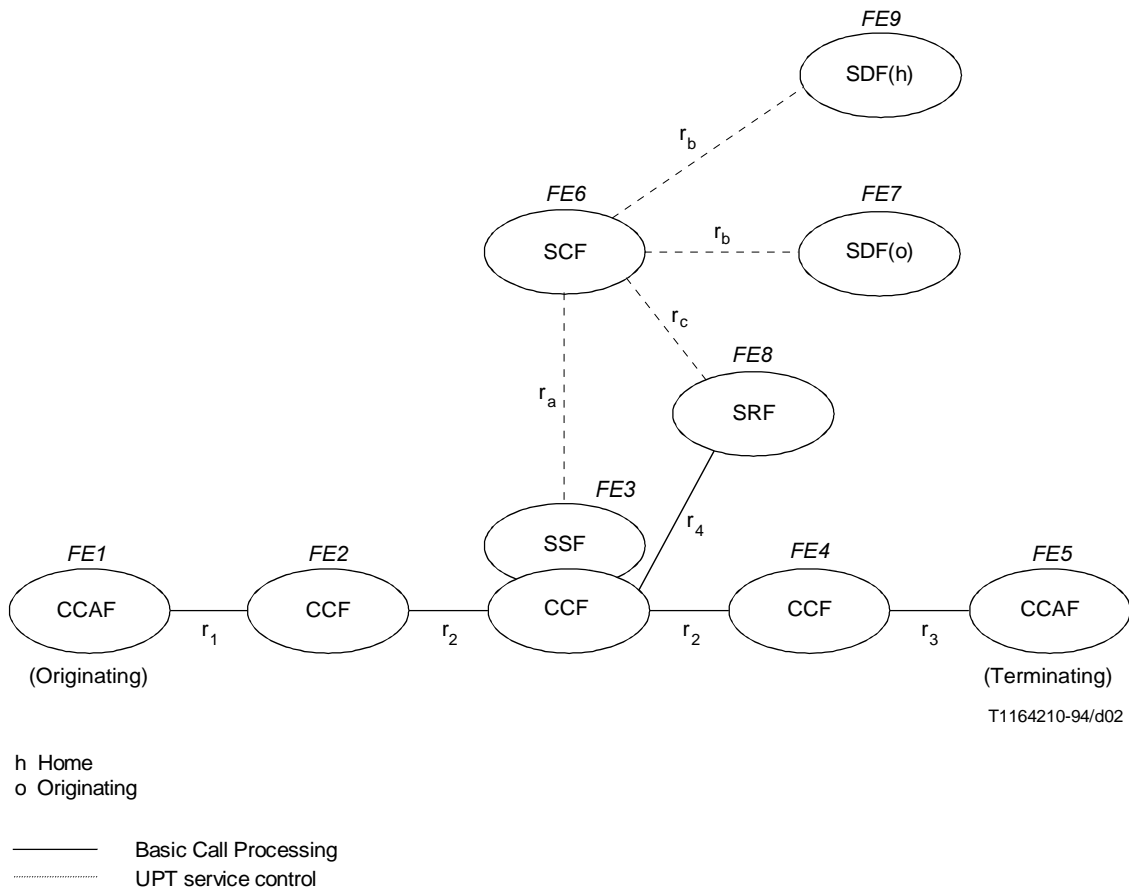

FIGURE 2-2/Q.76

**Functional model for UPT Service Set 1 provision - SSF associated with transit CCF**

Descriptions of the FEs are to be found in Recommendation 3.3/Q.1214 [4]. For the purposes of this Recommendation, the CCAF is identical with the CCA of Recommendation Q.71 [6]. The CCF is based on the corresponding Q.71 [6] ISDN definition but is modified for use in IN. The enhanced basic call state model of the IN defines standard detection points (DPs) at which IN service feature logic instances can be invoked. These DPs correspond to the Q.71 “hooks” where an ISDN supplementary service interfaces to the Q.71 basic call model. For the purposes of this Recommendation, relationships  $r_1$ ,  $r_2$  and  $r_3$  are outside the scope of the Recommendation and are identical with those defined in Recommendation Q.71 [6]. For the purposes of this Recommendation, relationship  $r_4$  is identical with relationship  $r_2$  of Recommendation Q.71 [6], since it involves the control of a connection between CCF and SRF in order to provide specialized resources such as tones and announcements.

In a single service example, one CCAF originates the call and the other CCAF terminates the call. The functions and relationships involved are not symmetric. This asymmetry is reflected in the different FE designations, FE1 and FE5, assigned to the two CCAFs and in the different relationship designations between CCAFs and CCFs ( $r_1$  and  $r_3$ ).

This Recommendation treats only the case where there is no transfer of the user’s service profile information and SDF(h) will be accessed for any query on or update of the UPT user’s data. Nevertheless, the SDF associated with the originating end of the call may contain some data related to the provision of UPT service to the visiting user. For example, SDF(o) may contain information on agreements with other UPT service providers. For the purposes of this

Recommendation, it is assumed that no additional security for interworking is provided other than such knowledge of existence of service agreements between service providers. It is assumed that SDF(h) will also be able to check that a service agreement exists with the service provider of the invoking SCF. SDF(o) may also contain data on local security measures, e.g. the number of retries allowed by the originating network to a UPT user attempting to access UPT service.

The various scenarios for connecting the SCF to the SRF are described in Recommendation 3.1.3.5/Q.1218 [5]. The information flows across the interface SCF-SRF (relationship  $r_c$ ) which are involved in UPT service interactions with the UPT user are not affected by the physical realization of the SRF connection. For illustrative purposes, the IFs used in this Recommendation are based only on case (ii) from Recommendation Q.1218 [5], in which the IP is directly attached to the SSP that is interacting with the SCP, but the SCP's operations to the IP are sent directly to the IP without SSP relaying being involved. Relaying is permitted if required, however. The IP must indicate to the SCP that it is ready to receive operations. SCF-initiated disconnection of SRF is assumed, except following call abandon or disconnect. No examples of SRF-initiated disconnection are shown.

### 3 Information flows for UPT Service Set 1

The main body of text of this Recommendation contains descriptions of all the essential and some of the optional features of UPT Service Set 1 for a variety of successful and unsuccessful operations. The UPT procedures defined in Recommendation F.851 [2] and included in this Recommendation fall into five main categories:

- elementary procedures for access, identification and authentication;
- personal mobility procedures;
- UPT call handling procedures;
- UPT service profile management procedures;
- third-party protection procedures.

The method by which a caller indicates that access to a UPT service procedure is required will depend on the procedure requested and on whether the caller is a UPT user or not. Where a UPT user requires a personal mobility (registration) or service profile management procedure, or wishes to make an outgoing call when not already registered for OutCall, then identification and authentication of the UPT user will always be required. In this case, some form of access procedure would be used to initiate the interaction with the UPT service.

The UPT user may send information to the UPT service provider in the network either in a prompted exchange of information or in one or a small number of messages (e.g. by using some form of ancillary device such as a DTMF tone sender). Strong authentication methods may require input of several items of information in one message. Only the prompt and response method is illustrated here.

It is assumed throughout that the user invokes access to UPT service by setting up a call to a UPT service provider. This is the CS-1 required method of invocation of services provided by an IN. The user is then connected to an SRF which provides the mechanism of interaction between the UPT user and the service provider. Interaction from the user to the UPT service provider is assumed to be by DTMF in-band signalling and from the service provider to the user by the voice announcement facility of the SRF. The wording of the announcements is to show intent only, not specific content. In-band DTMF signalling flows and voice announcements are shown on the diagrams by dotted lines.

The order in which the information is sent from the UPT user to the network (after initial access, specifically to the SRF) must be defined. The order in which the UPT user sends information to the UPT service provider in the network is assumed to be:

- a) access procedure (e.g. a special dialled code) (call set-up with information contained in SETUP req. ind.);

- b) identity of UPT user (e.g. UPT number) (interaction with SRF for this and remaining interactions);
- c) authentication information (e.g. PIN);
- d) identity of required UPT procedure (e.g. InCall);
- e) data for UPT procedure (e.g. network access address);
- f) optional follow-on procedure [followed by d), e) and f) as required].

An outline of the sequence in which procedures could be invoked is shown in Figure 3-1, which shows only those procedures which require prior authentication of the UPT user. Thus incoming call to a UPT user and third-party reset are not included, nor are all exit and error paths shown.

Where a third-party desires to invoke the reset procedure, to reset a registration for incoming calls in the absence of the UPT user, some form of access procedure will be required, but for the purposes of this Recommendation it is assumed that no input of identification or authentication information will be required from the caller.

In the case of an incoming call from any person to a UPT user, no access procedure is required but the UPT number must be identifiable as such. The method by which this will occur is outside the scope of this Recommendation.

NOTE – Recommendation E.168 provides some information on the means by which this may occur. It may be necessary to dial a prefix before the UPT number; this prefix might be network-dependent.

It is assumed that both the home and originating networks may apply limits on the number of retries that a UPT user may make if authentication, for example, is unsuccessful. For the purposes of this Recommendation, it is assumed that the values applying to such limits will be stored in SDF(o) and SDF(h), and it is assumed that the counter logic will reside in the originating SCF, in conformity with CS-1 guidelines (see Recommendations Q.1213 and 5.2.3/Q.1214 [4], Compare SIB). The implementation of counter logic within an SDF is within the scope of CS-1 enhancement. The mechanism to implement retry limits described in this Recommendation is meant to be illustrative and not definitive.

The Information Flows (IFs) and their contents (Information Elements, IEs) are based on those developed for the IN architecture, as described in clause 6/Q.1214 [4]. The individual Information Flows are described in clause 3.6 of this Recommendation. Whether IFs are confirmed or unconfirmed, and of type req. ind. or resp. conf., is described there. For the SSF-SCF interface there are alternative IFs at each detection point in the BCSM, as defined in clause 6/Q.1214 [4]. For example, at DP 3 Initial DP req. ind. and Analysed Information req. ind. are both valid IFs. For the purposes of this Recommendation, Initial DP req. ind. is shown always as the initiating IF from SSF to SCF. The use of DP-specific IFs (see 5.3.2.2/Q.1214 and clause 6/Q.1214 [4]) does not change the information specific to UPT which is carried by the IFs. Similarly, for the SCF to SSF IFs only Connect req. ind. has been shown and not the “proceed with call processing” family of IFs (5.3.2.2/Q.1214 [4]). Again, there is no change in the UPT-related information carried by the IFs.

The charging methods which are described in 5.2.2/Q.1214 [4] can apply to UPT service provided the principles of Recommendation D.280 [8] are followed.

For illustrative purposes, only examples of the use of IF Furnish Charging Information req. ind. are shown and only for outgoing and incoming calls. For example, in the PLMN environment more complicated charging methods will be required. Notes to some of the diagrams indicate where other charging IFs might be used. The information flow Update Data req. ind. as defined in 6.6.25/Q.1214 [4] and 2.1/Q.1218 and 2.3/Q.1218 [5] does not support an Add function, which will be required for such operations as adding charging or history records to a database. It will therefore be necessary to make a service-specific modification to the Update Data information flow and operation, to include the Add function for UPT realization. This requirement is within the scope of CS-1 enhancement.



In the information flow diagrams the CS-1 IF names are shown in mixed case lettering, without the req. ind. or resp. conf. descriptors. The full descriptions of these IFs are in 3.6. IFs derived from Recommendation Q.71 [6] are shown in upper case italic lettering, with type descriptors. The Q.71 IFs are SETUP, RELEASE and DISCONNECT.

The information flow diagrams do not show any IFs relating to timer control of interactions between functional entities. Not all error paths are considered. Details of those error paths which are included are given in the FEAs.

Where the SSF/CCF is required to send and react to both bearer and non-IN call control (see Recommendation Q.71 [6]) and IN call control IFs, the sequencing of the two classes of IF bears no relationship to each other, except that synchronization of the termination of sequences is assumed. For example, it has been assumed that the SSF/CCF will wait until all resources are released and the call is terminated before sending a Call Information Report to the SCF.

## **3.1 UPT elementary procedures and common sequences**

### **3.1.1 Access, identification and authentication**

For simplicity, it is assumed that the identity of the UPT user's service provider can be deduced from the UPT number. It is further assumed that, if there is a service agreement between the originating network service provider and the UPT user's service provider, then and only then does the originating SCF contain information identifying SDF(h). Other methods are possible.

#### **3.1.1.1 Outline description**

The following is a high-level description of the network actions required when a UPT user requests access to UPT service and undertakes identification and authentication:

- 1) Access code input by UPT user.
- 2) Recognition of access code, suspension of call processing in CCF, connection of SRF (Establish Temporary Connection).
- 3) Prompt and response for user identification (input UPT number).
- 4) Prompt and response for user authentication (input authentication code).
- 5) UPT user's service provider undertakes authentication check and sends result.
- 6) Decision:
  - if successful, continue to procedure identification;
  - if unsuccessful and more attempts allowed, advise user of failure and restart at 3);
  - if unsuccessful and no more attempts allowed, advise user and release call.

The initial access code will contain information that enables SSF/CCF to trigger on a statically armed detection point (TDP-R). Call processing will then be suspended at the detection point.

#### **3.1.1.2 Information flow diagrams**

The information flows are shown for the following procedures:

- Figure 3-2: Access, identification and authentication.
- Figure 3-3: Authentication rejection and retry.
- Figure 3-4: Maximum retries reached.

Information flows related to charging (if any) are not included.

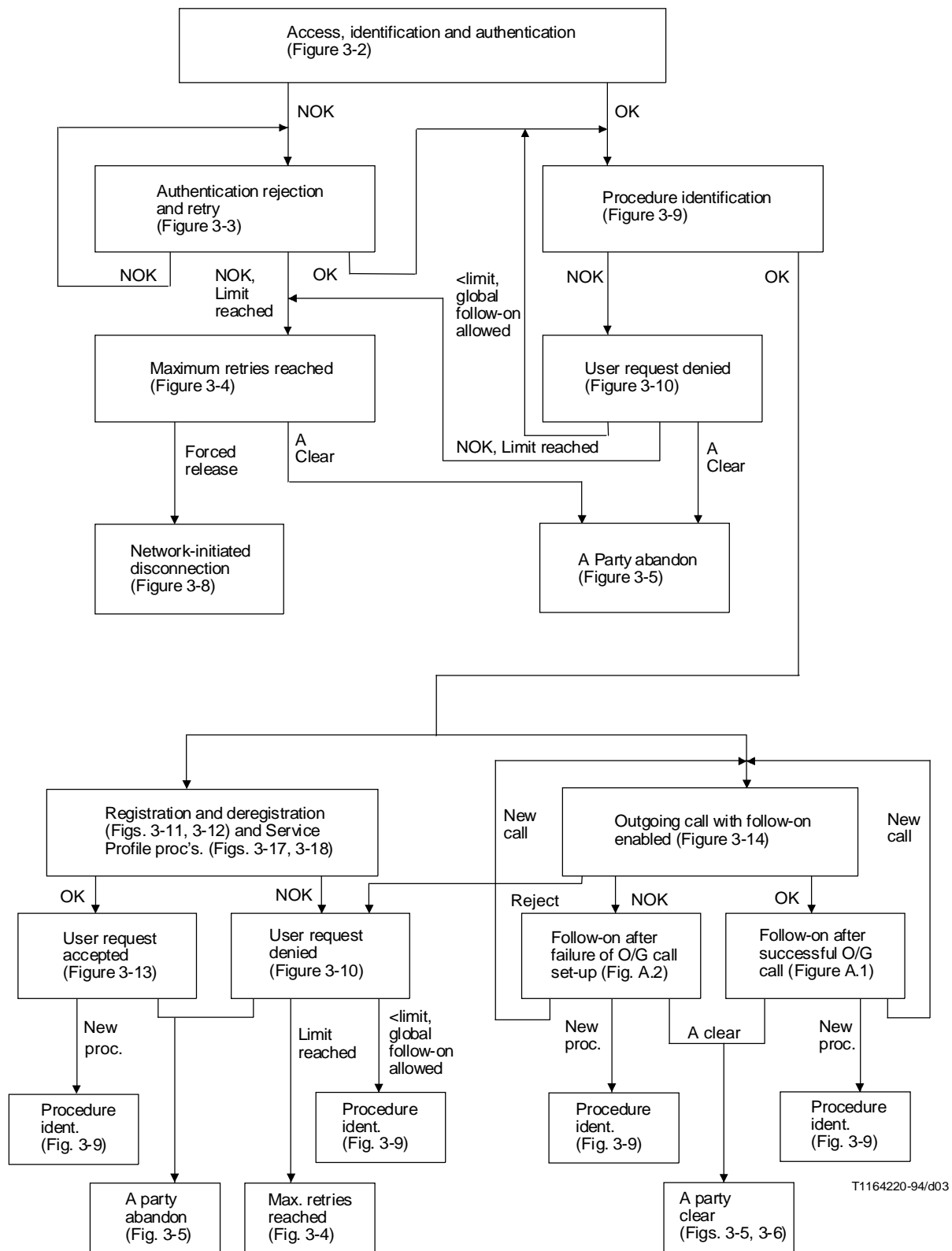

T1164220-94/d03

FIGURE 3-1/Q.76  
Outline of sequencing of UPT procedures

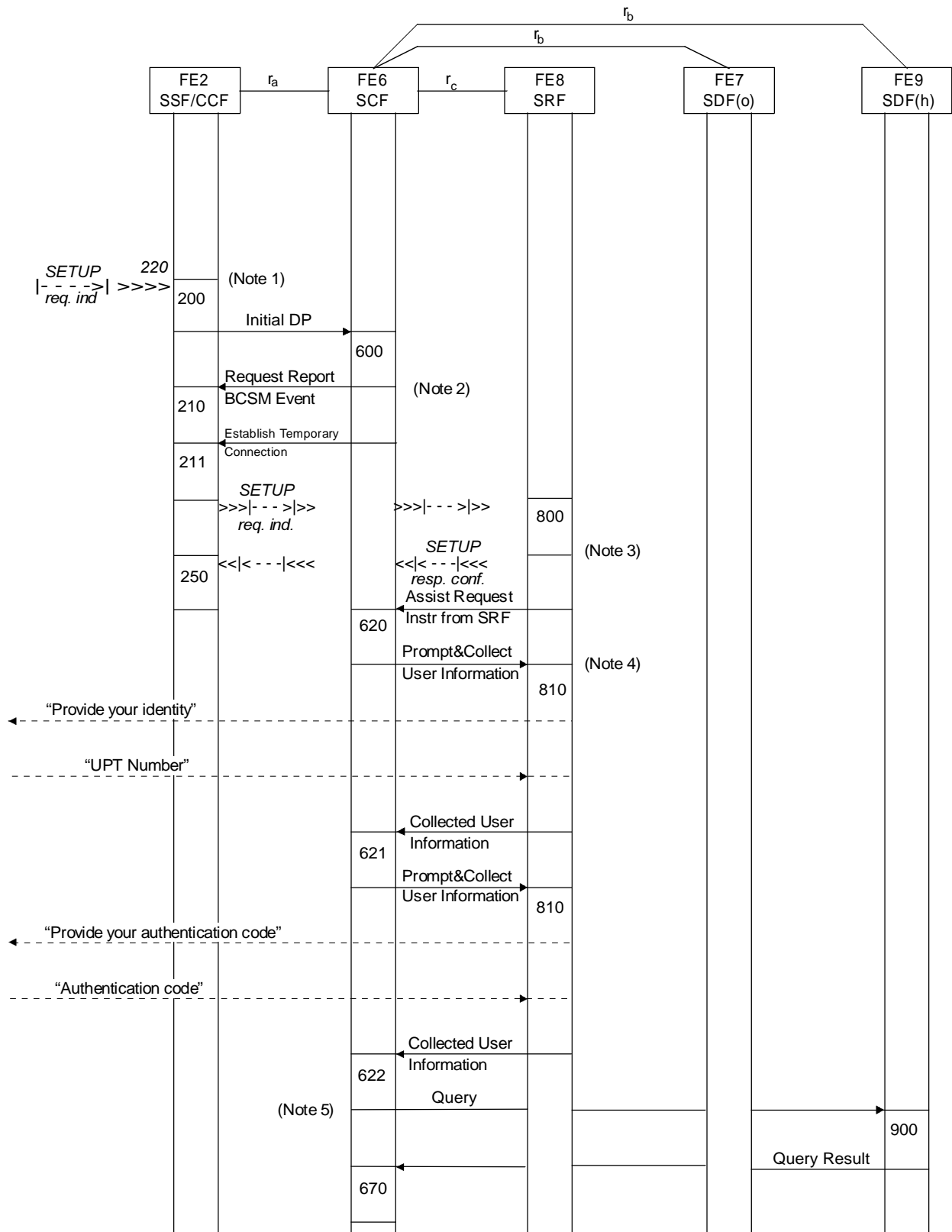

T1164230-94/d04

FIGURE 3-2/Q.76  
Access, identification and authentication

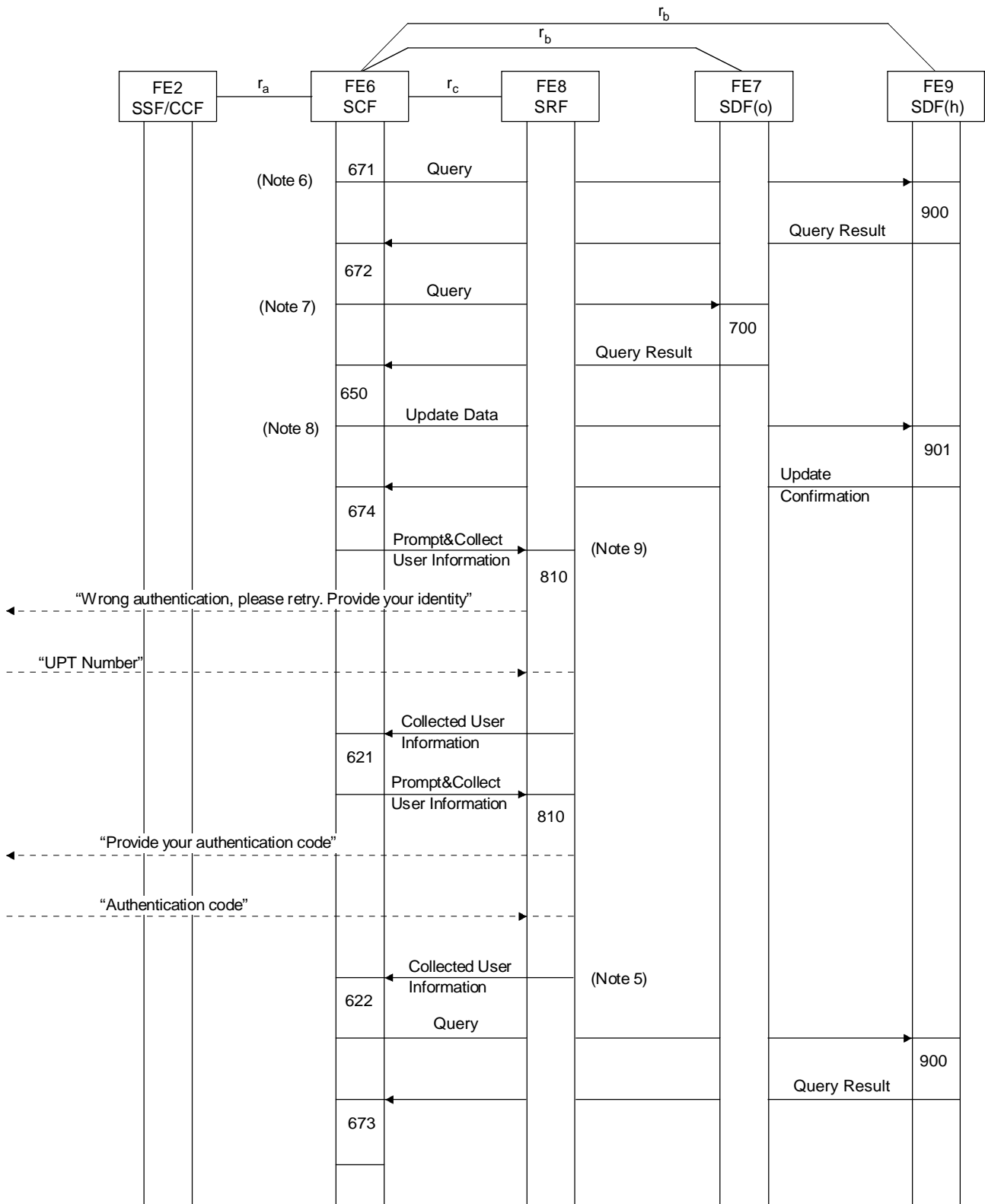

T1164240-94/d05

FIGURE 3-3/Q.76  
Authentication rejection and retry

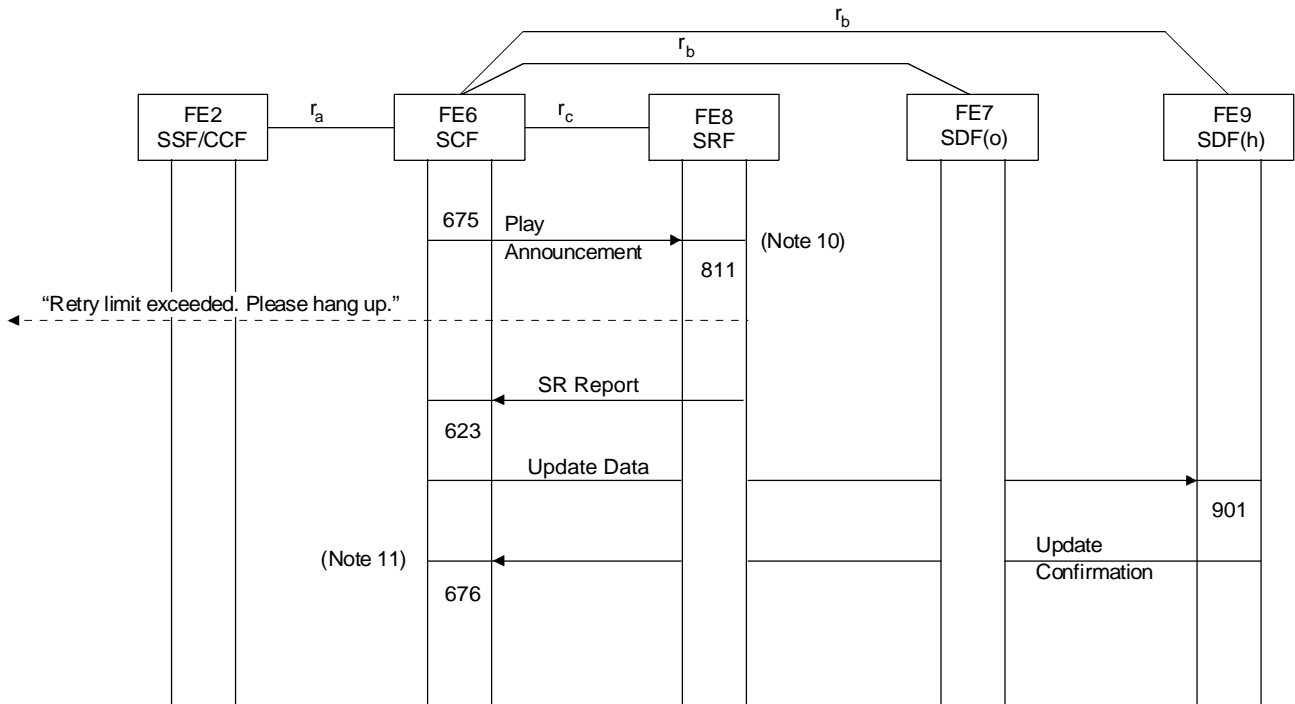

T1164250-94/d06

FIGURE 3-4/Q.76  
Maximum retries reached

**NOTES related to Figures 3-2 to 3-4**

- 1 The contents of SETUP req. ind. from FE1 (CCAF) to FE2 (SSF/CCF) are some form of UPT service access code. This may be interpreted as a special "UPT access number", to enable routing towards an exchange which contains an SSF. This is one possible implementation. Other solutions might be envisaged. The nature of the SETUP req. ind. is dependent on the network in use (PSTN, ISDN, PLMN). The access code might be different for different procedures, e.g. where reset is being requested.
- 2 On initiation of a UPT service procedure, Detection Point 10 is dynamically armed by Request Report BCSM Event req. ind. to detect calling party abandon (EDP-N). This IF may not be necessary, as it is possible that DP 10 will be statically armed (as TDP-N) for UPT or for all services provided by an IN. If required, Call Information Request req. ind. could also be sent at this point.
- 3 The order in which the SRF sends the SETUP resp. conf. and the Assist Request Instructions from SRF req. ind. is not significant.
- 4 The user is prompted to input his UPT number by dialling digits or using a DTMF tone sender, for example. The full UPT number may be required to allow identification of the UPT user's service provider. SCF-initiated disconnection of SRF is assumed, hence the SRF is not allowed to disconnect at the end of user interaction.
- 5 Authentication is undertaken by the UPT user's service provider. Records of identification and authentication attempts will be kept in SDF(h). If authentication is successful, the sending of the next request to the UPT user for more information implicitly advises the user that authentication has been successful. A specific announcement of success might optionally be provided. The UPT user is now successfully authenticated and UPT procedure initiation can now take place. If authentication fails, action proceeds to "Authentication rejection and retry" (see Figure 3-3).
- 6 Once authentication fails, a count must be kept of the number of retry attempts. On first execution of this sequence, the limit set by the UPT user's service provider is retrieved from SDF(h).

7 On first execution of this sequence, the retry limit of the originating UPT service provider is retrieved from SDF(o). The counter logic resides in the SCF. It is assumed that the SCF would use the smaller of these two values as the allowed limit, should they be different.

8 The count of authentication failures is now recorded in SDF(h) for security and administration purposes.

9 If authentication fails, the specific reason for failure should not be advised to the user, for security reasons. Therefore both the UPT number and the authentication code will need to be re-entered.

10 The SRF now plays a final announcement to the user. SRF-initiated disconnection could be used to disconnect the SRF in this case, but has not been shown.

11 The SDF(h) is updated with a record of the failed attempts if not already done. Security measures may be required to reject further attempts. The user is advised of failure and requested to hang up. The network then does a forced release of the call and disconnects the SRF (see Figure 3-8).

### 3.1.2 Call release sequences

One of the sequences for release of the calling user (see Figures 3-5 to 3-8) will take place at the end of every UPT procedure or call. The sequences can be initiated by the user hanging up either spontaneously, or as the response to an announcement, or by forced release by the originating network. The SCF can initiate a forced release, either immediately or after a timeout, e.g. if the user does not hang up within a specified time of being requested to do so.

The following release sequences are shown:

- a) *A-party abandon* – At any time (before answer if another party involved) in all procedures or A-party disconnect after B-party, follow-on enabled in outgoing call; SRF may or may not be connected (see Note 1).
- b) *A-party disconnect* – After answer in call handling procedures (see Note 1).
- c) *B-party release* – Only for call handling procedures, at any time after answer for
  - 1) incoming call to UPT user;
  - 2) outgoing call from UPT user, single call, no follow-on allowed (see Note 2).
- d) *Network-initiated release* – At end of procedure or on error or failure, e.g. after authentication rejection, and after reset procedure.

#### NOTES

1 The differences in the release sequences for A-party abandon and disconnect are covered in Notes to Figures 3-5 and 3-6.

2 The case of B-party release when follow-on is allowed, either after conversation or because of call set-up failure, is covered in Figures A.1 and A.2. If the A-party then clears, instead of making a follow-on call, Figure 3-5 applies.

In Figures 3-5 to 3-8, the release sequences apply to the case of ISDN access. For PSTN simple sequences will apply.

It is assumed that the appropriate detection points for detecting call abandon (DP 10) and disconnect (DP 9) will always be appropriately armed as EDP-N for detecting A-party release, so the case of unarmed DPs has not been shown. For detecting B-party disconnect for follow-on outgoing calls, DP 9 will also be armed as EDP-R with Leg ID information element specified as B-party.

For B-party initiated disconnection, depending on the signalling protocols in use between CCFs, the originating CCF will need to recognize Release, Clearback and Suspend (network initiated) messages. The O\_Disconnect information flow could be used instead of Event Report BCSM to pass the Release Cause information element to the SCF, if required. This has not been shown here, and Event Report BCSM req. ind. is used to report detection of DP 9, O\_Disconnect.

The sequence for release of the SRF (if connected) following call abandon is assumed to be controlled by the SSF/CCF (see 3.1.3.5.3/Q.1218 [5]). The SSF/CCF sends RELEASE req. ind. to the SRF to release it without waiting for the disconnect request (Disconnect Forward Connection) from the SCF. The SCF is advised of call termination by sending Event Report BCSM to SCF. Once the SCF is thus advised that dialogue with the SSF is terminated, it will await any

outstanding Call Information Report before returning to the idle state.

The procedures for call release are based on the corresponding procedures in Recommendation Q.1218. In particular, for call abandon before answer, 3.1.1.4/Q.1218 [5] requires that all CCF resources have been de-allocated before sending notification (Event Report BCSM req. ind.) to the SCF. When the first party disconnects after answer, the Event Report BCSM req. ind. is sent first and thus precedes de-allocation of CCF resources. This is required for implementing follow-on in outgoing calls.

In the case of network-initiated disconnection, if the SRF is connected it must first be disconnected (by Disconnect Forward Connection req. ind. for SCF-initiated release). Otherwise the Release Call req. ind. will be ignored by the SSF, as described in 3.1.1.5.4/Q.1218 [5].

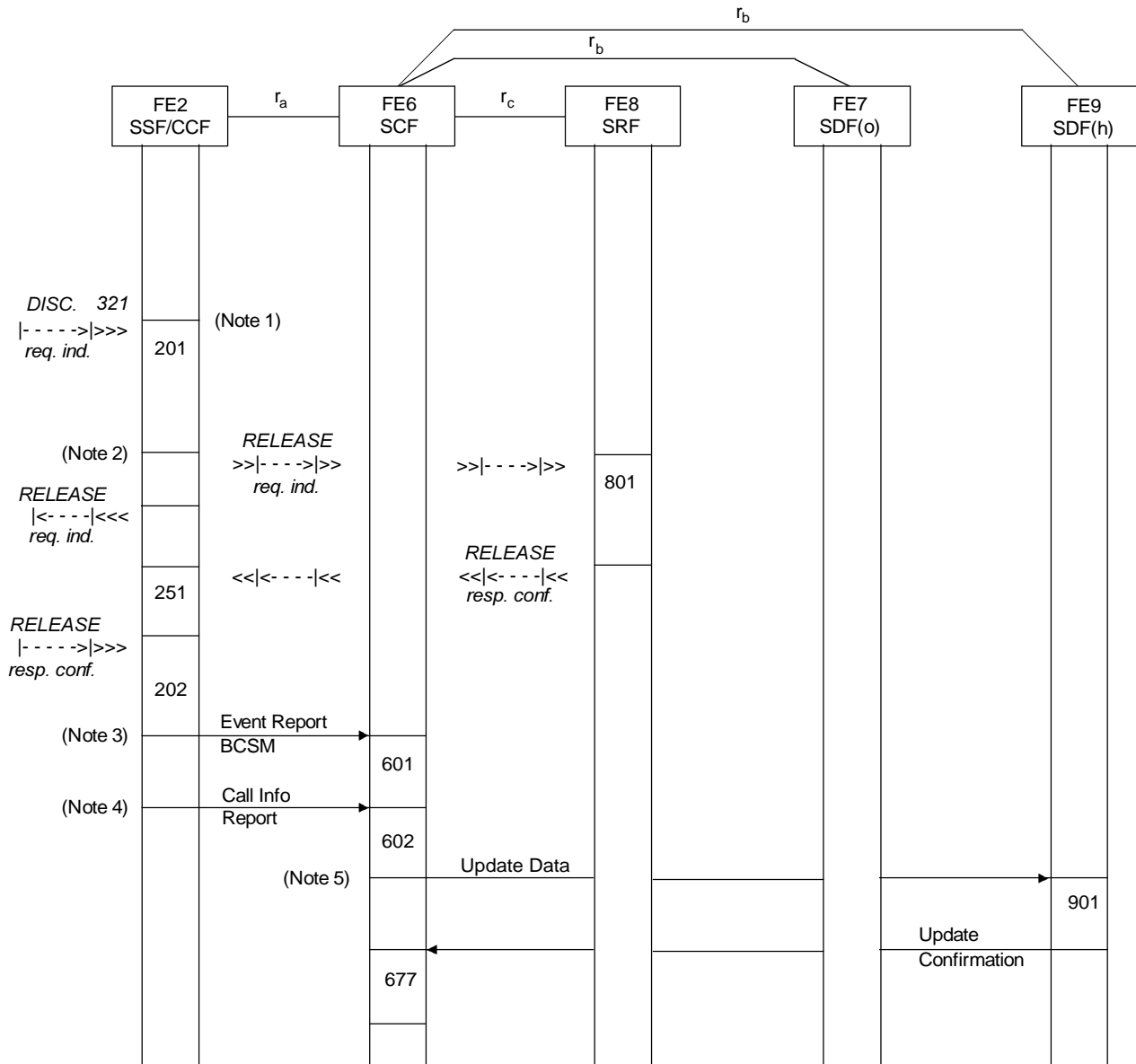

T1164260-94/d07

NOTE – Q.71 information flows are shown by chevrons and dashed lines; text in italics refers to Q.71 information flows and FEAs.

FIGURE 3-5/Q.76  
A-party abandon

### 3.1.2.1 Information flow diagrams

The information flows are shown for the following procedures:

- Figure 3-5: A-party abandon.
- Figure 3-6: A-party initiated disconnection.
- Figure 3-7: B-party initiated disconnection.
- Figure 3-8: Network initiated disconnection.

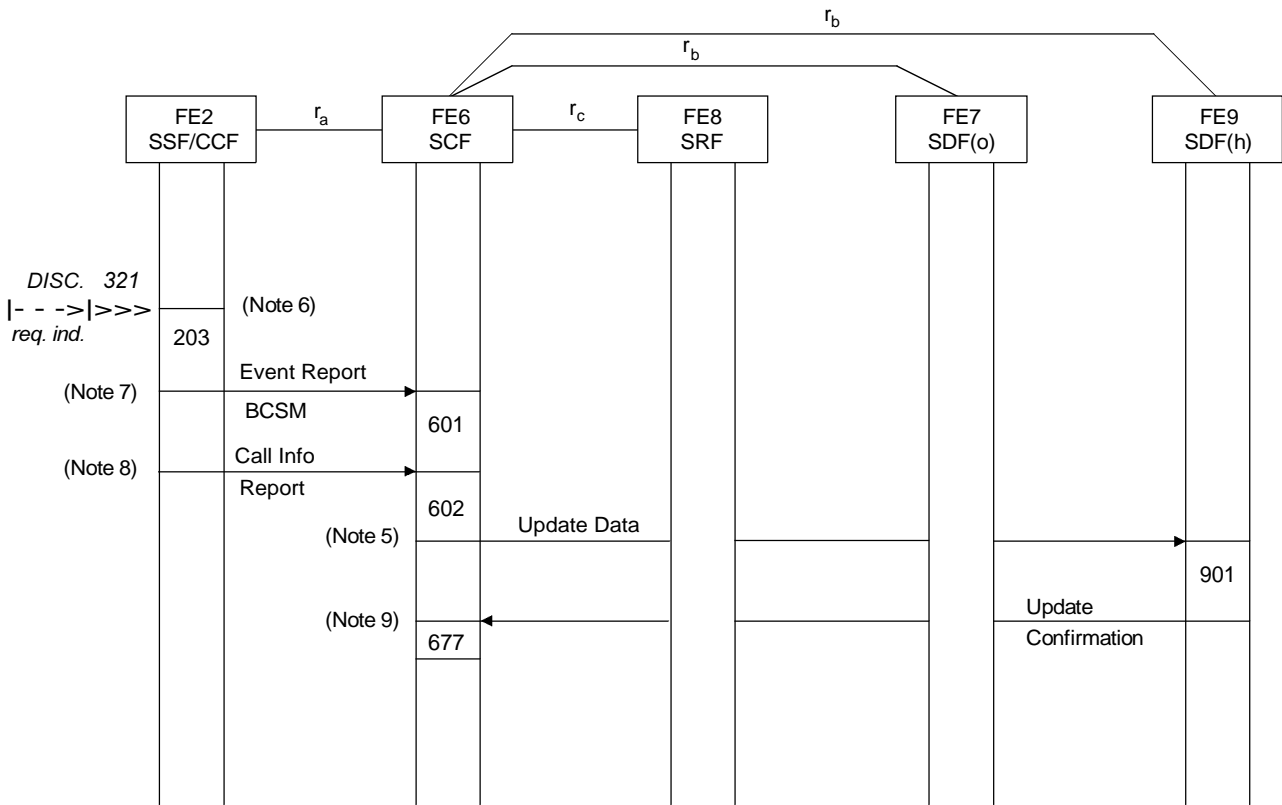

T1164270-94/d08

NOTE – Q.71 information flows are shown by chevrons and dashed lines; text in italics refers to Q.71 information flows and FEAs.

FIGURE 3-6/Q.76  
A-party initiated disconnection



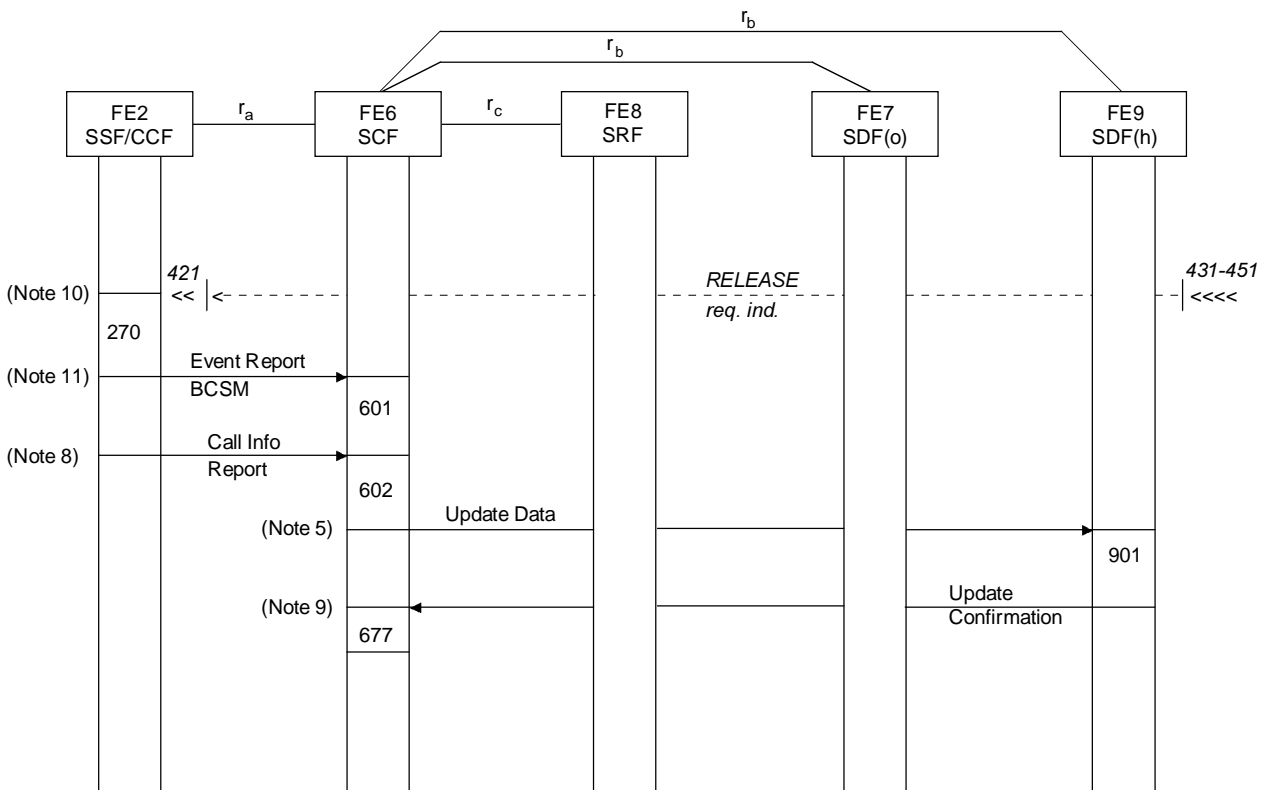

T1164280-94/d09

NOTE – Q.71 information flows are shown by chevrons and dashed lines; text in italics refers to Q.71 information flows and FEAs.

FIGURE 3-7/Q.76  
**B-party initiated disconnection**

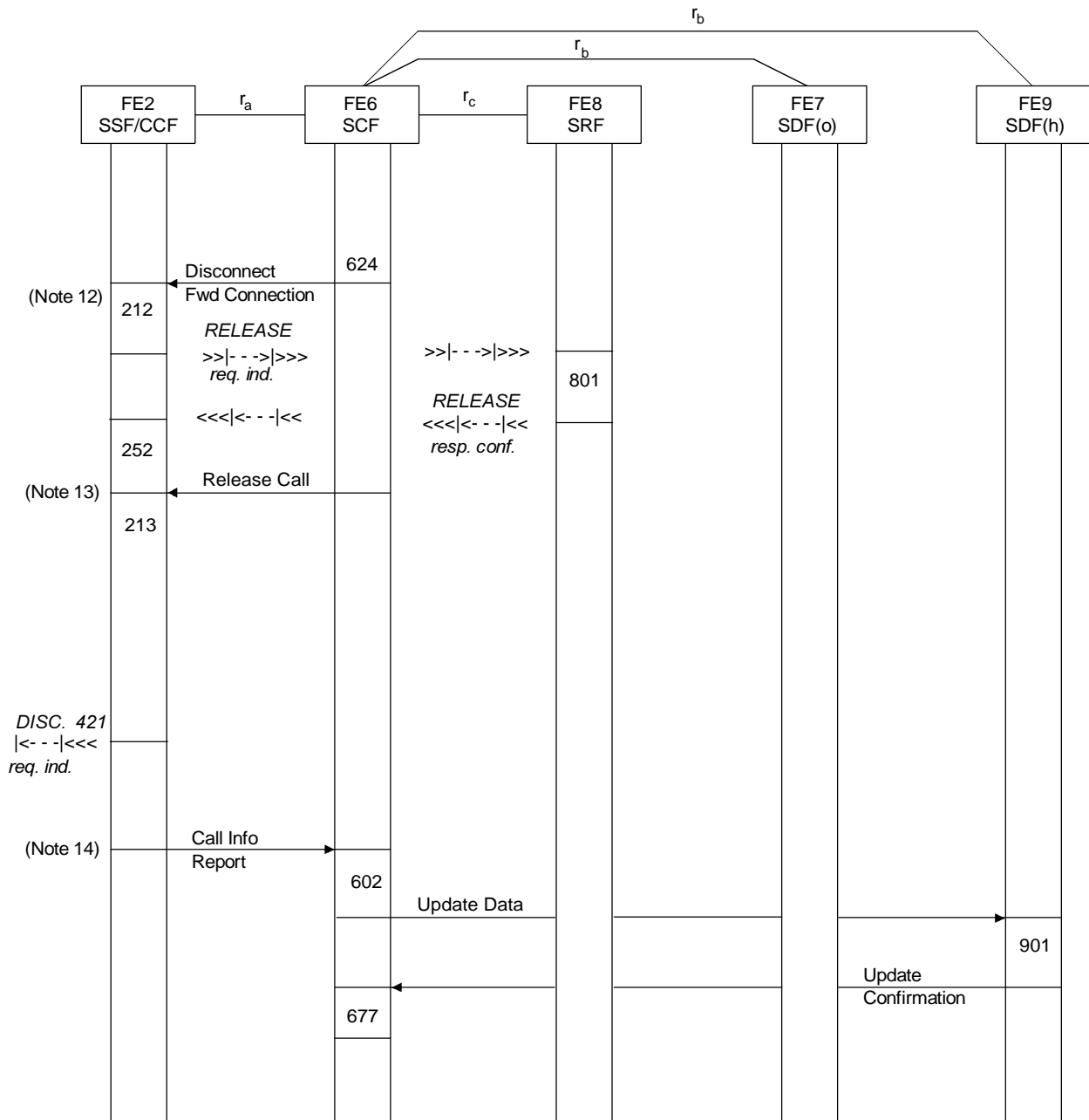

T1164290-94/d10

NOTE – Q.71 information flows are shown by chevrons and dashed lines; text in italics refers to Q.71 information flows and FEAs.

FIGURE 3-8/Q.76  
**Network initiated disconnection**

## NOTES related to Figures 3-5 to 3-8

- 1 The calling party has abandoned before answer. The event has been detected at DP 10, armed as EDP-N.
- 2 The SRF may or may not be connected, but if so, the CCF will release it as part of normal clear-down.
- 3 All release actions are completed by the CCF before sending advice of A-party abandon to the SCF by Event Report BCSM req. ind. (see 3.1.1.4/Q.1218 [5]).
- 4 The order in which the RELEASE resp. conf.'s are received is not significant but the SSF will wait for the CCF to receive the last RELEASE resp. conf. before sending any outstanding Call Information Report req. ind. to the SCF.
- 5 SDF(h) will be updated with information from the Call Information Report req. ind.
- 6 Calling party has disconnected first in an incoming or outgoing call. DP 9 is armed as EDP-N.
- 7 For disconnection (i.e. after answer), Event Report BCSM req. ind. is sent immediately rather than after the CCF has cleared the call.
- 8 Call Information Report req. ind. is sent if required.
- 9 Clear-down continues as described in Recommendation Q.71 [6].
- 10 For this procedure the B-party has released first in an outgoing call from a UPT user where follow-on is not allowed, or the UPT user has released first in an incoming call to a UPT user. The possibility of allowing B-party re-answer has not been considered.
- 11 Event Report BCSM req. ind. is sent to SCF to report B-party release.
- 12 The SRF, if connected, is disconnected by SCF-initiated release (Disconnect Forward Connection req. ind.). This must be sent before sending the Release Call req. ind., otherwise the Release Call req. ind. will be ignored by the SSF, as described in 3.1.1.5.4/Q.1218 [5].
- 13 The CCF now initiates disconnection of the A-party, as described in Recommendation Q.71 [6]. Any remaining armed DPs will be ignored.
- 14 At end of call a record is sent to SCF to be used, e.g. for statistics, and SDF(h) is updated.

### 3.1.3 Procedure identification including global follow-on

Procedure identification follows after successful identification and authentication. It is followed by specific personal mobility, call handling or service profile management procedures. It is assumed that a limit will be applied to the number of unsuccessful attempts to identify a procedure that a user may make. No limit is applied to successful attempts.

#### 3.1.3.1 Outline description

The following is a high-level description of the network actions for the UPT user to input procedure identification:

- 1) Procedure identification (prompt/response) – reply Procedure “type”.
- 2) Query originating SDF to determine if service agreement for that procedure exists with home service provider.
- 3) Query home SDF to determine if UPT user has subscribed to this procedure.
- 4) Decision:
  - if successful, go to procedure requested;
  - if unsuccessful, go to “User request denied” (see Figure 3-10).

The following is a high-level description of the actions following denial of user request. The method shown is illustrative only and is not intended to be definitive.

- 1) On first execution only of the sequence, retrieve the retry limit value for procedure identification requests from the UPT user’s home service provider.
- 2) On first execution only of the sequence, retrieve the originating UPT service provider’s retry limit.

- 3) On first execution only, start retry counter logic in the SCF, using the smaller of the two limit values, if there is a difference (see Note).
- 4) Modify the counter and test whether the limit of retries is reached.
- 5) Decision:
  - if reached, go to “Maximum retries reached” (Figure 3-4);
  - if not reached, request user to invoke another procedure or terminate (global follow-on).

NOTE – Logic for the retry counter is in SCF (CS-1 requirement – see 2.3/Q.1213, Compare SIB, and 5.2.3/Q.1214 [4]).

### 3.1.3.2 Information flow diagrams

The information flows are shown for the following procedures:

- Figure 3-9: Procedure identification.
- Figure 3-10: User request denied including global follow-on.

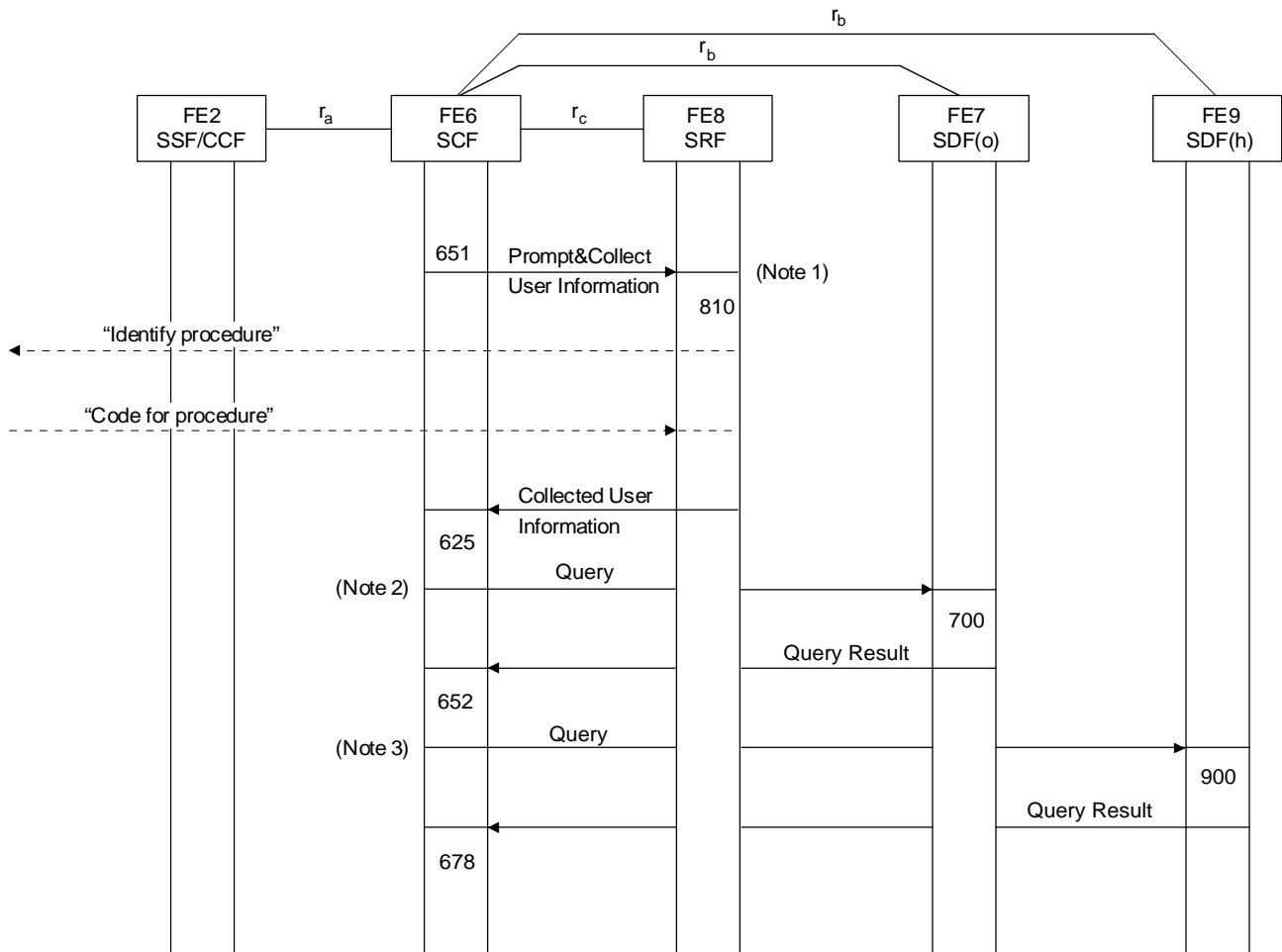

T1164300-94/d11

FIGURE 3-9/Q.76  
Procedure identification

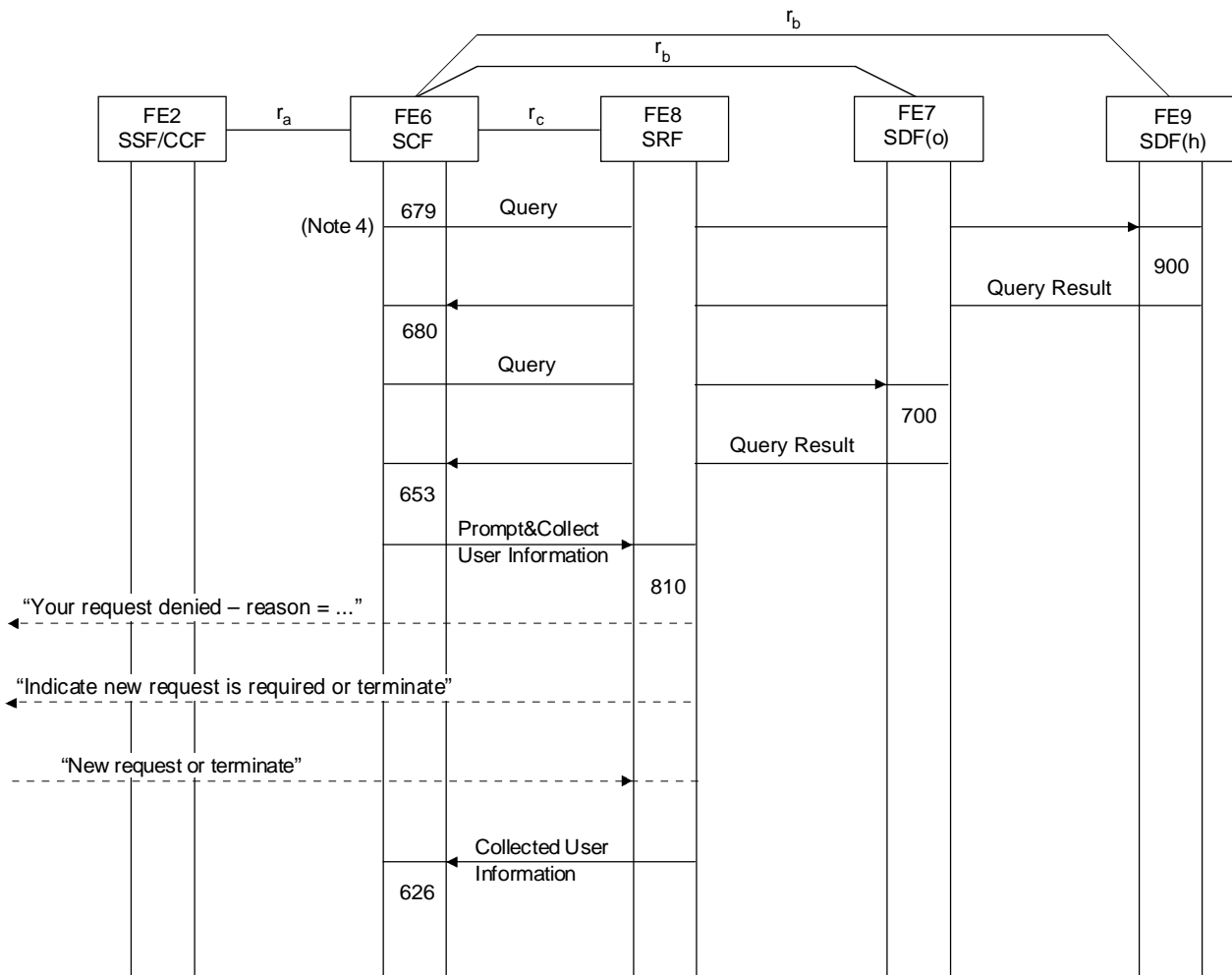

T1164310-94/d12

FIGURE 3-10/Q.76  
User request denied including global follow-on

#### NOTES related to Figures 3-9 and 3-10

- 1 Depending on the format of the procedure identification code, it may be necessary for the user to input the request in two steps. For example, the user might initially input a response of a code for "Registration", which would be followed by a request to identify the type of registration (InCall, OutCall, etc.). Alternatively different codes might be defined for each registration procedure.
- 2 The SDF(o) query is intended to check locally whether the UPT user is allowed to use the particular procedure requested, e.g. whether an agreement exists between the service providers of the visited (originating) and home networks.
- 3 The SDF(h) query is intended to check whether the user is permitted by his own network to use the procedure requested.
- 4 Limit values on retries are retrieved from home and originating SDFs on first execution of this sequence. The lower of the two values will be used by the SCF if there is a difference.

### 3.2 Procedures for personal mobility

#### 3.2.1 Registration and deregistration

"Registration" and "deregistration" are generic names used in this Recommendation to describe InCall registration and deregistration, in which the UPT user registers a terminal address to which incoming calls are to be presented and

deregisters either by registering for a new address or by a specific deregistration procedure.

The procedures for InCall registration and deregistration are shown in Figures 3-11, 3-12 and 3-13.

Local and remote registration are supported by the user inputting the terminal address required. Remote registration is registration on a terminal other than the one being used for the registration procedure. Unless the remote terminal address is in a network which supports UPT service it will not be possible to check the validity of the specified address.

For UPT Service Set 1, InCall registration and deregistration on the current terminal are classified as **essential** procedures and remote registration and deregistration are **optional**.

### 3.2.1.1 Outline description

The following is a high-level description of the network actions required when a UPT user invokes a registration procedure. Access, identification and authentication have already been completed and the registration or deregistration procedure required has been identified.

- 1) Input new location and echo to user (see Note 1).
- 2) Input other optional parameters (not shown in diagrams).
- 3) Query originating SDF to verify that UPT user is allowed by originating network to register on the terminal address specified (see Note 2).
- 4) Query home SDF to verify that UPT user is allowed by home network to register on the terminal address specified (see Note 2).
- 5) Update and confirmation of location data in SDF(h).
- 6) Decision:
  - if successful, advise user of success and request new procedure (“User request accepted”, Figure 3-13);
  - if unsuccessful, go to “User request denied” (see Figure 3-10).

#### NOTES

1 If the originating terminal address is available, it is an implementation matter for the service provider to allow the registration address to default to the terminal address if no value is entered.

2 This check is optional; actions otherwise might include, for example, unconditional acceptance of registration or, conversely, remote registration disallowed.

A high-level description of deregistration is:

- 1) Retrieve default address from SDF(h).
- 2) Update location address in SDF(h) to restore default value of address.
- 3) Decision:
  - if successful, advise user of success and request new procedure (“User request accepted”, Figure 3-13);
  - if unsuccessful, go to “User request denied” (see Figure 3-10).

### 3.2.1.2 Information flow diagrams

The information flows are shown for the following procedures:

- Figure 3-11: Registration for InCall.
- Figure 3-12: Deregistration for InCall.
- Figure 3-13: User request accepted including global follow-on.

At commencement of registration or deregistration successful authentication and procedure identification have already occurred, and the connection from the UPT user to the SRF still exists.

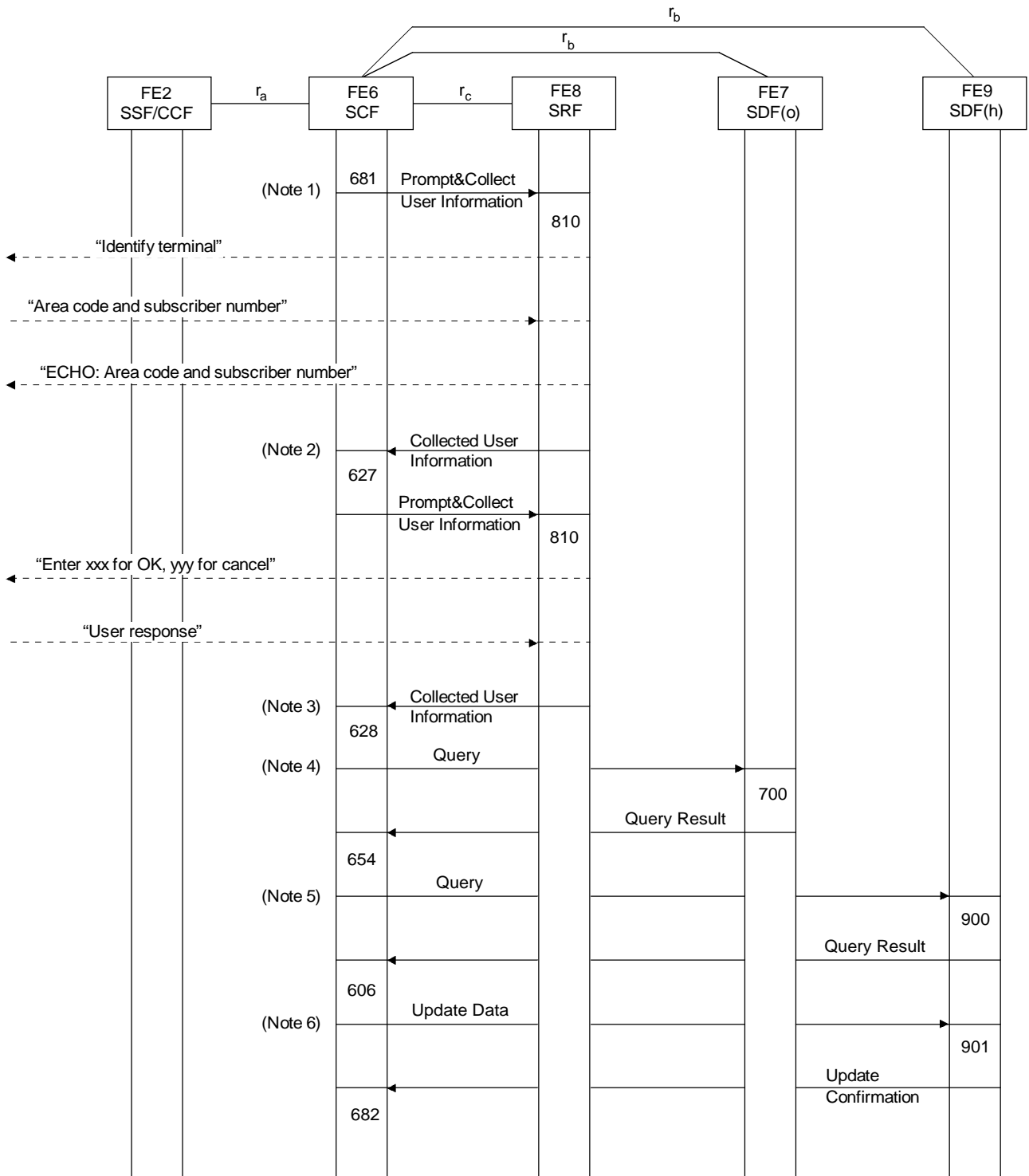

T1164320-94/d13

FIGURE 3-11/Q.76  
Registration for InCall

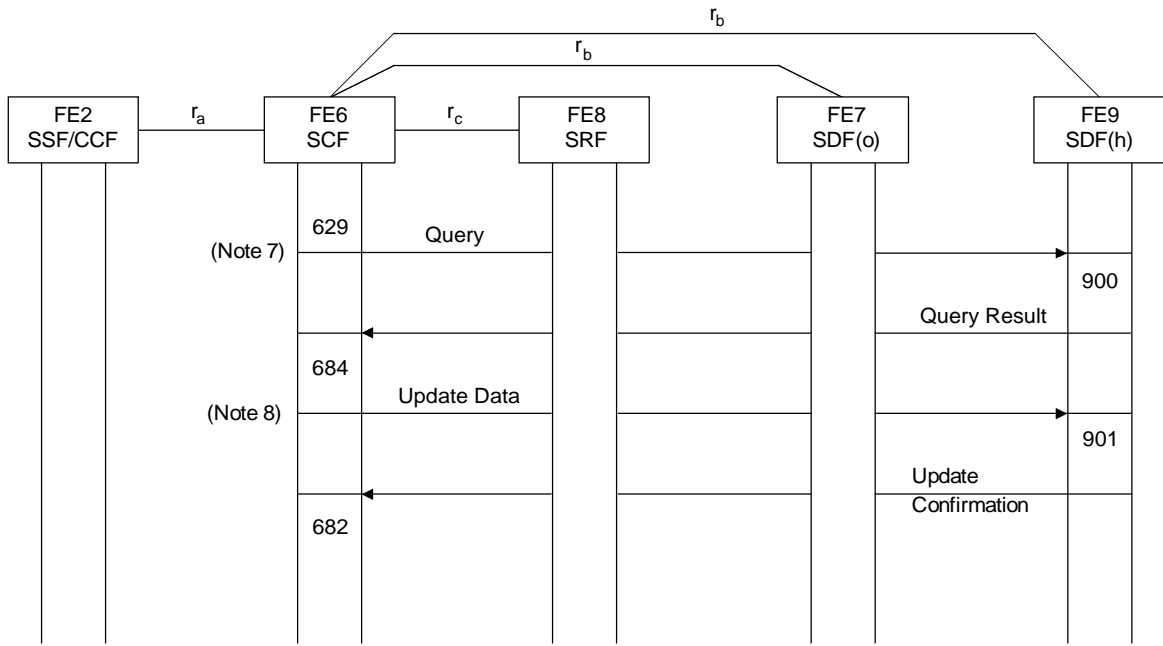

T1164330-94/d14

FIGURE 3-12/Q.76  
Deregistration for InCall

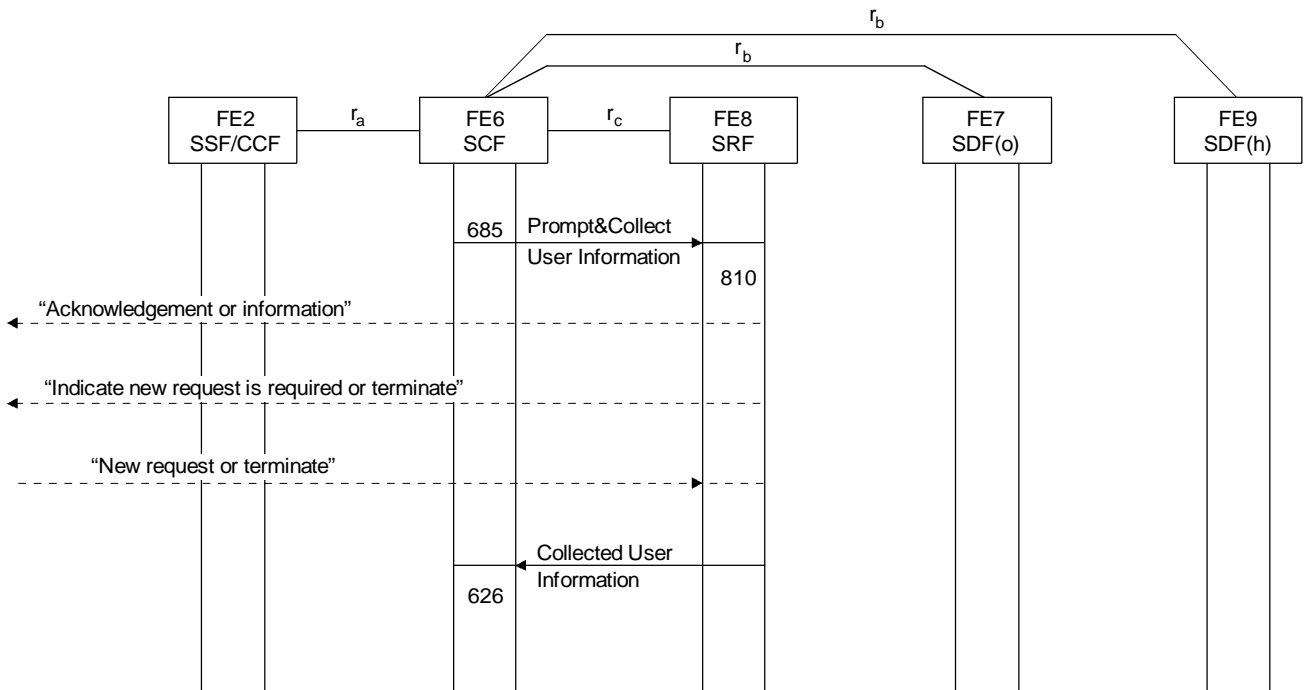

T1164340-94/d15

FIGURE 3-13/Q.76  
User request accepted including global follow-on



## NOTES related to Figures 3-11 to 3-13

- 1 The user has already identified the specific registration procedure required. The user must input the specific terminal address for the registration, which may not be the address of the terminal currently being used if remote registration is allowed. If the originating terminal address is available, it is an implementation matter for the service provider to allow the registration address to default to the terminal address if no value is entered. The new location should be echoed to the user for verification.
- 2 The user is prompted to confirm or reject the echoed data.
- 3 If the user cancels, control transfers to “User request denied” (see Figure 3-10). Alternative actions which could be taken if the user rejected the echoed value might include allowing a new attempt at entering registration data. A limit on the number of retries would be required. Other information can optionally be input for registration, requiring further requests and responses. Details are contained in Recommendation F.851 [2].
- 4 The optional SDF(o) query is to verify the UPT user’s permission to register on the specified originating network access, i.e. restrictions on the use of the terminal address specified. If the specified address is outside the originating network, then the target network SDF may be queried, if possible.
- 5 SDF(h) is queried to determine if there are any restrictions on the specified address.
- 6 SDF(h) is updated with the new registration address.
- 7 This query to SDF(h) is used to retrieve the appropriate default registration value.
- 8 The current registration location is replaced with the default value.

## 3.3 UPT call handling procedures

### 3.3.1 Outgoing calls

This Recommendation considers only the case of outgoing UPT call as described in 5.3.1/F.851 [2]. It does not cover the case of outgoing calls subsequent to OutCall registration (see 5.2.3/F.851 [2]).

Outgoing calls from a UPT user may be single calls, in which the procedure terminates at the end of the call, or may allow follow-on. The follow-on request may be for another call (“OutCall follow-on”) or for another UPT procedure (“global follow-on”). Follow-on will be offered to the UPT user after the B-party disconnects at the end of a conversation, or following call set-up failure due to route congestion, B-party busy or B-party no answer. For UPT Service Set 1, single outgoing call is classified as **essential** and OutCall and global follow-on are **optional**.

There are some difficulties in implementing these requirements within the constraints of normal call release procedures. If follow-on calls are to be implemented, the handling of normal network release sequences must be modified. The requirement is that resources in the forward direction are fully released when the B-party clears after conversation or if call set-up fails, but that resources in the backward direction (originating exchange to A-party) are not released until the A-party clears. Pending agreed solutions to these changes, follow-on calls are described in Annex A, where further discussion of the release mechanisms may also be found.

Call processing is suspended, the SRF is connected and the UPT user has specified that outgoing call is required.

It is assumed that the SCF can recognize UPT numbers. The user is prompted to input the destination number, which may be a UPT number; if so, it is translated by the SCF (involving queries to the originating and home SDFs). The SRF is disconnected and processing is restarted using the Connect operation which contains the destination number (even if it were the dialled number). If follow-on is enabled, various Detection Points will be armed (as EDP-R) to suspend processing when any follow-on event is detected. In CS-1 terms, a control relationship then exists between the SCF and SSF and the original transaction still exists.

### 3.3.1.1 Outline description

The following is a high-level description of the actions required for the network to set up an outgoing call. The user has requested outgoing call and the SRF is still connected.

- 1) Prompt user to input destination number.
- 2) Collect destination number.
- 3) Authorize destination number [optional, interaction with SDF(h)A].
- 4) If number is a UPT number, translate it to the called UPT user's current InCall location [involves SDF(h)B].
- 5) Disconnect SRF.
- 6) Arm A-disconnect and B-disconnect trigger (DP 9) (twice) and triggers to detect call set-up failure (DPs 4, 5, 6); also arm DP 8 to detect mid-call feature activation (if required) and activate application timer on "B-party no answer" (if required).
- 7) "Furnish Charging Information" operation (or other charging operation).
- 8) "Call Information Request" operation (if want transfer of call data to SDF at end of call).
- 9) Connect to destination number using "Connect" operation.

For follow-on call only:

- 10) B disconnects after conversation, or call set-up fails.
- 11) Report to SCF (Event Report BCSM or Route Select Failure operation).
- 12) Reconnect SRF ("Establish Temporary Connection" operation).
- 13) Prompt for next user input.
- 14) Go to 1) (follow-on call)(unless A disconnects also) or to procedure identification.

### 3.3.1.2 Information flow diagrams

The information flows are shown for the following procedure:

- Figure 3-14: Outgoing call set-up.

### 3.3.2 Incoming call to UPT user

Any person can make a call to a UPT user. The case of a UPT user calling a UPT user is covered in 3.3.1, Outgoing calls. This subclause deals only with a non-UPT user calling a UPT user. For simplicity, only the case where the caller's local exchange has SSF capabilities is shown here.

#### 3.3.2.1 Outline description

The following is a high-level outline of the network actions required for an incoming call to a UPT user:

- 1) detect UPT number dialled by number prefix;
- 2) query/response for translation [to SDF(h)];
- 3) play advice of charging announcement to caller (optional);
- 4) initiate charging (may be required for both parties if split charging);
- 5) "Call Information Request" operation (optional);
- 6) "Connect" operation to restart call processing with translated number;
- 7) call data update to SDF(h) at the end of the call (if requested).

#### 3.3.2.2 Information flow diagrams

The information flows are shown for the following procedure:

- Figure 3-15: Incoming call to UPT user.

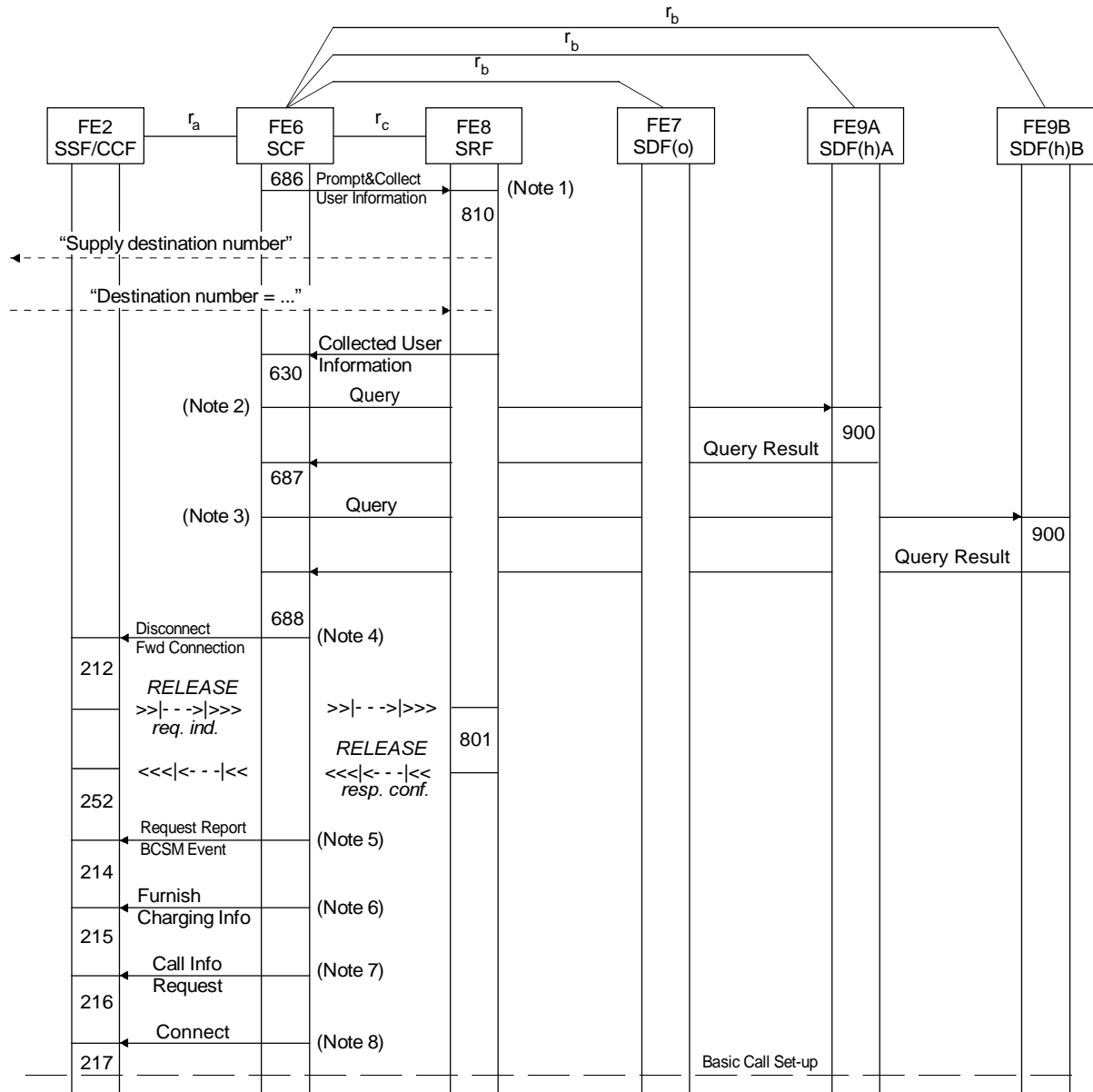

T1164350-94/d16

#### NOTES

- 1 Start of outgoing call. The user is prompted to input the destination number, using Prompt and Collect User Information req. ind. The number is reported to the SCF using Collected User Information req. ind.
- 2 SDF(h)A may be queried to authorize the destination number (optional).
- 3 If the dialled number is a UPT number, it will be translated to a normal directory number by querying SDF(h)B.
- 4 SRF is released (SCF initiated).
- 5 Request Report BCSM Event req. ind. is to arm Detection Points as EDP-R for B-party disconnection (DP 9) and call set-up failure (DPs 4, 5 and 6) to allow call or procedure follow-on. It is also used to arm DP 8 for mid-call feature activation for follow-on, if required, and to activate the application timer for "B party no answer", if required.
- 6 Furnish Charging Information req. ind. establishes a charge record for the call. Other charging IFs could be used here e.g. Apply Charging req. ind.
- 7 Call Information Request req. ind. specifies the call event information to be transferred to SCF at the end of the call – optional.
- 8 The B-party number (either the dialled directory number or the translated UPT number) is sent to the SSF/CCF in the Connect req. ind.

FIGURE 3-14/Q.76

#### Outgoing call set-up

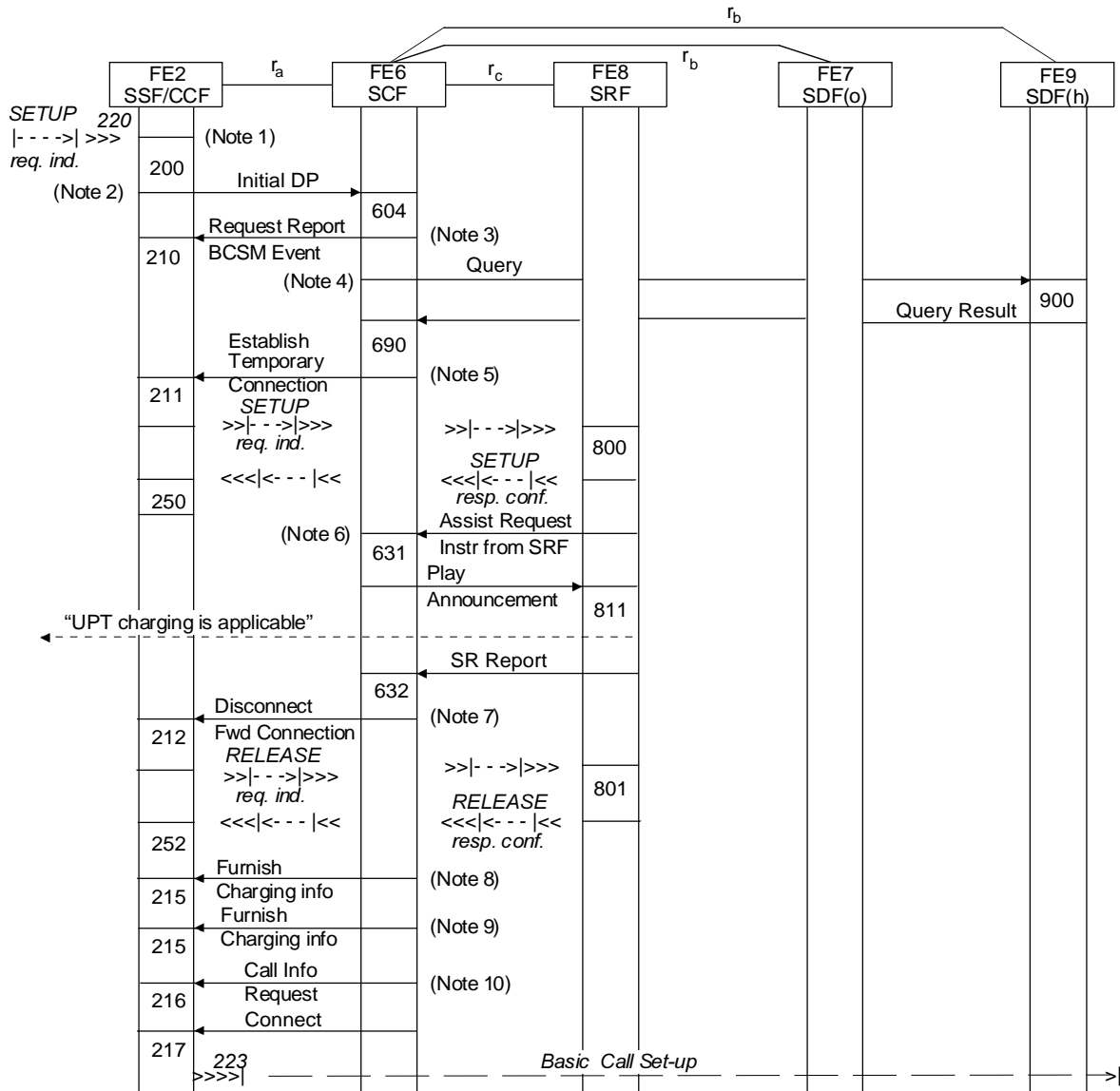

T1164360-94/d17

NOTES

- 1 Any user can dial a UPT number, which is a diallable number. It possibly has a prefix.
- 2 The UPT number can be detected at, for example, Detection Point 3, which will be statically armed as TDP-R.
- 3 DPs 10 and 9 are now armed as EDP-N to detect and report call abandon or disconnect, respectively.
- 4 The translation of UPT number to currently registered directory number (or equivalent) is obtained from SDF(h).
- 5 An announcement containing some UPT charging information might optionally be played to the caller. If the announcement is not played, the SRF will not be connected.
- 6 The actual nature of the announcement may be an implementation matter.
- 7 The SRF is now disconnected.
- 8 If split charging is required, two charging records may be required, one for each party to the call.
- 9 Call event data may be transferred to SDF(h) at the end of the call (optional), using Call Information Request req. ind. and Call Information Report req. ind.
- 10 The translated address is passed back to the SSF in the Connect req. ind. and call processing restarts to select a route. After conversation, the call will be cleared down as in Figure 3-6 if the A-party disconnects first or as in Figure 3-7 if the B-party disconnects first. Call set-up failure is handled according to Q.71 procedures.

FIGURE 3-15/Q.76  
Incoming call to UPT user

### 3.4 Procedures for UPT service profile management

Service profile interrogation allows a UPT user to examine information stored in his service profile. An example of information which the user might wish to view would be the current InCall registration address.

The UPT user may also be able to modify service profile information, for example, default parameters. Values such as the current location are set by registration procedures.

Service profile interrogation and modification are both **optional** features of UPT Service Set 1. The sequences shown here, which are illustrative only, will support simple interrogation and minor modifications only.

#### 3.4.1 Outline description

The following is a high-level outline of the network actions required for a UPT user to ascertain the current values stored in the service profile. Access, identification and authentication have been successfully undertaken, and the service profile interrogation procedure has been requested.

- 1) Input code for data whose values are required.
- 2) The values are retrieved from the home SDF and played back to the user (voice announcement).
- 3) The user can then select a new procedure or terminate.

The following is a high-level outline description of the actions required for a UPT user to modify values in the service profile.

- 1) Input code for data whose values are to be changed.
- 2) Values are retrieved from home SDF and played back to user (voice announcement).
- 3) User is prompted to input new information or cancel code (see Note).
- 4) New information is echoed to user, who can confirm or reject the echoed information (see Note).
- 5) Values are changed in the home service profile.
- 6) Decision:
  - If successful go to “User request accepted” (see Figure 3-13).
  - If unsuccessful, go to “User request denied” (see Figure 3-10).

NOTE – It is assumed that if the UPT user cancels or rejects echoed values that the values are incorrect in some way. Control is shown as passing to Figure 3-10, “User request denied”. Alternatively control could return to the beginning of the service profile modification procedure.

#### 3.4.2 Information flow diagrams

The information flows are shown for the following procedures:

- Figure 3-16: Service profile interrogation.
- Figure 3-17: Service profile modification.

Successful authentication has occurred and the path between the UPT user and the SRF has been maintained.

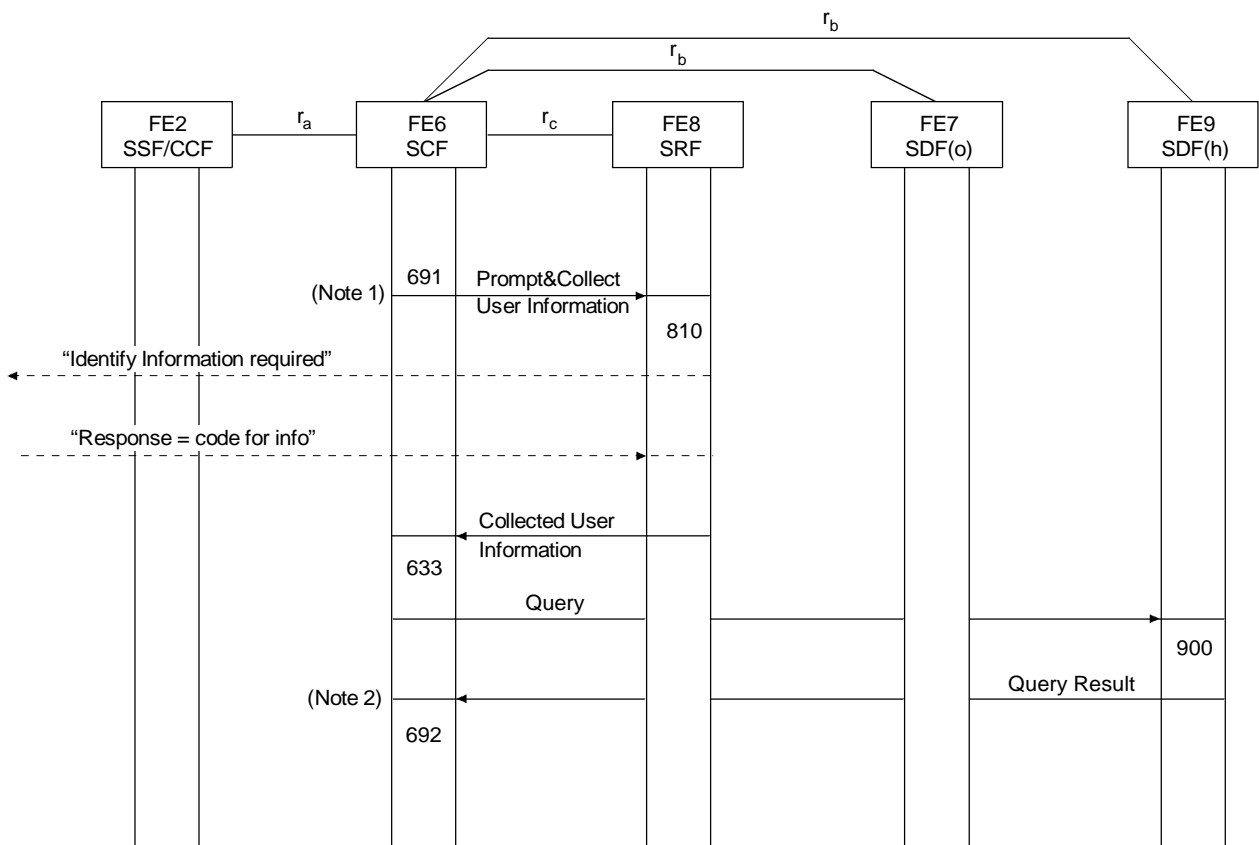

T1164370-94/d18

FIGURE 3-16/Q.76  
Service profile interrogation

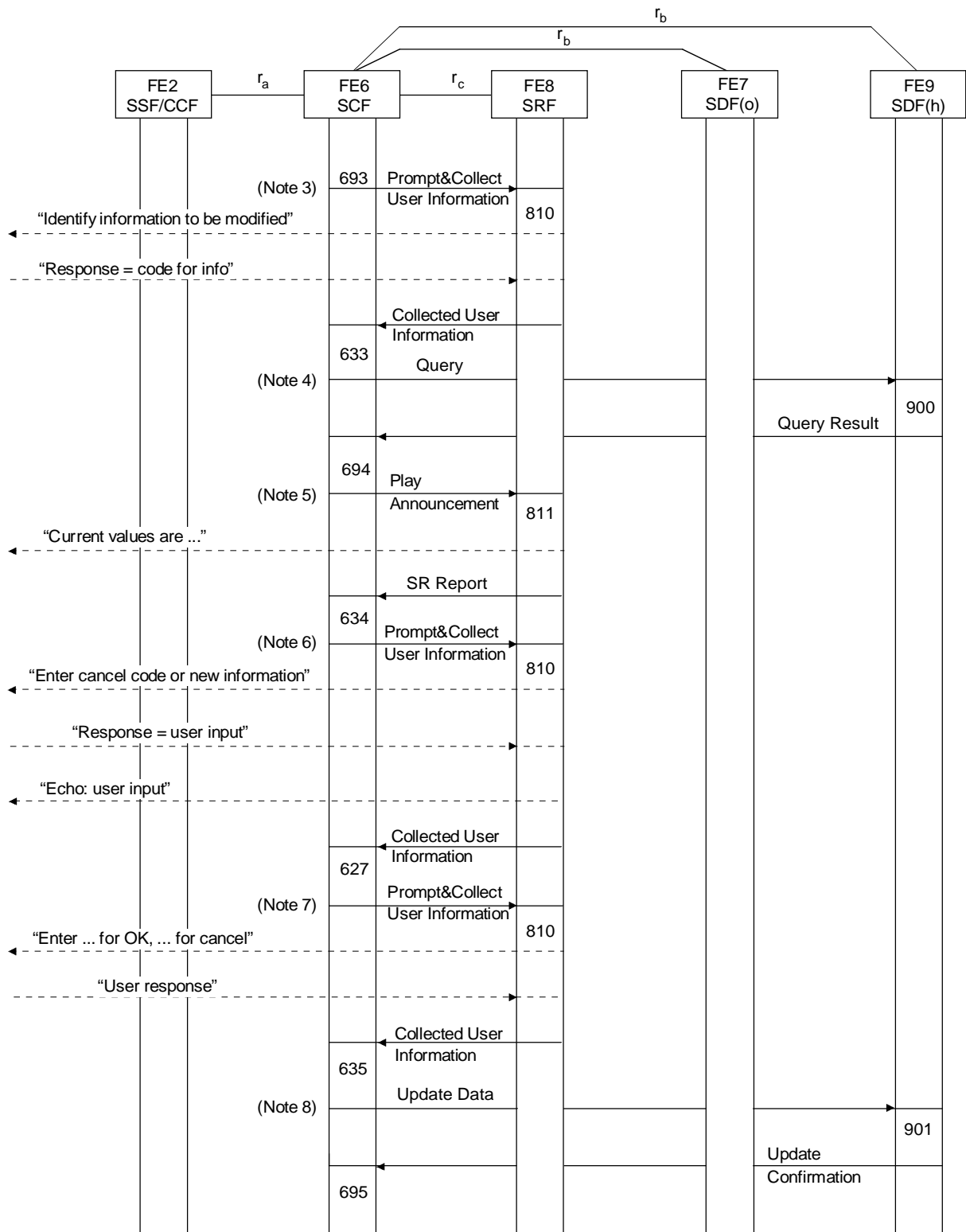

T1164380-94/d19

FIGURE 3-17/Q.76  
Service profile modification

## NOTES related to Figures 3-16 to 3-17

- 1 The UPT user has requested service profile interrogation and must now input further details of the information to be examined.
- 2 Control transfers to Figure 3-13 to play announcement to user with information requested and prompt user for new request.
- 3 The UPT user has requested service profile modification and must now input further details of the information to be modified.
- 4 SDF(h) is queried to retrieve the information requested. If the requested modification is allowed, the values are returned in Query Result resp. conf.
- 5 The current values are played back to the user for verification.
- 6 The prompt and response sequence might need to be repeated several times to input all necessary information. Voiceback of input values might be required.
- 7 Prompt user to enter codes for acknowledgement or cancel. If the user enters a code for "Cancel", it could be assumed that the wrong data had been requested or no modification was required. Control would transfer to "User request denied" (see Figure 3-10). Similarly, if the user does not accept the new information as echoed, "cancel" would transfer control to "User request denied". Alternatively in both cases control might return to the start of service profile modification.
- 8 The user's service profile can now be updated.

## 3.5 Third-party procedures

The form of the reset procedure considered in this Recommendation allows any person (the third party) to cancel UPT users' registrations for incoming calls in the absence of the UPT user. It is an **optional** feature of UPT Service Set 1. The terminal used to request the reset must be the terminal to which the registration applies. Recommendation F.851 [2] defines this procedure as enabling a third party to reset explicitly all UPT users who may have registered for incoming calls on a terminal address. Such a procedure is, however, not included in this Recommendation as it requires the originating network to have received data concerning registrations for incoming UPT calls on the terminal for which reset is being requested. Such capability is outside the scope of CS-1. It is assumed here that the third party knows the UPT number of the UPT user and that CLI is available. This is a security measure to restrict malicious cancellation of registrations, by ensuring that the reset procedure can only be requested from the affected terminal.

The third party invokes the reset procedure by using some form of access code. This access code may be different from that used by UPT users to invoke UPT procedures, since no form of identification (other than by CLI) or authentication is required.

For illustrative purposes, only reset of a single registration is shown here.

### 3.5.1 Outline description

The following is a high-level description of the network actions required when any person (the third party) invokes the reset procedure. It is assumed that CLI is available.

- 1) The third party dials the UPT reset access code.
- 2) Processing is suspended in the CCF while awaiting instructions from the SCF.
- 3) The SRF is connected.
- 4) The third party is requested to input the UPT number for which reset is desired.
- 5) The current terminal address is compared with the current registered location of the UPT user. If no match, play failure announcement to requesting user and request user to hang up.
- 6) The current terminal address is compared with the default registered location of the UPT user. If match (reset is not possible), play failure announcement to requesting user and request user to hang up.
- 7) Retrieve default location from UPT user's SDF(h).
- 8) The UPT registration is restored to the default address.
- 9) The third party is advised of the result and asked to hang up.



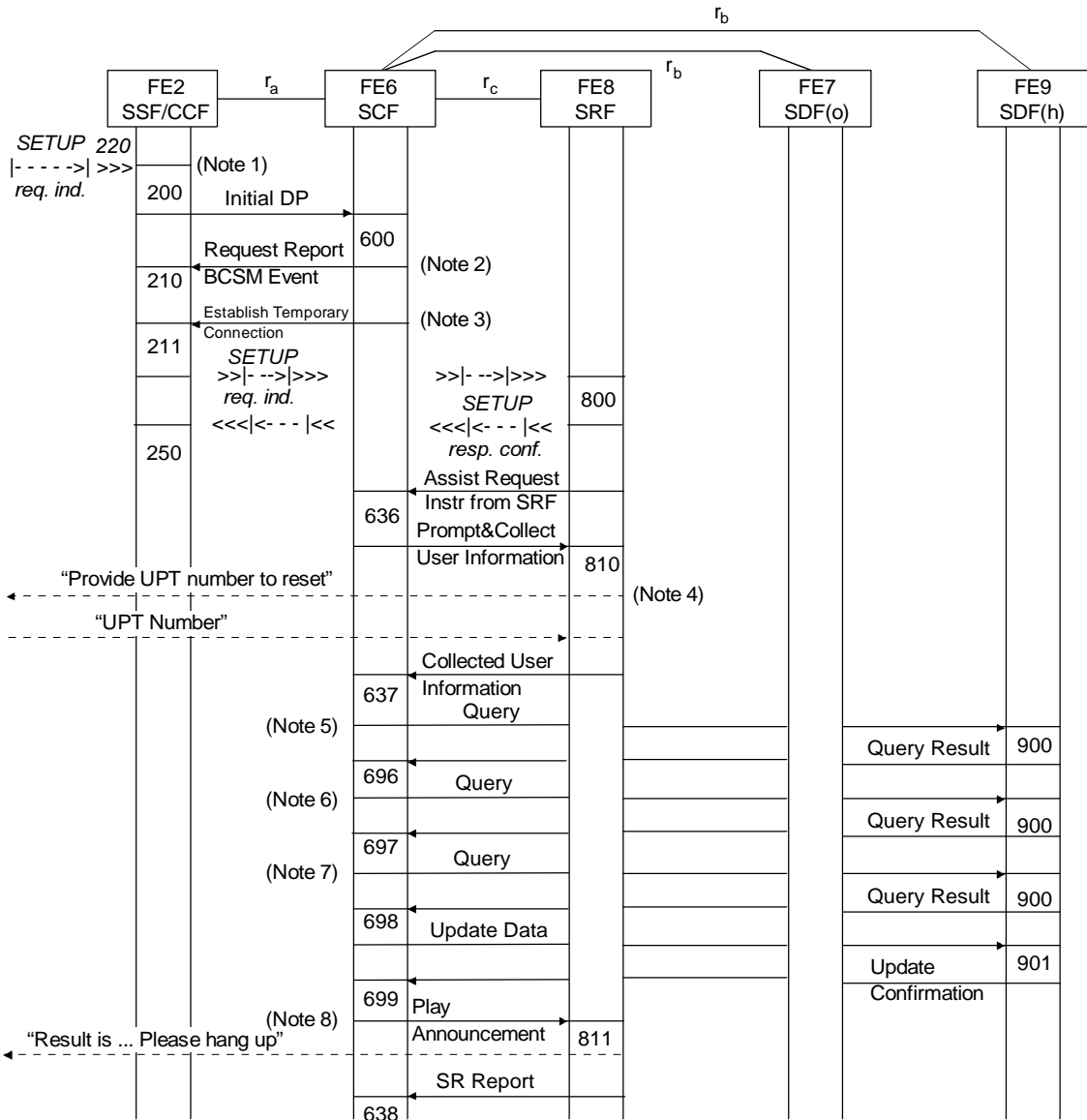

T1164390-94/d20

NOTES

- 1 The SETUP req. ind. contains an access code or indicator that the reset procedure is required. This access code may differ from the access code used by UPT users. Call processing will be suspended and Initial DP req. ind. sent to the SCF.
- 2 Detection Point 10 will then be armed as EDP-N to detect calling party abandon. Call Information Request req. ind. might be sent at this time, if required.
- 3 The SRF is now connected to request the third party to input the UPT number for which registration reset is required. If CLI is not available, advice that reset is not allowed will be played to the caller.
- 4 The full UPT number will have to be entered to allow identification of the UPT user's service provider.
- 5 The current terminal and the UPT user's current registration location are compared. Only if there is a match can reset be allowed.
- 6 The current terminal and the UPT user's default location are compared. Only if there is no match can reset succeed.
- 7 The reset request requires SDF(h) to be updated to restore the appropriate registration value to its default terminal location. CS-1 limitations on the Update Data operation require that it be preceded by a Query operation to retrieve the default value, which is then returned to SDF(h) in the Update Data operation.
- 8 The caller is advised whether the reset has been successful and is asked to hang up.

FIGURE 3-18/Q.76

Reset of registration for incoming UPT calls by a third party

### 3.5.2 Information flow diagrams

The information flows are shown for the following procedure:

- Figure 3-18: Reset of registration for incoming UPT calls by a third party.

### 3.6 Definition of individual information flows

The information flows contained in 3.6.1 through 3.6.3 are those described in clause 5/Q.1214 and clause 6/Q.1214 [4]. The information elements (IEs) shown as those which are either:

- mandatory (indicated by M); or
- optional but needed for UPT service (indicated by O).

Mandatory and optional are as defined in Recommendation Q.1214 [4]. The reference number in 6/Q.1214 [4] is shown in square brackets [ ] after the name of the IF.

The IFs are also cross-referenced to the Service Independent Building Block (SIB) in which the IF is described in clause 5/Q.1214 [4]. The abbreviations for the SIBs and the relevant reference numbers in Recommendation Q.1214 [4] are:

Basic Call Process	BCP	5.3
Charge	CHG	5.2.2
Log Call Information	LCI	5.2.6
Screen	Screen	5.2.8
Service Data Management	SDM	5.2.9
Translate	Trans.	5.2.11
User Interaction	UI	5.2.12

Example values of the IEs may be found in Recommendation Q.1219 [7].

The information flows for call set-up and release from Recommendation Q.71 [6] are not described.

#### 3.6.1 Relationship $r_a$ (SSF-SCF)

##### 3.6.1.1 SSF to SCF flows

Call Information Report req. ind. – unconfirmed IF [6.4.2.10] (LCI)

IEs: Requested Information	M
Correlation ID	O

Event Report BCSM req. ind. – unconfirmed IF [6.4.2.22] (BCP)

IEs: Call ID	M
Event Type BCSM	M
Misc Call Info	O
Event Specific Information BCSM	O
Leg ID	O
BCSM Event Correlation ID	O

Initial DP req. ind. – unconfirmed IF [6.4.2.25] (BCP)

IEs: Call ID	M
Service Key	M
Dialled Digits	O
Called Party Number	O
Calling Line Identity	O

SSF/SRF Capabilities	O
Misc Call Info	M
Terminal Type	O
Location Number	O

Misc Call Info contains a sequence of the following IEs:

DP Type	M
DP Assignment	O

### 3.6.1.2 SCF to SSF flows

Call Information Request req. ind. – unconfirmed IF [6.4.2.11] (LCI)

IEs: Requested Information	M
Correlation ID	O

Connect req. ind. – unconfirmed IF [6.4.2.16] (BCP)

IEs: Call ID	M
Destination Routing Address	M
Forwarding Condition	O
Route List	O
Cut And Paste	O

Disconnect Forward Connection req. ind. – unconfirmed IF [6.4.2.19] (UI)

IEs: Call ID	M
--------------	---

Establish Temporary Connection req. ind. – unconfirmed IF [6.4.2.20] (UI)

IEs: Call ID	M
Assisting SSF/SRF Routing Address	M

Furnish Charging Information req. ind. – unconfirmed IF [6.4.2.23] (CHG)

IEs: Call ID	M
Billing Charging Characteristics	M

Release Call req. ind. – unconfirmed IF [6.4.2.33] (BCP)

IEs: Call ID	M
Cause	M

Request Report BCSM Event req. ind. – unconfirmed IF [6.4.2.35] (BCP)

IEs: Call ID	M
BCSM Event List	M
BCSM Event Correlation ID	O

BCSM Event List contains one or more sets of the following IEs:

Event Type	M
Monitor Mode	M
Leg ID	O
Application Timer	O

### 3.6.2 Relationship $r_b$ (SCF-SDF)

#### 3.6.2.1 SCF to SDF flows

Query req. ind. – confirmed IF [6.6.2.1] (SDM, Screen, Trans.)

IEs: Database ID	O
Requested Info Type	O
Information Key	M

Update Data req. ind. – confirmed IF [6.6.2.5] (SDM, LCI)

IEs: Function Type	O
Database ID	O
Updated Info	M
Information Key	M

#### 3.6.2.2 SDF to SCF flows

Query Result resp. conf. – unconfirmed IF [6.6.2.2] (SDM, Screen, Trans.)

IEs: Requested Info	M
---------------------	---

Update Confirmation resp. conf. – unconfirmed IF [6.6.2.4] (SDM, LCI)

IEs: Outcome	M
--------------	---

### 3.6.3 Relationship $r_c$ (SCF-SRF)

#### 3.6.3.1 SCF to SRF flows

Play Announcement req. ind. – optionally confirmed IF [6.5.2.3] (UI)

IEs: SRF Connect ID	M
Information To Send	M
Disconnection From IP Forbidden	M
Request Announcement Completed Indication	M

Prompt and Collect User Information req. ind. – confirmed IF [6.5.2.4] (UI)

IEs: SRF Connect ID	M
Information To Send	O
Disconnection From IP Forbidden	M
Collected Info	M (see Note)

NOTE – The digit information contained within IE Collected Info includes instructions to the SRF to echo the user's input data back to the user ("Voiceback").

#### 3.6.3.2 SRF to SCF flows

Assist Request Instructions from SRF req. ind. – unconfirmed IF [6.5.2.1] (UI)

IEs: Call ID	M
SSF/SRF Capabilities	O
Correlation ID	M

Collected User Information req. ind. – unconfirmed IF [6.5.2.3] (UI)

IEs: SRF Connect ID	M
Received Information	M

Specialized Resource Report resp. conf. (SR Report) – unconfirmed IF [6.5.2.5] (UI)

IEs: SRF Connect ID	M
---------------------	---

## 4 SDL diagrams for functional entities

The SDL diagrams in this Recommendation describe the sequencing of the information flows of clause 3, and are consistent with the rules for sequencing of information flows contained in the Finite State Machines of Recommendation Q.1218 [5]. The sequencing rules are contained only in Recommendation Q.1218 and not in Recommendation Q.1214 [4]. The descriptions in Recommendation Q.1218 [5] are incomplete and a number of simplifying assumptions have been made there. Nevertheless, because of the mapping between Distributed Functional Plane and Physical Plane which is represented in Recommendation Q.1218 [5], the order of information transfer described in Recommendation Q.1218 [5] for the IN Application Protocol INAP must be identical with the sequencing requirements on information flows for Recommendation Q.1214 [4], and hence the state machines in both Recommendations must be structured in the same way.

The UPT SDL diagrams are very informal and high level in the description of processing actions. Little or no information is included on error paths or timer control. This information is not available in detail in Recommendation Q.1218 [5].

SDL diagrams are shown in the following figures:

- Figure 4-1: SDL diagram for SSF/CCF (7 sheets).
- Figure 4-2: SDL diagram for SCF (8 sheets).
- Figure 4-3: SDL diagram for SRF (3 sheets).

PROCESS UPT\_SSF:

/\*  
FE2 (SSF/CCF) – SDL diagram for UPT Service Set 1.  
State names based on SSF Finite State Model of  
Recommendation Q.1218, March 1993.  
Error paths and timer control not shown.  
Version 3.0, November 1993.  
\*/

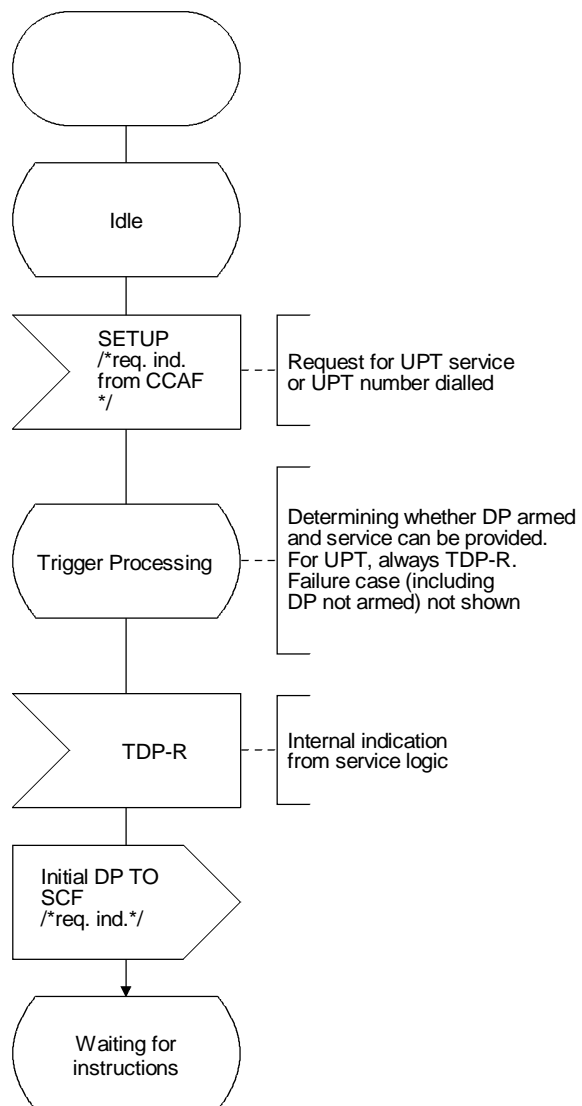

T1164400-94/d21

FIGURE 4-1/Q.76 (sheet 1 of 7)  
SDL diagram for SSF/CCF

PROCESS UPT\_SSF:

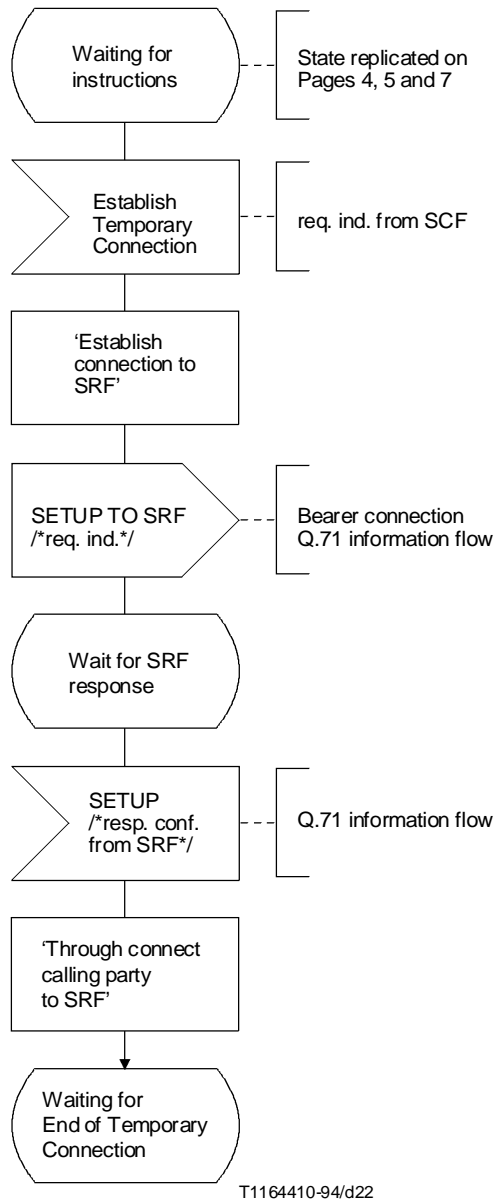

FIGURE 4-1/Q.76 (sheet 2 of 7)

SDL diagram for SSF/CCF

PROCESS UPT\_SSF:

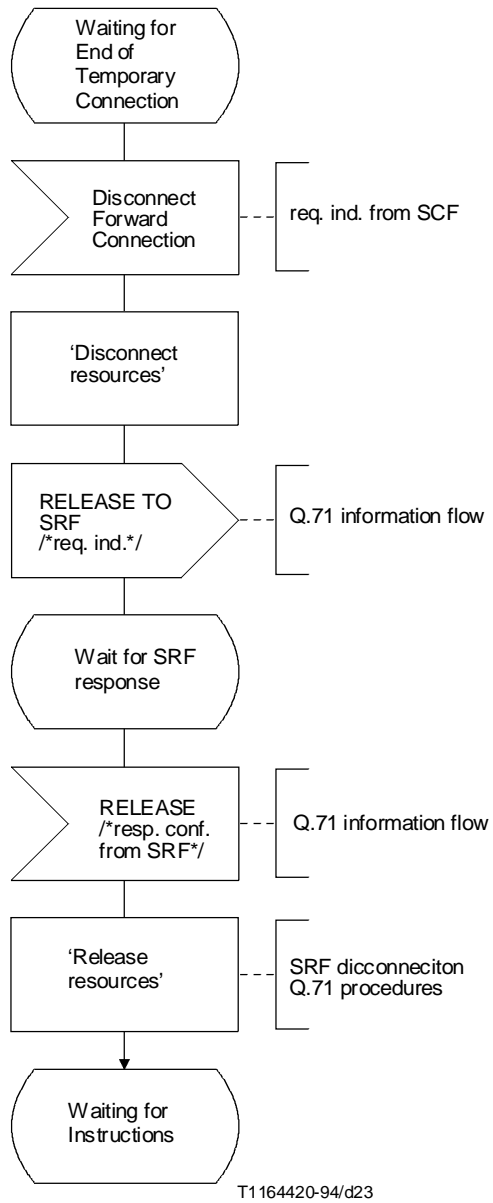

FIGURE 4-1/Q.76 (sheet 3 of 7)  
SDL diagram for SSF/CCF



PROCESS UPT\_GSF:

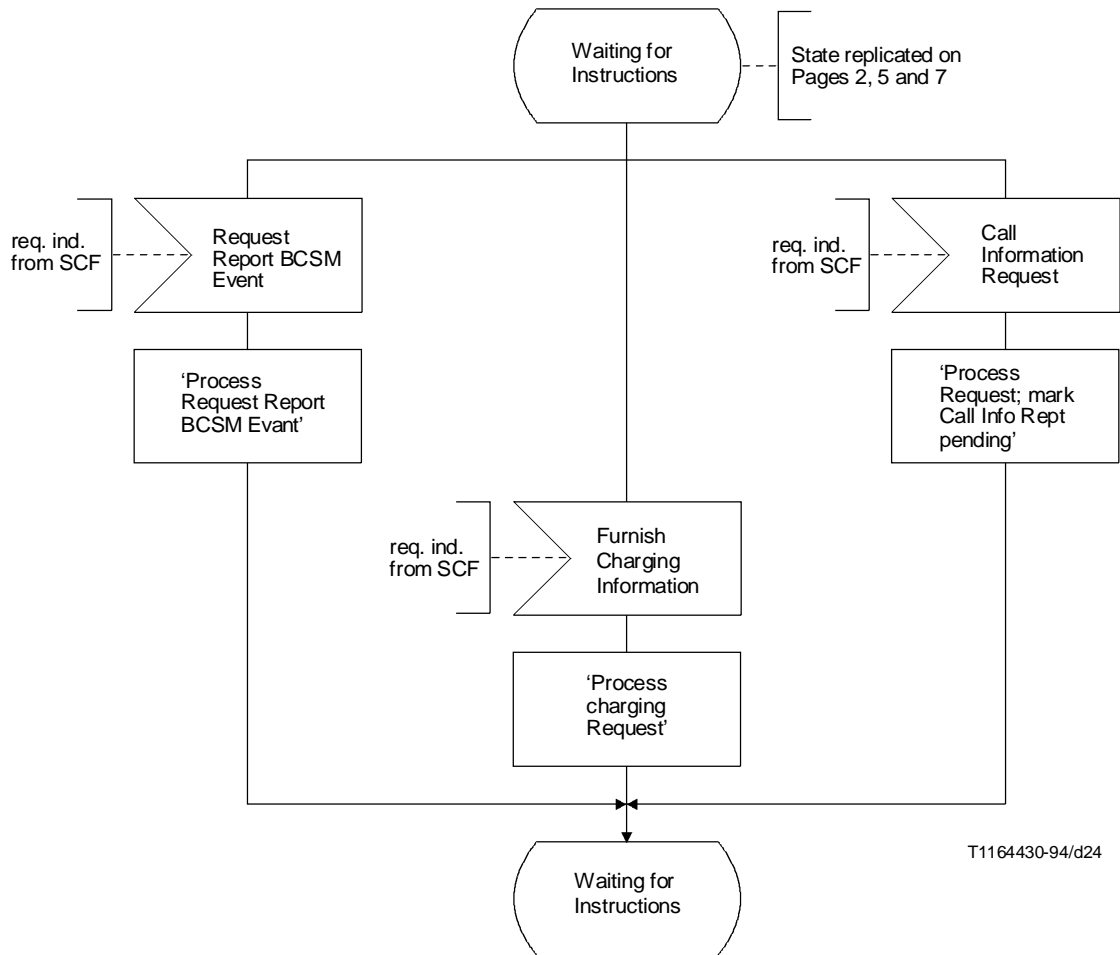
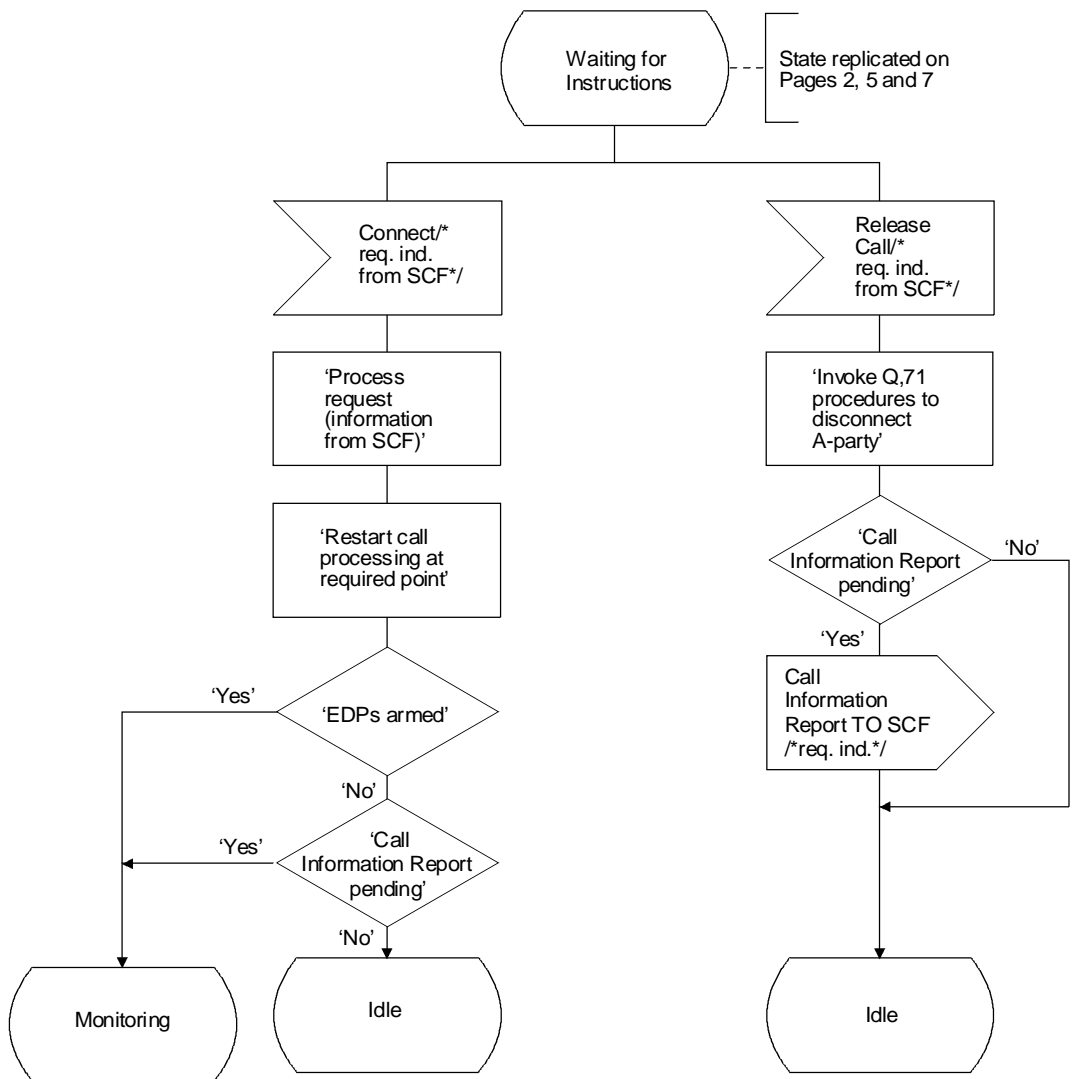

FIGURE 4-1/Q.76 (sheet 4 of 7)  
SDL diagram for SSF/CCF

PROCESS UPT\_SSF:



T1164440-94/d25

FIGURE 4-1/Q.76 (sheet 5 of 7)  
SDL diagram for SSF/CCF

PROCESS UPT\_SSF:

/\*Following Detection Points are allowed:  
 EDP-R  
 DP4, Route Select failure;  
 DP5, B busy  
 DP6, B no answer timeout  
  
 DEP-R or EDP-N:  
 DP9, Called or calling party disconnect\*/

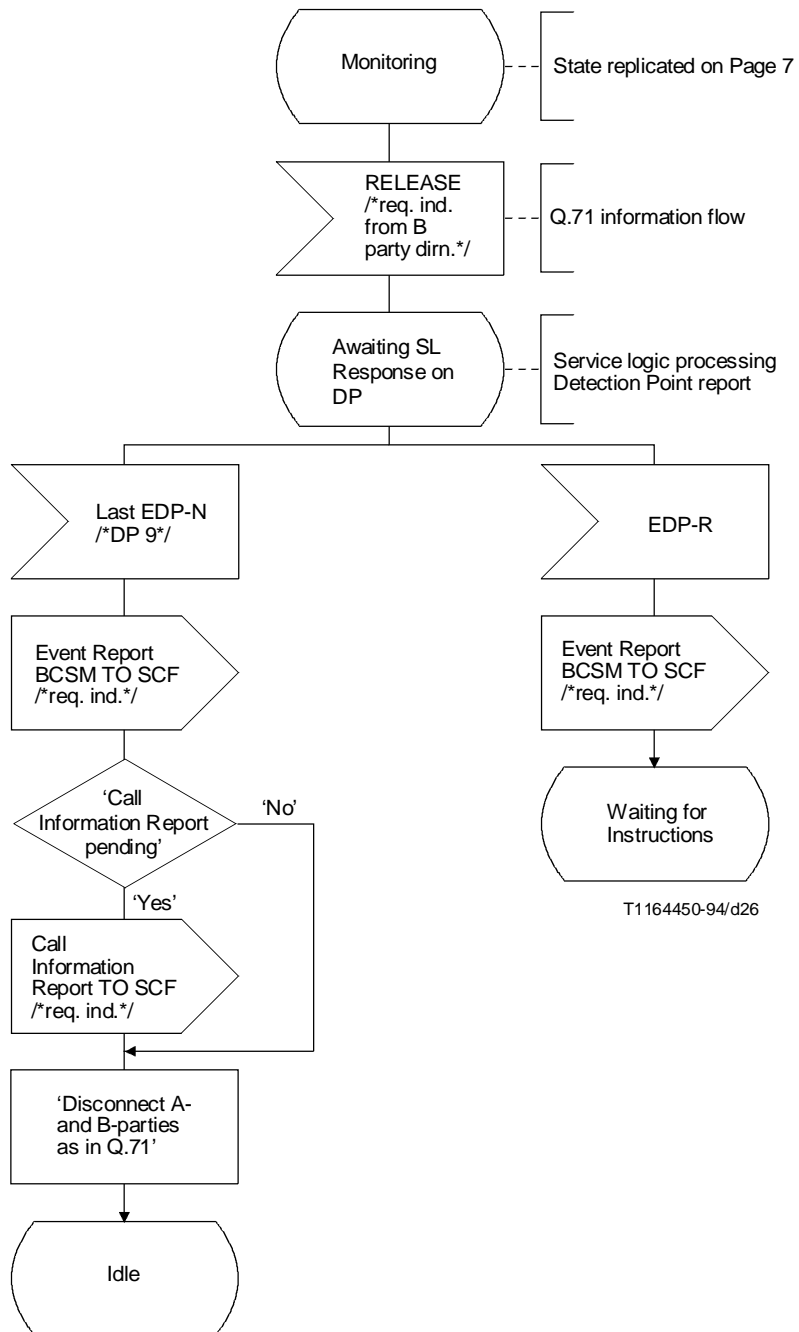

FIGURE 4-1/Q.76 (sheet 6 of 7)  
 SDL diagram for SSF/CCF

PROCESS UPT\_SSF:

```

/*
A-party abandon sequence.
SRF may or may not be connected.
DP 10 armed as EDP-N.
*/

```

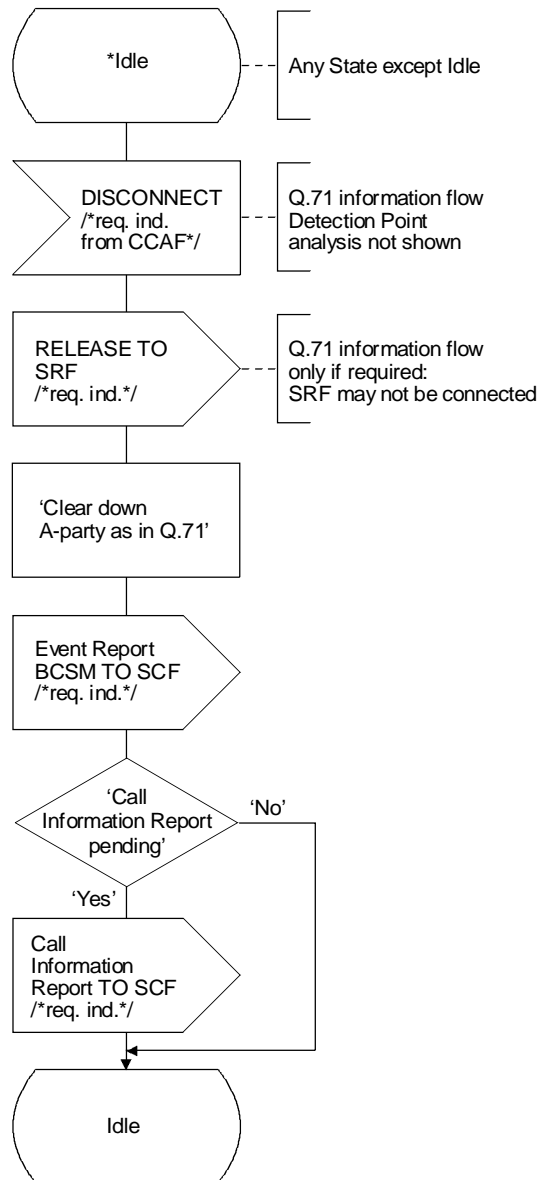

T1164460-94/d27

FIGURE 4-1/Q.76 (sheet 7 of 7)  
**SDL diagram for SSF/CCF**

PROCESS UPT\_SCF:

```
/*
FE6 (SCF) – SDL diagram for UPT Service Set 1.
State names based on SCF Finite State Model of
Recommendation Q.1218, March 1993.
Error paths and timer control not shown.
Version 3.0, November 1993.
*/
```

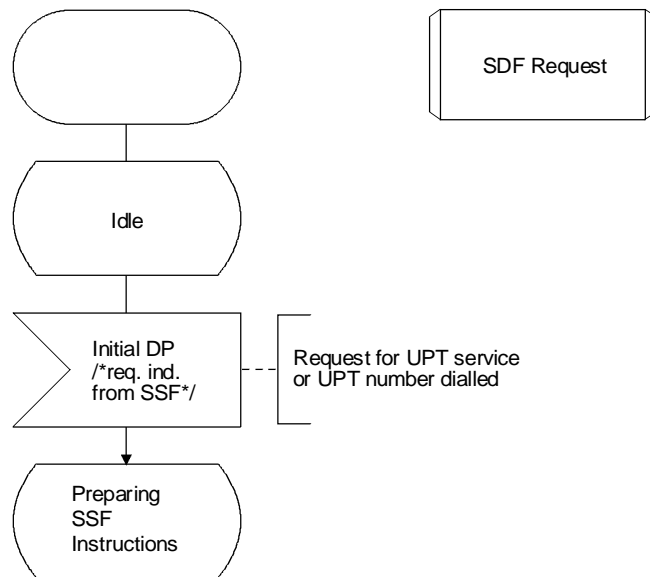

T1164470-94/d28

FIGURE 4-2/Q.76 (sheet 1 of 8)  
SDL diagram for SCF

PROCESS UPT\_SCF:

```
/*
Inputs on this page are from
internal (service) logic
*/
```

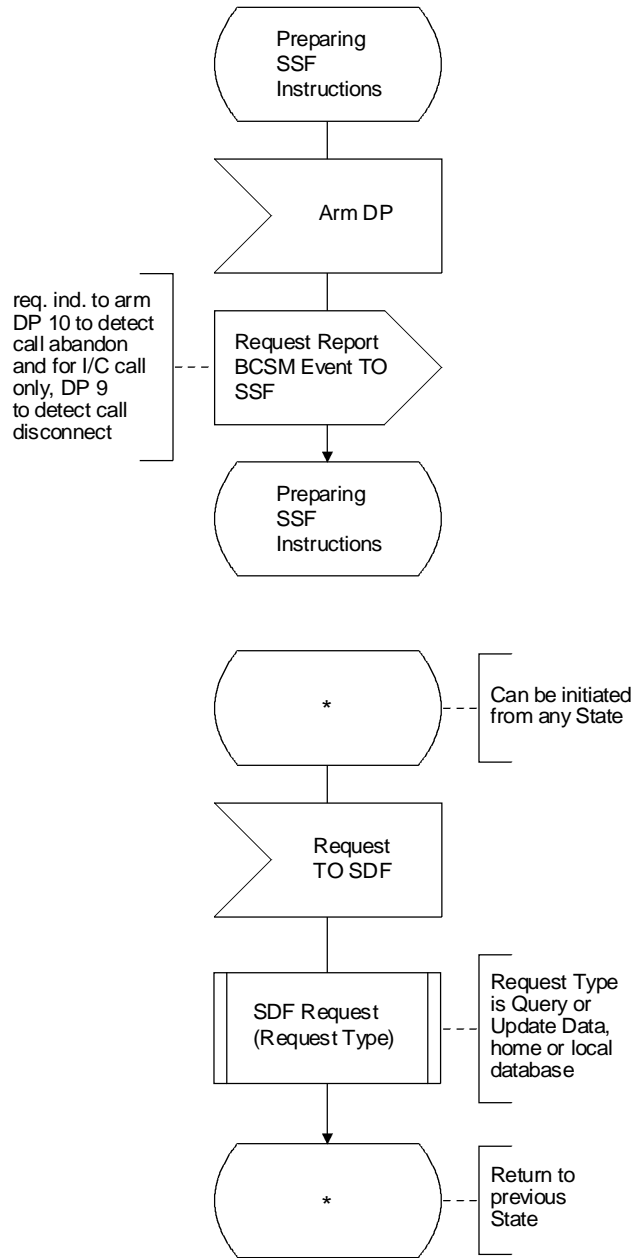

T1164480-94/d29

FIGURE 4-2/Q.76 (sheet 2 of 8)

SDL diagram for SCF

PROCESS UPT\_SCF:

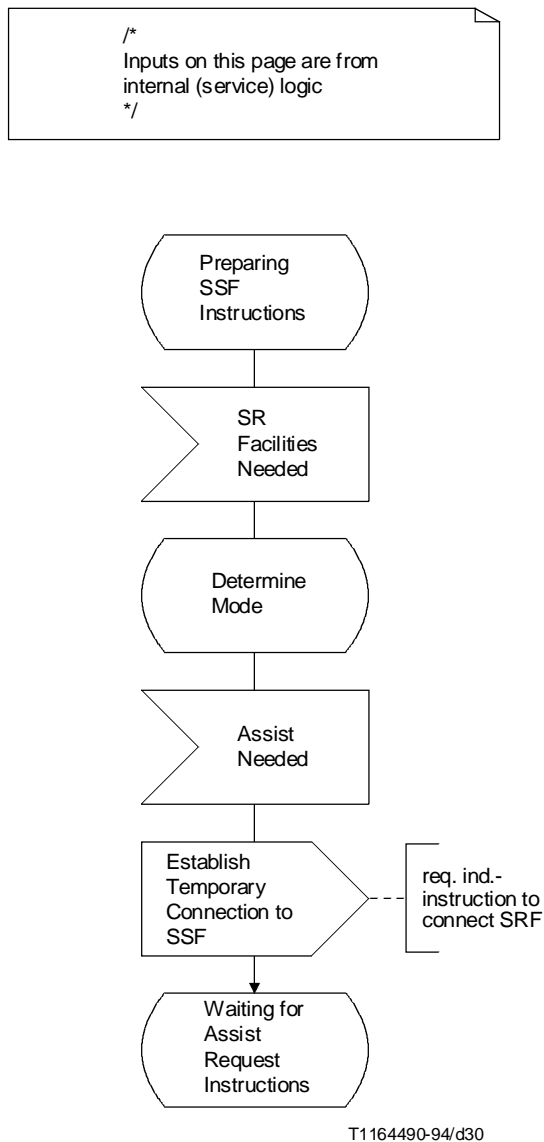
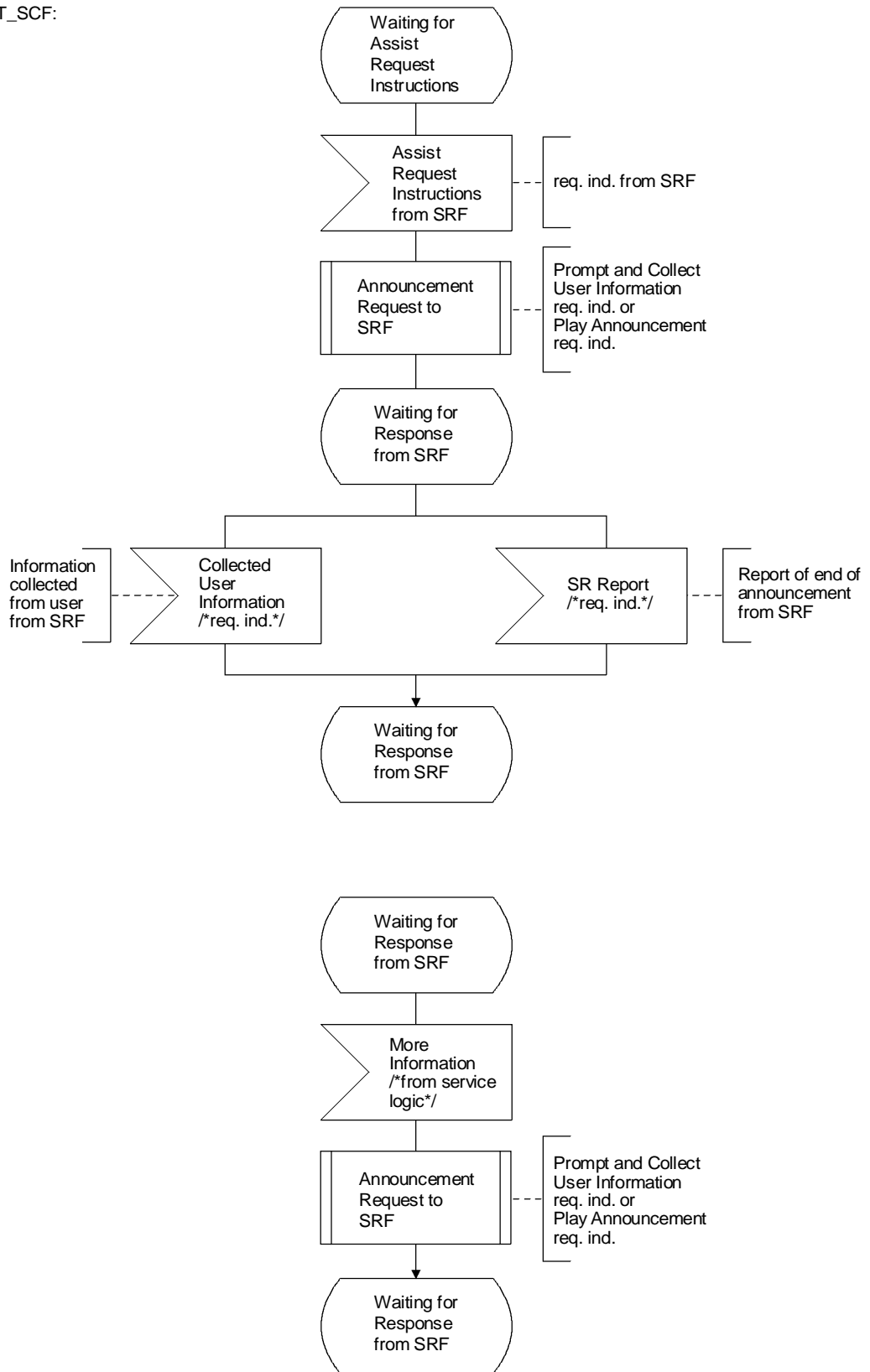

FIGURE 4-2/Q.76 (sheet 3 of 8)  
SDL diagram for SCF

PROCESS UPT\_SCF:



T1164500-94/d31

FIGURE 4-2/Q.76 (sheet 4 of 8)  
 SDL diagram for SCF



PROCESS UPT\_SCF:

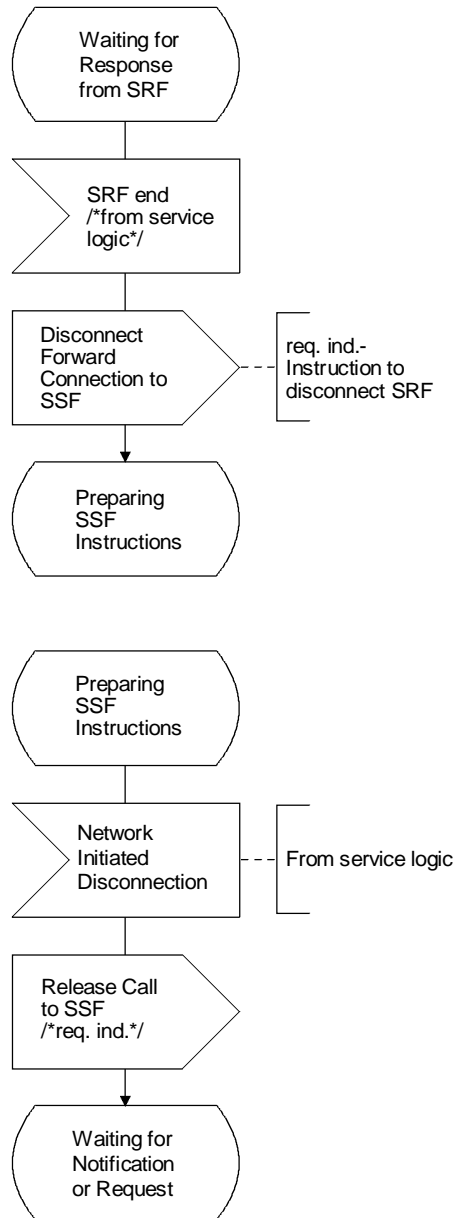

T1164510-94/d32

FIGURE 4-2/Q.76 (sheet 5 of 8)

**SDL diagram for SCF**

PROCESS UPT\_SCF:

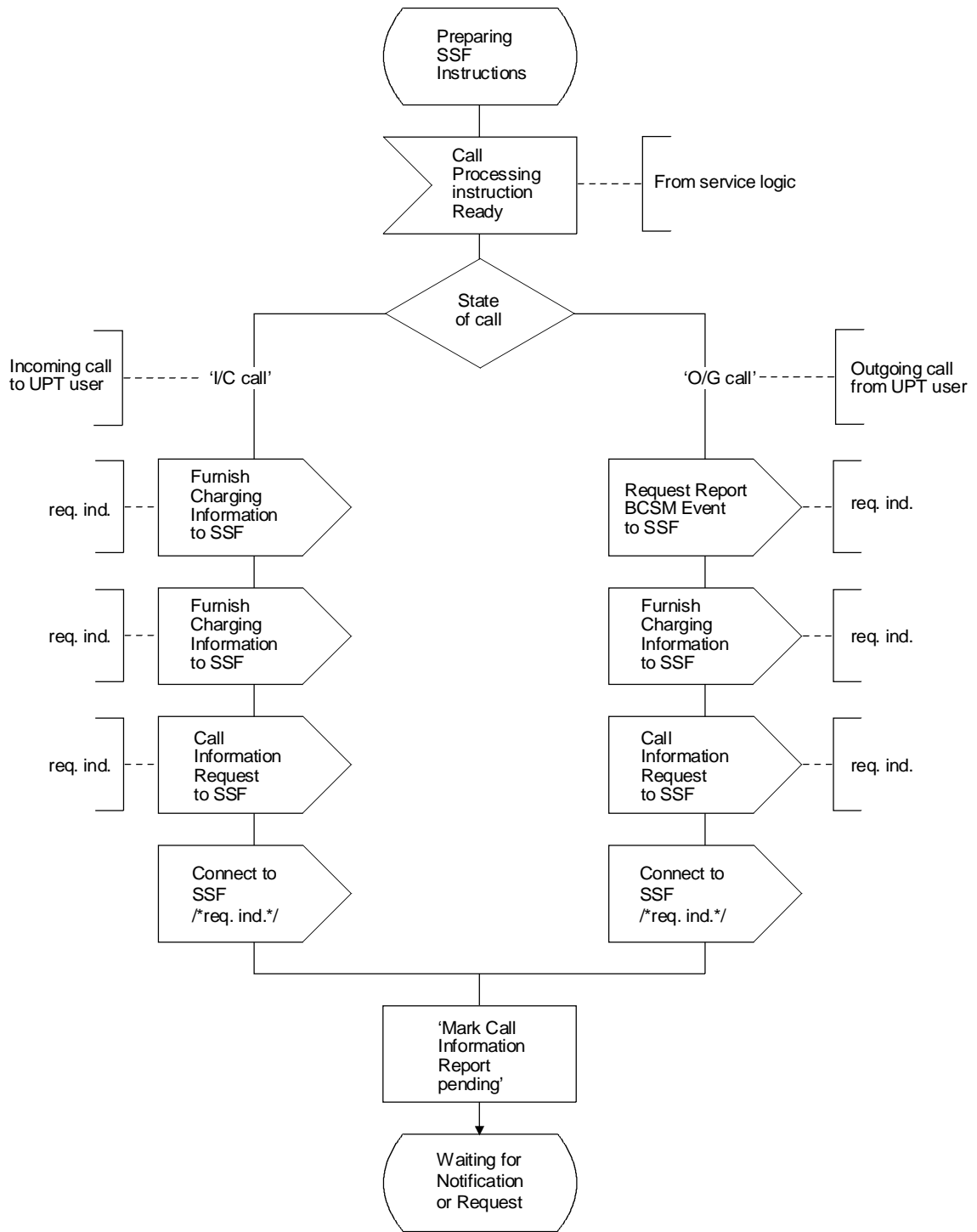

T1164520-94/d33

FIGURE 4-2/Q.76 (sheet 6 of 8)  
SDL diagram for SCF

PROCESS UPT\_SCF:

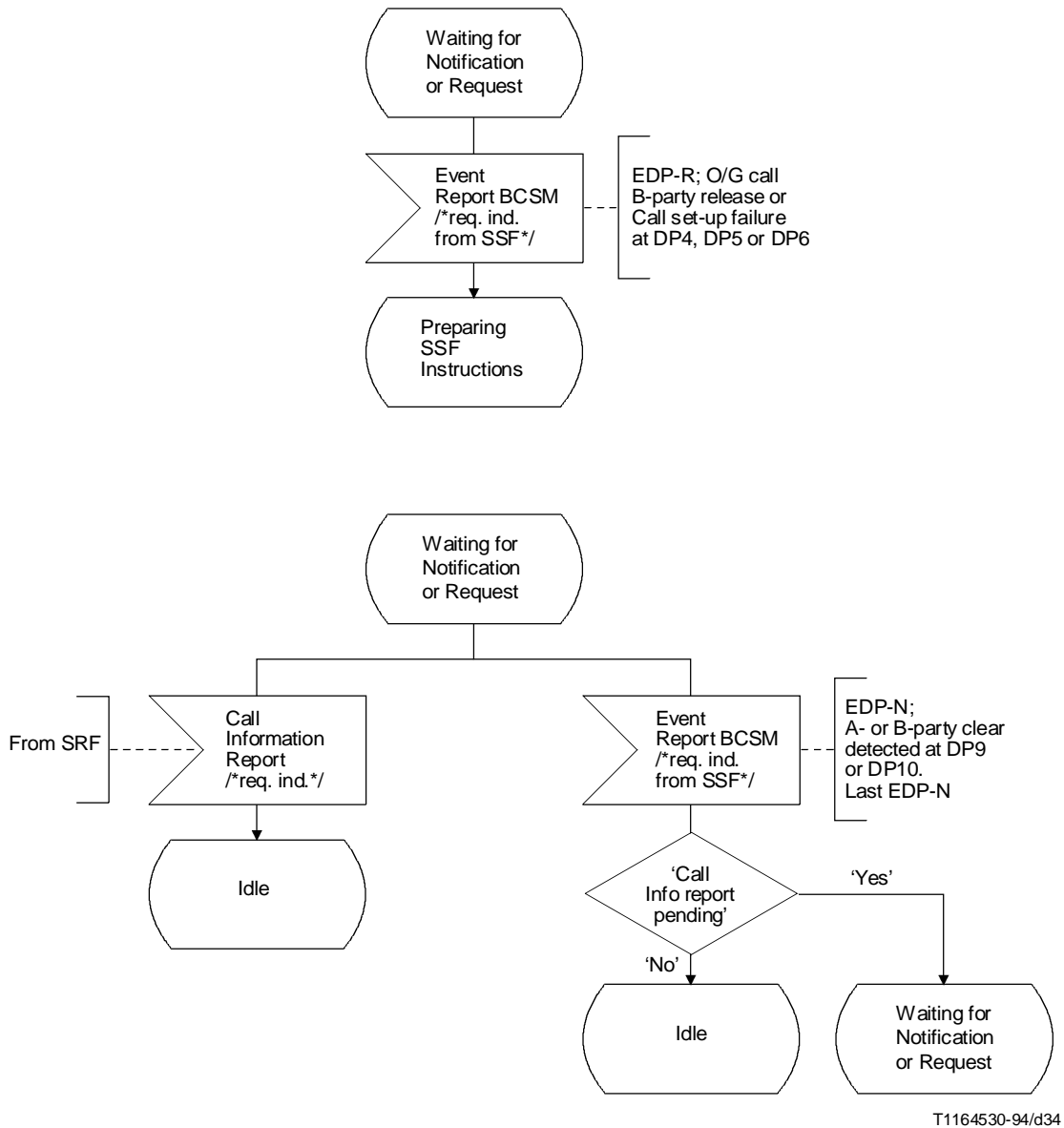
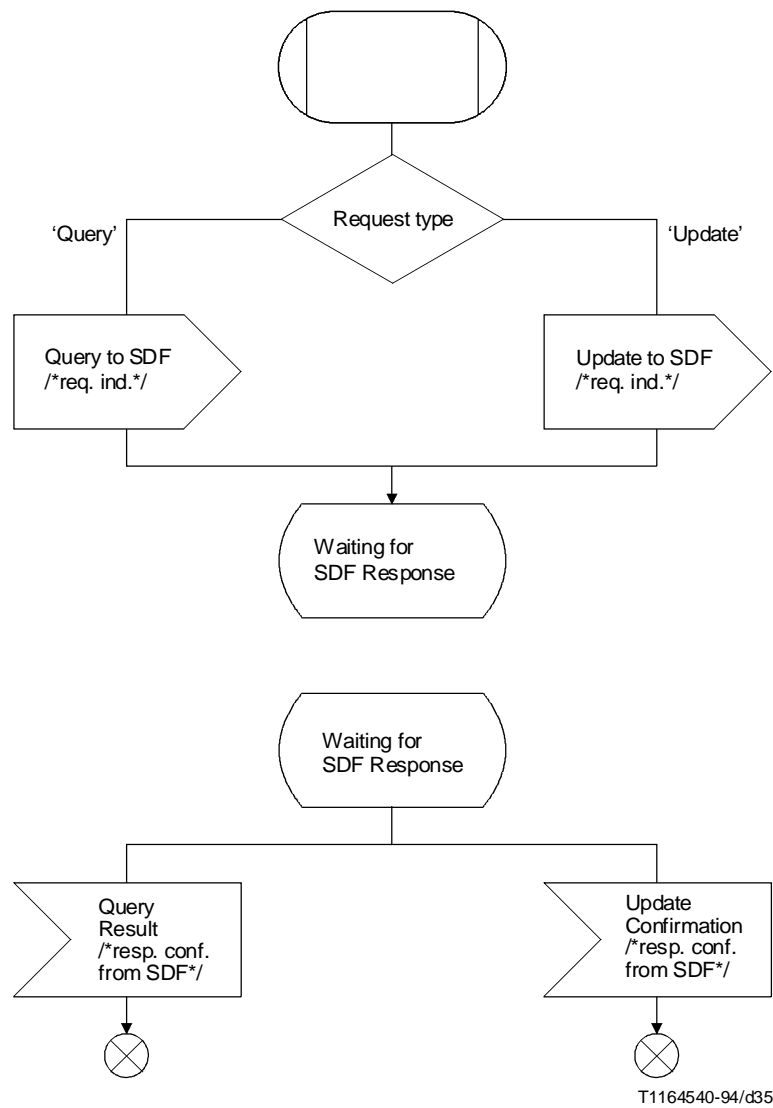

FIGURE 4-2/Q.76 (sheet 7 of 8)

SDL diagram for SCF

Procedure SDF\_Request:



T1164540-94/d35

FIGURE 4-2/Q.76 (sheet 8 of 8)  
SDL diagram for SCF

PROCESS UPT\_SRF:

```
/*  
FE8 (SRF) – SDL diagram for UPT Service Set 1.  
State names based on SRF Finite State Model of  
Recommendation Q.1218, March 1993.  
Error paths and timer control not shown.  
Version 3.0, November 1993.  
*/
```

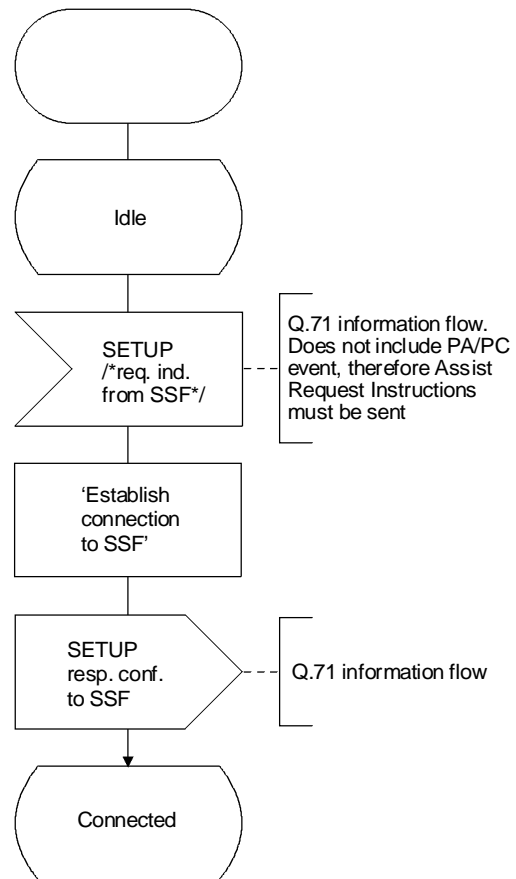

T1164550-94/d36

FIGURE 4-3/Q.76 (sheet 1 of 3)  
SDL diagram for SRF

PROCESS UPT\_SRF:

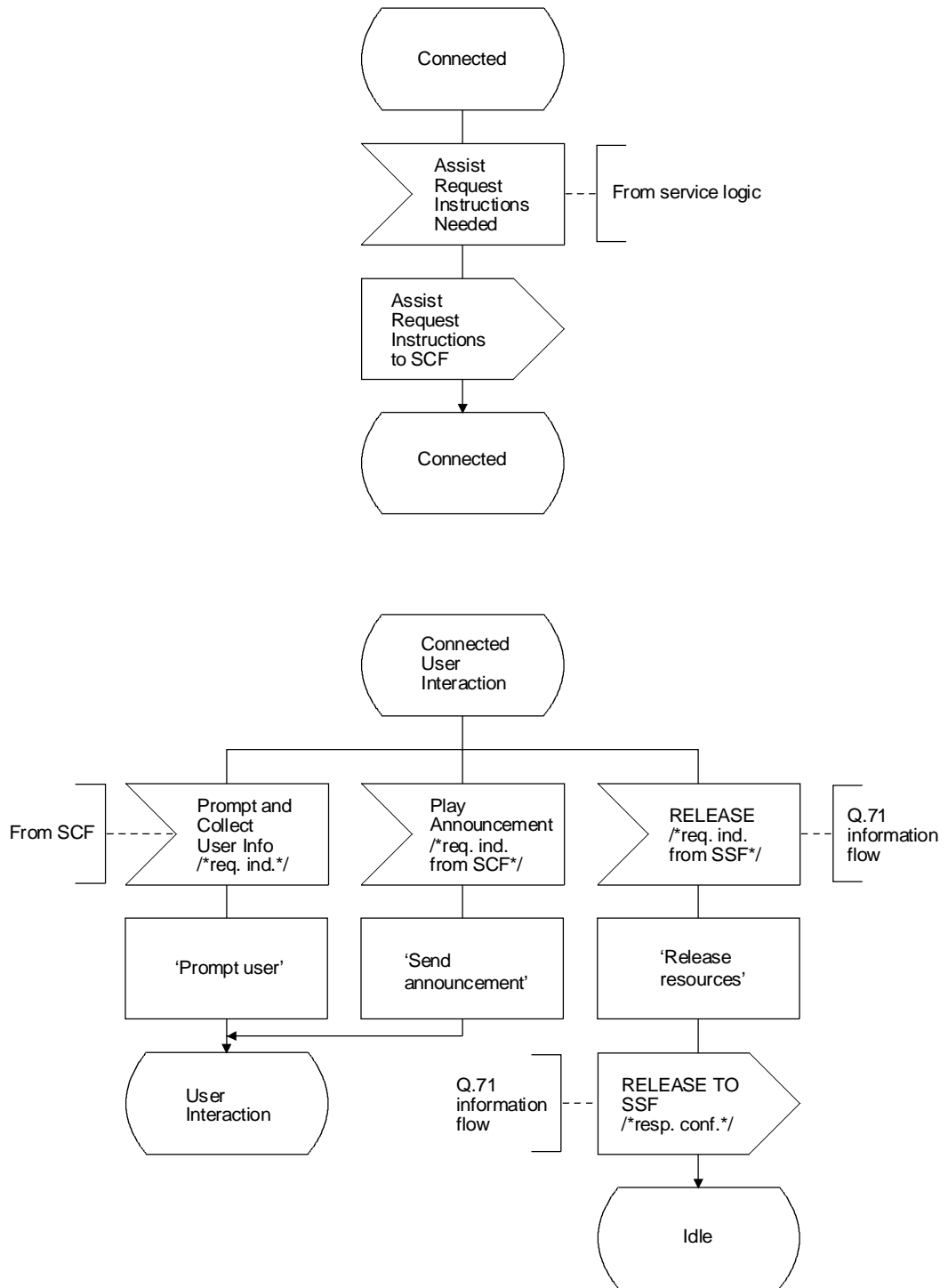

T1164560-94/d37

FIGURE 4-3/Q.76 (sheet 2 of 3)

**SDL diagram for SRF**

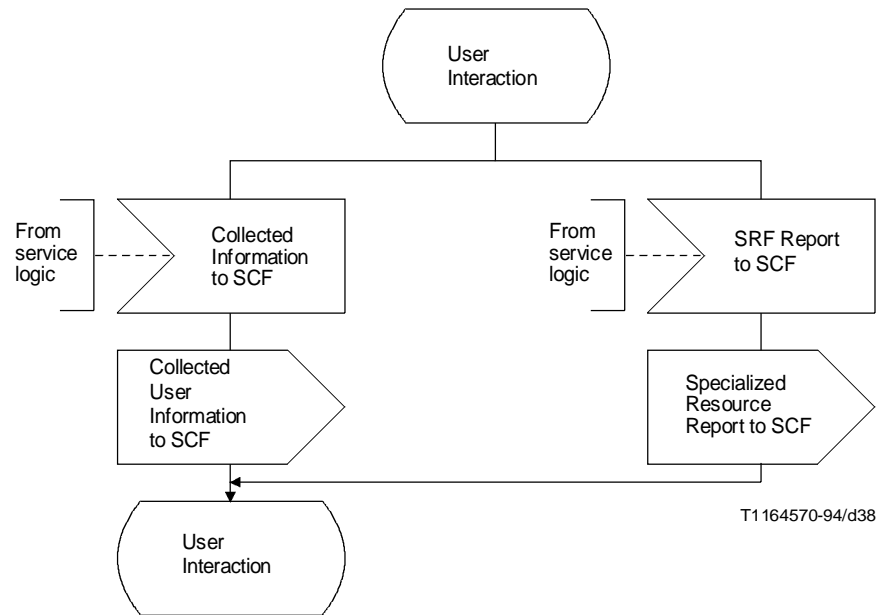

FIGURE 4-3/Q.76 (sheet 3 of 3)  
SDL diagram for SRF

## 5 Functional Entity Actions

The Functional Entity Actions are referenced by the numbers on the FE columns in the information flow diagrams. Not all error or failure handling actions are shown, and Notes refer to the need for these actions in some FEAs. The figure numbers in which the FEAs appear are shown in square brackets [ ] after each FEA number.

FEA numbers have a 3-digit code with the first digit corresponding to the number of the FE in which the action occurs. Digit ranges for the second and third digits have no significance.

### 5.1 Functional Entity – FE2 (SSF/CCF)

#### FEA: 200 [3-2, 3-15, 3-18]

- On detection of armed TDP-R, formulate and send Initial DP req. ind. to SCF.
- Suspend call processing.

#### FEA: 201 [3-5]

- Receive and react to DISCONNECT req. ind. from CCAF.
- **Error! Reference source not found.** Formulate and send RELEASE req. ind. to SRF to release resources, if required.
- Disconnect.
- Stop charging, if applicable.
- Formulate and send RELEASE req. ind. to CCAF to release resources.

**FEA: 202 [3-5]**

- Receive and react to RELEASE resp. conf. from CCAF.
- Formulate and send Event Report BCSM req. ind. to SCF to report detection of EDP-N, if required.
- Formulate and send Call Information Report req. ind. to SCF, if required.

**FEA: 203 [3-6]**

- Receive and react to DISCONNECT req. ind. from CCAF.
- Formulate and send Event Report BCSM req. ind. to SCF.
- Formulate and send Call Information Report req. ind. to SCF, if required.
- Continue clearing call as per Recommendation Q.71 [6].

**FEA: 210 [3-2, 3-15, 3-18]**

- Receive Request Report BCSM Event req. ind. from SCF.
- Arm Detection Points as EDP-N to report user abandon (before answer – DP 10) and user disconnect (after answer – DP 9).

**FEA: 211 [3-2, 3-15, 3-18]**

- Receive and react to Establish Temporary Connection req. ind. from SCF.
- Formulate and send SETUP req. ind. to SRF to establish a connection to it.

**FEA: 212 [3-8, 3-14, 3-15]**

- Receive and react to Disconnect Forward Connection req. ind. from SCF.
- Formulate and send RELEASE req. ind. to SRF.

**FEA: 213 [3-8]**

- Receive and react to Release Call req. ind. from SCF.
- Continue clearing call as per Recommendation Q.71 [6].
- At end of clear down, formulate and send Call Information Report req. ind. to SCF, if required.

**FEA: 214 [3-14]**

- Receive Request Report BCSM Event req. ind. from SCF.
- Arm Detection Points as EDP-R or EDP-N to report route select failure (DP 4), B busy (DP 5), B no answer timeout (DP 6), and B clear (DP 9).

NOTE 1 – If follow-on call is allowed, the DPs will be armed as EDP-R, else as EDP-N. Only the first case is considered here.

**FEA: 215 [3-14, 3-15]**

- Receive Furnish Charging Information req. ind. from SCF.
- Initiate off-line charging according to specified rules.

NOTE 2 – This is an example only. Other charging methods can be used.

**FEA: 216 [3-14, 3-15]**

- Receive and react to Call Information Request req. ind. from SCF.
- Take appropriate action to record information.

**FEA: 217 [3-14, 3-15]**

- Receive Connect req. ind. from SCF.
- Restart basic call set-up, using destination routing address supplied by SCF.

NOTE 3 – Call processing restarts at PIC 3 in the Originating BCSM.



**FEA: 250 [3-2, 3-15, 3-18]**

- Receive and react to SETUP resp. conf. from SRF.
- Establish a relationship between the leg between the calling party and the SSF/CCF, and the leg between the SSF/CCF and the SRF.
- Through-connect calling party to SRF.

**FEA: 251 [3-5, 3-6]**

- Receive and react to RELEASE resp. conf. from SRF.
  - If no other RELEASE resp. conf. outstanding:
    - Formulate and send Event Report BCSM req. ind. to SCF, if required.
    - Formulate and send Call Information Report req. ind. to SCF, if required.
- NOTE 4 – SRF is being released at the end of a procedure. The call is being terminated.

**FEA: 252 [3-8, 3-14, 3-15]**

- Receive and react to RELEASE resp. conf. from SRF.
- NOTE 5 – The SRF is being released in the middle of a procedure and the call is not yet being terminated.

**FEA: 270 [3-7]**

- Receive and react to RELEASE req. ind. from forward direction.
  - Formulate and send Event Report BCSM req. ind. to SCF to report called party release (EDP-N).
  - Formulate and send Call Information Report req. ind. to SCF, if required.
  - Continue clearing call as per Recommendation Q.71 [6].
- NOTE 6 – These actions apply in the case of:
- a) a UPT user making an outgoing call, follow-on not allowed, B-party disconnects first after conversation; similar actions may apply after call set-up failure;
  - b) incoming call to UPT user, who disconnects first.

**5.2 Functional Entity – FE6 (SCF)****FEA: 600 [3-2, 3-18]**

- Receive and react to Initial DP req. ind. from SSF/CCF.
- Formulate and send Request Report BCSM Event req. ind. to SSF/CCF to arm Detection Points as EDP-N for abandon (DP 10) and disconnect (DP 9), if the latter is required.
- Formulate and send Establish Temporary Connection req. ind. to SSF/CCF to instruct it to connect to SRF.

**FEA: 601 [3-5, 3-6, 3-7]**

- Receive and react to Event Report BCSM req. ind. from SSF/CCF.
- If no Call Information Report pending, terminate call.

**FEA: 602 [3-5, 3-6, 3-7, 3-8]**

- Receive and react to Call Information Report req. ind. from SSF/CCF.
- Formulate and send Update Data req. ind. to SDF(h) to update user's home SDF with data received, e.g. end-of-call record (for statistics, etc.).

**FEA: 604 [3-15]**

- Receive and react to Initial DP req. ind. from SSF/CCF.
- Formulate and send Request Report BCSM Event req. ind. to SSF/CCF to arm Detection Points as EDP-N for abandon (DP 10) and disconnect (DP 9).

- Formulate and send Query req. ind. to SDF(h), to translate the UPT number to the current destination routing address of the called UPT user.

**FEA: 606 [3-11]**

- If allowed to register by originating network, formulate and send Update Data req. ind. to SDF(h) to store the specified network access address.
- If not allowed (permission denied or default address not retrieved), go to “User request denied” (see Figure 3-10).

**FEA: 620 [3-2]**

- Receive and react to Assist Request Instructions from SRF req. ind. from SRF.
- Formulate and send Prompt and Collect User Information req. ind. to SRF to prompt user to input his identity in the form of his UPT number.

**FEA: 621 [3-2, 3-3]**

- Receive and react to Collected User Information resp. conf. from SRF.
- Formulate and send Prompt and Collect User Information req. ind. to instruct SRF to prompt the UPT user for authentication information.

**FEA: 622 [3-2, 3-3]**

- Receive and react to Collected User Information resp. conf. from SRF.
- Start authentication of the UPT user.
- Formulate and send Query req. ind. to SDF(h) for data.

**FEA: 623 [3-4]**

- Receive and react to SR Report resp. conf. from SRF.
- Formulate and send Update Data req. ind. to UPT user’s home SDF, SDF(h), to update it with record of failure.
- Activate security measures to prevent access re-attempts.

**FEA: 624 [3-8]**

- Formulate and send Disconnect Forward Connection req. ind. to SSF/CCF to initiate disconnection of SRF (see Note 1).
- Formulate and send Release Call req. ind. to SSF/CCF to initiate disconnection of calling party (see Note 1).
- If required, send Update Data req. ind. to update SDF(h) with reasons for disconnection.

NOTE 1 – The order in which the two disconnection IFs are sent to the SSF/CCF is significant and is determined by the Finite State Machine for the SSF described in Recommendation Q.1218 [5].

**FEA: 625 [3-9]**

- Receive and react to Collected User Information resp. conf. from SRF.
- Analyse procedure identifier.
- Formulate and send Query req. ind. to SDF(o) on whether agreement exists between originating network and UPT user’s home network for originating network to provide user with procedure requested.

**FEA: 626 [3-10, 3-13]**

- Receive and react to Collected User Information resp. conf. from SRF.
- If new request required, go to FEA 651 in “Procedure identification” (see Figure 3-9).
- If user terminates, go to appropriate release sequence (see Figure 3-5 or Figure 3-6).

**FEA: 627 [3-11, 3-17]**

- Receive and react to Collected User Information resp. conf. from SRF.
- Formulate and send Prompt and Collect User Information req. ind. to prompt user to input codes for acknowledgement of input values (correct data) or cancel (incorrect data).
- If cancel received, go to “User request denied” (see Figure 3-10).

**FEA: 628 [3-11]**

- Receive and react to Collected User Information resp. conf. from SRF.
- If acknowledgement received, formulate and send Query req. ind. to originating network SDF, SDF(o), to verify the UPT user’s permission to register on the specified network access.
- If cancel received, go to “User request denied” (see Figure 3-10).

**FEA: 629 [3-12]**

- Formulate and send Query req. ind. to SDF(h) to retrieve appropriate default value for deregistration.

**FEA: 630 [3-14]**

- Receive and react to Collected User Information resp. conf. from SRF.
- If required, formulate and send Query req. ind. to SDF(h)A to authorize the dialled destination number.
- If authorization not required, go to FEA 687.

**FEA: 631 [3-15]**

- Receive and react to Assist Request Instructions from SRF req. ind. from SRF.
- Formulate and send Play Announcement req. ind. to SRF to play announcement of UPT charges.

NOTE 2 – Advice of end of announcement required.

**FEA: 632 [3-15]**

- Receive and react to SR Report resp. conf. from SRF.
- Formulate and send Disconnect Forward Connection req. ind. to SSF/CCF to initiate disconnection of SRF.
- Formulate and send Furnish Charging Information req. ind. to SSF/CCF to establish charge record for the call.
- Formulate and send Call Information Request req. ind. to SSF/CCF to report call event information to SCF (if required).
- Formulate and send Connect req. ind. to SSF/CCF to restart basic call set-up, using destination routing address supplied.

NOTE 3 – The charging method shown is an example only. Other charging methods can be used. If split charging is required, two charging records, for A- and B- parties, may be required.

**FEA: 633 [3-16, 3-17]**

- Receive and react to Collected User Information resp. conf. from SRF.
- Formulate and send Query req. ind. to SDF(h), to retrieve requested service profile information.

NOTE 4 – There may be some method of advising the UPT user of available services.

**FEA: 634 [3-17]**

- Receive and react to Specialized Resources Report req. ind. from SRF.
- Formulate and send Prompt and Collect User Information req. ind. to SRF to prompt user to input new service profile information or cancel code.

**FEA: 635 [3-17]**

- Receive and react to Collected User Information resp. conf. from SRF.
- If information input, formulate and send Update Data req. ind. to user's home SDF, SDF(h), to change service profile information.
- If "Cancel" input, go to "User request denied" (see Figure 3-10).

**FEA: 636 [3-18]**

- Receive and react to Assist Request Instructions from SRF req. ind. from SRF.
- Formulate and send Prompt and Collect User Information req. ind. to SRF to prompt user to input the UPT number for which reset is requested.

**FEA: 637 [3-18]**

- Receive and react to Collected User Information resp. conf. from SRF.
- Formulate and send Query req. ind. to SDF(h) with address of current terminal to screen against current registration location (see Note 5).

NOTE 5 – It is assumed that the address of the current terminal is available by CLI.

**FEA: 638 [3-18]**

- Receive and react to SR Report resp. conf. from SRF.
- Go to "Network initiated disconnection" (see Figure 3-8).

**FEA: 650 [3-3]**

- On first execution, receive and react to Query Result resp. conf. from SDF(o).
- On first execution, start SCF counter of authentication retries, using as the allowed limit the smaller of the two values retrieved from SDF(h) and SDF(o).
- Modify counter value as required.
- Formulate and send Update Data req. ind. to SDF(h) to record number of authentication failures.

**FEA: 651 [3-9]**

- Formulate and send Prompt and Collect User Information req. ind. to SRF to prompt UPT user to input code for procedure identification.

**FEA: 652 [3-9]**

- Receive and react to Query Result resp. conf. from SDF(o) on existence of service agreement with UPT user's home network.
- If allowed by originating network, formulate and send Query req. ind. to SDF(h) to see if user allowed by home network to use procedure.
- If not allowed (service agreement does not exist), go to "User request denied" (see Figure 3-10).

**FEA: 653 [3-10]**

- On first execution, receive and react to Query Result resp. conf. from SDF(o).
- On first execution, start SCF counter of procedure retries, using as the allowed limit the smaller of the two values retrieved from SDF(h) and SDF(o).
- Modify counter value as required.
- Test if limit reached:
  - If reached, go to FEA 675 in Figure 3-4, “Maximum retries reached”.
  - If not reached, formulate and send Prompt and Collect User Information req. ind. to SRF to play “failure” announcement and prompt user to input indication that a new request is required or terminate.

**FEA: 654 [3-11]**

- Receive and react to Query Result resp. conf. from SDF(o) on permission to register on specified address.
- If allowed to register, formulate and send Query req. ind. to home network SDF to verify the UPT user’s permission to register on the specified network access.
- If not allowed (permission denied), go to “User request denied” (see Figure 3-10).

**FEA: 670 [3-2]**

- Receive and react to Query Result resp. conf. from SDF(h).
  - If authentication successful, go to FEA 651 in “Procedure identification” (see Figure 3-9).
  - If unsuccessful, go to FEA 671 in “Authentication rejection and retry” (see Figure 3-3).

**FEA: 671 [3-3]**

- On first execution formulate and send Query req. ind. to SDF(h) to obtain limit value of authentication retries allowed to UPT user.

**FEA: 672 [3-3]**

- On first execution, formulate and send Query req. ind. to SDF(o) to obtain local limit value of authentication retries allowed to UPT user.

**FEA: 673 [3-3]**

- Receive and react to Query Result resp. conf. from SDF(h).
- If authentication successful, go to FEA 651 in “Procedure identification” (see Figure 3-9).
- If authentication has failed, go to FEA 650 in Figure 3-3, “Authentication retry”, to update record of failures.

**FEA: 674 [3-3]**

- Receive and react to Update Confirmation resp. conf. from SDF(h).
- Test if retry counter limit reached:
  - If reached, go to FEA 675 in Figure 3-4, “Maximum retries reached”.

- If not reached, formulate and send Prompt and Collect User Information req. ind. to SRF to play “failure” announcement and prompt user to input UPT number to restart authentication attempt or terminate.

**FEA: 675 [3-4]**

- Formulate and send Play Announcement req. ind. to SRF to play “failure” announcement with request to UPT user to hang up.

NOTE 6 – Advice of end of announcement required.

**FEA: 676 [3-4]**

- Receive and react to Update Confirmation resp. conf. from SDF(h).
- Go to “Network initiated disconnection” (see Figure 3-8) to initiate forced release of caller.

**FEA: 677 [3-5, 3-6, 3-7, 3-8]**

- Receive and react to Update Confirmation resp. conf. from SDF(h).

**FEA: 678 [3-9]**

- Receive and react to Query Result resp. conf. from SDF(h) on whether UPT user is allowed to use requested procedure.
- If allowed by home network, go to procedure requested.
- If not allowed, go to “User request denied” (see Figure 3-10).

**FEA: 679 [3-10]**

- If not already retrieved, formulate and send Query req. ind. to SDF(h) to obtain limit value of procedure identification retries allowed to UPT user.

**FEA: 680 [3-10]**

- If not already retrieved, formulate and send Query req. ind. to SDF(o) to obtain local limit value of procedure identification retries allowed to UPT user.

**FEA: 681 [3-11]**

- Formulate and send Prompt and Collect User Information req. ind. to SRF to prompt UPT user to input appropriate registration information.

**FEA: 682 [3-11, 3-12]**

- Receive and react to Update Confirmation resp. conf. from SDF(h) (result of registration or deregistration data update).
- If successful, go to “User request accepted” (see Figure 3-13).
- If unsuccessful, go to “User request denied” (see Figure 3-10).

**FEA: 684 [3-12]**

- Receive and react to Query Result resp. conf. from SDF(h) with requested default value.
- Error! Reference source not found.** Formulate and send Update Data req. ind. to SDF(h) to replace registration address with default value.

**FEA: 685 [3-13]**

- Formulate and send Prompt and Collect User Information req. ind. to SRF to play “success” announcement and prompt UPT user to input new request or terminate call.

**FEA: 686 [3-14]**

- Formulate and send Prompt and Collect User Information req. ind. to SRF to prompt UPT user to input B-party number.

NOTE 7 – The B-party number may be an ordinary directory number or a UPT number.

**FEA: 687 [3-14]**

- If destination number authorization was requested:
  - Receive and react to Query Result resp. conf. from SDF(h)A.
    - If authorization denied, go to “User request denied” (see Figure 3-10).
- If UPT number was dialled, formulate and send Query req. ind. to SDF(h)B to get current registered address of called UPT user.

**FEA: 688 [3-14]**

- If UPT translation in progress:
  - Receive and react to Query Result resp. conf. from SDF(h)B containing translated address.
    - If translation not successful, go to “User request denied” (see Figure 3-10).
- Formulate and send Disconnect Forward Connection req. ind. to SSF/CCF to initiate disconnection of SRF.
- Formulate and send Request Report BCSM Event req. ind. to SSF/CCF to arm Detection Points for B clear (DP 9), route select failure (DP 4), B busy (DP 5) and B no answer timeout (DP 6) (see Note 8).
- Formulate and send Furnish Charging Information req. ind. to SSF/CCF to establish charge record for the call (see Note 9).
- Formulate and send Call Information Request req. ind. to SSF/CCF to report call event information to SCF (if required).
- Formulate and send Connect req. ind. to SSF/CCF to restart basic call set-up, using destination routing address supplied.

NOTE 8 – If follow-on is allowed, arm as EDP-R, else as EDP-N. Only the case of EDP-R is considered here.

NOTE 9 – The charging method shown is an example only. Other charging methods can be used.

**FEA: 690 [3-15]**

- Receive and react to Query Result resp. conf. from SDF(h) containing translated address.
- Formulate and send Establish Temporary Connection req. ind. to SSF/CCF to instruct it to connect to SRF to play announcement to calling party.

**FEA: 691 [3-16]**

- Formulate and send Prompt and Collect User Information req. ind. to SRF to prompt UPT user to identify service profile information required.

**FEA: 692 [3-16]**

- Receive and react to Query Result resp. conf. from SDF(h) containing requested service profile information.
- If service profile information successfully retrieved, go to “User request accepted” (see Figure 3-13) to play announcement of result to user.
- If unsuccessful, go to “User request denied” (see Figure 3-10).

**FEA: 693 [3-17]**

- Formulate and send Prompt and Collect User Information req. ind. to SRF to prompt UPT user to identify service profile information to be modified.

**FEA: 694 [3-17]**

- Receive and react to Query Result resp. conf. from SDF(h) containing current values of service profile information.
- If data successfully retrieved, i.e. service profile modification allowed, formulate and send Play Announcement req. ind. to SRF to replay current service profile information to user.
- If service profile modification not allowed, go to “User request denied” (see Figure 3-10).

**FEA: 695 [3-17]**

- Receive and react to Update Confirmation resp. conf. from SDF(h).
- If successful, go to “User request accepted” (see Figure 3-11) to advise use of success.
- If unsuccessful, go to “User request denied” (see Figure 3-10).

**FEA: 696 [3-18]**

- Receive and react to Query Result resp. conf. from SDF(h).
- If current terminal is not the currently registered location (result is “no match”), go to FEA 699 to play announcement of failure to user.
- If result is “match”, formulate and send Query req. ind. to SDF(h) with address of current terminal to screen against default registration location (see Note 10).

NOTE 10 – It is assumed that the address of the current terminal is available by CLI.

**FEA: 697 [3-18]**

- Receive and react to Query Result resp. conf. from SDF(h).
- If current terminal is the default registered location (result is “match”), go to FEA 699 to play announcement of failure to user (see Note 11).
- If result is “no match”, formulate and send Query req. ind. to SDF(h) to retrieve default registration address.

NOTE 11 – In this case, the current terminal is the default registration location and reset will have no effect.

**FEA: 698 [3-18]**

- Receive and react to Query Result resp. conf. from SDF(h).
- If data successfully retrieved, formulate and send Update Data req. ind. to SDF(h) to reset the UPT user’s registration to the default location.
- If data not successfully retrieved, go to FEA 699 to play announcement of failure to user.

**FEA: 699 [3-18]**

- Receive and react to Update Confirmation resp. conf. from SDF(h) if pending.
- Formulate and send Play Announcement req. ind. to SRF to request it to play announcement to third party of result of reset request, and instruct caller to hang up.

NOTE 12 – Advice of end of announcement is required.

**5.3 Functional Entity – FE7 [SDF(o)]****FEA: 700 [3-3, 3-9, 3-10, 3-11]**

- Receive and react to Query req. ind. from SCF.
- Extract data requested.
- Formulate and send Query Result resp. conf. to SCF.



## 5.4 Functional Entity – FE8 (SRF)

### FEA: 800 [3-2, 3-15, 3-18]

- Receive and react to SETUP req. ind. from SSF/CCF.
- On successful establishment of connection:
  - Formulate and send SETUP resp. conf. to SSF/CCF.
  - Formulate and send Assist Request Instructions from SRF req. ind. to SCF.

### FEA: 801 [3-5, 3-7, 3-8, 3-14, 3-15]

- Receive and react to RELEASE req. ind. from SSF/CCF.
- Disconnect resources.
- Formulate and send RELEASE resp. conf. to SSF/CCF.

### FEA: 810 [3-2, 3-3, 3-9, 3-10, 3-11, 3-13, 3-14, 3-16, 3-17, 3-18]

- Receive and react to Prompt and Collect User Information req. ind. from SCF.
- Play announcement requested by SCF.
- Collect information.
- On successful receipt of information, or on error condition, formulate and send Collected User Information resp. conf. to SCF.

### FEA: 811 [3-4, 3-15, 3-17, 3-18]

- Receive and react to Play Announcement req. ind. from SCF.
- Play announcement requested by SCF.
- At end of announcement, send SR Report resp. conf. to SCF.

## 5.5 Functional Entity – FE9 [SDF(h)]

### FEA: 900 [3-2, 3-3, 3-9, 3-10, 3-12, 3-14, 3-15, 3-16, 3-17, 3-18]

- Receive and react to Query req. ind. from SCF.
- Extract data requested.
- Formulate and send Query Result resp. conf. to SCF.

### FEA: 901 [3-3, 3-4, 3-5, 3-6, 3-7, 3-8, 3-11, 3-12, 3-17, 3-18]

- Receive and react to Update Data req. ind. from SCF.
- UPT user's home network SDF, SDF(h), is updated.
- Formulate and send Update Confirmation resp. conf. to SCF to report update result (successful or unsuccessful).

## 6 Mapping of functional entities to physical entities

As the functional model for UPT is based on the IN functional model for CS-1, the mapping between functional entities FEs and physical entities PEs for UPT is also based on the related mapping for IN. The only difference is the distinction between the originating and the home database.

The PE used for the mapping are the same as those described in Recommendation Q.1215 and are the following:

- *Service Switching Point (SSP)* – The SSP provides switching functionality and, if it is a local exchange, provides the user with access to the network. The SSP allows access to IN capabilities after a request for IN service has been detected. It communicates with other PEs such as an SCP. Functionally, the SSP contains a Call Control Function (CCF), a Service Switching Function (SSF), and, if the SSP is a local

exchange, a Call Control Agent Function (CCAF). A Service Control Function (SCF), a Specialized Resource Function (SRF) and a Service Data Function (SDF) may be optionally contained in the SSP.

- *Network Access Point (NAP)* – This PE contains only the CCAF and CCF FEs. The NAP cannot communicate with an SCF but has the capability to recognize a call requesting an IN service and to route it to an SSP.
- *Service Control Point (SCP)* – The SCP contains Service Logic Programs (SLPs) and data used to provide services from an IN. SCP and SSP are connected by a signalling network. An SCP contains a Service Control Function (SCF) and a Service Data Function (SDF).
- *Adjunct (AD)* – This PE contains the same functionality as an SCP but is directly connected to the SSP by a high speed interface.
- *Intelligent Peripheral (IP)* – The IP provides resources (i.e. customised announcement, voice recognition, DTMF digits collection) for user interaction with the network. Functionally an IP contains a Specialized Resource Function (SRF).
- *Service Node (SN)* – The SN controls services provided by an IN and communicates directly with one or more SSPs. Functionally, the SN contains an SCF, SDF and SRF.
- *Service Switching and Control Point (SSCP)* – This is a combined SCP and SSP in a single node. Functionally it contains an SCF, SDF, CCAF, CCF and SSF. An SSCP may optionally contain an SRF.
- *Service Data Point (SDP)* – The SDP contains the customer and network data which is accessed during the execution of a service. Functionally, the SDP contains an SDF.

Table 6-1 is an extension of the typical scenarios of FE to PE mapping contained in Recommendation Q.1215 in order to be aligned with the UPT functional model in clause 2.

TABLE 6-1/Q.76

**Typical scenarios of FE to PE mapping for UPT**

PEs/FEs	SCF	CCF/SSF	SDF originating	SRF	SDF home
SCP	C	–	C	–	C
SN	C	–	C	C	C
AD	C	–	C	–	C
SSP	O	C	O	O	O
IP	–	–	–	C	–
SDP	–	–	C	–	C
SSCP	C	C	C	O	C
NAP	–	C (CCF only)	–	–	–
C Core O Optional – Not allowed For definitions, see Recommendation Q.1215. NOTE – SCF, CCF/SSF, SDF (originating) and SRF must all be contained within the originating network; SDF (home) may be contained within a network other than the originating network, and will be associated with an SCF in that other network. Where SCF is shown in the table, only one of SDF (originating) or SDF (home) can be associated with it.					

## Annex A

### Outgoing call follow-on

(This annex forms an integral part of this Recommendation)

#### A.1 Initiation of follow-on

Outgoing calls from a UPT user may be single calls, in which the procedure terminates at the end of the call, or may allow follow-on. The follow-on request may be for another call (“OutCall follow-on”) or for another UPT procedure (“global follow-on”). Follow-on will be offered to the UPT user after the B-party disconnects at the end of a conversation, or following call set-up failure due to route congestion, B-party busy or B-party no answer. For discussion of outgoing call set-up, see 3.3.1.1.

There are some difficulties in implementing these requirements within the constraints of normal call release procedures. If follow-on calls are to be implemented, the handling of normal network release sequences must be modified. The requirement is that resources in the forward direction are fully released when the B-party clears after conversation or if call set-up fails, but that resources in the backward direction (originating exchange to A-party) are not released until the A-party clears. Pending agreed solutions to these changes, this description of follow-on calls is contained in this annex.

For follow-on after a successful call, DP 9 is armed as EDP-R to detect B-party release. It is assumed that the RELEASE req. ind. is passed back immediately to the SSF/CCF. (See 3.1.2 for further discussion on recognition of B-party release). It is also assumed that B-party re-answer is not supported. Call processing is suspended at DP 9 and the SRF is re-connected to prompt the UPT user to input a code for OutCall or global follow-on. The user must indicate his requirements in some way as subsequent processing actions are different. If global follow-on is requested, processing will remain suspended at DP 9. Before the outgoing call was made processing was suspended at DP 2 or DP 3 and it is assumed that the status of A-party resources at DP 9 should be identical with those at DP 2 or DP 3 before the first outgoing call was made to ensure that there can be no subsequent discrepancies of A-party resource allocation. If OutCall follow-on is requested, processing can be restarted at the previous outgoing call commencement point, e.g. DP 3, but again it is assumed that the status of A-party resources should be identical with those obtaining at DP 3 before the first outgoing call was made.

In cases where the Release signal is not passed back to the originating exchange, it is possible that O\_Mid\_Call DP (DP 8) could be armed to allow the calling party to invoke follow-on from the active phase of the call. It is assumed that the caller would be aware from voice path indications that the called party had disconnected. This mechanism has not been examined further, but in Figure A.1 it is possible that follow-on could be initiated by O\_MidCall or Event Report BCSM req. ind. from SSF to SCF rather than by Release from the terminating end.

Follow-on after call set-up failure is initiated by detection of armed Detection Points at DP 4 (route selection failure), DP 5 (B-party busy) or DP 6 (B-party does not answer). In the case of DP 4 and DP 5, a RELEASE req. ind. with the cause is returned by the terminating end. Detection of DP 6, B-party no answer, is triggered by expiry of a timer in the originating exchange (see Recommendation Q.71 [6]). The value of this timer will be network-dependent, hence in some networks follow-on after no answer may not be offered to the UPT user until after an unacceptably long delay. In these cases a special timer in the SSF can be used to override the normal timer, with follow-on being offered after a shorter

time. This application timer is set via Request Report BCSM Event IF. The explanation given in 6.4.2.35/Q.1214 [4] is “If this timer expires, the SSF automatically tears down the forward connection to the B-party to avoid synchronization problems, then notifies the SCF”. The mechanism of notification is by Event Report BCSM req. ind. Thus in this case B-party release is assumed to have occurred before the SCF is notified of timer expiry.

## A.2 Release of resources

Whenever call processing is suspended after B-party RELEASE or no-answer timeout, the Q.71 [6] procedures for call clear down will have to be modified. In this case the A-party is not being cleared and DISCONNECT req. ind. towards the A-party cannot be sent. The release actions are handled by each resource (CCAF or CCF) separately and sequentially from the B-party towards the A-party, but each resource must receive RELEASE resp. conf. from the next resource towards the A-party before concluding the call. If the SSF/CCF completely suspends clear down and does not release resources and send RELEASE resp. conf. towards the B-party, the resource adjacent to the SSF/CCF could be left uncleared. Recommendation Q.71 [6] does not show any timer control on receipt of this RELEASE resp.conf. The required modifications for Recommendation Q.71 [6] have been proposed and were presented to Working Party 1 at the May 1993 meeting of Study Group 11.

### A.2.1 Release of B-party

FE2 (SSF/CCF) is first made aware of B-party disconnect when the Q.71 [6] RELEASE req. ind. is received from FE3 (another CCF). To prevent an undesired release of A-party resources, FE2 BCSM must be suspended before sending DISCONNECT req. ind. The description of the remaining actions in Recommendation Q.71 [6] (e.g. release of resources in the B-party direction and cessation of charging) has been included in the proposed modifications to Recommendation Q.71 [6].

Two mechanisms have been suggested for controlling the method of B-party release, one requiring a specific information flow from the SCF to the SSF/CCF, and the other based on implicit knowledge in the SSF/CCF.

- *Explicit information flow* – FE2 (SSF/CCF) notifies FE6 (SCF) of the receipt of the B-party release after conversation or on call set-up failure by Event Report BCSM req. ind. The SCF could then initiate forward clearing of the B-party by sending an appropriate instruction to the SSF/CCF. SWP XI/4-1 (IN), at its meeting in September 1992, considered this problem and proposed either a modified version of the Release Call information flow or the Release Call Party Connection information flow. The latter is suitable for such a purpose, but is in Appendix I/Q.1214 [4], since it was not fully defined.
- *Implicit SSF/CCF knowledge* – Once any of the Detection Points 4, 5, 6 or 9 are armed as EDP-R to report B-party release or call set-up failure, the SSF/CCF can assume that follow-on call is required, and hence can clear only the B-party resources, as required, on detection of any of the relevant DPs. This could be done in parallel with or before the event is reported to the SCF by Event Report BCSM req. ind. This mechanism is included in the ETSI Core INAP which is within the scope of CS-1 enhancement.

In both cases B-party re-answer cannot be supported.

The second method has been adopted here and it is assumed that SSF/CCF is able to determine that follow-on calls are required.

## A.2.2 A-party resources

The handling of release of A-party resources may depend on whether OutCall follow-on or global follow-on is requested. If the A-party wishes to attempt another call, the SCF (via the SRF) will elicit a new destination address. Call processing can resume at PIC 3 which, however, has already executed once. It is assumed here that if further action relating to A-party resources is necessary no instruction from SCF to SSF to that effect will be necessary, and the CCF can act autonomously.

If the A-party invokes global follow-on for a new procedure, processing remains suspended at DP 9, not DP 2 or DP 3 as was the case before any outgoing call was made. It is assumed that there is no effect on the status of the A-party resources at this point.

## A.3 Description and diagrams

### A.3.1 Outline description

The following is a high-level description of the actions required for the network to set up an outgoing call with follow-on, for both the options described in 3.3.1.1. The user has requested outgoing call and the SRF is still connected.

- 1) Prompt user to input destination number.
- 2) Collect destination number.
- 3) Authorize destination number [optional, interaction with SDF(h)A].
- 4) If number is a UPT number, translate it to the called UPT user's current InCall location [involves SDF(h)B].
- 5) Disconnect SRF.
- 6) Arm A-disconnect and B-disconnect trigger (DP 9) (twice) and triggers to detect call set-up failure (DPs 4, 5, 6); also arm DP 8 to detect mid-call feature activation (if required) and activate application timer on "B-party no answer" (if required).
- 7) "Furnish Charging Information" operation (or other charging operation).
- 8) "Call Information Request" operation (if want transfer of call data to SDF at end of call).
- 9) Connect to destination number using "Connect" operation (see Note).
- 10) B disconnects after conversation, or call set-up fails.
- 11) Report to SCF (Event Report BCSM or Route Select Failure operation).
- 12) Reconnect SRF ("Establish Temporary Connection" operation).
- 13) Prompt for next user input.
- 14) Decision:
  - If global follow-on requested, go to Procedure identification (see Figure 3-9).
  - If OutCall follow-on requested, go to 1) (follow-on call).
  - If A-party disconnects, terminate call.

NOTE – At this point, the new destination number is about to be passed to the SSF/CCF in the Connect operation.

### A.3.2 Information flow diagrams

Information flows are shown for the following procedures:

- Figure A.1: OutCall follow-on after successful outgoing call.
- Figure A.2: Follow-on after failure of outgoing call set-up.

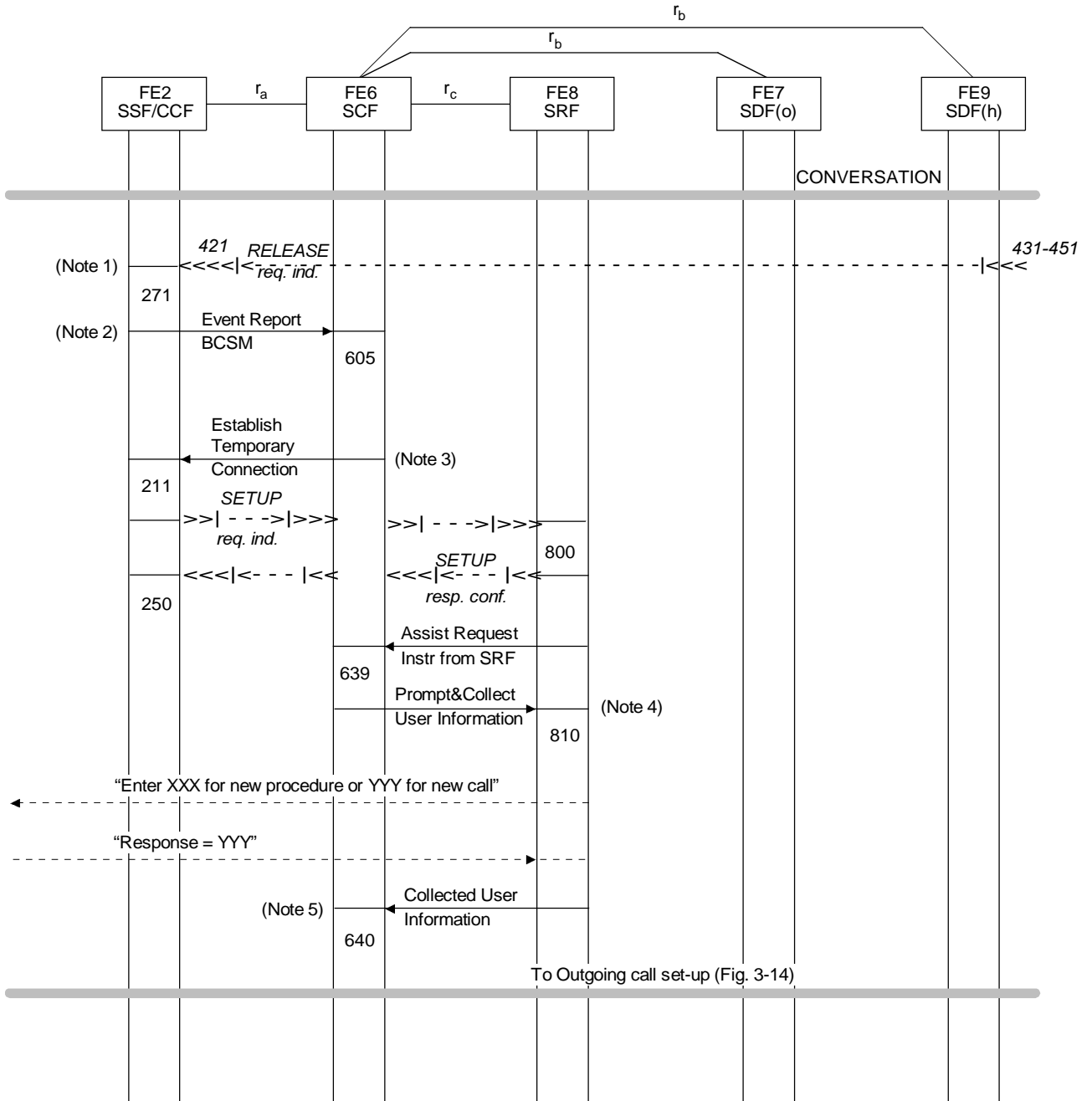

T1164580-94/d39

FIGURE A.1/Q.76  
OutCall follow-on after successful outgoing call

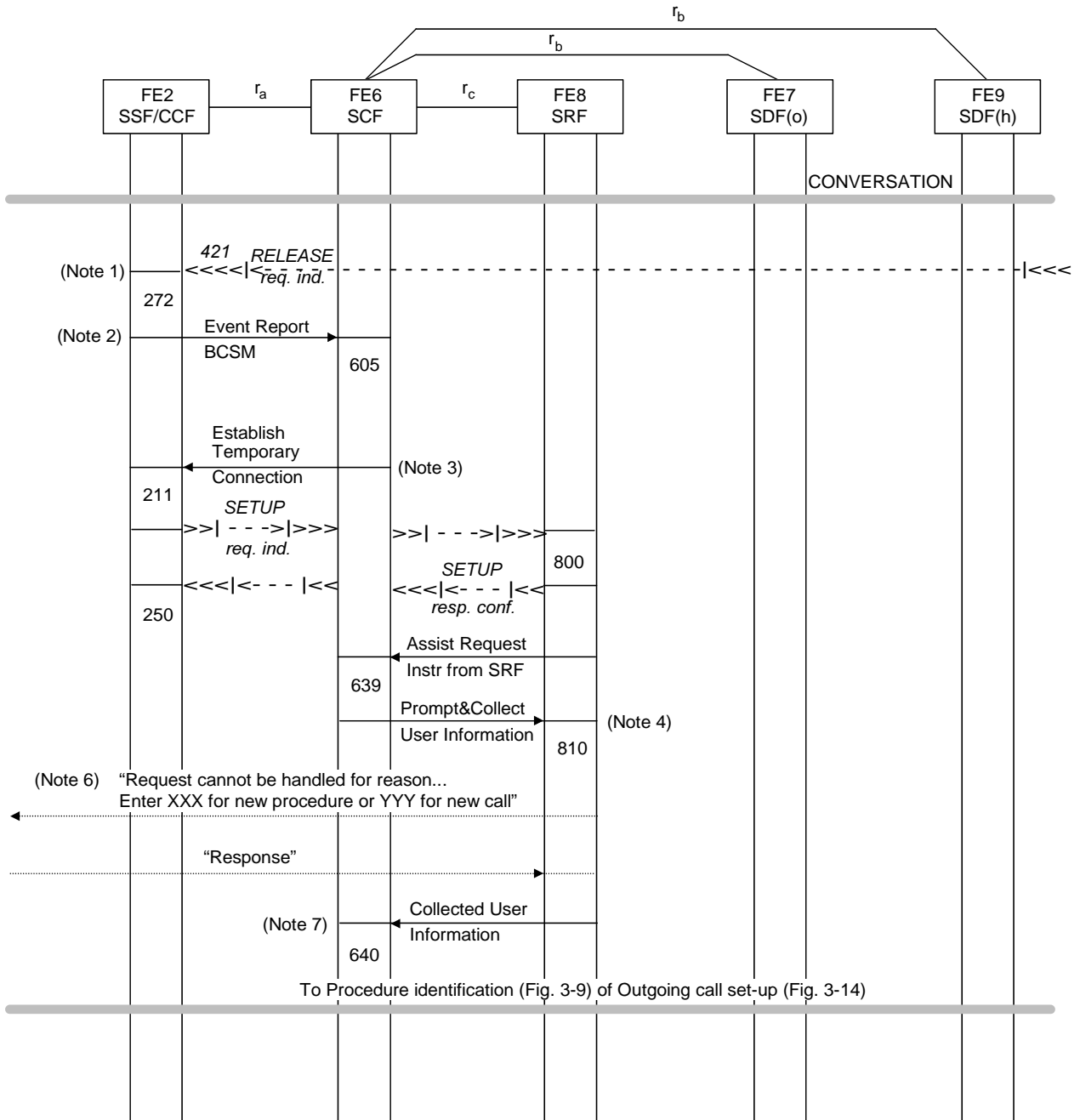

T1164590-94/d40

FIGURE A.2/Q.76  
Follow-on after of outgoing call set-up

## NOTES related to Figures A.1 to A.2

- 1 B-party disconnect is detected and reported to SCF.
- 2 It is assumed that the SSF/CCF handles the completion of B-party release. Modified Q.71 [6] procedures have been proposed in order to release the B-party, by sending RELEASE resp. conf. towards the B-party at this point, without sending DISCONNECT req. ind. towards the A-party.
- 3 The SRF is reconnected.
- 4 The user is prompted to input the code for a new outgoing call or a new procedure request.
- 5 If the user requests OutCall follow-on, go to start of Figure 3-14.
- 6 Set-up of the outgoing call has failed and the appropriate DP will be detected. RELEASE req. ind. is received only for B-party busy (DP 5). B-party no answer (DP 6) is triggered by timeout in the originating exchange (network or application timer). Since the call has not been answered, A-party abandon can still be detected at DP 10. The SSF/CCF handles the completion of B-party release.
- 7 If the user requests a new procedure, go to start of Figure 3-9, and if a new outgoing call, go to start of Figure 3-14.

### A.3.3 Functional entity actions

The following are additional functional entity actions which are required to implement OutCall and global follow-on after an outgoing call.

#### A.3.3.1 Functional Entity – FE2 (SSF/CCF)

##### FEA: 271 [A.1]

- Receive RELEASE req. ind. from resources in direction of called party.
- Formulate and send Event Report BCSM req. ind. to SCF to report B clear detected.
- Suspend call processing (at DP 9).

##### FEA: 272 [A.2]

- Receive and react to RELEASE req. ind. from resources in direction of called party (see Note).
- Formulate and send Event Report BCSM req. ind. to SCF to report failure of call set-up (congestion, no answer, B busy).
- Suspend call processing at appropriate Detection Point.

NOTE – This RELEASE req. ind. is only received for B-party busy. For B-party no answer, this FEA may be initiated by expiry of the timer.

#### A.3.3.2 Functional Entity – FE6 (SCF)

##### FEA: 605 [A.1, A.2]

- Receive and react to Event Report BCSM req. ind. or Route Select Failure req. ind. from SSF/CCF.
- Formulate and send Establish Temporary Connection req. ind. to SSF/CCF to instruct it to connect to SRF.

##### FEA: 639 [A.1, A.2]

- Receive and react to Assist Request Instructions from SRF req. ind. from SRF.
- Formulate and send Prompt and Collect User Information req. ind. to SRF to prompt user to input code for new procedure or new call.



**FEA: 640 [A.1, A.2]**

- Receive and react to Collected User Information resp. conf. from SRF.
- Analyse user response:
  - If global follow-on requested, go to “Procedure identification” (see Figure 3-9).
  - If OutCall follow-on requested, go to “Outgoing call set-up” (see Figure 3-14).