



INTERNATIONAL TELECOMMUNICATION UNION

**ITU-T**

TELECOMMUNICATION  
STANDARDIZATION SECTOR  
OF ITU

**P.58**

(08/96)

SERIES P: TELEPHONE TRANSMISSION QUALITY

Objective measuring apparatus

---

**Head and torso simulator for telephonometry**

ITU-T Recommendation P.58

(Previously CCITT Recommendation)

---

ITU-T P-SERIES RECOMMENDATIONS  
TELEPHONE TRANSMISSION QUALITY

Vocabulary and effects of transmission parameters on customer opinion of transmission quality	Series P.10
Subscribers' lines and sets	Series P.30 P.300
Transmission standards	Series P.40
<b>Objective measuring apparatus</b>	<b>Series P.50</b> <b>P.500</b>
Objective electro-acoustical measurements	Series P.60
Measurements related to speech loudness	Series P.70
Methods for objective and subjective assessment of quality	Series P.80 P.800
Audiovisual quality in multimedia services	Series P.900

*For further details, please refer to ITU-T List of Recommendations.*

## **ITU-T RECOMMENDATION P.58**

### **HEAD AND TORSO SIMULATOR FOR TELEPHONOMETRY**

#### **Summary**

This Recommendation specifies the electroacoustical characteristics of Head and Torso Simulators (HATS) to be used for telephonometric measurements. Both the sound generation and sound pick-up characteristics of these devices are specified.

The proposed revision of Recommendation P.58 concerns new distortion and output linearity requirements for the Artificial Mouths of the HATS (as for Recommendation P.51) and describes the positioning on the HATS of the revised Type 3.2 and new Type 3.4 Artificial Ears.

#### **Source**

ITU-T Recommendation P.58 was revised by ITU-T Study Group 12 (1993-1996) and was approved under the WTSC Resolution N°. 1 procedure on the 30th of August 1996.

## FOREWORD

ITU (International Telecommunication Union) is the United Nations Specialized Agency in the field of telecommunications. The ITU Telecommunication Standardization Sector (ITU-T) is a permanent organ of the ITU. The ITU-T is responsible for studying technical, operating and tariff questions and issuing Recommendations on them with a view to standardizing telecommunications on a worldwide basis.

The World Telecommunication Standardization Conference (WTSC), which meets every four years, establishes the topics for study by the ITU-T Study Groups which, in their turn, produce Recommendations on these topics.

The approval of Recommendations by the Members of the ITU-T is covered by the procedure laid down in WTSC Resolution No. 1 (Helsinki, March 1-12, 1993).

In some areas of information technology which fall within ITU-T's purview, the necessary standards are prepared on a collaborative basis with ISO and IEC.

## NOTE

In this Recommendation, the expression "Administration" is used for conciseness to indicate both a telecommunication administration and a recognized operating agency.

© ITU 1996

All rights reserved. No part of this publication may be reproduced or utilized in any form or by any means, electronic or mechanical, including photocopying and microfilm, without permission in writing from the ITU.

## CONTENTS

	<b>Page</b>
1	Scope..... 1
2	Object..... 1
3	Definitions ..... 1
4	Physical dimensions of HATS..... 4
4.1	Torso ..... 4
4.2	Head ..... 5
4.3	Pinna ..... 10
5	Acoustic characteristics ..... 11
5.1	Sound pick-up..... 11
5.1.1	Measurement conditions..... 11
5.1.2	Free-field frequency response..... 12
5.1.3	Diffuse-field frequency response..... 13
5.1.4	Monaural frequency response of HATS..... 14
5.1.5	Sound leakage..... 14
5.2	Sound generation ..... 15
5.2.1	Normalized free-field response..... 15
5.2.2	Normalized obstacle diffraction ..... 22
5.2.3	Maximum deliverable sound pressure level ..... 22
5.2.4	Distortion ..... 23
5.2.4.1	Harmonic distortion..... 23
5.2.5	Linearity..... 23
5.3	Composite characteristics ..... 24
5.3.1	Free-field plane wave diffraction at MRP ..... 24
5.3.2	Diffuse-field diffraction at MRP ..... 25
5.3.3	Mouth to ear crosstalk ..... 25
6	Miscellaneous ..... 26
6.1	Calibration of the Artificial Ears..... 26
6.2	DRP-ERP transfer function ..... 27
6.3	Stray magnetic field ..... 28
6.4	Atmospheric reference conditions ..... 29
6.5	Markings and calibration fixtures ..... 29
6.6	Delivery conditions..... 29
6.7	Materials ..... 29
6.8	Stability ..... 29
7	References..... 30



## Recommendation P.58

### HEAD AND TORSO SIMULATOR FOR TELEPHONOMETRY

*(Helsinki, 1993; revised in 1996)*

#### 1 Scope

This Recommendation specifies the Head And Torso Simulator (HATS) for telephonometric use. Both sound emissions and sound pick-up characteristics are specified, as well as the free-field acoustic diffraction.

The device is intended for airborne acoustic measurements, and is not suitable for measurements which depend on vibration conduction paths such as bone conduction. The HATS is intended to provide acoustic diffraction similar to that encountered around the median human head and torso and to generate an acoustic field similar to that generated by the human mouth, both in proximity and in the far field.

The methods of use of the HATS in telephonometry are outside the scope of this Recommendation, however the sound pick-up and diffraction characteristics specified by this Recommendation are in compliance with those recommended by the IEC for the measurement of hearing aids. The electroacoustic measurement methodologies for assessing the performances of hearing aids in their telecommunication applications are then, as far as applicable, as specified by the relevant IEC Publications.

#### 2 Object

The Head And Torso Simulator is a device that accurately reproduces the sound transmission and pick-up characteristics of the median head and torso of adult humans. Only the sound emission and pick-up characteristics affecting the electroacoustic measurements of telephone sets, headsets and hands-free telecommunication devices are considered.

The HATS consists of a head mounted on a torso that extends to the waist. The head is equipped with one or two artificial ears and with a mouth simulator. The HATS is specified physically as well as acoustically, and requirements are specified for both descriptions.

#### 3 Definitions

For the purposes of this Recommendation, the following definitions apply:

**3.1 head and torso simulator (HATS) for telephonometry:** Manikin extending downward from the top of the head to the waist, designed to simulate the sound pick-up characteristics and the acoustic diffraction produced by a median human adult and to reproduce the acoustic field generated by the human mouth.

**3.2 artificial ear:** A device for the calibration of earphones incorporating an acoustic coupler and a calibrated microphone for the measurement of the sound pressure and having an overall acoustic impedance similar to that of the median adult human ear over a given frequency band.

**3.3 ear reference point (ERP):** A virtual point for geometric reference located at the entrance to the listener's ear, traditionally used for calculating telephonometric loudness ratings.

**3.4 ear-drum reference point (DRP):** A point located at the end of the ear canal, corresponding to the ear-drum position.

- 3.5 ear canal entrance point (EEP):** A point located at the centre of the ear canal opening.
- 3.6 ear canal extension:** Cylindrical cavity extending the simulation of the ear canal provided by the occluded-ear simulator out to the concha cavity.
- 3.7 ear simulator:** Device for measuring the output sound pressure of an earphone under well-defined loading conditions in a specified frequency range. It consists essentially of a principal cavity, acoustic load networks, and a calibrated microphone. The location of the microphone is chosen so that the sound pressure at the microphone corresponds approximately to the sound pressure existing at the human ear-drum.
- 3.8 occluded-ear simulator:** Ear simulator which simulates the inner part of the ear canal, from the tip of an ear insert to the ear-drum.
- 3.9 pinna simulator:** A device which has the approximate shape and dimensions of a median adult human pinna.
- 3.10 lip ring:** Circular ring of thin rigid rod, having a diameter of 25 mm and less than 2 mm thick. It shall be constructed of non-magnetic material and be solidly fixable to the HATS. The lip ring defines both the reference axis of the mouth and the mouth reference point.
- 3.11 lip plane:** Outer plane of the lip ring. When the HATS is in the reference position, the lip plane is vertically oriented. The lip plane of HATS is normally different from the plane of the mouth simulator orifice.
- 3.12 reference axis:** The line perpendicular to the lip plane containing the centre of the lip ring.
- 3.13 vertical plane (plane of symmetry of the HATS):** A plane containing the reference axis that divides the HATS into symmetrical halves. It is vertically oriented when the HATS is in the reference position.
- 3.14 horizontal plane of HATS:** The plane containing the reference axis, perpendicular to the vertical plane. It is horizontally oriented when the HATS is in the reference position.
- 3.15 mouth reference point (MRP):** The point on the reference axis, 25 mm in front of the lip plane.
- 3.16 normalized free-field response (sound generation):** Difference in dB between the third-octave spectrum level of the signal delivered by the HATS mouth at a given point in the free field and the third-octave spectrum level of the signal delivered simultaneously at the MRP. The characteristic is measured by generating the Artificial Voice (see Recommendation P.50), a speech shaped random noise, a pink noise or other adequate wideband signals.
- 3.17 reference obstacle:** Disc constructed of hard, stable and non-magnetic material, such as brass, having a diameter of 63 mm and 5 mm thick. In order to measure the normalized obstacle diffraction of the mouth simulator, it shall be fitted with a ¼ inch pressure microphone, mounted at the centre with the diaphragm flush with the disc surface facing the HATS.
- 3.18 normalized obstacle diffraction:** Difference in dB between the third-octave spectrum level of the acoustic pressure delivered by the HATS mouth simulator at the surface of the reference obstacle and the third-octave spectrum level of the pressure simultaneously delivered at the point on the reference axis, 500 mm in front of the lip plane. The characteristic is defined for positions of the reference obstacle in front of the HATS mouth, with the disc axis coinciding with the reference axis, and is measured by generating the Artificial Voice (see Recommendation P.50), a speech shaped random noise, a pink noise or other adequate wideband signals.
- 3.19 HATS reference point (HRP):** The point bisecting the line joining the Ear canal Entrance Points (EEPs).



**3.20 axis of rotation:** A straight line about which the HATS can be rotated, passing through the HATS Reference Point (HRP), vertical to the horizontal plane and lying in the vertical plane. It is vertically oriented when the HATS is in the reference position.

**3.21 HATS reference plane:** A plane parallel to the horizontal plane, containing the HATS Reference Point (HRP).

**3.22 transverse plane:** A plane perpendicular to the reference axis and containing the HATS reference point.

**3.23 mouth-ear reference plane:** Plane containing the Ear canal Entrance Points (EEPs) of both ears and the centre of the lip ring on the lip plane.

**3.24 test point:** A reproducible position in the test space at which the sound pressure level is measured with the HATS absent and at which the HATS Reference Point (HRP) has to be located for test purposes.

**3.25 test axis:** The line through the test point, parallel to the propagation direction of externally applied plane progressive waves in a free sound field.

**3.26 test plane for measurement of the uniformity of the free field wavefront:** A plane perpendicular to the test axis and containing the test point.

**3.27 azimuth angle of sound incidence:** The angle between the vertical plane of the HATS and the plane defined by the axis of rotation and the test axis. When the HATS faces the sound source, the azimuth angle of sound incidence is defined as  $0^\circ$ . When the right ear of the HATS faces the sound source, the angle is defined as  $+90^\circ$ . When the left ear of the HATS faces the sound source, the angle is defined as  $+270^\circ$ .

**3.28 elevation angle of sound incidence:** The angle between the reference plane and the test axis. When the vertex points towards the sound source, the elevation angle is defined as  $+90^\circ$ . When the test axis lies in the reference plane, the elevation angle is defined as  $0^\circ$ .

**3.29 reference position of HATS:** The reference position of the HATS in the test space is intended to simulate a person in the upright position. The HATS is in the reference position when the following conditions are met:

- the reference point coincides with the test point;
- the HATS reference plane is horizontal.

**3.30 free-field frequency response of HATS (sound pick-up):** Difference, in dB, between the third-octave spectrum level of the acoustic pressure at the ear-Drum Reference Point (DRP) and the third-octave spectrum level of the acoustic pressure at the HATS Reference Point (HRP) in a free sound field with the HATS absent (test point).

**3.31 monaural free-field frequency response of HATS (sound pick-up):** The difference, in dB, between the third-octave spectrum level of the acoustic pressure at the ear-Drum Reference Point (DRP) for a given angle of sound incidence and the third-octave spectrum level of the acoustic pressure at the DRP for front ( $0^\circ$ ) sound incidence.

**3.32 diffuse field frequency response of HATS (sound pick-up):** Difference, in dB, between the third-octave spectrum level of the acoustic pressure at the ear-Drum Reference Point (DRP) and the third-octave spectrum level of the acoustic pressure at the HATS Reference Point (HRP) in a diffuse sound field with the HATS absent.

**3.33 free-field plane wave diffraction at MRP:** Difference, in dB, between the third-octave spectrum level of the acoustic pressure at the Mouth Reference Point (MRP) and the third-octave spectrum level of the acoustic pressure at the same point in a free sound field with the HATS absent.

The characteristic is measured for a frontal sound incidence, with a propagation direction parallel to the reference axis.

**3.34 diffuse field diffraction at MRP:** Difference, in dB, between the third-octave spectrum level of the acoustic pressure at the Mouth Reference Point (MRP) and the third-octave spectrum level of the acoustic pressure at the same point in a diffuse sound field with the HATS absent.

#### 4 Physical dimensions of HATS

The HATS geometrical references and the coordinate scheme for azimuth and elevation angles of the sound source are illustrated in Figures 1 and 2.

##### 4.1 Torso

The principal dimensions of the torso are illustrated in Figure 3 and ranges are listed in Table 1. The realization of the torso shall conform to the given ranges of dimensions and guarantee the conformance to the electroacoustic performances specified in this Recommendation.

NOTE – For the relevant dimensions, reference is made to the EEP position of the ears.

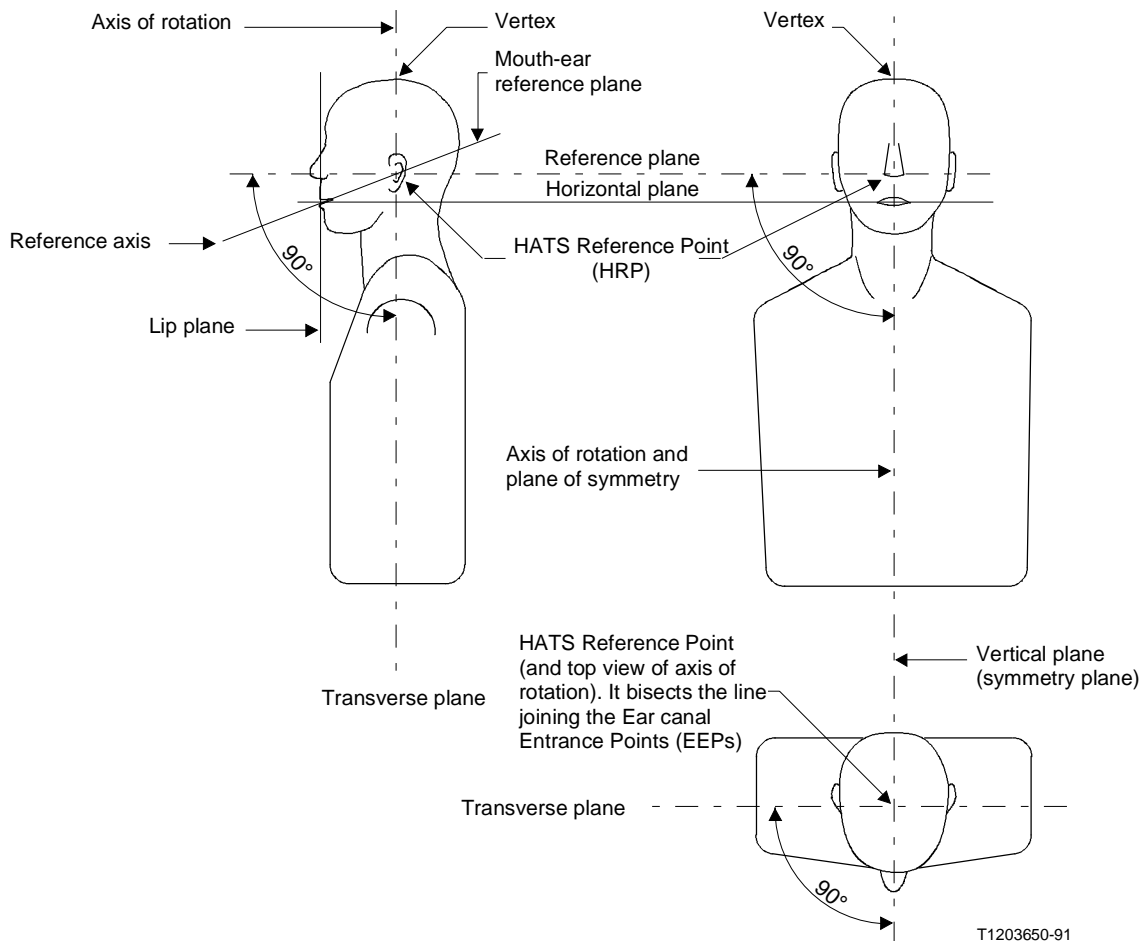

FIGURE 1/P.58

#### HATS geometrical references

## 4.2 Head

The principal dimensions of the HATS head are listed in Table 1. The realization of the head shall conform to the given ranges of dimensions and guarantee the conformance to the electroacoustic performances specified in this Recommendation.

NOTE – For the relevant dimensions, reference is made to the EEP position of the ears.

The cross-sections of the head surface, excluding pinnas, shall conform to the templates reported in Figures 4, 5, 6 and 7. In order to comply with this Recommendation, HATS shall comply both with dimensions in Table 1 and with cross-section templates shown in Figures 4, 5, 6 and 7.

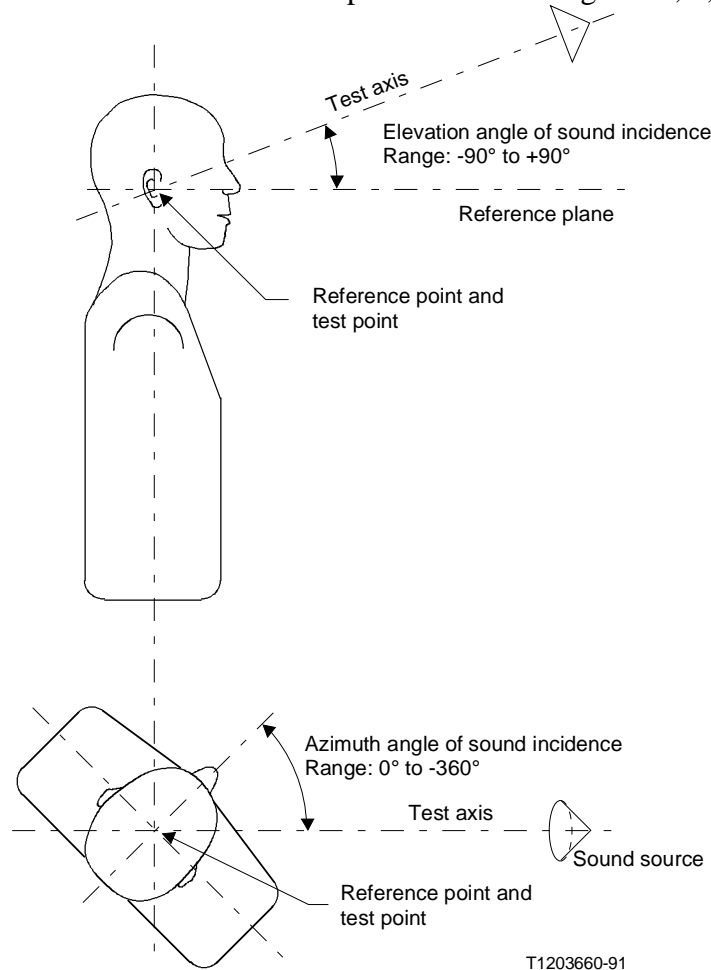

FIGURE 2/P.58

**Coordinate scheme for azimuth and elevation angles of the sound source**

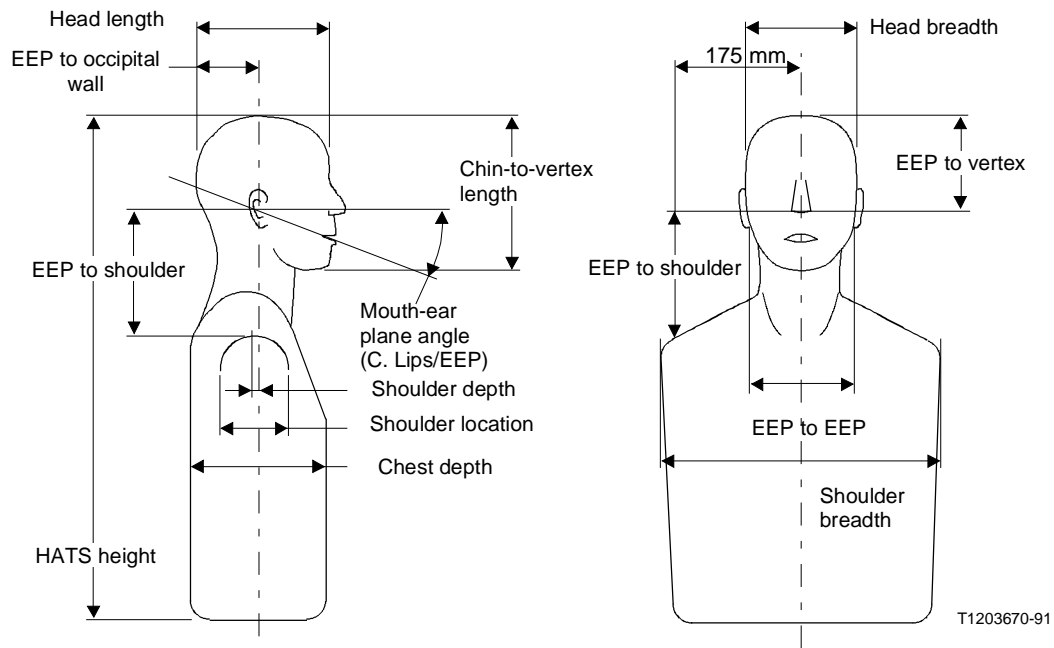
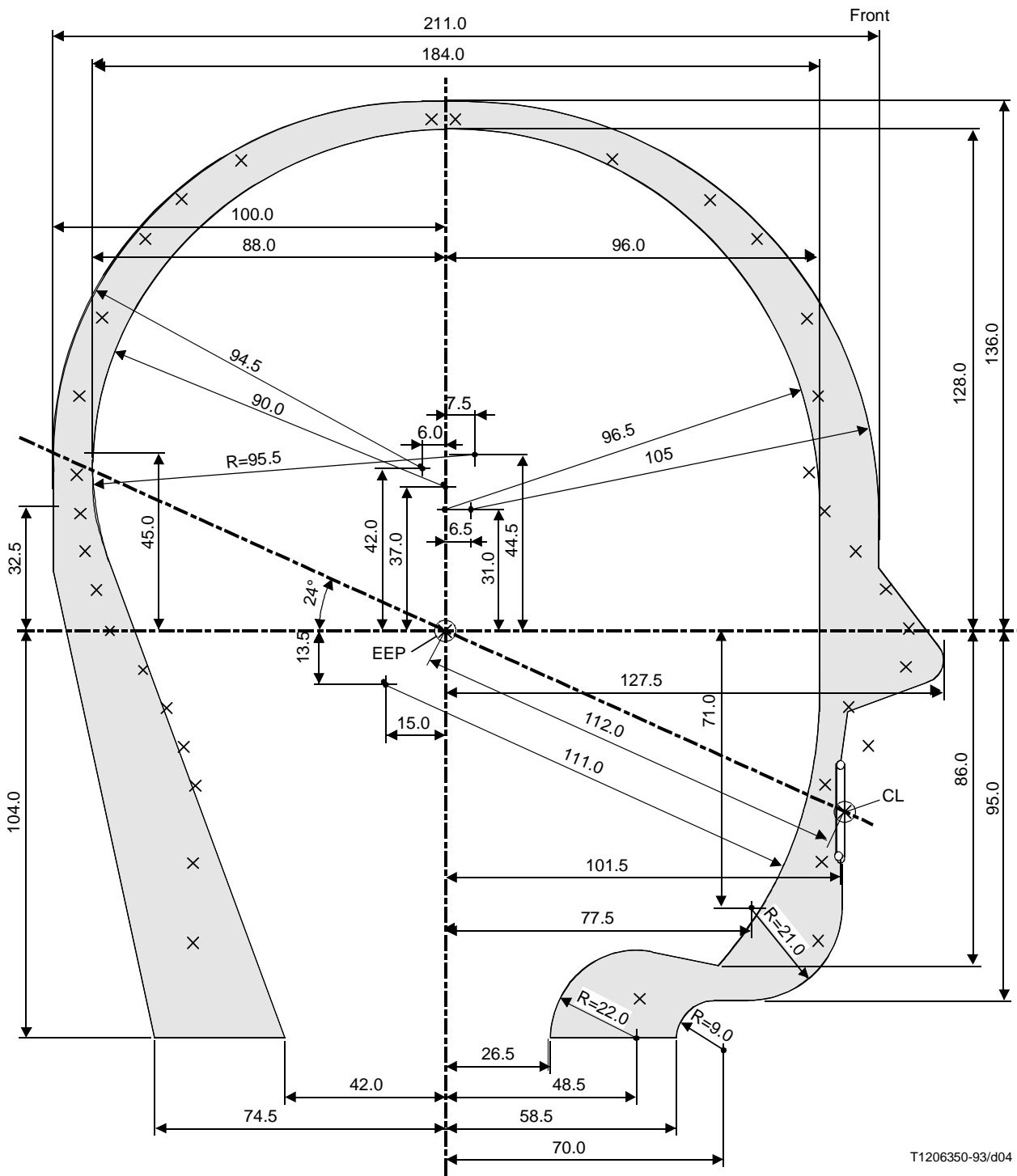

FIGURE 3/P.58  
**Illustration of HATS dimensions**

TABLE 1/P.58  
**Head and torso dimensions (linear dimensions in mm)**

Dimension	Nominal	Minimum	Maximum
Head breadth	152	147	154
Head length	191	190	205
EEP to vertex	130	128	136
EEP to EEP distance	132	130	133
EEP to occipital wall	94	92	100
EEP to shoulder <sup>a)</sup>	170	167	181
EEP to centre lips	130	128	131
Chin-to-vertex length	224	216	225
Mouth-ear plane angle	24°	21.5°	25.5°
Shoulder breadth	420	400	455
Chest depth	235	178	272
Shoulder depth <sup>b)</sup>	110	108	161
Shoulder location <sup>c)</sup>	10	-4	46
HATS height		600	

a) Measured from the shoulder surface, 175 mm sideways from the vertical plane, to the HATS reference plane.  
b) Measured between front and back shoulder points, 175 mm sideways from the vertical plane.  
c) Measured from the point of the shoulder section, 175 mm sideways from the vertical plane, to the HATS transverse plane (positive behind transverse plane).



T1206350-93/d04

X Profile specified in IEC 959 (1990)

FIGURE 4/P.58

Limits of the head cross-section in the vertical plane – dimensions in mm

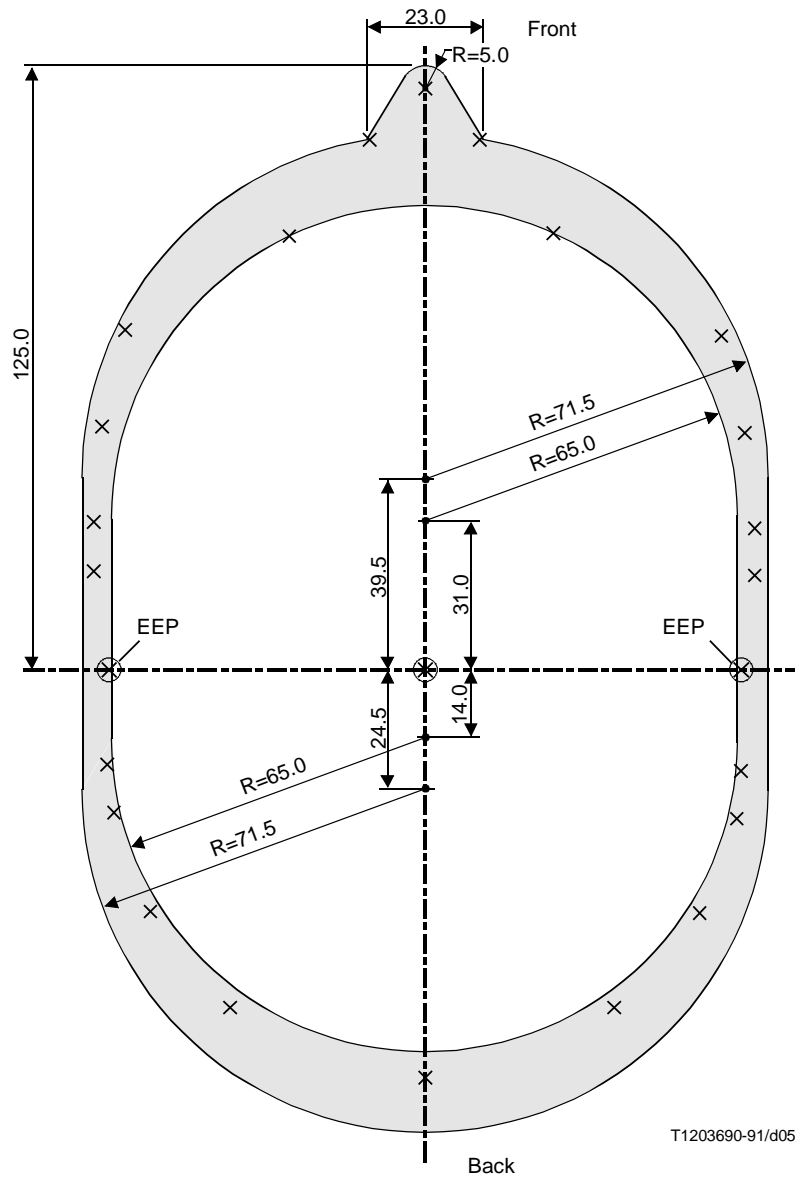

X Profile specified in IEC 959 (1990)

FIGURE 5/P.58

Limits of the head cross-section in the reference plane – dimensions in mm

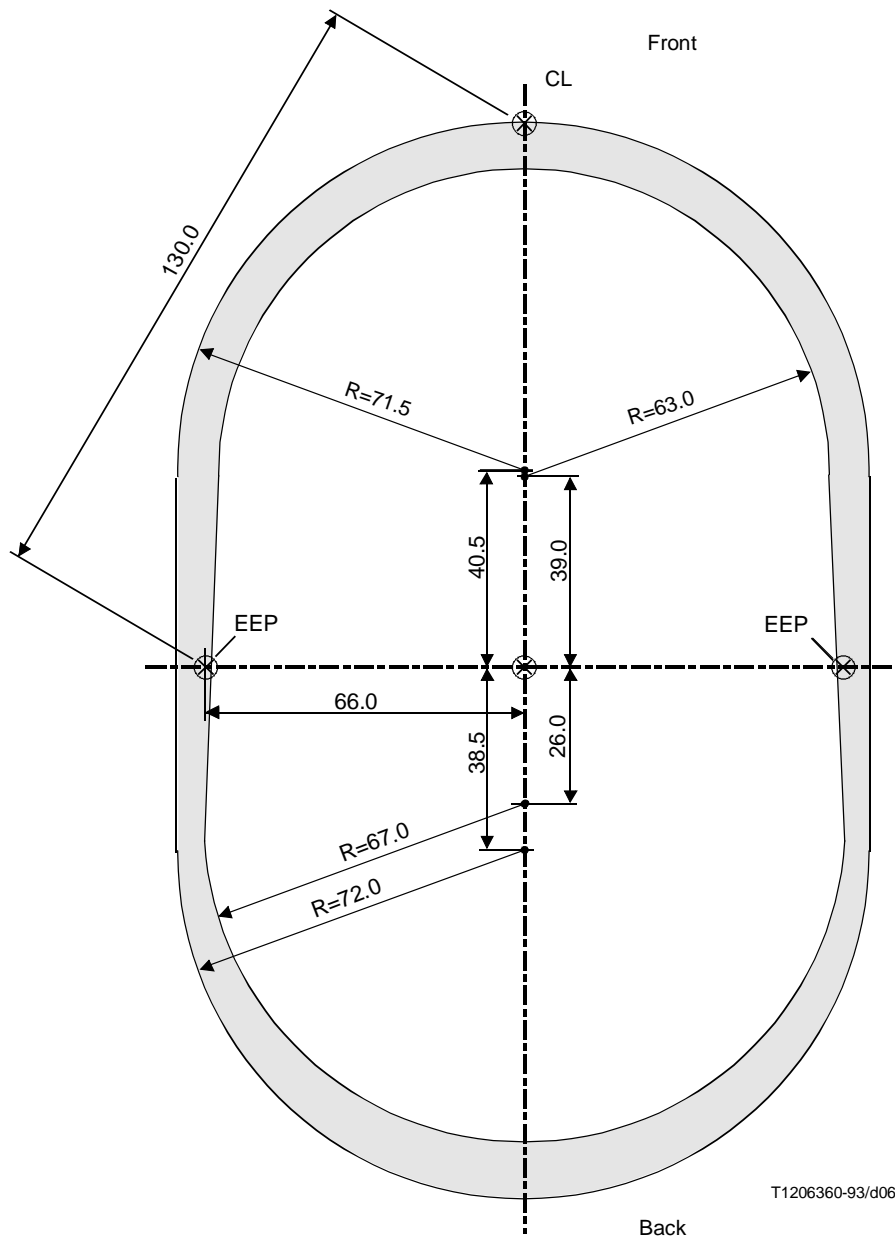
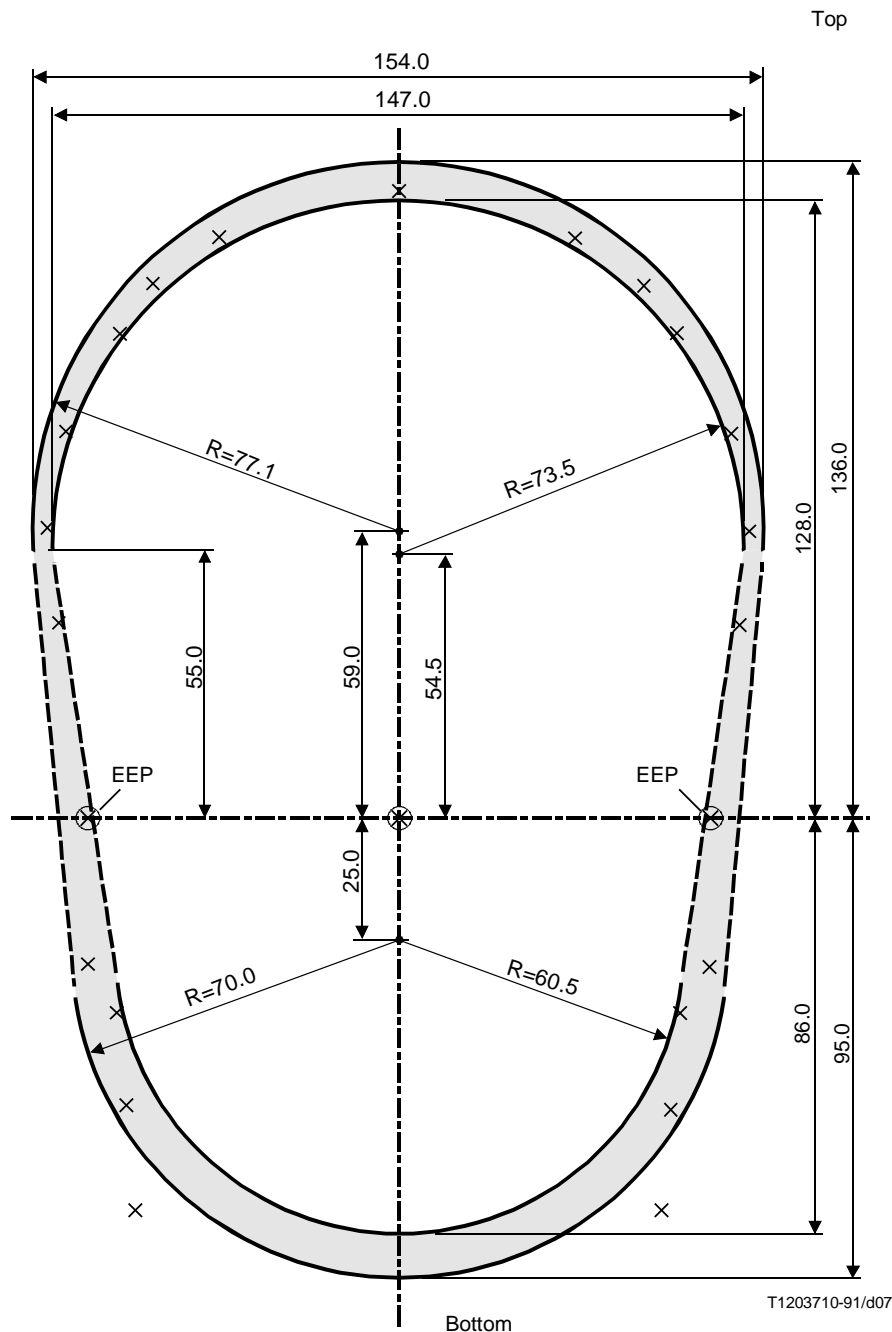

FIGURE 6/P.58

Limits of the head cross-section in the mouth-ear reference plane – dimensions in mm



X Profile specified in IEC 959 (1990)

FIGURE 7/P.58

**Limits of the head cross-section in the transverse plane – dimensions in mm**

**4.3 Pinna**

The dimensions of pinna are as specified in Recommendation P.57 for Type 3.3 artificial ear. The pinna shall be positioned on HATS in order to meet the following requirements:

- the EEP of Figure 7c/P.57 (0 mm) shall correspond to the EEP of Figure 5;
- the vertical axis through the dots in Figures 7b, 7c and 7d/P.57 is perpendicular to the HATS reference plane;



- the cross-sections reported in Figures 7b, 7c and 7d/P.57 are referred to planes parallel to the HATS reference plane;
- the baselines on Figures 7b, 7c and 7d/P.57 (horizontal with dot) shall be parallel to the HATS vertical plane.

The dimensions of the simplified pinna are as specified in Recommendation P.57 for Type 3.4 artificial ear. The pinna shall be positioned on HATS in order to meet the following requirements:

- the EEP of Figure 8/P.57 (0 mm) shall correspond to the EEP of Figure 5;
- the vertical axis through the axis of rotation (Reference plane) in Figure 8/P.57 is perpendicular to the HATS reference plane;
- the cross-section A-A reported in Figure 8/P.57 is referred to the HATS transverse plane and indicates a tilting of 1.3° downwards of the ear;
- the cross-section B-B reported in Figure 8/P.57 is referred to the transverse plane containing the EEP.

In order to fit Artificial Ear Type 3.2 (see Recommendation P.57) on HATS, the following rules shall be applied:

- the EEP in Figure 6/P.57 shall correspond to the EEP position in Figure 5;
- the line through the EEP in the sectioning plane of Figure 6/P.57, perpendicular to the ear canal axis, shall be parallel to the HATS reference plane and HATS vertical plane. The ERP is positioned to the rear of the EEP;
- the angle between the sectioning plane in Figure 6/P.57 and the HATS reference plane shall be 8° (pinna pointing downwards);
- the pinna simulator, including the ERP, shall be turned 11° around an axis through the EEP perpendicular to the above tilted sectioning plane (pinna pointing forwards).

## **5 Acoustic characteristics**

### **5.1 Sound pick-up**

The HATS shall be equipped with one or two Type 3.3 Artificial Ears. Irrespective whether one or two ears are installed, HATS shall always be equipped with two artificial pinnae.

#### **5.1.1 Measurement conditions**

Measurement of sound pick-up characteristics of the HATS shall be performed with equipment conforming to the following specifications.

##### **5.1.1.1 Test space and measurement equipment**

The sound pressure level of extraneous background noise, in each measurement frequency band, shall be at least 15 dB less than the sound pressure level in the same band of the test signal.

###### *Free-field measurements*

The test space and the sound source shall provide an approximation to plane progressive waves in free-field conditions in the frequency range 100 Hz-10 kHz.

These conditions are deemed to exist if the sound pressure levels measured at distances of 250 mm from the test point do not deviate from the sound pressure level at the test point by more than  $\pm 2$  dB up to 300 Hz and  $\pm 1$  dB above 300 Hz. The measurement points for testing compliances shall include two points on the test axis, respectively towards and away from the sound source. Four further measurement points in the test plane shall be included:

two in the reference plane, to the left and right as viewed from the sound source; the other two on the axis of rotation, above and below the test point.

NOTE – For an anechoic room, compliance cannot generally be expected unless the test point is further than 1 metre from the boundaries and the sound source is at least 2 metres from the boundaries.

The test sound source shall only contain coaxial elements or a single diaphragm, and the ratio of the maximum frontal sound source dimension to source distance shall be less than 0.25. In order to avoid reflections, the frontal area of the sound source baffle shall be covered by a suitable absorbing material.

– *Diffuse-field measurements*

Reference is made to ISO 4869-1.

### 5.1.1.2 Measurement of sound pressure level

The free-field calibration of the reference microphone used to measure the unobstructed free-field sound pressure level shall be accurate within  $\pm 0.5$  dB for frequencies up to 5 kHz and  $\pm 1.0$  dB from 5 kHz - 10 kHz.

The accuracy of the calibration of the occluded-ear simulator shall conform to the specifications in IEC Publication 711.

### 5.1.1.3 Positioning of HATS in the test space

The test space shall be equipped with fixtures permitting an accurate and repeatable positioning of the HATS in the reference position.

The horizontal positioning of the HATS reference plane shall be guaranteed within  $\pm 2^\circ$ .

### 5.1.1.4 Sound source positioning

The azimuth and elevation angles of the sound source shall be aligned with an accuracy of  $\pm 2^\circ$  relative to the vertical and reference planes of the HATS.

## 5.1.2 Free-field frequency response

Table 2 gives the HATS free-field frequency response, in dB relative to the free-field sound pressure level. Values are stated for elevation and azimuth angles of  $0^\circ$  (frontal incidence).

### 5.1.2.1 Tolerances

Tolerances on the HATS free-field frequency response are stated in Table 2. The values stated include the tolerances in the calibration of the occluded-ear simulator, but not the free-field calibration microphone.

TABLE 2/P.58

**Sound pick-up free field frequency response of HATS**

Frequency (Hz)	Free-field response (dB)	Tolerance (dB)
100	0.0	$\pm 1.0$
125	0.0	$\pm 1.0$
160	0.0	$\pm 1.0$
200	0.0	$\pm 1.0$

TABLE 2/P.58

**Sound pick-up free field frequency response of HATS**

Frequency (Hz)	Free-field response (dB)	Tolerance (dB)	
250	0.5	+1.0	-1.5
315	1.0	+1.0	-1.5
400	1.5	+1.0	-1.5
500	2.0	+1.5	-1.0
630	2.5	+1.5	-1.0
800	3.5	+2.5	-1.0
1000	3.5	+2.0	-1.5
1250	3.5	+2.5	-1.5
1600	5.0	+2.0	-3.0
2000	12.5	+1.0	-3.5
2500	18.5	+1.0	-4.0
3150	15.5	+5.0	-2.0
4000	13.0	+3.0	-1.0
5000	11.0	+4.5	-2.5
6300	5.0	+4.0	-2.5
8000	2.0	+9.0	-3.0
10 000	7.0	+3.0	-6.5

**5.1.3 Diffuse-field frequency response**

Table 3 gives the diffuse-field frequency response of HATS.

**5.1.3.1 Tolerances**

Tolerances on the HATS diffuse-field frequency response are stated in Table 3. The values stated include the tolerances in the calibration of the occluded-ear simulator, but not the diffuse-field calibration microphone.

TABLE 3/P.58

**Sound pick-up diffuse field frequency response of HATS**

Frequency (Hz)	Diffuse-field response (dB)	Tolerance (dB)
100	0.0	±1.0
125	0.0	±1.0
160	0.0	±1.0
200	0.0	±1.0

TABLE 2/P.58

**Sound pick-up free field frequency response of HATS**

Frequency (Hz)	Free-field response (dB)	Tolerance (dB)	
250	0.5	±1.0	
315	0.5	±1.0	
400	1.0	±1.0	
500	1.5	±1.5	
630	2.0	±1.5	
800	4.0	±2.0	
1000	5.0	±2.0	
1250	6.5	±1.5	
1600	8.0	±1.5	
2000	10.5	+2.0	-1.0
2500	14.0	+2.0	-3.0
3150	12.0	+6.0	-1.0
4000	11.5	+5.0	-2.0
5000	11.0	+5.0	-2.0
6300	8.0	+2.0	-3.0
8000	6.5	+5.0	-4.0
10 000	10.5	0.0	-10.0

**5.1.4 Monaural frequency response of HATS**

Table 4 gives the HATS monaural frequency response. Values are stated for an elevation angle of 0° and azimuth angles of 90°, 180° and 270° for the right ear. Corresponding symmetrical azimuth angles apply for the left ear.

**5.1.4.1 Tolerances**

Tolerances on the HATS monaural frequency response are stated in Table 4.

**5.1.5 Sound leakage**

With the ear canal under test effectively sealed from external sound at the reference plane of the occluded-ear simulator and the other ear canal blocked, the measurement of the free-field frequency response of HATS shall give results at least 35 dB below those obtained with the ear canal open.

NOTE – Suitable plugs or equivalent arrangements for checking the conformance to this requirement without disassembling the HATS external ear shall be provided by the manufacturer.

TABLE 4/P.58

**Monaural frequency response (dB) of HATS – right ear**

Frequency (Hz)	Azimuth angle			Tolerance (dB)
	90°	180°	270°	
100	0.0	0.0	0.0	±1.0
125	0.5	0.0	0.0	±1.0
160	1.0	-0.5	0.0	±1.0
200	1.5	-0.5	-1.0	±1.0
250	1.5	-0.5	-1.0	±1.0
315	2.0	-0.7	-1.0	±1.5
400	2.5	-1.0	-1.0	±2.0
500	3.5	-1.0	-1.0	±2.0
630	4.5	0.0	-0.5	±2.0
800	4.0	0.5	-1.0	±2.0
1000	4.5	1.5	-1.0	±2.0
1250	5.8	2.5	-0.5	±2.5
1600	5.0	1.0	-0.5	±2.0
2000	-0.5	-2.0	-4.0	±2.0
2500	0.0	-2.5	-6.0	±2.0
3150	1.5	-3.0	-8.0	±2.0
4000	1.5	-3.0	-	±2.0
5000	3.5	-4.0	-	±4.5
6300	12.0	-1.0	-	±4.5
8000	12.0	3.5	-	±6.0
(10 000)	6.0	-3.0	-	

**5.2 Sound generation****5.2.1 Normalized free-field response**

The normalized free-field response is specified at 23 points: 11 in the near field and 12 in the far field. Near-field points are listed in Table 5, while far-field points are listed in Table 6.

NOTE 1 – Azimuth and elevation angles given in Table 6 are referred to the vertical and the horizontal planes and are computed for the line joining the measurement points to the centre of the lip ring. The same sign conventions of the angles defined for sound incidence apply.

TABLE 5A/P.58

**Coordinates of points in the near field**

Measurement point	On axis displacement from the lip plane (mm)	Off axis, perpendicular displacement (mm)
1	12.5	0
2	50	0
3	100	0
4	140	0
5	0	20 horizontal
6	0	40 horizontal
7	25	20 horizontal
8	25	40 horizontal
9	25	20 vertical (down)
10	25	40 vertical

TABLE 5B/P.58

**Coordinates of the "Boom Microphone Position (BMP) "**

Measurement point # 21	
On axis <sup>1)</sup> displacement <sup>2)</sup>	-6 mm (backwards)
Off axis <sup>1)</sup> horizontal displacement	42 mm (right)
Off axis <sup>1)</sup> vertical displacement	-9 mm (down)
<sup>1)</sup> Reference axis.	
<sup>2)</sup> Distance from the lip plane.	

TABLE 6A/P.58

**Coordinates of far-field front points**

Measurement point	Distance from the lip plane (mm)	Azimuth angle (horizontal) (°)	Elevation angle (vertical) (°)
11	500	0	0
12	500	0	+15 (up)
13	500	0	+30 (up)
14	500	0	-15 (down)
15	500	0	-30 (down)
16	500	15	0
17	500	30	0

TABLE 6B/P.58

**Coordinates of points in the far field behind and above the talker**

Measurement point	Distance from the centre of the lip ring (mm)	Azimuth angle (horizontal) (°)	Elevation angle (vertical) (°)
22	500	90	0
23	500	135	0
24	500	180	0
25	500	180	45 (up)
26	500	0	90 (up)

NOTE – It shall be noticed that points in Table 6A lie on a plane while points in Table 6B lie on a surface of a sphere.

Table 7 provides the normalized free-field response of the HATS mouth, together with tolerances, for the bandwidth between 100 Hz and 8 kHz. The requirements at each point not lying in the vertical plane shall also be met by the corresponding point in the symmetrical half-space.

NOTE 2 – The normalized response at off-axis points in the near field are given in Tables 7B and 7C. Points in Table 7B are not significantly affected by the body reflection and about the same tolerance set applies as in Recommendation P.51 (Artificial mouth). Points in Table 7C are affected by the body reflection and different tolerances apply with respect to Recommendation P.51.

The normalized free-field response shall be checked by using appropriate microphones, as specified in Table 8. Pressure microphones shall be oriented with their axis perpendicular to the sound direction, while free-field microphones shall be oriented with their axis parallel to the direction of sound.

NOTE 3 – If a compressor microphone is normally used in the HATS, it (or an equivalent dummy) shall be left in place while checking the normalized free-field response.

TABLE 7A/P.58

**Normalized free-field response at points on-axis in the near field**

Frequency (Hz)	Measurement point				Tolerance (dB)
	1 (dB)	2 (dB)	3 (dB)	4 (dB)	
100	4.2	-5.0	-11.0	-13.6	+2/-1.5
125	4.2	-5.0	-10.9	-13.6	+2/-1.5
160	4.2	-5.0	-10.7	-13.6	+2/-1.5
200	4.0	-5.0	-10.7	-13.3	+2/-1.5
250	4.0	-5.0	-10.6	-13.2	+2/-1.5
315	4.0	-5.0	-10.6	-13.2	+2/-1.5
400	4.0	-5.0	-10.6	-13.2	+2/-1.5
500	4.1	-5.0	-10.6	-13.2	+2/-1.5
630	4.2	-4.9	-11.3	-14.2	+1/-1.5
800	4.2	-4.8	-11.9	-15.1	+1/-2.0

TABLE 7A/P.58

**Normalized free-field response at points on-axis in the near field**

Frequency (Hz)	Measurement point				Tolerance (dB)
	1 (dB)	2 (dB)	3 (dB)	4 (dB)	
1000	4.1	-4.8	-11.4	-14.6	+1/-2.0
1250	3.9	-4.8	-10.2	-13.8	+1/-1.5
1600	3.8	-4.8	-10.0	-12.7	+1/-1.5
2000	3.6	-4.7	-10.0	-12.7	+1/-1.5
2500	3.5	-4.6	-9.4	-13.3	+1/-1.5
3150	3.6	-4.6	-9.4	-12.0	+1/-1.5
4000	3.7	-4.6	-9.7	-12.3	±1.5
5000	3.7	-4.5	-9.7	-12.6	±1.5
6300	3.8	-4.5	-9.7	-12.6	±1.5
8000	3.8	-4.9	-10.0	-12.7	±1.5

TABLE 7B/P.58

**Normalized free-field response at points off-axis in the near field**

Frequency (Hz)	Measurement point				Tolerance (dB)
	5 <sup>a)</sup> (dB)	7 (dB)	8 (dB)	9 (dB)	
100	5.2	-1.4	-4.0	-1.6	±1.5
125	5.2	-1.3	-3.8	-1.5	±1.5
160	5.2	-1.2	-3.8	-1.5	±1.5
200	5.2	-1.2	-3.8	-1.5	±1.5
250	5.2	-1.3	-3.8	-1.4	±1.5
315	5.1	-1.3	-3.8	-1.3	±1.0
400	5.1	-1.3	-3.8	-1.3	±1.0
500	5.0	-1.3	-3.8	-1.3	±1.0
630	5.0	-1.3	-3.8	-1.3	±1.0
800	5.0	-1.3	-3.8	-1.3	±1.0
1000	4.8	-1.3	-3.9	-1.3	±1.0
1250	4.8	-1.4	-4.0	-1.3	±1.0
1600	4.7	-1.4	-3.8	-1.3	±1.0
2000	4.7	-1.2	-3.7	-1.3	±1.0
2500	4.7	-1.0	-3.6	-1.1	±1.0



TABLE 7B/P.58

**Normalized free-field response at points off-axis in the near field**

Frequency (Hz)	Measurement point				Tolerance (dB)
	5 <sup>a)</sup> (dB)	7 (dB)	8 (dB)	9 (dB)	
3150	4.7	-1.1	-3.5	-1.2	± 1.0
4000	4.5	-1.5	-4.1	-1.3	± 1.5
5000	3.8	-1.5	-4.8	-1.3	± 1.5
6300	3.2	-1.8	-5.2	-1.7	± 2.0
8000	2.5	-2.0	-6.1	-1.8 <sup>b)</sup>	± 3.0

<sup>a)</sup> The measurements on the human mouth at point 5 are quite scattered, so the response at this point is only indicatively provided and no tolerances apply.

<sup>b)</sup> Slight difference from the Artificial Mouth requirement (Recommendation P.51) due to the nose diffraction.

TABLE 7C/P.58

**Normalized free-field response at points off-axis in the near field**

Frequency (Hz)	Measurement point			Tolerance (dB)
	6 (dB)	10 (dB)	21 (dB)	
100	-1.7	-4.2	-3	± 1.5
125	-1.7	-4.2	-3	± 1.5
160	-1.7	-4.2	-3	± 1.5
200	-1.7	-4.2	-3	± 1.5
250	-1.8	-4.2	-3	± 1.5
315	-1.8	-4.2	-3	+1.0/-1.5
400	-1.8	-4.0	-3	+1.0/-1.5
500	-1.6	-3.9	-3	+1.0/-1.5
630	-1.6	-3.9	-3	+1.0/-1.5
800	-1.6	-4.0	-3	+1.0/-1.5
1000	-1.7	-4.1	-3	+1.0/-2.0
1250	-1.8	-4.3	-3	+1.0/-2.0
1600	-1.8	-4.0	-3	+1.0/-2.5
2000	-1.8	-3.6	-3	+1.0/-2.5
2500	-1.9	-3.5	-3	+1.0/-2.5
3150	-2.1	-3.4	-3	+1.0/-2.5
4000	-2.9	-3.0	-4	+1.0/-2.5

TABLE 7C/P.58

**Normalized free-field response at points off-axis in the near field**

Frequency (Hz)	Measurement point			Tolerance (dB)
	6 (dB)	10 (dB)	21 (dB)	
5000	-3.6	-3.7	-5	+1.0/-3.0
6300	-5.0	-3.7	-6	+1.5/-4.0
8000	-5.2	-4.2	-7	+3.0/-7.5

TABLE 7D/P.58

**Normalized free-field response in the far field in front of the talker**

Frequency (Hz)	Measurement point							Tolerance (dB)
	11 (dB)	12 (dB)	13 (dB)	14 (dB)	15 (dB)	16 (dB)	17 (dB)	
100	-24	-24	-25	-24	-25	-24	-25	+3/-4
125	-24	-24	-25	-24	-25	-24	-25	+3/-4
160	-24	-24	-25	-24	-25	-24	-25	+3/-4
200	-24	-24	-25	-24	-25	-24	-25	+3/-4
250	-24	-24	-24	-24	-24	-24	-24	± 3
315	-24	-24	-24	-24	-24	-24	-24	± 3
400	-24	-24	-24	-24	-24	-24	-24	± 3
500	-24	-24	-24	-24	-24	-24	-24	± 3
630	-25.5	-25.5	-25.5	-24	-23	-25.5	-25.5	+3/-4
800	-27	-27	-27	-25.5	-23	-27	-27	+3/-4
1000	-25.5	-25.5	-25.5	-27	-25.5	-27	-27	+3/-4
1250	-24	-24	-24	-25.5	-27	-25.5	-25.5	+3/-4
1600	-24	-24	-24	-24	-27	-24	-24	+3/-4
2000	-24	-24	-24	-24	-25.5	-24	-24	± 3
2500	-24	-24	-24	-24	-23	-24	-24	± 3
3150	-24	-24	-24	-24	-23	-24	-24	± 3
4000	-24	-24	-24	-24	-24	-24	-24	± 3
5000	-24	-24	-24	-24	-24	-24	-24	± 3
6300	-24	-24	-24	-24	-24	-24	-24	± 3
8000	-24	-24	-24	-24	-24	-24	-24	± 3

TABLE 7E/P.58

**Normalized free-field response in the far field behind and above the talker**

Frequency (Hz)	Measurement point					Tolerance (dB)
	22 (dB)	23 (dB)	24 (dB)	25 (dB)	26 (dB)	
100	-24.5	-24.5	-25.0	-25.0	-24	+3/-5
125	-24.5	-25.1	-25.7	-25.0	-24	+3/-5
160	-24.5	-25.7	-26.4	-25.0	-24	+3/-5
200	-24.5	-26.3	-27.1	-25.0	-24	+3/-4
250	-24.5	-26.9	-27.8	-25.0	-24	+3/-4
315	-24.5	-27.5	-28.5	-25.0	-24	+3/-4
400	-24.5	-28.1	-29.2	-25.0	-24.5	+3/-4
500	-24.5	-28.7	-29.9	-25.8	-25.2	+3/-5
630	-25.1	-29.3	-30.6	-26.6	-26.5	+3/-5
800	-25.7	-29.9	-31.3	-27.4	-26.5	+3/-5
1000	-26.3	-30.5	-32.0	-28.2	-26.5	+3/-5
1250	-26.9	-30.5	-33.5	-29.0	-26.5	+3/-5
1600	-27.5	-30.5	-35.0	-29.8	-26.5	+3/-5
2000	-27.5	-30.5	-36.5 <sup>a)</sup>	-30.6	-26.5	+3/-5
2500	-27.5	-32.1	-38.0 <sup>a)</sup>	-31.4	-26.5	+3/-5
3150	-27.5	-33.7	-39.5 <sup>a)</sup>	-32.2	-26.5	+3/-5
4000	-27.5	-35.3	-41.0 <sup>a)</sup>	-33.0	-26.5	+3/-5
5000	-29.0	-36.9	-42.5 <sup>a)</sup>	-34.5	-26.5	+3/-5
6300	-31.5	-38.5	-44.0 <sup>a)</sup>	-36.0	-27.5	+3/-5
8000	-32.0	-40.0	-45.5 <sup>a)</sup>	-37.5	-28.5	+3/-5

<sup>a)</sup> Shadow zone: tolerances not applicable.

TABLE 8/P.58

**Recommended microphone types for free-field  
sound emission characterization of HATS**

Measurement point	Microphone size	Microphone equalization
1, 2, 5, 6, 7, 8, 9, 10, 21	¼ inch	Pressure
3, 4	½ inch	Pressure
11, 12, 13, 14, 15, 16, 17, 22, 23, 24, 25, 26	1 inch	Free field
MRP	¼ inch	Pressure

### 5.2.2 Normalized obstacle diffraction

The normalized obstacle diffraction of HATS mouth is defined at three points on the reference axis, as specified in Table 9.

NOTE – If a compressor microphone is normally used in the HATS, it (or an equivalent dummy) shall be left in place while checking the normalized obstacle diffraction.

TABLE 9/P.58  
**Normalized obstacle diffraction**

Frequency (Hz)	Measurement point			Tolerance (dB)
	18 (12.5 mm) (dB)	19 (25 mm) (dB)	20 (50 mm) (dB)	
100	34.2	28.5	23.2	+3.0/-2.0
125	34.0	28.5	22.9	+3.0/-2.0
160	34.0	28.8	22.9	+3.0/-2.0
200	33.2	28.0	22.1	+3.0/-2.0
250	33.2	28.0	22.0	± 2.0
315	33.9	28.5	22.5	± 1.5
400	33.8	28.5	22.4	± 1.5
500	33.3	27.9	21.9	± 1.5
630	33.0	27.5	21.5	+3.0/-1.5
800	36.1	30.6	24.9	+3.0/-1.5
1000	35.3	29.9	24.3	+3.0/-1.5
1250	32.0	26.8	21.3	+3.0/-1.5
1600	30.9	26.0	21.1	+2.5/-1.5
2000	30.6	26.7	22.0	+2.5/-1.5
2500	31.0	27.8	24.7	+2.5/-1.5
3150	31.0	28.0	23.3	+2.5/-1.5
4000	31.6	28.8	24.3	(Note)
5000	33.2	28.4	23.9	(Note)
6300	33.7	27.5	24.0	(Note)
8000	32.0	24.5	19.5	(Note)

NOTE – Only indicative values – Tolerances not specified.

### 5.2.3 Maximum deliverable sound pressure level

The HATS mouth shall be able to deliver steadily the acoustical artificial voice at the sound pressure levels up to at least +6 dB (reference 1 Pa) at the MRP.

## 5.2.4 Distortion

### 5.2.4.1 Harmonic distortion

When delivering sine tones, with amplitudes up to 0 dBPa at the MRP, the harmonic distortion of the acoustic signal (delivered at the MRP) shall lie below the curve drawn with the straight lines between the breaking points in Table 10 on a logarithmic (frequency) – logarithmic (% distortion) scale.

TABLE 10/P.58

#### Maximum harmonic distortion of the HATS mouth

Frequency	2nd harmonic	3rd harmonic
125 Hz	10%	10%
300 Hz	1%	1%
8 kHz	1%	1%

In addition to the requirement of Table 10, when delivering sine tones with frequencies between 1004 Hz and 1025 Hz with a level up to 10 dBPa, the total harmonic distortion (2nd and 3rd harmonics) of the HATS Mouth measured at the MRP shall not exceed 1.5%.

### 5.2.4.2 Total distortion

When delivering noise signals according to Recommendation O.131 with levels up to +5 dBPa at the MRP, the total distortion of the HATS Mouth measured at the MRP shall not exceed 1.5%.

## 5.2.5 Linearity

Positive or negative level variations of 6 dB of the feeding electrical signal shall produce corresponding variations of 6 dB  $\pm$ 0.5 dB at the MRP for output pressures in the range from -14 dBPa to +6 dBPa. This requirement shall be met both for complex excitations, such as the artificial voice, and for sinusoidal excitations in the range from 100 Hz to 8 kHz.

NOTE – Better and less temperature dependent linearity performances can be achieved by controlling the electrical excitation current instead of the feeding voltage. For applications requiring better performances than here specified and extended dynamic ranges, it is recommended to individually calibrate the HATS Mouth used and to compensate the measured data by taking into account the calibration results. An effective alternative technique also consists in monitoring the generated acoustic pressure by means of a measurement microphone placed at the acoustic outlet of the HATS Mouth.

### 5.3 Composite characteristics

#### 5.3.1 Free-field plane wave diffraction at MRP

The free-field diffraction at MRP is given in Table 11.

TABLE 11/P.58  
Free-field diffraction at MRP

Frequency (Hz)	Diffraction			Tolerance (dB)
	0° (dB)	90° (dB)	180° (dB)	
100	1.0	-0.5	-1.0	±2.0
125	0.5	-0.5	-1.0	±2.0
160	1.5	-0.5	-1.0	±2.0
200	1.5	-0.5	-1.5	±2.0
250	3.0	0.0	-1.5	±2.0
315	4.0	0.0	-1.5	±1.5
400	4.5	0.0	-2.5	±1.5
500	4.0	0.5	-3.0	±1.5
630	3.0	0.5	-2.5	±1.5
800	-0.5	1.5	-2.0	±2.0
1000	-0.5	2.5	-2.5	±2.0
1250	3.5	2.5	-3.0	±1.5
1600	5.0	1.5	-4.0	±1.5
2000	1.0	1.5	-3.0	±1.5
2500	-5.0	-1.0	-5.0	±2.0
3150	-1.5	-1.0	-5.5	±2.0
4000	-0.5	0.5	-6.0	±2.0
5000	3.0	3.5	-8.5 <sup>a)</sup>	±2.0
6300	3.5	1.0	-11.0 <sup>a)</sup>	±2.0
8000	-4.5	-2.0	-12.0 <sup>a)</sup>	±2.0

<sup>a)</sup> Shadow zone: tolerances not applicable.

### 5.3.2 Diffuse-field diffraction at MRP

The diffuse-field diffraction at MRP is given in Table 12.

TABLE 12/P.58  
Diffuse-field diffraction at MRP

Frequency (Hz)	Diffraction (dB)	Tolerance (dB)
100	1.0	±2.0
125	1.0	±2.0
160	1.0	±2.0
200	0.0	±2.0
250	0.0	±2.0
315	0.5	±1.5
400	1.0	±1.5
500	1.0	±1.5
630	1.0	±1.5
800	1.0	±1.5
1000	1.0	±1.5
1250	1.0	±1.5
1600	1.0	±1.5
2000	0.5	±1.5
2500	-0.5	±1.5
3150	-1.5	±1.5
4000	-1.0	±2.0
5000	-1.0	±3.0
6300	-0.5	±3.0
8000	-0.5	±3.0

### 5.3.3 Mouth to ear crosstalk

#### 5.3.3.1 Closed ears

The MRP to ear-drum sound attenuation with closed ears shall be more than 40 dB in the third-octave bands between 100 Hz and 1 kHz and more than 50 dB in the third-octave bands between 1250 Hz and 8 kHz (see Note in 5.1.5).

### 5.3.3.2 Open ears

The MRP to ear-drum sound attenuation with open ears shall be as specified in Table 13.

TABLE 13/P.58

#### MRP to DRP transfer function (open ear)

Frequency (Hz)	Transfer function (dB)	Tolerance (dB)
100	-18.0	±2
125	-18.0	±2
160	-18.0	±2
200	-18.0	±2
250	-18.0	±2
315	-18.0	±1.5
400	-17.5	±1.5
500	-17.5	±1.5
630	-17.0	±1.5
800	-17.0	±1.5
1000	-17.0	±2
1250	-17.0	±2
1600	-15.5	±2
2000	-12.5	±2
2500	-9.0	±2
3150	-10.5	±2
4000	-15.5	±4/-2
5000	-20.5	±4/-2
6300	-32.5	±4/-2
8000	-31.5	±4/-2

## 6 Miscellaneous

### 6.1 Calibration of the Artificial Ears

The calibration at any frequency of Type 3.3 Artificial Ears installed on the HATS is defined as the pressure sensitivity of the respective occluded-ear simulators at that frequency.

#### NOTES

1 Performance testing and calibration of the occluded-ear simulator are specified in IEC Publication 711.

2 Manufacturers are encouraged to provide suitable means for calibrating the occluded-ear simulator without disassembling the HATS.



## 6.2 DRP-ERP transfer function

The sound pressure measured by the Type 3.3 Artificial Ear is referred to the ear-Drum Reference Point (DRP). The correction function given in Table 14A and 14B shall be used for converting data to the Ear Reference Point (ERP), when it is required to calculate loudness ratings or compare results with specifications based on measurements referred to ERP. Table 14A applies to third-octave measurements while Table 14B applies to twelfth-octave and sine measurements.

TABLE 14A/P.58

### **S<sub>DE</sub>: Third-octave measurements**

Frequency (Hz)	S <sub>DE</sub> (dB)
100	0.0
125	0.0
160	0.0
200	0.0
250	-0.3
315	-0.2
400	-0.5
500	-0.6
630	-0.7
800	-1.1
1000	-1.7
1250	-2.6
1600	-4.2
2000	-6.5
2500	-9.4
3150	-10.3
4000	-6.6
5000	-3.2
6300	-3.3
8000	-16.0
(10 000)	(-14.4)

S<sub>DE</sub> Transfer function DRP to ERP  
 $S_{DE} = 20 \log_{10} (P_E/P_D)$   
 where:  
 P<sub>E</sub> Sound pressure at the ERP  
 P<sub>D</sub> Sound pressure at the DRP

TABLE 14B/P.58

**S<sub>DE</sub>: Twelfth-octave measurements**

Frequency (Hz)	S <sub>DE</sub> (dB)	Frequency (Hz)	S <sub>DE</sub> (dB)	Frequency (Hz)	S <sub>DE</sub> (dB)	Frequency (Hz)	S <sub>DE</sub> (dB)
92	0.1	290	-0.3	917	-1.3	2901	-11.0
97	0.0	307	-0.2	972	-1.4	3073	-10.5
103	0.0	325	-0.2	1029	-1.8	3255	-10.2
109	0.0	345	-0.2	1090	-2.0	3447	-9.1
115	0.0	365	-0.4	1155	-2.3	3652	-8.0
122	0.0	387	-0.5	1223	-2.4	3868	-6.9
130	0.0	410	-0.4	1296	-2.6	4097	-5.8
137	0.0	434	-0.6	1372	-3.1	4340	-5.0
145	0.0	460	-0.3	1454	-3.3	4597	-4.2
154	0.0	487	-0.7	1540	-3.9	4870	-3.3
163	0.0	516	-0.6	1631	-4.4	5158	-2.7
173	-0.1	546	-0.6	1728	-4.8	5464	-2.4
183	-0.1	579	-0.6	1830	-5.3	5788	-2.4
193	0.0	613	-0.6	1939	-6.0	6131	-2.5
205	0.1	649	-0.8	2053	-6.9	6494	-3.3
218	0.0	688	-0.8	2175	-7.5	6879	-4.5
230	-0.1	729	-1.0	2304	-8.1	7286	-5.9
244	-0.2	772	-1.1	2441	-9.1	7718	-9.0
259	-0.3	818	-1.1	2585	-9.5	8175	-14.2
274	-0.3	866	-1.2	2738	-10.4	8659	-20.7

**6.3 Stray magnetic field**

Neither the d.c. nor the a.c. magnetic stray fields generated by the HATS mouth shall influence the signal transduced by microphones, receivers or other electroacoustic devices (e.g. hearing aids) under test.

It is recommended that the a.c. stray field produced at the MRP shall lie below the curve formed by the following coordinates:

Frequency (Hz)	Magnetic output at MRP (dB A/m/Pa)
200	-10
1000	-40
10 000	-40

It is also recommended that the d.c. stray field at the MRP and at the earcap position be lower than 400 A/m

NOTE – The recommended d.c. stray-field limit of 400 A/m at the MRP applies specifically to mouths intended for measuring electromagnetic microphones. For measuring other kinds of microphones (e.g. electret), a higher limit of 1200 A/m at the MRP is acceptable.

#### **6.4 Atmospheric reference conditions**

The range of the ambient conditions where HATS characteristics shall comply with this Recommendation is:

Static pressure:  $101.3 \pm 3.0$  kPa

Temperature:  $23 \pm 3$  ° C

Relative humidity:  $60 \pm 20\%$

#### **6.5 Markings and calibration fixtures**

To facilitate azimuth alignment, the torso shall be equipped with markings indicating the direction of 0° azimuth.

If the head is not solidly connected to the torso, both must be provided with markings to ensure correct alignment.

To assist reproducible placement of transducers on and around the pinna, the head surfaces in the immediate vicinity of the pinnae may be equipped with coordinate axis markings. The coordinate axes should be parallel to the axis of rotation (Y-axis) and the HATS reference plane (X-axis) respectively, and could have the centre of the ear canal at the concha as their origin. Values on the X-axis shall be positive towards the front of the HATS, on the Y-axis positive towards the vertex.

The HATS shall be provided by the manufacturer with the mechanical fixtures required to place a ¼ inch calibration microphone at the MRP.

NOTE – Manufacturers are encouraged to provide means for easily checking the correct vertical positioning of HATS.

#### **6.6 Delivery conditions**

Each HATS shall be delivered with a calibration documentation specifying the acoustical characteristics as defined in this Recommendation.

NOTE – Manufacturers are encouraged to provide supplementary information about the acoustical characteristics of HATS (e.g. 1/12th octave frequency characteristics), for better supporting the research applications of HATS.

#### **6.7 Materials**

The HATS shall have a non-porous surface, with an acoustic impedance which is large compared to that of air, and be of a material which ensures dimensional stability.

#### **6.8 Stability**

The HATS shall be stable and reproducible. The stability of HATS shall be periodically controlled by recalibration.

## 7 References

- [1] IEC Report 959-4, 1990.
- [2] ISO 4869-1: 1990, *Acoustics – Hearing protectors – Part 1: Subjective method for the measurement of sound attenuation.*

## ITU-T RECOMMENDATIONS SERIES

- Series A Organization of the work of the ITU-T
- Series B Means of expression
- Series C General telecommunication statistics
- Series D General tariff principles
- Series E Telephone network and ISDN
- Series F Non-telephone telecommunication services
- Series G Transmission systems and media
- Series H Transmission of non-telephone signals
- Series I Integrated services digital network
- Series J Transmission of sound-programme and television signals
- Series K Protection against interference
- Series L Construction, installation and protection of cables and other elements of outside plant
- Series M Maintenance: international transmission systems, telephone circuits, telegraphy, facsimile and leased circuits
- Series N Maintenance: international sound-programme and television transmission circuits
- Series O Specifications of measuring equipment
- Series P Telephone transmission quality**
- Series Q Switching and signalling
- Series R Telegraph transmission
- Series S Telegraph services terminal equipment
- Series T Terminal equipment and protocols for telematic services
- Series U Telegraph switching
- Series V Data communication over the telephone network
- Series X Data networks and open system communication
- Series Z Programming languages