



INTERNATIONAL TELECOMMUNICATION UNION

ITU-T

TELECOMMUNICATION
STANDARDIZATION SECTOR
OF ITU

M.3208.1

(10/97)

SERIES M: TMN AND NETWORK MAINTENANCE:
INTERNATIONAL TRANSMISSION SYSTEMS,
TELEPHONE CIRCUITS, TELEGRAPHY, FACSIMILE
AND LEASED CIRCUITS

Telecommunications management network

**TMN management services for dedicated and
reconfigurable circuits network: Leased circuit
services**

ITU-T Recommendation M.3208.1

(Previously CCITT Recommendation)

ITU-T M-SERIES RECOMMENDATIONS

**TMN AND NETWORK MAINTENANCE: INTERNATIONAL TRANSMISSION SYSTEMS, TELEPHONE
CIRCUITS, TELEGRAPHY, FACSIMILE AND LEASED CIRCUITS**

Introduction and general principles of maintenance and maintenance organization	M.10–M.299
International transmission systems	M.300–M.559
International telephone circuits	M.560–M.759
Common channel signalling systems	M.760–M.799
International telegraph systems and phototelegraph transmission	M.800–M.899
International leased group and supergroup links	M.900–M.999
International leased circuits	M.1000–M.1099
Mobile telecommunication systems and services	M.1100–M.1199
International public telephone network	M.1200–M.1299
International data transmission systems	M.1300–M.1399
Designations and information exchange	M.1400–M.1999
International transport network	M.2000–M.2999
Telecommunications management network	M.3000–M.3599
Integrated services digital networks	M.3600–M.3999
Common channel signalling systems	M.4000–M.4999

For further details, please refer to ITU-T List of Recommendations.

ITU-T RECOMMENDATION M.3208.1

TMN MANAGEMENT SERVICES FOR DEDICATED AND RECONFIGURABLE CIRCUITS NETWORK: LEASED CIRCUIT SERVICES

Summary

This Recommendation is one of the M.3200-Series TMN management service Recommendations that provide descriptions of management services, goals and context for the Dedicated and Reconfigurable Circuits Network.

Source

ITU-T Recommendation M.3208.1 was prepared by ITU-T Study Group 4 (1997-2000) and was approved under the WTSC Resolution No. 1 procedure on the 24th of October 1997.

Keywords

Dedicated and Reconfigurable Circuits Network, Leased Circuits, Leased Circuit Services, Telecommunications Management Networks (TMN), TMN Management Service.

FOREWORD

ITU (International Telecommunication Union) is the United Nations Specialized Agency in the field of telecommunications. The ITU Telecommunication Standardization Sector (ITU-T) is a permanent organ of the ITU. The ITU-T is responsible for studying technical, operating and tariff questions and issuing Recommendations on them with a view to standardizing telecommunications on a worldwide basis.

The World Telecommunication Standardization Conference (WTSC), which meets every four years, establishes the topics for study by the ITU-T Study Groups which, in their turn, produce Recommendations on these topics.

The approval of Recommendations by the Members of the ITU-T is covered by the procedure laid down in WTSC Resolution No. 1.

In some areas of information technology which fall within ITU-T's purview, the necessary standards are prepared on a collaborative basis with ISO and IEC.

NOTE

In this Recommendation, the expression "Administration" is used for conciseness to indicate both a telecommunication administration and a recognized operating agency.

INTELLECTUAL PROPERTY RIGHTS

The ITU draws attention to the possibility that the practice or implementation of this Recommendation may involve the use of a claimed Intellectual Property Right. The ITU takes no position concerning the evidence, validity or applicability of claimed Intellectual Property Rights, whether asserted by ITU members or others outside of the Recommendation development process.

As of the date of approval of this Recommendation, the ITU had not received notice of intellectual property, protected by patents, which may be required to implement this Recommendation. However, implementors are cautioned that this may not represent the latest information and are therefore strongly urged to consult the TSB patent database.

© ITU 1998

All rights reserved. No part of this publication may be reproduced or utilized in any form or by any means, electronic or mechanical, including photocopying and microfilm, without permission in writing from the ITU.

CONTENTS

	Page
1 Introduction	1
1.1 Scope	1
1.2 Related Recommendations	2
1.3 Abbreviations	2
1.4 Definitions	3
1.4.1 Service related definitions.....	3
1.4.2 Role related definitions	4
1.4.3 Transport network resource definitions	4
1.4.4 Conventions used in this Recommendation	5
2 Leased Circuit Service security.....	5
3 Customer administration management service.....	6
3.1 Management service description	6
3.2 Management goals.....	7
3.3 Management context description.....	7
3.3.1 Roles.....	7
3.3.2 Telecommunications services and resources.....	8
3.3.3 Management functions	9
3.4 Management scenarios	54
3.4.1 Scenarios for dedicated leased circuit service configuration	54
3.4.2 Scenarios for leased circuit service status administration.....	58
3.4.3 Scenarios for link connection configuration	61
3.4.4 Scenarios for link connection status administration.....	64
3.4.5 Scenarios for service access domain configuration.....	67
3.4.6 Scenarios for access equipment status administration	69
3.5 Architecture	70
3.5.1 Functional architecture.....	70
3.5.2 Physical Architecture	70
4 Maintenance Management Service.....	70
4.1 Management service description	70
4.2 Management goals.....	71
4.3 Management context description.....	71
4.3.1 Roles.....	71
4.3.2 Telecommunications services and resources.....	71
4.3.3 Management functions	71

	Page
4.4 Management scenarios	72
4.5 Architecture	72
Appendix I – Example enterprise viewpoint specification of Leased Circuit Service	
Management	72
I.1 Enterprise viewpoint specification	72
I.2 Dedicated Leased Circuit Service Configuration Community (dLCSc)	73
I.2.1 Purpose	73
I.2.2 Enterprise roles	73
I.2.3 Community Policy	73
I.2.4 Enterprise actions	74
I.2.5 Activities	76
I.2.6 Contract	77
Appendix II – Management scenario examples	
II.1 Other scenarios for dedicated leased circuit service configuration	77
II.1.1 Other scenarios for dedicated leased circuit service creation	77
II.1.2 Other scenarios for dedicated leased circuit service creation with specifying alias name	79
II.1.3 Other scenarios for dedicated leased circuit service creation with specifying the route	79
II.1.4 Other scenarios for dedicated leased circuit service creation with specifying service characteristics	81
II.1.5 Other scenarios for dedicated leased circuit service creation with specifying diverse routing	82
II.1.6 Other scenarios for multiple dedicated leased circuits service creation	82
II.1.7 Other scenarios for dedicated leased circuit service deletion with specifying service termination date	83
II.1.8 Other scenarios for dedicated leased circuit service request cancellation	84
II.1.9 Other scenarios for dedicated leased circuit service request negotiation	85
II.2 Other scenarios for link connection configuration	86
II.2.1 Other scenarios for link connection request cancellation	86
Appendix III – Topological configuration examples	
III.1 Introduction	87
III.2 Simple circuit through one network	87
III.3 Single network with path specification	88

Recommendation M.3208.1

TMN MANAGEMENT SERVICES FOR DEDICATED AND RECONFIGURABLE CIRCUITS NETWORK: LEASED CIRCUIT SERVICES

(Geneva, 1997)

1 Introduction

This management service is related to the two phases of the service life cycle of a leased circuit service:

pre-service

This phase starts when the Service Customer (SC) requests the creation of a service and lasts until the completion of the requests is reported to the SC.

When the required facilities are present, the completion may be immediate and no interaction takes place between the SC and service provider between the request and the response.

When completion is not immediate, the provisioning phase ends with the Report create completion function from the service provider. During the provisioning phase the SC may:

- a) modify service request parameters;
- b) retrieve service request parameters;
- c) query the status of the service request;
- d) cancel the service request.

During the provisioning phase, the service provider may report configuration change.

in-service

The in-service (operation) phase follows the provisioning phase and lasts until the service is deleted either by the SC or the Service Provider (SP).

1.1 Scope

This Recommendation describes a subset of TMN management services for Dedicated and Reconfigurable Leased Circuits network identified in the Recommendation M.3200 as a TMN managed area. Its main focus is on the management services of Customers Administration and Maintenance management for the point-to-point Leased Circuit Services (LCSs) that may be offered by one or more service providers and may be controlled by the SC with different levels of visibility. The LCS is defined between a single SC and a single SP. These management services are also applicable for interactions between management systems of different service providers or within a service provider.

TMN management services in this Recommendation specify interface requirements for Leased Circuit Services between an Operations System (OS) and an Operations System (OS) to provision and manage Leased Circuit Services. The interfaces addressed by the TMN management services in this Recommendation are applicable to both X Interfaces across jurisdictional boundaries and Q3 within a TMN. Support for the services described in this Recommendation is at the discretion of the Service Provider.

The TMN management services in this Recommendation are described using GDMS template contained in the Recommendation M.3020.

In general, the definition of a service should be independent of the particular network used to transport the service. This allows multiple technologies to support the service. Therefore, network level information should not be presented to the service layer. However, specific service features may be defined which allow network or network element information to be presented to a service customer. In this case, an abstraction of the information appropriate to the service feature is transferred.

The requirements for International LCS are not included in this Recommendation.

Clause 2 provides the requirements for security of the Leased Circuit Service (LCS).

Clause 3 provides the requirements for customer administration of the LCS. This includes configuration and status administration of Dedicated LCS and Reconfigurable LCS.

Clause 4 addresses the maintenance management requirements for LCS.

Appendix I provides enterprise viewpoint per Recommendation G.851 for the Leased Circuit Service.

Appendix II provides management scenario examples.

Appendix III shows some topological examples of LCS.

1.2 Related Recommendations

The following Recommendations should be referred to in connection with this Recommendation:

- ITU-T Recommendation G.805 (1995), *Generic functional architecture of transport networks*.
- ITU-T Recommendation M.3010 (1996), *Principles for a telecommunications management network*.
- ITU-T Recommendation M.3020 (1995), *TMN interface specification methodology*.
- ITU-T Recommendation M.3200 (1997), *TMN management services and telecommunications managed areas: Overview*.
- ITU-T Recommendation M.3320 (1997), *Management requirements framework for the TMN X-interface*.
- ITU-T Recommendation M.3400 (1997), *TMN management functions*.
- ITU-T Recommendation Q.821 (1993), *Stage 2 and stage 3 description for the Q3 interface – Alarm surveillance*.
- ITU-T Recommendation X.790 (1995), *Trouble management function for ITU-T applications*.

1.3 Abbreviations

This Recommendation uses the following abbreviations.

AP	Access Point
ATM	Asynchronous Transfer Mode
CP	Connection Point
CPE	Customer Premises Equipment
GDMS	Guidelines for the Definition of TMN Management Services

LC	Link Connection
LCS	Leased Circuit Service
MS	Management Services
NML	Network level Management Layer
PDH	Plesiochronous Digital Hierarchy
SAD	Service Access Domain
SAG	Service Access Group
SC	Service Customer
SDH	Synchronous Digital Hierarchy
SML	Service level Management Layer
SN	Service Node
SNC	Sub-Network Connection
SP	Service Provider
TCP	Termination Connection Point
TMN	Telecommunications Management Network

1.4 Definitions

1.4.1 Service related definitions

This Recommendation defines the following terms:

1.4.1.1 contract: A contract is a formalized business agreement between a customer and a provider. A contract may be either internal, that is, between a SC and service user, or external, i.e. between a service provider and a SC. An internal contract is not subject to standardization.

1.4.1.2 leased circuit service: The Leased Circuit Service is a telecommunications service that provides for the transmission of information between two or more service access points in a layer network. A service access point can either be at a customer premise or within the network. This Recommendation is limited to Leased Circuit Services with two access points. These types of Leased Circuit Services are termed point-to-point leased circuit services. The transmission resources used to provide the service must meet the parameters and conditions specified in the contract. The underlying technology that supports the transmission path may use one or more technologies (e.g. SDH, PDH, ATM, Frame Relay) as long as the contract for the service is met.

The Leased Circuit Service may be specialized. See Dedicated Leased Circuit Service and reconfigurable Leased Circuit Service.

NOTE – This Recommendation is limited to leased circuit services with two access points. These types of leased circuit services are generally termed point-to-point leased circuit services. The terms "Originating Location" and "Terminating Location" refer to the A and Z access points for the LCS. For bi-directional LCSs, the terms "Originating" and "Terminating" have no semantic meaning.

1.4.1.3 dedicated leased circuit service: The dedicated leased circuit service is a point-to-point connection between two service access points which cannot be changed after creation of the service . The Dedicated LCS uses the Service Name and Service Class to define the value for service specific parameters and to designate which parameters may be changed by the SC following provisioning of the service.

1.4.1.4 reconfigurable leased circuit service: The reconfigurable leased circuit service is leased circuit service where the connectivity among a set of predefined access points can be changed by management operations. The individual leased circuits established by this service will be instances of the dedicated leased circuit service.

1.4.1.5 service access domain: A collection of service access groups that form a domain for the reconfigurable leased line service. Any service access point can be connected to any other service access point in that domain.

1.4.1.6 service access group: For LCS a service access group represents one or more Service Access Points in the same layer network connected to the same SP sub-network and in the same location.

1.4.1.7 service access point: The end-point of a LCS.

1.4.2 Role related definitions

This Recommendation makes use of the following terms defined in Recommendation M.3320:

1.4.2.1 customer: Service Customer; See definition of "Customer" in Recommendation M.3320. This use of customer specializes the definition to the context of the TMN Management role for the Service Level.

1.4.2.2 service provider: A general reference to an entity who provides telecommunications services to Customers and other users either on a tariff or contract basis. A SP may or may not operate a network. A SP may or may not be a Customer of another SP. In this Recommendation, the phrase "SP's (sub)network" is used to reference the network(s) used by the SP to provide the LCS.

1.4.2.3 network operator: An organization that operates a telecommunications network. A Network Operator may be a SP and vice versa. A network Operator may or may not provide particular telecommunications services.

1.4.2.4 diversity: Two or more circuits (bundles) with the same originating and terminating locations are diverse if a limitation is imposed on the resources they may share in order to prevent single failures (of some specified types) from causing those circuits (bundles) to fail.

1.4.2.5 service characteristic: The service characteristic represents the service parameter assigned to a leased circuit service [transfer rate and format (characteristic information), quality of service, type of service, cost, etc.].

1.4.3 Transport network resource definitions

This Recommendation makes use of and/or specializes the following terms defined in the Transport Network Architecture, Recommendation G.805:

1.4.3.1 layer network: For LCS, a layer network represents the capability to manage a collection of LCSs of the same service characteristics.

1.4.3.2 sub-network: For LCS, a sub-network represents the SP topological component that provides routing of LCS of the same service characteristics. Sub-network may be partitioned into smaller sub-networks that represent regions (for routing purposes) of the SP.

1.4.3.3 link: For LCS, a link represents a transport capacity within a layer network, between an access group and a SP's sub-network, between two SP's sub-networks, or between two sub-networks belonging to the same SPs.

1.4.3.4 access group: For LCS, an access group represents one or more access points of the same service characteristic in the same location.

1.4.3.5 access point: For LCS an access point represents an end-point of the LCS. Each LCS is bound by two access points. Note that access point may not be available to the SP.

1.4.3.6 trail: For LCS a trail represents a circuit. A LCS is bound by two TCPs and is within the same SP's sub-network or layer network.

1.4.3.7 connection point: For LCS, a connection point represents a point where the segment of the circuit that crosses a sub-network is terminated.

1.4.3.8 termination connection point: For LCS, a termination connection point represents a point where a segment of the LCS is bound to a port on a link connecting SPs sub-networks, or bound to a SP's sub-network.

1.4.3.9 link connection: For LCS, a link connection enables the transfer of information of a LCS across a link.

1.4.3.10 sub-network connection: For LCS, a sub-network connection enables the transfer of information of a LCS across a service provider's sub-network.

1.4.3.11 network connection: For LCS, a network connection enables the transfer of information of a LC across a service provider's sub-network links or multiple SPs' sub-network links.

1.4.3.12 service node: A service node is defined by a set of co-located service access points and service access groups and is visible at the boundary of a layer sub-network.

1.4.4 Conventions used in this Recommendation

Legend for the Tables

m Mandatory

m(=) The SP must provide the same value in the response as provided in the request by the SC.

o Optional, Optionality is subject to definition according to the Service Level Agreement or Contract between the SC and SP, i.e. a parameter listed as optional may be made mandatory by the Contract.

o(=) Return of the value by the SP is optional; however, if the SP elects to return the value, it must be the same value supplied by the SC in the request. SP is not allowed to alter this field.

c Conditional Parameter, Definition of the Condition will be specified in the notes column. A numeric suffix is used to enable reuse of the conditional statements.

c(=) If the value is provided in the request by the SC, the SP must provide the same value in the response.

Blank A blank implies that the parameter is not applicable.

2 Leased Circuit Service security

The security service is defined between a single SC and SP. Several security services are needed to assure the proper functioning of LCS management:

- a) Peer entity authentication and data origin authentication are needed to prevent attacks and uniquely identify the SC.
- b) Integrity is needed to prevent unauthorized modification of data in transit.
- c) Access control is needed to assure that one Service Customer does not gain access, maliciously or accidentally, to other customers' data. The SP may use the authenticated identity of the SC to provide access control.

- d) Confidentiality may be needed if private information is being exchanged. This security service may not be needed for all LCS management messages.
- e) Non-repudiation of origin may be needed, e.g. when a SC requests a service that may cause the service provider to invest labor and/or materials. This security service may not be needed for all LCS management messages.
- f) Non-repudiation of delivery may be needed, e.g. when a SC reports a problem. This security service may not be needed for all LCS management messages.

In addition, security management functions, as per Recommendation M.3400, are needed to manage the security-related information needed to support the security services described above. The exact nature of the security management functions depends on the selection of security mechanisms used to provide the security services. Security management is outside the scope of this Recommendation.

3 Customer administration management service

3.1 Management service description

This management service addresses the management interface between the SP domain and the SC domain. It is based on an abstract view of the resources underlying a particular service, a view that shields the service user from knowledge of the specific technical implementation that supports the service.

Management capability described by this management service enables customers to configure and to reconfigure their Leased Circuit services.

Possible interactions between TMN management roles are given in Figures 1 and 2.

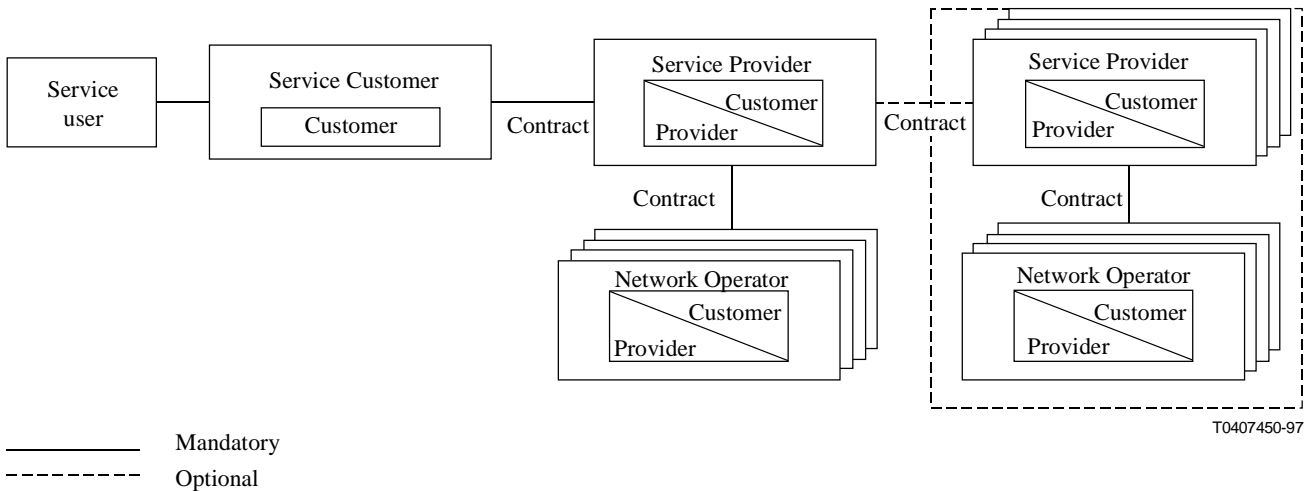

A Service Provider may have one or more contracts to other Service Provider and Network Operator.

Figure 1/M.3208.1 – The relationship among TMN management roles

3.2 Management goals

The goal of this management service is to provide the SC with the capability to request, modify, or delete a Leased Circuit Service. In addition, the SP is given a mechanism to keep the SC informed on the status of his/her request.

3.3 Management context description

3.3.1 Roles

Service Customer

The service customer is the client of the LCS. A SC can initiate one or many service requests. Some actions that a SC can perform are: placing orders, using services, query service status and paying the bills. The SC uses the X interface across the jurisdictional boundary of a TMN to manage telecommunications services. The SC is acting in the role of a customer when requesting services provided by a SP according to a contract with that SP.

Service Provider

The SP provides telecommunications services (such as LCS), or components thereof to the SC. A SP is able to act as a customer of other SPs or network operators in the delivery of the service to the SC. Figure 1 illustrates the interfaces between SPs, network operators and SCs. Figure 1 shows there is always one SP role in charge of overall service integration for SC. As pointed out in Figure 1, the SP further acts in the role of a customer or provider. In the customer role, the SP requests services from another SP or network operator. In the provider role, the SP provides the service to the SC. This is further illustrated in the examples in Figure 2.

Network Operator

The network operator provides network resources to SPs according to contracts with the requesting SP. The TMN Management role of network operator and SP may be combined in one business unit. However, for the purpose of this Recommendation, only the SP role is visible to the SC.

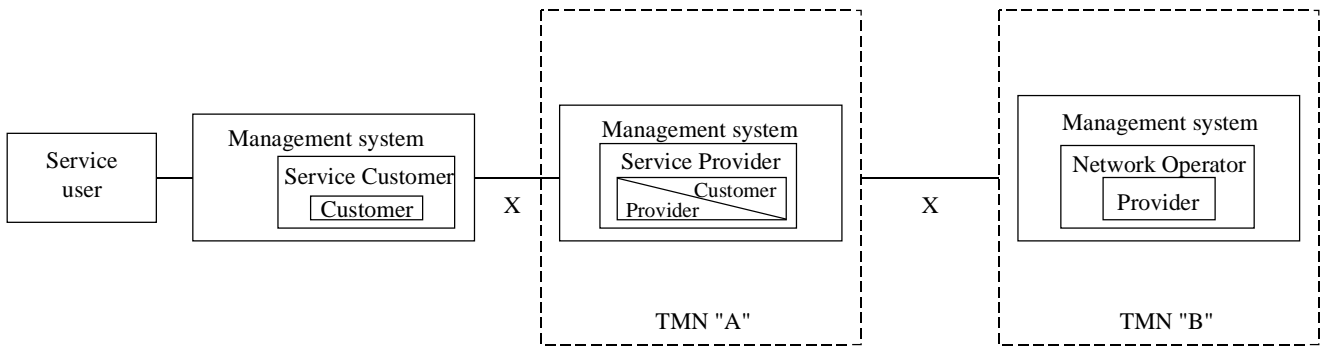

Example 1: Service Provider and Network Operator roles reside on OSs in different TMNs

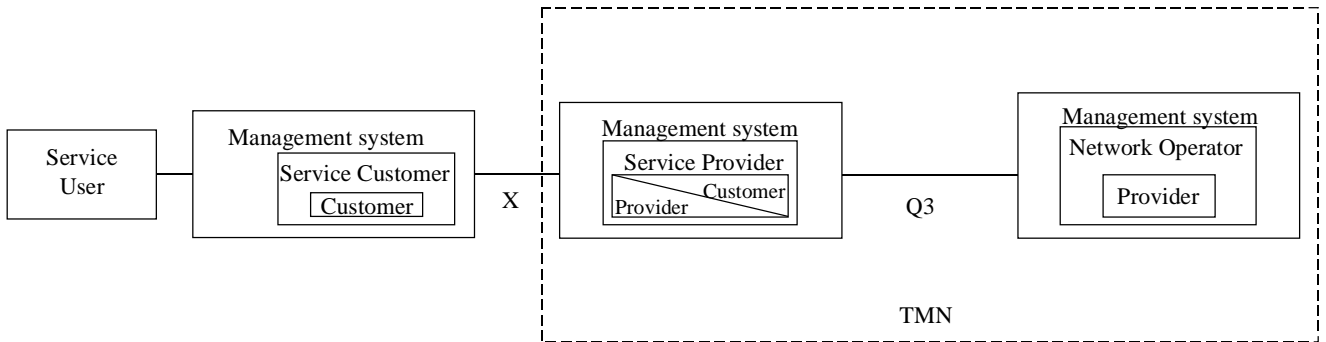

Example 2: Service Provider and Network Operator roles reside on OSs in the same TMN

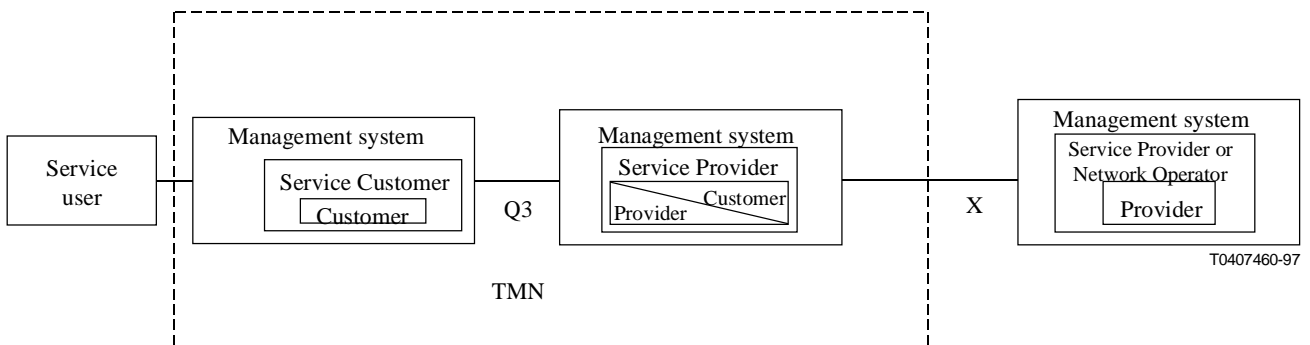

Example 3: Service Customer and Service Provider roles reside on OSs in the same TMN, and request of a leased line service from another Service Provider or Network Operator

Figure 2/M.3208.1 – Examples of the realization of TMN management roles

3.3.2 Telecommunications services and resources

The LCS Management service is concerned with the management of leased circuits as well as the service view of telecommunications resources. Figure 3 illustrates an example of the telecommunications resources.

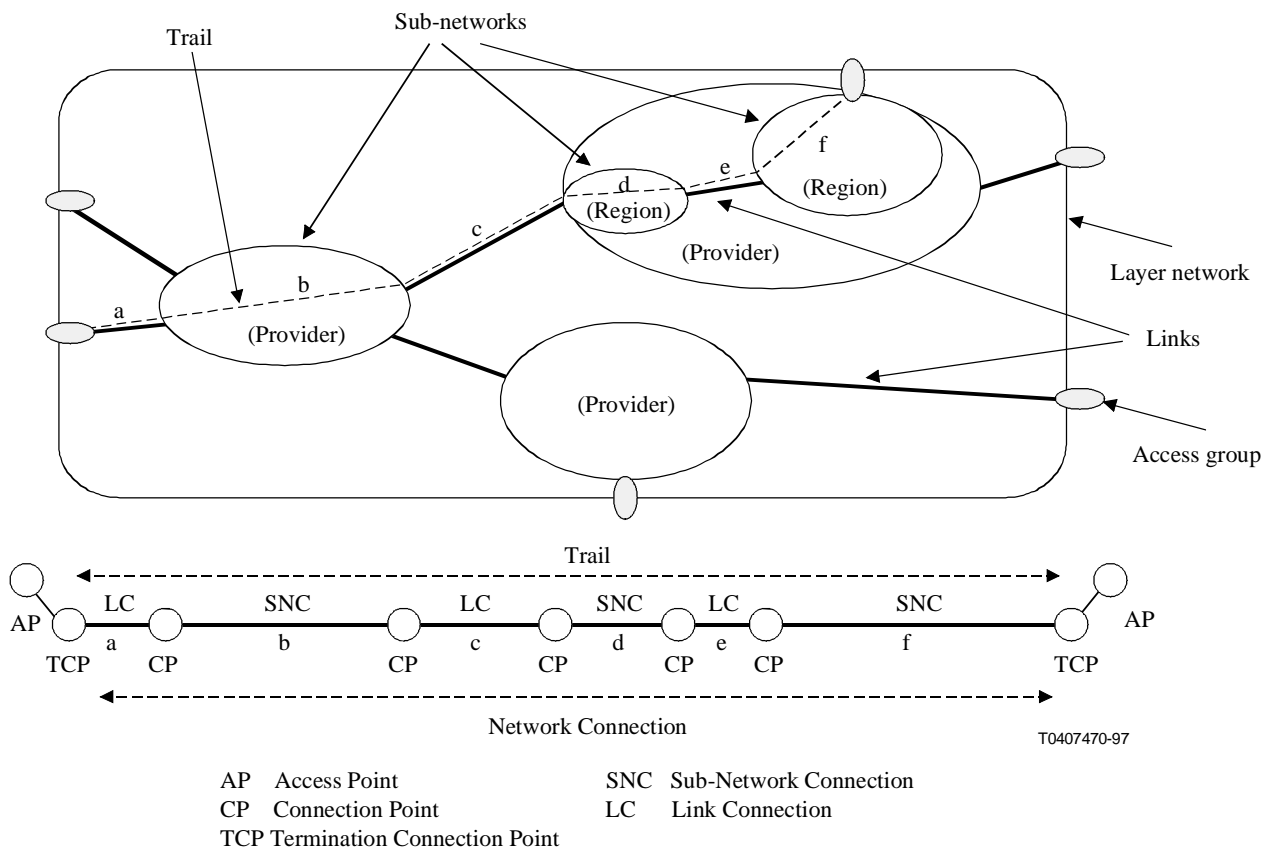

Figure 3/M.3208.1 – Leased Circuit-Topology view of telecommunications resources

3.3.3 Management functions

This subclause provides the configuration function set and Administrative function set for Dedicated and Reconfigurable LCS. In addition it provides the management functions for Link Connection, Service Access Group, and Access Equipment which are required to support the Dedicated and Reconfigurable LCS.

3.3.3.1 Dedicated leased circuit service configuration function set

The SC must be able to request the creation and deletion of a Dedicated LCS, as well as the modification of the dedicated leased circuits, and be notified of the completion of the creation, deletion, or modification request. The functions in this set are:

- 1) Create dedicated leased circuit service.
- 2) Delete dedicated leased circuit service.
- 3) Modify dedicated leased circuit service.
- 4) Cancel dedicated leased circuit service request.

3.3.3.1.1 Create dedicated leased circuit service function

3.3.3.1.1.1 Summary

This function allows the SC to request the creation of one or more Dedicated Leased Circuit Services. The SC shall identify the service to be provisioned, and service features (as specified in the Information Flow), the service availability date requested, the customer contact within the organization, and relevant information about the originating and terminating locations of the service (see Information Flow). The SC may also specify the route of the requested service and a user

identifier for the requested leased circuit. The SP may reject the request if the user identifier is ambiguous in some context.

For service creation, the SP makes available to the SC one of the following options:

- 1) The SC specifies the endpoints and the SP does not provide any information related to the route of the circuit.
- 2) The SC specifies the endpoints and some information on the route the circuit should take.
- 3) The SC specifies the endpoints but does not specify the route. The SP provides the SC with some view of the route.

This function includes the following interactions between the SC and the SP. Not all interactions will be applicable in all cases.

SC uses the Create Dedicated Leased Circuit function to request the creation of a LCS from SP.

The response from the SP may be either:

- a) An acknowledgment with a Provider Request Number indicating the receipt of the create function request. The completion of processing of the service request will be reported to the SC at a later time, following processing of the create function request using the Report Creation function.
- b) Completion response indicating that the create function request has been processed coincident with receipt of the request and that all information defined in the SP column of the Table for the Information Flows contained in 3.3.3.1.1.2 has been filled in and is available.
- c) The Create request has been rejected with a reason code indicating probable cause.

If b) or c), then this function is completed. If a), then the following interactions are possible (see Figure 4):

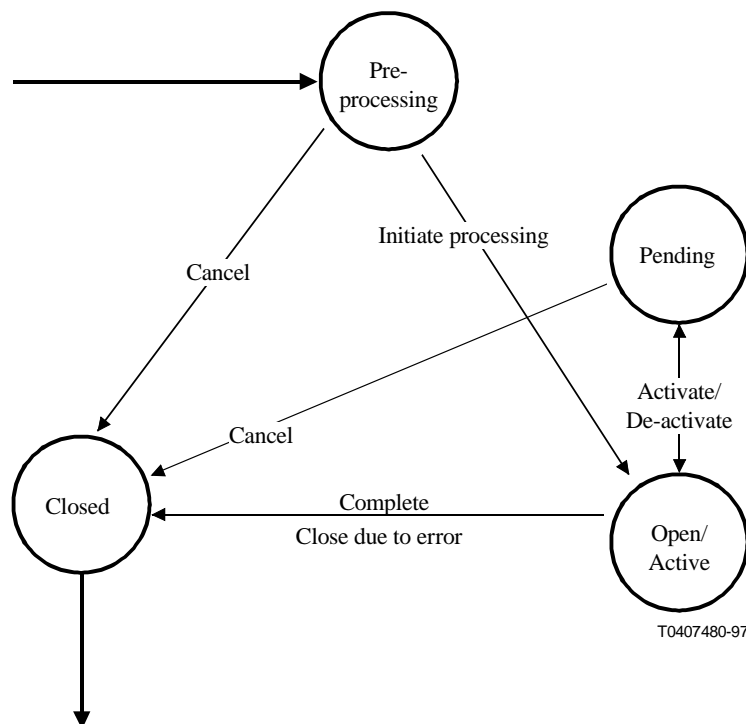

Figure 4/M.3208.1 – Request state model

Table 1/M3208.1 – State transition table for service request state

Event	Current state				
	Wait state	Pre-processing	Open/Active	Pending	Closed
service request	pre-processing				
initiate processing		If (parameters accepted) then ⇒ open active If (parameters negotiated) then ⇒ pending Else (emit error event) ⇒ closed			
deactivate			wait for additional information ⇒ pending		
complete			service request completed ⇒ closed		
error			emit error event ⇒ closed	emit error event ⇒ closed	
activation trigger				⇒ open/active	
cancel	closed	closed		closed	

- i) SP responds to the SC with information regarding the progress of the request using the Report Progress of the service request function of the Service Administrative Function Set.
- ii) the SC may inquire about the progress of the request using the Monitor progress of the service request function of the Service Administrative function set.
- iii) SP informs the SC upon the successful completion of the Create request using the Report creation of LCS to service customer function of the Service Administrative function set.
- iv) SP informs the SC upon a failure in the processing of the Create request, using the Report Progress of service request function of the Service Administrative function with a reason code indicating probable cause of the failure.

Item iii) or iv) signals completion of the function. The valid interactions are determined by the state model shown in Figure 4. Table 1 depicts the request state transition and the valid operations within each state.

3.3.3.1.1.2 Information Flow

Service Customer Request and SP Response	Service Customer	Service Provider	Notes
Service Name	m	o	The type of leased circuit service offered by the SP. Service names are not subject to standardization and are defined by the contract between the SC and the SP.
Service Class	o	c	<p>The name of a profile of service characteristics (associated with the service name) defined and supported by the SP. Examples of the service characteristics that may be included in the profile are directionality, channelization, signalling options, protection, quality of service objectives, application, etc. Service Class names are not subject to standardization and are defined by the Contract.</p> <p>c – If the requested service class is not equal to the class of service provided by the SP, then the SP must supply the value, else it is optional.</p>
Bandwidth	o	c	<p>Requested bandwidth, actual bandwidth returned.</p> <p>c – If the requested bandwidth cannot be provided by the SP, the SP shall return the value together with a reason code indicating that the bandwidth is not available. If the response is not indicating a completion, the SP, may report an error condition with a reason code indicating that the available service differs from the customer's initial service request.</p>
Quantity	o	c	The number of Leased Circuit Services to be generated by the SP. Following the processing of the LCS function, the SP shall return unique circuit numbers for each LCS generated by the processing of this command by the SP.
Service Termination Date	o	c	<p>The date at which the LCS will be made Inactive.</p> <p>c – If the SC provides a return date and the SP does not return a date, the requested date is accepted. In case the SP cannot accept the date, an alternate date is provided.</p>

Service Customer Request and SP Response	Service Customer	Service Provider	Notes
Schedule	o	c	<p>Describes the requested and offered (actual) schedule for the availability of the LCS following the Service Availability Date.</p> <p>Schedule will contain all relevant information such as list of activation times, dates and durations.</p> <p>NOTE – The schedule mechanism is described in Recommendations X.734 and X.735.</p> <p>If the SC does not specify a schedule, the value will default to the value specified in the Contract.</p> <p>If the SC specifies a value and the SP is not able to accommodate the requested schedule, the SP must return a error with a reason code indicating that the schedule cannot be met.</p>
Service Availability Date	o	m	<p>Date the service is due to be provisioned and placed in the requested Service Administrative State.</p>
Service Request State		c	<p>c – This parameter is present only when the response does not include the value for the circuit number(s) or an error. The presence of this parameter indicates that the request is in progress and requested LCS(s) have not been established.</p> <p>Valid Values are:</p> <p>pre-processing – Indicates that the service request is currently being checked for validity of request parameters.</p> <p>open/Active – Indicates that the service request is open and is being actively processed.</p> <p>Pending – Indicating that the LCS service request is deactivated for reasons such as waiting for additional information, completion of other supporting tasks. Activation from this pending state is required before processing can be continued.</p> <p>Closed – Indicates the service request is closed either as a result of successful completion or error or because the request was cancelled.</p> <p>See Figure 4 for allowed state transitions.</p>

Service Customer Request and SP Response	Service Customer	Service Provider	Notes
Service Administrative State	o	o(=)	<p>The SC may specify the service administrative state when the service is created. Valid values are:</p> <p>Unlocked – Indicating that the LCS is available for use (provides service) by the SC.</p> <p>Locked – Indicating that the LCS is currently not providing service. The SC may use this value for pre-provisioning LCS(s).</p> <p>See Figure 5 for an explanation of the Service Administrative State Model.</p>
Service Operational State		o	<p>The Operational State indicates if the service is working or not. The allowed values are enabled and disabled. This parameter is not controlled by the SC.</p>
Diversity	o	c	<p>Diversity may be specified with respect to existing leased circuit(s) by identification of leased circuit(s) from which this (these) new leased circuit(s) shall be diverse, or by identification of the set of topological entities from which this (these) new leased circuit(s) shall be diverse.</p> <p>When more than one leased circuit is requested, diversity may be specified within the request. In this case, the SC specifies the number of diverse groups and the number of circuits within each group, and/or a set of topological entities.</p> <p>c – The SP shall indicate the result of the request as either failure, success or partial success. In the case of partial success, the SP may indicate the common (i.e. non-diverse) components of the circuits (new and/or old) as a set of topological entities.</p>
Route	o	o	<p>A sequence of topological entities over which LCS is provided (i.e. connection points, links, sub-networks). The SP may associate user friendly names (i.e. city names) with such topological entities.</p>
Originating Location	m	o(=)	<p>Physical location (e.g. street address) where the Leased Circuit Service originates.</p> <p>Return of the value by the SP is optional; however, if the SP elects to return the value, it must be the same value supplied by the SC in the Create LCS request. SP is not allowed to alter this field.</p>

Service Customer Request and SP Response	Service Customer	Service Provider	Notes
Terminating Location	m	o(=)	Physical location (i.e. street address) where the Leased Circuit Service terminates. In the case of a circuit that terminates in a Central Office, this could be the name of the Service Node.
Originating Location CPE Type	o	o(=)	Describes the type and make of the CPE that the LCS is connected to at the Originating point of the circuit.
Terminating Location CPE Type	o	o(=)	Describes the type and make of the CPE that the LCS is connected to at the terminating point of the circuit.
Customer Contact	m	o(=)	The Customer contact person who may be called by the SP, who is knowledgeable and may be called for problems or questions concerning the service that has been ordered.
Provider Request Number		m	Unique identifier provided by the SP to identify the request.
Customer Request Number	o	o(=)	Unique identifier provided by the SC to identify the request.
Alias Name	o	o(=)	Customer supplied circuit identifier.
Originating Location Service Access Point	o	o	Access point where the Leased Circuit Service originates.
Terminating Location Service Access Point	o	o	Access point where the Leased Circuit Service terminates.
Circuit Number		c	Unique SP-specific identifier for the LCS. The value is not subject to standardization. c – This parameter shall be present when the quantity is equal to one, indicating a single LCS is requested and the response indicates the request is completed successfully. If more than one LCS is requested in the Create LCS function, the Report creation of LCS is used to notify the SC of the creation of the individual circuit numbers.
SP Contact		m	The Provider contact information for use by the SC in resolving questions or problems with the service.

Service Customer Request and SP Response	Service Customer	Service Provider	Notes
Error and reason code		c	c – This parameter is present if the request is rejected because of one or more of the following reason: Unknown Service Class Unknown Service Name Requested Bandwidth Not Available Resources Unavailable Quantity Specified Out of Range Invalid Service Termination Date Invalid Schedule Invalid Service Availability Date Request Already Closed Contract Violation Invalid Value Service Cannot Be Completed Invalid Address Required Parameter Not Available Non-Existent SAP

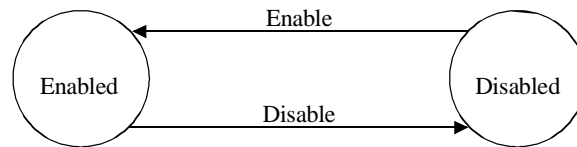
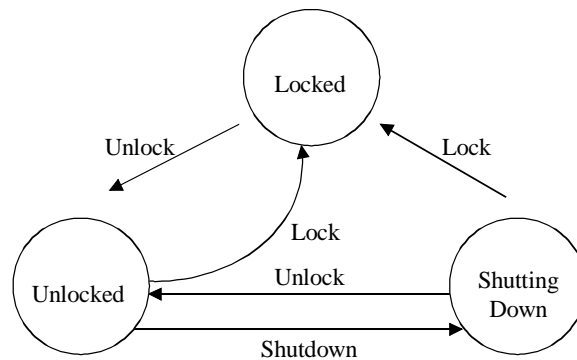

T0407490-97

Figure 5/M.3208.1 – Service administrative and operational state model from Recommendation X.731

3.3.3.1.2 Delete dedicated leased circuit service function

3.3.3.1.2.1 Summary

This function permits the SC to delete one or more Leased Circuit Services. The SC shall identify the circuit numbers to be deleted in the request.

In response to the deletion request from the SC, the SP shall respond with either:

- a) An acknowledgment with a Provider Request Number indicating the receipt of the delete function request. The completion of processing of the deletion service request will be reported to the SC at a later time, following processing of the delete function request using the Report Deletion function.
- b) Completion response indicating that the delete function request has been processed coincident with receipt of the request and that all information defined in the SP column of the Table for the Information Flows contained in 3.3.3.1.2.2 has been filled in and is available.
- c) The delete request has been rejected with a reason code indicating probable cause.

If b) or c), then this function is completed. If a), then the following interactions are possible:

- i) SP responds to the SC with information regarding the progress of the request using the Report Progress of the service request function of the Service Administrative Function Set.
- ii) the SC may inquire about the progress of the request using the Monitor progress of the service request function of the Service Administrative function set.
- iii) SP informs the SC upon the successful completion of the delete request using the Report deletion of LCS to service customer function of the Service Administrative function set.
- iv) SP informs the SC upon a failure in the processing of the delete request, using the Report Progress of service request function of the Service Administrative function with a reason code indicating probable cause of the failure. In addition, the SP may set the administrative state of the service to locked and report this change using the Report configuration change function of the Service administrative function set.

Item iii) or iv) signals completion of the function. The valid interactions are determined by the state model shown in Figure 4.

As a result of a successful delete operation diversity that may have been provided among a SC's LCSs may no longer be in effect for the remaining LCSs.

3.3.3.1.2.2 Information Flow

Service Customer Request and Service Provider Response	Service Customer	Service Provider	Notes
Circuit Number(s)	m	c	<p>The SC must supply the SP with the SP-specific unique Circuit Number(s). The Service Administrative State for the circuit(s) must be in a "Locked" state. If the Service Administrative State of the circuit(s) is "Unlocked", an error will be returned with a reason code indicating the LCS is currently active. The SC may then set the Service administrative state to shut down or locked prior to issuing a deletion request.</p> <p>The SP shall return the value(s) of the Circuit Number(s) being deleted if this is a completion response.</p>
Service Request State		c	<p>c – This parameter is present only when the response does not indicate completion of the request (success or error). The presence of this parameter indicates that the request is in progress and requested LCS(s) have not been deleted. The values are as specified for the create function.</p>
Service Provider Contact		o	<p>The SP provides an SP contact in cases in which the Delete LCS request fails due to an error in Circuit Number(s) or when the Delete LCS request fails due to the LCS(s) not being in the appropriate Service Administrative State, otherwise it is optional.</p>
Service Termination Date	o	o(=)	<p>The SC may supply a Service Termination Date specifying a date and time for the service to be deleted. If the SC does not supply a Service Termination Date, the date and time of termination is assumed to be specified in the Contract or immediately.</p>

Service Customer Request and Service Provider Response	Service Customer	Service Provider	Notes
Provider Request Number		c	Unique identifier provided by the SP to identify the request. c – This parameter is required only when the request state is not closed. This number is used by the SC to track (monitor) the progress of the request.
Customer Request Number	o	o(=)	Unique identifier provided by the SC to identify the request.
Error		c	c – This parameter is present if the request is rejected. Valid error codes are: Already Deleted Invalid Circuit Number Invalid Service Termination Date Not Being in Appropriate Service Administrative State Contract Violation

3.3.3.1.3 Modify dedicated leased circuit service function

The modify dedicated LCS function enables a SC to request the modification of a number of applicable parameters of both service requests and established LCSs.

When the LCS is established, the operational parameters of a LCS can only be modified if the Service Administrative State is Locked. If the Service Administrative state is Unlocked, the modification request will be rejected with a reason code indicating the service is in use. The SC may then set the Service Administrative state to locked or shutdown prior to requesting modifications. (Note that setting the Service Administrative state and modification of parameters may be done in one request).

3.3.3.1.3.1 Summary

In response to the modification request from the SC, the SP shall respond with either:

- a) An acknowledgement with a Provider Request Number together with a Request Sequence Number indicating the receipt of the modification request. The completion of processing of the modification request will be reported to the SC at a later time, following processing of the modification function request using the Report Configuration Changes of applicable service parameters function or report progress of Service Request.
- b) Completion response indicating that the modification request has been processed coincident with receipt of the request and that all information defined in the SP column of the Table for the Information Flows contained in 3.3.3.1.3.2 has been filled in and is available. Completion of the modification request does not imply that the LCS is established if the LCS was not established when the modification request was received by the SP.
- c) The modify request has been rejected with a reason code indicating probable cause.

If b) or c), then this function is completed. If a), then the following interactions are possible:

- i) SP responds to the SC with information regarding the progress of the request using the Report Progress of the service request function of the Service Administrative Function Set.
- ii) the SC may inquire about the progress of the request using the Monitor progress of the service request function of the Service Administrative function set.
- iii) SP informs the SC upon the successful completion of the modify request using either the Report Configuration Change of applicable service parameters function or the Report changes to service request parameters of the Service Administrative function set.
- iv) SP informs the SC upon a failure in the processing of the modification request, using the Report Progress of service request to service customer function of the Service Administrative function set with a reason code indicating probable cause of the failure.

Item iii) or iv) signals completion of the function. The valid interactions are determined by the state model shown in Figure 4.

3.3.3.1.3.2 Information Flow

Service Customer Request and Service Provider Response	Service Customer	Service Provider	Notes
Originating Location CPE Type	o	o(=)	
Terminating Location CPE Type	o	o(=)	
Customer Contact	o	o(=)	
Originating Location Service Access Point	c	o	c – The SAP modification is restricted to the same Originating Location. Once the service is established, the value cannot be modified.
Terminating Location Service Access Point	c	o	c – The SAP modification is restricted to the same Terminating Location. Once the service is established, the value cannot be modified.
Circuit Number	c	o	c – Either this parameter or the provider request number is present.
Provider Request Number	c1	c2	c1 – This parameter shall be present if the modification request is issued against a previously issued request that is not in the "Closed" processing state. The value of the parameter is the value given by the provider in response to the LCS create request. c2 – The SP shall always return a Provider Request Number in the response. If this request is not modifying a previous request, in the "Pre-processing", "Open/Active", or "Pending" processing state, the SP may return a new Provider Request Number.

Service Customer Request and Service Provider Response	Service Customer	Service Provider	Notes
Request Sequence Number		c	c – The Request Sequence Number together with the Provider Request Number provides a unique number for identifying this request. If the provider elects not to return a value to this parameter, the default value shall be zero.
Bandwidth	c3	o(=)	c3 – The presence of this optional parameter is controlled by the value specified in Service Name and Service Class. The SP may reject the modify LCS request if the requested bandwidth is not available with a reason code.
Route	c3	c	The SP may reject the modify LCS request and return a reason code in the error parameter if the requested route is not available due to Quality of Service or availability. c – The SP may return an alternate route when the requested route is not available.
Schedule	c3	c	The SP may reject the modify LCS request if the requested schedule is not available with a reason code. c – The SP may return an alternate schedule, then the requested schedule is not available.
Service Request State		c	c – This parameter is present only when the response does not indicate completion of the request (success or error). The presence of this parameter indicates that the request is in progress and requested LCS has not been modified. The values are as specified for the create function.
Service Termination Date	o	o	The SC may alter the Service Termination Date on any create, modify, or delete LCS request in any Service Request State.
Service Availability Date	c	c	The Service Availability Date can be modified only if the service has not been established (the circuit number has not been made available by the SP). The request shall be rejected if the service has already been established.

Service Customer Request and Service Provider Response	Service Customer	Service Provider	Notes
Service Administrative State	o	o	The SC may use this parameter to modify the value from locked to unlocked if the request was initially made for the LCS to be pre-provisioned. If the service has already been established, the SC may request it to be locked to either allow modifications of other parameters or discontinue service.
Alias Name	o	o(=)	
Error		c	c – This parameter is present if the request is rejected. Valid error codes are: Invalid Service Access Point Invalid CPE Type Required Bandwidth Not Available Unknown Route Invalid Schedule Invalid Service Available State Invalid Service Termination Date Service Administrative State Unlocked Invalid Circuit Number Contract Violation Resource Unavailable Invalid Provider Request Number Invalid Alias Name

3.3.3.1.4 Cancel dedicated leased circuit service request function

3.3.3.1.4.1 Summary

This function permits the SC to cancel a dedicated LCS after the create, delete or modify (only on an existing service) request has been acknowledged by the SP, but prior to the actual processing of the request by the SP.

The SC shall identify the provider request number of the service request to be cancelled.

The SP may reject the cancel request if processing of the create, delete, or modify request is close to completion. In this case, the SC may delete the service following Create LCS request completion, re-create the service using the Create LCS function.

In response to the service request from the SC, the SP shall respond with either:

- a) successful cancel of the request; or
- b) the cancel was not successful with an error code the service request is completed or closed.

3.3.3.1.4.2 Information Flow

Service Customer Request and Service Provider Response	Service Customer	Service Provider	Notes
Provider Request Number	m	m(=)	The value of the parameter is the value given by the provider in response to the LCS create request.
Request Sequence Number	c1	c2	c1 – The SC shall specify the SP supplied modification request number when the SC request cancellation of an issued modification request. c2 – If the parameter was provided in the request, the SP shall provide it in the response.
Error		c	If the request cannot be cancelled, an error shall be returned. Valid error codes are: Invalid Provider Request Number Request Already Cancelled

3.3.3.2 Dedicated leased circuit service status administration function set

This function set includes functions that allow the SP to inform the SC of Service administrative functions and for the SC to monitor administrative information related to the requested LCS. These functions contain status administration functions from Recommendation M.3400 and augments those with additional new functions.

- 1) Report creation of leased circuit service to service customer.
- 2) Report deletion of leased circuit service to service customer.
- 3) Report configuration changes of leased circuit service parameters to service customer.
- 4) Report change of leased circuit service request parameters.
- 5) Control leased circuit service administrative state by the service customer.
- 6) Retrieve leased circuit service parameters by the service customer.
- 7) Monitor progress of the leased circuit service request.
- 8) Report progress of the leased circuit service request.
- 9) Retrieve leased circuit service request parameters.

3.3.3.2.1 Report creation of leased circuit service to service customer function

3.3.3.2.1.1 Summary

This function is used to report the creation of an LCS to the service customer. This function is used in conjunction with the request to create the service. (This function is particularly applicable when the request is received to create a service and it is made available at a later time.) Service customer may or may not acknowledge the report.

3.3.3.2.1.2 Information Flow

Parameters (Information)	Service Provider	Notes
Service Name	o	The service name may be included by the service provider if different from the one requested. Whether it is permitted to include a different name than requested is outside the scope of standardization (may be included in the contract).
Service Class	o	The service class may be included by the service provider if different from the one requested. Whether it is permitted to include a different name than requested is outside the scope of standardization (may be included in the contract).
Bandwidth	c	c – This parameter is not present if the corresponding parameter was not present in the request.
Quantity	c	If a quantity was specified in the request, the value in this report may be different from that in the request. c – This parameter is not present if the corresponding parameter was not present in the request.
Service Termination Date	o	
Schedule	o	
Provider Request Number	m	
Service Availability Date	o	The date when the service is available for use by the SC.
Service Administrative State	o	Default value if the parameter is not present is unlocked.
Service Operational State	o	Indicates if the service is operational. Default value if parameter is absent is enabled.
Diversity	c	c – If diversity was in the request and the SP can support it only partially this parameter shall be present. The SP indicates the common (i.e. non-diverse) components of the circuits (new and/or old) as a set of topological entities. Otherwise the presence is optional.
Route	c	c – If the route was specified in the create service request, and the sequence of topological entities forming the route are different from the request these entities are included in the report. Otherwise optional.
Originating Location	o	
Terminating Location	o	
Originating Location CPE Type	o	

Parameters (Information)	Service Provider	Notes
Terminating Location CPE Type	o	
Customer Contact	o	
Alias Name	o	
Originating Location Service Access Point	m	
Terminating Location Service Access Point	m	
Circuit Number(s)	m	
SP Contact	m	

3.3.3.2.2 Report deletion of leased circuit service to service customer function

3.3.3.2.2.1 Summary

This function is used to report the deletion of an LCS to the service customer. This function is used in conjunction with the request to delete the service. (This function is particularly applicable when the request is received to delete a service and the deletion is done later in time.) Service customer may or may not acknowledge the report.

3.3.3.2.2.2 Information Flow

Parameters (Information)	Service Provider	Notes
Circuit Number	m	
Service Provider Contact	m	
Service Termination Date	o	If absent implies that the service is unavailable immediately.

3.3.3.2.3 Report configuration change of leased circuit service parameters to service customer function

3.3.3.2.3.1 Summary

This function is used to report the changes to configuration parameters of an LCS to the service customer. Only some parameters may change due to either internal operation or because of request from the service customer.

3.3.3.2.3.2 Information Flow

Parameters (Information)	Service Provider	Notes
Bandwidth	c1	c1 – Optional presence of this parameter is controlled by the value of service class parameter.
Schedule	c1	
Route	c1	
Originating Location CPE Type	o	
Terminating Location CPE Type	o	
Customer Contact	o	
Circuit Number	m	
Service Termination Date	o	
Service Operational State	o	
Service Administrative State	o	

3.3.3.2.4 Report change of leased circuit service request parameters function

3.3.3.2.4.1 Summary

This function is used to report changes to configuration parameters of a leased circuit service request to the service customer.

3.3.3.2.4.2 Information Flow

Parameters (Information)	Service Provider	Notes
Bandwidth	c1	c1 – Optional presence of this parameter is controlled by the value of the service class parameter.
Schedule	c1	
Route	c1	
Service Provider Contact	o	
Provider Request Number	m	
Request Sequence Number	c	
Service Class	o	
Quantity	c1	
Service Availability Date	o	
Diversity	c1	
Originating Location Service Access Point	o	
Terminating Location Service Access Point	o	
Circuit Number(s)	o	

3.3.3.2.5 Control leased circuit service administrative state by the service customer function

3.3.3.2.5.1 Summary

This function is used by the service customer to control the availability of the LCS or the ability of a LCS to be modified. Following to the Service Availability Date the SC may use this service to place the LCS in-service. The Service Administrative State must be set to Locked prior to any modifications. The request to modify the Administrative State may be rejected by the SP and an error or reason code returned to the SC.

3.3.3.2.5.2 Information Flow

Parameters (Information)	Service Customer	Service Provider	Notes
Circuit Number	m	o	
Service Administrative State	m	o	
Error		c	Valid errors are: Invalid Circuit Number Contract Violation

3.3.3.2.6 Retrieve leased circuit service parameters by the service customer function

3.3.3.2.6.1 Summary

This function is used by the service customer to retrieve the values of the parameters of the service. It assumes that the SP has completed processing of the service request associated with the instance of the service and that a Circuit Number has been generated and supplied to the SC by the SP.

3.3.3.2.6.2 Information Flow

Parameters (Information)	Service Customer	Service Provider	Notes
Bandwidth	c1	c	c – If the SC requests this parameter, the value shall be returned by the SP. c1 – Optional presence of this parameter is controlled by the value of service class parameter.
Schedule	c1	c	
Route	c1	c	
Originating Location CPE Type	o	c	
Terminating Location CPE Type	o	c	
Customer Contact	o	c	
Originating Location Service Access Point	o	c	

Parameters (Information)	Service Customer	Service Provider	Notes
Terminating Location Service Access Point	o	c	
Circuit Number	m	m	
Service Availability Date	o	c	
Service Termination Date	o	c	
Service Operational State	o	c	
Service Administrative State	o	c	
Alias Name	o	c	
Error		c	c – This parameter is present if the request is rejected because of one or more of the following reasons: Invalid Parameter Name Invalid Circuit Number

3.3.3.2.7 Monitor progress of the leased circuit service request function

3.3.3.2.7.1 Summary

This function is used by the service customer to monitor the progress of the service request to create an LCS.

3.3.3.2.7.2 Information Flow

Parameters (Information)	Service Customer	Service Provider	Notes
Provider Request Number	m	m	
Service Request State		m	The current state of the Service Request.
Error		c	c – This parameter will be present if the request is rejected for one or more of the following reasons: Invalid Circuit Number Invalid Parameter

3.3.3.2.8 Report progress of the leased circuit service request function

3.3.3.2.8.1 Summary

This function is used by the SP to report the progress of the service request to create an LCS to the SC.

3.3.3.2.8.2 Information Flow

Parameters (Information)	Service Provider	Notes
Provider Request Number	m	
Service Request State	m	
Error	c	c – If the request was not successful an error is sent with reason. Valid error codes are: Invalid Request Number Unknown Service Class Unknown Service Name Requested Bandwidth Not Available Resources Unavailable Quantity Specified Out of Range Invalid Service Termination Date Invalid Schedule Invalid Service Availability Date Contract Violation Invalid Value Service Cannot Be Completed Invalid Address Required Parameter Not Available Non-Existent SAP

3.3.3.2.9 Retrieve leased circuit service request parameters function

3.3.3.2.9.1 Summary

This function is used by the service customer to retrieve the values of the parameters of the service request.

3.3.3.2.9.2 Information Flow

Parameters (Information)	Service Customer	Service Provider	Notes
Bandwidth	c1	c	c – If the SC requests this parameter, the value shall be returned by the SP. c1 – Optional presence of this parameter is controlled by the value of service class parameter.
Schedule	c1	c	
Route	c1	c	
Originating Location CPE Type	o	c	
Terminating Location CPE Type	o	c	
Customer Contact	o	c	

Parameters (Information)	Service Customer	Service Provider	Notes
Originating Location Service Access Point	o	c	
Terminating Location Service Access Point	o	c	
Provider Request Number	m	m	
Service Availability Date	o	c	
Service Operational State	o	c	
Service Administrative State	o	c	
Alias Name	o	c	
Error		c	c – This parameter will be present if the request is rejected for one or more of the following reasons: Invalid Parameter Name Invalid Provider Request Number

3.3.3.3 Link connection configuration service function set

This function set provides SCs the capabilities to establish or remove point-to-point links representing the transport between Customer Premises and a provider Service Node (SN), between two providers' SNs, or within a provider's SNs. Note that a single Link Connection may support multiple LCS. The CPs are assumed to exist prior to the receipt of this request. The services used to create CPs which underlie the Create, Delete, or Cancel link connections are not considered within the present scope of this Recommendation. This area is considered for further study and will be considered in the future. Provisioning of the supporting Link is outside the scope of standardization. The functions in this set are:

- 1) Create link connection.
- 2) Delete link connection.
- 3) Modify link connection.
- 4) Cancel link connection request.

3.3.3.3.1 Create link connection function

3.3.3.3.1.1 Summary

This function allows the SC to request the creation of a Link Connection that is capable of supporting the transfer of information associated with one or more LCS.

To create a Link Connection a SC specifies the Link Connection endpoints (CP or SN APs). The SP may permit the customer to specify the Link Connection characteristics (e.g. bandwidth, directionality, availability, etc.) associated with a Link Connection. The SP may reject the request based on the Link Connection characteristics.

The SP may permit the inclusion of a user identifier in the request. The SP may reject the request if the user identifier is ambiguous in some context.

Information Flow defines the various parameters associated with the request.

This function includes the following interactions between the SC and the SP. Not all interactions will be applicable in all cases.

SC uses the Create Link Connection function to request the creation of a Link Connection from SP.

The response from the SP may be either:

- a) An acknowledgment with a Provider Request Number indicating the receipt of the create link connection function request. The completion of processing of the service request will be reported to the SC at a later time, following processing of the create function request using the Report Creation of Link Connection to service customer function.
- b) Completion response indicating that the create Link Connection function request has been processed coincident with receipt of the request and that all information defined in the SP column of the Table for the Information Flows contained in 3.3.3.3.1.2 has been filled in and is available.
- c) The Create Link Connection function request has been rejected with a reason code indicating probable cause.

If b) or c), then this function is completed. If a), then the following interactions are possible.

- i) SP informs the SC information regarding the progress of the function using the Report Progress of the Link Connection request function of the Link Connection Administrative Function Set.
- ii) the SC may inquire about the progress of the request using the Monitor progress of the service request function of the Link Connection Administrative function set.
- iii) SP informs the SC upon the successful completion of the Create Link Connection function request using the Report creation of Link Connection to service customer function of the Link Connection Administrative function set.
- iv) SP informs the SC upon a failure in the processing of the Create link connection function request, using the Report Progress of Link Connection request to service customer function of the Link Connection Administrative function with a reason code indicating probable cause of the failure.

Item iii) or iv) below signals completion of the function. The valid interactions are determined by the state model shown in Figure 4.

3.3.3.3.1.2 Information Flow

Service Customer Request and Service Provider Response	Service Customer	Service Provider	Notes
Service Name	m	o	The name of the Link connection service. Service names are not subject to standardization.
Service Class	o	c	Service Class Name for the Link connection service.
Link Connection Bandwidth	o	c	c – If the requested bandwidth cannot be provided by the SP, the SP shall return the value together with a reason code indicating that the bandwidth is not available. If the response is not indicating a completion, the SP may report an error condition with a reason code indicating that the available service differs from the customers initial service request.
Link Connection Termination Date	o	o(=)	The date at which the Link Connection will be made Inactive.
Link Connection Availability Date	o	m	Date the Link Connection is due to be provisioned and placed in the requested Link Connection Administrative State.
Link Connection Request State		c	The behaviour of this parameter is the same as service request defined in Create LCS function (Table in 3.3.3.1.1.2).
Link Connection Administrative State	o	o(=)	The behaviour of this parameter is the same as for Link Connection administrative state in 3.3.3.1.1.2.
Link Connection Operational State		o	The behaviour of this parameter is the same as for service operational state in 3.3.3.1.1.2.
Provider Request Number		m	Unique identifier provided by the SP to identify the request.
Link Connection Alias Name	o	o(=)	Customer supplied alias for the Link Connection.

Service Customer Request and Service Provider Response	Service Customer	Service Provider	Notes
Originating Location Connection Point	c1	c	<p>CP or SN, where the Link Connection originates.</p> <p>Must exist prior to provisioning. The SC may not know the name at the time of the request. SP must provide the name of the CP to the SC.</p> <p>SP cannot provision the service unless the CP is known.</p> <p>c1 – The SC must provide either the Originating or Terminating Location Connection Point or both.</p> <p>If one of the points is at the customer premises, that point must be provided by the SC.</p> <p>If one of the points is in a network of a service provider other than the one receiving this request, it must be provided by the SC.</p> <p>c – If the Link Connection Point Name is not provided by the SC in the request and the response indicates the completion of the LC and the SC did not provide it in the request, then the value of this parameter must be provided by the SP in the response.</p>
Terminating Location Connection Point	c1	c	<p>CP or SN, where the Link Connection terminates.</p> <p>Must exist prior to provisioning. The SC may not know the name at the time of the request. SP must provide the name of the CP to the SC.</p> <p>SP cannot provision the service unless the CP is known.</p> <p>c – If the Link Connection Point Name is not provided by the SC in the request and the response indicates the completion of the LC and the SC did not provide it in the request, then the value of this parameter must be provided by the SP in the response.</p>

Service Customer Request and Service Provider Response	Service Customer	Service Provider	Notes
Link Connection Identifier		c	Unique SP-specific identifier for the Link Connection. The value is not subject to standardization. The SP must provide the Link Connection when the service is established. c – This parameter shall be present when the response indicates the request is completed successfully. If either the request is rejected due to an error or when the provider request number is present in the response this parameter is not present.
SP Contact		m	The Provider contact information for use by the SC in resolving questions or problems with the Link Connection.
Customer Contact	m	o(=)	
Error		c	c – This parameter is present if the request is rejected. Valid error codes are: Unknown Service Class Unknown Service Name Requested Link Connection Bandwidth Not Available Resources Unavailable Invalid Link Connection Termination Date Invalid Link Connection Availability Date Contract Violation Invalid Value Link Connection Request cannot be Completed Required Parameters Not Available Non-Existent Link Connection Point

3.3.3.3.2 Delete link connection function

3.3.3.3.2.1 Summary

This function permits the SC to delete one or more links. The SC shall identify the links to be deleted in the request.

This function permits the SC to delete one or more Link Connections. The SC shall identify the circuit numbers to be deleted in the request.

In response to the deletion request from the SC, the SP shall respond with either:

- a) An acknowledgment with a Provider Request Number indicating the receipt of the delete link function request. The completion of processing of the deletion request will be reported to the SC at a later time, following processing of the delete link function request using the Report Deletion of Link Connection function.

- b) Completion response indicating that the delete link connection function request has been processed coincident with receipt of the request and that all information defined in the SP column of the Table for the Information Flows contained in 3.3.3.1.2.2 has been filled in and is available.
- c) The delete link connection request has been rejected with a reason code indicating probable cause.

If b) or c), then this function is completed. If a), then the following interactions are possible:

- i) SP responds to the SC with information regarding the progress of the request using the Report Progress of the delete link connection request function of the Service Administrative Function Set.
- ii) the SC may inquire about the progress of the request using the Monitor progress of the delete link connection request function of the Service Administrative function set.
- iii) SP informs the SC upon the successful completion of the delete link connection request using the Report deletion of link connection to service customer function of the Service Administrative function set.
- iv) SP informs the SC upon a failure in the processing of the delete link connection request, using the Report Progress of delete link connection request function of the Service Administrative function with a reason code indicating probable cause of the failure. In addition, the SP may set the administrative state of the service to locked and report this change using the Report configuration change function of the Service administrative function set.

Item iii) or iv) signals completion of the function. The valid interactions are determined by the state model shown in Figure 4.

3.3.3.3.2.2 Information Flow

Service Customer Request and Service Provider Response	Service Customer	Service Provider	Notes
Link Connection Identifier(s)	m	c(=)	<p>The SC shall supply the SP with the SP-specific unique Link Connection Identifier(s). The Link Connection Administrative State must be in a Locked State. If the Link Connection Administrative State is Unlocked, the delete request is rejected with a reason code indicating that the Link Connection is In-Use. The SC may then set the Link Connection Administrative State to Shutdown.</p> <p>c – The SP shall return the Link Connection Identifiers for LCs which have been deleted.</p>

Service Customer Request and Service Provider Response	Service Customer	Service Provider	Notes
Service Provider Contact		o	The SP provides an SP contact in cases in which the Delete Link Connection request fails due to an error in Link Connection Identifier(s) or because of the Link Connection(s) not being in the appropriate Link Connection Administrative State or Usage State.
Provider Request Number		c	Unique identifier provided by the SP to identify the request. c – This parameter is required only when the request state is not completed or closed. This number is used by the SC to track (monitor) the progress of the request.
Link Connection Termination Date	o		The SC may supply a Service Termination Date specifying a date and time for the service to be deleted. If the SC does not supply a Service Termination Date, the date and time of termination is assumed to be specified in the Contract or immediately.
Error		c	c – This parameter is present if the request is rejected. Valid error codes are: Already Deleted Invalid Link Connection Identifier Invalid Link Connection Termination Date Not being in Appropriate Link Connection Administration State Contract Violation

3.3.3.3.3 Modify link connection function

The modify LC function enables a SC to request the modification of a number of applicable parameters of both service requests and established LCs.

When the LC is established, the operational parameters of a LC can only be modified if the Link connection administrative state is Locked. If the Link connection administrative state is Unlocked, the modification request will be rejected with a reason code indicating the Link Connection is in use. The SC may then set the Link Connection Administrative state to locked or shutdown prior to requesting modifications. (Note that setting the Link connection administrative state and modification of parameters may be done in one request.)

3.3.3.3.1 Summary

In response to the modification request from the SC, the SP shall respond with either:

- a) An acknowledgement with a Provider Request Number together with a Request Sequence Number indicating the receipt of the modification request. The completion of processing of the modification request will be reported to the SC at a later time, following processing of the modification function request using the Report link connection configuration changes of applicable service parameters function or Report progress of link connection request.
- b) Completion response indicating that the modification request has been processed coincident with receipt of the request and that all information defined in the SP column of the Table for the Information Flows contained in 3.3.3.3.1.2 has been filled in and is available. Completion of the modification request does not imply that the LC is established if the LC was not established when the modification request was received by the SP.
- c) The modify request has been rejected with a reason code indicating probable cause.

If b) or c), then this function is completed. If a), then the following interactions are possible:

- i) SP responds to the SC with information regarding the progress of the request using the Report progress of the link connection request function of the Link connection administrative function set.
- ii) the SC may inquire about the progress of the request using the Monitor progress of the link connection request function of the Link connection administrative function set.
- iii) SP informs the SC upon the successful completion of the modify request using the Report link connection configuration change of applicable service parameters function of the Link connection administrative function set.
- iv) SP informs the SC upon a failure in the processing of the modification request, using the Report progress of link connection request to service customer function of the Link connection administrative function with a reason code indicating probable cause of the failure.

Item iii) or iv) signals completion of the function. The valid interactions are determined by the state model shown in Figure 4.

3.3.3.3.2 Information Flow

Service Customer Request and Service Provider Response	Service Customer	Service Provider	Notes
Link Connection Bandwidth	o	o(=)	The SP may reject the Modify Link Connection bandwidth request with a reason code if the requested bandwidth is not available, or the underlying Link Connection facility cannot support the requested bandwidth.
Customer Contact	o	o(=)	
Originating Location Connection Point	o	o	
Terminating Location Connection Point	o	o	

Service Customer Request and Service Provider Response	Service Customer	Service Provider	Notes
Provider Request Number	c1	c2	<p>c1 – This parameter shall be present if the modification request is issued against a previously issued request that is not in the "Closed" processing state. The value of the parameter is the value given by the provider in response to the LCS create request.</p> <p>c2 – The SP shall always return a Provider Request Number in the response. If this request is not modifying a previous request, in the "Pre-processing", "Open/Active", or "Pending" processing state, the SP may return a new Provider Request Number.</p>
Request Sequence Number		c	<p>c – The request sequence number together with the Provider Request Number provides a unique number for identifying this request. If the provider elects not to return a value for this parameter, the default value shall be zero.</p>
Link Connection Request State		c	<p>c – This parameter is present only when the response does not indicate completion of the request (success or error). The presence of this parameter indicates that the request is in progress and requested Link Connection has not been modified. The values are as specified in Figure 4.</p>
Link Connection Identifier	c	o	<p>c – This parameter or the provider request number is present.</p>
Link Connection Termination Date	o	o	<p>The SC may alter the Link Connection Termination Date on any create, modify, or delete Link Connection request in any Service Request State, provided that the Link Connection Termination Date is not less than the current Date/Time.</p>
Link Connection Availability Date	c	c	<p>c – The Link Connection Availability Date can only be modified if the link connection has not been established. The request shall be rejected if the service has already been established.</p>

Service Customer Request and Service Provider Response	Service Customer	Service Provider	Notes
Link Connection Administrative State	o	o	The SC may use this parameter to modify the state from locked to unlocked if the request was initially made for the link connection to be pre-provisioned. If link connection has already been established, the SC may request it to be locked to either allow modifications of other parameters or discontinue the link connection.
Link Connection Alias Name	o	o(=)	
Link Connection Schedule	o	o(=)	
Error		c	c – This parameter is present if the request is rejected. Valid error codes are: Invalid Link Connection Point Required Bandwidth Not Available Invalid Schedule Invalid Link Connection Available State Invalid Link Connection Termination State Link Connection Administration State Unlocked Invalid Link Connection Identifier Contract Violation Resource Unavailable Invalid Provider Request Number Invalid Link Connection Alias Name

3.3.3.3.4 Cancel link connection request function

3.3.3.3.4.1 Summary

This function permits the SC to cancel a Link Connection after the create, delete or modify has been acknowledged by the SP, but prior to the actual processing of the request by the SP.

The SC shall identify the provider request identifier of the Link Connection request to be cancelled.

The SP may reject the cancel request if processing of the create, delete, or modify Link Connection request is close to completion. In this case, the SC may delete the service following Create Link Connection request completion, re-create the Link Connection following a completion of a Delete Link Connection request completion, or a Modify, following a Modify Link Connection request completion.

In response to the cancel request from the SC, the SP shall respond with either:

- a) successful cancel of the request; or
- b) the cancel was not successful with an error code that the original link connection service request is completed or closed.

3.3.3.3.4.2 Information Flow

Service Customer Request and Service Provider Response	Service Customer	Service Provider	Notes
Provider Request Number	m	m	The provider specific identifier (as returned in the create/delete/modify Link Connection request), of the request to be cancelled.
Request Sequence Number	c1	c2	c1 – The SC shall specify the SP supplied Request sequence number when attempting to cancel an existing request. The SC shall use the request sequence number to identify the specific modification request to be cancelled. c2 – If the parameter is provided in the request by the SC, the SP will supply in the response.
Error		c	c – This parameter will be present if the request is rejected. Valid reason codes are: Invalid Provider Request Number Request Already Cancelled

3.3.3.4 Link connection status administration function set

This function set includes functions that allow the SP to inform the SC of Link Connection functions and for the SC to monitor administrative information related to the requested Link Connection(s). These functions contain Link Connection status administration functions from Recommendation M.3400 and augments with additional functions.

- 1) Report creation of link connection to service customer.
- 2) Report deletion of link connection to service customer.
- 3) Report configuration change of link connection parameters to service customer.
- 4) Report change of link connection request parameters.
- 5) Control link connection administrative state by the service customer.
- 6) Retrieve link connection parameters by the service customer.
- 7) Monitor progress of the link connection request.
- 8) Report progress of the link connection request.
- 9) Retrieve link connection request parameters.

3.3.3.4.1 Report creation of link connection to service customer function

3.3.3.4.1.1 Summary

This function is used to report the creation of a Link Connection to the service customer. This function is used in conjunction with the request to create the Link Connection. (This function is particularly applicable when the request is received to create a Link Connection and it is made available later in time.) Service customer may or may not acknowledge the report.

3.3.3.4.1.2 Information Flow

Parameters (Information)	Service Provider	Notes
Service Name	m	
Service Class	o	
Link Connection Bandwidth	c	If a bandwidth was specified in the request, the value in this report may be different from that in the request. Absence of this parameter assumes that the requested bandwidth was allocated. c – This parameter is not present if the corresponding parameter was not present in the request.
Link Connection Termination Date	o	The date when the link connection will be terminated.
Link Connection Availability Date	o	The date when the link is available for use.
Link Connection Administrative State	o	Default value if the parameter is not present is unlocked.
Link Connection Operational State	o	Default value if parameter not present is enabled.
Provider Request Number	m	
Link Connection Alias Name	o	
Originating Location Connection Point	c	c – If the Connection Point Name is not provided by the SC in the request, then the value of this parameter must be provided by the SP.
Terminating Location Connection Point	c	c – If the Connection Point Name is not provided by the SC in the request, then the value of this parameter must be provided by the SP.
Link Connection Identifier	m	
SP Contact	m	

3.3.3.4.2 Report deletion of link connection to service customer function

3.3.3.4.2.1 Summary

This function is used to report the deletion of an Link Connection to the SC. This function is used in conjunction with the request to delete the Link Connection. (This function is particularly applicable when the request is received to delete a link connection and the deletion is done later in time.) Service customer may or may not acknowledge the report.

3.3.3.4.2.2 Information Flow

Parameters (Information)	Service Provider	Notes
Link Connection Identifier	m	
Service Provider Contact	m	
Link Termination Date	o	If absent implies that the LC is unavailable immediately.

3.3.3.4.3 Report configuration change of link connection parameters to service customer function

3.3.3.4.3.1 Summary

This function is used to report the changes to configuration parameters of a Link Connection to the SC. Only some parameters may change due to either internal operation or because of request from the SC.

3.3.3.4.3.2 Information Flow

Parameters (Information)	Service Provider	Notes
Link Connection Bandwidth	o	
Link Connection Termination Date	o	
Link Connection Administrative State	o	
Link Connection Operational State	o	
Link Connection Alias Name	o	
Originating Location Link Connection Point	o	
Terminating Location Link Connection Point	o	
Link Connection Identifier	m	
SP Contact	o	

3.3.3.4.4 Report change of link connection request parameters function

3.3.3.4.4.1 Summary

This function is used to report changes to configuration parameters of a LC request to the service customer.

3.3.3.4.4.2 Information Flow

Parameters (Information)	Service Provider	Notes
Link Connection Bandwidth	o	
Link Connection Termination Date	o	
Link Connection Administrative State	o	
Link Connection Operational State	o	
Link Connection Alias Name	o	

Parameters (Information)	Service Provider	Notes
Originating Location Connection Point	o	
Terminating Location Connection Point	o	
Provider Request Number	m	
SP Contact	o	

3.3.3.4.5 Control link connection administrative state by the service customer function

3.3.3.4.5.1 Summary

This function is used by the SC to control the availability of the Link Connection. If the Link Connection was pre-provisioned, the SC may use this function to turn on the service. The Link Connection Administrative State will typically be set to a Locked state by the SP. Under the authorization of the contract, the SP will set the value to Unlocked upon reaching the Link Connection Availability Date.

3.3.3.4.5.2 Information Flow

Parameters (Information)	Service Customer	Service Provider	Notes
Link Connection Identifier	m	o	
Link Connection Administrative State	m	o	
Error		c	c – This parameter will be present if the request is rejected. Valid reason codes are: Invalid Link Connection Identifier Contract Violation

3.3.3.4.6 Retrieve link connection parameters by the service customer function

3.3.3.4.6.1 Summary

This function is used by the service customer to retrieve the values of the parameters of the Link Connection. It assumes that the SP has completed processing of the Link Connection request associated with the instance of the Link Connection and that a Link Connection Identifier has been generated and supplied to the SC by the SP.

3.3.3.4.6.2 Information Flow

Parameters (Information)	Service Customer	Service Provider	Notes
Link Connection Bandwidth	o	c	
Customer Contact	o	c	
Originating Location Connection Point	o	c	
Terminating Location Connection Point	o	c	
Link Connection Identifier	m	m	
Link Connection Termination Date	o	c	
Link Connection Availability Date	o	c	
Link Connection Operational State	o	c	
Link Connection Administrative State	o	c	
Link Connection Alias Name	o	c	
Error		c	c – This parameter will be present if the request is rejected. Valid reason codes are: Invalid Link Connection Identifier Invalid Parameter Name

3.3.3.4.7 Monitor progress of the link connection request function

3.3.3.4.7.1 Summary

This function is used by the service customer to monitor the progress of the Link Connection request.

3.3.3.4.7.2 Information Flow

Parameters (Information)	Service Customer	Service Provider	Notes
Provider Request Number	m	m	
Link Connection Request State		m	The current state of the Link Connection Request.
Error		c	c – This parameter is present if the request is rejected. Valid reason codes are: Invalid Request Number

3.3.3.4.8 Report progress of the link connection request function

3.3.3.4.8.1 Summary

This function is used by the SP to report the progress of the Link Connection request to the SC.

3.3.3.4.8.2 Information Flow

Parameters (Information)	Service Provider	Notes
Provider Request Number	m	
Link Connection Request State	m	
Error	c	<p>c – This parameter is present if the request is rejected because of one or more of the following reason: cannot support the requested schedule, requested availability date is not supportable or invalid, requested diversity cannot be supported. Valid error codes are:</p> <ul style="list-style-type: none"> Unknown Service Class Unknown Service Name Requested Link Connection Bandwidth Not Available Resources Unavailable Invalid Link Connection Termination Date Invalid Link Connection Availability Date Contract Violation Invalid Value Link Connection Request cannot be Completed Required Parameters Not Available Non-Existent Link Connection Point

3.3.3.4.9 Retrieve link connection request parameters function

3.3.3.4.9.1 Summary

This function is used by the service customer to retrieve the values of the parameters of the link connection service request.

3.3.3.4.9.2 Information Flow

Service Customer Request and Service Provider Response	Service Customer	Service Provider	Notes
Link Connection Bandwidth	o	c	c – This parameter is present if the request is rejected.
Customer Contact	o	c	
Provider Request Number	m	m	
Originating Location Connection Point	o	c	
Terminating Location Connection Point	o	c	
Link Connection Request State	o	c	
Link Connection Identifier(s)	o	c	
Link Connection Termination Date	o	c	

Service Customer Request and Service Provider Response	Service Customer	Service Provider	Notes
Link Connection Availability Date	o	c	
Link Connection Administrative State	o	c	
Link Connection Alias Name	o	c	
Link Connection Schedule	o	c	
Error	o	c	c – This parameter is present if the request is rejected. Valid error codes are: Invalid Link Connection Identifier Contract Violation Invalid Provider Request Number Invalid Parameter

3.3.3.5 Reconfigurable leased circuit service configuration function set

The reconfigurable LCS is a collection of leased circuit service functions in which the connectivity between the service access points is dynamically configured by the SC from a predefined domain of access groups. The domain belongs to one SC. The Originating and Terminating Service Access Points for the reconfigurable LCS must be within the same Service Access domain. The SC must be able to request the creation, deletion, and modification of the reconfigurable LCS and be notified of the completion of the request.

The Reconfigurable LCS can be modelled as a cross-connection, where the connections between access points can be switched among cross-connect points to complete the connections from the originating location to multiple terminating locations individually. This switching may occur based upon time of day, or some other SC specified event or explicit request by the SC. Figure 6 illustrates the Reconfigurable LCS.

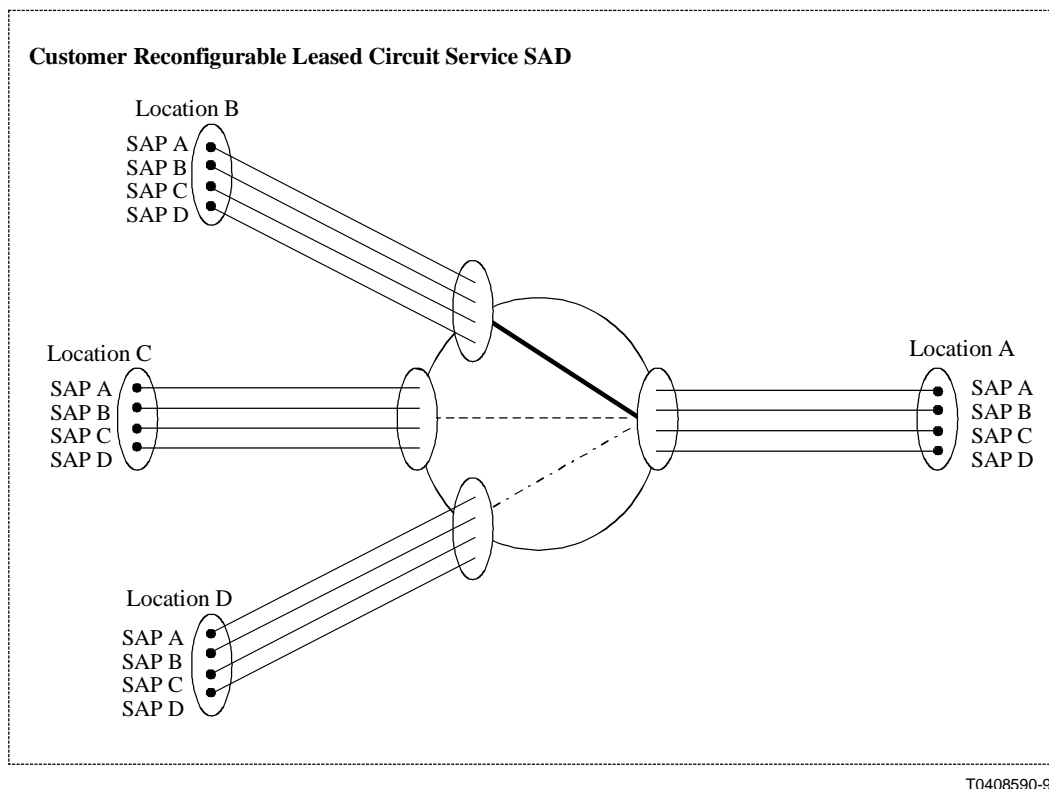

Figure 6/M.3208.1 – Example Topology of the Reconfigurable Leased Circuit Service

In Figure 6 a typical Reconfigurable LCS is modelled as a single customer with 4 locations, A, B, C, and D. The access groups, shown as ellipses, at these four locations form a Service Access Domain. The figure shows a Reconfigurable LCS consisting of the service access domain and 4 Service Access Groups, each of which supports 4 individual service access points. The circle in the center represents a sub-network. SAP A from Customer Location A is connected to SAP A at Customer Location B. Based on some event, for example, time of day, the individual access points from Customer Location A, can be connected to corresponding access points at Customer Location B, C, or D.

The SC uses the Dedicated LCS functions specified in 3.3.3.1 to create and delete LCSs between the SAP in the customer's locations and specifies the SAPs in the sub-network as termination points for the individual LCSs.

The functions in this set are:

- 1) Create link connection.
- 2) Delete link connection.
- 3) Modify link connection.
- 4) Cancel link connection request.
- 5) Create leased circuit service.
- 6) Delete leased circuit service.
- 7) Modify leased circuit service.

3.3.3.6 Reconfigurable leased circuit service function set

The function that controls atomic reconfiguration of the service is for further study. In the meantime, reconfiguration can be performed by performing a delete of a circuit followed by a create to a different destination.

3.3.3.7 Service access domain configuration function set

The functions in this set are:

- 1) Create service access domain.
- 2) Create service access group.
- 3) Delete service access group.
- 4) Add service access points to service access group.
- 5) Remove service access points from service access group.

3.3.3.7.1 Create service access domain function

3.3.3.7.1.1 Summary

The purpose of this function is to enable the SC to create a named Service Access Domain, to which Service Access Groups and Service Access Points will be added to support the Reconfigurable Leased Circuit Service.

3.3.3.7.1.2 Information Flow

Service Customer Request and Service Provider Response	Service Customer	Service Provider	Notes
Customer Contact	m		The Customer contact name.
Alias Name	o		Customer Defined user-friendly name.
Service Class	o	o	Service Class to be supported by the Access Domain.
Service Name	m	o	
List of SAGs	o	o(=)	
Provider Request Number		m	The SP-specific identifier for the request.
SP Contact		m	The Provider contact name in case of problems.
Service Access Domain Identifier	m	m(=)	The SP generated name for the Service Access Domain.
Error		c	c – This parameter is present if the request is rejected because of one or more of the following reasons (only one error cause may be returned by the SP): Invalid Location Invalid Service Name Invalid Service Class

3.3.3.7.2 Create service access group function

3.3.3.7.2.1 Summary

The purpose of this function is to enable the SC to create named Service Access Groups, to which Service Access Points will be added to support the Reconfigurable Leased Circuit Service.

3.3.3.7.2.2 Information Flow

Service Customer Request and Service Provider Response	Service Customer	Service Provider	Notes
Alias Name	o		Customer Defined user-friendly name.
Service Access Group Name	m		Name of Service Access Group.
Service Access Domain Identifier	o	o(=)	
Service Administrative State	o	c	The state of the service access group. c – Must be returned if the state is different than the state requested by the SC.
SAG Location	m	c	c – must be returned when the location is invalid.
Error	o	c	c – This parameter is present if the request is rejected because of one or more of the following reasons (only one error cause may be returned by the SP): Invalid SAG Id Invalid SAD Id Invalid Location

3.3.3.7.3 Delete service access group function

3.3.3.7.3.1 Summary

The purpose of this function is to enable the SC to delete Service Access Groups and all associated Service Access Points.

3.3.3.7.3.2 Information Flow

Service Customer Request and Service Provider Response	Service Customer	Service Provider	Notes
Service Access Group Identifier	m	o	Service Access Group to be deleted.
Service Domain Identifier	m	o	The Id of the SAD in which the SAG is contained.
Error		c	c – This parameter is present if the request is rejected because of one or more of the following reasons (only one error cause may be returned by the SP): Invalid SAD Id Invalid SAG Id

3.3.3.7.4 Add service access points to service access group function

3.3.3.7.4.1 Summary

The purpose of this function is to enable the SC to add Service Access Points to a named Service Access Group.

3.3.3.7.4.2 Information Flow

Service Customer Request and Service Provider Response	Service Customer	Service Provider	Notes
Service Access Group Id	m	c	c – must be present in case of an error.
Service Access point Id(s)	o	c	Either contains the Ids of the SAP(s) to be added, or if empty, the SP will provide the Id(s) c – must be present in case of an error or if the Ids are not provided by the SC.
Number of Service Access Point(s)	o		If this parameter is not provided and no SAP Ids are provided a single SAP will be added to the SAG. If both this parameter and the SAP Ids parameter are present, the quantity specified is in addition to the SAPs identified in the SAP Ids parameter.
Error	o	c	c – This parameter is present if the request is rejected because of one or more of the following reasons (only one error cause may be returned by the SP): Invalid SAG Id Invalid SAP Id SAP not in appropriate usage state Resources not available

3.3.3.7.5 Remove service access points from service access group function

3.3.3.7.5.1 Summary

The purpose of this function is to enable the SC to remove Service Access Points from a named Service Access Group.

3.3.3.7.5.2 Information Flow

Service Customer Request and Service Provider Response	Service Customer	Service Provider	Notes
Service Access Group Id	m	c	c – must be present in case of an error.
Service Access point Id(s)	m	c	The Ids of the SAP(s) to be deleted. c – must be present in case of an error.
Error	o	c	c – This parameter is present if the request is rejected because of one or more of the following reasons (only one error cause may be returned by the SP): Invalid SAG Id Invalid SAP Id SAP not in appropriate usage state

3.3.3.8 Reconfigurable leased circuit service administration function set

The SC must be able to receive service status change reports as well as control of service status change reporting. The service administration function set of Recommendation M.3400 containing:

- 1) Report creation of leased circuit service to service customer.
- 2) Report deletion of leased circuit service to service customer.
- 3) Report configuration change of leased circuit service parameters to service customer.
- 4) Report change of reconfigurable leased circuit service request parameters.
- 5) Control leased circuit service administrative state by the service customer.
- 6) Report leased circuit service parameters by the service customer.
- 7) Monitor progress of the leased circuit service request.
- 8) Report progress of the leased circuit service request.
- 9) Retrieve leased circuit service parameters.

3.3.3.8.1 Report creation of leased circuit service to service customer function

See 3.3.3.2.1: Report creation of leased circuit service to service customer function.

3.3.3.8.2 Report deletion of leased circuit service to service customer function

See 3.3.3.2.2: Report deletion of leased circuit service to service customer function.

3.3.3.8.3 Report configuration change of leased circuit service parameters to service customer function

See 3.3.3.2.3: Report configuration change of leased circuit service parameters to service customer function.

3.3.3.8.4 Report change of reconfigurable leased circuit service request parameters function

See 3.3.3.2.4: Report change of leased circuit service request parameters function.

3.3.3.8.5 Control leased circuit service administrative state by the service customer function

See 3.3.3.2.5: Control leased circuit service administrative state by the service customer function.

3.3.3.8.6 Retrieve leased circuit service parameters by the service customer function

See 3.3.3.2.6: Retrieve leased circuit service parameters by the service customer function.

3.3.3.8.7 Monitor progress of the leased circuit service request function

See 3.3.3.2.7: Monitor progress of the leased circuit service request function

3.3.3.8.8 Report progress of the leased circuit service request function

See 3.3.3.2.8: Report progress of the leased circuit service request function.

3.3.3.9 Access equipment status administration function set

The SP may be able to access information regarding the status of access equipment for miscellaneous reasons such as:

- in the provisioning of some data services such as frame relay, the provider may need to know what options need to be supported based on the customer's access equipment;
- in order to support service assurance, the SP may need to perform loop-back testing that involves the customer's access equipment or access the error statistics compiled by the customer's equipment;
- in the provisioning of some conditioned circuits, the SP may need to know the type of the customer's equipment in order to provide the correct conditioning;
- a SP may need to access usage data collected by a customer's PBX in order to provide detailed billing data for the LCS.

3.3.3.9.1 Access equipment status update function

3.3.3.9.1.1 Summary

The SC must be able to convey to the SP any information related to the access equipment that the SP may need in order to perform loop-back testing or any similar function agreed upon as part of the service. Such information may include the name of the manufacturer and the model type of the equipment. This function allows the SC to alert the SP when such equipment is about to be changed, or has been changed, or if its operational and/or administrative state has changed.

3.3.3.9.1.2 Information Flow

Service Customer conveys CPE information to Service Provider	Service Customer	Notes
Equipment Type	o	
Equipment Manufacturer	o	
Model Type	o	
Date Of Installation	o	
Expected Date Of Installation	o	
Operational State	o	
Administrative State	o	
Location	m	
Service Access Point	m	

3.3.3.9.2 Access equipment status inquiry function

3.3.3.9.2.1 Summary

The SP must be able to query the SC regarding the access equipment that may be needed in order to perform loop-back testing or any similar function agreed upon as part of the service. Such information may include the name of the manufacturer and the model type of the equipment. The SP must further be able to alert the SC if any (planned) change in the access equipment may cause changes to the way loop-back testing or any similar function agreed upon as part of the service is done.

3.3.3.9.2.2 Information Flow

Service Customer conveys CPE information to Service Provider	Service Provider	Service Customer	Notes
Equipment Type	o	c	c – provided by SC if requested by SP and required by the service contract.
Equipment Manufacturer	o	c	
Model Type	o	c	
Date Of Installation	o	c	
Expected Date Of Installation	o	c	
Operational State	o	c	
Administrative State	o	c	
Changes In Procedure	o		
Location	m	m	
Service Access Point	m	m	

3.4 Management scenarios

Management scenarios are described for examination of the relationships among roles, resources and functions of which management context is composed. For this purpose, scenarios show interactions between the service customer role and the service provider role, using the telecommunications services or resources and functions. Based on the purpose of examining the relationships among management context, management scenarios only show representative examples of interactions between service customer role and service provider role, but do not cover whole of cases.

3.4.1 Scenarios for dedicated leased circuit service configuration

Scenarios for dedicated leased circuit service configuration are described by using the following TMN management roles, telecommunication service/resource and TMN management functions.

Those TMN management roles are:

- service customer role; and
- service provider role.

That telecommunication service/resource is:

- dedicated leased circuit service.

Those TMN management functions are identified in 3.3.3.1: Dedicated leased circuit service configuration function set.

The functions identified in 3.3.3.2: Dedicated leased circuit service status administration function set may also be referred.

The following examples show configuration flows for dedicated leased circuit service.

3.4.1.1 Scenarios for dedicated leased circuit service creation

The SC shall identify the service to be provisioned, the customer contact within the organisation, and the originating and terminating location of the service, which are mandatory information.

SC -----> SP

Request to create a dedicated leased circuit service

{with service name, customer contact, originating location and terminating location}

The SP may inform the SC that the request has been received.

SC <----- SP

Acknowledge the creation request of a dedicated leased circuit service

{with provider request number }

If the service is established as requested, the SP may inform the SC of the provider request number, SP contact, service availability date, circuit number that is unique for the duration of the leased circuit service and, if any, other customer requested parameters for the confirmation.

SC <----- SP

Respond with success of the creation request of a dedicated leased circuit service

{with provider request number, SP contact, originating location SAP, terminating location SAP, service availability date, circuit number and other customer requested parameters}

When the time the service is available has come, the SP may inform that the service is activated and other information related to the requested leased circuit service.

SC <----- SP

Report creation of a dedicated leased circuit service

{with provider request number, SP contact, originating location SAP, terminating location SAP, circuit number and other information }

3.4.1.2 Scenarios for dedicated leased circuit service deletion

The SC shall uniquely identify an existing dedicated leased circuit service, which is desired to be released.

SC -----> SP

Request to delete a dedicated leased circuit service

{with circuit number }

The SP may inform the SC that the request was received.

SC <----- SP

Acknowledge the deletion request of a dedicated leased circuit service

{with provider request number }

When the deletion request is completed and the leased circuit service instance was terminated, the SP notifies the SC of the deletion.

SC <----- SP

Respond with success of the deletion request of a dedicated leased circuit service

{with circuit number }

SC <----- SP

Report deletion of a dedicated leased circuit service

{with circuit number and SP contact }

3.4.1.3 Scenarios for dedicated leased circuit service modification before the service being completed

The SC may request to modify the request parameters such as customer contact, alias name, original location CPE type, terminating location CPE type, bandwidth, route of an existing leased circuit service, schedule, service termination date, service availability date and service administrative state, depending on service name, service class and the contract. These can be also technology specific. In the case the SC would modify the parameters of the service creation request before the completion of the request, the SC uses provider request number to identify the service request.

SC -----> SP

Request to modify the request of a dedicated leased circuit service

{with provider request number, parameters to be modified and their values}

The SP informs the SC that the request was received.

SC <----- SP

Acknowledge the modification request of the request

{with provider request number and request sequence number }

If the modification request is complete as requested, the SP informs the SC of the provider request number and customer requested parameters for confirmation.

SC <----- SP

Respond with success of the modification request of the request

{with provider request number, request sequence number and customer requested parameters}

At the same time, the SP informs the SC of parameter changes by leased circuit service administrative function set.

SC <----- SP

Report parameter changes of a request of a dedicated leased circuit service

{with provider request number and changed parameters }

3.4.1.4 Scenarios for dedicated leased circuit service modification after the creation request completion

The SC may request to modify the service parameters such as customer contact, alias name, originating location SAP, terminating location SAP, originating location CPE type, and terminating location CPE type, bandwidth, route of an existing leased circuit service, schedule, service termination date and service administrative state, depending on service name, service class and the contract. These can be also technology specific. In the case the SC would modify the parameters of the activated leased circuit service, the SC uses circuit number to identify the leased circuit service.

SC -----> SP

Request to modify a dedicated leased circuit service

{with circuit number and the parameters to be modified and their values}

The SP informs the SC that the request was received.

SC <----- SP

Acknowledge the modification request of a dedicated leased circuit service

{with provider request number}

If the modification request is done as requested, the SP informs the SC of the circuit number and customer requested parameters for confirmation.

SC <----- SP

Respond with success of the modification request of a dedicated leased circuit service

{with provider request number, circuit number and customer requested parameters }

At the same time, the SP may inform the SC of parameter changes by leased circuit service administrative function set.

SC <----- SP

Report parameter changes of a dedicated leased circuit service

{with circuit number and changed parameters }

3.4.1.5 Scenarios for dedicated leased circuit service request cancellation

When the SC wants to cancel the request after the request was acknowledged, if the actual process of the request has not started, a cancel request from the SC may be accepted by the SP.

SC -----> SP

Request to create a dedicated leased circuit service

{with service name, customer contact, originating location and terminating location}

SC <----- SP
Acknowledge the creation request of a dedicated leased circuit service
{with provider request number}

SC -----> SP
Cancel the creation request of a dedicated leased circuit service
{with provider request number}

If the actual processing of the request has not started yet, the SP may cancel the request and inform the SC that the request was cancelled.

SC <----- SP
Respond with cancellation of the creation request of a dedicated leased circuit service
{with provider request number}

3.4.1.6 Scenarios for dedicated leased circuit service request negotiation

The SC requests the SP to create a leased circuit service.

SC -----> SP
Request to create a dedicated leased circuit service
{with service type, customer contact, originating location and terminating location}

The SP informs the SC of the acknowledgement of the request before analyzing the contents of the request.

SC <----- SP
Acknowledge the creation request of a dedicated leased circuit service
{with provider request number}

The SP starts to analyse whether the request can be satisfied or not. If the SP finds that the request cannot be satisfied or the SP wants to suggest more useful alternatives to the SC, the SP may inform the SC that the request is pending awaiting confirmation from the SC, with substituted parameters from the SP.

SC <----- SP
Respond with substitution of the creation request of a dedicated leased circuit service
{with provider request number, SP contact, originating location SAP, terminating location SAP, service availability date, circuit number, service request state = "preprocessing" and other customer requested parameters}

If the SC accepts the substituted parameters, the SC requests to modify the original request parameters with the substituted values.

SC -----> SP
Request to modify the request of a dedicated leased circuit service
{with provider request number, parameters to be modified and their values}

The SP may inform the SC of the acknowledgement of the modification request, and then starts to analyze it.

SC <----- SP
Acknowledge the modification request of the request
{with provider request number and request sequence number }

If the changed values of the parameters are within range of the substituted values by the SP, the negotiation is agreed and then the SP may resume the discontinued job. When the SC's request is completed, the SP informs the SC of the completion of the request.

SC <----- **SP**

Respond with success of the modification request of the request

{with provider request number, request sequence number and customer requested parameters}

3.4.2 Scenarios for leased circuit service status administration

Scenarios for leased circuit service status administration are described by using the following TMN management roles, telecommunication services and TMN management functions.

Those TMN management roles are:

- service customer role; and
- service provider role.

That telecommunication service is:

- leased circuit service.

Those TMN management functions are identified in 3.3.3.2: Dedicated leased circuit service status administration function set.

The functions identified in 3.3.3.1: Dedicated leased circuit service configuration function set may also be referred.

The following examples show administration flows for dedicated leased circuit service.

3.4.2.1 Scenarios for report creation of leased circuit service to service customer

A management scenario using the report creation of leased circuit service to service customer function is described in 3.4.1.1 and others. Refer to those subclauses.

3.4.2.2 Scenarios for report deletion of leased circuit service to service customer

A management scenario using the report deletion of leased circuit service to service customer is described in 3.4.1.2 and others. Refer to those subclauses.

3.4.2.3 Scenarios for report configuration change of leased circuit service parameters to the service customer

A management scenario using the report configuration change of leased circuit service parameters to service customer function is described in 3.4.1.4. Refer to that subclause.

3.4.2.4 Scenarios for report change of leased circuit service request parameters

A management scenario using the report change of leased circuit service request parameters function is described in 3.4.1.3. Refer to that subclause.

3.4.2.5 Scenarios for control leased circuit service administrative state by the service customer

The SC is able to control the service administrative state for some maintenance of the service. If the service was pre-provisioned, the SC may use this function to turn on the service.

SC -----> **SP**

Request to modify a leased circuit service

{with circuit number and service administrative state = "unlocked" }

If the request is completed, the SP responds to the SC with the results of the request.

SC <----- SP
Respond with success of modification request of a leased circuit service
{with circuit number and service administrative state = "unlocked" }

SC <----- SP
Report parameter changes of a dedicated leased circuit service
{with circuit number, service administrative state = "unlocked" }

3.4.2.6 Scenarios for retrieve leased circuit service parameters by the service customer

If the SC wants to retrieve the parameters of the leased circuit service after the completion of the service request, the SC requests the SP to retrieve the values of the desired parameters.

SC -----> SP
Request to retrieve parameters of a leased circuit service
{with circuit number and desired parameters }
SC <----- SP
Respond with success of the parameters retrieval request of a leased circuit service
{with circuit number and the values of the desired parameters }

3.4.2.7 Scenarios for monitor progress of the service request

If the SC wants to know the state of the request because of taking a long time until the completion of the request after the acknowledgement of the request, the SC requests the SP to notify the current state of the request.

SC -----> SP
Request to create a leased circuit service
{with service name, customer contact, originating location and terminating location}
SC <----- SP
Acknowledge the creation request of a leased circuit service
{with provider request number }

If the SC wants to know the state of the request, the SC requests the SP to notify the current state of the request.

SC -----> SP
Request to retrieve the state of a service request
{with provider request number }
SC <----- SP
Respond with success of state retrieval request of a service request
{with provider request number and service request state = "open/active" }

When the current processing creation request is completed, the SP may notify the SC of the completion of the creation request.

SC <----- SP
Respond with success of the creation request of a leased circuit service
{with provider request number, SP contact, circuit number and other customer requested parameters}

3.4.2.8 Scenarios for report progress of the leased circuit service request

The SP may report the progress of the service request to the SC if defined by the contract.

SC -----> SP

Request to create a leased circuit service

{with service name, customer contact, originating location and terminating location}

If the SP acknowledges the request and has checked for validity of the parameters of the request, the SP may inform the SC that the state of the request has moved to "open/active".

SC <----- SP

Acknowledge the creation request of a leased circuit service

{with provider request number }

SC <----- SP

Report the state change of the service request

{with provider request number and service request state = "open/active" }

During the processing of the service configuration, when the processing of the service configuration awaits additional information or completion of other supporting tasks, the SP may inform the SC that the state of the request has moved to "pending".

SC <----- SP

Report the state change of the service request

{with provider request number and service request state = "pending" }

When the processing resumes, the SP may inform the SC that the state of the request has moved to "open/active".

SC <----- SP

Report the state change of the service request

{with provider request number and service request state = "open/active" }

When the processing is completed, the SP may inform the SC that the state of the request has moved to "closed".

SC <----- SP

Report the state change of the service request

{with provider request number and service request state = "closed" }

SC <----- SP

Respond with success of the creation request of a leased circuit service

{with provider request number, SP contact, originating location SAP, terminating location SAP, service availability date, circuit number and other customer requested parameters}

3.4.2.9 Scenarios for retrieve leased circuit service request parameters

If the SC wants to retrieve the parameters of the request of the leased circuit service before the completion of the service request, the SC requests the SP to retrieve the values of the desired parameters.

SC -----> SP

Request to retrieve parameters of the request of a leased circuit service

{with provider request number and desired parameters}

SC <----- SP

**Respond with success of the parameters retrieval request of a request
{with provider request number and the values of the desired parameters }**

3.4.3 Scenarios for link connection configuration

Scenarios for link connection configuration are described by using the following TMN management roles, telecommunication service resource and TMN management functions.

Those TMN management roles are:

- service customer role; and
- service provider role.

That telecommunication service/resource is:

- link connection.

Those TMN management functions are identified in 3.3.3.3: Link connection configuration service function set.

The functions identified in 3.3.3.4: Link connection status administration function set may also be referred.

3.4.3.1 Scenarios for link connection creation

To create a Link connection, a service customer specifies the Link connection endpoints (CP or SN APs).

SC -----> SP

Request to create a link connection

{with service name, customer contact, originating location connection point name and terminating location connection point name }

The SP informs the SC that the request is received.

SC <----- SP

Acknowledge the creation request of a link connection

{with provider request number }

If the link connection is established as requested, the SP shall inform the SC of the completion of the request.

SC <----- SP

Respond with success of the creation request of a link connection

{with provider request number, SP contact, link connection identifier, originating location connection point name, terminating location connection point name, link connection availability date and other customer requested parameters}

When the time the link connection is available has come, the SP may inform the SC of request number, information related to the requested link connection and the link connection identifier.

SC <----- SP

Report creation of a link connection

{with provider request number, SP contact, originating location connection point, terminating location connection point, link connection identifier and other information }

3.4.3.2 Scenarios for link connection deletion

This function allows the SC to delete a link connection. Note before a Link connection can be deleted all LCs that are associated with the Link connection must be removed.

The SC shall uniquely identify an existing link connection, which is desired to be released.

SC -----> SP

Request to delete a link connection

{with link connection identifier}

The SP informs the SC that the request was received.

SC <----- SP

Acknowledge the deletion request of a link connection

{with provider request number}

When the deletion request is completed and the link connection is terminated, the SP notifies the SC of the deletion.

SC <----- SP

Respond with success of the deletion request of a link connection

{with link connection identifier }

SC <----- SP

Report deletion of a link connection

{with link connection identifier and SP contact }

3.4.3.3 Scenarios for link connection modification before the link connection being completed

The SC may request to modify the request parameters such as customer contact, link connection alias name, link connection bandwidth, link connection schedule, link connection termination date, link connection availability date and link connection administrative state, depending on service name, service class and the contract. These can be also technology specific. In the case the SC would modify the parameters of the link connection creation request before the completion of the request, the SC uses provider request number to identify the link connection request.

SC -----> SP

Request to modify the request of a link connection

{with provider request number, parameters to be modified and their values}

The SP informs the SC that the request was received..

SC <----- SP

Acknowledge the modification request of the request

{with provider request number and request sequence number }

If the modification request is done as requested, the SP may inform the SC of the provider request number and customer requested parameters for confirmation.

SC <----- SP

Respond with success of the modification request of the request

{with provider request number, request sequence number and customer requested parameters}

At the same time, the SP may inform the SC of parameter changes by link connection administrative function set.

SC <----- SP
Report parameter changes of a request of a link connection
{with provider request number and changed parameters }

3.4.3.4 Scenarios for link connection modification after the creation request completion

The SC may request to modify the link connection parameters such as customer contact, link connection alias name, link connection bandwidth, originating location connection point, terminating location connection point, link connection schedule, link connection termination date and link connection administrative state, depending on service name, service class and the contract. These can be also technology specific. In the case the SC would modify the parameters of the link connection after the completion of the request, the SC uses link connection identifier to identify the link connection. In the case the SC would modify the parameters of the activated link connection, the SC uses link connection identifier to identify the link connection.

The SC shall uniquely identify an existing link connection, which is desired to be modified.

SC -----> SP
Request to modify a link connection
{with link connection identifier and the parameters to be modified and their values }

The SP informs the SC that the request was received.

SC <----- SP
Acknowledge the modification request of a link connection
{with provider request number}

If the modification request is done as requested, the SP informs the SC of the circuit number and customer requested parameters for confirmation.

SC <----- SP
Respond with success of the modification request of a link connection
{with provider request number, link connection identifier and customer requested parameters }

At the same time, the SP may inform the SC of parameter changes by leased circuit service administrative function set.

SC <----- SP
Report parameter changes of a link connection
{with provider request number, link connection identifier and changed parameters }

3.4.3.5 Scenarios for link connection request cancellation

(Request cancelled case)

When the SC wants to cancel the request after the request was acknowledged, if the actual process of the request has not started, a cancel request from the SC may be accepted by the SP.

SC -----> SP
Request to create a link connection
{with service name, customer contact, originating location connection point name and terminating location connection point name }

SC <----- SP
Acknowledge the creation request of a link connection
{with provider request number }
SC -----> SP
Cancel the creation request of a link connection
{with provider request number}

If the actual processing of the request has not started yet, the SP may cancel the request and inform the SC that the request was cancelled.

SC <----- SP
Respond with cancellation of the creation request of a link connection
{with provider request number}

3.4.4 Scenarios for link connection status administration

Scenarios for link connection status administration are described by using the following TMN management roles, telecommunication service/resource and TMN management functions.

Those TMN management roles are:

- service customer role; and
- service provider role.

That telecommunication service/resource is:

- link connection.

Those TMN management functions are identified in 3.3.3.4: Link connection status administration function set.

The functions identified in 3.3.3.3: Link connection configuration service function set may also be referred

The following examples show administration flows on link connection.

3.4.4.1 Scenarios for report creation of link connection to service customer

A management scenario using the report creation of link connection to service customer function is described in 3.4.3.1 and others. Refer to those subclauses.

3.4.4.2 Scenarios for report deletion of link connection to service customer

A management scenario using the report deletion of link connection to service customer is described in 3.4.3.2 and others. Refer to those subclauses.

3.4.4.3 Scenarios for report configuration change of link connection parameters to service customer

A management scenario using the report configuration change of link connection parameters to service customer function is described in 3.4.3.4 and others. Refer to those subclauses.

3.4.4.4 Scenarios for report change of link connection request parameters

A management scenario using the report change of link connection request parameters function is described in 3.4.3.3 and others. Refer to those subclauses.

3.4.4.5 Scenarios for control link connection administrative state by the service customer

The SC is able to control the link connection administrative state for some maintenance of the link connection.

SC -----> SP

Request to modify a link connection

{with link connection identifier and link connection administrative state = "unlocked" }

If the request is completed, the SP responds to the SC with the results of the request.

SC <----- SP

Respond with success of modification request of a link connection

{with link connection identifier and link connection administrative state = "unlocked" }

SC <----- SP

Report parameter changes of a link connection

{with link connection identifier, link connection administrative state = "unlocked" }

3.4.4.6 Scenarios for retrieve link connection parameters

If the SC wants to retrieve the parameters of the link connection after the completion of the link connection request, the SC requests the SP to retrieve the values of the desired parameters.

SC -----> SP

Request to retrieve parameters of a link connection

{with link connection identifier and desired parameters }

SC <----- SP

Respond with success of the parameters retrieval request of a link connection

{with link connection identifier and the values of the desired parameters}

3.4.4.7 Scenarios for monitor progress of the link connection request

If the SC wants to know the state of the request because of taking a long time until the completion of the request after the acknowledgement of the request, the SC requests the SP to notify the current state of the request.

SC -----> SP

Request to create a link connection

{with service name, customer contact, originating location connection point name and terminating location connection point name}

SC <----- SP

Acknowledge the creation request of a link connection

{with provider request number }

If the SC wants to know the state of the request, the SC requests the SP to notify the current state of the request.

SC -----> SP

Request to retrieve the state of a link connection request

{with provider request number }

SC <----- SP

Respond with success of state retrieval request of link connection request
{with provider request number and link connection request state = "open/active" }

When the current processing creation request is completed, the SP may notify the SC of the completion of the creation request.

SC <----- SP

Respond with success of the creation request of a link connection
{with provider request number, SP contact, link connection identifier originating location connection point, terminating location connection point, link connection availability date and other customer requested parameters}

3.4.4.8 Scenarios for report progress of the link connection request

The SP may report the progress of the link connection request to the SC if defined by the contract.

SC -----> SP

Request to create a link connection
{with service name, customer contact, originating location connection point and terminating location connection point }

If the SP acknowledges the request and has checked validity of the parameters of the request, the SP may inform the SC that the state of the request has moved to "open/active".

SC <----- SP

Acknowledge the creation request of a link connection
{with provider request number }

SC <----- SP

Report the state change of the link connection request
{with provider request number and link connection request state = "open/active" }

During the processing of the link connection configuration, when the processing of the service configuration awaits additional information or completion of other supporting tasks, the SP may inform the SC that the state of the request has moved to "pending".

SC <----- SP

Report the state change of the link connection request
{with provider request number and link connection request state = "pending" }

When the processing resumes, the SP may inform the SC that the state of the request has moved to "open/active".

SC <----- SP

Report the state change of the link connection request
{with provider request number and link connection request state = "open/active" }

When the processing is completed, the SP may inform the SC that the state of the request has moved to "closed".

SC <----- SP

Report the state change of the link connection request
{with provider request number and link connection request state = "closed" }

SC <----- SP

Respond with success of the creation request of a link connection

{with provider request number, SP contact, link connection identifier, originating location connection point, terminating location connection point, link connection availability date, and other customer requested parameters}

3.4.4.9 Scenarios for retrieve link connection request parameters

If the SC wants to retrieve the parameters of the request of the link connection before the completion of the service request, the SC requests the SP to retrieve the values of the desired parameters.

SC -----> SP

Request to retrieve parameters of the request of a link connection

{with provider request number and desired parameters }

SC <----- SP

Respond with success of the parameters retrieval request of a request

{with provider request number and the values of the desired parameters }

3.4.5 Scenarios for service access domain configuration

Scenarios for service access domain configuration are described by using the following TMN management roles, telecommunication services/resources, and TMN management functions.

Those TMN management roles are:

- service customer role; and
- service provider role.

Those telecommunication services/resources are:

- service access domain;
- service access point; and
- service access group.

Those TMN management functions are identified in 3.3.3.7: Service access domain configuration function set.

3.4.5.1 Scenarios for service access domain creation

The SC may request the SP to create a service access domain with list of location.

SC -----> SP

Request to create a service access domain

{with customer contact, service name and service access domain identifier }

The SP informs the SC that the request is received.

SC <----- SP

Acknowledge the creation request of a service access domain

{with provider request number }

If the service access domain is established as requested, the SP informs the SC that the request is completed.

SC <----- SP

Respond with success of the creation request of a service access domain

{with provider request number, SP contact, service access domain identifier and other customer requested parameters}

3.4.5.2 Scenarios for service access group creation

The SC may request the SP to create a service access group with list of location.

SC -----> SP

Request to create a service access group

{with service access domain identifier and service access group identifier }

The SP informs the SC that the request is received.

SC <----- SP

Acknowledge the creation request of a service access group

{with provider request number }

If the service access group is established as requested, the SP informs the SC that the request is completed.

SC <----- SP

Respond with success of the creation request of a service access group

{with provider request number, SP contact, service access group identifier, service access domain identifier and other customer requested parameters}

3.4.5.3 Scenarios for service access group deletion

The SC may request the SP to delete a service access group.

SC -----> SP

Request to delete a service access group

{with service access group identifier}

If the service access group is able to be deleted, the SP informs the SC that the request is received.

SC <----- SP

Acknowledge the deletion request of a service access group

{with provider request number }

When the request is completed, the SP notifies the SC of the completion of the request.

SC <----- SP

Respond with success of the deletion request of a service access group

{with service access group identifier }

3.4.5.4 Scenarios for service access point addition to service access group

The SC may request the SP to add an access point into an existing service access group by identifying location.

SC -----> SP

Request to add a service access point to a service access group

{with service access group identifier and service access point identifier }

The SP informs the SC that the request is received.

SC <----- SP

**Acknowledge the addition request of a service access point to a service access group
{with provider request number}**

If the service access point is added as requested, the SP may inform the SC that the request is completed.

SC <----- SP

**Respond with success of the addition request of a service access point to a service access group
{with provider request number, service access group identifier and list of service access point identifiers}**

3.4.5.5 Scenarios for service access point removal from service access group

The SC may request the SP to remove a service access point from an existing service access group.

SC -----> SP

**Request to remove a service access point from a service access group
{with service access group identifier and service access point identifier to be removed}**

If the specified service access point is able to be removed, the SP informs the SC that the request is received.

SC <----- SP

**Acknowledge the removal request of a service access point from a service access group
{with provider request number }**

When the request is completed, the SP notifies the SC of the completion of the request.

SC <----- SP

**Respond with success of the removal request of a service access point from a service access group
{with service access group identifier and removed service access point identifier}**

3.4.6 Scenarios for access equipment status administration

Scenarios for access equipment status administration are described by using TMN management roles, telecommunication services and resources, and TMN management functions.

Those TMN management roles are:

- service customer role; and
- service provider role.

Those telecommunication services/resources are:

- access point; and
- access equipment.

Those TMN management functions are identified in 3.3.3.9: Access equipment status administration function set.

3.4.6.1 Scenarios for access equipment status update

The SC must be able to convey to the SP any information related to the access equipment that the SP may need in order to perform loop-back testing or any similar function agreed upon as part of the service. Such information may include the name of the manufacturer and the model type of the equipment.

SC -----> SP
Report parameter change of access equipment
{with location, service access point, and changed parameters}

The SP informs the SC that the request has been received.

3.4.6.2 Scenarios for access equipment status inquiry

The SP must be able to query the SC regarding the access equipment that may be needed in order to perform loop-back testing or any similar function agreed upon as part of the service. Such information may include the name of the manufacturer and the model type of the equipment. The SP must further be able to alert the SC if any (planned) change in the access equipment may cause changes to the way loop-back testing or any similar function agreed upon as part of the service is done.

SC <----- SP
Request to retrieve parameters of an access equipment
{with location, service access point, and desired parameters }

The SP informs the SC that the request has been received.

SC -----> SP
Respond with success of the parameter retrieval request of an access equipment
{with location, service access point, and the values of the desired parameters}

3.5 Architecture

3.5.1 Functional architecture

The architecture is described in Recommendation M.3010. Applicable reference points are x, and q3, between SML and SML, and q3 between SML and NML.

3.5.2 Physical Architecture

The architecture is described in Recommendation M.3010. Applicable interfaces are X and Q3.

4 Maintenance Management Service

4.1 Management service description

This management service addresses the management interface between the service provider domain and the service customer domain. It is based on an abstract view of the resources underlying a particular service, a view that shields the service user from knowledge of the specific technical implementation that supports the service. The specific resource managed by this management service is supporting Leased Circuit Services.

Management capability described by this management service enables service customers to detect faults or abnormal conditions of their leased circuits.

4.2 Management goals

The goal of this management service is:

- to monitor detected faults or abnormal condition near in real time;
- to control report of alarms and related information; and
- to get a summary of the current alarm conditions.

4.3 Management context description

4.3.1 Roles

4.3.2 Telecommunications services and resources

Telecommunications services and resources applicable to this management service are defined in 3.3.2.

4.3.3 Management functions

4.3.3.1 Alarm reporting function set

This subclause describes the Alarm Reporting functions provided by the services specified in this Recommendation and is a specialization of the alarm reporting function set of Recommendation M.3400 containing the following management functions:

- 1) report alarm;
- 2) route alarm report;
- 3) request alarm report route;
- 4) condition alarm reporting;
- 5) request alarm report control condition;
- 6) allow/inhibit alarm reporting;
- 7) request alarm history report;
- 8) delete alarm history report,

are applicable to the following resources supporting leased circuits services:

- 1) Leased Circuit Services (and specializations of Leased Circuit services).
- 2) Link Connections (and specializations of Link Connections).

4.3.3.2 Alarm log control function set

The log control function set of Recommendation M.3400 containing the following management functions:

- 1) allow/inhibit logging;
- 2) condition logging;
- 3) request log condition,

are applicable to alarm log control for Leased Circuit Services.

The requirements for the Alarm Reporting Function Set are as documented in Recommendation Q.821. Not all the probable causes in Recommendations X.733 and M.3100 are applicable for the service level.

4.3.3.3 Trouble reporting function set

The requirements for the Trouble reporting function set are as documented in Recommendation X.790.

4.3.3.4 Trouble report status change notification function set

The requirements for the Trouble reporting function set are as documented in Recommendation X.790.

4.3.3.5 Trouble information query function set

The requirements for the Trouble reporting function set are as documented in Recommendation X.790.

4.3.3.6 Trouble ticket creation notification function set

The requirements for the Trouble reporting function set are as documented in Recommendation X.790.

4.4 Management scenarios

4.5 Architecture

Architecture applicable to this management service is defined in 3.5.

APPENDIX I

Example enterprise viewpoint specification of Leased Circuit Service Management

I.1 Enterprise viewpoint specification

This Appendix presents an example of an Enterprise Viewpoint specification of the business requirements corresponding to TMN functions specified in the main body of this Recommendation. A number of initiatives to define a precise methodology for capturing requirements to TMN interoperable interfaces are underway in several ITU groups. The ITU-T G.851 methodology, using ODP-based principles, is one such approach and is used in this informative Appendix. However, efforts are underway in the TMN SG 4 to define a unified methodology. When this methodology, i.e. unified precise methodology, is finalized by the new effort in the TMN SG 4, future revisions of this Recommendation will be specified using this unified approach in normative text.

A major benefit of this recast of the requirements using the enterprise language is that each requirement statement is given a scoped identifier (policy tag), which will facilitate correspondence statements from the Information and Computational interface specifications to corresponding policy statements in the requirements.

The purpose of this Appendix is to demonstrate, by example, how the requirements in this Recommendation can be recast as an enterprise viewpoint specification by adding policy tags (scoped identifiers) for each requirement statement. For purposes of brevity, this example is not complete. It outlines an enterprise specification corresponding to the Dedicated leased circuit service configuration function set, in 3.3.3.1. It includes detailed text for only one function, and only one activity.

I.2 Dedicated Leased Circuit Service Configuration Community (dLCSc)

I.2.1 Purpose

The objective of the community is to configure a Leased Circuit Service, where the leased circuit is provisioned through operations on interfaces available to the customer of the service. The Service Customer must be able to request the creation and deletion of fixed and variable Dedicated Leased Circuit Services, as well as the modification of variable dedicated leased circuits, and be notified of the completion of the creation, deletion, or modification request.

I.2.2 Enterprise roles

I.2.2.1 Active roles

Service Customer (SC)

The service customer (customer) is the organization which has a business relationship with the service provider for the provision of Leased Circuit Services to one or more end users. There is only one service customer in this community.

Service Provider (SP)

The service provider (provider) provides the Leased Circuit Service, or a component thereof, to the service customer. The service provider may be, but does not have to be, the administrator of the network(s) over which the Leased Circuit Service, or some component thereof, is provided. For this community, only one service provider receives the action requests to provide the Leased Circuit Service to the service customer.

I.2.2.2 Resource roles

Service access point

The location at which the basic Leased Circuit Service is delivered to the service customer. An access point is an abstraction of the underlying technology that supports the Leased Circuit Service which is visible to the service provider. Zero or more service access point role occurrences may exist in the community.

Leased Circuit Service (LCS)

A telecommunication service instance that provides for the transmission of information between two access points or connection points. The transmission path used to provide the service must meet the parameters and conditions specified as part of the service. The technology that supports the transmission path may use one or more technologies, as long as the service parameters and conditions for the service are met. Zero or more circuit role occurrences may exist in the community.

I.2.3 Community Policy

OBLIGATION OBLG_1

The SC must be able to request the creation and deletion of Dedicated Leased Circuit Services, as well as the modification of dedicated leased circuits, and be notified of the completion of the creation, deletion, or modification request.

I.2.4 Enterprise actions

I.2.4.1 Create Dedicated Leased Circuit Service (cDLCS)

This action allows the SC to request the creation of one or more Dedicated Leased Circuit Services.

ACTION POLICY

OBLIGATION SCInputs

The SC shall identify the service to be provisioned, and service features (as specified in the Information Flow requirements below), the service availability date requested, the customer contact within the organization, and relevant information about the originating and terminating locations of the service (see Information Flow requirements below for more detailed rules). The SC may also specify the route of the requested service and a user identifier for the requested leased circuit.

OBLIGATION SPInformation

In case of service establishment, the service provider shall inform the service customer with information related to service circuit and the service access points (as specified in Information Flow requirements below).

PERMISSION SPCustomerIdReject

The SP may permit the inclusion of a user identifier in the request. The SP may reject the request if the user identifier is ambiguous in some context.

OBLIGATION SPavailCases

The Service Provider shall, subject to community contract negotiation, make available one or more of the following cases for service creation:

- 1) The SC is given only an external view of the circuit associated with the service and creates a simple circuit without knowledge of its supporting internal structure.
- 2) The SC has a view of the internal structure of the circuit associated with the service, and specifies the route the circuit will take (routeSpec).
- 3) The SC has an internal view of the circuit associated with the service, but does not specify the route the circuit will take (internalView). In this case, the provider will return the route to the customer.

PERMISSION SCcustRouteSpec

In the routeSpec case, the SC may specify in the request the route the leased circuit service will take.

PERMISSION SCInternalView

In the internalView case, the SC may request a view of the internal structure of the leased circuit service associated with the service, without specifying the route.

OBLIGATION SPprovRoute

If custRouteSpec is not contracted as part of the service, the service provider will provide the route.

OBLIGATION SPprovView

If custRouteSpec or custInternalView are part of the contracted service, then the SP shall inform the SC of the route the leased circuit service will take.

Information Flow requirements

The Information Flow requirements for this action, for both the Service Customer, and the service provider, are specified in 3.3.3.1.1.2. In this subclause, these individual information element requirements are named as obligations, permissions, or prohibitions on a specific role in the community. The text for the policy statement can be found in the fourth column of the table of 3.3.3.1.1.2.

Policies on Service Customer supplied information parameters

OBLIGATION	SC_ServiceName
PERMISSION	SC_ServiceClass
PERMISSION	SC_Bandwidth
PERMISSION	SC_Quantity
PERMISSION	SC_ServiceTerminationDate
PERMISSION	SC_Schedule
PERMISSION	SC_ServiceAvailabilityDate
PERMISSION	SC_ServiceAdministrativeState
PERMISSION	SC_Diversity
PERMISSION	SC_Route
OBLIGATION	SC_OriginatingLocation
OBLIGATION	SC_TerminatingLocation
PERMISSION	SC_OriginatingLocationCPEType
PERMISSION	SC_TerminatingLocationCPEType
OBLIGATION	SC_CustomerContactInformation
PERMISSION	SC_CustomerRequestNumber
PERMISSION	SC_AliasName
OBLIGATION	SC_OriginatingLocationServiceAccessPoint
OBLIGATION	SC_TerminatingLocationServiceAccessPoint

Policies on Service Provider supplied information parameters

PERMISSION	SP_ServiceName
OBLIGATION	SP_ServiceClass
OBLIGATION	SP_Bandwidth
OBLIGATION	SP_Quantity
OBLIGATION	SP_ServiceTerminationDate
OBLIGATION	SP_Schedule
OBLIGATION	SP_ServiceAvailabilityDate
OBLIGATION	SP_ServiceRequestState
PERMISSION	SP_ServiceAdministrativeState
PERMISSION	SP_ServiceOperationalState

OBLIGATION	SP_Diversity
PERMISSION	SP_Route
PERMISSION	SP_OriginatingLocation
PERMISSION	SP_TerminatingLocation
PERMISSION	SP_OriginatingLocationCPEType
PERMISSION	SP_TerminatingLocationCPEType
PERMISSION	SP_CustomerContactInformation
OBLIGATION	SP_ProviderRequestNumber
PERMISSION	SP_CustomerRequestNumber
PERMISSION	SP_AliasName
OBLIGATION	SP_OriginatingLocationServiceAccessPoint
OBLIGATION	SP_TerminatingLocationServiceAccessPoint
OBLIGATION	SP_CircuitNumber
OBLIGATION	SP_SPContact
OBLIGATION	SP_ErrorAndReasonCode

I.2.4.2 Cancel Dedicated Leased Circuit Service Request (cDLCSR)

<action details not shown for brevity of example>

I.2.4.3 Delete Dedicated Leased Circuit Service (dDLCS)

<action details not shown for brevity of example>

I.2.4.4 Modify Dedicated Leased Circuit Service (mDLCS)

<action details not shown for brevity of example>

I.2.5 Activities

These activities make use of the Report actions from the Dedicated leased circuit service administration community.

I.2.5.1 Dedicated Leased Circuit Service creation (DLCS_c)

SC uses the Create Dedicated Leased Circuit function to request the creation of a LCS from SP.

The response from the SP may be either:

- a) An acknowledgment with a Provider Request Number indicating the receipt of the create function request. The completion of processing of the service request will be reported to the customer at a later time, following processing of the create function request using the Report Creation function.
- b) Completion response indicating that the create function request has been processed coincident with receipt of the request and that all information defined in the SP column of the Table for the Information Flows contained in 3.3.3.1.1.2 has been filled in and available.
- c) The Create request has been rejected with a reason code indicating probable cause.

If b) or c), then this function is completed. If a), then the following interactions are possible:

- i) SP responds to the SC with information regarding the progress of the request using the Report Progress of the service request function of the Service Administrative Function Set.
- ii) the SC may inquire about the progress of the request using the Monitor progress of the service request function of the Service Administrative function set.
- iii) SP informs the SC upon the successful completion of the Create request using the Report creation of LCS to service customer function of the Service Administrative function set.
- iv) SP informs the SC upon a failure in the processing of the Create request, using the Report Progress of service request function of the Service Administrative function with a reason code indicating probable cause of the failure.

Item iii) or iv) signals completion of the function. The valid interactions are determined by the state model shown in Figure 4. Table 1 depicts the request state transition and the valid operations within each state.

I.2.5.2 Dedicated Leased Circuit Service modification (DLCSm)

<activity details not shown for brevity of example>

I.2.5.3 Dedicated Leased Circuit Service deletion (DLCSd)

<activity details not shown for brevity of example>

I.2.6 Contract

Service features are subject to negotiation as part of a service contract.

The options in the information requirements are subject to service contract negotiation.

APPENDIX II

Management scenario examples

II.1 Other scenarios for dedicated leased circuit service configuration

II.1.1 Other scenarios for dedicated leased circuit service creation

Example 1: Simple case

The SC shall identify the service to be provisioned, the customer contact within the organization and the originating and terminating location of the service, which are mandatory information.

SC -----> SP

Request to create a dedicated leased circuit service

{with service name, customer contact, originating location and terminating location}

The SP informs the SC of the completion of the request.

SC <----- SP

Respond with success of the creation request of a dedicated leased circuit service

{with provider request number, SP contact, originating location SAP, terminating location SAP, service availability date, circuit number and other customer requested parameters}

Example 2: Request acknowledge responded case

The SC shall identify the service to be provisioned, the customer contact within the organization and the originating and terminating location of the service, which are mandatory information.

SC -----> SP

Request to create a dedicated leased circuit service

{with service name, customer contact, originating location and terminating location}

The SP informs the SC that the request is received, prior to the actual processing of the request by the SP.

SC <----- SP

Acknowledge the creation request of a dedicated leased circuit service

{with provider request number }

If the service is established as requested, the SP may inform the SC of the completion of the request.

SC <----- SP

Respond with success of the creation request of a dedicated leased circuit service

{with provider request number, SP contact, originating location SAP, terminating location SAP, service availability date, circuit number and other customer requested parameters}

Example 3: Request rejected case

The SC shall identify the service to be provisioned, the customer contact within the organization and the originating and terminating location of the service, which are mandatory information.

SC -----> SP

Request to create a dedicated leased circuit service

{with service name, customer contact, originating location and terminating location}

If the request is not accepted because of parameter error, the SP may inform the SC that the request was rejected. In this case, the actual processing does not start.

SC <----- SP

Reject the creation request of a dedicated leased circuit service

{with provider request number, SP contact and the reasons for rejection}

When the request was rejected due to parameter errors and the SC wants to retry, the SC re-initiates from the beginning after correcting the parameter errors.

SC -----> SP

Request to create a dedicated leased circuit service

{with service name, customer contact, originating location and terminating location}

SC <----- SP

Acknowledge the creation request of a dedicated leased circuit service

{with provider request number }

Example 4: Request failed case

The SC shall identify the service to be provisioned, the customer contact within the organization and the originating and terminating location of the service, which are mandatory information.

SC -----> SP

Request to create a dedicated leased circuit service

{with service name, customer contact, originating location and terminating location}

If the request is acknowledged, the SP informs the SC that the request is received, prior to the actual processing of the request by the SP.

SC <----- SP
Acknowledge the creation request of a dedicated leased circuit service
{with provider request number }

If the requested service failed to be established, the SP informs the SC that the request failed ,with the provider request number, SP contact and reasons for the failure.

SC <----- SP
Respond with in-completion of the creation request of a dedicated leased circuit service
{with provider request number, SP contact and the reasons for in-completion }

II.1.2 Other scenarios for dedicated leased circuit service creation with specifying alias name

This example shows a scenario in the case the SC specifies the alias name defined in 3.3.3.1.2.

As the circuit number is only assigned by the SP, if the SC wants to use the special name for the leased circuit being created by this request, the SC uses Alias name for it.

SC -----> SP
Request to create a dedicated leased circuit service
{with alias name and the mandatory parameters}

The SP informs the SC that the request is received.

SC <----- SP
Acknowledge the creation request of a dedicated leased circuit service
{with provider request number }

If the service is established as requested, the SP informs the SC of the provider request number, SP contact, circuit number that is unique for the duration of the leased circuit service and, if any, other customer requested parameters for the confirmation.

SC <----- SP
Respond with success of the creation request of a dedicated leased circuit service
{with provider request number, SP contact, originating location SAP, terminating location SAP, service availability date, circuit number, alias name and other customer requested parameters}

When the time the service availability date is reached, the SP informs the SC that the service is activated and other information related to the requested leased circuit service.

SC <----- SP
Report creation of a dedicated leased circuit service
{with provider request number, SP contact, originating location SAP, terminating location SAP, circuit number, alias name and other information }

II.1.3 Other scenarios for dedicated leased circuit service creation with specifying the route

The following examples show scenarios in which the SC specifies the desired route of the leased circuit service. At service creation the SP makes available to the SC one of the following three options for the route specification.

- 1) The SC specifies the endpoints and the SP does not provide any information related to the route of the leased circuit.

SC -----> SP

Request to create a dedicated leased circuit service

{with service name, customer contact, service availability date, originating location and terminating location }

The SP informs the SC that the request is received.

SC <----- SP

Acknowledge the creation request of a dedicated leased circuit service

{with provider request number }

If the service is established as requested, the SP may inform the SC of the completion of the request.

SC <----- SP

Respond with success of the creation request of a dedicated leased circuit service

{with provider request number, SP contact, originating location SAP, terminating location SAP, service availability date, circuit number and other customer requested parameters}

When the service availability date is reached, the SP informs the SC that the service is activated and other information related to the requested leased circuit service.

SC <----- SP

Report creation of a dedicated leased circuit service

{with provider request number, SP contact, originating location SAP, terminating location SAP, circuit number and other information }

- 2) The SC specifies the endpoints and some information on the route the leased circuit should take.

SC -----> SP

Request to create a dedicated leased circuit service

{with service name, customer contact, service availability date, origination location SAP, termination location SAP and a sequence of topological entities determining the route }

If the route specification by SC or the view of the internal structure are part of the contracted service, then the SP informs the SC of the receipt of the request.

SC <----- SP

Acknowledge the creation request of a dedicated leased circuit service

{with provider request number }

If the service is established as requested, the SP informs the SC of the completion of the request.

SC <----- SP

Respond with success of the creation request of a dedicated leased circuit service

{with provider request number, SP contact, service availability date, circuit number, originating location SAP, terminating location SAP, a sequence of topological entities determining the route and other customer requested parameters}

When the service availability date is reached, the SP informs the SC of the service activation of the request.

SC <----- SP

Report creation of a dedicated leased circuit service

{with provider request number, SP contact, originating location SAP, terminating location SAP, circuit number, a sequence of topological entities determining the route and other information }

3) The SC specifies the endpoints but does not specify the route. The provider provides the SC with some view of the route.

The SC may request a view of the internal structure of the leased circuit associated with the service, without specifying the route.

SC -----> SP

Request to create a dedicated leased circuit service

{with service name, customer contact, service availability date, originating location and terminating location}

The SP informs the SC that the request is received.

SC <----- SP

Acknowledge the creation request of a dedicated leased circuit service

{with provider request number }

If the service is established as requested, the SP informs the SC of the completion of the request.

SC <----- SP

Respond with success of the creation request of a dedicated leased circuit service

{with provider request number, SP contact, service availability date, circuit number, originating location SAP, terminating location SAP, a sequence of topological entities determining the route and other customer requested parameters}

When the service availability date is reached, the SP informs the SC of the service activation of the request.

SC <----- SP

Report creation of a dedicated leased circuit service

{with provider request number, SP contact, originating location SAP, terminating location SAP, circuit number and other information }

II.1.4 Other scenarios for dedicated leased circuit service creation with specifying service characteristics

The SP may permit the SC to specify service characteristics (e.g. directionality, channelization, signalling option, protection, etc.) associated with a leased circuit service. A profile of service characteristic is given by the service class parameter.

SC -----> SP

Request to create a dedicated leased circuit service

{with service name, service class, customer contact, service availability date, originating location and terminating location}

In all cases of service creation, if service characteristics are part of the contracted service and if the SP cannot satisfy the need, then the SP rejects the request and informs the SC of the rejection.

SC <----- SP

Reject the creation request of a dedicated leased circuit service

{with provider request number, SP contact and the reasons for rejection }

II.1.5 Other scenarios for dedicated leased circuit service creation with specifying diverse routing

The SP may provide the ability for the SC to specify that the leased circuit should be diverse from other existing leased circuits.

The SC may specify that a leased circuit should be diverse from other existing leased circuits.

SC -----> SP

Request to create a dedicated leased circuit service

{with service name, customer contact, service availability date, originating location, terminating location, circuit number of an existing leased circuit (one or more), service access group of the set of service access points for diversity (one or more) }

If diverse routing is part of the contracted service, then the SP will attempt to select a route and underlying network elements that are not common to both the new leased circuit and the existing leased circuit.

SC <----- SP

Acknowledge the creation request of a dedicated leased circuit service

{with provider request number }

If the service is established as requested, the SP informs the SC of the completion of the request. In the case where the SP provides the SC with the internal view, the route of new leased circuit is provided to the SC.

SC <----- SP

Respond with success of the creation request of a dedicated leased circuit service

{with provider request number, SP contact, service availability date, circuit number, originating location SAP, terminating location SAP, a sequence of topological entities determining the route of the diverse leased circuit and other customer requested parameters}

When the service availability date is reached, the SP informs the SC of the service activation of the request.

SC <----- SP

Report creation of a dedicated leased circuit service

{with provider request number, SP contact, originating location SAP, terminating location SAP, circuit number, a sequence of topological entities determining the route and other information }

II.1.6 Other scenarios for multiple dedicated leased circuits service creation

The SC may need the ability to request simultaneously the creation of two or more leased circuits.

In addition, the SC may request that some or all of the requested leased circuits are routed diversely from each other.

SC -----> SP

Request to create multiple dedicated leased circuit services

{with service name, customer contact, service availability date, originating location terminating location, diversity and quantity}

The SP informs the SC that the request was received.

SC <----- SP
Acknowledge the creation request of multiple dedicated leased circuit services
{with provider request number }

If the service is established as requested, the SP informs the SC of the completion of the request.

SC <----- SP
Respond with success of the creation request of multiple dedicated leased circuit services
{with provider request number, SP contact and other customer requested parameters }

When the service availability date is reached, the SP informs the SC of the service activation of the request.

SC <----- SP
Report creation of a dedicated leased circuit service
{with provider request number, SP contact, originating location SAP, terminating location SAP, circuit number and other information }

.
.
.

SC <----- SP
Report creation of a dedicated leased circuit service
{with provider request number, SP contact, originating location SAP, terminating location SAP, circuit number and other information }

II.1.7 Other scenarios for dedicated leased circuit service deletion with specifying service termination date

The SC shall uniquely identify an existing leased circuit resource, which is desired to be released.

SC -----> SP
Request to delete a dedicated leased circuit service
{with circuit number and service termination date}

The SP informs the SC that the request was received..

SC <----- SP
Acknowledge the delete request of a dedicated leased circuit service
{with provider request number}

When the deletion request is completed, the SP notifies the SC of the deletion.

SC <----- SP
Respond with success of the deletion request of a dedicated leased circuit service
{with circuit number}

When the leased circuit service is terminated when the service termination date is reached, the SP informs the SC of the termination of the LCS.

SC <----- SP
Report deletion of a dedicated leased circuit service
{with circuit number and SP contact }

II.1.8 Other scenarios for dedicated leased circuit service request cancellation

(Cancel request rejected case)

When the SC requests to cancel an existing request after the request was acknowledged by the SP, if the actual processing of the request has started, a cancel request from the SC may be rejected by the SP.

SC -----> SP
Request to create a dedicated leased circuit service
{with service name, customer contact, originating location and terminating location}

SC <----- SP
Acknowledge the creation request of a dedicated leased circuit service
{with provider request number}

SC -----> SP
Cancel the creation request of a dedicated leased circuit service
{with provider request number}

If the actual processing of the request has started, the SP informs the SC that the request could not be cancelled. In this case, the SC has to use deletion function instead of cancel request function after the completion of the request.

SC <----- SP
Reject the cancel request
{with provider request number and error }

When the service is established as firstly requested, the SP informs the SC of the completion of the request.

SC <----- SP
Respond with success of the creation request of a dedicated leased circuit service
{with provider request number, SP contact, originating location SAP, terminating location SAP, service availability date, circuit number and other customer requested parameters}

SC -----> SP
Request to delete a dedicated leased circuit service
{with circuit number}

The SP informs the SC that the request was received..

SC <----- SP
Acknowledge the deletion request of a dedicated leased circuit service
{with provider request number}

When the leased circuit service is terminated, the SP notifies the SC of the termination.

SC <----- SP
Respond with success of the deletion request of a dedicated leased circuit service
{with circuit number }

II.1.9 Other scenarios for dedicated leased circuit service request negotiation

Example 1: Negotiation disagreed case

The SC requests the SP to create a leased circuit service.

SC -----> SP

Request to create a dedicated leased circuit service

{with service type, customer contact, originating location and terminating location}

The SP informs the SC of the receipt of the request before analyzing the contents of the request.

SC <----- SP

Acknowledge the creation request of a dedicated leased circuit service

{with provider request number}

The SP starts to analyze whether the request can be satisfied or not. If the SP finds that the request cannot be satisfied, or the SP wants to suggest more useful alternatives to the SC, the SP informs the SC that the request is pending, with substituted parameters.

SC <----- SP

Respond with substitution of the creation request of a dedicated leased circuit service

{with provider request number, SP contact, originating location SAP, terminating location SAP, service availability date, circuit number, service request state = "preprocessing" and other customer requested parameters}

If the SC cannot accept the substituted parameters, the SC may cancel the original request.

SC -----> SP

Cancel the creation request of a dedicated leased circuit service

{with provider request number}

The SP notifies the SC of the cancellation of the request.

SC <----- SP

Respond with cancellation of the request of a leased circuit service

{with provider request number}

Example 2: Negotiation repeated case

The SC requests the SP to create a leased circuit service.

SC -----> SP

Request to create a dedicated leased circuit service

{with service type, customer contact, originating location and terminating location}

The SP informs the SC of the receipt of the request before analyzing the contents of the request.

SC <----- SP

Acknowledge the creation request of a dedicated leased circuit service

{with provider request number}

The SP starts to analyze whether the request can be satisfied or not. If the SP finds that the request cannot be satisfied, or the SP wants to suggest more useful alternatives to the SC, the SP informs the SC that the request is pending, with substituted parameters.

SC <----- SP

Respond with substitution of the creation request of a dedicated leased circuit service

{with provider request number, SP contact, originating location SAP, terminating location SAP, service availability date, circuit number, service request state = "preprocessing" and other customer requested parameters}

If the SC cannot accept the substituted parameters and wants to request again with other parameters, the SC may request to modify the original request parameters with substituted values.

SC -----> SP

Request to modify the request of a dedicated leased circuit service

{with provider request number, parameters to be modified and their values}

The SP informs the SC of the receipt of the request before analyzing the contents of the request.

SC <----- SP

Acknowledge the modification request of the request

{with provider request number and request sequence number }

The SP starts to analyze whether the request can be satisfied or not. If the SP finds that the request cannot be satisfied or the SP wants to suggest more useful alternatives to the SC, the SP informs the SC that the request is pending, with other substituted parameters.

SC <----- SP

Respond with substitution of the creation request of a dedicated leased circuit service

{with provider request number, SP contact, originating location SAP, terminating location SAP, service availability date, circuit number, service request state = "preprocessing" and other customer requested parameters}

II.2 Other scenarios for link connection configuration

II.2.1 Other scenarios for link connection request cancellation

(Cancel request rejected case)

When the SC wants to cancel the request after the request was acknowledged, if the actual processing of the request has started, a cancel request from the SC may be rejected by the SP.

SC -----> SP

Request to create a link connection

{with service name, customer contact, originating location connection point name and terminating location connection point name }

SC <----- SP

Acknowledge the creation request of a link connection

{with provider request number }

SC -----> SP

Cancel the creation request of a link connection

{with provider request number}

If the actual processing of the request has started, the SP informs the SC that the request could not be cancelled. In this case, the SC has to use deletion function instead of cancel request function after the completion of the request.

SC <----- SP
Reject the cancel request
{with provider request number and error}

When the service is established as requested, the SP informs the SC of the completion of the request.

SC <----- SP
Respond with success of the creation request of a link connection
{with provider request number, SP contact, link connection identifier, originating location connection point name, terminating location connection point name, link connection availability date and other customer requested parameters}

SC -----> SP
Request to delete a link connection
{with link connection identifier}

The SP informs the SC that the request was received.

SC <----- SP
Acknowledge the deletion request of a link connection
{with provider request number }

When the link connection is terminated, the SP notifies the SC of the termination.

SC <----- SP
Respond with success of the deletion request of a link connection
{with link connection identifier }

APPENDIX III

Topological configuration examples

III.1 Introduction

This Appendix illustrates some possible topological configurations for the LCS. The figures are simple diagrams of the Leased Circuit Service, showing only those topological entities that the service customer is made aware of by the service provider. They are not meant to be complete representations of the G.805 connectivity model.

Whereas some cases clearly involve service level information, other cases also involve, to various degrees, the service level realization of network level information. This Appendix illustrates the relationships among various information elements from the service, network and network element level that may be exchanged between the service customer and the service provider.

III.2 Simple circuit through one network

This example shows a simple view of the service. The service customer can specify (e.g. in a service request), and is aware of, only the two access points at which the service terminates. The service is completely provided through a single service network. The provided service, a Leased Circuit, is represented, in Figure III.1, as a trail between two access points at two different customer locations.

A circuit is characterized by the characteristic information that it carries, its Quality of Service parameters, and possibly other characteristics.

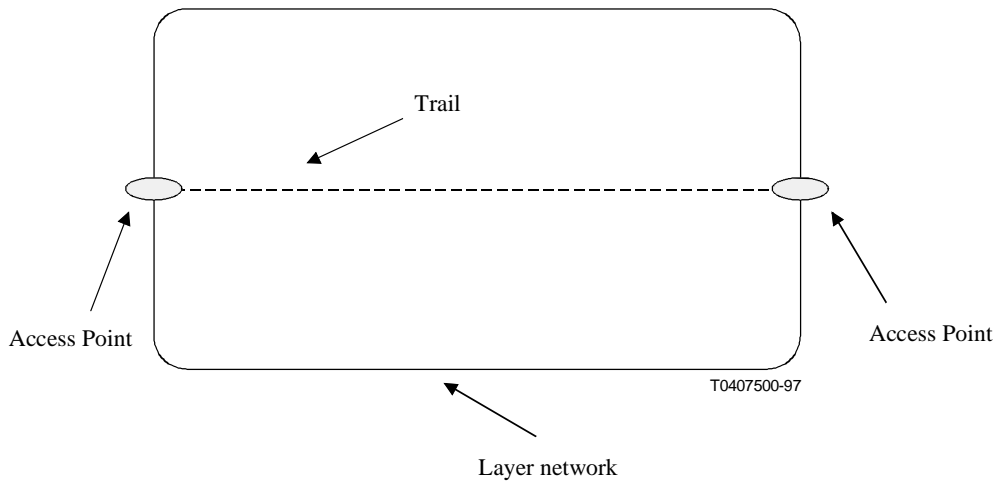

Figure III.1/M.3208.1

III.3 Single network with path specification

In this example, the service customer specifies, in the service request, the two access points at which the service terminates as well as an intermediate sub-network, within the service network, that the trail is constrained to pass through. In Figure III.2, the Leased Circuit is represented as a trail which is set up to pass through a customer specified intermediate sub-network. None of the details of the topology of how the network sets up connections to reach the sub-network from each access point are shown in the simple figure. The specified intermediate sub-network is chosen from a set supplied by the service provider. In this example, the service customer is not aware of the particular sub-network connection through the intermediate sub-network, or any of the links or sub-network connections used to reach the intermediate sub-network.

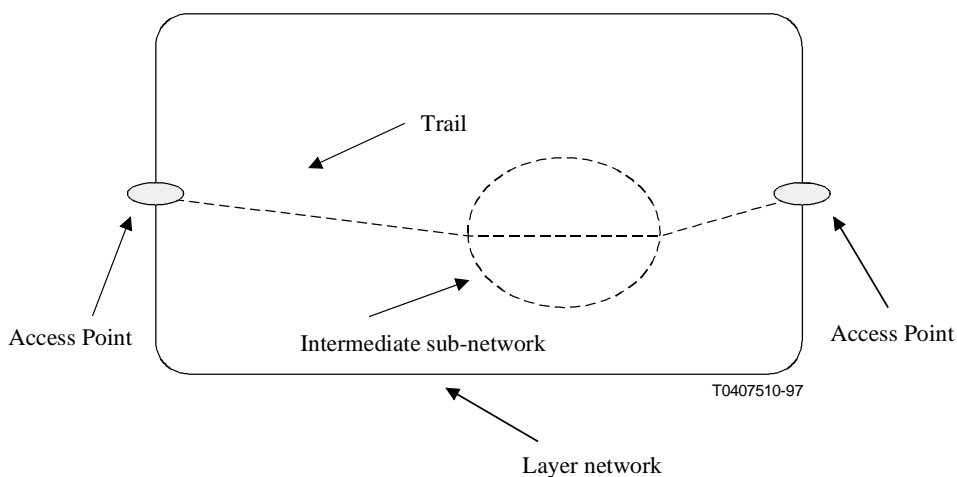

Figure III.2/M.3208.1

This view can be used, for example, when the service customer specifies that the circuit passes through a specific geographical location represented by the intermediate sub-network.

ITU-T RECOMMENDATIONS SERIES

- Series A Organization of the work of the ITU-T
- Series B Means of expression: definitions, symbols, classification
- Series C General telecommunication statistics
- Series D General tariff principles
- Series E Overall network operation, telephone service, service operation and human factors
- Series F Non-telephone telecommunication services
- Series G Transmission systems and media, digital systems and networks
- Series H Audiovisual and multimedia systems
- Series I Integrated services digital network
- Series J Transmission of television, sound programme and other multimedia signals
- Series K Protection against interference
- Series L Construction, installation and protection of cables and other elements of outside plant
- Series M TMN and network maintenance: international transmission systems, telephone circuits, telegraphy, facsimile and leased circuits**
- Series N Maintenance: international sound programme and television transmission circuits
- Series O Specifications of measuring equipment
- Series P Telephone transmission quality, telephone installations, local line networks
- Series Q Switching and signalling
- Series R Telegraph transmission
- Series S Telegraph services terminal equipment
- Series T Terminals for telematic services
- Series U Telegraph switching
- Series V Data communication over the telephone network
- Series X Data networks and open system communication
- Series Z Programming languages