



INTERNATIONAL TELECOMMUNICATION UNION

**ITU-T**

TELECOMMUNICATION  
STANDARDIZATION SECTOR  
OF ITU

**M.60**

(03/93)

**MAINTENANCE: INTRODUCTION AND GENERAL  
PRINCIPLES OF MAINTENANCE AND  
MAINTENANCE ORGANIZATION**

---

**MAINTENANCE TERMINOLOGY  
AND DEFINITIONS**

**ITU-T Recommendation M.60**

(Previously "CCITT Recommendation")

---

## FOREWORD

The ITU Telecommunication Standardization Sector (ITU-T) is a permanent organ of the International Telecommunication Union. The ITU-T is responsible for studying technical, operating and tariff questions and issuing Recommendations on them with a view to standardizing telecommunications on a worldwide basis.

The World Telecommunication Standardization Conference (WTSC), which meets every four years, established the topics for study by the ITU-T Study Groups which, in their turn, produce Recommendations on these topics.

ITU-T Recommendation M.60 was revised by the ITU-T Study Group IV (1988-1993) and was approved by the WTSC (Helsinki, March 1-12, 1993).

---

## NOTES

1 As a consequence of a reform process within the International Telecommunication Union (ITU), the CCITT ceased to exist as of 28 February 1993. In its place, the ITU Telecommunication Standardization Sector (ITU-T) was created as of 1 March 1993. Similarly, in this reform process, the CCIR and the IFRB have been replaced by the Radiocommunication Sector.

In order not to delay publication of this Recommendation, no change has been made in the text to references containing the acronyms "CCITT, CCIR or IFRB" or their associated entities such as Plenary Assembly, Secretariat, etc. Future editions of this Recommendation will contain the proper terminology related to the new ITU structure.

2 In this Recommendation, the expression "Administration" is used for conciseness to indicate both a telecommunication administration and a recognized operating agency.

© ITU 1994

All rights reserved. No part of this publication may be reproduced or utilized in any form or by any means, electronic or mechanical, including photocopying and microfilm, without permission in writing from the ITU.

## CONTENTS

	<i>Page</i>
1 General terms .....	1
2 Telecommunications management network (TMN).....	2
3 Quality, availability, reliability, dependability.....	16
4 Transmission .....	19
5 Switching and signalling .....	29
6 Integrated services digital network (ISDN).....	30
7 Testing, monitoring points, alarms.....	32

## INTRODUCTION

This Recommendation consists primarily of those terms and definitions that are considered essential to the understanding of the maintenance of networks and services. Reference is provided to relevant Recommendations or other international standards from which these terms are derived.

The terms are associated with a clause number. Within each clause terms are not necessarily listed in alphabetical order. Annex A presents the list of terms in alphabetical order with the clause number.

Annex B consists of a listing of abbreviations and acronyms.

Annex C shows Figures that are associated with definitions in this Recommendation.

### **Keywords**

Maintenance, terminology and definition

## **MAINTENANCE TERMINOLOGY AND DEFINITIONS**

*(Melbourne 1988; revised at Helsinki, 1993)*

### **1 General terms**

- 1000 **automatic maintenance:** Maintenance accomplished without human intervention.
- 1001 **bearer service:** A type of telecommunication service that provides the capability for the transmission of signals between user-network interfaces. (Rec. I.112)
- 1002 **controlled maintenance:** A method to sustain a desired quality of service by the systematic application of analysis techniques using centralized supervisory facilities and/or sampling to minimize preventive maintenance and to reduce corrective maintenance. (Rec. M.20)
- 1003 **corrective maintenance:** The maintenance carried out after fault recognition and intended to restore an item to a state in which it can perform a required function. (Rec. M.20)
- 1004 **data communication network:** A data network which is established and operated either by Administrations or by private organizations. (Rec. X.15)
- 1005 **deferred maintenance:** Such corrective maintenance which is not immediately initiated after a fault recognition, but is delayed in accordance with given maintenance rules.
- 1006 **intelligent network (IN):** A telecommunications network which has an architecture that provides flexibility for facilitating the introduction of new capabilities and services, including those under customer control. (Rec. Q.1290)
- 1007 **interface:** The common boundary between two associated systems. (Rec. I.112)
- 1008 **maintenance:** The whole of the operations required for setting-up and maintaining, within prescribed limits, any element entering into the setting-up of a connection. In the international automatic telephone service, maintenance is particularly concerned with circuits and automatic switching equipment. Circuit and automatic equipment maintenance includes:
- a) carrying out setting-up measurements and adjustments;
  - b) planning and programming a maintenance scheme;
  - c) carrying out the prescribed routine preventive maintenance measurements and all other tests and measurements deemed necessary;
  - d) locating and clearing faults.
- 1009 **maintenance entities (ME):** Maintenance entities are defined by the following principles:
- The different equipment of a telecommunications network constituting the MEs are interconnected at consecutive and easily identifiable interface points at which the interface conditions defined for these equipment apply, and which possess the means of detecting maintenance events and failures.
  - If the telecommunication equipment supports bi-directional transmission, it normally consists of telecommunications equipment transmitting in both directions, and then both directions are considered part of the same ME.
  - When a failure occurs within a network, it is desirable that the maintenance alarm information indication appear at the failed ME. When this is not practical, the indication should appear at the closest possible entity.
  - Maintenance alarm information indications in an entity should not cause related alarm information indications at other entities. In the event that such indications are permitted to occur, they should clearly indicate that the failure has occurred upstream, and not in the other entities displaying the information. (Rec. M.20)
- 1010 **maintenance philosophy:** A system of underlying principles for the organization and execution of the maintenance.

1011 **maintenance policy:** A description of the interrelationship between the maintenance echelons, the indenture levels and levels of maintenance to be applied for the maintenance of an item.

1012 **maintenance strategy:** A plan for the organization and execution of maintenance.

1013 **one stop shopping:** An arrangement whereby a single Administration (or ROA) provides and/or coordinates with other Administrations (or ROAs) the provision of one or more telecommunication services. It is designed to shield the customer from the complexities of ordering, implementation, billing and maintenance coordination procedures undertaken by each Administration (or ROA) for provision of informational services. (Rec. F.14)

1014 **preventive maintenance:** The maintenance carried out at predetermined intervals or according to prescribed criteria and intended to reduce the probability of failure or the degradation of the functioning of an item. (Rec. M.20)

1015 **service:** A set of functions offered to a user by an organization. (Rec. E.800)

1016 **service maintenance:** This term denotes the set of maintenance-related activities which should be undertaken by network operators and service providers in order that they can ensure meeting the applicable Quality of Service requirements for the various services which they support. (Rec. M.21)

1017 **telecommunication:** Any transmission and/or emission and reception of signals representing signs, writing, images and sounds or intelligence of any nature by wire, radio, optical or other electromagnetic systems. (Recs. G.710, I.112)

1018 **telecommunication Administration:** An Administration, or the part of a combined postal telecommunication Administration, concerned with the provision of telecommunication services. (Rec. D.70)

1019 **telecommunication service:** That which is offered by an Administration to its customers in order to satisfy a specific telecommunication requirement.

NOTE – Bearer service and teleservice are types of telecommunication service. Other types of telecommunication service may be identified in the future. (Rec. I.112)

1020 **teleservice:** A type of telecommunication service that provides the complete capability including terminal equipment functions, for communications between users according to protocols established by agreement between Administrations. (Rec. I.112)

## 2 Telecommunications management network (TMN)

2000 **accounting management:** A set of functions which enable the use of network services to be measured and the costs for such use to be determined and rendered. (Rec. M.3010)

2001 **action:** A type of management operation which applies to managed objects as a whole. Its impact is generally not confined to modifications of attribute values. (Rec. X.720)

2002 **actions (generic network information model)**

Add TPs to GTP

Add TPs to TP pool

Allow audible visual local alarm

Connect

Disconnect

Inhibit audible visual local alarm

Remove TPs from GTP

Remove TPs from TP pool

Reset audible alarm

For complete definitions see Recommendation M.3100, except reset audible alarm which is defined in Recommendation Q.821.

2003 **Administration (entity):** Denotes a public telecommunication Administration or Recognized Operating Agency (ROA). (Rec. F.500)

- 2004 **administration (task):** Administration covers a broad group of functions that sustain telecommunication services once they have been established. Administration generally consists of network administration and service administration. Network administration ensures that the network is used efficiently and that grade of service objectives are met. Service administration includes such diverse support functions as billing, collecting and switching service evaluation. (Rec. M.3010)
- 2005 **agent:** A management information system user which, for a particular exchange of systems management information, has taken an agent role. (Rec. X.701)
- 2006 **agent role:** A management information system user taking an agent role is capable of performing operations on managed objects and of emitting notifications on behalf of managed objects. (Rec. X.701)
- 2007 **alarm:** An alerting indication to a condition that may have immediate or potential negative impact on the state of the monitoring network element. (Rec. M.3010)
- 2008 **alarm status:** The attribute that describes the condition of a managed object as a result of one or more alarm events. (Complete definition is in Rec. M.3100)
- 2009 **alarm surveillance:** A set of TMN management functions which provides, near real time, detection and indication of failures. (Rec. M.3010)
- 2010 **allomorphism:** The ability of a managed object of a given class to resemble objects of one or more other object classes. (Rec. X.720)
- 2011 **analogue signal:** A continuous signal that varies in some direct relationship with an impressed phenomenon, stimulus, or event that bears intelligence. (Rec. X.700)
- 2012 **application association:** A cooperative relationship between two application entities, formed by their exchange of application protocol control information through their use of presentation services. (Rec. X.217)
- 2013 **application context:** An explicitly identified set of application service elements, related options and any other necessary information for the interworking of application entries on an application association. (Rec. X.217)
- 2014 **application entity:** Any aspect of an application process pertinent to OSI. (Rec. X.200)
- 2015 **application process:** An element within a real open system which performs the information processing for a particular application. (Rec. X.200)
- 2016 **application protocol:** A set of rules and formats (semantic and syntactic) which determine the communication behaviour of application entities in the performance of application functions. (Rec. X.200)
- 2017 **application protocol control information:** Information exchanged between application entities, using presentation services, to coordinate their joint operation. (ISO 9545)
- 2018 **application protocol data unit:** A unit of information specified in an application protocol and consisting of application protocol control information and possibly user information. (ISO 9545)
- 2019 **application service element (ASE):** A set of functions that provide a capability for the interworking of application entity invocations for a specific purpose on a single application association. (ISO 9545)
- 2020 **architecture (functional):** A description of appropriate distribution of functionality, that allows for a creation of functional blocks from which a TMN of any complexity can be implemented. These function blocks are separated by reference points and lead to the requirements for the TMN-recommended interface specifications. (Rec. M.3010)
- 2021 **architecture (information):** The information architecture based on an object-oriented approach gives the rationale for the application of OSI systems management principles to the TMN principles. The OSI systems management principles are mapped onto the TMN principles and are expanded to fit the TMN environment where necessary. (Rec. M.3010)
- 2022 **architecture (physical):** A description of realizable interfaces and examples of physical components (hardware and software) that make up the TMN. (Rec. M.3010)
- 2023 **arena:** A bounded area of logical management responsibility. (Rec. M.3010)

2024 **attribute (of managed object):** Information concerning a managed object used to describe (either in part or in whole) that managed object. This information consists of an attribute type and its corresponding attribute value (for “single-valued” attributes) or values (for “multi-valued” attributes). (Rec. X.700)

2025 **attributes (generic network information model)**

A-termination point instance

Administrative state

Alarm severity assignment list

Alarm severity assignment profile ID

Alarm severity assignment profile pointer

Alarm status

Channel number

Characteristic information

Client connection

Client trail

Connected termination point count

Connection ID

Connection termination point ID

Cross-connection ID

Cross-connection name

Cross-connection object pointer

Current problem list

Directionality

Downstream connectivity pointer

Equipment ID

External time

Fabric ID

From termination

Group termination point ID

Idle TP count

List of characteristic information

Location name

Managed element ID

Multi-point cross-connection ID

Network ID

Network level pointer

Operational state\*

Protected

Redline

Replaceable

Server connection list

Signal type

Software ID

Supportable client list



Supported by object list  
System timing source  
System title\*  
Total TP count  
To termination  
Tp pool ID  
Tps in GTP list  
TPs in TP pool list  
Trail ID  
Trail termination point ID  
Upstream connectivity pointer  
Usage state\*  
User label  
Vendor name  
Version  
Z-termination point instance

For complete definitions see Recommendation M.3100, except those marked with an \*, these definitions are in Recommendation X.710.

2026 **attribute identifier:** An identifier used to distinguish an attribute of a managed object class from all other attributes defined for that object class. (ISO 9545)

2027 **attribute type:** A collection of values which an instance of that type may have, and a collection of operations (in their mathematical sense) which may be performed on values of that attribute type. (Rec. X.720)

2028 **attribute value:** A particular instance of the class of information indicated by an attribute type. (Rec. X.700)

2029 **attribute value assertion:** An assertion that a particular attribute of a managed object has a particular value, i.e. a proposition that may be true, false, or undefined, concerning the values (or perhaps only the distinguished values) of an entity. (Rec. X.501)

2030 **authentication:** The network should ensure that a data exchange is established with the addressed peer entity (and not with an entity attempting a masquerade or a reply of a previous establishment) and that the data source is the one claimed.

Authentication generally follows identification, establishing the validity of the claimed identity, providing against fraudulent transactions. Identification, authentication and authorization information should be protected by the network. When this requirement is requested in a connection-oriented association, it is known as peer entity authentication; when it supports a connectionless association, it is known as data origin authentication. (Rec. M.3010)

2031 **authority domain:** A set of managed objects managed by a managing application in the context of a particular authority relationship set.

2032 **authority relationship:** The relationship between a managing application and a managed object, in which the managing application has the authority to manage the managed object.

2033 **authority relationship set:** A set of authority relationships, each authority relationship of the set being defined from some common standpoint of allocated management responsibility.

2034 **behaviour:** A description of the way in which managed objects, name bindings, attributes, notifications and actions interact with the actual resources they model and with each other. (Rec. X.720)

2035 **billing integrity:** Preservation of accuracy according to specified performance parameters and criteria when preparing bills to a user for a service. (Rec. M.3010)

2036 **broadcast:** One-way transmission from one point to two or more other points. (Rec. M.3010)

- 2037 **bus-type interface:** An interface over which signals from a number of channels or equipments pass, separated by time division and uniquely identified by header information. (Rec. M.3010)
- 2038 **cascaded network:** A physical architecture where connections for one type of components (e.g. network elements) follow serially through similar components before being connected to another type of components (e.g. operation systems). (Rec. M.3010)
- 2039 **circuit-switched network:** A network which provides connections for the exclusive use of the users for the duration of a call or service by interconnecting transmission channels or telecommunication circuits. (Rec. M.3010)
- 2040 **characteristic information:** A signal of characteristic rate and format which is transferred within and between “sub-networks” and presented to an “adaption” function for transport by the server layer network. For the complete definition see Recommendation G.803.
- 2041 **client-server relationship:** A relationship between functional entities (e.g. managed objects) in which the client is the user of a service provided by a server. (Rec. G.803)
- 2042 **common management information services (CMIS):** The sets of services provided by the specific management information service elements. (Rec. X.710)
- 2043 **common management information service element (CMISE):** Application service element which provides basic services for the transfer and manipulation of management information. (Rec. X.710)
- 2044 **concentrator:** A communication device which serves as mediation equipment in the telecommunications management network and which permits equipment connected to multiple physical ports to share a smaller number of physical ports for connection to a communication network or one or more dedicated lines. One NE is connected to each physical port. On the ports carrying concentrated data, frames containing data passing to and from each of the NE ports are interleaved.
- 2045 **concrete syntax:** Those aspects of the rules used in the formal specification of data which embody a specific representation of that data. (Rec. X.200)
- 2046 **conditional package:** A collection of optional attributes, notifications, operations and behaviour which are either all present or all absent in a managed object. The presence or absence of a package is conditional on the capability of the underlying resource, e.g. the options of an X.25 protocol machine. (Rec. X.720)
- 2047 **configuration management (CM):** A set of TMN management functions which exercise control over the extension or reduction of a system, the status of the constituent parts and the identity of their allocation. (Rec. M.3010)
- 2048 **connection quality:** The collective effect of service performance, which determines the degree of satisfaction of a user with the particular connection. (Rec. M.3010)
- 2049 **connection:** An association of transmission channels or circuits, switching and other functional units set up to provide a means for a transfer of information between two or more points in a telecommunication network. (Rec. Q.9)
- 2050 **connection retention:** The probability that a connection, once obtained, will continue to be provided for a communication. (Rec. M.3010)
- 2051 **containment:** A structuring relationship for managed objects in which the existence of a managed object is dependent on the existence of a containing managed object. (Rec. X.720)
- 2052 **containment hierarchy:** See **containment tree**.
- 2053 **containment tree:** A hierarchical arrangement of managed object instances where the hierarchy is organized on the basis of containment relationships. A managed object instance containing another managed object instance is higher in the hierarchy than the contained object. The containing managed object instance is referred to as being the superior of the contained object, which is referred to as the subordinate. (Rec. X.720)
- 2054 **cross-connect (digital):** The function of cross-connect systems is to act as automated distribution frames enabling traffic to be sorted and routed on a semi-permanent basis under local or remote computer control. (Rec. M.3010)

- 2055 **customer:** A customer is an entity which receives services offered by a service provider based on a contractual relationship. It may include the role of a network user. (Rec. M.3010)
- 2056 **data collection processor:** A communications device which serves as mediation equipment in the telecommunication management network and which provides concentration, protocol conversion and operations functions such as accumulation and thresholding. One or more NE may be connected to each physical port.
- 2057 **data communication function (DCF):** The data communication function (DCF) is used by the TMN function blocks for exchanging information. (Rec. M.3010)
- 2058 **data communication network (DCN):** A communication network within a TMN which supports data communication functions (DCF) at the reference point  $q_3$  and/or  $q_x$ . (Rec. M.3010)
- 2059 **data communications channel (DCC):** Within an STM-N signal there are two DCC channels, comprising bytes D1-D3, giving a 192 kbit/s channel, and bytes D4-D12, giving a 576 kbit/s channel. D1-D3 (DCC-R) are accessible by all SDH NEs whereas D4-D12 (DCC-M), not being part of the regenerator section overhead, are not accessible at regenerators. D1-D3 are allocated for SDH NE use. The D4-D12 channel can be used as a wide-area general-purpose communication channel to support TMN including non-SDH applications. (Rec. G.784)
- 2060 **deadlock:** Dead-lock occurs when a management operation has embarked upon a course of action which involves the control of several objects but not all the objects are available as they are locked by another operation which cannot continue until objects locked by the first operation are released. Hence each operation is waiting for the other to do something (note that multiple operations may be involved in a dead-lock). (Rec. M.3010)
- 2061 **diagnostic tests:** Tests specially designed to identify more precisely, preferably to a single replaceable unit, the location of a hardware fault. (Rec. M.3010)
- 2062 **digital signal:** A discretely timed signal in which information is represented by a number of well-defined discrete values. (Rec. X.700)
- 2063 **distinguished name:** The name of a managed object which consists of a sequence of the relative distinguished names of its superiors in the naming tree, starting at the root and working to the managed object to be identified. (Rec. X.501)
- 2064 **domain:** The organizations requirements for managing a collection of managed objects. (Rec. M.3010)
- 2065 **embedded operations channel (EOC):** A channel which is provided as an integral part of communications facility for the purpose of carrying operations messages. (Rec. G.784)
- 2066 **emergency action:** A modified action or procedure to be used when normal activity cannot re-establish the handling of traffic. (Rec. M.3010)
- 2067 **event:** An instantaneous occurrence that changes the global status of an object. This status change may be persistent or temporary, allowing for surveillance, monitoring, and performance measurement functionality, etc. Events may or may not generate reports; they may be spontaneous or planned; they may trigger other events or may be triggered by one or more other events. (Rec. X.700)
- 2068 **embedded control channel (ECC):** An ECC provides a logical operations channel between SDH network elements, utilizing a data communications channel (DCC) as its physical layer. (Rec. G.784)
- 2069 **F-interface:** The F-interface connects work stations remotely to the OSF or MF through a data communications network. (Rec. M.3010)
- 2070 **fault (maintenance) management:** A set of TMN management functions which enable the detection and localization of faults, the scheduling of repairs, and the testing out and return to service of repaired equipment. (Rec. M.3010)
- 2071 **file:** A complete collection of related data. (Rec. M.3010)
- 2072 **fragment:** A fragment is a grouping of a limited number of object class definitions. Each fragment deals with a particular subject. (Rec. M.3010)

2073 **fragment (generic network information model)**

Network fragment

Managed element fragment

Termination point fragment

Transmission fragment

Cross-connection fragment

Functional area fragment

For definitions see Recommendation M.3100.

2074 **function attributes:** Properties or characteristics of functions which allow differentiation between realizations to be specified by means of parameters. (Rec. M.3010)

2075 **function block:** A function block is a component of the functional architecture of a TMN. Function blocks provide the functions which enable a TMN to perform the TMN functions. A functional block may be built up from functional components. (Rec. M.3010)

2076 **functional component:** A sub-element within a function block. (Rec. M.3010)

2077 **functional entity (FE):** A functional entity is a grouping of service-providing functions in a single location and is a subset of the total set of functions required to provide the service. It is described in terms of the control of one instance of a service. (Rec. Q.66)

2078 **functional architecture:** See **architecture (functional)**.

2079 **generic definitions:** Definitions of object classes, attribute types, notification types or operation types, made available for general use. (Rec. X.701)

2080 **generic network information model (GNIM):** A model describing managed object classes and their properties that are technology-independent (generic) and useful to describe information exchanged across all interfaces defined in the Recommendation M.3010 architecture. (Rec. M.3100)

2081 **global status:** The complete set of attributes necessary to describe an object at a particular time. (Rec. M.3010)

2082 **group relationship:** Used to express the grouping of the same or different classes of member objects for some identified functional management or administrative purpose. (Rec. X.732)

2083 **human-machine adaption (HMA):** The HMA performs the conversion from the “q<sub>3</sub>” information model to the “f” information model (it masks some data, adds information and reorganizes the whole), and vice versa. In addition, it supports the authentication and authorization of the user. (Rec. M.3010)

2084 **information conversion function (ICF):** The information conversion function is used in intermediate systems to translate the information model at one interface into the information model at the other interface. (Rec. M.3010)

2085 **information model:** Between two communicating entities there needs to exist a common understanding of the information about which communication can take place. This is abstracted in an information model as objects and their behaviour, characteristics and relationships. (Rec. M.3100)

2086 **inheritance:** The conceptual mechanism by which attributes, notifications, operations and behaviour are acquired by a subclass from its superclass. (Rec. X.720)

2087 **inheritance hierarchy:** A hierarchical arrangement of managed object classes where the hierarchy is organized on the basis of class refinement. A managed object class which is derived from another managed object class is lower in the hierarchy than the class from which it is derived. (Rec. X.720)

2088 **interoperability:** The ability of network management products and services from different suppliers to work together to manage communications between managed object classes. (Rec. M.3100)

2089 **interoperable interface:** The interoperable interface defines the protocol suite and the messages carried by the protocol. It is based upon an object-oriented view of the communication and so all the messages carried deal with object manipulations. It is the formally-defined set of protocols, procedures, messages, formats and semantics used for management communications. (Rec. M.3010)

- 2090 **managed (open) systems:** A real open system supporting the agent role of an MIS user. (Rec.X.701)
- 2091 **managed domain:** A set of real open systems, collected for systems management. (Rec. X.701)
- 2092 **managed element:** A physical or logical resource that is to be managed but exists independently of its need to be managed. Managed elements include resources within the communications network which provide communications services and systems resources that make use of the communication network. (Rec. M.3010)
- 2093 **managed object:** See **object**.
- 2094 **managed object class:** See **object class**.
- 2095 **managed object instance:** See **object instance**.
- 2096 **management application function (MAF):** An application process participating in systems management. The MAF includes an agent (being managed) and/or a manager. Each network element (NE) and operations system (OS) or mediation device (MD) must support an MAF that includes at least an agent. NE contains the management application function NEF-MAF, MD contains MF-MAF and OS contains OSF-MAF. An MAF is the origin and termination for all TMN messages. (Rec. M.3010)
- 2097 **management domain:** Management domains are sets of managed objects arranged to meet the following organizational requirements:
- To partition the management environment for a number of functional purposes (or policies), such as for security, accounting, fault management, etc., or to partition the environment for each management purposes, such as according to geographical, technological or organizational structure.
  - To temporarily assign and possibly modify the roles of manager and agent for each of the purposes within each collection of managed objects.
  - To exercise forms of control (e.g. security policy) in a consistent manner. (Rec. M.3010)
- 2098 **management information base (MIB):** A management information base is the information within an open system which may be transferred or affected through the use of OSI management protocols. The MIB is the set of managed objects within an open system. This does not imply any form of physical or logical storage for the information and its implementation is a matter of local concern and outside the scope of standards.
- Management information may be shared between management processes and is structured according to the requirements of those processes. The MIB neither restricts the interpretation of management data to a pre-defined set, nor to whether the data is stored in a processed or unprocessed form. However, both the abstract syntax and the semantics of information which is part of the MIB are defined so that they can be represented in OSI protocol exchanges. (Rec. X.700)
- 2099 **management information catalogue (MIC):** A management information catalogue is a set of summaries of management information definitions, fully consistent with the definitions in the source CCITT Recommendations. (Rec. M.3180)
- 2100 **management information library (MIL):** A management information library is a set of management information definitions using the templates in Recommendation X.722. (Rec. X.722)
- 2101 **management information tree:** See **naming tree**.
- 2102 **management layer:** Management layers are used to restrict management activity within the boundaries of each layer to a clearly defined rank that is concerned with a subset of the total management activity. (Rec. M.3010)
- 2103 **management subdomain:** A management domain that is wholly located within another management domain. (Rec. M.3010)
- 2104 **manager:** An MIS user which, for a particular exchange of systems management information, has taken a manager role. (Rec. X.701)
- 2105 **manager role:** An MIS user taking a manager role is capable of issuing operations and of receiving notifications. (Rec. X.701)

- 2106 **management system:** A system with the capability and authority to exercise control over and/or collect management information from another system. (Rec. M.3010)
- 2107 **mediation device (MD):** The mediation device is the stand-alone device which performs mediation functions. MDs can be implemented as hierarchics of cascaded devices. (Rec. M.3010)
- 2108 **mediation function block (MF):** The MF acts on information passing between NEFs and OSFs to achieve smooth and efficient communication. Major MFs include communication control, protocol conversion and data handling, communication of primitive functions, processes involving decision making, and data storage. (Rec. M.3010)
- 2109 **memory backup:** A process which takes copies of information in a data base memory, at periodic intervals, to be used for rebuilding that memory's contents in case of its failure. (Rec. M.3010)
- 2110 **message:** Content of a notification or an operation. (Rec. M.3010)
- 2111 **message communication function (MCF):** The MCF is associated with all function blocks and is used by them to exchange with their peers management information contained in messages. The MCF is composed of and limited to a protocol stack that allows connection of function blocks to data communication functions. Depending on the protocol stack supported at the reference point, different MCF types will exist. These will be differentiated by subscripts (e.g. MCFq3 applies at a q<sub>3</sub> reference point). (Rec. M.3010)
- 2112 **message syntax:** The relationships between messages or groups of messages, independent of their meanings or the manner of their interpretation and use. (Rec. M.3010)
- 2113 **multiple inheritance:** A conceptual mechanism that allows a managed object class to acquire attributes, notifications, operations and behaviour from more than one superclass. (Rec. X.720)
- 2114 **(n)-layer managed object:** A managed object specific to the (N)-layer. (Rec. X.700)
- 2115 **name binding:** A relation between managed object classes for the purpose of naming. (Rec. X.720)
- 2116 **name binding (generic network information model)**
- Alarm record\*
  - Alarm severity assignment profile
  - Connection
  - Connection termination point source
  - Connection termination point sink
  - Cross-connection
  - Equipment
  - Event forwarding discriminator
  - Fabric
  - GTP
  - Log
  - Multi-point cross-connection managed element
  - Network
  - Software
  - TP pool
  - Trail
  - Trail termination point source
  - Trail termination point sink

For complete definitions see Recommendation M.3100, except for alarm record which is defined in Recommendation X.721.

2117 **naming tree:** A hierarchical arrangement of managed objects where the hierarchy is organized on the basis of the containment relationship. A managed object used to name another managed object is higher in the hierarchy than the named object. The naming managed object is referred to as being the superior of the named object, which is referred to as the subordinate. (Rec. X.720)

2118 **network element (NE):** The NE consists of telecommunication equipment (or groups/parts of telecommunication equipment) and support equipment. An NE performs network element functions (NEFs) and has one or more standard Q-type interfaces. (Rec. M.3010)

2119 **network element function block (NEF):** NEF may contain telecommunication functions and/or support functions. The NEF is a functional block which communicates with a TMN for the purpose of being monitored and/or controlled. (Rec. M.3010)

2120 **non-repudiation:** Non-repudiation requirements provide unforgeable proof of shipment and/or receipt of data to prevent the sender from disavowing a legitimate message or the recipient from denying receipt. The network may provide either or both of the following two forms:

- the recipient of data is provided with proof of origin of data that will protect against any attempt by the sender to falsely deny sending the data or its contents;
- the sender is provided with proof of delivery of data such that the recipient cannot later deny receiving the data or its contents. (Rec. M.3010)

2121 **notification:** Information emitted by a managed object relating to an event that has occurred within the managed object. (Rec. X.710)

2122 **notification (generic network information model)**

Attribute value change  
Communications alarm  
Environmental alarm  
Equipment alarm  
Object creation  
Object deletion  
Processing error alarm  
State change

For complete definitions see Recommendation X.721.

2123 **notification type:** A datatype defining a specific kind of notification. (Rec. X.700)

2124 **object:** A view of one or more resources. The abstract view of such a resource that represents its properties as seen by (and for the purpose of) management. (Rec. M.3100)

2125 **object class:** A named set of managed objects sharing the same attributes, notifications and management operations. (Rec. M.3100)

2126 **object classes (generic network information model)**

Alarm record	X.721
Alarm severity assignment profile	M.3100
Attribute value change record	X.721
Connection	M.3100
Connection termination point bidirectional	M.3100
Connection termination point sink	M.3100
Connection termination point source	M.3100
Connectivity	M.3100
Cross-connection	M.3100
Current alarm summary control	Q.821
Discriminator	X.721
Equipment	M.3100

Event forwarding discriminator	X.721
Event log record	X.721
Fabric	M.3100
Group termination point	M.3100
Log	X.721
Log record	X.721
Managed element	M.3100
Management operations schedule	Q.821
Multipoint cross-connection	M.3100
Named cross-connection	M.3100
Named multipoint cross-connection	M.3100
Network	M.3100
Object creation record	X.721
Object deletion record	X.721
Software	M.3100
State change record	X.721
Termination point	M.3100
TP pool	M.3100
Trail	M.3100
Trail termination point bidirectional	M.3100
Trail termination point sink	M.3100
Trail termination point source	M.3100

For complete definitions see references in the right-hand column above.

2127 **object instance:** A particular managed object of a managed object class. (Rec. X.700)

2128 **operations:** These include the operation of work centers, technical support centers, support systems, test equipment, methods and procedures, as well as the personnel and training required to install and maintain all the elements that constitute the network capability underlying the relevant services. (Rec. M.3010)

2129 **operations systems (OS):** The OS is the stand-alone system which performs operation system functions (OSF). For operational purposes the management functionality may be considered to be partitioned into layers, such as network element management layer, network layer, service and business layer. (Rec. M.3010)

2130 **operations systems function block (OSF):** The OSF processes information related to telecommunication management for the purpose of monitoring/coordinating and/or controlling telecommunications functions and support functions including management functions (i.e. the TMN itself). (Rec. M.3010)

2131 **orchestration:** Orchestration is sequencing where a management operation is dependent upon several managed objects in a network being changed in a strict sequence. (Rec. M.3010)

2132 **overhead and adaptation trail:** A trail carrying overhead and adaptation information. (Rec. M.3010)

2133 **packages:** A collection of attributes, notifications, operations and behaviour which are either all present or all absent in a managed object.

2134 **packages (generic network information model)**

- Administrative operational states
- Affected object list
- Alarm severity assignment pointer
- Attribute value change notification
- Audible visual local alarm
- Channel number



Characteristic information  
Client connection  
Client trail  
Create delete notifications  
Cross-connection pointer  
CTP instance  
Current problem list  
Environmental alarm  
Equipments equipment alarm  
External time  
Location name  
Named cross-connection  
Network level  
Operational state  
Object management notifications  
Processing error alarm  
Protected  
Reset audible alarm  
Server connection list  
Server trail list  
Software processing error alarm  
Supportable client list  
State change notification  
System timing source  
TMN communication alarm information  
TTP instance  
User label  
Vendor name  
Version

For complete definitions see Recommendation M.3100, other packages defined elsewhere are not listed above.

2135 **packet-switched network:** A network providing a service involving the transmission, and if necessary the assembly and disassembly, of data in the form of packets. (Rec. X.15)

2136 **parallel interface:** An interface consisting of two or more connection elements in parallel, with each connection element dedicated to the passage of signals from a specific equipment. (Rec. M.3010)

2137 **performance management (PM):** A set of TMN management functions which enable the performance (i.e. ability to reproduce a signal) of the network services to be measured and corrective actions to be taken. (Rec. M.3010)

2138 **physical configuration:** A combination of equipment entities showing electrical, optical or electromagnetic radiation type interconnections between associated parts. (Rec. M.3010)

2139 **polling:** The action of sequentially interrogating various equipment items, on a common communication bus, in order to solicit information from them. (Rec. M.3010)

2140 **presentation context:** An association of an abstract syntax with a transfer syntax. (Rec. X.216)

- 2141 **presentation function (PF):** The presentation function performs the general operations to translate the information held in the TMN information model to a displayable format for the human-machine interface, and vice versa. The PF performs all the functions needed to provide user-friendly facilities to enter, display, and modify details about objects. (Rec. M.3010)
- 2142 **private operating agencies:** Privately owned (as distinct from a Telecommunication Administration) network operator or provider of value-added services. (Rec. M.3010)
- 2143 **protocol:** A set of rules and formats (semantic and syntactic) which determine the communication behaviour of peer entities. (Rec. G.771)
- 2144 **protocol suite:** A protocol suite identifies the allowed sets of individual layer protocols where each set can fully support a specific interface. Example of a protocol suite is Recommendation G.773. (Rec. G.771)
- 2145 **protocol profile:** A protocol (layer) profile fully specifies the protocol options of one protocol layer. (Rec. G.771)
- 2146 **provisioning:** Provisioning is the process of making available various telecommunications resources (such as switching systems and transport facilities) for telecommunication services. Provisioning includes forecasting the demand for services, determining the additions or changes to the network that will be needed, determining where and when they will be needed, and installing all the necessary network elements to provide such services. (Rec. M.3010)
- 2147 **Q-adapter (QA):** The QA is a device which connects non-TMN compatible NE-like or OS-like entities (i.e. those with m-reference points) to  $Q_x$  or  $Q_3$  interfaces. (Rec. M.3010)
- 2148 **Q-adapter function block (QAF):** The QAF is used to connect to the TMN those NEFs and OSFs which do not support standard TMN interfaces. The responsibility of the QAF is to translate between a TMN interface and non-TMN (e.g. proprietary) interface and hence this latter activity is shown outside the TMN. (Rec. M.3010)
- 2149 **Q-interface:** To provide the flexibility of implementation, the class of Q-interfaces is made up of the following subclasses:
- interfaces  $Q_x$ , intended to connect MDs to MDs, NEs to MDs, QAs to MDs, and NEs to NEs when one or both NEs contain a mediation function;
  - interface  $Q_3$ , intended to connect MDs, QAs, NEs and OSs to OSs via a DCN. (Rec. M.3010)
- 2150 **reference point:** A conceptual point at the conjunction of two non-overlapping functions that can be used to identify the type of information passing between these functions. (Rec. M.3010)
- 2151 **relative distinguished name (RDN):** A set of attribute value assertions, each of which is true concerning the distinguished values of a particular entry (object). (Rec. X.501)
- 2152 **resource:** Manageable functional parts of telecommunication and support equipment which can be unambiguously defined. (Rec. M.3010)
- 2153 **security management:** A set of TMN management functions which enable a TMN to change passwords and alter the identifications and security classes of communication channels. (Rec. M.3010)
- 2154 **service status:** A set of attributes that describes the services provided by an object, for example: service state, etc. The service status of an object is a subset of the global status of the object. (Rec. X.700)
- 2155 **signal trail:** A trail carrying a payload. (Rec. M.3010)
- 2156 **specialization:** The technique of deriving new managed object classes from an existing class by the addition of new capabilities, such as new attributes or notifications. (Rec. X.720)

- 2157 **star (interface):** An interface in which signals to and from a number of equipment are brought to corresponding ports on one equipment item. (Rec. M.3010)
- 2158 **status:** A set of attributes necessary to describe an object at a particular time for a particular purpose. (Rec. X.700)
- 2159 **subclass:** A class derived from another class by refinement. (Rec. X.720)
- 2160 **subordinate managed object:** A managed object instance further from the root in the naming tree, contained within a superior managed object and named within the scope of its superior managed object. (Rec. X.720)
- 2161 **superclass:** A class used in deriving another class by refinement. (Rec. X.720)
- 2162 **support object:** An object defined to support the functions of managing a network. Support objects do not exist independently of the act of network management. (Rec. X.700)
- 2163 **synchronization:** Clock synchronization used in transmission and switching equipment. Activity synchronization used in TMN. This is where a single management operation needs to be positioned in a particular order as it needs to influence several managed objects in a coordinated manner. The managed objects involved could be distributed across several separate managed elements. (Rec. M.3010)
- 2164 **systems management application service element:** An application service element providing systems management services. (Rec. X.701)
- 2165 **systems management function:** A group of systems management services which satisfy a set of logically related user requirements. (Rec. X.701)
- 2166 **systems management functional unit:** A named set of systems management services defined for the purpose of identifying specific sets of functionality where there is requirement to establish or negotiate the use of such functionality between end systems or for reference purposes in other standards. (Rec. X.701)
- 2167 **systems management process:** An application process participating in systems management. (Rec. X.701)
- 2168 **systems management service:** A named set of service primitives that provide a service for use in systems management. (Rec. X.701)
- 2169 **telecommunications management network (TMN):** A TMN provides the means used to transport and process information related to management of the telecommunications network. (Rec. M.3010)
- 2170 **template:** Templates define standard formats for the documentation of managed object class definitions, conditional packages, specific errors, name bindings, attributes, group attributes, behaviour definitions, actions and notifications. (Rec. X.722)
- 2171 **terminals:** Equipment, located in close proximity to the user, which presents to the user the information received from the network in a form compatible with the user's requirements and also performs the complementary function from the user to the network. (Rec. I.112)
- 2172 **thresholding:** A process which is involved in decision-making and compares the actual value of a parameter with a predetermined value to decide whether an alarm action needs to be initiated. (Rec. M.3010)
- 2173 **TMN management function (TMN MF):** The TMN management function represents an access mechanism to the managed resources. They provide the capability of acting upon the managed resources. TMN MFs map onto the operations to be performed on the managed objects (and related attributes) that represent the managed resources. (Rec. M.3020)
- 2174 **TMN management service (TMN MS):** TMN management service is an offering fulfilling specific telecommunications management needs of the TMN user. TMN users may be internal or external to the organization of the TMN provider. TMN MS is then a management activity which provides for the support of one aspect of operation, administration and maintenance of the network and services being managed. The TMN MS is always designed from the TMN user perception of the management requirements. TMN MSs are described as assemblies of TMN MSCs. (Rec. M.3020)

2175 **TMN management service components (TMN MSC):** TMN management service components are a constituent part of a TMN MS, stating the requirements for actions to be performed on the managed resources. TMN MSC could be specific of a TMN MS or generic and reuseable by a set of TMN MSs. Depending on the TMN user needs, the TMN MS can be decomposed into TMN MSCs of different degrees of details of the TMN MS. (Rec. M.3020)

2176 **TMN general function:** The TMN general functions provide support for the TMN application functions. (Rec. M.3010)

2177 **TMN user:** TMN user is that which exercises the TMN management service for the purpose of fulfilling its management objectives. It may be a human user applying for the use of management services via a man-machine communication or it may be a system requiring the capabilities of the TMN. (Rec. M.3010)

2178 **trail:** A trail is a “transport entity” in a server layer responsible for the integrity of transfer of “characteristic information” from one or more client network layers between server layer “access points”. It defines the association between access points in the same “transport network layer”. It is formed by combining a near-end “trail termination” function, a “network connection” function and a far-end “trail termination” function. (Rec. G.803)

2179 **transmission:** The physical process of propagating information signals through a physical medium. (Rec. G.803)

2180 **transport:** The functional process of transferring information between end points. (Rec. G.803)

2181 **transport network layer:** Part of a transport network solely concerned with the transfer of particular characteristic information, defined by data rate and format. (Rec. G.803)

2182 **user:** A person or a machine delegated by a customer to use the services and/or facilities of a telecommunications network. (Rec. I.112)

2183 **work station (WS):** A multi-functional terminal with local processing capabilities. (Rec. M.3010)

2184 **work station function block (WSF):** The work station function block provides the means to interpret TMN information for the management information user. The WSF includes support for interfacing to a human user. (Rec. M.3010)

2185 **X-interface:** The purpose of an X-interface will be to interconnect two management systems or TMNs. It will be used to interconnect the TMNs of two separate Administrations or an Administration’s TMN to an external service provider’s TMN. (Rec. M.3010)

### 3 Quality, availability, reliability, dependability

3000 **anomaly:** An anomaly is a discrepancy between the actual and desired characteristic of an item. The desired characteristic may be expressed in the form of a specification. An anomaly may or may not affect the ability of an item to perform a required function. (Rec. M.20)

3001 **availability performance:** The ability of an item to be in the state to perform a required function at a given instant of time or at any instant of time within a given time interval, assuming that the external resources, if required, are provided.

#### NOTES

1 This ability depends on the combined aspects of the reliability performance, the maintainability performance and the maintenance support performance of an item.

2 In the definition of the item the external resources required must be delineated.

3 The term availability is used as an availability performance measure.

3002 **bit error ratio (BER):** The ratio of the number of bit errors to the total number of bits transmitted in a given time interval. (Rec. E.800)

3003 **defect:** A defect is a limited interruption of the ability of an item to perform a required function. It may or may not lead to maintenance action depending on the results of additional analysis. (Rec. M.20)

3004 **echo**: An electric, acoustic or electromagnetic wave which arrives at a given point, after reflection or indirect propagation, with sufficient magnitude and delay for it to be perceptible at the given point, as a wave distinct from that directly transmitted. (Rec. G.601)

3005 **echo canceller**: A voice operated device placed in the 4-wire portion of a circuit and used for reducing near-end echo present on the send path, by subtracting an estimation of that echo from the near-end echo. (Rec. G.165)

3006 **echo suppressor**: A voice-operated device placed in the 4-wire portion of a circuit and used for inserting loss in the transmission path to suppress echo. The path in which the device operates may be an individual circuit path or a path carrying a multiplexed signal. (Rec. G.164)

3007 **error**: An inconsistency between a digit in a transmitted digital signal and the corresponding digit in the received digital signal. (Rec. G.701)

3008 **error burst**: A group of bits in which two successive erroneous bits are always separated by less than a given number ( $x$ ) of correct bits. The number ( $x$ ) should be specified when describing an error burst. (Rec. Q.9)

3009 **error free seconds (EFS)**: The ratio of the number of one-second intervals during which no bits are received in error to the total number of one-second intervals in the time interval.

NOTES

- 1 The length of the time interval need to be specified.
- 2 This ratio is usually expressed as a percentage. (Rec. E.800)

3010 **errored second (ES) (in-service condition)**: An ES (for in-service measurements) is a one-second interval with one or more anomaly events (see 2.5.3/M.2100).

3011 **errored second (out-of-service condition)**: A one-second period with equal to (or greater than) 1 binary error. (Rec M.2100)

3012 **failure**: The termination of the ability of an item to perform a required function.

NOTE – After failure the item has a fault. (Rec. M.20)

3013 **fault**: The inability of an item to perform a required function, excluding that inability due to preventive maintenance, lack of external resources or planned actions.

NOTE – A fault is often the result of a failure of the item itself, but may exist without prior failure. (Rec. M.20)

3014 **interruption; break of service**: Temporary inability of a service to be provided persisting for more than a given time duration, characterized by a change beyond given limits in at least one parameter essential for service.

NOTES

- 1 An interruption of a service may be caused by disabled states of the items used for the service or by external reasons such as high service demands.
- 2 An interruption of a service is generally an interruption of the transmission, which may be characterized by an abnormal value of power level, signal distortion, error rate, etc. (Rec. E.800)

3015 **maintainability (performance)**: The ability of an item under stated conditions of use, to be retained in, or restored to, a state in which it can perform a required function, when maintenance is performed under given conditions and using stated procedures and resources.

NOTE – The term maintainability is used as a measure of maintainability performance.

3016 **maintenance support (performance)**: The ability of a maintenance organization, under given conditions, to provide upon demand the resources required to maintain an item, under a given maintenance policy.

NOTE – The given conditions are related to the item itself and to the conditions under which the item is used and maintained.

3017 **propagation performance**: The ability of a propagation medium, in which a wave propagates without artificial guide, to transmit a signal within the given tolerances.

NOTE – The given tolerances may apply to variations in signal level, noise, interference levels, etc. (Rec. E.800)

3018 **quality of service (QOS):** The collective effect of service performances which determine the degree of satisfaction of a user of the service.

NOTE – The quality of service is characterized by the combined aspects of service support performance, service operability performance, service integrity and other factors specific to each service. [See Figure 1/E.800 in Annex C of this Recommendation.] (Rec. E.800)

3019 **random error:** Errors distributed over the digital signal so that they can be considered statistically independent from each other. (Rec. Q.9)

3020 **reliability (performance):** The ability of an item to perform a required function under given conditions for a given time period.

NOTES

1 It is generally assumed that the item is in a state to perform this required function at the beginning of the time interval.

2 The term reliability is used as a measure of reliability performance.

3021 **serveability performance:** The ability of a service to be obtained, within specified tolerances and other given conditions, when requested by the user and continued to be provided for a requested duration.

NOTE – Serveability performance may be subdivided into the service accessibility performance and the service retainability performance. (Rec. E.800)

3022 **service accessibility performance:** The ability of a service to be obtained, within specified tolerances and other given conditions, when requested by the user.

NOTE – This takes into account the transmission tolerance and the combined aspects of propagation performance, trafficability performance and availability performance of the related systems. (Rec. E.800)

3023 **service integrity:** The degree to which a service is provided without excessive impairments, once obtained.

NOTE – This service is characterized by the transmission performance of the system. (Rec. E.800)

3024 **service operability performance:** The ability of a service to be successfully and easily operated by a user. (Rec. E.800)

3025 **service retainability performance:** The ability of service, once obtained, to continue to be provided under given condition for a requested duration.

NOTE – Generally this depends on the transmission tolerances, the propagation performance and reliability performance of the related systems. For some services, for example packet switching, this also depends on the trafficability performance and the availability performance of the related systems. (Rec. E.800)

3026 **service support performance:** The ability of an organization to provide a service and assist in its utilization.

NOTE – An example of service support performance is the ability to provide assistance in commissioning a basic service, or a supplementary service such as the call waiting service or directory inquiries service. (Rec. E.800)

3027 **severely errored second (SES) (in-service condition):** An SES (for in-service measurements) is a one second interval with one or more defect events (see 2.5.3/M.2100).

3028 **severely errored second (SES) (out-of-service condition):** A one-second period with an integrated BER of  $> 10^{-3}$ . (Rec. M.2100)

3029 **system availability information point:** The system availability information point is an element within the general maintenance organization for the international automatic and semi-automatic telephone service associated with one or more international centers. It collects and disseminates information concerning the non-availability of telecommunications systems which affects the international service. The term availability is used here in the broadest sense of the word. (Rec. M.721)

3030 **trafficability performance:** The ability of an item to meet a traffic demand of a given size and other characteristics, under given internal conditions.

NOTE – Given internal conditions refer, for example, to any combination of faulty and non-faulty sub-items. (Rec. E.800)

3031 **transmission performance:** The level of reproduction of a signal offered to a telecommunications system, under given conditions, when this system is in an up state. (Rec. E.800)

## 4 Transmission

4000 **15 supergroup assembly:** A 15 supergroup assembly consists of a 15 supergroup assembly link terminated at each end by terminal equipments. These terminal equipments provide for the setting-up of 15 supergroup links or sections separated by free spaces of 8 kHz and occupying a band whose total width is 3716 kHz. The basic supergroup assembly is made up of supergroups 2 to 16 occupying the frequency band 312-4028 kHz. (See Figures 2, 3 and 4 in Annex C.)

4001 **15 supergroup assembly section:** The whole of the means of transmission using a frequency band of specified width (3716 kHz) connecting two consecutive 15 supergroup assembly distribution frames (or equivalent points) and connected, at least at one end, to through-15 supergroup assembly connection equipment. It always forms part of a 15 supergroup assembly link. (See Figures 2, 3 and 4 in Annex C.)

4002 **analogue circuit:** An analogue circuit comprises one or more analogue circuit sections. These circuits terminate at both ends in analogue switching machines. (Rec. M.590)

4003 **analogue circuit section:** An analogue circuit section comprises two analogue channels, one for each direction of transmission. (Rec. M.562)

4004 **access channel:** A designated part, having specified characteristics, of the information transfer capability at the user network interface.

### NOTES

- 1 The information transfer may be, and usually is, bi-directional.
- 2 See also the definition for transmission channel. (Rec. I.112)

4005 **analogue channel:** An analogue channel is a one-way transmission capability which is provided on audio pairs of analogue transmission systems, and which appears at voice frequency at both ends. Where an analogue channel is provided by an analogue transmission system, it will not have voice frequency appearances other than at its ends.

4006 **circuit control station:** The circuit control station is the point within the general maintenance organization for the international automatic and semi-automatic telephone service that fulfills the control responsibilities for the automatic circuits assigned to it. (Rec. M.723)

4007 **circuit sub-control station:** The circuit sub-control station is a point within the general maintenance organization for the international automatic and semi-automatic telephone service that assists the circuit control station and fulfills the control responsibilities for a circuit section assigned to it. (Rec. M.724)

4008 **circuit, telecommunication circuit:** A combination of two transmission channels permitting bi-directional telecommunication between two points to support a single call.

### NOTES

- 1 If the telecommunication is by nature unilateral, for example: long distance television transmission, the term "circuit" is sometimes used to designate the single channel providing the facility.
- 2 In telephony, use of the term "circuit" is generally limited to a telecommunication circuit with associated terminating equipment directly connecting two switching devices or exchanges.
- 3 A telecommunication circuit does not necessarily permit simultaneous transmission in both directions.
- 4 The "go" and "return" channels may be permanently associated together or may be selected from separate sets of associations together throughout the call.
- 5 The term circuit may be preceded by other qualifiers than telecommunication e.g. telephone, digital, etc. (Rec. Q.9)

4009 **confirmation time:** The time from the occurrence of the potential failure to the instant when the fault is confirmed as requiring a restoration. (See Figure 6/M.495 in Annex C of this Recommendation.) (Rec. M.495)

4010 **connection:** An association of transmission channels or circuits, switching and other functional units, set up to provide a means of transfer of information between two or more points in a telecommunication network. (Rec. Q.9)

4011 **control circuit:** A circuit used for the transmission of restoration control information. (See Figure 5/M.495 in Annex C of this Recommendation.) (Rec. M.495)

4012 **control equipment:** An equipment that is used to implement the transmission restoration control function. (See Figure 5/M.495 in Annex C of this Recommendation.) (Rec. M.495)

4013 **control station:** A control station is that point within a general maintenance organization which fulfills the control responsibilities for the circuit, group, supergroup, digital section, etc., assigned to it. (Rec. M.80)

4014 **controlled station:** The station that has its systems, links, and other maintenance elements supervised, where the information and commands for switching are sent to and received from the control center, and where the switching is effected. (See Figure 5/M.495 in Annex C of this Recommendation.) (Rec. M.495)

4015 **detection time:** Time interval between a potential failure of transmission and the recognition of that potential failure. (See Figure 6/M.495 in Annex C of this Recommendation.) (Rec. M.495)

4016 **digital block:** The combination of a digital path and associated digital multiplex equipment. (See Figure 6 in Annex C.)

NOTE – The bit rate of the digital path should form part of the title.

4017 **digital channel:** A digital channel provides one-way 64 kbit/s transmission capability, on a digital path. A digital channel appears at both ends on a digital distribution frame or equivalent either at 64 kbit/s or as a 64 kbit/s time slot in a digital path at a specified level of the digital hierarchy. (See Figure 7 in Annex C.)

4018 **digital circuit:** A circuit which transmits information signals in digital form between two exchanges. It includes termination equipment but not switching stages. (Rec. Q.9)

4019 **digital circuit section:** A digital circuit section comprises two digital channels, one for each direction of transmission. (Rec. M.585)

4020 **digital connection:** A concatenation of digital transmission channels or digital telecommunication circuits, switching and other functional units set up to provide for the transfer of digital signals between two or more points in a telecommunication network, to support a single communication. (Rec. G.701)

4021 **digital distribution frame:** A frame at which interconnections are made between the digital outputs of equipment and the digital inputs of other equipment. (See Figure 6 in Annex C.)

4022 **digital line path:** Two or more digital line sections interconnected in tandem in such a way that the specified rate of digital signals transmitted and received is the same over the whole length of the line path between the two terminal digital distribution frames (or equivalent). (See Figure 6 in Annex C.)

4023 **digital line section:** Two consecutive line terminal equipment, their interconnection transmission medium and in-station cabling between them and their adjacent digital distribution frames (or equivalents), which together provide the whole of the means of transmitting and receiving between two consecutive digital distribution frames (or equivalents) a digital signal of specified rate.

#### NOTES

1 Line terminal equipments may include the following:

- regenerators;
- code converters;
- scramblers;
- remote power feeding;
- fault location;
- supervision.

2 A digital line section is a particular case of a digital section.

4024 **digital line system:** A specific means of providing a digital line section. (See Figure 6 in Annex C.)

4025 **digital multiplexer:** Equipment for combining, by time division multiplexing, two or more tributary digital signals into a single composite digital signal.



4026 **digital multiplex equipment:** The combination of a digital multiplexer and digital demultiplexer at the same location.

4027 **digital multiplex hierarchy:** A series of digital multiplexers graded according to capability so that multiplexing at one level combines a defined number of digital signals, each having the digit rate prescribed for a lower order, into a digital signal having a prescribed digit rate which is then available for further combination with other digital signals of the same rate in a digital multiplexer of the next higher order.

4028 **digital path:** The whole of the means of transmitting and receiving a digital signal of specified rate between those two digital distribution frames (or equivalent) at which terminal equipments or switches will be connected. Terminal equipments are those at which signals at the specified bit rate originate or terminate.

NOTES

- 1 A digital path comprises one or more sections.
- 2 Where appropriate, the bit rate should qualify the title.
- 3 Digital paths interconnected by digital switches form a digital connection.

4029 **digital radio path:** Two or more digital radio sections interconnected in tandem in such a way that the specified rate of the digital signal transmitted and received is the same over the whole length of the radio path between the two terminal digital distribution frames (or equivalent).

4030 **digital radio section:** Two consecutive radio terminal equipments and their interconnection transmission medium which together provide the whole of the means of transmitting and receiving between two consecutive digital distribution frames (or equivalents) a digital signal of specified rate. (See Figure 6 in Annex C.)

NOTE – A digital radio section is a particular case of a digital section.

4031 **digital radio system:** A specific means of providing a digital radio section. (See Figure 6 in Annex C.)

4032 **digital section:** The whole of the means of transmitting and receiving between two consecutive digital distribution frames (or equivalent) a digital signal of specified rate. (See Figure 6 in Annex C.)

NOTES

- 1 A digital section forms either a part or the whole of a digital path.
- 2 Where appropriate, the bit rate should qualify the title.

4033 **digital terminal circuit section:** A digital terminal circuit section comprises the two directions of transmission, for one equivalent voice-frequency signal, through a digital terminal. For each direction of transmission, the digital terminal circuit section extends from a particular 64 kbit/s time slot appearance, in the input bit sequence to the digital terminal, to the corresponding 64 kbit/s time slot appearance in the output bit sequence of the digital terminal. (Rec. M.585)

4034 **fault definition program:** Program which collects fault information and defines faulty transmission links. (Rec. M.495)

4035 **group:** A group consists of a group link connected at each end to terminal equipments. These terminal equipments provide for the setting-up of a number of telephony channels (generally 12), one or more data transmission or facsimile channels, etc.

It occupies a 48 kHz frequency band. Figures 1/M.320, 2/M.320 and 3/M.320 show various possible arrangements of telephony channels in a basic group B (60 to 108 kHz). (See Figures 1, 2, 3 and 4 in Annex C.)

4036 **group link:** The whole of the means of transmission using a frequency band of specified width (48 kHz) connecting two terminal equipments, for example, channel translating equipments, wideband sending and receiving equipments (modems, etc.). The ends of the link are the points on group distribution frames (or their equivalent) to which the terminal equipments are connected.

It can include one or more group sections. (See Figures 1, 2, 3 and 4 in Annex C.)

- 4037 **group section:** The whole of the means of transmission using a frequency band of specified width (48 kHz) connecting two consecutive group distribution frames (or equivalent points). (See Figures 1, 2, 3 and 4 in Annex C.)
- 4038 **international automatic circuit:** The whole of the international line and the outgoing and incoming equipments (or both-way equipment) proper to the automatic circuit considered. The ends of this circuit are defined by the circuit access points (see definition for *circuit access points*).
- 4039 **international chain:** An international chain is made up of one or more 4-wire international circuits. These are connected on a 4-wire basis to international circuits (in transit international centers) or to national systems (in terminal international centers). (See Figure 1/M.560 in Annex C of this Recommendation.) (Rec. M.560)
- 4040 **international connection:** Whole of the means joining temporarily two subscribers and enabling them to exchange information.
- 4041 **international data transmission link:** The international data transmission link, that supports the aggregate transmission from the terminal multiplexing equipment of the international data transmission system, is defined as existing between link termination points (LTP). LTPs are digital interface points at the aggregate input and outputs of multiplexers. The link may be a carrier over all digital, all analogue or mixed transmission path. In case of analogue routing, the modems are considered to be part of the link. (Rec. M.1300)
- 4042 **international data transmission system:** An international data transmission system is comprised of an international data transmission link combined with multiplexing equipment<sup>1)</sup> at each end and is primarily used for the point-to-point transmission of international leased and special circuits. A system may be carried as a channel on a higher order system.
- 4043 **international leased circuit:** The whole of the assembly of lines and apparatus connecting the renter's terminal equipment (e.g. data modem) in one country to the renter's terminal equipment in another. The interfaces between the circuit and the renter's terminal equipment will be defined by the respective Administrations. (See Figure 2/M.1010 in Annex C of this Recommendation.) (Rec. M.1010)
- 4044 **international line:** The transmission system contained between the line access points (see 2/M.565) of the two terminal international centers. Where a digital international center is interfaced by primary (or higher order) digital paths, a line access point on a per circuit basis may not exist. In such cases, the international line is deemed to end at the digital path access point nearest the international center.
- 4045 **international line:** The whole of the assembly of international and national circuit sections between terminal international centers. (See Figure 2/M.1010 in Annex C of this Recommendation.) (Rec. M.1010)
- 4046 **international link:** The whole of the assembly of international and national circuit sections between terminal national centers. (See Figure 2/M.1010 in Annex C of this Recommendation.) (Rec. M.1010)
- 4047 **international main section:** The whole of the assembly of national and international group or supergroup sections, between the defined test access points at the two terminal international centers (see Recommendation M.460). These access points should be the same points as those for the ends of the national main sections involved in the leased link. (See Figure 1/M.900 in Annex C of this Recommendation.) (Rec. M.900)
- 4048 **international section:** The digital, group, supergroup, etc., sections between two adjacent frontier stations in different countries constitute an international section. Some international sections may be a single digital, group, supergroup, etc., section routed over long submarine cable systems. If the international group, supergroup, etc., is routed via intermediate countries without the digital path being demultiplexed to its characteristic bit rate/basic frequency band, the frontier stations at the ends of the international digital, group, supergroup, etc., section are still considered to be adjacent.

---

<sup>1)</sup> Multiplexing equipment includes digital cross connect equipment as defined in this Recommendation. (Rec. M.1300)

4049 **international telephone connection:** A complete international telephone connection has three parts, as shown in Figure 1/M.560 in Annex C of this Recommendation:

- an international chain;
- two national systems, one on each end. (Rec. M.560)

4050 **line access point:** A point used by the CCITT to define the limits of an international line and from which measurements are made. Only one “line access point” exists at each end of an international line. The precise location of each such point depends on the Administration concerned. (Rec. M.565)

4051 **line link (using symmetric pairs, coaxial pairs, radio-relay link, etc.):** A transmission path, however provided, together with all the associated equipment, such that the bandwidth available, while not having any specific limits, is effectively the same throughout the length of the link.

Within the link there are no direct filtration points nor any through-connection points for groups, supergroups, etc., and the ends of the link are the points at which the band of line frequencies is changed in some way or other. (See Figures 2, 3 and 4 in Annex C.)

4052 **main section:** The sections into which a digital path or group, supergroup, etc., link is divided by the digital path, group, supergroup, etc., control and subcontrol stations are called main sections. A main section is the portion of the digital path or group, supergroup, etc., link between two adjacent stations having control functions. In many cases, these two stations are in different countries. In the case of a country which has elected to have more than one station with control functions, a main section will lie wholly within that country. (See Figure 2/M.460 in Annex C of this Recommendation.)

4053 **mastergroup:** A mastergroup consists of a mastergroup link terminated at each end by terminal equipments. These terminal equipments provide for the setting-up of five supergroup links or sections occupying frequency bands separated by 8 kHz in a 1232 kHz band.

The basic mastergroup consists of supergroups 4, 5, 6, 7 and 8 within the band of frequencies 812 kHz to 2044 kHz. (See Figures 1, 2, 3, 4 and 1/M.340 in Annex C of this Recommendation.)

4054 **mastergroup link:** The whole of the means of transmission using a frequency band of specified width (1232 kHz) connecting two terminal equipment, for example, supergroup translating equipment, wideband sending and receiving equipment (modem, etc.). The ends of the link are the points on mastergroup distribution frames (or their equivalent) to which the terminal equipment is connected.

It can include one or more mastergroup sections. (See Figures 1, 2, 3 and 4 in Annex C.)

4055 **mastergroup section:** The whole of the means of transmission using a frequency band of specified width (1232 kHz) connecting two consecutive mastergroup distribution frames (or equivalent points). (See Figures 1, 2, 3 and 4 in Annex C.)

4056 **mixed analogue/digital channel:** A mixed analogue/digital channel is a one-way transmission capability provided over an analogue transmission system with transmultiplexer equipment at one end and transmultiplexer or analogue translating equipment at the other end. Where the end of the channel is provided by transmultiplexer equipment, the channel appears as a 64 kbit/s time slot and a digital distribution frame at the output of the transmultiplexing equipment in a digital path at a specified level of the digital hierarchy. Where the end of the channel is provided by analogue translating equipment, it appears at voice frequency. (See Figures 8 and 9 in Annex C.)

4057 **mixed analogue/digital circuit:** A mixed analogue/digital circuit comprises any combination of circuit sections that includes one or more analogue to digital processes. Mixed analogue/digital circuits may terminate at either end in analogue or digital switching machines. (Rec. M.590)

4058 **muldex:** A contraction of multiplexer-demultiplexer. The term may be used when the multiplexer and demultiplexer are associated in the same equipment.

NOTE – When used to describe an equipment, the function of the equipment should qualify the title, e.g. PCM muldex, data muldex, digital muldex.

4059 **multiplex:** Designating or pertaining to an installation in which a common transmission channel is divided into several separate channels each capable of transmitting signals independently in the same direction. (Rec. R.140)

4060 **multiplex section:** Multiplex section or synchronous transport module of the synchronous digital hierarchy. For complete definition, see Recommendation G.708.

4061 **multiterminal service circuit:** A telephone or teleprinter (teletypewriter) service circuit serving more than two stations and having at least one branching point. On each branch of this circuit a certain number of stations can be connected in series. Every station served can enter the circuit individually. (See Figure 2/M.100 in Annex C of this Recommendation.) (Rec. M.100)

4062 **national line:** The whole of the assembly of national circuit sections connecting the terminal national center to the terminal international center. When a distinction is needed to indicate the transmission direction in one country, the expressions national sending line, that is, outgoing from the center and national receiving line, that is, incoming to the center, may be used. (See Figure 2/M.1010 in Annex C of this Recommendation.) (Rec. M.1010)

4063 **national main section:** The whole of the assembly of national group or supergroup sections containing the defined test access points at the terminal national center and defined test access point at the terminal international center. (See Figure 1/M.900 in Annex C of this Recommendation.) (Rec. M.900)

4064 **national section:** The digital sections and group, supergroup, etc., sections between a station with control or subcontrol functions and a frontier station within the same country are termed comprehensively a national section. A national section will usually comprise several digital, group, supergroup, etc., sections. The digital, group, supergroup, etc., sections between the two stations with control functions within one country also constitute a national section.

4065 **national system:** This system may comprise one or more 4-wire amplified national circuits with a 4-wire interconnection, and circuits with 2-wire connection to terminal exchanges and subscribers. (See Figure 1/M.560 in Annex C of this Recommendation.) (Rec. M.560)

4066 **network image:** Software description of the transmission network to be protected. (Rec. M.495)

4067 **normal transmission link/equipment: normal digital block, group, supergroup, etc.:** A transmission link/equipment or a digital block, group, supergroup, etc., which is used for transmission under normal operating conditions. (Rec. M.495)

4068 **omnibus service circuit:** A telephone or teleprinter (teletypewriter) service circuit serving more than two stations connected in series, any or all of which may make connection to the service circuit simultaneously. (See Figure 1/M.100 in Annex C of this Recommendation.) (Rec. M.100)

4069 **PCM multiplex equipment:** Equipment for deriving a single digital signal at a defined digit rate from two or more analogue channels by a combination of pulse code modulation and time division multiplexing (multiplexer) and also for carrying out the inverse function (demultiplexer).

The term should be preceded by the relevant equivalent binary digit rate, e.g. 2048 kbit/s PCM multiplex equipment.

4070 **primary block (American: digroup):** A basic group of PCM channels assembled by time division multiplexing.

NOTE – The following convention could be useful:

Primary block  $\mu$  – a basic group of PCM channels derived from 1544 kbit/s PCM multiplex equipment.

Primary block A – a basic group of PCM channels derived from 2048 kbit/s PCM multiplex equipment. (See Figure 5 in Annex C.)

4071 **protection switching:**

NOTE – This term was used in the CCITT *Red Book* and has been deleted. For more information, see the definitions for terms relating to direct transmission restoration (protection link switching) and automatic and semi-automatic transmission restoration (protection network switching) in Recommendation M.495.

4072 **redundancy; standby:** That redundancy wherein one means for performing a required function is intended to operate while the alternative means are inoperative until needed.

4073 **regulated line section (symmetrical pairs, coaxial pairs or radio-relay links):** In a carrier transmission system, a line section on which the line-regulating pilot or pilots are transmitted from end to end without being subjected to any intermediate amplitude regulation associated with the pilot or pilots.

4074 **restoration; recovery:** That event when the item regains the ability to perform a required function after a fault.

4075 **restoration algorithm:** Method for forming restoration links for faulty normal transmission links. (Rec. M.495)

4076 **restoration control center:** A center supervising all or part of normal and restoration transmission systems. (See Figure 5/M.495 in Annex C of this Recommendation.)

NOTE – A restoration control center can be included within a control center which is not dedicated to restoration. (Rec. M.495)

4077 **restoration control point (RCP):** The restoration control point (RCP) is an element within the general maintenance organization for the international telecommunication services. It initiates and coordinates service restoration activities in case of failures or planned outages of transmission systems in accordance with plans and ad hoc arrangements agreed to by the technical services of the Administration concerned. (Rec. M.20)

4078 **restoration control program:** A decision making program which controls the restoration processes. (Rec. M.495)

4079 **restoration link/equipment:** A transmission link/equipment which is used for transmission when the normal link/equipment is not available.

NOTES

1 A restoration link or equipment is generally idle under normal operating conditions, but might be used under these conditions by low-priority traffic for which a lower degree of service availability is accepted.

2 Note 1 may not apply to 1 + 1 type restoration systems where both links are carrying the traffic. (Rec. M.495)

4080 **restoration network:** The network formed by all restoration links. (Rec. M.495)

4081 **restoration procedure time:** Time interval between the confirmation of a fault and completion of the processing and transmission of the control signals required to effect restoration. (See Figure 6/M.495 in Annex C of this Recommendation.) (Rec. M.495)

4082 **restoration time:** The time from the occurrence of the failure to the restoration of the faulty transmission. (See Figure 6/M.495 in Annex C of this Recommendation.) (Rec. M.495)

4083 **restoration transfer time:** Time interval between completion of the processing and transmission of the control signals required to effect restoration and the completion of transmission restoration operations. (See Figure 6/M.495 in Annex C of this Recommendation.) (Rec. M.495)

4084 **restoration unit:** All normal and restoration links and associated equipment capable of being controlled from a particular control center. (See Figure 5/M.495 in Annex C of this Recommendation.)

NOTE – Some networks areas may be controlled from more than one control center. (Rec. M.495)

4085 **Sub-control station:** A sub-control station is a point within the general maintenance organization which fulfills the sub-control responsibilities of the circuit, group, supergroup, etc., digital section assigned to it. (Rec. M.900)

4086 **supergroup**: A supergroup consists of a supergroup link connected at each end to terminal equipments. These terminal equipments provide for the setting-up of five group links or sections occupying adjacent frequency bands in a 240 kHz band or for one or more data transmission or facsimile channels, etc.

The basic supergroup occupies the band 312 to 552 kHz. Figure 1/M.330 (Annex C of this Recommendation) shows the position of groups and channels within the supergroup. (See also Figures 1, 2, 3 and 4 in Annex C.)

4087 **supergroup assembly link**: The whole of the means of transmission using a frequency band of specified width (3716 kHz) connecting two 15 supergroup assembly distribution frames (or equivalent points). It can be made up of a number of 15 supergroup assembly sections. When terminal equipments are connected to both ends, it becomes a constituent part of a 15 supergroup assembly for carrying telephony or telegraphy channels or data or facsimile, etc. (See Figures 2, 3 and 4 in Annex C.)

4088 **supergroup link**: The whole of the means of transmission using a frequency band of specified width (240 kHz) connecting two terminal equipments, for example, group translating equipments, wideband sending and receiving equipments (modem, etc.). The ends of the link are the points on supergroup distribution frames (or their equivalent) to which the terminal equipments are connected.

It can include one or more supergroup sections. (See Figures 1, 2, 3 and 4 in Annex C.)

4089 **supergroup section**: The whole of the means of transmission using a frequency band of specified width (240 kHz) connecting two consecutive supergroup distribution frames (or equivalent points). (See Figures 1, 2, 3 and 4 in Annex C.)

4090 **supermastergroup**: A supermastergroup consists of a supermastergroup link connected at each end to terminal equipments. These terminal equipments provide for the setting-up of three mastergroup links or sections separated by two free spaces of 88 kHz and occupying a band whose total width is 3872 kHz. The basic supermastergroup is composed of mastergroups 7, 8 and 9 occupying the frequency band 8516-12 388 kHz. (See Figures 1, 2, 3, 4 and 1/M.350 in Annex C of this Recommendation.)

4091 **supermastergroup link**: The whole of the means of transmission using a frequency band of specified width (3872 kHz) connecting two terminal equipments, for example, supergroup translating equipments, wideband sending and receiving equipments (modem, etc.). The ends of the link are the points on mastergroup distribution frames (or their equivalent) to which the terminal equipments are connected.

It can include one or more mastergroup sections. (See Figures 1, 2, 3 and 4 in Annex C.)

4092 **supermastergroup section**: The whole of the means of transmission using a frequency band of specified width (3872 kHz) connecting two consecutive supermastergroup distribution frames (or equivalent points). (See Figures 1, 2, 3 and 4 in Annex C.)

4093 **telecommunication path**: The continuous course taken by a transmission signal between two points.

#### NOTES

1 This may be a physical transmission medium, a frequency band in a frequency multiplex, a time slot in a time division multiplex, etc.

2 The path includes the transmission media and the means used for connecting them together. (Rec. Q.9)

4094 **terminal international center (TIC)**: The international center (for example, an international repeater station) serving the renter in the country in which the renter's installation is situated. There will be two terminal international centers in an international leased group or supergroup link, or more in the case of a multiterminal link. (See Figure 1/M.900 in Annex C of this Recommendation.) (Rec. M.900)

4095 **terminal international center (TIC):** The terminal international center (TIC) for leased and special circuits is the international center serving the renter in the country in which the renter's installation is situated. It marks the interface of the international and national lines and is normally located in association with a terminal international center for the international public telephony circuits.

Some Administrations may wish to locate the TIC for international leased and special circuits independently of that for public telephony circuits.

In all cases there will be a transmission maintenance point (international line) (TMP-IL) (see Recommendation M.1014) located at each TIC for leased and special circuits.

There will be two TICs in a point-to-point international circuit. There may be more in a multiterminal circuit. (See Figure 2/M.1010 in Annex C of this Recommendation.) (Rec. M.1010)

4096 **terminal national center (TNC):** The nearest national installation (for example, a repeater station) to which the renter's equipment is connected by the terminal national section. This center will normally be staffed and equipped to make transmission measurements. (See Figure 1/M.900 in Annex C of this Recommendation.) (Rec. M.900)

4097 **terminal national center (TNC):** The national center (e.g. repeater station, telephone exchange) that is:

- nearest to the renter's installation;
- provided with a circuit so that transmission measurements can be made by the appropriate staff. (See Figure 2/M.1010 in Annex C of this Recommendation.) (Rec. M.1010)

4098 **terminal national section:** The lines and apparatus between the defined test access points at the interface in the renter's premises and corresponding defined access points at the terminal national center. (See Figure 1/M.900 in Annex C of this Recommendation.) (Rec. M.900)

4099 **terminal national section:** The lines and apparatus connecting the renter's installation with the terminal national center concerned. There may be intermediate installations (e.g. telephone exchanges) in the terminal national section but they are assumed to have no testing facilities normally available. (See Figure 2/M.1010 in Annex C of this Recommendation.) (Rec. M.1010)

4100 **through-group connection point:** When a group link is made up of several group sections, they are connected in tandem by means of through-group filters at points called through-group connection points. (See Figures 2, 3 and 4 in Annex C.)

4101 **through-mastergroup connection point:** When a mastergroup link is made up of several mastergroup sections, they are connected in tandem by means of through-mastergroup filters at points called through-mastergroup connection points.

4102 **through-supergroup connection point:** When a supergroup link is made up of several supergroup sections, they are connected in tandem by means of through-supergroup connection points. (See Figures 2, 3 and 4 in Annex C.)

4103 **through-supermastergroup connection point:** When a supermastergroup link is made up of several supermastergroup sections, they are connected in tandem by means of through-supermastergroup filters at points called through-supermastergroup connection points.

4104 **through-15 supergroup assembly connection point:** When a 15 supergroup assembly link is made up of several 15 supergroup assembly sections, these sections are interconnected in tandem by means of through-15 supergroup assembly filters at points called through-15 supergroup assembly connection points.

NOTE – In a country normally using mastergroup and supermastergroup arrangements, a 15 supergroup assembly can be through-connected without difficulty at the supermastergroup distribution frame by means of through-supermastergroup filters. In this case, the 15 supergroup assembly is through-connected to position 3 (8620-12336 kHz) instead of position 1 (312-4028 kHz) as required by the definition of the through-connection point of such an assembly. The point where this through-connection is made is a through-supermastergroup connection point and not a through-15 supergroup assembly connection point.

4105 **transfer time:** The time interval after the confirmation that a fault requires a restoration to the completion of the transmission restoration operation. (See Figure 6/M.495 in Annex C of this Recommendation.) (Rec. M.495)

4106 **transmission:** The action of conveying signals from one point to one or more other points.

NOTES

1 Transmission can be effected directly or indirectly, with or without intermediate storage.

2 The use of the English word "transmission" in the sense of emission is deprecated. (Recs. G.701, I.112)

4107 **transmission channel:** (See the definitions of **analogue channel**, **digital channel** and **mixed analogue digital channel**.)

4108 **transmission link:** A means of transmission with specified characteristics between two points.

NOTE – The type of the transmission path or the capacity is normally indicated, e.g. radio link, coaxial link, or 2048 Kbit/s link. (Rec. I.112)

4109 **transmultiplexer:** An equipment that transforms frequency division multiplexed signals (such as group or supergroup) into corresponding time division multiplexed signals that have the same structure as those derived from PCM multiplex equipment. The equipment also carries out the inverse function. (See Figure 6 in Annex C.)

4110 **transmission restoration:** The different actions taken in order to restore the transmission of a signal affected by a transmission fault. (Rec. M.495)

4111 **transmission restoration control function:** This is the function which decides whether restoration is necessary on the basis of information from the link supervision system or link alarms.

NOTE – The control function might be included in a specific equipment, or in the transmission restoration equipment itself, or within a restoration control center. Control decisions can also be taken by people in, for example, a control center. (Rec. M.495)

4112 **transmission restoration equipment:** The part of the transmission restoration system that switches the transmission from the normal link to a restoration link. (Rec. M.495)

4113 **transmission restoration function:** The ability to perform under stated conditions and within given time constraints the transmission restoration.

NOTES

1 This function is aimed at increasing the transmission availability; it can provide transmission link supervision and control, the sending and receiving of control and check signals, and the changeover from normal to an alternative link, if necessary by assembling links.

2 This function can allow the restoration of failed transmission systems, links, groups, digital blocks, equipment, etc., as well as the restoration for maintenance purposes such as planned outages, or to remedy conditions that affect transmission such as fading.

3 The transmission restoration function can be implemented by equipment that is dedicated to it, or by equipment that has other functions, such as, for example, automatic digital distribution frames. (Rec. M.495)

4114 **transmission restoration function: 1 + 1 restoration:** 1 + 1 restoration is that category of transmission restoration function in which one transmission link is substituted for another associated link, generally on another transmission route. (See Figure 3/M.495 in Annex C of this Recommendation.) (Rec. M.495)

4115 **transmission restoration function: automatic or semi-automatic transmission rerouting (protection network switching):** Automatic or semi-automatic transmission rerouting is that category of transmission restoration function in which transmission links are assembled together and substituted for another link.

NOTE – This reflects a configuration in which a certain number of links form a restoration network and protect normal links. Within a given transmission station, or for a given switching equipment, M links protect N links. It is recommended to use the expression N + M automatic transmission rerouting to designate such a configuration.

Figure 2/M.495 (Annex C of this Recommendation) shows an example. In station A, M restoration links can be used for restoration of N normal links. A link between A and B can be restored, for example, directly or via C. (Rec. M.495)



4116 **transmission restoration function: direct transmission restoration (protection link switching):** Direct transmission restoration is that category of transmission restoration function in which one transmission link between two stations is substituted for another between those two stations.

NOTE – This reflects a configuration in which M links protect N links, or in which N + M links give redundancy to a relation requiring N links, with the extremities of all links in the same locations. It is recommended to use the expression N + M direct transmission restoration to designate such a configuration. (See Figure 1/M.495 in Annex C of this Recommendation.) (Rec. M.495)

4117 **transmission restoration function: manual transmission rerouting:** Manual transmission rerouting is that category of transmission restoration function in which one transmission link is replaced manually by another when a complete or partial transmission route failure has occurred or when the normal route restoration link is not available due to a previous or simultaneous interruption, or when there is no such restoration link provided.

NOTE – Such rerouting is normally effected using plugs and cords. (Rec. M.495)

4118 **transmission restoration system:** A system that can be used to implement the transmission restoration function. An example is shown in Figure 4/M.495 in Annex C of this Recommendation. (Rec. M.495)

4119 **transmission route:** A transmission facility on a specific medium used by a certain number of transmission systems between two stations.

#### NOTES

1 For example, one cable between two stations could be regarded as one transmission route (whatever the number of systems using this cable might be) and a radio system between these two points could be regarded as another route.

2 This definition represents a physical route; this is different from the term “route” which is defined in Recommendations E.600, Q.9 and Z.341, which represents a logical route. (Rec. M.495)

4120 **transmission route diversity:** The provision of at least two links between two nodes in a transmission network which are routed over different transmission routes.

NOTE – In case of a failure of one link, transmission route diversity allows some traffic between the two nodes still to be carried over the remaining link(s). (Rec. M.495)

4121 **virtual container:** Virtual container of the synchronous digital hierarchy (see Recommendation G.708).

4122 **waiting time:** Time interval after the recognition of a potential failure and its confirmation as a fault requiring restoration. (See Figure 6/M.495 in Annex C of this Recommendation.) (Rec. M.495)

## 5 Switching and signalling

5000 **automatic switching equipment:** The part of an international exchange concerned with switching operations for routing the call in the desired direction.

5001 **call control:** The set of functions used to process a call (e.g. provide service features and establish, supervise, maintain and release connections). (Rec.Q.1290)

5002 **call/service processing:** The execution of logic by a switching or control function to advance a call attempt of a service request. (Rec. Q.1290)

5003 **connection control:** The set of functions used for setting up, maintaining and releasing a communication path between two or more users or a user and a network entity, e.g. a dual tone multifrequency receiver. (Rec. Q.1290)

5004 **exchange:** An aggregate of traffic carrying devices, switching stages, controlling and signalling means, and other functional units at a network node that enables subscriber lines, telecommunication circuits and/or other functional units to be interconnected as required by individual users. (Rec. I.112)

5005 **digital exchange:** An exchange that switches information in digital form through its switching devices. (Rec. Q.9)

5006 **digital switching:** The process in which connections are established by operations on digital signals without converting them to analogue signals. (Rec. Q.9)

5007 **initial address message (IAM):** A type of message sent in the forward direction at call set-up. It contains address information and other information relating to the routing and handling of the call. (Rec. Q.9)

5008 **signalling information:** The information content of a signal or a signalling message. (Rec. Q.9)

5009 **signalling link:** A transmission means which consists of a signalling data link and its transfer control functions, used for reliable transfer of a signalling message. (Recs. M.770, Q.9)

5010 **signalling network:** A network used for signalling and consisting of signalling points and connecting common channel signalling links. (Rec. Q.9)

5011 **signalling system:** The procedures for the interpretation and use of a repertoire of signals together with the hardware and/or software needed for the generation, transmission, and reception of these signals. (Rec. Q.9)

5012 **signalling system administrative control:** A signalling system administrative control is a point within the general maintenance organization which coordinates the various organizational units that may have functional responsibility for individual sub-systems which comprise a common channel signalling system. (Rec. M.782)

5013 **signalling system administrative sub-control:** A signalling system administrative sub-control is a point within the general maintenance organization, located at the distant terminal of a signalling system administrative control, which has similar responsibilities with respect to its own terminal. (Rec. M.782)

5014 **switching stage:** An aggregate of switching devices constituting a subset of the switching network in an exchange and designed to operate as a single unit from a traffic handling point of view. (Rec. Q.9)

5015 **switching network:** The switching stages of a telecommunication exchange taken collectively. (Rec. Q.9)

5016 **signalling point:** A node in the signalling network which either originates and receives signal messages, or transfers signal messages from one signalling link to another, or both. (Rec. Q.9)

5017 **signal transfer point:** A signalling point with the function of transferring signalling messages from one signalling link to another. (Rec. Q.9)

## 6 Integrated services digital network (ISDN)

6000 **ISDN interface management services:** Services defined on the user network interface and which provide a customer with management capabilities. (Rec. M.3600)

6001 **local exchange center:** An organization that is in charge of operating and maintaining local exchanges and subscriber accesses. It may contain people, local exchanges and local exchange operation systems, which together have the responsibility for and capability of maintaining local exchanges and ISDN subscriber accesses. (Rec. M.3600)

6002 **local exchange operation system (LE-OS):** A system that is located in a local exchange center and performs local exchange operation functions to maintain local exchange and subscriber access. This OS may be realized as part of the local exchanges. This OS communicates with other OSs within other organizations in order to facilitate the management of subscriber access and ISDN services. (Rec. M.3600)

6003 **management entities:** Management entities are groups of capabilities that collectively provide management functions, such as operations, administration, maintenance and provisioning. For the network part, the functions may be implemented by a combination of capabilities in the network elements and operations systems. For the subscriber part, management functions may be contained within the subscriber installations. (Rec. M.3600)

6004 **management service provider (MSP):** An organization which provides management services to subscribers. An MSP contains people and operation systems, which together have the responsibility for and capability of providing a limited management service for ISDNs. (Rec. M.3600)

6005 **MSP management function (MSP-MF):** A group of functions for managing the subscriber installation or a part of subscriber installation. An MSP-MF cannot control the management functions of the subscriber access. If authorized, it can request information from the OAMC-MF about subscriber access. (Rec. M.3600)

6006 **MSP operation system (MSP-OS):** A system that is located in the MSP and performs part of management functions in SI. This OS communicates with other organizations in order to increase its management functions. (Rec. M.3600)

6007 **operation, administration and maintenance centre (OAMC):** An organization that is in charge of operating and maintaining networks and services. It is located somewhere within the network and contains people and operation systems, which together have the responsibility for and capability of maintaining ISDNs. (Rec. M.3600)

6008 **OAMC management function (OAMC-MF):** A group of functions for managing the network including facilities and services. The OAMC-MF may be distributed to several OAMC-OSs. (Rec. M.3600)

6009 **OAMC operation system (OAMC-OS):** A system that is located in OAMC and performs network operation functions to maintain ISDN facilities and services. This OS communicates with other OSs in other organizations in order to facilitate the management of ISDN facilities and services. (Rec. M.3600)

6010 **subscriber access management function (SAMF):** A group of functions for managing the subscriber access and communication with other management functions in other OSs. The SAMF may be distributed throughout a local exchange OS and OAMC-OS. (Rec. M.3600)

6011 **subscriber installation (SI):** An organization located in the subscriber side, that contains people, TEs, NEs and, if needed, operation systems, which together have the responsibility for and capability of maintaining subscriber installation facilities. (Rec. M.3600)

6012 **subscriber installation management function (SIMF):** A group of dedicated functions contained within the functional groups (as specified in Recommendation I.411) of the subscriber installation which may have one or more of the following purposes:

- interaction with the (human) user
- handling of maintenance protocol from the SAMF and/or MSP-MF
- control of internal testing and maintenance mechanisms.

It is considered that the functions may be distributed throughout the protocol layers implemented in the subscriber equipment, SI-OS, and MSP-OSs, including NT1 functions in some applications. (Rec. M.3600)

6013 **subscriber installation operation system (SI-OS):** A system that performs operation functions within SI and communicates with other OSs within other organizations in order to facilitate the management of subscriber access and ISDN services. This OS may be realized as part of the equipment located within the subscriber installation. (Rec. M.3600)

## 7 Testing, monitoring points, alarms

7000 **alarm indication signal (AIS):** An alarm indication signal is a signal associated with a prompt maintenance alarm of a defective maintenance entity and is, when possible, transmitted in the direction affected (downstream direction) as a substitute for the normal signal, indicating to other non-defective entities that a failure has been identified and that other maintenance alarms consequent to this failure should be inhibited. (Rec. M.20)

7001 **circuit access points:** Four-wire access points so located that as much as possible of the international circuit is included between corresponding pairs of these access points at the two centres concerned. These points, and their relative level (with reference to the transmission reference point) are determined in each case by the Administration concerned. They are taken as the basic practical reference points of known relative level to which other transmission measurements will be related. In other words, for measurement and lining-up purposes, the level at the appropriate circuit access point is the relative level with respect to which other levels are adjusted. (Rec. M.565)

7002 **continuity check:** A check made to a circuit or circuits in a connection to verify that an acceptable path (for transmission of data, speech, etc.) exists. (Rec. Q.9)

7003 **continuous checking:** At the time an item is active, it is being checked for good performance. If the item does not fulfill the test requirements, it is considered to have failed. (Rec. M.20)

7004 **deferred maintenance alarm (DMA):** A deferred maintenance alarm is generated when immediate action is not required by maintenance personnel, e. g. when performance falls below standard but the effect does not warrant removal from service, or generally, if automatic changeover to standby equipment has been used to restore service. (Rec. M.20)

7005 **fault correction:** Actions taken after a fault localization, intended to restore the ability of the faulty item to perform a required function.

7006 **fault localization; localization of faults:** The broad localization of fault consists in finding the general part of the equipment in which it exists. Fault finding consists of determining the faulty item of the equipment.

7007 **fault report point:** The generic definition of a fault report point is an element within the general maintenance organization for telecommunications services at each international centre or common for more than one international centre.

A fault report point is equipped with all the necessary facilities and arranged in such a way that it can receive fault reports relating to one or more type of network or service entities/objects from different sources or make such fault reports to other maintenance elements as appropriate, and initiate fault localization/diagnosis and clearing operations.

7008 **fault report point (circuit):** The fault report point (circuit) is an element within the general maintenance organization for the international automatic and semi-automatic telephone service at each international centre or common for more than one international centre.

The fault report point (circuit) is equipped with all the necessary facilities and arranged in such a way that it may receive fault reports relating to one or more specifically identified circuits from different sources or make such fault reports to other points and initiate the fault localization and clearing operations.

The fault report point (circuit) will undertake its given responsibilities and functions for circuits provided by wholly analogue transmission and switching systems, and those provided by a mixture of analogue and digital systems. (Rec. M.715)

7009 **fault report point (network):** The fault report point (network) is an element within the general maintenance organization for the international automatic and semi-automatic telephone service at each international centre or for more than one international centre. If more than one international centre is associated with a given relation, it is desirable to designate one fault report point (network) as the principle one for that relation. If such is not practical, one of the fault report points (network) or a central organization may be nominated to coordinate the activities of the various fault report points (network) that are involved.

Such arrangements provide the maintenance organization of other Administrations with a single point of contact for directing fault reports and service problems which involve more than one international centre.

While the fault report point (network) is essentially a maintenance element, it will in fact receive reports of network difficulties which may result in network management actions. In other cases, network fault reports may be explained by information already available to the network management (implementation and control point) and collected as a result of its network surveillance responsibility. Therefore, to avoid duplication of report points, considerable benefit is derived from close liaison between the fault report point (network) and the network management (implementation and control point). (See Recommendation E.413)

The fault report point (network) is equipped with all the necessary facilities and arranged in such a way as to enable it

- a) to receive from different sources, fault reports of difficulties on the international telephone network or of problems with the international telephone service that, at the time of reporting, cannot be related to specific circuits or, in some cases, even to a specific international centre; and
- b) to make such fault reports to other points and initiate the fault location and clearing operations. (Rec. M.716)

7010 **logistic delay:** The logistic delay is the period of time between the fault localization and arrival of the maintenance staff on site. In case of an ISDN, the logistic delay will depend on the type of failures and how they are reported, i. e. by prompt maintenance alarm (PMA), deferred maintenance alarm (DMA) or maintenance event information (MEI). (Rec. M.20)

7011 **loopback:** A mechanism incorporated into a terminal or into the network whereby the transmit path of a communication may be connected back upon the receive path.

7012 **complete loopback:** A complete loopback is a layer 1 [of the open system interconnection (OSI) model] mechanism which operates on the full bit stream. At the loopback point, the received bit stream shall be transmitted back towards the transmitting station without modification. (Rec. M.125)

7013 **digital loopback:** A digital loopback is a mechanism incorporated into a piece of equipment whereby a bidirectional communication path may be connected back upon itself so that some or all of the information contained in the bit stream sent on the transmit path is returned on the receive path. (Rec. M.125)

7014 **logical loopback:** A logical loopback acts selectively on certain information within a specified channel or channels and may result in some specified modification of the looped information. Logical loopbacks may be defined at any layer of the OSI model depending on the detailed maintenance procedure specified. (Rec. M.125)

7015 **non-transparent loopback:** A non-transparent loopback is one in which the signal transmitted beyond the loopback point (the forward signal) when the loopback is activated is not the same as the received signal at the loopback point. The forward signal may be a defined signal or unspecified. (Rec. M.125)

7016 **partial loopback:** A partial loopback is a layer 1 mechanism which operates on one or more specified channels multiplexed within the full bit stream. At the loopback point, the received bit stream associated with the specified channel(s) shall be transmitted back towards the transmitting station without modification. (Rec. M.125)

7017 **loopback application:** The maintenance phase for which the loopback operation is used. (Rec. M.125)

7018 **loopback control mechanism:** The means by which the loopback is operated and released from the loopback control point. (Rec. M.125)

7019 **loopback control point:** The loopback control point is the point which has the ability to directly control loopbacks. (Rec. M.125)

7020 **loopback point:** A loopback point is the location of the loopback. (Rec. M.125)

7021 **loopback requesting point:** The loopback requesting point is the point which requests the loopback control point to operate loopbacks.

NOTES

1 Loopback requests should be subject to identification and authorization.

2 Possible locations of loopback requesting points are: in the network, in the TMN, in maintenance service providers (MSP). (Rec. M.125)

7022 **loopback test pattern:** The information transmitted during the operation of the loopback in the channel or channels which are to be redirected by the loopback. (Rec. M.125)

7023 **maintenance entity assembly (MEA)**

The maintenance entity assembly is defined by the following principles:

- An MEA contains a group of maintenance entities (MEs) assembled for additional maintenance purposes.
- Principles that apply to MEs apply also the MEAs.
- An MEA may detect failures and maintenance event information which cannot be detected by MEs.
- An MEA may provide end-to-end maintenance alarm information which cannot be provided by MEs.

End-to-end information may be collected by using additional supervision means. (Rec. M.20)

7024 **maintenance event information (MEI):** This information has to be generated as a consequence of events when no immediate actions by the maintenance staff are required, because the total performance is not endangered. The maintenance actions can be performed on a scheduled basis or after the accumulation of maintenance event information indications. (Rec. M.20)

7025 **maintenance sub-entity (MSE):** The maintenance sub-entity is defined by the following principles:

- The different parts of an MSE constituting the maintenance entities (MEs) are interconnected at consecutive and easily identifiable interface points.
- When a failure occurs within an MSE it is desirable that the maintenance alarm information indication appears at the failed maintenance entity containing the MSE.
- A failed MSE should be identified as failed by the fault location process, but should lead only to the identification of the failed ME by the supervision process.
- An MSE generally corresponds to the item which is replaceable during routine operations in the event of failure. (Rec. M.20)

7026 **measurement:** A numerical assessment, in suitable units, of the value of a simple or complex quantity or magnitude.

7027 **network analysis point:** The network analysis point is an element within the general maintenance organization for the international automatic and semi-automatic telephone service associated with one or more international centres.

It receives information concerning service quality and faults not associated with specific circuits. It analyses all relevant information to investigate the problems involved. It may request the fault report point (network) to initiate investigatory and/or remedial actions in one or more maintenance centres in the home country or via a fault report point (network) in another country.

The network analysis point acts as a single point of contact for general enquiries concerning the day-to-day maintenance of the international telephone network, as may be made by the maintenance organization of other Administrations. (Rec. M.720)

7028 **point**

- a) to identify an element within a maintenance organization where specified functions are carried out. Examples of its use in this context are: fault report point circuit, restoration control point, testing point-transmission;
- b) to identify an electrical location in a circuit, group, digital path, etc., where access is required for testing purposes. Examples of its use in this context are: circuit access point, analogue link access point, digital path access point.

7029 **prompt maintenance alarm (PMA):** A prompt maintenance alarm is generated in order to initiate maintenance activities (normally immediately) by maintenance personnel to remove from service a defective equipment for the purpose of restoring good service and effecting repair of the failed equipment. (Rec. M.20)

7030 **protected monitoring point:** A protected monitoring point provides a digital interface at which it is possible to monitor the transmitted signal and to make measurements with suitable test equipment.

The degree of protection is considered to be sufficient when a variation of the pulse mask as given in Recommendation G.703 is less than x% with a short circuit at the protected monitoring point. (The value of x is for further study in connection with the electrical characteristics.)

NOTE – This definition is a working definition and is under study in Study Groups 4 and 15.

7031 **routine or periodic testing:** Items are tested periodically, initiated either by the system or by the maintenance staff. The frequency of the test depends on the importance of the item, the failure rate and the number of items of that type present in the element. (Rec. M.20)

7032 **service alarm (SA):** A service alarm is generated at maintenance entities at which the service originates and/or terminates to indicate that the particular service is no longer available (e. g. when primary block is no longer available for setting up connections, the PCM muldex will extend a service alarm indication to the exchange equipment). The service alarm should be generated when performance falls below a level specified for a particular service. This level may coincide with that for initiating also a prompt maintenance alarm. (Rec. M.20)

7033 **test:** A direct practical trial in whatever manner it may be made.

7034 **functional test:** A yes or no test made to indicate whether a circuit, equipment or part of an equipment will function or not function under actual working conditions.

7035 **limit test:** A test made to indicate whether a quantity would fall within or outside a pair of limits or boundaries.

7036 **testing point (line signalling):** The testing point (line signalling) is an element within the general maintenance organization for the international automatic and semi-automatic telephone service at each international centre. It carries out line signalling tests on international circuits using channel-associated signalling systems, e. g. R2, No. 5, whether provided by wholly analogue transmission and switching systems or by a mixture of analogue and digital systems.

NOTE – In practice, at digital international exchanges, a line access point at the circuit level may not exist when the exchanges are interfaced by primary (or higher order) digital paths. Thus, all signalling testing may need to be carried out from one location, generally the testing point (switching and interregister signalling). Signalling tests on Signalling System No. 6 are controlled and coordinated by the administrative control [see Recommendation M.762]. (Rec. M.718)

7037 **testing point (switching and interregister signalling):** The testing point (switching and interregister signalling) is an element within the general maintenance organization for the international automatic and semi-automatic telephone service at each international centre. It carries out tests concerned with switching and interregister signalling functions associated with international circuits, whether provided by wholly analogue transmission and switching systems or by a mixture of analogue and digital systems.

NOTE – In practice, at digital international exchanges, a line access point at the circuit level may not exist when the exchange is interfaced by primary (or higher order) digital paths. Thus, all signalling testing may need to be carried out from one location, generally the testing point (switching and interregister signalling). This would include line signalling aspects, if any. (Rec. M.719)

7038 **testing point (transmission):** The testing point (transmission) is an element within the general maintenance organization for the international automatic and semi-automatic telephone service at each international centre. It carries out transmission testing on international circuits whether provided by wholly analogue transmission and switching systems or by a mixture of analogue and digital systems. (Rec. M.717)

7039 **upstream failure indication (UFI):** The upstream failure indication given by a maintenance entity indicates that the signal arriving at that maintenance entity is defective. The UFI indicates that the failure has occurred upstream of this point and no unnecessary maintenance activities are initiated. (Rec. M.20)

7040 **yes or no test:** A test made to indicate whether a quantity or magnitude would fall above or below a specified limit or boundary defined to distinguish pass and fail conditions.

## Annex A

### Alphabetical list of definitions contained in the Recommendation

(This annex forms an integral part of this Recommendation)

4000	15 supergroup assembly	2027	attribute type
4001	15 supergroup assembly section	2028	attribute value
4004	access channel	2029	attribute value assertion
2000	accounting management	2025	attributes (generic network information model)
2001	action	2030	authentication
2002	actions (generic network information model)	2031	authority domain
2003	Administration (entity)	2032	authority relationship
2004	administration (task)	2033	authority relationship set
2005	agent	1000	automatic maintenance
2006	agent role	5000	automatic switching equipment
2007	alarm	3001	availability performance
7000	alarm indication signal (AIS)	1001	bearer service
2008	alarm status	2034	behaviour
2009	alarm surveillance	2035	billing integrity
2010	allomorphy	3002	bit error ratio (BER)
4005	analogue channel	2036	broadcast
4002	analogue circuit	2037	bus-type interface
4003	analogue circuit section	5001	call control
2011	analogue signal	5002	call/service processing
3000	anomaly	2038	cascaded network
2012	application association	2040	characteristic information
2013	application context	7001	circuit access points
2014	application entity	4006	circuit control station
2015	application process	4007	circuit sub-control station
2016	application protocol	4008	circuit, telecommunication circuit
2017	application protocol control information	2039	circuit-switched network
2018	application protocol data unit	2041	client-server relationship
2019	application service element (ASE)	2043	common management information service element (CMISE)
2020	architecture (functional)	2042	common management information service (CMIS)
2021	architecture (information)	7012	complete loopback
2022	architecture (physical)	2044	concentrator
2023	arena		
2024	attribute (of managed object)		
2026	attribute identifier		



2045	concrete syntax	4022	digital line path
2146	conditional package	4023	digital line section
2047	configuration management (CM)	4024	digital line system
4009	confirmation time	7013	digital loopback
2049	connection	4026	digital multiplex equipment
4010	connection	4027	digital multiplex hierarchy
5003	connection control	4025	digital multiplexer
2048	connection quality	4028	digital path
2050	connection retention	4029	digital radio path
2051	containment	4030	digital radio section
2052	containment hierarchy	4031	digital radio system
2053	containment tree	4032	digital section
7002	continuity check	2062	digital signal
7003	continuous checking	5006	digital switching
4011	control circuit	4033	digital terminal circuit section
4012	control equipment	2063	distinguished name
4013	control station	2064	domain
1002	controlled maintenance	3004	echo
4014	controlled station	3005	echo canceller
1003	corrective maintenance	3006	echo suppressor
2054	cross-connect (digital)	2068	embedded control channel (ECC)
2055	customer	2065	embedded operations channel (EOC)
2056	data collection processor	2066	emergency action
2057	data communication function (DCF)	3007	error
1004	data communication network	3008	error burst
2058	data communication network (DCN)	3009	error free seconds (ESF)
2059	data communication channel (DCC)	3010	errored second (ES) (in-service condition)
2060	deadlock	3011	errored second (out-of-service condition)
3003	defect	2067	event
1005	deferred maintenance	5004	exchange
7004	deferred maintenance alarm (DMA)	2069	F-interface
4015	detection time	3012	failure
2061	diagnostic tests	3013	fault
4016	digital block	2070	fault (maintenance) management
4017	digital channel	7005	fault correction
4018	digital circuit	4034	fault definition program
4019	digital circuit section	7006	fault localization; localization of faults
4020	digital connection	7007	fault report point
4021	digital distribution frame		
5005	digital exchange		

7008	fault report point (circuit)	2089	interoperable interface
7009	fault report point (network)	3014	interruption; break of service
2071	file	6000	ISDN interface management services
2072	fragment	7035	limit test
2073	fragment (generic network information model)	4050	line access point
2074	function attributes	4051	line link (using symmetric pairs, coaxial pairs, radio-relay link, etc.)
2075	function block	6001	local exchange centre
2078	functional architecture	6002	local exchange operation system (LE-OS)
2076	functional component	7014	logical loopback
2077	functional entity (FE)	7010	logistic delay
7034	functional test	7011	loopback
2079	generic definitions	7017	loopback application
2080	generic network information model (GNIM)	7018	loopback control mechanism
2081	global status	7019	loopback control point
4035	group	7020	loopback point
4036	group link	7021	loopback requesting point
2082	group relationship	7022	loopback test pattern
4037	group section	4052	main section
2083	human-machine adaption (HMA)	3015	maintainability (performance)
2084	information conversion function (ICF)	1008	maintenance
2085	information model	1009	maintenance entities (ME)
2086	inheritance	7023	maintenance entity assembly (MEA)
2087	inheritance hierarchy	7024	maintenance event information (MEI)
5007	initial address message (IAM)	1010	maintenance philosophy
1006	intelligent network (IN)	1011	maintenance policy
1007	interface	1012	maintenance strategy
4038	international automatic circuit	7025	maintenance sub-entity (MSE)
4039	international chain	3016	maintenance support (performance)
4040	international connection	2090	managed (open) systems
4041	international data transmission link	2091	managed domain
4042	international data transmission system	2092	managed element
4043	international leased circuit	2093	managed object
4044	international line	2094	managed object class
4045	international line	2095	managed object instance
4046	international link	2096	management application function (MAF)
4047	international main section	2097	management domain
4048	international section	6003	management entities
4049	international telephone connection		
2088	interoperability		

2098	management information base (MIB)	2119	network element function block (NEF)
2099	management information catalogue (MIC)	4066	network image
2100	management information library (MIL)	2120	non-repudiation
2101	management information tree	7015	non-transparent loopback
2102	management layer	4067	normal transmission link/equipment: normal digital block, group, supergroup, etc.
6004	management service provider (MSP)	2121	notification
2103	management subdomain	2122	notification (generic network information model)
2106	management system	2123	notification type
2104	manager	6008	OAMC management function (OAMC-MF)
2105	manager role	6009	OAMC operation system (OAMC-OS)
4053	mastergroup	2124	object
4054	mastergroup link	2125	object class
4055	mastergroup section	2126	object classes (generic network information model)
7026	measurement	2127	object instance
2107	mediation device (MD)	4068	omnibus service circuit
2108	mediation function block (MF)	1013	one stop shopping
2109	memory backup	6007	operation, administration and maintenance centre (OAMC)
2110	message	2128	operations
2111	message communication function (MCF)	2129	operations systems (OS)
2112	message syntax	2130	operations systems function block (OSF)
4056	mixed analogue/digital channel	2131	orchestration
4057	mixed analogue/digital circuit	2132	overhead and adaptation trail
6005	MSP management function (MSP-MF)	2133	packages
6006	MSP operation system (MSP-OS)	2134	packages (generic network information model)
4058	muldex	2135	packet-switched network
2113	multiple inheritance	2136	parallel (interface)
4059	multiplex	7016	partial loopback
4060	multiplex section	4069	PCM multiplex equipment
4061	multiterminal service circuit	2137	performance management (PM)
2114	(n)-layer managed object	2138	physical configuration
2115	name binding	7028	point
2116	name binding (generic network information model)	2139	polling
2117	naming tree	2140	presentation context
4062	national line	2141	presentation function (PF)
4063	national main section		
4064	national section		
4065	national system		
7027	network analysis point		
2118	network element (NE)		

1014	preventive maintenance	7032	service alarm (SA)
4070	primary block (American: digroup)	3023	service integrity
2142	private operating agencies	1016	service maintenance
7029	prompt maintenance alarm (PMA)	3024	service operability performance
3017	propagation performance	3025	service retainability performance
7030	protected monitoring point	2154	service status
4071	protection switching	3026	service support performance
2143	protocol	3027	severely errored second (SES) (in-service condition)
2145	protocol profile	3028	severely errored second (SES) (out-of-service condition)
2144	protocol suite	2155	signal trail
2146	provisioning	5017	signal transfer point
2147	Q-adapter (QA)	5008	signalling information
2148	Q-adapter function block (QAF)	5009	signalling link
2149	Q-interface	5010	signalling network
3018	quality of service	5016	signalling point
3019	random error	5011	signalling system
4072	redundancy; standby	5012	signalling system administrative control
2150	reference point	5013	signalling system administrative sub-control
4073	regulated line section (symmetrical pairs, coaxial pairs or radio-relay links)	2156	specialization
2151	relative distinguished name (RDN)	2157	star (interface)
3020	reliability (performance)	2158	status
2152	resource	4085	sub-control station
4075	restoration algorithm	2159	subclass
4076	restoration control centre	2160	subordinate managed object
4077	restoration control point (RCP)	6010	subscriber access management function (SAMF)
4078	restoration control program	6011	subscriber installation (SI)
4079	restoration link/equipment	6012	subscriber installation management function (SIMF)
4080	restoration network	6013	subscriber installation operation system (SI-OS)
4081	restoration procedure time	2161	superclass
4082	restoration time	4086	supergroup
4083	restoration transfer time	4087	supergroup assembly link
4084	restoration unit	4088	supergroup link
4074	restoration; recovery	4089	supergroup section
7031	routine or periodic testing	4090	supermastergroup
2153	security management		
3021	serveability performance		
1015	service		
3022	service accessibility performance		

4091	supermastergroup link	4103	through-supermastergroup connection point
4092	supermastergroup section	4100	through-group connection point
2162	support object	2176	TMN general function
5015	switching network	2173	TMN management function (TMN MF)
5014	switching stage	2174	TMN management service (TMN MS)
2163	synchronization	2175	TMN management service components (TMN MSC)
3029	system availability information point	2177	TMN user
2164	systems management application service element	3030	trafficability performance
2165	systems management function	2178	trail
2166	systems management functional unit	4105	transfer time
2167	systems management process	2179	transmission
2168	systems management service	4106	transmission
1017	telecommunication	4107	transmission channel
1018	telecommunication Administration	4108	transmission link
4093	telecommunication path	3031	transmission performance
1019	telecommunication service	4110	transmission restoration
2169	telecommunications management network (TMN)	4111	transmission restoration control function
1020	teleservice	4112	transmission restoration equipment
2170	template	4113	transmission restoration function
4094	terminal international centre (TIC)	4114	transmission restoration function: 1 + 1 restoration
4095	terminal international centre (TIC)	4115	transmission restoration function: automatic or semi-automatic transmission rerouting (protection network switching)
4096	terminal national centre (TNC)	4116	transmission restoration function: direct transmission restoration (protection link switching)
4097	terminal national centre (TNC)	4117	transmission restoration function: manual transmission rerouting
4098	terminal national section	4118	transmission restoration system
4099	terminal national section	4119	transmission route
2171	terminals	4120	transmission route diversity
7033	test	4109	transmultiplexer
7036	testing point (line signalling)	2180	transport
7037	testing point (switching and interregister signalling)	2181	transport network layer
7038	testing point (transmission)	7039	upstream failure indication (UFI)
2172	thresholding	2182	user
4104	through-15 supergroup assembly connection point		
4101	through-mastergroup connection point		
4102	through-supergroup connection point		

4121 virtual container  
4122 waiting time  
2183 work station (WS)  
2184 work station function block (WSF)  
2185 X-interface  
7040 yes or no test

## Annex B

### List of abbreviations and acronyms

(This annex forms an integral part of this Recommendation)

ADPCM	Adaptive dynamic pulse code modulation
AES	Aircraft earth station
AIS	Alarm indication signal
AMI	Alternate mark inversion
ANSI	American National Standards Institute
ASE	Application service element
ASN.1	Abstract syntax notation one
ATM	Asynchronous transfer mode
ATME No. 1	CCITT automatic transmission measuring equipment
ATME No. 2	CCITT automatic transmission measuring and signalling testing equipment
B6ZS	Bipolar with 6 zero substitution
B8ZS	Bipolar with 8 zero substitution
BCD	Binary coded decimal
BER	Bit error ratio
BES	Base earth station
BIS	Bringing into service
BRI	Basic rate interface
CCS	Common channel signalling
CCSS No. 7	CCITT common channel signalling system No. 7
CES	Coast earth station
CM	Configuration management
CME	Circuit multiplication equipment
CMIS	Common management information service
CMISE	Common management information service element
CMR	Common mode rejection

CMS	Circuit multiplication system
CRC	Cyclic redundancy check
CTP	Connection termination point
DA	Demand assignment
DA	Digital access
DCC	Data communication channel
DCE	Data circuit terminating equipment
DCF	Data communication function
DCME	Digital circuit multiplication equipment
DCN	Data communication network
DCP	Data coordination point
DMA	Deferred maintenance alarm
DTE	Data terminal equipment
DTMF	Dual tone multi-frequency
DXC	Digital cross-connect
ECC	Embedded control channel
ECMA	European Computer Manufacturers Association
EFS	Error free seconds
EOC	Embedded operations channel
ES	Errored second
ET	Exchange termination
ETSI	European Telecommunications Standards Institute
EUT	Equipment under test
FAS	Frame alignment signal
FDM	Frequency division multiplexing
FE	Functional entity
FEC	Forward error correction
FPLMTS	Future public land mobile telecommunication services
GES	Aeronautical ground earth station
GNIM	Generic network information model
GTP	Group termination point
HDB3	High density bipolar 3 code
HDTV	High definition television
HLPI	Higher layer protocol interworking
HMA	Human-machine adaption



ICF	Information conversion function
IN	Intelligent network
IPSS	International packet switched service
ISC	International switching centre
ISCC	International service coordination centre
ISDN	Integrated services digital network
ISM	In-service monitoring
ISMC	International switching maintenance centre
ISO	International Standards Organization
ISPC	International sound programme centre
ITC	International television centre
ITMC	International transmission maintenance centre
ITS	Insertion test signal
IVC	International video conference centre
LCL	Longitudinal conversion loss
LCTL	Longitudinal conversion transfer loss
LE	Local exchange
LE-OS	Local exchange operation system
LEC	Local exchange centre
LES	Land earth station
LMES	Land mobile earth station
LOF	Loss of frame
LOS	Loss of signal
LT	Line termination
LTP	Link terminal point
MAC	Multiple analogue components
MAF	Management application function
MCF	Message communication function
MD	Mediation device
ME	Maintenance entities
MEA	Maintenance entity assembly
MEI	Maintenance event information
MES	Mobile earth station
MF	Mediation function block
MF	Multi-frequency
MI	Maintenance information
MIB	Management information base

MIC	Management information catalogue
MIL	Management information library
MIS	Management information system
MML	Man-machine language
MOCS	Managed object conformance statements
MSE	Maintenance sub-entities
MSP	Management service provider
MSP-MF	MSP management function
MSP-OS	MSP operation system
MTBF	Mean time between failures
MTRS	Mean time to restore service
MTT	Marine test terminal
MTTF	Mean time to failure
MTTR	Mean time to repair
MU	Multiple destination unidirectional
NCC	Network control centre
NCP	Network control point
NCS	Network coordination station
NE	Network element
NEF	Network element function
NI	Network interface
NPO	Network performance objective
NSPC	National sound programme centre
NT	Network termination
NTC	National television centre
NTE	Network terminating equipment
OAM&P	Operations, administration, maintenance and provisioning
OAMC	Operations, administration and maintenance centre

OAMC-MF	OAMC management function
OAMC-OS	OAMC operation system
OCC	Operation control centre
OMAP	Operations, maintenance application part
ORP	Optical reference point
OS	Operation system
OSB	Output signal balance
OSF	Operation system function block
OSI	Open system interconnect
PABX	Private automatic branch exchange
PBC	Programme boocking centre
PBX	Private branch exchange
PCE	Path core element
PCM	Pulse code modulation
PCME	Packet circuit multiplication equipment
PDH	Plesiochronous digital hierarchy
PEP	Path end point
PF	Presentation function
PLMN	Public land mobile network
PM	Performance management
PMA	Prompt maintenance alarm
POH	Path overhead
PRBS	Pseudo-random bit sequence
PRI	Primary rate interface
PSPDN	Packet switched public data network
PSTN	Public switched telephone network
PVT	Performance verification test
QA	Q-interface adapter
QAF	Q-interface adapter function block
QOS	Quality of service
QRSS	Quasi-random signal source
r.m.s.	Root mean square
RCP	Restoration control point
RDN	Relative distinguished name
RFS	Ready for service

ROA	Recognized Operating Agency
RP	Renter's premises
SA	Service alarm
SAMC	Subscriber access maintenance centre
SAMF	Subscriber access management function
SCPC	Single channel per carrier
SDH	Synchronous digital hierarchy
SES	Severely errored second
SES	Ship earth station
SI	Subscriber installation
SI-OS	Subscriber installation operation system
SIMF	Subscriber installation management function
SPC	Stored program control
SPL	Sound pressure level
SPV	Service profile verification
STP	Signalling transfer point
TA	Terminal adapter
TCL	Transverse conversion loss
TCTL	Transverse conversion transfer loss
TDM	Time division multiplex
TDMA/DSI	Time division multiplexing access/ digital speech interpolation
TE	Telecommunication entity
TE	Terminal equipment
TIC	Terminal international centre
TMN	Telecommunications management network
TMN MF	TMN management function
TMN MS	TMN management service
TMN MSC	TMN management service components
TMP-IL	Transmission maintenance point - international line
TNC	Terminal national centre
TP	Termination point
TS	Time slot
TT	Test terminal
TTC	Telecommunication Technology Committee
TTP	Trail termination point

TVRO	Television receive only
UFI	Upstream failure indication
UI	Unit interval
UPT	Universal personal telecommunication
US	Unavailable seconds
VC	Video conference centre
WS	Work station
WSF	Work station function block

## Annex C

### Figures referred to in this Recommendation

(This annex forms an integral part of this Recommendation)

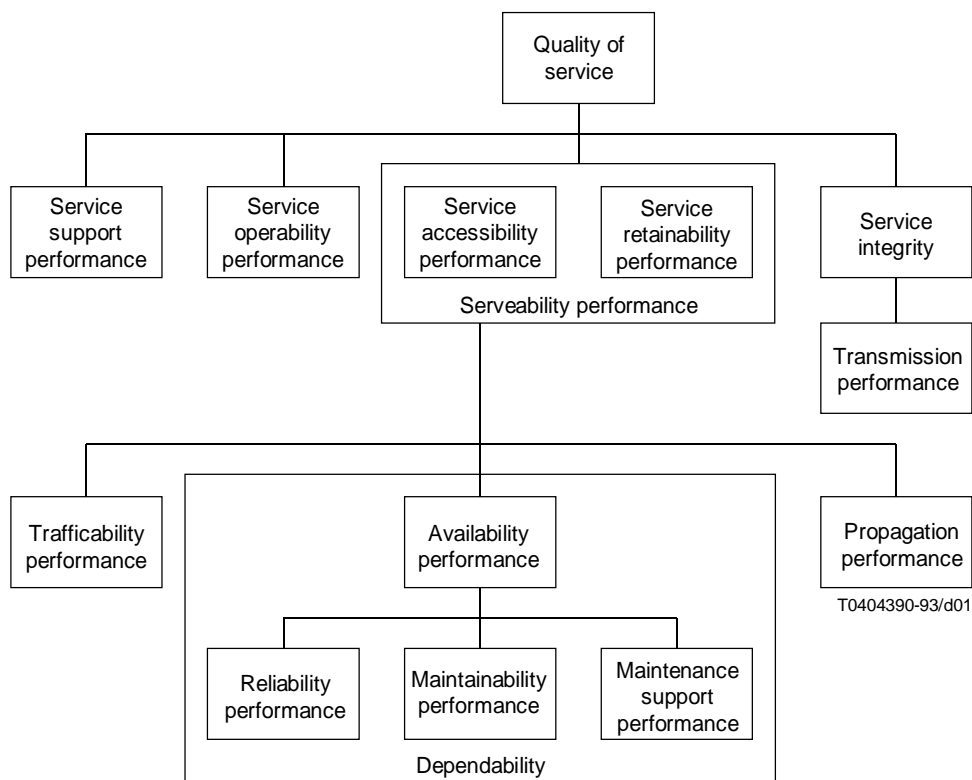
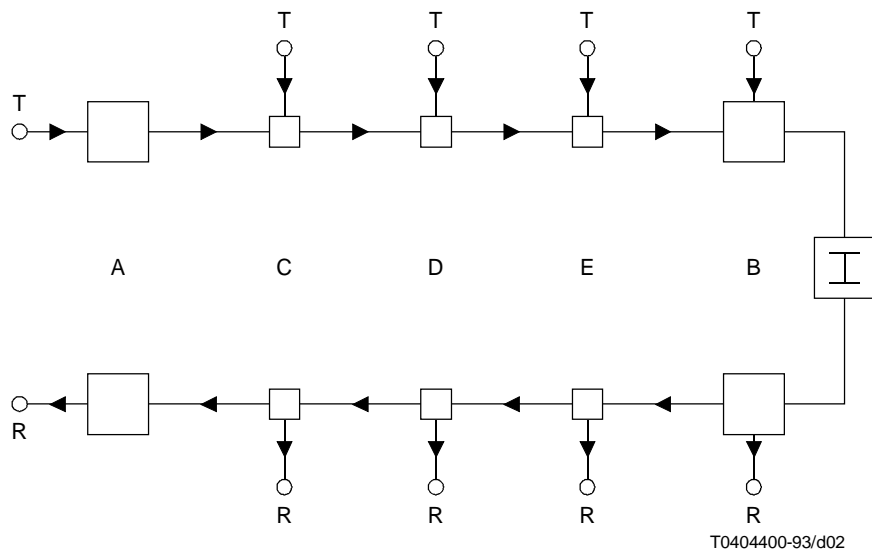

FIGURE 1/E.800

**Performance concepts**



- T ○ → Send  
R ○ ← Receive
- A B Terminal international centres or terminal repeater stations  
C D E Intermediate international centres or intermediate repeater stations  
I Attenuator looping the two directions of transmission

FIGURE 1/M.100  
**Example of an omnibus service circuit**

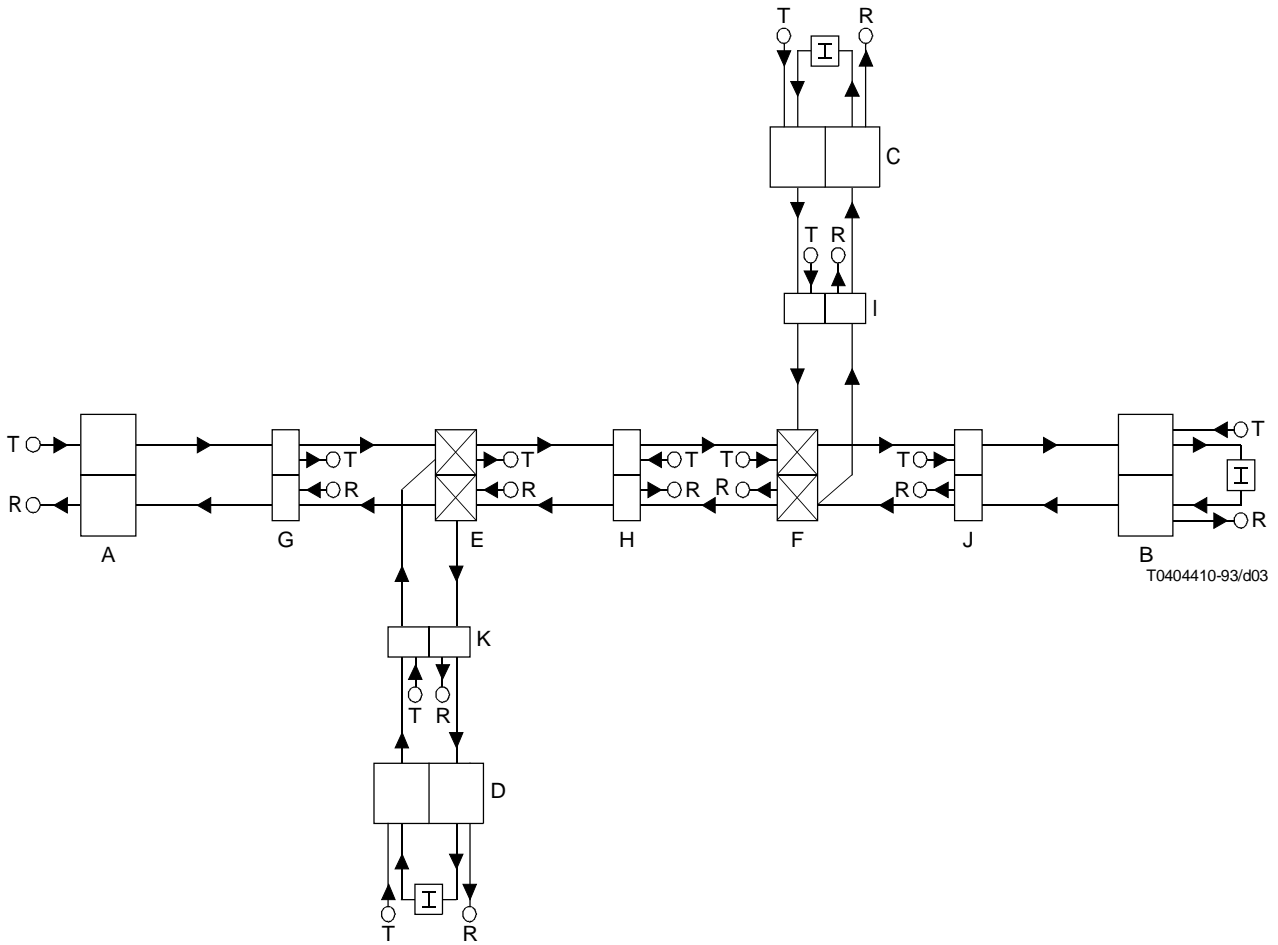

T0404410-93/d03

- T O → Send
- R O ← Receive
- A B C D Terminal international centres or terminal repeater stations
- E F International centres (or repeater stations) with branching facilities
- G H I J K Intermediate international centres or intermediate repeater stations
- I Attenuator looping the two directions of transmission

FIGURE 2/M.100  
Multiterminal service circuit

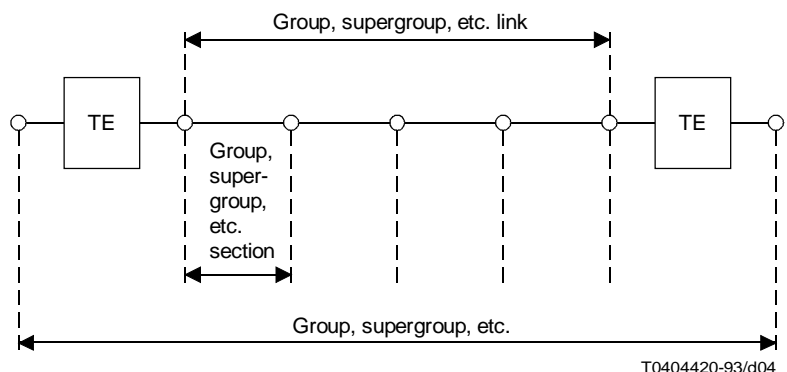

T0404420-93/d04

TE Terminal equipment for telephony, data facsimile transmission, etc.

—○— Distribution frame (or equivalent)

FIGURE 1/M.60  
**Group, supergroup, etc. link**



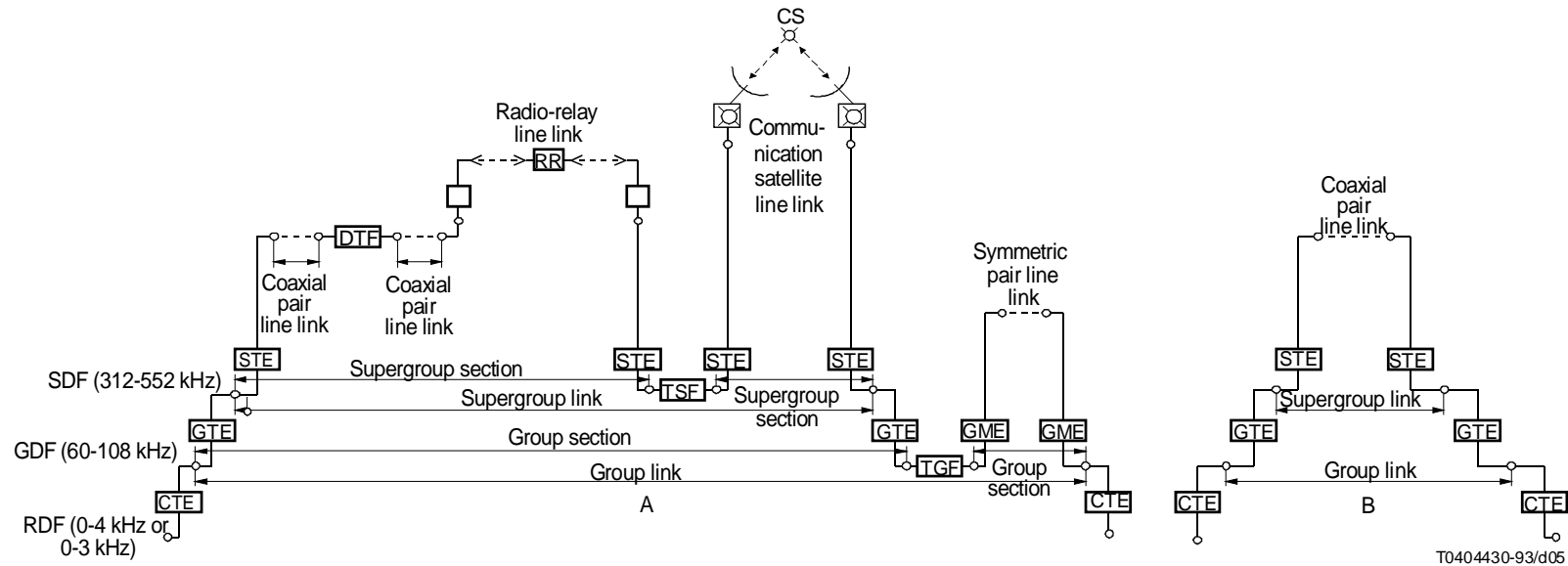

- CTE Channel translating equipment  
(translation of the audio band into the basic group or vice versa)
- GTE Group translating equipment  
(translation of the basic group into the basic supergroup)
- STE Supergroup translating equipment  
(translation of the basic supergroup into the line frequency on  
coaxial cable, or radio-relay system or vice versa)
- GME Group modulating equipment

- DTF Direct through-connection filter
- TSF Through-supergroup filter
- TGF Through-group filter
- RDF Repeater distribution frame
- GDF Group distribution frame
- SDF Supergroup distribution frame
- RR Radio-relay station
- CS Communication satellite

FIGURE 2/M.60

Channel of a group set-up on: several line links in tandem (A), a single line link (B)

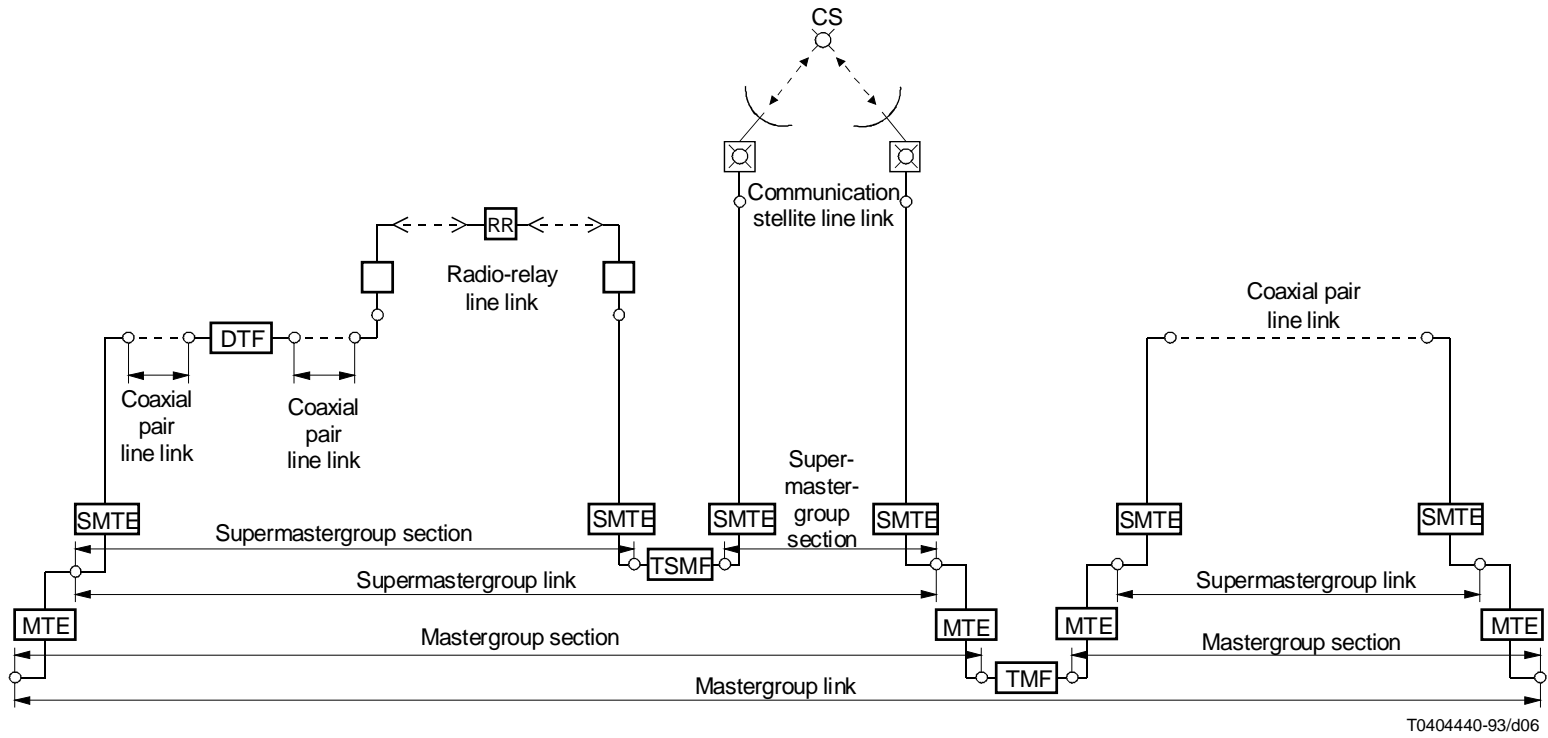

MTE Mastergroup translating equipment  
 SMTE Supermastergroup translating equipment  
 TMF Through-mastergroup filter  
 TSMF Through-supermastergroup filter

DTF Direct through-connection filter  
 RR Radio-relay station  
 CS Communication satellite

FIGURE 3/M.60  
**Mastergroup link**

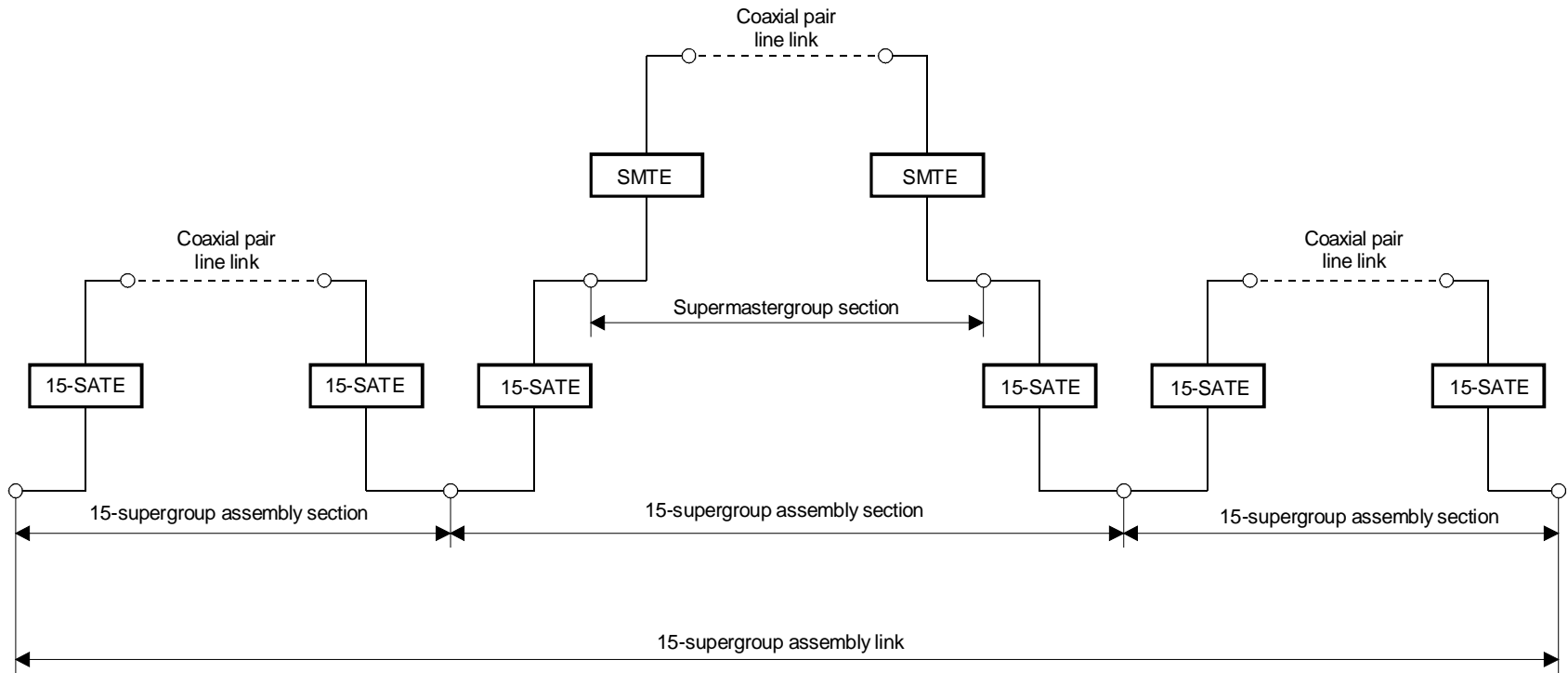

T0404450-93/d07

SMTE Supermastergroup translating equipment  
 15-SATE 15-supergroup assembly translating equipment

FIGURE 4/M.60  
 15-supergroup assembly link

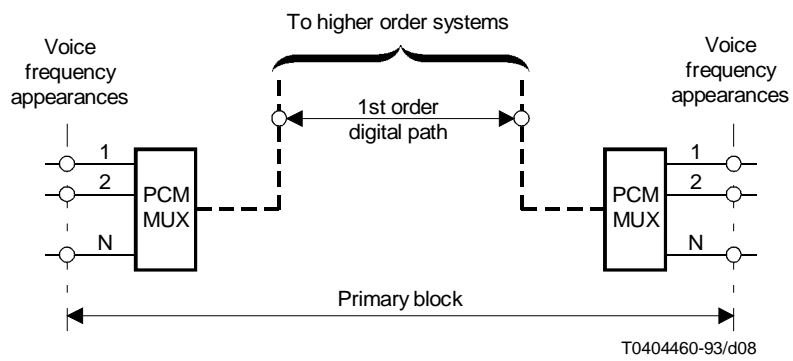

T0404460-93/d08

FIGURE 5/M.60  
**Example of a primary block**

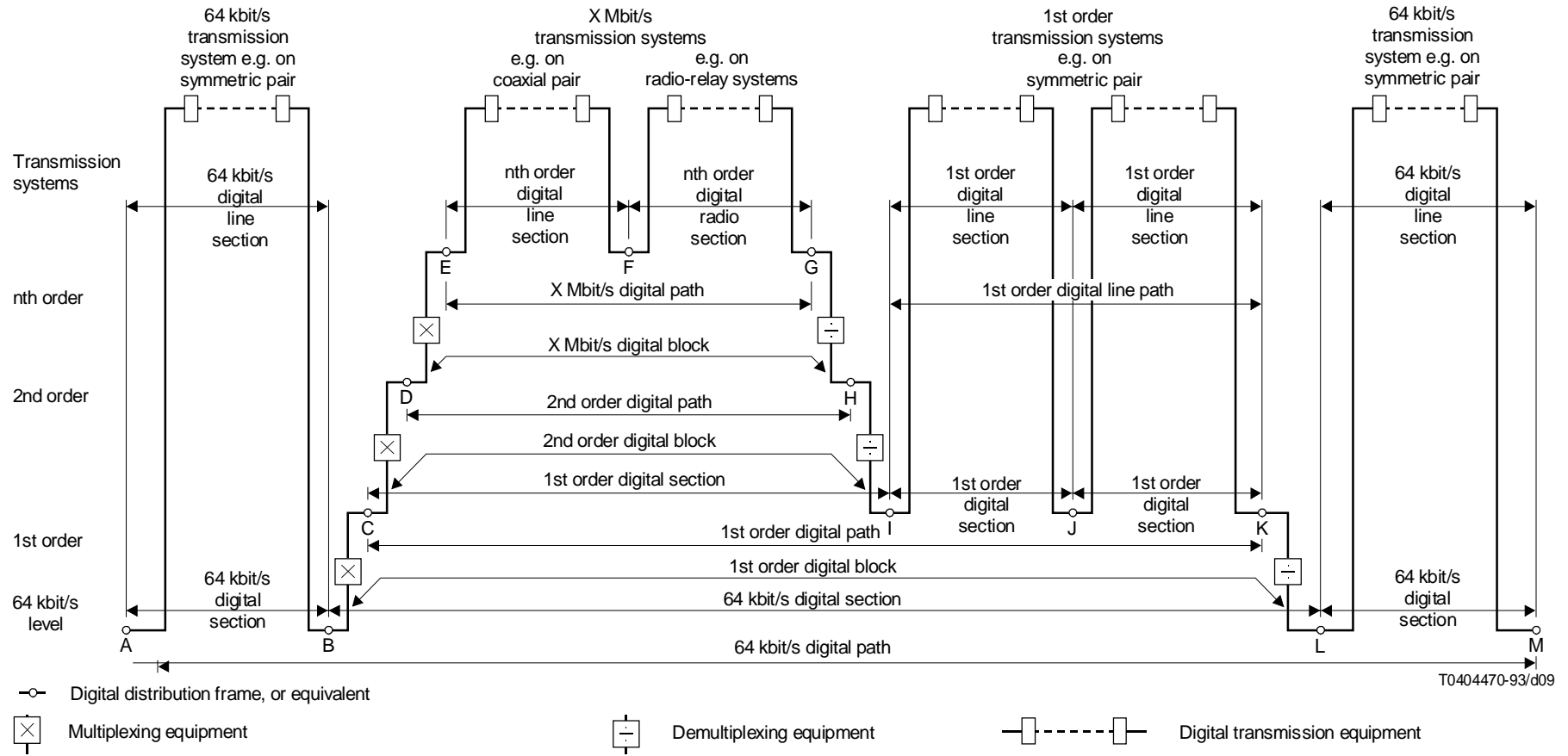

**NOTES**

- 1 Digital line and radio sections may be at digit rates which are either hierarchical or non-hierarchical.
- 2 A-B is a 64 kbit/s digital line section, which is a particular case of a 64 kbit/s digital section.
- 3 A-M is a 64 kbit/s digital path which comprises three 64 kbit/s digital sections, A-B, B-L and L-M.
- 4 F-G is an X Mbit/s digital radio section which forms part of an X Mbit/s digital path E-G.
- 5 C-I is a 1st order digital section which contains a 2nd order digital path D-H.
- 6 I-K is an example of a digital line path.

**FIGURE 6/M.60**

**Examples of digital path, digital section, digital line section, etc.**

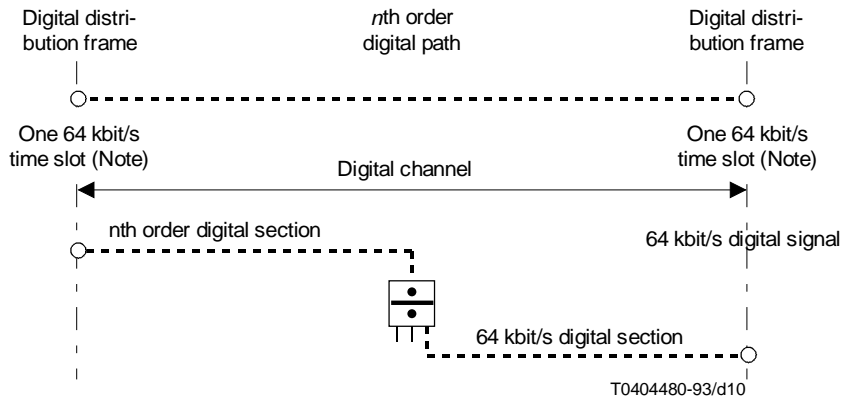

NOTE – Here the digital channel appears as a 64 kbit/s time slot in a digital path or section. It is not directly accessible.

FIGURE 7/M.60

**Diagrammatic representations of a digital channel**

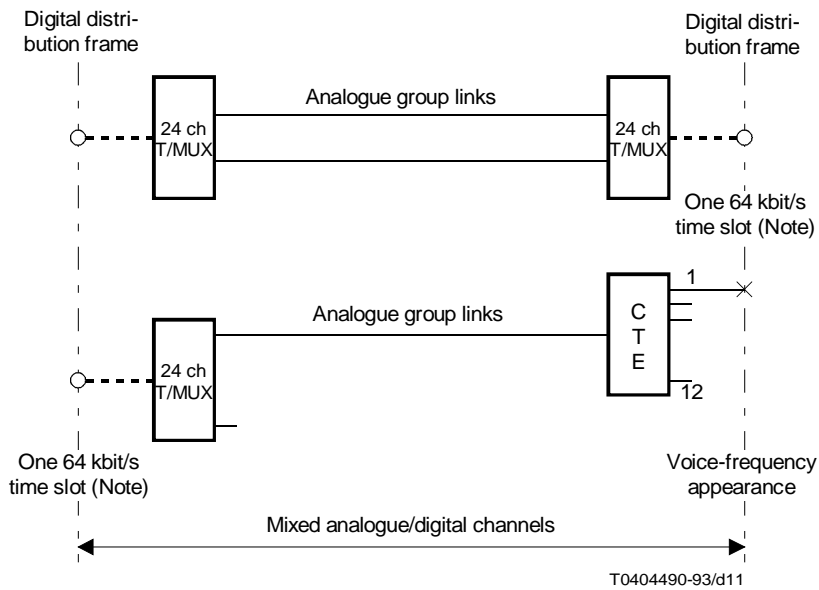

NOTE – Here the digital channel appears as a 64 kbit/s time slot in a digital path or section. It is not directly accessible.

FIGURE 8/M.60

**Examples of mixed analogue/digital channels**

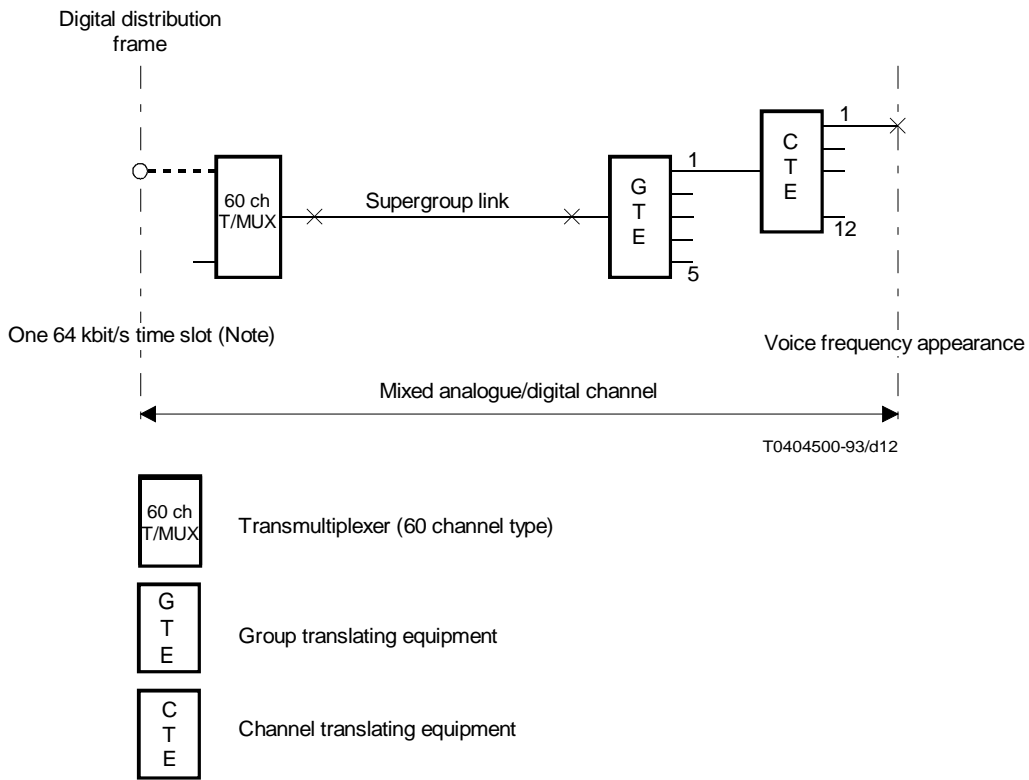

FIGURE 9/M.60  
**Example of a mixed analogue/digital channel**

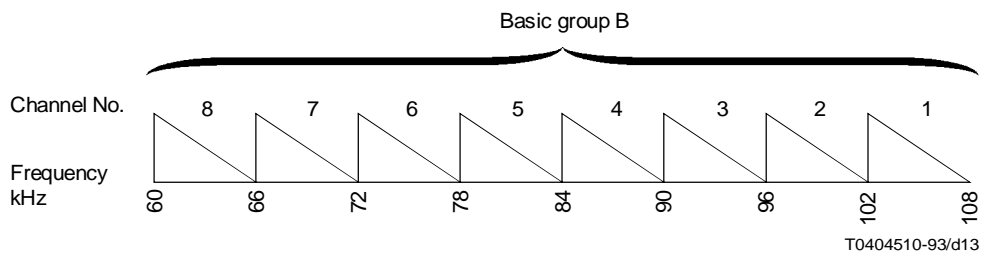

FIGURE 1/M.320  
**Numbering of channels in 8 channel group**

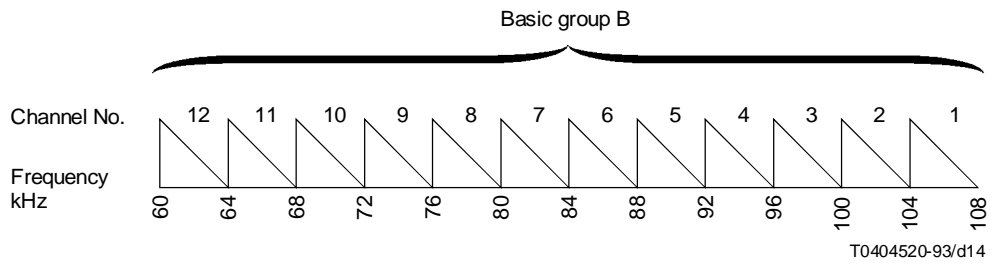

FIGURE 2/M.320  
Numbering of channels in 12 channel group

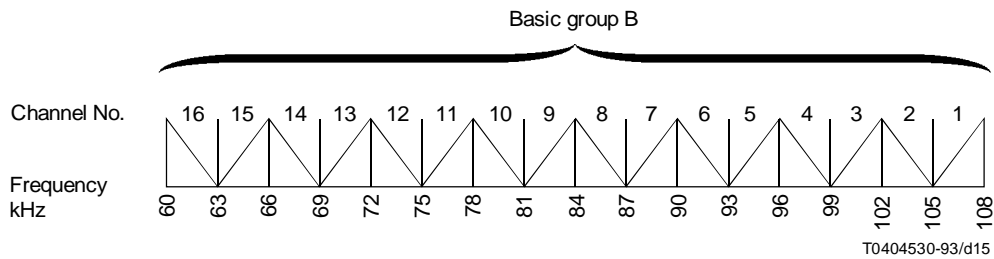

FIGURE 3/M.320  
Numbering of channels in 16 channel group

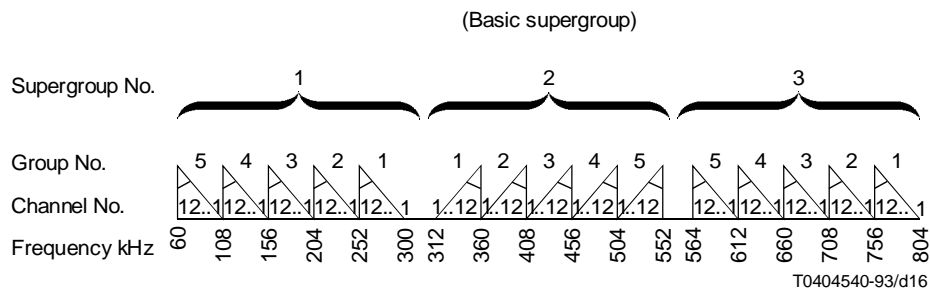

FIGURE 1/M.330  
Numbering of 12 circuit groups and channels in supergroups



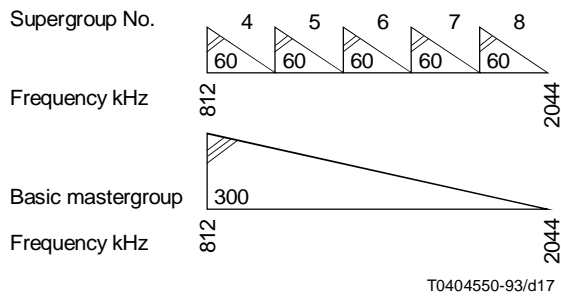

FIGURE 1/M.340

**Numbering of supergroups within the basic mastergroup**

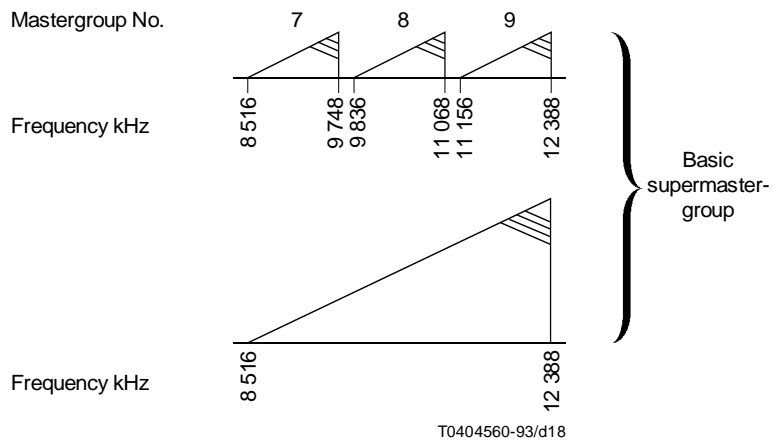
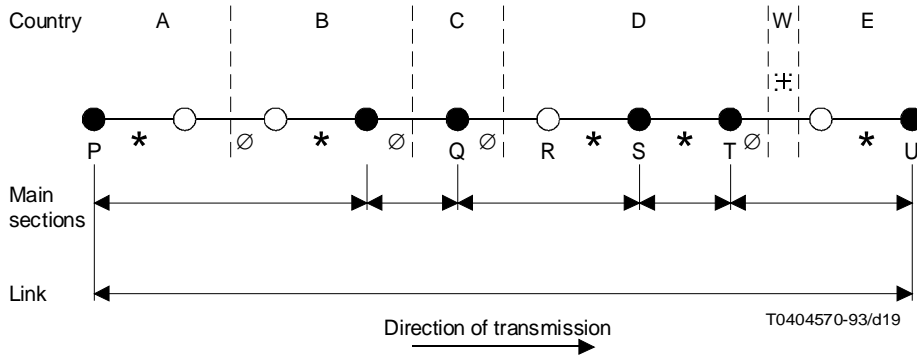

FIGURE 1/M.350

**Numbering of mastergroup within a supermastergroup**



- \* National section
- ∅ International section
- † The group, supergroup, etc., passes through country W without being reduced to the appropriate basic frequency band. There are thus no control or frontier stations for the group, supergroup, etc., in these countries.
- Frontier stations
- Control stations

FIGURE 2/M.460

**Example of an international link showing how it may be divided into sections of control for lining-up and maintenance**

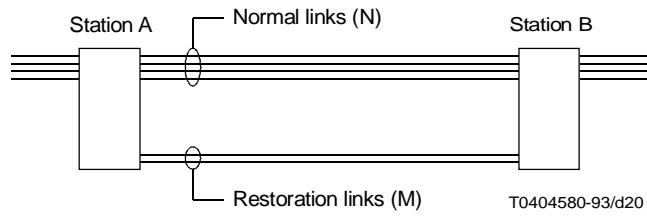

FIGURE 1/M.495  
**N + M direct transmission restoration system  
 (protection link switching)**

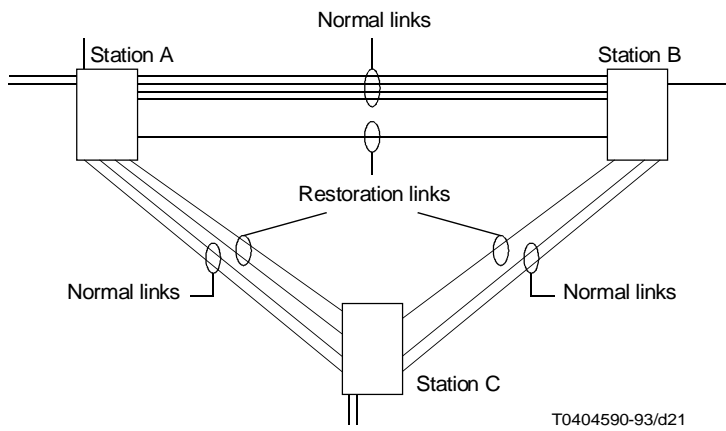

FIGURE 2/M.495  
**N + M automatic transmission rerouting system  
 (protection network switching)**

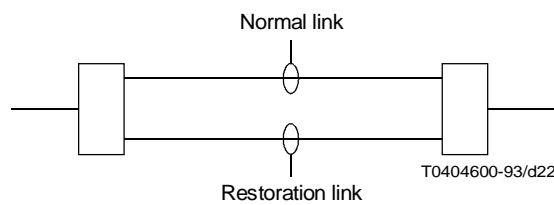
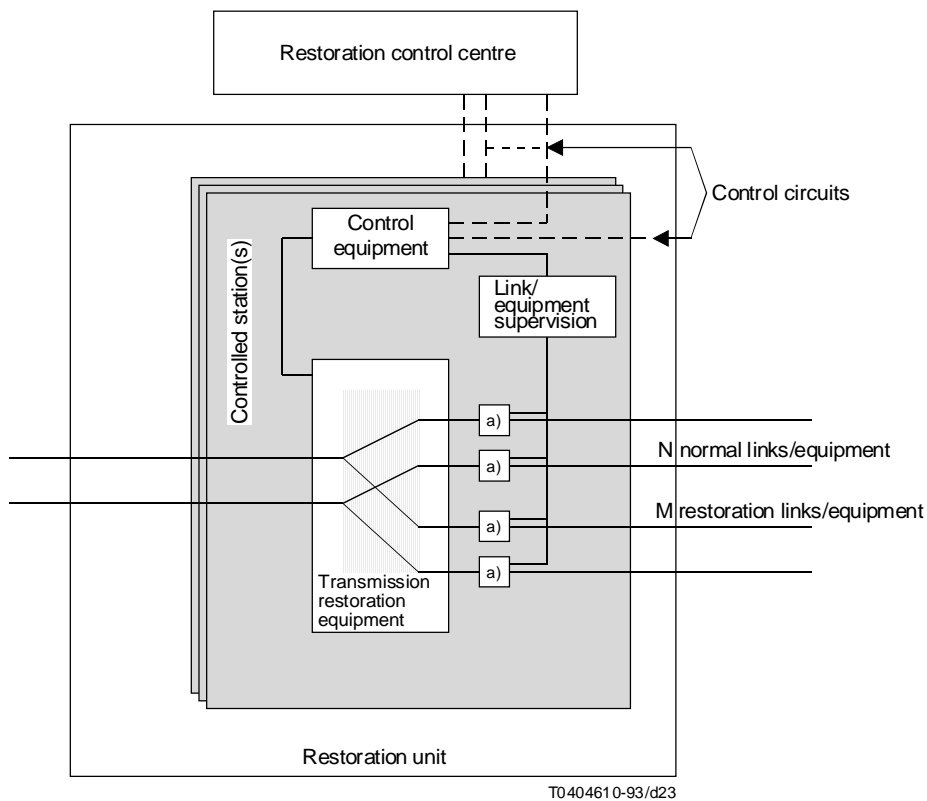

FIGURE 3/M.495  
**1 + 1 restoration system**



a) Line terminal equipment and/or multiplex equipment

NOTE – This illustration is only an example. The structure of a transmission restoration system can be different (for example, the control function might be implemented within a restoration control centre, with no specific equipment).

FIGURE 4/M.495  
**Example of transmission restoration system**

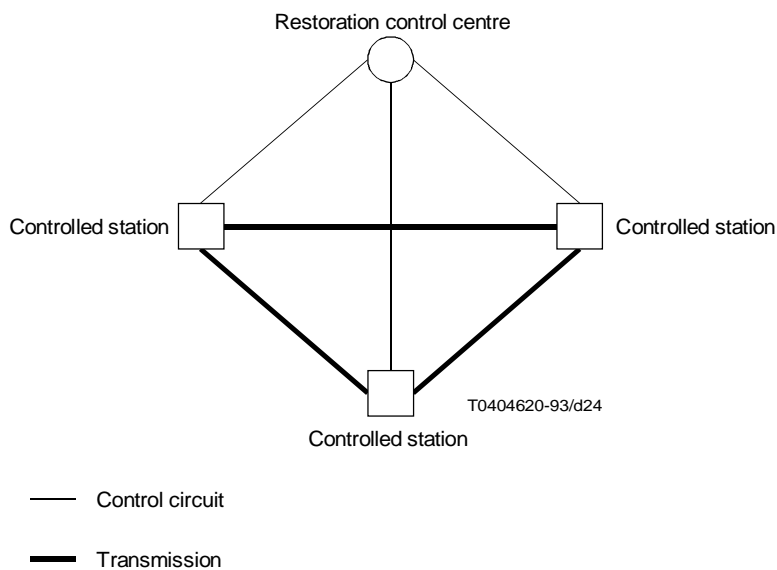
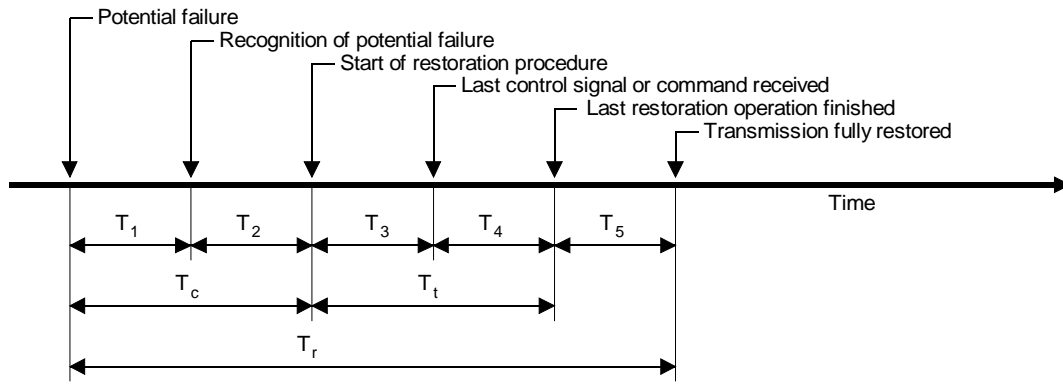

FIGURE 5/M.495  
**Restoration control**



T0404630-93/d25

- |                                  |                         |
|----------------------------------|-------------------------|
| $T_1$ Detection time             | $T_c$ Confirmation time |
| $T_2$ Waiting time               | $T_t$ Transfer time     |
| $T_3$ Restoration procedure time | $T_r$ Restoration time  |
| $T_4$ Restoration transfer time  |                         |
| $T_5$ Recovery time              |                         |

FIGURE 6/M.495  
Defined restoration times

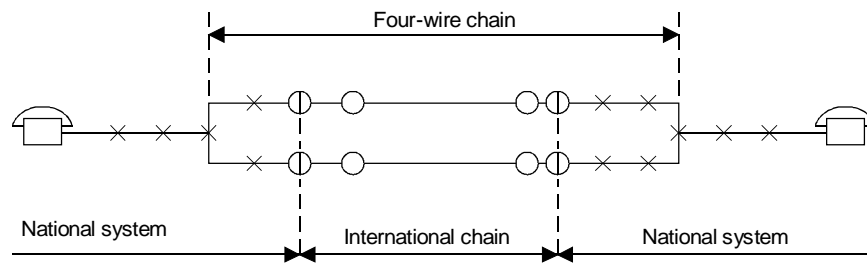

T0404640-93/d26

- Transit international exchange
- ⊖ Terminal international exchange
- × National exchange
- ☎ Subscriber's set

FIGURE 1/M.560  
Constituent parts of an international telephone connection

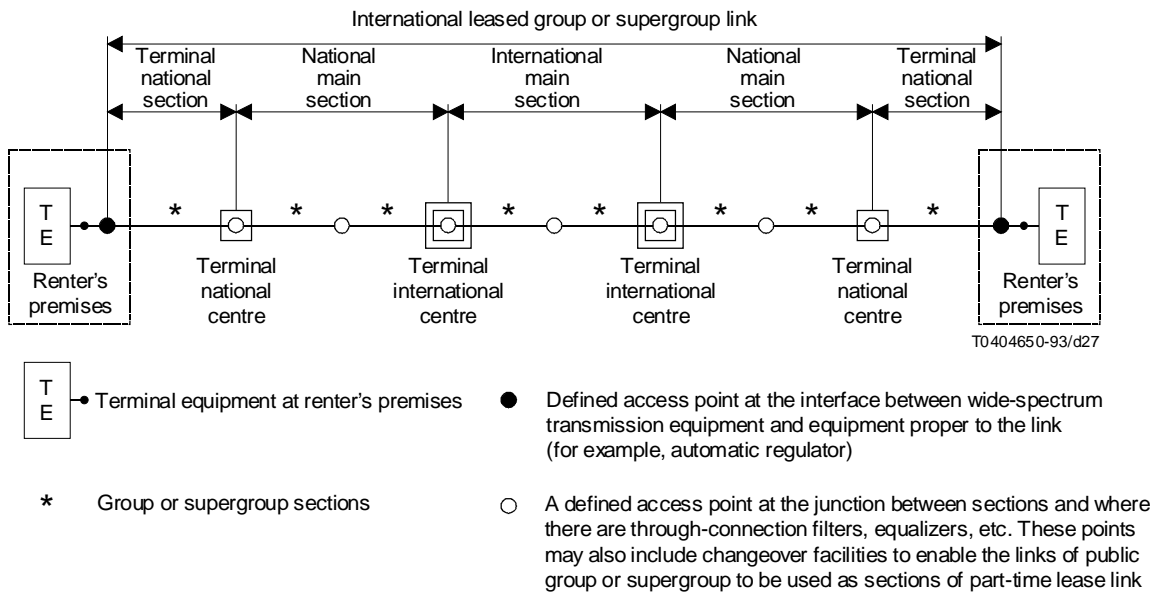

FIGURE 1/M.900

**Example of the basic constitution of an international leased group or supergroup link for wide-spectrum signal transmission**

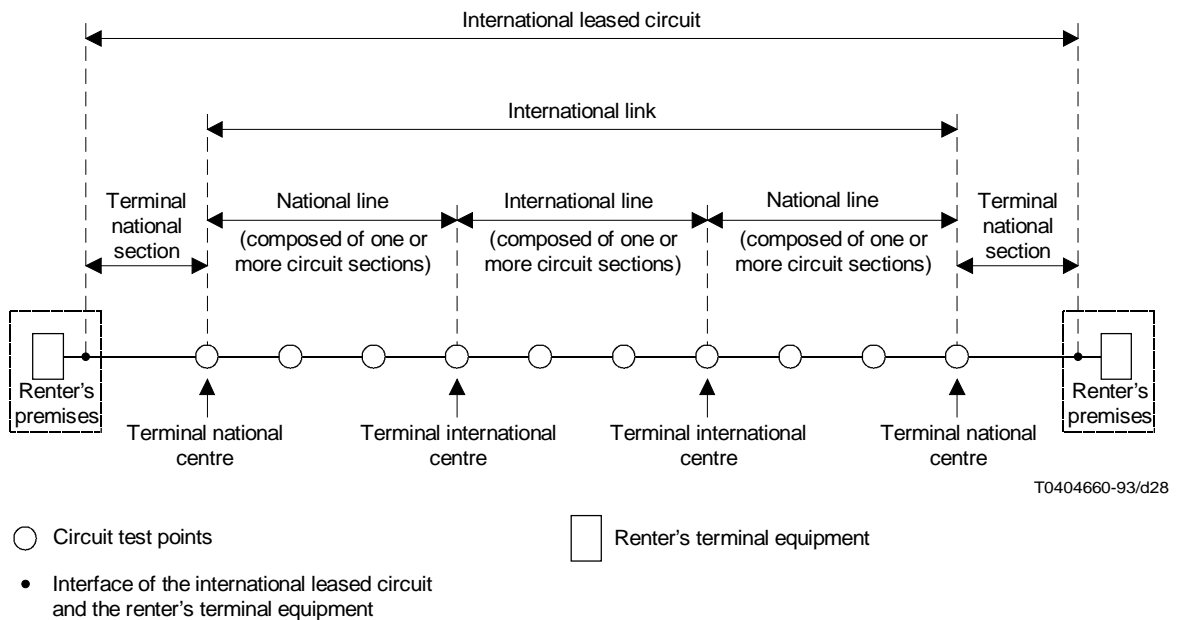

FIGURE 2/M.1010

**Basic constitution of a point-to-point international leased circuit**