



INTERNATIONAL TELECOMMUNICATION UNION

ITU-T

TELECOMMUNICATION
STANDARDIZATION SECTOR
OF ITU

J.112

(03/98)

SERIES J: TRANSMISSION OF TELEVISION, SOUND
PROGRAMME AND OTHER MULTIMEDIA SIGNALS

Interactive systems for digital television distribution

**Transmission systems for interactive cable
television services**

ITU-T Recommendation J.112

(Previously CCITT Recommendation)

ITU-T J-SERIES RECOMMENDATIONS

TRANSMISSION OF TELEVISION, SOUND PROGRAMME AND OTHER MULTIMEDIA SIGNALS

General Recommendations	J.1–J.9
General specifications for analogue sound-programme transmission	J.10–J.19
Performance characteristics of analogue sound-programme circuits	J.20–J.29
Equipment and lines used for analogue sound-programme circuits	J.30–J.39
Digital encoders for analogue sound-programme signals	J.40–J.49
Digital transmission of sound-programme signals	J.50–J.59
Circuits for analogue television transmission	J.60–J.69
Analogue television transmission over metallic lines and interconnection with radio-relay links	J.70–J.79
Digital transmission of television signals	J.80–J.89
Ancillary digital services for television transmission	J.90–J.99
Operational requirements and methods for television transmission	J.100–J.109
Interactive systems for digital television distribution	J.110–J.129
Transport of MPEG-2 signals on packetised networks	J.130–J.139
Measurement of the quality of service	J.140–J.149
Digital television distribution through local subscriber networks	J.150–J.159

For further details, please refer to ITU-T List of Recommendations.

ITU-T RECOMMENDATION J.112

TRANSMISSION SYSTEMS FOR INTERACTIVE CABLE TELEVISION SERVICES

Summary

This Recommendation "Transmission systems for interactive cable television services" extends the scope of Recommendation J.83 "Digital multi-programme systems for television, sound and data services for cable distribution" to make provision for bidirectional data over coaxial and hybrid fibre-coax cables for interactive services. Like Recommendation J.83, this Recommendation also contains several annexes in recognition of different existing media environments. The annexes in this Recommendation are intended to be read in conjunction with the corresponding annexes in Recommendation J.83.

It is recommended that for the introduction of fast Internet access and/or interactive cable television services, the systems in this Recommendation be used to achieve the benefits of economies of scale and facilitate interoperability.

Source

ITU-T Recommendation J.112 was prepared by ITU-T Study Group 9 (1997-2000) and was approved under the WTSC Resolution No. 1 procedure on the 18th of March 1998.

FOREWORD

ITU (International Telecommunication Union) is the United Nations Specialized Agency in the field of telecommunications. The ITU Telecommunication Standardization Sector (ITU-T) is a permanent organ of the ITU. The ITU-T is responsible for studying technical, operating and tariff questions and issuing Recommendations on them with a view to standardizing telecommunications on a worldwide basis.

The World Telecommunication Standardization Conference (WTSC), which meets every four years, establishes the topics for study by the ITU-T Study Groups which, in their turn, produce Recommendations on these topics.

The approval of Recommendations by the Members of the ITU-T is covered by the procedure laid down in WTSC Resolution No. 1.

In some areas of information technology which fall within ITU-T's purview, the necessary standards are prepared on a collaborative basis with ISO and IEC.

NOTE

In this Recommendation, the expression "Administration" is used for conciseness to indicate both a telecommunication administration and a recognized operating agency.

INTELLECTUAL PROPERTY RIGHTS

The ITU draws attention to the possibility that the practice or implementation of this Recommendation may involve the use of a claimed Intellectual Property Right. The ITU takes no position concerning the evidence, validity or applicability of claimed Intellectual Property Rights, whether asserted by ITU members or others outside of the Recommendation development process.

As of the date of approval of this Recommendation, the ITU had not received notice of intellectual property, protected by patents, which may be required to implement this Recommendation. However, implementors are cautioned that this may not represent the latest information and are therefore strongly urged to consult the TSB patent database.

© ITU 1998

All rights reserved. No part of this publication may be reproduced or utilized in any form or by any means, electronic or mechanical, including photocopying and microfilm, without permission in writing from the ITU.

CONTENTS

	<i>Page</i>
1	Scope 1
2	References 1
2.1	Normative References 1
2.2	Informative references 3
3	Terms and definitions 4
4	Abbreviations 10
5	Interactive cable television services 13
Annex A – Interaction channel for digital video broadcasting cable television distribution systems 13	
A.1	Scope..... 13
A.2	Normative references 13
A.3	Abbreviations 13
A.4	Referencemodel for system architecture of narrowband interaction channels in a broadcasting scenario (asymmetric interactive services)..... 14
A.4.1	Protocol stack model 14
A.4.2	System model 14
A.5	Interaction Channel specification for CATV networks 16
A.5.1	System concept..... 16
A.5.2	Lower physical layer specification 18
A.5.3	Framing 30
A.5.4	Slot timing assignment 41
A.5.5	MAC functionality..... 47
Annex B – Data-over-cable radio frequency interface 84	
B.1	Scope and purpose 84
B.1.1	Scope..... 84
B.1.2	Requirements..... 84
B.1.3	Background 85
B.2	Functional assumptions 87
B.2.1	Broadband access network 88
B.2.2	Equipment assumptions 88
B.2.3	RF channel assumptions 89
B.2.4	Transmission levels 90
B.2.5	Frequency inversion 90
B.3	Communication protocols 91
B.3.1	Protocol stack 91
B.3.2	The MAC Forwarder 94
B.3.3	Network Layer 95
B.3.4	Above the Network Layer 95
B.3.5	Data Link Layer 96
B.3.6	Physical layer 97
B.4	Physical media dependent sublayer specification..... 98
B.4.1	Scope 98
B.4.2	Upstream 98
B.4.3	Downstream..... 113
B.5	Downstream transmission convergence sublayer 117
B.5.1	Introduction 117
B.5.2	MPEG Packet format 118
B.5.3	MPEG Header for MCNS Data-Over-Cable 118
B.5.4	MPEG Payload for MCNS Data-Over-Cable 118
B.5.5	Interaction with the MAC sublayer 119
B.5.6	Interaction with the Physical layer..... 120
B.5.7	MPEG Header synchronization and recovery 121

	<i>Page</i>	
B.6	Media access control specification.....	121
B.6.1	Introduction.....	121
B.6.2	MAC Frame formats.....	122
B.6.3	MAC Management messages.....	133
B.6.4	Upstream bandwidth allocation.....	151
B.6.5	Timing and synchronization.....	159
B.6.6	Data link encryption support.....	161
B.7	Cable modem – CMTS interaction.....	162
B.7.1	CMTS initialization.....	162
B.7.2	Cable modem initialization.....	163
B.8	Supporting future new cable modem capabilities.....	179
B.8.1	Setting up communications on an enhanced basis.....	179
B.8.2	Downloading cable modem operating software.....	179
B.9	Provision for other future capabilities.....	180
B.9.1	Anticipated physical-layer changes.....	180
B.9.2	New network service requirements.....	181
B.9.3	PID filtering capability.....	183
Appendix B.I	– Well-Known Addresses.....	184
B.I.1	MAC addresses.....	184
B.I.2	MAC Service IDs.....	184
B.I.3	MPEG PID.....	184
Appendix B.II	– Parameters and constants.....	185
Appendix B.III	– CM configuration interface specification.....	186
B.III.1	DHCP fields used by the CM.....	186
B.III.2	CM binary configuration file format.....	186
B.III.3	Configuration file settings.....	187
B.III.4	Configuration file creation.....	187
B.III.5	CM MIC calculation.....	189
B.III.6	CMTS MIC calculation.....	189
B.III.7	Registration configuration settings.....	189
B.III.8	Encodings.....	190
Appendix B.IV	– MAC sublayer service definition.....	197
B.IV.1	Service at the CM.....	197
B.IV.2	MAC_CM_802_DATA.request.....	197
B.IV.3	MAC_CM_DIX_DATA.request.....	197
B.IV.4	MAC_CM_ATM_DATA.request.....	198
B.IV.5	MAC_CM_802_DATA.indication.....	198
B.IV.6	MAC_CM_DIX_DATA.indication.....	198
B.IV.7	MAC_CM_ATM_DATA.indication.....	198
B.IV.8	MAC_CM_DATA.acknowledgment.....	198
Appendix B.V	– Example Burst Profiles.....	199
B.V.1	Introduction.....	199
B.V.2	Example preamble sequence.....	199
B.V.3	Example Burst Profiles.....	200
Appendix B.VI	– Upstream modulation rates.....	209
B.VI.1	Introduction.....	209
B.VI.2	Sources of narrowband ingress.....	209
B.VI.3	Fitting data carriers within the ingress gaps.....	211
Appendix B.VII	– Example: Multiple upstream channels.....	213
Appendix B.VIII	– The data-over-cable spanning tree protocol.....	214
B.VIII.1	Background.....	214
B.VIII.2	Public Spanning Tree.....	214
B.VIII.3	Public spanning tree protocol details.....	215
B.VIII.4	Spanning tree parameters and defaults.....	216
Annex C	– Multimedia data transmission equipment over cable television network.....	217
C.1	Introduction.....	217
C.2	Definition of reference system and Interfaces.....	217

	<i>Page</i>
C.3	Protocol stacks 218
C.3.1	Interface A protocol stack 218
C.3.2	Interface A physical layer and data link layer 218
C.3.3	Interface A network layer 218
C.3.4	Interface B protocol stack 218
C.3.5	Interface C protocol stack..... 219
C.3.6	Interface C physical layer and data link layer..... 219
C.3.7	Interface C network layer 219
C.4	Physical layer specification..... 219
C.4.1	Upstream 219
C.4.2	Downstream..... 222
C.5	Transmission convergence sublayer specification..... 223
C.5.1	Introduction 223
C.5.2	MPEG Packet format 224
C.5.3	MPEG Header 224
C.5.4	Interface with MAC sublayer 225
C.5.5	Physical layer interaction 226
C.5.6	MPEG Header synchronization and recovery 226
C.6	MAC layer specification 226
C.6.1	Introduction..... 226
C.6.2	MAC Frame format 229
C.6.3	MAC Management message..... 236

Introduction

Digital television services have been established in many countries and the benefits of extending these to provide interactive services are widely recognized. Cable television distribution systems are particularly suited for the implementation of bidirectional data services and this Recommendation complements the system specifications in Recommendation J.83.

Whilst the annexes reflect the different environments, there is substantial commonality. The services may include fast Internet access and/or interactive cable television. The transmission protocols supported include, but are not limited to IP and ATM. The reference architectures are all based on Recommendation J.110. In each case downstream transmission involves optional constant bit rate streams protected by scrambling and forward error correction, with multiplexing such that a head end can support a large number of remote stations (see A.5.1.1, B.3.6, C.4.2). Upstream transmission from the stations also involves a similar multiplex for which a Media Access Control (MAC) layer manages access on a contention or contentionless basis (see A.5.1.3, B.3.6 and C.4.1). Regarding spectrum allocation, an approach is used throughout whereby downstream transmission is at higher frequencies than upstream transmission (see A.5.1.2, B.2.3, C.4.1.4 and C.4.2.4).

It should be noted that the annexes to this Recommendation describe different variations of the same protocol layers, for use in different ITU regions. Connectivity between these variations, however, can be supported by telecommunications and computer standards in the public domain, which are well-established and widely used.

It should be further noted that there exists two Supplements to the J-series Recommendations related to Rec. J.112 which are entitled:

- Supplement 1 – Example of linking options between annexes of ITU-T Recommendation J.112 and annexes of ITU-T Recommendation J.83;
- Supplement 2 – Guidelines for the use of Annex A of Recommendation J.112 "Transmission systems for interactive cable television services"; Example of Digital Video Broadcasting (DVB) interaction channel for cable television distribution.

TRANSMISSION SYSTEMS FOR INTERACTIVE CABLE TELEVISION SERVICES

(Geneva, 1998)

1 Scope

This Recommendation "Transmission systems for interactive cable television services" extends the scope of Recommendation J.83 "Digital multi-programme systems for television, sound and data services for cable distribution" to make provision for bidirectional data over hybrid fibre-coax cables for interactive services. Like Recommendation J.83, this Recommendation also contains several annexes in recognition of different existing media environments. The annexes in this Recommendation are intended to be read in conjunction with the corresponding annexes in Recommendation J.83.

Annex A is based on work done in Europe and is related to a wider set of options such as Recommendation J.111 and should provide a suitable basis for further developments.

Annex B is based on work done in North America and should provide a suitable basis for future developments.

Annex C is based on work done in Japan and should provide a suitable basis for future developments.

Whilst Annexes A, B and C correspond to A, B and C in Recommendation J.83, there is substantial commonality in the services and protocols supported. The reference architectures are also based on Recommendation J.110. There is therefore the possibility that, in application, the features chosen for use with the transmission system described in a particular annex of Recommendation J.83 are not limited to only the corresponding annex of this Recommendation.

2 References

The following ITU-T Recommendations and other references contain provisions which, through reference in this text, constitute provisions of this Recommendation. At the time of publication, the editions indicated were valid. All Recommendations and other references are subject to revision; all users of this Recommendation are therefore encouraged to investigate the possibility of applying the most recent edition of the Recommendations and other references listed below. A list of the currently valid ITU-T Recommendations is regularly published.

2.1 Normative References

- [EN 50201] ETSI EN 50201:1997, *Interfaces for DVB-IRDs*. (Ref. Annex A.)
- [EN 300 421] ETSI EN 300 421, *Digital Broadcasting systems for television, sound and data services – Framing structure, channel coding and modulation for 11/12 satellite services. (DVB-S spec)*. (Ref. Annex A.)
- [ETS 300 802] ETSI ETS 300 802: *Digital Video Broadcasting (DVB) – Network Independent Protocols for interactive Services*. (Ref. Annex A.)
- [ISO/IEC 8825] ISO/IEC 8825:1990, *Information technology – Open Systems Interconnection – Specification of the Basic Encoding Rules for Abstract Syntax Notation One (ASN.1)*. (Ref. Annex B.)
- [ISO/IEC 8802-2] ISO/IEC 8802-2:1994 (IEEE Std 802.2:1994), *Information technology – Telecommunications and information exchange between systems – Local and metropolitan area networks – Specific requirements – Part 2: Logical link control*. (Ref. Annex B.)
- [ISO/IEC 8802-3] ISO/IEC 8802-3:1996 (IEEE Std 802.3:1996), *Information technology – Telecommunications and information exchange between systems – Local and metropolitan area networks – Specific requirements – Part 3: Carrier sense multiple access with collision detection (CSMA/CD) access method and physical layer specifications*. (Ref. Annex B.)

- [ISO/IEC 10038] ISO/IEC 10038:1993 (ANSI/IEEE Std 802.1D:1993), *Information technology – Telecommunications and information exchange between systems – Local area networks – Media Access Control (MAC) bridges.* (Ref. Annex B.)
- [ISO/IEC 10039] ISO/IEC 10039:1991, *Information technology – Open Systems Interconnection – Local area networks – Medium Access Control (MAC) service definition.* (Ref. Annex B.)
- [ISO/IEC 15802-1] ISO/IEC 15802-1:1995, *Information technology – Telecommunications and information exchange between systems – Local and metropolitan area networks – Common specifications – Part 1: Medium Access Control (MAC) service definition.* (Ref. Annex B.)
- [ITU-T H.222.0] ITU-T Recommendation H.222.0 (1995) | ISO/IEC 13818-1:1996, *Information technology – Generic coding of moving pictures and associated audio information: Systems.* (Ref. Annex B.)
- [ITU-T I.361] ITU-T Recommendation I.361 (1995), *B-ISDN ATM layer specification.* (Ref. Annex A.)
- [ITU-T I.363] ITU-T Recommendation I.363, *B-ISDN ATM Adaptation Layer specification.* (Ref. Annex A.)
- [ITU-T J.83 A] ITU-T Recommendation J.83 (Annex A) (1997), *Digital multi-programme systems for television, sound and data services for cable distribution (Digital multi-programme System A).* (Ref. Annex A.)
- [ITU-T J.83 B] ITU-T Recommendation J.83 (Annex B) (1997), *Digital multi-programme systems for television, sound and data services for cable distribution (Digital multi-programme System B).* (Ref. Annex B.)
- [ITU-T J.83 C] ITU-T Recommendation J.83 (Annex C) (1997), *Digital multi-programme systems for television, sound and data services for cable distribution (Digital multi-programme System C).* (Ref. Annex C.)
- [ITU-T J.110] ITU-T Recommendation J.110 (1997), *Basic principles for a worldwide common family of systems for the provision of interactive television services.*
- [CCITT V.21] CCITT Recommendations V.21 (1984), 300 bits per second duplex modem standardized for use in the general switched telephone network. (Ref. Annex A.)
- [CCITT V.22] CCITT Recommendation V.22 (1988), 1200 bits per second duplex modem standardized for use in the general switched telephone network and on point-to-point 2-wire leased telephone-type circuits. (Ref. Annex A.)
- [CCITT V.22 bis] CCITT Recommendation V.22 bis (1988), 2400 bits per second duplex modem using the frequency division technique standardized for use on the general switched telephone network and on point-to-point 2-wire leased telephone-type circuits. (Ref. Annex A.)
- [CCITT V.23] CCITT Recommendation V.23 (1988), 600/1200-baud modem standardized for use in the general switched telephone network. (Ref. Annex A.)
- [ITU-T V.25] ITU-T Recommendation V.25 (1996), *Automatic answering equipment and general procedures for automatic calling equipment on the general switched telephone network including procedures for disabling of echo control devices for both manually and automatically established calls.* (Ref. Annex A.)
- [ITU-T V.32] ITU-T Recommendation V.32 (1993), *A family of 2-wire, duplex modems operating at data signalling rates of up to 9600 bit/s for use on the general switched telephone network and on leased telephone-type circuits.* (Ref. Annex A.)
- [CCITT V.32 bis] CCITT Recommendation V.32 bis (1991), *A duplex modem operating at data signalling rates of up to 14 400 bit/s for use on the general switched telephone network and on leased point-to-point 2-wire telephone-type circuits.* (Ref. Annex A.)
- [ITU-T V.34] ITU-T Recommendation V.34 (1998), *A modem operating at data signalling rates of up to 33 600 bit/s for use on the general switched telephone network and on leased point-to-point 2-wire telephone-type circuits.* (Ref. Annex A.)

- [ITU-T V.42] ITU-T Recommendation V.42 (1996), *Error-correcting procedures for DCEs using asynchronous-to-synchronous conversion.* (Ref. Annex A.)
- [ITU-T X.25] ITU-T Recommendation X.25 (1996), *Interface between Data Terminal Equipment (DTE) and Data Circuit-terminating Equipment (DCE) for terminals operating in the packet mode and connected to public data networks by dedicated circuit.* (Ref. Annex B.)
- [ITU-T Z.100] ITU-T Recommendation Z.100 (1993), *CCITT Specification and Description Language (SDL).* (Ref. Annex B.)
- [RFC-791] POSTEL (J.), Internet Protocol, IETF RFC-791 (MIL STD 1777), September, 1981. (Ref. Annex B.)
- [RFC-826] PLUMMER (D.), Ethernet Address Resolution Protocol: Or converting network protocol addresses to 48-bit Ethernet address for transmission on Ethernet hardware, November, 1982. (Ref. Annex B.)
- [RFC-868] HARRENSTIEN (K.) and POSTEL (J.), Time Protocol, IETF RFC-868, May 1983. (Ref. Annex B.)
- [RFC-1042] POSTEL (J.) and REYNOLDS (J.), A Standard for the Transmission of IP Datagrams over IEEE 802 Networks, IETF RFC-1042, February, 1988. (Ref. Annex B.)
- [RFC-1058] HEDRICK (C.), Routing Information Protocol, IETF RFC-1058, June, 1988 . (Ref. Annex B.)
- [RFC-1157] SCHOFFSTALL (M.), FEDOR (M.), DAVIN (J.) and CASE (J.), A Simple Network Management Protocol (SNMP), IETF RFC-1157, May, 1990. (Ref. Annex B.)
- [RFC-1350] SOLLINGS (K.), The TFTP Protocol (Revision 2), IETF RFC-1350, July, 1992. (Ref. Annex B.)
- [RFC-1493] DECKER (E.), LANGILLE (P.), RIJSINGHANI (A.) and McCLOGHRIE (K.), Definitions of Managed Objects for Bridges, July, 1993, (Obsoletes RFC-1286). (Ref. Annex B.)
- [RFC-1533] ALEXANDER (S.) and DROMS (R.), DHCP Options and BOOTP Vendor Extensions, IETF RFC-1533, October, 1993. (Ref. Annex B.)
- [RFC-1541] DROMS (R.), Dynamic Host Configuration Protocol, IETF RFC-1541, October, 1993. (Ref. Annex B.)
- [RFC-1633] BRADEN (R.), CLARK (D.) and SHENKER (S.), Integrated Services in the Internet Architecture: An Overview, IETF RFC-1633, June, 1994. (Ref. Annex B.)
- [RFC-1812] BAKER (F.), Requirements for IP Version 4 Routers, IETF RFC-1812, June, 1995. (Ref. Annex B.)
- [RFC-2104] KRAWCZYK (H.), BELLARE (M.) and CANETTI (R.), HMAC: Keyed-Hashing for Message Authentication, IETF RFC-2104, February, 1997. (Ref. Annex B.)

2.2 Informative references

- [91/263/EEC] 91/263/EEC Directive on Terminal equipment. (Ref. Annex A.)
- [CableLabs1] Two-Way Cable Television System Characterization, Cable Television Laboratories, Inc., April 12, 1995. (Ref. Annex B.)
- [CableLabs2] Digital Transmission Characterization of Cable Television Systems, Cable Television Laboratories, Inc., November, 1994. (Ref. Annex B.)
- [DAVIC] DAVIC Specification, DAVIC System Reference Model. (Ref. Annex A.)
- [DIX] Ethernet Protocol Version 2.0, Digital, Intel, Xerox, 1982. (Ref. Annex B.)
- [DVB-A008] DVB-A008, Commercial requirements for asymmetric interactive services supporting broadcast to the home with narrowband return channels, October, 1995. (Ref. Annex A.)
- [ETS 300 800] ETS 300 800, Digital Video Broadcasting (DVB) – DVB interaction channel for Cable TV distribution systems (CATV). (Ref. Annex A.)

[IEEE 802]	IEEE Std 802:1990, Local and Metropolitan Area Networks: Overview and Architecture. (Ref. Annex B.)
[IEEE 802.1Q]	IEEE Draft Standard 802.1Q/D4,. Draft Standard for Virtual Bridged Local Area Networks, December 20, 1996. (Ref. Annex B.)
[IPS-SP-401]	F-Connector Specification, Society of Cable Television Engineers. (Ref. Annex B.)
[IS-6]	EIA Interim Standard IS-6 (1983), Recommended Cable TV Channel Identification Plan. (Ref. Annex B.)
[JCTEA1]	Multiplex System for Digital Cable Television, JCTEA STD-002. (Ref. Annex C.)
[JCTEA2]	Receiver for Cable Television, JCTEA STD-004. (Ref. Annex C.)
[MCNS2]	Data-Over-Cable Service Specifications, Security System Interface Specification, SP-SSI-I01-970506. (Ref. Annex B.)
[MCNS3]	Data-Over-Cable Service Interface Specifications, Cable Modem Termination System – Network-Side Interface Specification SP-CMTS-NSI-I01-960702. (Ref. Annex B.)
[MCNS4]	Data-Over-Cable Service Interface Specifications, Cable Modem to Customer Premises Equipment Interface Specification SP-CMCI-I01-960702. (Ref. Annex B.)
[MCNS5]	Data-Over-Cable Service Interface Specifications, Operations Support System Interfaces SP-OSSI-I01-970403. (Ref. Annex B.)
[MCNS6]	Data-Over-Cable Service Interface Specifications, Cable Modem Telephone Return Interface Specification SP-CMTRI-I01-970804. (Ref. Annex B.)
[MCNS7]	Data-Over-Cable Service Interface Specifications, Removable Security Module Interface Specifications, SP-RSMI-I01-980204. (Ref. Annex B.)
[MCNS8]	Data-Over-Cable Service Interface Specifications, Baseline Privacy Interface SP-BPI-I01-970609. (Ref. Annex B.)
[NCTA]	NCTA Recommended Practices for measurement on Cable Television Systems – National Cable Television Association, Washington DC, 2nd Edition, revised October, 1993. (Ref. Annex B.)
[SMS]	The Spectrum Management Application (SMA) and the Common Spectrum Management Interface (CSMI), Time Warner Cable, December 24, 1995. (Ref. Annex B.)

3 Terms and definitions

This Recommendation defines the following terms.

3.1 Address Resolution Protocol (ARP): A protocol of the IETF for converting network addresses to 48-bit Ethernet addresses.

3.2 American National Standards Institute (ANSI): A US standards body.

3.3 Asynchronous Transfer Mode (ATM): A protocol for the transmission of a variety of digital signals using uniform 53-byte cells.

3.4 availability: In cable television systems, availability is the long-term ratio of the actual RF channel operation time to scheduled RF channel operation time (expressed as a percent value) and is based on a Bit Error Rate (BER) assumption.

3.5 Bridge Protocol Data Unit (BDU): Spanning tree protocol messages as defined in [ISO/IEC 10038].

3.6 broadcast addresses: A predefined destination address that denotes the set of all data network service access points.

3.7 burst error second: Any Errored Second containing at least 100 errors.

- 3.8 Cable Modem (CM):** A modulator-demodulator at subscriber locations intended for use in conveying data communications on a cable television system (see Annex B). Called IIM in Annex A and MH in Annex C.
- 3.9 Cable Modem Termination System (CMTS):** Cable modem termination system, located at the cable television system headend or distribution hub, which provides complementary functionality to the cable modems to enable data connectivity to a wide-area network (see Annex A). Called INA in Annex A and MC in Annex C.
- 3.10 cable modem termination system; Network Side Interface (CMTS-NSI):** The interface, defined in [MCNS3], between a CMTS and the equipment on its network side (see Annex B). Called INA in Annex A and MC in Annex C.
- 3.11 Cable Modem to CPE Interface (CMCI):** The interface, defined in [MCNS4], between a CM and CPE.
- 3.12 carrier hum modulation:** The peak-to-peak magnitude of the amplitude distortion relative to the RF carrier signal level due to the fundamental and low-order harmonics of the power-supply frequency.
- 3.13 carrier-to-Noise Ratio (C/N or CNR):** The square of the ratio of the root mean square (rms) of the voltage of the digitally-modulated RF carrier to the rms of the continuous random noise voltage in the defined measurement bandwidth. (If not specified explicitly, the measurement bandwidth is the symbol rate of the digital modulation).
- 3.14 carrier related band** (applies to Annexes B and C only): A frequency bandwidth of spacing television channels on a cable television system in exact 6 MHz increments.
- 3.15 Composite Second Order Beat (CSO):** The peak of the average level of distortion products due to second-order non-linearities in cable system equipment.
- 3.16 Composite Triple Beat (CTB):** The peak of the average level of distortion components due to third-order non-linearities in cable system equipment.
- 3.17 cyclic redundancy check:** A method of error detection using cyclic code.
- 3.18 cross-modulation:** A form of television signal distortion where modulation from one or more television channels is imposed on another channel or channels.
- 3.19 customer:** See End User.
- 3.20 Customer Premises Equipment (CPE):** Equipment at the end user's premises; may be provided by the end user or the service provider.
- 3.21 data link layer:** Layer 2 in the Open System Interconnection (OSI) architecture; the layer that provides services to transfer data over the transmission link between open systems.
- 3.22 distribution hub:** A location in a cable television network which performs the functions of a Headend for customers in its immediate area, and which receives some or all of its television program material from a Master Headend in the same metropolitan or regional area; see, for example, [MCNS1].
- 3.23 downstream:** In cable television, the direction of transmission from the headend to the subscriber.
- 3.24 drop cable:** Coaxial cable that connects to a residence or service location from a directional coupler (tap) on the nearest coaxial feeder cable.
- 3.25 Dynamic Host Configuration Protocol (DHCP):** An Internet protocol used for assigning network-layer (IP) addresses.
- 3.26 dynamic range:** The ratio between the greatest signal power that can be transmitted over a multichannel analogue transmission system without exceeding distortion or other performance limits, and the least signal power that can be utilized without exceeding noise, error rate or other performance limits.

- 3.27 Electronic Industries Association (EIA):** A voluntary body of manufacturers which, among other activities, prepares and publishes standards.
- 3.28 end user:** A human being, organization, or telecommunications system that accesses the network in order to communicate via the services provided by the network.
- 3.29 errored second:** Any one second interval containing at least one bit error.
- 3.30 extended subplit:** A frequency division scheme that allows bidirectional traffic on a single coaxial cable. E.G. in North America, reverse path signals come to the Headend from 5 to 42 MHz, and forward path signals go from the Headend from 50 or 54 MHz to the upper frequency limit.
- 3.31 feeder cable:** Coaxial cables that run along streets within the served area and connect between the individual taps which serve the customer drops.
- 3.32 Fiber Distributed Data Interface (FDDI):** A fiber-based LAN standard.
- 3.33 fiber node:** A point of interface between a fiber trunk and the coaxial distribution.
- 3.34 forward channel:** The direction of RF signal flow away from the headend toward the end user; equivalent to Downstream.
- 3.35 group delay:** The difference in transmission time between the highest and lowest of several frequencies through a device, circuit or system.
- 3.36 guard time:** Minimum time allocated between bursts in the upstream, referenced from the symbol center of the last symbol of a burst to the symbol center of the first symbol of the following burst.
- 3.37 Harmonic Related Carrier (HRC):** A method of spacing television channels on a cable television system in exact 6 MHz increments, with all carrier frequencies harmonically related to a common reference.
- 3.38 headend:** The central location on the cable network that is responsible for injecting broadcast video and other signals in the downstream direction. See also Master Headend, Distribution Hub.
- 3.39 header:** Protocol control information located at the beginning of a protocol data unit.
- 3.40 High Frequency (HF):** Used in Annex B to refer to the entire subplit (5-30 MHz) and extended subplit (5-42 MHz) band used in reverse channel communications over the cable television network.
- 3.41 high return:** A frequency division scheme that allows bi-directional traffic on a single coaxial cable. Reverse channel signals propagate to the headend above the downstream passband.
- 3.42 hum modulation:** Undesired modulation of the television visual carrier by the fundamental or low-order harmonics of the power supply frequency, or other low-frequency disturbances.
- 3.43 Hybrid Fiber/Coax (HFC) system:** A broadband bidirectional shared-media transmission system using fiber trunks between the headend and the fiber nodes, and coaxial distribution from the fiber nodes to the customer locations.
- 3.44 interactive interface module** (see Annex A): Called CM in Annex B and MH in Annex C.
- 3.45 Incremental Related Carriers (IRC):** A method of spacing NTSC television channels on a cable television system in which all channels except 5 and 6 correspond to the standard channel plan, used to reduce composite triple beat distortions.
- 3.46 Institute of Electrical and Electronic Engineers (IEEE):** A voluntary organization which, among other things, sponsors standards committees and is accredited by the American National Standards Institute.
- 3.47 interleave:** An error correction method that enables the correction of burst noise induced errors.

- 3.48 International Electrotechnical Commission (IEC):** An international standards body.
- 3.49 International Organization for Standardization (ISO):** An international standards body, commonly known as the International Standards Organization.
- 3.50 Internet Control Message Protocol (ICMP):** An Internet network-layer protocol.
- 3.51 Internet Engineering Task Force (IETF):** A body responsible, among other things, for developing standards used in the Internet. See also request for comments.
- 3.52 impulse noise:** Noise characterized by non-overlapping transient disturbances.
- 3.53 Internet Protocol (IP):** An Internet network-layer protocol, defined by the IETF.
- 3.54 Japan Cable Television Engineering Association (JCTEA):** A body responsible for developing standards concerning cable television systems in Japan.
- 3.55 latency:** The time, expressed in quantity of symbols, taken for a signal element to pass through a device.
- 3.56 layer:** A subdivision of the Open System Interconnection (OSI) architecture, constituted by subsystems of the same rank.
- 3.57 Local Area Network (LAN):** A non-public data network in which serial transmission is used for direct data communication among data stations located on the user's premises.
- 3.58 Logical Link Control (LLC) procedure:** In a Local Area Network (LAN) or a Metropolitan Area Network (MAN), that part of the protocol that governs the assembling of data link layer frames and their exchange between data stations, independent of how the transmission medium is shared.
- 3.59 MAC service access point:** See B. 6.1.2.
- 3.60 master headend:** A headend which collects television program material from various sources by satellite, microwave, fiber and other means, and distributes this material to Distribution Hubs in the same metropolitan or regional area. A Master Headend may also perform the functions of a Distribution Hub for customers in its own immediate area; see, for example, [MCNS1].
- 3.61 multimedia center equipment:** Equipment located at cable television headend, which provides complementary functionality to the Multimedia Home Equipment to enable data connectivity to a wide-area network. Called CMTS in Annex B and INA in Annex A.
- 3.62 Mean Time to Repair (MTTR):** In cable television systems, the MTTR is the average elapsed time from the moment a loss of RF channel operation is detected up to the moment the RF channel operation is fully restored.
- 3.63 Media Access Control (MAC) address:** The "built-in" hardware address of a device connected to a shared medium.
- 3.64 Media Access Control (MAC) procedure:** In a subnetwork, that part of the protocol that governs access to the transmission medium independent of the physical characteristics of the medium, but taking into account the topological aspects of the subnetworks, in order to enable the exchange of data between nodes. MAC procedures include framing, error protection, and acquiring the right to use the underlying transmission medium.
- 3.65 Media Access Control (MAC) sublayer:** The part of the data link layer that supports topology dependent functions and uses the services of the Physical Layer to provide services to the Logical Link Control (LLC) sublayer.
- 3.66 multimedia home equipment:** A modulator-demodulator at subscriber locations intended for use in conveying data communications on a cable television system (see Annex C). Called CMTS in Annex B and INA in Annex A.
- 3.67 micro-reflections:** Echoes in the forward transmission path due to departures from ideal amplitude and phase characteristics.

- 3.68 mid split:** A frequency division scheme that allows bi-directional traffic on a single coaxial cable, e.g. in North America, reverse channel signals propagate to the headend from 5 to 108 MHz, the forward path signals go from the Headend from 162 MHz to the upper frequency limit, and the duplex crossover band is located from 108 to 162 MHz.
- 3.69 mini-slot:** In Annex B, a mini-slot is an integer multiple of 6.25-microsecond increments. The relationship between mini-slots, bytes and time ticks is described in B.6.5.4.
- 3.70 Moving Picture Experts Group (MPEG):** A voluntary body which develops standards for digital compressed moving pictures and associated audio.
- 3.71 Multimedia Cable Network System (MCNS) partners:** A consortium of Comcast Cable Communications, Inc., Cox Communications, Tele-Communications, Inc., and Time Warner Cable, interested in deploying high-speed data communications systems on cable television systems.
- 3.72 multipoint access:** User access in which more than one terminal equipment is supported by a single network termination.
- 3.73 multipoint connection:** A connection among more than two data network terminations.
- 3.74 National Cable Television Association (NCTA):** A voluntary association of cable television operators which, among other things, provides guidance on measurements and objectives for cable television systems in the USA.
- 3.75 National Television Systems Committee (NTSC):** Committee which defined the analog colour television broadcast standard used in North America.
- 3.76 network layer:** Layer 3 in the Open System Interconnection (OSI) architecture; the layer that provides services to establish a path between open systems.
- 3.77 network management:** The functions related to the management of data link layer and physical layer resources and their stations across the data network supported by the hybrid fiber/coax system.
- 3.78 Open Systems Interconnection (OSI):** A framework of ISO standards for communication between different systems made by different vendors, in which the communications process is organized into seven different categories that are placed in a layered sequence based on their relationship to the user. Each layer uses the layer immediately below it and provides a service to the layer above. Layers 7 through 4 deal with end-to-end communication between the message source and destination, and layers 3 through 1 deal with network functions.
- 3.79 Organizationally Unique Identifier (OUI):** A three octet IEEE assigned identifier that OUI can be used to generate Universal LAN MAC addresses and Protocol Identifiers per ANSI/IEEE Std 802 for use in Local and Metropolitan Area Network applications.
- 3.80 Packet Identifier (PID):** A unique integer value used to identify elementary streams of a program in a single- or multi-program MPEG-2 stream.
- 3.81 Physical (PHY) layer:** Layer 1 in the Open System Interconnection (OSI) architecture; the layer that provides services to transmit bits or groups of bits over a transmission link between open systems and which entails electrical, mechanical and handshaking procedures.
- 3.82 Physical Media Dependent (PMD) sublayer:** A sublayer of the Physical Layer which is concerned with transmitting bits or groups of bits over particular types of transmission link between open systems and which entails electrical, mechanical and handshaking procedures.
- 3.83 Program Specific Information (PSI):** In MPEG-2, normative data necessary for the demultiplexing of Transport Streams and the successful regeneration of programs.
- 3.84 program stream:** In MPEG-2, a multiplex of variable-length digital video and audio packets from one or more program sources having a common time-base.

- 3.85 protocol:** A set of rules and formats that determines the communication behaviour of layer entities in the performance of the layer functions.
- 3.86 Quadrature Amplitude Modulation (QAM):** A method of modulating digital signals onto a radio-frequency carrier signal involving both amplitude and phase coding.
- 3.87 Quaternary Phase-Shift Keying (QPSK):** A method of modulating digital signals onto a radio-frequency carrier signal using four phase states to code two digital bits.
- 3.88 Radio Frequency (RF):** In cable television systems, this refers to electromagnetic signals typically in the range 5 to 1000 MHz.
- 3.89 Reed-Solomon code:** A forward error correction code located before interleaving that enables correction of errors induced by burst noise.
- 3.90 Request for Comments (RFC):** A technical policy document of the IETF; these documents can be accessed on the World Wide Web at <http://ds.internic.net/ds/rfcindex.html>.
- 3.91 return loss:** The parameter describing the attenuation of a guided wave signal (e.g. via a coaxial cable) returned to a source by a device or medium resulting from reflections of the signal generated by the source.
- 3.92 reverse channel:** The direction of signal flow towards the headend, away from the subscriber; equivalent to Upstream.
- 3.93 roll off:** A coefficient of cosine roll off function that determines the frequency characteristics of the filter.
- 3.94 Routing Information Protocol (RIP):** A protocol of the IETF for exchanging routing information about IP networks and subnets.
- 3.95 Service Access Point (SAP):** The point at which services are provided by one layer, or sublayer, to the layer immediately above it.
- 3.96 Service Data Unit (SDU):** Information that is delivered as a unit between peer service access points.
- 3.97 Simple Network Management Protocol (SNMP):** A network management protocol of the IETF.
- 3.98 Spectrum Management System (SMS):** A system, defined in [SMS], for managing the RF cable spectrum.
- 3.99 sublayer:** A subdivision of a layer in the Open System Interconnection (OSI) reference model.
- 3.100 subnetwork:** Subnetworks are physically formed by connecting adjacent nodes with transmission links.
- 3.101 Subnetwork Access Protocol (SNAP):** An extension of the LLC header to accommodate the use of IEEE 802 type networks as IP networks.
- 3.102 subscriber:** See End User.
- 3.103 subsplit:** A frequency-division scheme that allows bi-directional traffic on a single cable, e.g. in North America, reverse path signals come to the Headend from 5 to 30 MHz (up to 42 MHz on Extended Subsplit systems), and forward path signals go from the headend from 50 or 54 MHz to the upper frequency limit of the cable network.
- 3.104 subsystem:** An element in a hierarchical division of an open system that interacts directly with elements in the next higher division or the next lower division of that open system.
- 3.105 systems management:** Functions in the application layer related to the management of various Open Systems Interconnection (OSI) resources and their status across all layers of the OSI architecture.

- 3.106 tick:** Time intervals that are the reference for upstream mini-slot definition and upstream transmission times.
- 3.107 tilt:** Maximum difference in transmission gain of a cable television system over a given bandwidth (typically the entire forward operating frequency range).
- 3.108 transit delay:** The time difference between the instant at which the first bit of a PDU crosses one designated boundary, and the instant at which the last bit of the same PDU crosses a second designated boundary.
- 3.109 Transmission Control Protocol (TCP):** A transport-layer Internet protocol which ensures successful end-to-end delivery of data packets without error, as defined by the IETF.
- 3.110 transmission convergence sublayer:** A sublayer of the Physical Layer that provides an interface between the Data Link Layer and the PMD Sublayer.
- 3.111 transmission link:** The physical unit of a subnetwork that provides the transmission connection between adjacent nodes.
- 3.112 transmission medium:** The material on which information signals may be carried; e.g., optical fiber, coaxial cable, and twisted wire pairs.
- 3.113 transmission system:** The interface and transmission medium through which peer physical layer entities transfer bits.
- 3.114 transmit on/off ratio:** In multiple-access systems, the ratio between the signal powers sent to line when transmitting and when not transmitting.
- 3.115 transport stream:** In MPEG-2, a packet based method of multiplexing one or more digital video and audio streams having one or more independent time bases into a single stream.
- 3.116 Trivial File Transfer Protocol (TFTP):** An Internet protocol for transferring files without the requirement for user names and passwords that is typically used for automatic downloads of data and software.
- 3.117 trunk cable:** Cables that carry the signal from the headend to groups of subscribers. The cables can be either coaxial or fiber depending on the design of the system.
- 3.118 Type/Length/Value (TLV):** An encoding of three fields, in which the first field indicates the type of element, the second the length of the element, and the third field, the value.
- 3.119 upstream:** The direction from the subscriber location toward the headend.

4 Abbreviations

This Recommendation uses the following abbreviations:

(C/N or CNR)	Carrier-to-Noise Ratio
ANSI	American National Standards Institute
ARP	Address Resolution Protocol
ATM	Asynchronous Transfer Mode
BC	Broadcast Channel
BPDU	Bridge Protocol Data Unit
BRA	Basic Rate Access
CATV	Cable Television
CM	Cable Modem, IIM, MH
CMCI	Cable Modem to CPE Interface
CMTS	Cable Modem Termination System
CMTS-NSI	Cable Modem Termination System – Network Side Interface

CPE	Customer Premises Equipment
CRC	Cyclic Redundancy Check
CSO	Composite Second Order beat
CTB	Composite Triple Beat
DA	Destination Address
DAVIC	Digital Audiovisual Council
DCE	Data Communication Equipment
DHCP	Dynamic Host Configuration Protocol
DOC	Data over Cable
DTE	Data Termination Equipment
DTMF	Dual Tone Multifrequency (dialling mode)
DVB	Digital Video Broadcasting
EH or EHDR	Extended Header
EIA	Electronic Industries Association
FC	Frame Control
FDDI	Fiber Distributed Data Interface
FDM	Frequency Division Multiplex
FDMA	Frequency Division Multiple Access
FEC	Forward Error Correction
GSTN	General Switched Telephone Network
GT	Global Time
HCS	Header Check Sequence
HF	High Frequency
HFC	Hybrid Fiber/Coax system
HRC	Harmonic Related Carrier
IB	In-Band
IC	Interaction Channel
ICMP	Internet Control Message Protocol
IE	Information Element
IEC	International Electrotechnical Commission
IEEE	Institute of Electrical and Electronic Engineers
IETF	Internet Engineering Task Force
IIM	Interactive Interface Module
INA	Interactive Network Adapter
IP	Internet Protocol
IQ	In-phase and Quadrature Components
IRC	Incremental Related Carriers (IRC)
IRD	Integrated Receiver Decoder
ISDN	Integrated Services Digital Network
ISO	International Organization for Standardization
JCTEA	Japan Cable Television Engineering Association
LAN	Local Area Network

LEN	Length (in bytes unless otherwise stated)
LFSR	Linear Feedback Shift Register
LLC	Logical Link Control procedure
LSB	Least Significant Bit
LT	Local time
MAC	Media Access Control
MC	Multimedia Center Equipment
MCNS	Multimedia Cable Network System
MH	Multimedia Home equipment
MMDS	Multi-channel Multi-point Distribution Systems
MPEG	Moving Picture Experts Group
MSAP	MAC Service Access Point
MSB	Most Significant Bit
MTTR	Mean Time to Repair
NCTA	National Cable Television Association
NIU	Network Interface Unit
NSAP	Network Service Access Point
NTSC	National Television Systems Committee
OOB	Out of Band
OSI	Open Systems Interconnection
OUI	Organization Unique Identifier
PHY	Physical (PHY) layer
PID	Packet Identifier
PM	Pulse Modulation
PMD	Physical Media Dependent sublayer
PSI	Program Specific Information
PSTN	Public Switched Telephone Network
QAM	Quadrature Amplitude Modulation
QOS	Quality of Service
QPSK	Quaternary Phase-Shift Keying
REQ	Request indicator used in Annex B.
RF	Radio Frequency
RFC	Request for Comments
RIP	Routing Information Protocol
RNG	Ranging
RTD	Round Trip Delay
SAP	Service Access Point
SDU	Service Data Unit
SID	Service Identifier
SMATV	Satellite Master Antenna Television
SMS	Spectrum Management System
SNAP	Subnetwork Access Protocol
SNMP	Simple Network Management Protocol

STB	Set-Top Box
STU	Set-Top Unit
SYNC	Synchronization
TC	Transmission Convergence sublayer
TCP	Transmission Control Protocol
TDMA	Time Division Multiplex Access
TFTP	Trivial File Transfer Protocol
TLV	Type/Length/Value
TS	Transport Stream
UCC	Upstream Channel Change
UCD	Upstream Channel Descriptor

5 Interactive cable television services

It is recommended that for interactive cable television services, the appropriate systems described in the annexes be used in conjunction with the relevant cable distribution systems described in Recommendation J.83.

Annex A

Interaction channel for digital video broadcasting cable television distribution systems

A.1 Scope

This annex is derived from work done on the provisioning of interaction channels for CATV networks in Europe [ETS 300 800].

It is not intended to specify a return channel solution associated to each broadcast system because the interoperability of different delivery media to transport the return channel is desirable.

These solutions provided for interaction channel for CATV networks are a part of a wider set of alternatives to implement interactive services for digital video broadcasting systems.

A.2 Normative references

See common part of this Recommendation.

A.3 Abbreviations

See the common part of this Recommendation.

A.4 Reference model for system architecture of narrowband interaction channels in a broadcasting scenario (asymmetric interactive services)

A.4.1 Protocol stack model

For asymmetric interactive services supporting broadcast to the home with narrowband return channel, a simple communications model consists of the following layers:

- **physical layer:** Where all the physical (electrical) transmission parameters are defined;
- **transport layer:** Defines all the relevant data structures and communication protocols like data containers, etc.;
- **application layer:** Is the interactive application software and runtime environments (e.g. home shopping application, script interpreter, etc.).

This specification addresses the lower two layers (the physical and transport) leaving the application layer open to competitive market forces.

A simplified model of the OSI layers was adopted to facilitate the production of specifications for these nodes. Figure A.1 points out the lower layers of the simplified model and identifies some of the key parameters for the lower two layers. Following the user requirements for interactive services, no attempt will be made to consider higher layers in this specification.

This specification addresses the CATV network specific aspects only. The network independent protocols will be specified separately [ETS 300 802].

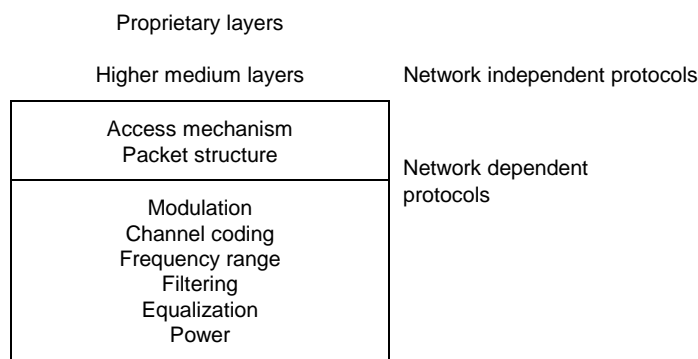

Figure A.1/J.112 – Layer structure for generic system reference model

A.4.2 System model

Figure A.2 shows the system model which is to be used within DVB for interactive services.

In the system model, two channels are established between the Service provider and the User:

- **Broadcast Channel (BC):** A unidirectional broadband Broadcast Channel including video, audio and data. BC is established from the service provider to the users. It may include the Forward Interaction path.
- **Interaction Channel (IC):** A Bidirectional Interaction Channel is established between the service provider and the user for interaction purposes. It is formed by:
 - **Return Interaction path (Return Channel):** From the User to the Service Provider. It is used to make requests to the service provider or to answer questions. It is a narrowband channel. Also commonly known as return channel.
 - **Forward Interaction path:** From the service provider to the user. It is used to provide some sort of information by the service provider to the user and any other required communication for the interactive service provision. It may be embedded into the broadcast channel. It is possible that this channel is not required in some simple implementations which make use of the Broadcast Channel for the carriage of data to the user.

The user terminal is formed by the Network Interface Unit (NIU) [consisting of the Broadcast Interface Module (BIM) and the Interactive Interface Module (IIM)] and the Set-Top Unit (STU). The user terminal provides interface for both broadcast and interaction channels. The interface between the user terminal and the interaction network is via the Interactive Interface Module.

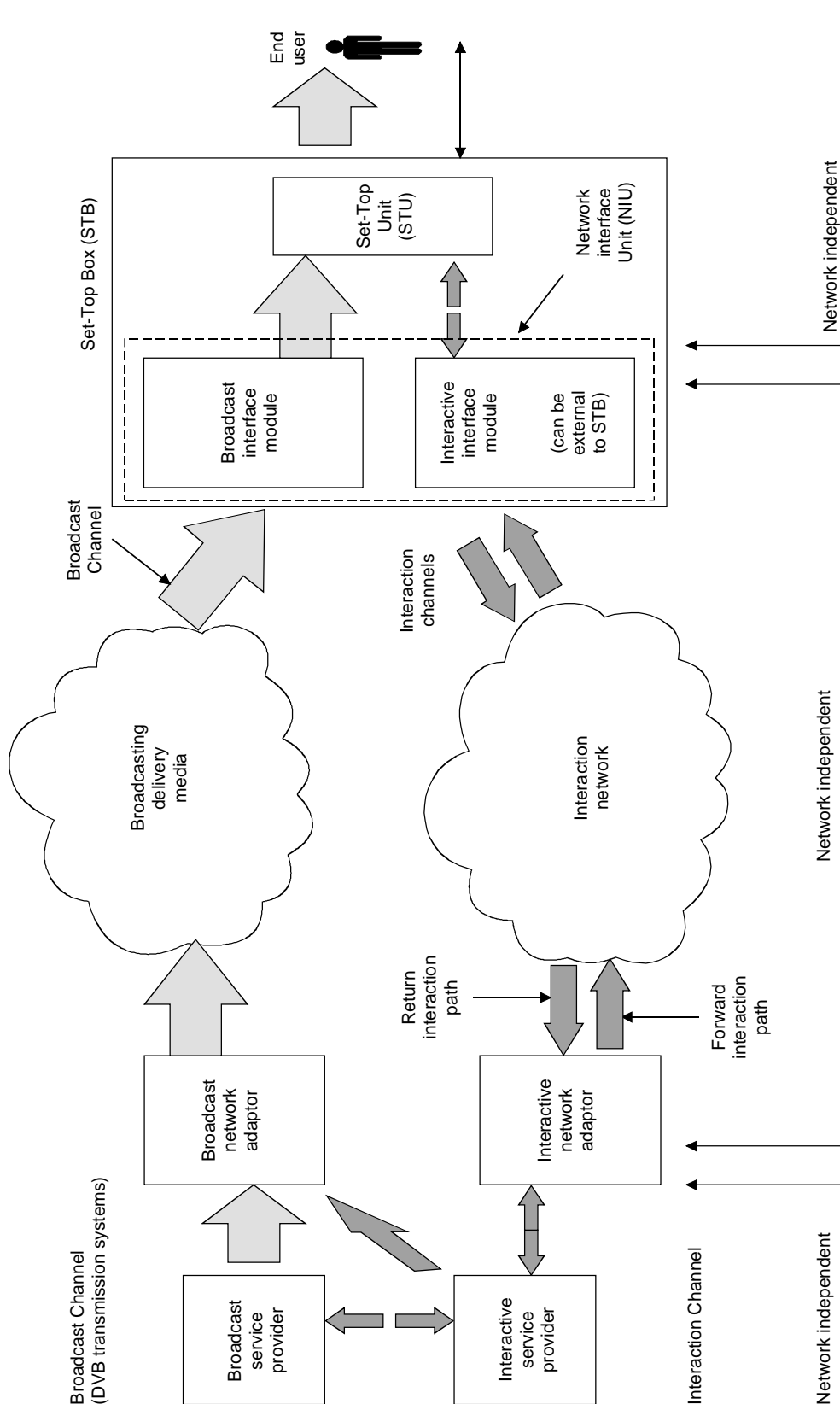

T0904350-97/d001

Figure A.2/J.112 – A generic system Reference Model for interactive systems

A.5 Interaction Channel specification for CATV networks

The CATV infrastructures can support the implementation of the Return Channel for interactive services suitable for DVB broadcasting systems.

CATV can be used to implement interactive services in the DVB environment, providing a bidirectional communication path between the user terminal and the service provider.

A.5.1 System concept

The interactive system is composed of Forward Interaction path (downstream) and Return Interaction path (upstream). The general concept is to use downstream transmission from the INA to the NIUs to provide synchronization and information to all NIUs. This allows the NIUs to adapt to the network and send synchronized information upstream.

Upstream transmission is divided into time slots which can be used by different users, using the technique of Time Division Multiple Access (TDMA). One downstream channel is used to synchronize up to 8 upstream channels, which are all divided into time slots. A counter at the INA is sent periodically to the NIUs, so that all NIUs work with the same clock. This gives the opportunity to the INA to assign time slots to different users.

Three major access modes are provided with this system. The first one is based on contention access, which lets users send information at any time with the risk to have a collision with other user's transmissions. The second and third modes are contention-less based, where the INA either provides a finite amount of slots to a specific NIU, or a given bit rate requested by a NIU until the INA stops the connection on NIU's demand. These access modes are dynamically shared among time slots, which allows NIUs to know when contention based transmission is or is not allowed. This is to avoid a collision for the two contention-less based access modes.

Periodically, the INA will indicate to new users that they have the possibility to go through sign-on procedure, in order to give them the opportunity to synchronize their clock to the network clock, without risking collisions with already active users. This is done by leaving a larger time interval for new users to send their information, taking into account the propagation time required from the INA to the NIUs and back.

A.5.1.1 Out-of-band/In-band principle

This interactive system is based either on Out-of-Band (OOB) or In-Band (IB) downstream signalling. However, Set-Top Boxes do not need to support both systems.

In the case of OOB signalling, a Forward Interaction path is added. This path is reserved for interactivity data and control information only. The presence of this added Forward Information path is in that case mandatory. However, it is also possible to send higher bit rate downstream information through a DVB-C channel whose frequency is indicated in the Forward Information path.

In the case of IB signalling, the Forward Information path is embedded into the MPEG-2 TS of a DVB-C channel. Note that it is not mandatory to include the Forward Information path in all DVB-C channels.

Both systems can provide the same quality of service. However, the overall system architecture will differ between networks using IB Set-Top Boxes and OOB Set-Top Boxes. Note also that both types of systems may exist on the same networks under the condition that different frequencies are used for each system.

A.5.1.2 Spectrum allocation

Figure A.3 indicates a possible spectrum allocation. Although not mandatory, a guideline is provided to use the following preferred frequency ranges, 70-130 MHz and/or 300-862 MHz for the Forward Interaction path (downstream OOB) and 5-65 MHz for the Return Interaction path (upstream), or parts thereof. To avoid filtering problems in the bidirectional RF amplifiers and in the Set-Top Boxes, the upper limit 65 MHz for the upstream flow shall not be used together with the lower limit 70 MHz for the downstream flow in the same system. For passive networks, the frequency range 5-65 MHz could be used bidirectionally. Furthermore, to avoid intermediate frequency impairments of Set-Top Boxes as well as analogue receivers in the same network, it could be necessary to leave out some parts of the range 5-65 MHz which includes the intermediate frequency ranges of these appliances.

NOTE – To fix detailed limits for the usable frequency range(s), future investigations concerning the intermediate frequency immunity of receivers must be carried through.

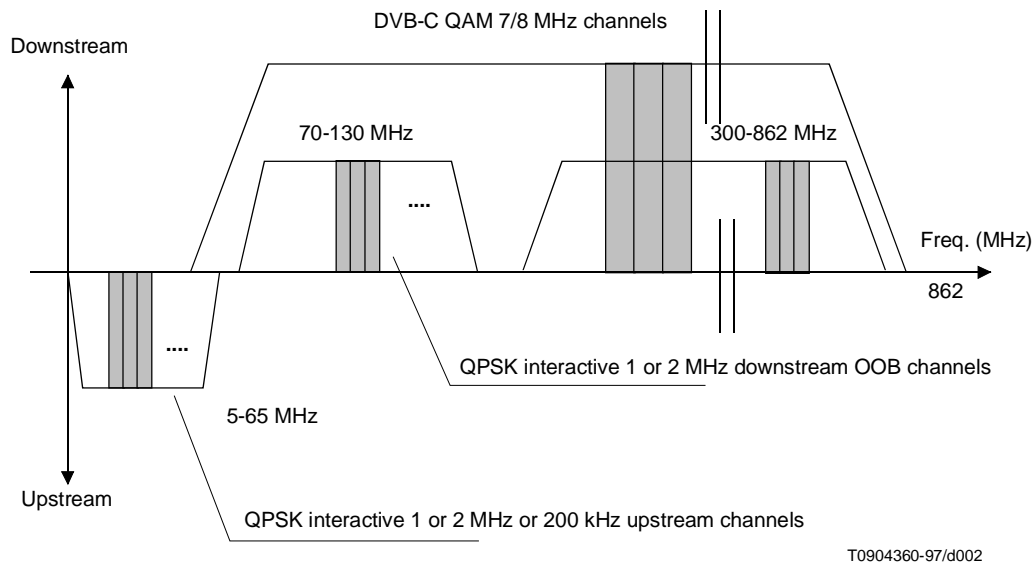

Figure A.3/J.112 – DVB preferred frequency ranges for CATV interactive systems

A.5.1.3 FDM/TDMA multiple access

A multiple access scheme is defined in order to have different users share the same transmission media. Downstream information is sent broadcast to all users of the networks. Thus, an address assignment exists for each user which allows the INA to send information singlecast to one particular user. Two addresses are stored in Set-Top Boxes in order to identify users on the network:

- MAC address: It is a 48-bit value representing the unique MAC address of the NIU. This MAC address may be hard coded in the NIU or be provided by external source.
- NSAP address: It is a 160-bit value representing a network address. This address is provided by higher layers during communication.

Upstream information may come from any user in the network and must therefore also be differentiated at the INA using the set of addresses defined above.

Upstream and OOB downstream channels are divided into separate channels of 1 or 2 MHz bandwidth for downstream and 1 or 2 MHz or 200 kHz for upstream. Each downstream channel contains a synchronization frame used by up to 8 different upstream channels, whose frequencies are indicated by the Media Access Control (MAC) protocol.

Within upstream channels, users send packets with TDMA type access. This means that each channel is shared by many different users, who can either send packets with a possibility of collisions when this is allowed by the INA, or request transmission and use the packets assigned by the INA to each user specifically. Assuming each channel can therefore accommodate thousands of users at the same time, the upstream bandwidth can easily be used by all users present on the network at the same time.

The TDMA technique utilizes a slotting methodology which allows the transmit start times to be synchronized to a common clock source. Synchronizing the start times increases message throughput of this signalling channel since the message packets do not overlap during transmission. The period between sequential start times are identified as slots. Each slot is a point in time when a message packet can be transmitted over the signalling link.

The time reference for slot location is received via the downstream channels generated at the Delivery System and received simultaneously by all Set-Top Units. Note that this time reference is not sent in the same way for OOB and IB signalling. Since all NIUs reference the same time base, the slot times are aligned for all NIUs. However, since there is propagation delay in any transmission network, a time base ranging method accommodates deviation of transmission due to propagation delay.

Since the TDMA signalling link is used by NIUs that are engaged in interactive sessions, the number of available message slots on this channel is dependent on the number of simultaneous users. When messaging slots are not in use, an NIU may be assigned multiple message slots for increased messaging throughput. Additional slot assignments are provided to the NIU from the downstream signalling information flow.

There are different access modes for the upstream slots:

- Reserved slots with fixed rate reservation (Fixed Rate Access: the user has a reservation of one or several time slots in each frame enabling, e.g. for voice, audio).
- Reserved slots with dynamic reservation (Reservation Access: the user sends control information announcing his demand for transmission capacity. He gets grants for the use of slots).
- Contention based slots (these slots are accessible for every user. Collision is possible and solved by a contention resolution protocol).
- Ranging slots (these slots are used upstream to measure and adjust the time delay and the power).

These slots may be mixed on a single carrier to enable different services on one carrier only. If one carrier is assigned to one specific service, only those slot types will be used which are needed for this service. Therefore a terminal can be simplified to respond to only those slot types assigned to the service.

A.5.1.4 Bit rates and Framing

For the interactive downstream OOB channel, a rate of 1.544 Mbit/s or 3.088 Mbit/s may be used. For downstream IB channels, no other constraints than those specified in the DVB-C specifications exist, but a guideline would be to use rates multiples of 8 kbit/s.

Downstream OOB channels continuously transmit a frame based on T1 type framing, in which some information is provided for synchronization of upstream slots. Downstream IB channels transmit some MPEG-2 TS packets with a specific PID for synchronization of upstream slots (at least one packet containing synchronization information must be sent in every period of 3 ms).

For upstream transmission, the INA can indicate three types of transmission rates to users, specifically 3.088 Mbit/s, 1.544 Mbit/s or 256 kbit/s. The INA is responsible for indicating which rate may be used by NIUs. It would imply all NIUs to be able to either transmit with 256 kbit/s, 1.544 Mbit/s, or 3.088 Mbit/s. Only the implementation of one of these bit rates would be mandatory.

Upstream framing consists of packets of 512 bits (256 symbols) which are sent in a bursty mode from the different users present on the network. The upstream slot rates are 6000 upstream slots/s when the upstream data rate is 3.088 Mbit/s, 3000 upstream slots/s when the upstream data rate is 1.544 Mbit/s and 500 upstream slots/s when the upstream data rate is 256 kbit/s.

A.5.2 Lower physical layer specification

In this subclause, detailed information is given on the lower physical layer specification. Figures A.4 and A.5 show the conceptual block diagrams for implementation of the present specification.

A.5.2.1 Forward interaction path (downstream OOB)

A.5.2.1.1 Frequency range (downstream OOB)

The frequency range is not specified as mandatory although a guideline is provided to use the following preferred frequency ranges, 70-130 MHz and/or 300-862 MHz or parts thereof, in order to simplify the tuner of the NIU. Frequency stability shall be in the range ± 50 ppm measured at the upper limit of the frequency range.

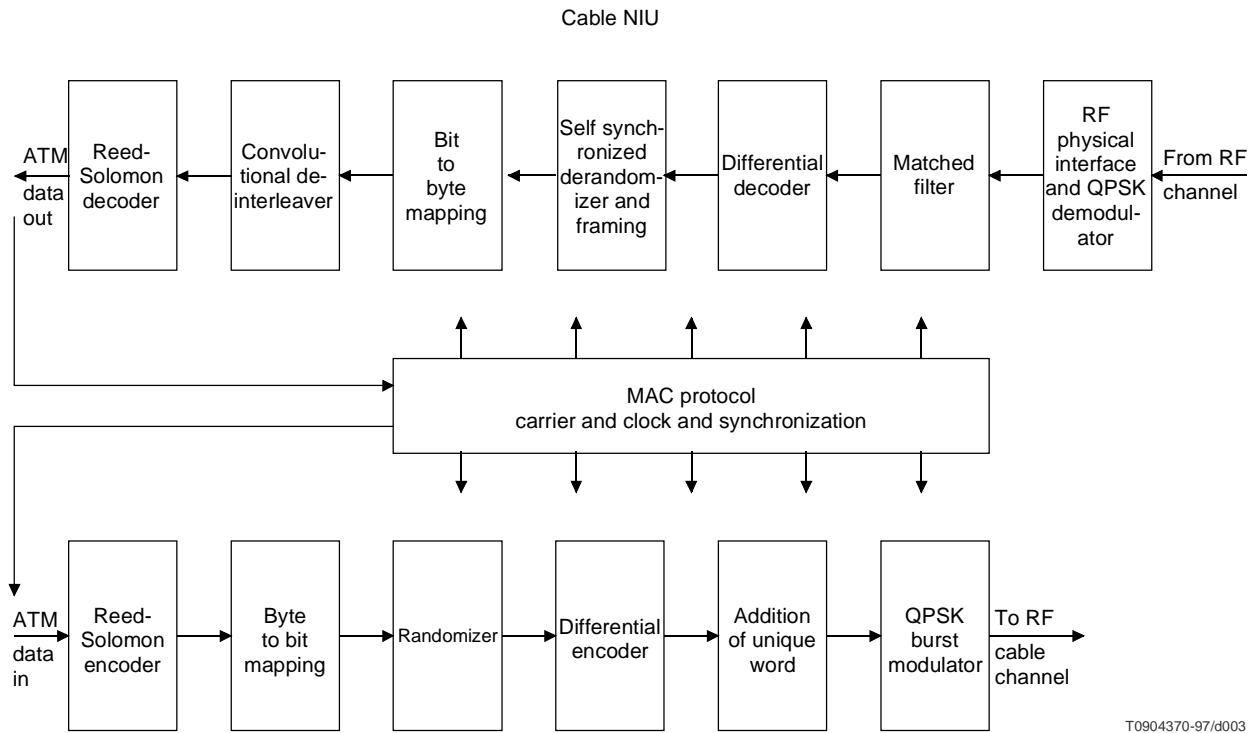

Figure A.4/J.112 – Conceptual block diagram for the NIU OOB transceiver

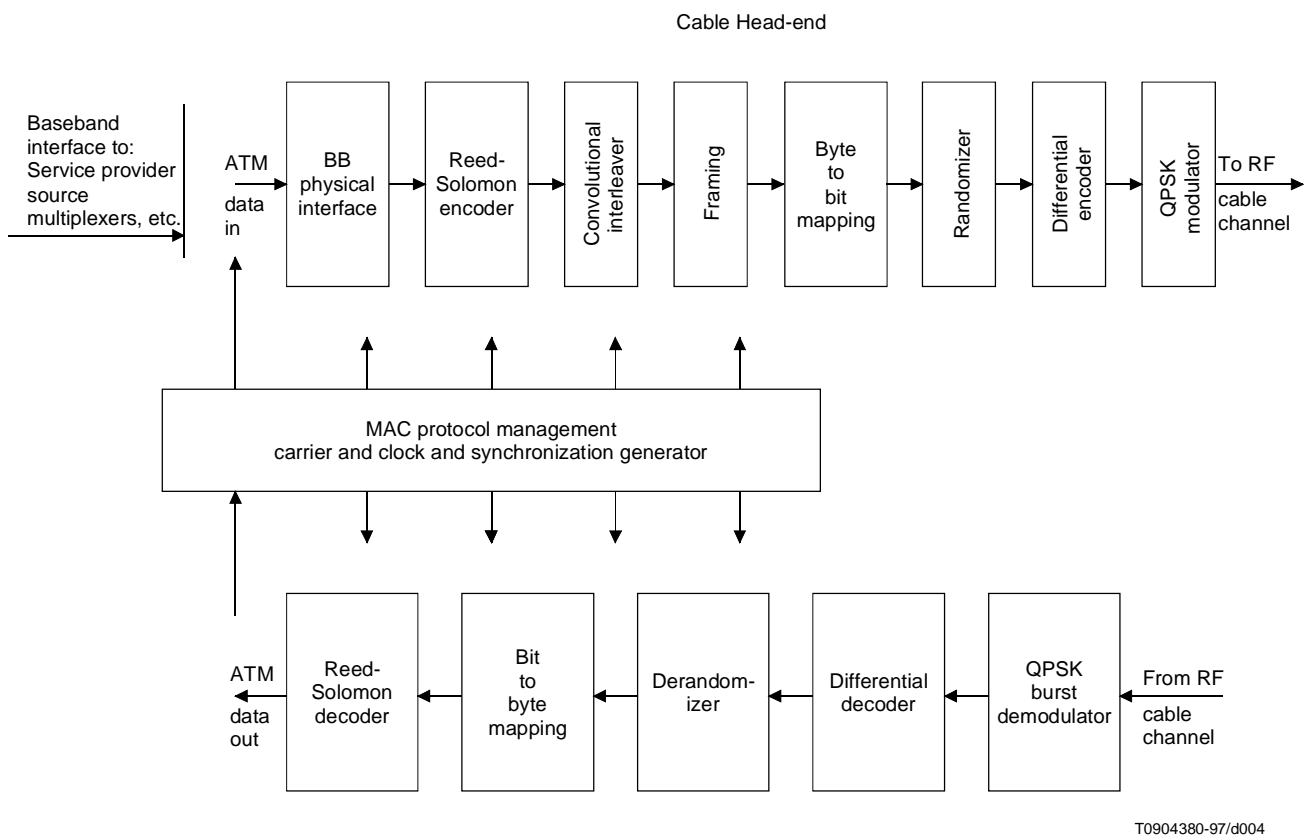

Figure A.5/J.112 – Conceptual block diagram for the OOB head-end transceiver

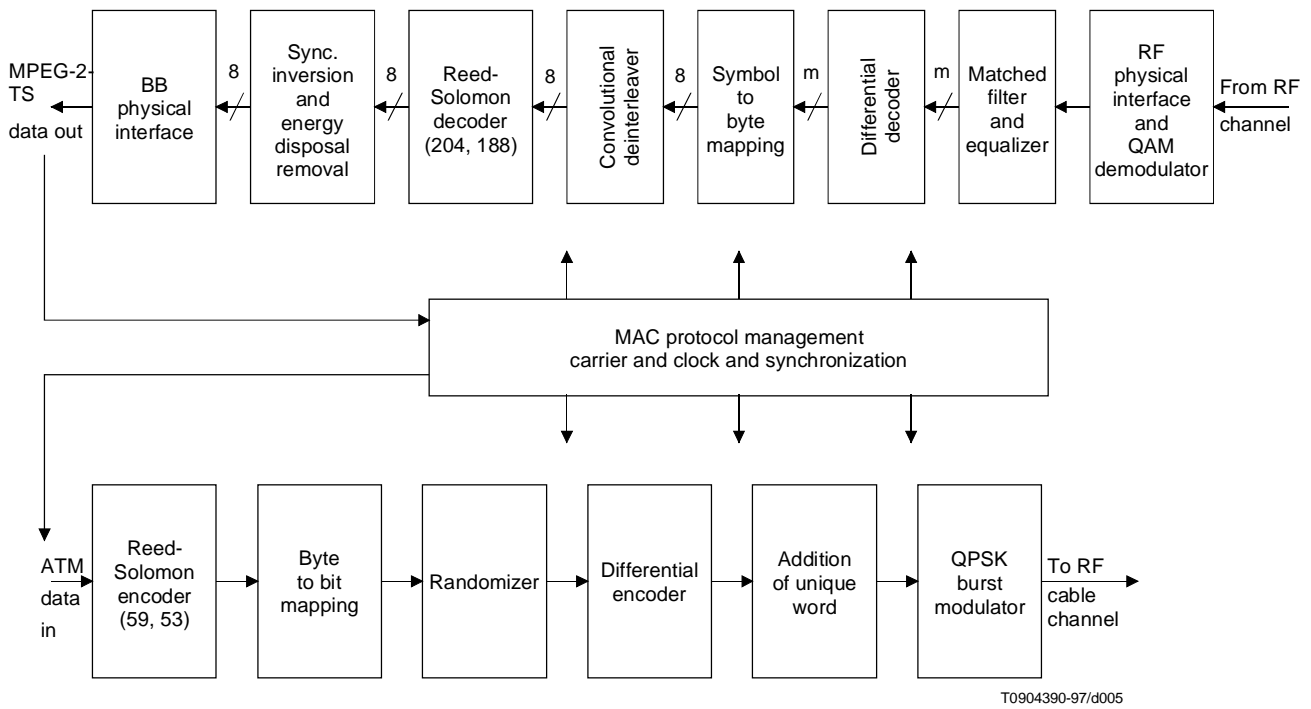

Figure A.6/J.112 – Conceptual block diagram for the IB NIU transceiver

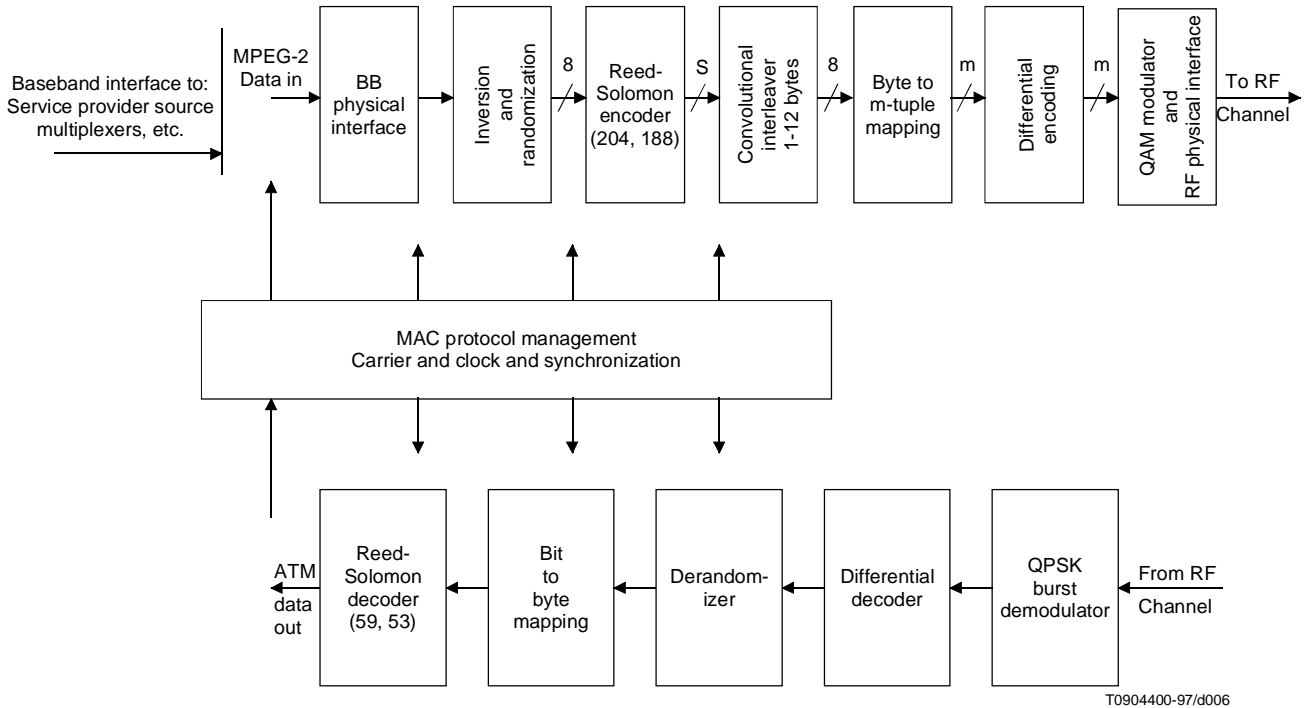

Figure A.7/J.112 – Conceptual block diagram for the IB head-end transceiver

A.5.2.1.2 Modulation and mapping (downstream OOB)

QPSK modulation is used as a means of encoding digital information over wireline or fibre transmission links. The method is a subset of Phase Shift Keying (PSK) which is a subset of Phase Modulation (PM). Specifically QPSK is a four level use of digital Phase Modulation (PM). Quadrature signal representations involve expressing an arbitrary phase sinusoidal waveform as a linear combination of a cosine wave and a sine wave with zero starting phases.

QPSK systems require the use of differential encoding and corresponding differential detection. This is a result of the receivers having no method of determining if a recovered reference is a sine reference or a cosine reference. In addition, the polarity of the recovered reference is uncertain.

Differential encoding transmits the information in encoded phase differences between the two successive signals. The modulator processes the digital binary symbols to achieve differential encoding and then transmits the absolute phases. The differential encoding is implemented at the digital level.

The differential encoder shall accept bits A, B in sequence, and generate phase changes as shown in Table A.1:

Table A.1/J.112 – Phase changes associated with bit A, B

A	B	Phase Change
0	0	None
0	1	+90°
1	1	180°
1	0	-90°

In serial mode, A arrives first. The outputs I, Q from the differential encoder map to the phase states as in Figure A.8.

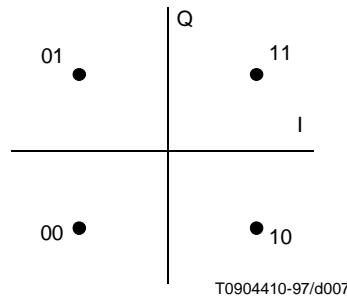

Figure A.8/J.112 – Mapping for the QPSK constellation (downstream OOB)

The phase changes can also be expressed by the following formulas (assuming the constellation is mapped from I and Q as shown in A.5.2.2.2):

$$\begin{cases} A_k = \overline{(I_{k-1} \oplus Q_{k-1})} \times (Q_{k-1} \oplus Q_k) + \overline{(I_k \oplus Q_{k-1})} \times (I_k \oplus I_{k-1}) \\ B_k = \overline{(I_{k-1} \oplus Q_{k-1})} \times (I_{k-1} \oplus I_k) + \overline{(I_{k-1} \oplus Q_k)} \times (Q_k \oplus Q_{k-1}) \end{cases}$$

where k is the time index.

I/Q amplitude imbalance shall be less than 1.0 dB, and phase imbalance less than 2.0°.

A.5.2.1.3 Shaping filter (downstream OOB)

The time-domain response of a square-root raised-cosine pulse with excess bandwidth parameter α is given by:

$$g(t) = \frac{\sin\left[\frac{\pi t}{T}(1-\alpha)\right] + \frac{4\alpha t}{T} \cos\left[\frac{\pi t}{T}(1+\alpha)\right]}{\frac{\pi t}{T} \left[1 - \left(\frac{4\alpha t}{T}\right)^2\right]}$$

where T is the symbol period.

The output signal shall be defined as:

$$S(t) = \sum_n [I_n \times g(t - nT) \times \cos(2\pi f_c t) - Q_n \times g(t - nT) \times \sin(2\pi f_c t)]$$

with I_n and Q_n equal to ± 1 , independently from each other, and f_c the QPSK modulator's carrier frequency.

The QPSK modulator divides the incoming bit stream so that bits are sent alternately to the in-phase modulator I and the out-of-phase modulator Q. These same bit streams appear at the output of the respective phase detectors in the demodulator where they are interleaved back into a serial bit stream.

The occupied bandwidth of a QPSK signal is given by the equation:

$$\text{Bandwidth} = \frac{f_b}{2} (1 + \alpha)$$

f_b = bit rate

α = excess bandwidth = 0.30

For both bit rates: 1.544 Mbit/s (Grade A) and 3.088 Mbit/s (Grade B), the Power Spectrum at the QPSK transmitter shall comply to the Power Spectrum Mask given in Table A.2 and Figure A.9. The Power Spectrum Mask shall be applied symmetrically around the carrier frequency.

Table A.2/J.112 – QPSK downstream transmitter Power Spectrum

$ (f - f_c)/f_N $	Power Spectrum
$\leq 1 - \alpha$	0 ± 0.25 dB
at 1	-3 ± 0.25 dB
at $1 + \alpha$	≤ -21 dB
≥ 2	≤ -40 dB

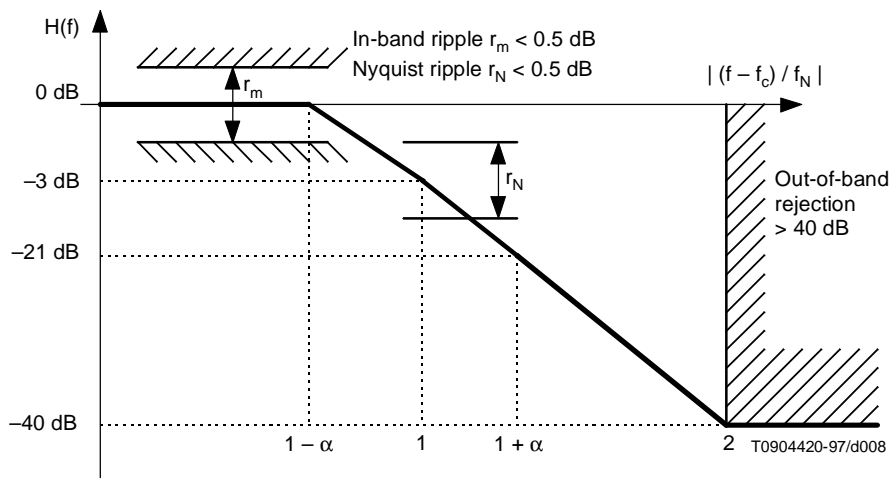

Figure A.9/J.112 – QPSK downstream transmitter Power Spectrum

QPSK systems require the use of differential encoding and corresponding differential detection. This is a result of the receivers having no method of determining if a recovered reference is a sine reference or a cosine reference. In addition, the polarity of the recovered reference is uncertain.

Differential encoding transmits the information in encoded phase differences between the two successive signals. The modulator processes the digital binary symbols to achieve differential encoding and then transmits the absolute phases. The differential encoding is implemented at the digital level.

A.5.2.1.4 Randomizer (downstream OOB)

After addition of the FEC bytes (see A.5.3), all of the 1.544 Mbit/s (or 3.088 Mbit/s) data is passed through a six register Linear Feedback Shift Register (LFSR) randomizer to ensure a random distribution of ones and zeroes. The generating polynomial is: $x^6 + x^5 + 1$. Byte/serial conversion shall be MSB first. A complementary self-synchronizing de-randomizer is used in the receiver to recover the data.

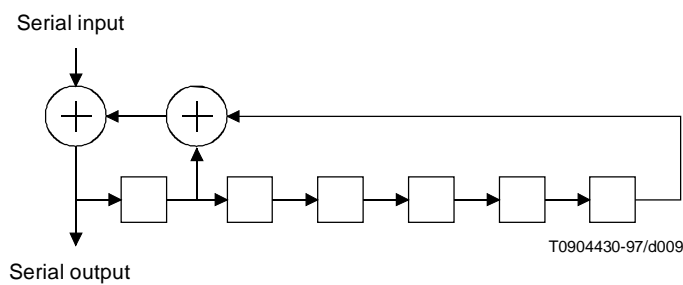

Figure A.10/J.112 – Randomizer

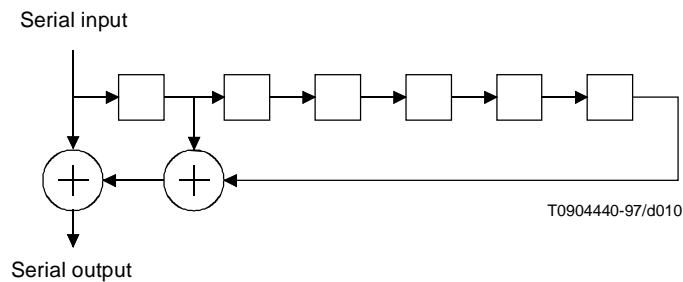

Figure A.11/J.112 – De-randomizer

A.5.2.1.5 Bit rate (downstream OOB)

The bit rate shall be 1.544 Mbit/s or 3.088 Mbit/s. Only one of the bit rates is mandatory in the NIU. Symbol rate accuracy should be within ± 50 ppm.

A.5.2.1.6 Receiver power level (downstream OOB)

The receiver power level shall be in the range 42-75 dBmicroV (RMS) (75 Ω) at its input.

A.5.2.1.7 Summary (downstream OOB)

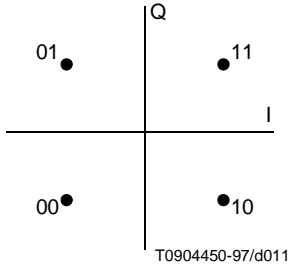
Transmission Rate	1.544 Mbit/s for Grade A 3.088 Mbit/s for Grade B															
Modulation	Differentially encoded QPSK															
Transmit Filtering	Filtering is alpha = 0.30 square root raised cosine															
Channel Spacing	1 MHz for Grade A 2 MHz for Grade B															
Frequency Step Size	250 kHz (center frequency granularity)															
Randomization	After addition of the FEC bytes, all of the 1.544 Mbit/s (or 3.088 Mbit/s) data is passed through a six register Linear Feedback Shift Register (LFSR) randomizer to ensure a random distribution of ones and zeroes. The generating polynomial is: $x^6 + x^5 + 1$. Byte/serial conversion shall be MSB first. A complementary self-synchronizing de-randomizer is used in the receiver to recover the data.															
Differential Encoding	The differential encoder shall accept bits A, B in sequence, and generate phase changes as follows: <table border="1" style="margin-left: 20px;"> <thead> <tr> <th>A</th> <th>B</th> <th>Phase-Change</th> </tr> </thead> <tbody> <tr> <td>0</td> <td>0</td> <td>None</td> </tr> <tr> <td>0</td> <td>1</td> <td>+90°</td> </tr> <tr> <td>1</td> <td>1</td> <td>180°</td> </tr> <tr> <td>1</td> <td>0</td> <td>-90°</td> </tr> </tbody> </table> In serial mode, A arrives first.	A	B	Phase-Change	0	0	None	0	1	+90°	1	1	180°	1	0	-90°
A	B	Phase-Change														
0	0	None														
0	1	+90°														
1	1	180°														
1	0	-90°														
Signal Constellation	The outputs I, Q from the differential encoder map to the phase states as in Figure A.12. <div style="text-align: center;">  <p>T0904450-97/d011</p> </div> <p>Figure A.12/J.112</p>															
Frequency Range	Recommended but not mandatory 70 to 130 MHz and/or 300 to 862 MHz															
Frequency Stability	± 50 ppm measured at the upper limit of the frequency range															
Symbol Rate Accuracy	± 50 ppm															
Carrier Suppression	> 30 dB															
I/Q Amplitude Imbalance	< 1.0 dB															
I/Q Phase Imbalance	< 2.0°															
Receive Power Level at input	42-75 dBmicroV (RMS) (75 Ω)															
Transmit Spectral Mask	A common mask for both bit rates: 1.544 Mbit/s (Grade A) and 3.088 Mbit/s (Grade B) is given in Table A.2 and in Figure A.9															

A.5.2.1.8 Bit error rate downstream OOB (informative)

Bit error rate at the NIU should be less than 10^{-10} (after error correction, i.e. 1 error in 2 hours at 1.5 Mbit/s) at $C/N > 20$ dB for downstream transmission. C/N is the carrier-to-noise ratio relevant for the demodulation process (Nyquist bandwidth for white noise).

A.5.2.2 Forward Interaction path (downstream IB)

The IB Forward Interaction Path must use a MPEG-2 TS stream with a modulated QAM channel as defined by ETS 300 429. Frequency range, channel spacing, and other lower physical layer parameters should follow that specification.

A.5.2.3 Return Interaction path (upstream)

A.5.2.3.1 Frequency range (upstream)

The frequency range is not specified as mandatory although a guideline is provided to use the 5-65 MHz. Frequency stability shall be in the range ± 50 ppm measured at the upper limit of the frequency range.

A.5.2.3.2 Modulation and mapping (upstream)

The unique word (CC CC CC 0D, see A.5.3 for upstream framing) is not differentially encoded, the outputs I, Q map to the phase states as in Figure A.13.

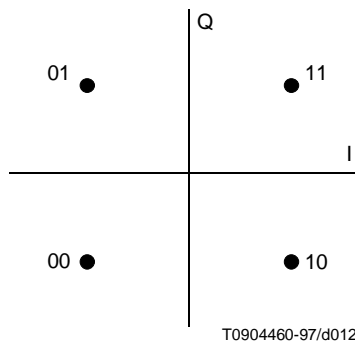

Figure A.13/J.112 – Mapping for the QPSK constellation (upstream)

For the remainder of the packet, the differential encoder shall accept bits A, B in sequence, and generate phase changes as indicated in Table A.3. It starts with the first information dibit and is initialized with the last dibit of the unique word, i.e. (A, B = 0, 1) since conversion is made MSB first.

Table A.3/J.112 – Phase changes corresponding to bits A, B

A	B	Phase change
0	0	None
0	1	+90°
1	1	180°
1	0	-90°

Phase changes correspond to the following formulas (assuming I and Q are mapped to the constellation as for the unique word):

$$\begin{cases} A_k = \overline{(I_{k-1} \oplus Q_{k-1})} \times (Q_{k-1} \oplus Q_k) + \overline{(I_k \oplus Q_{k-1})} \times (I_k \oplus I_{k-1}) \\ B_k = \overline{(I_{k-1} \oplus Q_{k-1})} \times (I_{k-1} \oplus I_k) + \overline{(I_{k-1} \oplus Q_k)} \times (Q_k \oplus Q_{k-1}) \end{cases}$$

where k is the time index.

I/Q amplitude imbalance shall be less than 1.0 dB, and phase imbalance less than 2.0° .

A.5.2.3.3 Shaping filter (upstream)

The time-domain response of a square-root raised-cosine pulse with excess bandwidth parameter α is given by:

$$g(t) = \frac{\sin\left[\frac{\pi t}{T}(1-\alpha)\right] + \frac{4\alpha t}{T} \cos\left[\frac{\pi t}{T}(1+\alpha)\right]}{\frac{\pi t}{T} \left[1 - \left(\frac{4\alpha t}{T}\right)^2\right]}$$

where T is the symbol period.

The output signal shall be defined as:

$$S(t) = \sum_n [I_n \times g(t - nT) \times \cos(2\pi f_c t) - Q_n \times g(t - nT) \times \sin(2\pi f_c t)]$$

with I_n and Q_n equal to ± 1 , independently from each other, and f_c the QPSK modulator's carrier frequency.

The QPSK modulator divides the incoming bit stream so that bits are sent alternately to the in-phase modulator I and the out-of-phase modulator Q. These same bit streams appear at the output of the respective phase detectors in the demodulator where they are interleaved back into a serial bit stream.

The QPSK signal parameters are:

- RF bandwidth: $BW = (f_b/2) * (1 + \alpha)$;
- Occupied RF Spectrum: $[f_c - BW/2, f_c + BW/2]$;
- Symbol Rate: $f_s = f_b/2$;
- Nyquist Frequency: $f_N = f_s/2$;

with f_b = bit rate, f_c = carrier frequency and α = excess bandwidth.

For all three bit rates: 256 kbit/s (Grade A), 1.544 Mbit/s (Grade B) and 3.088 Mbit/s (Grade C), the Power Spectrum at the QPSK transmitter shall comply to the Power Spectrum Mask given in Table A.4 and Figure A.14. The Power Spectrum Mask shall be applied symmetrically around the carrier frequency.

The specifications which shall apply to QPSK modulation for the upstream channel are given in Table A.4.

Table A.4/J.112 – QPSK upstream transmitter Power Spectrum

$ (f - f_c)/f_N $	Power Spectrum
$\leq 1 - \alpha$	0 ± 0.25 dB
at 1	-3 ± 0.25 dB
at $1 + \alpha$	≤ -21 dB
≥ 2	≤ -40 dB

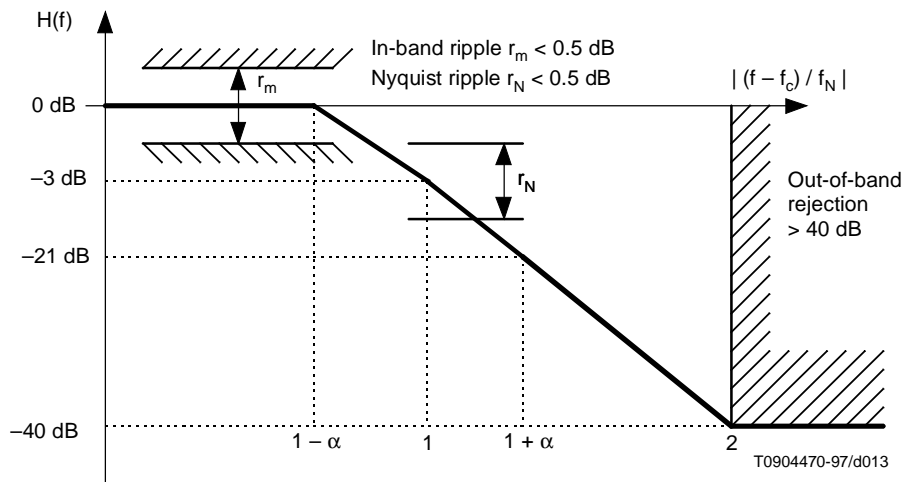

Figure A.14/J.112 – QPSK upstream transmitter Power Spectrum

A.5.2.3.4 Randomizer (upstream)

The unique word shall be sent in clear (see A.5.3). After addition of the FEC bytes, randomization shall apply only to the payload area and FEC bytes, with the randomizer performing modulo -2 addition of the data with a pseudo-random sequence. The generating polynomial is $x^6 + x^5 + 1$ with seed all ones. We assume the first value coming out of the pseudo-random generator taken into account is 0. Byte/serial conversion shall be MSB first. The binary sequence generated by the shift register starts with 00000100... The first "0" is to be added in the first bit after the unique word.

A complementary non self-synchronizing de-randomizer is used in the receiver to recover the data. The de-randomizer shall be enabled after detection of the unique word.

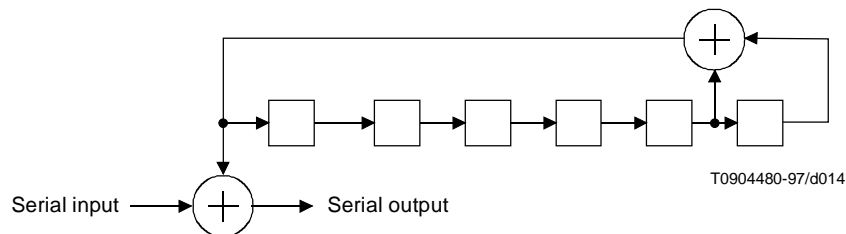

Figure A.15/J.112 – Randomizer

A.5.2.3.5 Bit rate (upstream)

Three grades of modulation transmission rate are specified:

Table A.5/J.112 – Upstream bit-rates for modulation grades A, B and C

Grade	Rate
A	256 kbit/s
B	1.544 Mbit/s
C	3.088 Mbit/s

A QPSK modulator (NIU transmitter) may support A, B and C grades of transmission rate. (Only the implementation of one of these grades should be mandatory.) A QPSK demodulator (INA receiver) shall support at least one grade A, B or C, but may support all grades.

Symbol rate accuracy should be within ± 50 ppm.

For grade A, the rate is 500 slots/s. For grade B, the rate is 3000 slots/s. For grade C, the rate is 6000 slots/s.

A.5.2.3.6 Transmit power level (upstream)

At the output, the transmit power level shall be in the range 85-113 dBmicroV (RMS) (75 Ω). In some geographic areas, it may be necessary to cover the range 85-122 dBmicroV (RMS) (75 Ω). However, note that high power may lead to electromagnetic compatibility problems. This power shall be adjusted by steps of 0.5 dB by MAC messages coming from the INA.

A.5.2.3.7 Carrier suppression when idle (upstream)

The Carrier Suppression shall be more than 60 dB below nominal power output level, over the entire power output range. A terminal is considered to be idle if it is 3 slots before an imminent transmission or 3 slots after its most recent transmission.

A.5.2.3.8 Summary (upstream)

See Table A.6.

Table A.6/J.112 – Summary (upstream)

Transmission Rate	Three grades of modulation transmission rate are specified: <table border="1"> <thead> <tr> <th>Grade</th> <th>Rate</th> </tr> </thead> <tbody> <tr> <td>A</td> <td>256 kbit/s</td> </tr> <tr> <td>B</td> <td>1.544 Mbit/s</td> </tr> <tr> <td>C</td> <td>3.088 Mbit/s</td> </tr> </tbody> </table> <p>A QPSK modulator (transmitter) may support A, B and C grades of transmission rate. (Only the implementation of one of these grades should be mandatory.) A QPSK demodulator (receiver) shall support at least one grade A, B, or C, but may support all grades.</p>	Grade	Rate	A	256 kbit/s	B	1.544 Mbit/s	C	3.088 Mbit/s							
Grade	Rate															
A	256 kbit/s															
B	1.544 Mbit/s															
C	3.088 Mbit/s															
Modulation	Differentially encoded QPSK															
Transmit Filtering	Alpha = 0.30 square root raised cosine															
Channel Spacing	200 kHz for Grade A (256 kbit/s) 1 MHz for Grade B (1.544 Mbit/s) 2 MHz for Grade C (3.088 Mbit/s)															
Frequency Step Size	50 kHz															
Randomization	The unique word shall be sent in the clear. After addition of the FEC bytes, randomization shall apply only to the payload area and FEC bytes, with the randomizer performing modulo -2 addition of the data with a pseudo-random sequence. The generating polynomial is $x^6 + x^5 + 1$ with seed all ones. Byte/serial conversion shall be MSB first. A complementary non self-synchronizing de-randomizer is used in the receiver to recover the data. The de-randomizer shall be enabled after detection of the unique word.															
Differential Encoding	The differential encoder shall accept bits A, B in sequence, and generate phase changes as follows. In serial mode, A arrives first. <table border="1"> <thead> <tr> <th>A</th> <th>B</th> <th>Phase Change</th> </tr> </thead> <tbody> <tr> <td>0</td> <td>0</td> <td>None</td> </tr> <tr> <td>0</td> <td>1</td> <td>+90°</td> </tr> <tr> <td>1</td> <td>1</td> <td>180°</td> </tr> <tr> <td>1</td> <td>0</td> <td>-90°</td> </tr> </tbody> </table>	A	B	Phase Change	0	0	None	0	1	+90°	1	1	180°	1	0	-90°
A	B	Phase Change														
0	0	None														
0	1	+90°														
1	1	180°														
1	0	-90°														

Table A.6/J.112 – Summary (upstream) (concluded)

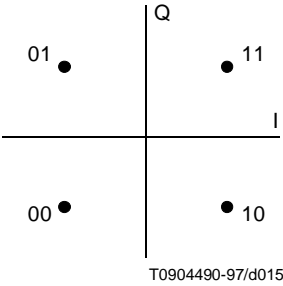
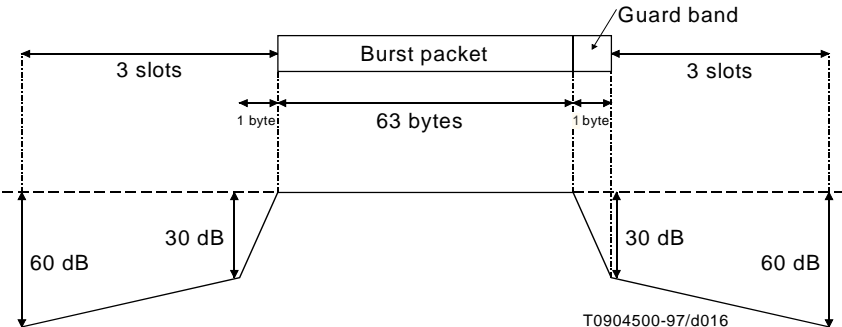
<p>Signal Constellation</p> <p>NOTE – The unique word (0x CC CC CC 0D) does not go through differential encoding.</p>	<p>The outputs I, Q from the differential encoder map to the phase states as in Figure A.16.</p> <div style="text-align: center;">  <p>Figure A.16/J.112</p> </div>
<p>Frequency Range</p>	<p>5-65 MHz recommended but not mandatory</p>
<p>Frequency Stability</p>	<p>± 50 ppm measured at the upper limit of the frequency range</p>
<p>Symbol Rate Accuracy</p>	<p>± 50 ppm</p>
<p>Transmit Spectral Mask</p>	<p>A common mask for all three bit rates: 256 kbit/s (Grade A), 1.544 Mbit/s (Grade B) and 3.088 Mbit/s (Grade C) is given in Table A.4 and Figure A.14.</p>
<p>Carrier Suppression when Transmitter Active</p>	<p>> 30 dB</p>
<p>Carrier Suppression when Transmitter Idle</p>	<p>The Carrier Suppression shall be more than 60 dB below nominal power output level over the entire power output range (see Recommendation I.361 for details) and 30 dB right after or before transmission.</p> <p>Idle Transmitter Definition: a terminal is considered to be idle if it is 3 slots before an imminent transmission or 3 slots after its most recent transmission.</p> <div style="text-align: center;">  </div>
<p>I/Q Amplitude Imbalance</p>	<p>< 1.0 dB</p>
<p>I/Q Phase Imbalance</p>	<p>< 2.0°</p>
<p>Transmit Power Level at the modulator output (upstream)</p>	<p>85-113 dBmicroV (RMS) (75 Ω) . In some geographic areas, it may be necessary to cover the range 85-122 dBmicroV (RMS) (75 Ω).</p>

A.5.2.3.9 Packet loss upstream (informative)

Packet loss at the INA shall be less than 10⁻⁶ at C/N > 20 dB (after error correction) for upstream transmission.

NOTE – A packet loss occurs when one or more bit per packet (after error correction) are uncorrectable. The C/N is referred at the demodulator input (Nyquist bandwidth, white noise).

A.5.3 Framing

A.5.3.1 Forward interaction path (downstream OOB)

A.5.3.1.1 Signalling Link Extended Superframe Framing format

The Signalling Link Extended Superframe (SL-ESF) frame structure is shown in Figure A.17. The bitstream is partitioned into 4632-bit Extended Superframes. Each Extended Superframe consists of 24 × 193-bit frames. Each frame consists of 1 Overhead (OH) bit and 24 bytes (192 bits) of payload.

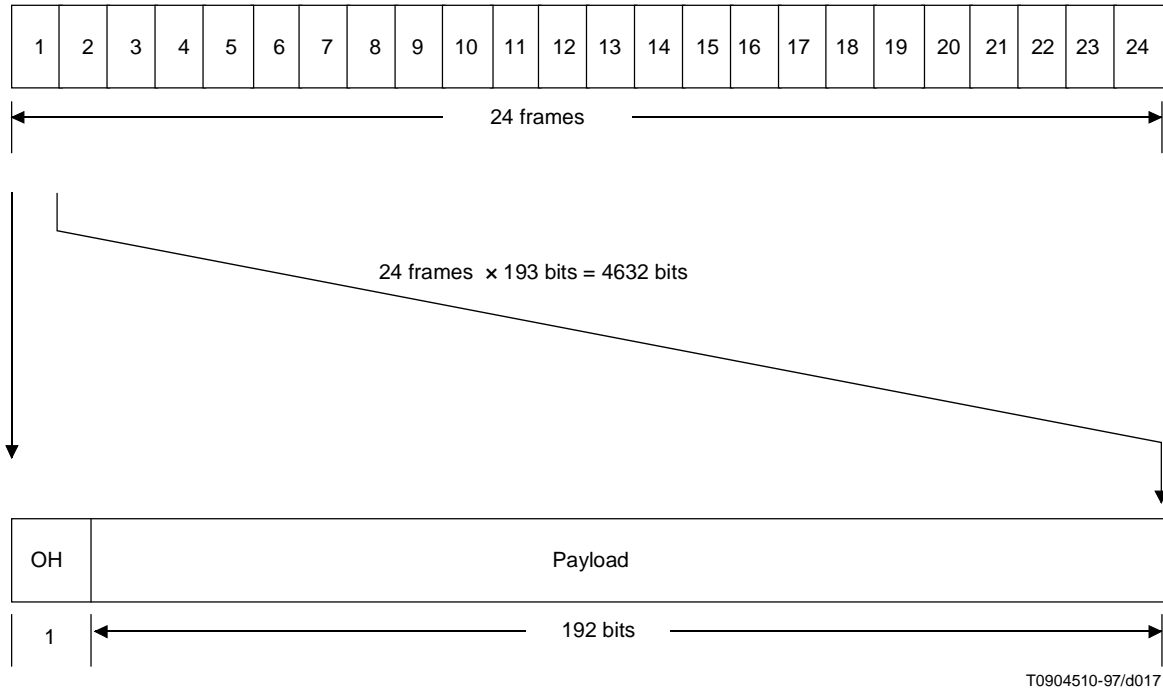

Figure A.17/J.112 – SL-ESF frame structure

A.5.3.1.2 Frame overhead

There are 24 frame overhead bits in the Extended Superframe which are divided into Extended Superframe Frame Alignment Signal (F1-F6), Cyclic Redundancy Check (C1-C6), and M-bit Data Link (M1-M12) as shown in Table A.7. Bit number 0 is received first.

ESF Frame Alignment Signal

The ESF Frame Alignment Signal (FAS) is used to locate all 24 frames and overhead bit positions. The bit values of the FAS are defined as follows:

$$F1 = 0, F2 = 0, F3 = 1, F4 = 0, F5 = 1, F6 = 1$$

ESF Cyclic Redundancy Check

The Cyclic Redundancy Check field contains the CRC-6 check bits calculated over the previous Extended Superframe (CRC Message block [CMB] size = 4632 bits). Before calculation, all 24 frame overhead bits are equal to "1". All information in the other bit positions is unchanged. The check bit sequence C1-C6 is the remainder after multiplication by x^6 and then division by the generator polynomial $x^6 + x + 1$ of the CMB. C1 is the most significant bit of the remainder. The initial remainder value is preset to all zeros.

ESF Mbit data link

The M-bits in the SL-ESF serve for slot timing assignment (see A.5.4).

Table A.7/J.112 – Frame overhead

Frame Number	Bit Number	Overhead bit	Data (192 bits)
1	0	M1	
2	193	C1	
3	386	M2	
4	579	F1 = 0	
5	772	M3	
6	965	C2	
7	1158	M4	
8	1351	F2 = 0	
9	1544	M5	
10	1737	C3	
11	1930	M6	
12	2123	F3 = 1	
13	2316	M7	
14	2509	C4	
15	2702	M8	
16	2895	F4 = 0	
17	3088	M9	
18	3281	C5	
19	3474	M10	
20	3667	F5 = 1	
21	3860	M11	
22	4053	C6	
23	4246	M12	
24	4439	F6 = 1	
FAS Frame Alignment Signal (F1-F6) DL Mbit Data Link (M1-M12) CRC Cyclic Redundancy Check (C1-C6)			

A.5.3.1.3 Payload structure

The SL-ESF frame payload structure provides a known container for defining the location of the ATM cells and the corresponding Reed-Solomon parity values. The SL-ESF payload structure is shown in Table A.8.

The SL-ESF payload structure consists of 5 rows of 57 bytes each, 4 rows of 58 bytes each which includes 1 byte trailer, and 1 row of 59 bytes, which includes a 2-byte trailer. The first bit of the SL-ESF payload structure follows the M1 bit of the SL-ESF frame. The SL-ESF payload fields are defined as follows. Table A.8 is read from left to right and top to bottom and mapped as is into the ESF frame described by Table A.7.

Table A.8/J.112 – ESF payload structure

	← 2		← 53			← 2		
1	R1a	R1b	ATM cell			RS parity		
2	R1c	R2a						R2 b
3	R2c	R3a						
4	R3b	R3c						R4 a
5	R4b	R4c						
6	R5a	R5b						R5 c
7	R6a	R6b						
8	R6c	R7a						R7 b
9	R7c	R8a						
10	R8b	R8c						T
								T

T0904520-97/d018

ATM cell structure

The format for each ATM cell structure is shown in Figure A.18. This structure and field coding shall be consistent with the structure and coding given in Recommendation I.361 for ATM UNI.

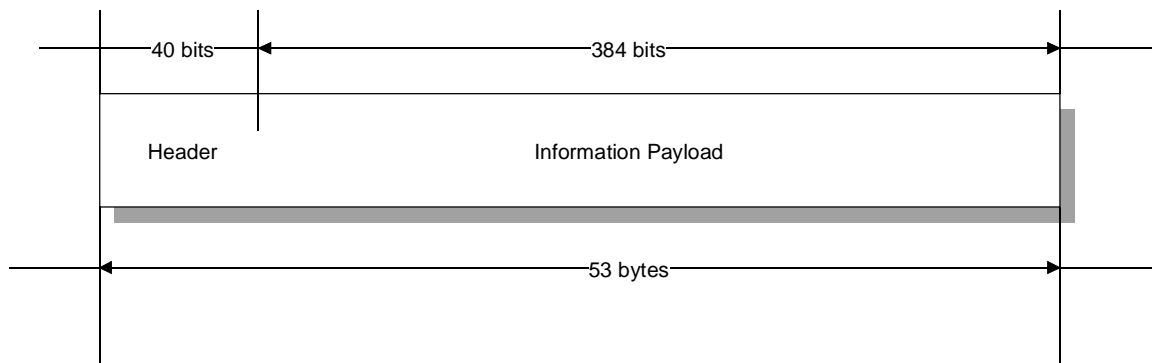

T0904530-97/d019

Figure A.18/J.112 – ATM cell format

Channel coding and interleaving

Reed-Solomon encoding with $t = 1$ shall be performed on each ATM cell. This means that 1 erroneous byte per ATM cell can be corrected. This process adds 2 parity bytes to the ATM cell to give a codeword of (55,53).

The Reed-Solomon code shall have the following generator polynomials:

- Code Generator Polynomial: $g(x) = (x + \mu^0)(x + \mu^1)$, where $\mu = 02$ hex;
- Field Generator Polynomial: $p(x) = x^8 + x^4 + x^3 + x^2 + 1$.

The shortened Reed-Solomon code shall be implemented by appending 200 bytes, all set to zero, before the information bytes at the input of a (255,253) encoder; after the coding procedure these bytes are discarded.

Convolutional interleaving shall be applied to the ATM cells contained in the SL-ESF. The Rxa-Rxc bytes and the two T bytes shall not be included in the interleaving process. Convolutional interleaving is applied by interleaving 5 lines of 55 bytes.

Following the scheme of Figure A.19, convolutional interleaving shall be applied to the error protected packets. The convolutional interleaving process shall be based on the Forney approach, which is compatible with the Ramsey type III approach, with $I = 5$. The Interleaved frame shall be composed of overlapping error protected packets and a group of 10 packets shall be delimited by the start of the SL-ESF.

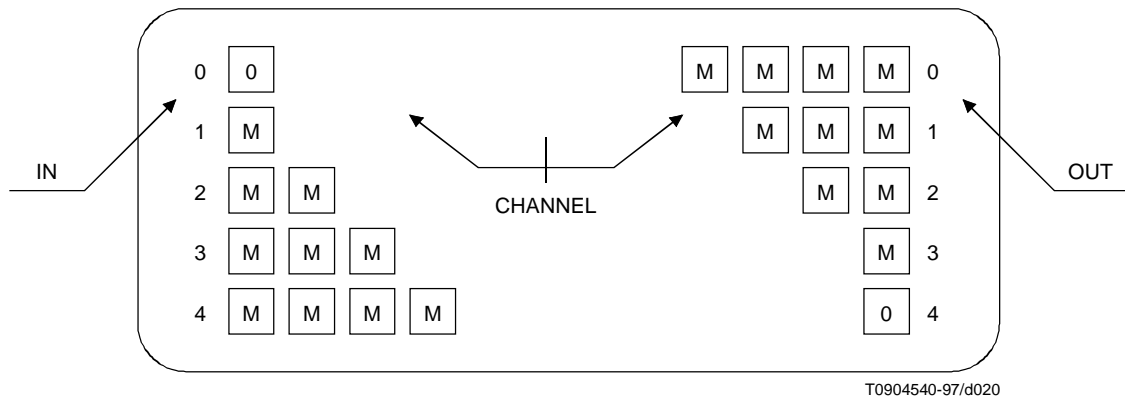

Figure A.19/J.112 – Interleaver and de-interleaver structures

The interleaver is composed of I branches, cyclically connected to the input byte-stream by the input switch. Each branch shall be a First In First Out (FIFO) shift register, with depth (M_j) cells (where $M = N/I$, $N = 55 =$ error protected frame length, $I =$ interleaving depth, $j =$ branch index). The input and output switches shall be synchronized. Each cell of the FIFO shall contain one byte.

For synchronization purposes, the first byte of each error protected packet shall be always routed into the branch "0" of the interleaver (corresponding to a null delay). The third byte of the SL-ESF payload (the byte immediately following R1b) shall be aligned to the first byte of an error protected packet.

The de-interleaver is similar, in principle, to the interleaver, but the branch indexes are reversed (i.e. branch 0 corresponds to the largest delay). The de-interleaver synchronization is achieved by routing the third data byte of the SL-ESF into the "0" branch.

Reception indicator fields and slot boundary fields

A downstream channel contains control information for each of its associated upstream channels. This information is contained within structures known as MAC Flags. A set of MAC Flags, represented by either 24 bits (denoted $b_0 \dots b_{23}$) or by 3 bytes (denoted R_{xa} , R_{xb} and R_{xc}), are uniquely assigned to a given upstream channel "x":

- $R_{xa} = \text{b0} \dots \text{b7} = (\text{msb} \dots \text{lsb});$
- $R_{xb} = \text{b8} \dots \text{b15} = (\text{msb} \dots \text{lsb});$
- $R_{xc} = \text{b16} \dots \text{b23} = (\text{msb} \dots \text{lsb}).$

These flags constitute the slot configuration information for the upstream channel "x" where "x" is indicated to the NIU in the «MAC Flag sets» given in MAC messages (Default Configuration message, Connect message, Reprovision message, Transmission Control message) and is described as follows:

The `MAC_Flag_Set` is a 5-bit field indicating the MAC Flag set number assigned to the channel (i.e. R1a, R1b and R1c represent MAC Flag set 1). It can take the values 1..16. Values 0 and 17..31 are invalid.

In the OOB downstream case, each SL-ESF frame structure contains eight sets of MAC Flags represented by R_{xa} , R_{xb} and R_{xc} , where x is replaced by the numbers 1..8. In the case of a 1.544 Mbit/s downstream bit rate, only one SL-ESF frame occurs during a 3 ms interval providing 8 sets of MAC Flags. In the case of a 3.088 Mbit/s downstream bit rate, two SL-ESF frames A and B occur during a 3-ms interval, providing 16 sets of MAC Flags. The second set of MAC Flags (contained in the second SL-ESF) are denoted by R_{xa} , R_{xb} and R_{xc} , where x is replaced by the numbers 9 through 16.

In the IB downstream case, the MAC Flags are contained in the MAC Control message structure which can contain as many as 16 MAC Flag sets. The MAC Flags 1-8 are contained in the "MAC Flags" field and the MAC Flags 9-16 are contained in the "Extension Flags" field.

In case of a 3.088 Mbit/s upstream channel, two sets of MAC Flags are required. In this case, the `MAC_Flag_Set` parameter represents the first of two successively assigned MAC Flag sets (R_{xa} - R_{xc} , R_{ya} - R_{yc} with $y = x + 1 \pmod 8$ (for 1.544 Mbit/s DS) or $y = x + 1 \pmod 16$ (for 3.088 Mbit/s DS)). In particular, if one downstream OOB 1.544 Mbit/s channel controls 3.088 Mbit/s upstream channels, at most 4 upstream channels can be controlled, due to the number of available MAC Flags.

The bits b_0 to b_{23} are defined as follows:

- b_0 = ranging slot indicator for next 3 ms period (msb)
- b_1 - b_6 = slot boundary definition field for next 3 ms period
- b_7 = slot 1 reception indicator (as shown in Table A.12)
- b_8 = slot 2 reception indicator (as shown in Table A.12)
- b_9 = slot 3 reception indicator (as shown in Table A.12)
- b_{10} = slot 4 reception indicator (as shown in Table A.12)
- b_{11} = slot 5 reception indicator (as shown in Table A.12)
- b_{12} = slot 6 reception indicator (as shown in Table A.12)
- b_{13} = slot 7 reception indicator (as shown in Table A.12)
- b_{14} = slot 8 reception indicator (as shown in Table A.12)
- b_{15} = slot 9 reception indicator (as shown in Table A.12)
- b_{16} - b_{17} = reservation control for next 3 ms period
- b_{18} - b_{23} = CRC-6 parity (see definition in SL-ESF section)

When the upstream data rate is 256 kbit/s, then only the first three slot reception indicators are valid. When the upstream data rate is 1.544 Mbit/s, then the 9 slots are valid. When the upstream data rate is 3.088 Mbit/s, the 9 slots of this field and the 9 slots of the following field are valid: two consecutive Slot Configuration fields are then used. The definition of the first Slot Configuration field is unchanged. The definition of the second Slot Configuration field extends the boundary definition to cover upstream slots 10 through 18, and the reception indicators to cover upstream slots 10 through 18.

In general, when the upstream rate is lower than the downstream rate, there are several OOB downstream superframes during groups of k upstream slots (where $k = 3$ for 256 kbit/s upstream, $k = 9$ for 1.544 Mbit/s upstream). In that case, configuration slots remain equal over all superframes corresponding to one group of k upstream slots.

Ranging slot indicator (b_0): When this bit is active ($b_0 = 1$), the first three slots of upstream channel " x " which correspond to the occurrence of the next superframe of the related downstream channel are designated as ranging slots. A ranging message may be transmitted in the second ranging slot "on contention", and the first and third ranging slots may not be used for transmission (guard band for ranging operations).

Slot Boundary Definition field (b1-b6): Slot types are assigned to upstream slots using bits b0-b6. The slots are grouped into regions among "spans" of 3 slots (256 kbit/s), 9 slots (1.544 Mbit/s), or 18 slots (3.088 Mbit/s), such that slots of a similar type are contained within the same region. The order of the regions is Ranging slot, Contention based slots, Reserved slots and Fixed rate based slots. If a ranging slot is available within a "span", it will consist of the first three slot times in the "span", assuming b1-b6 are not in the range 55-63 (see Table A.9). A ranging slot is indicated by b0 = 1. The boundaries between the remaining regions of the "spans" are defined by b1-b6. The boundaries are defined as shown in Table A.9.

Table A.9/J.112 – Slot Boundary Definition field (b1-b6)

Boundary 0	
Boundary 1	Slot 1
Boundary 2	Slot 2
Boundary 3	Slot 3
Boundary 4	Slot 4
Boundary 5	Slot 5
Boundary 6	Slot 6
Boundary 7	Slot 7
Boundary 8	Slot 8
Boundary 9	Slot 9

The boundary positions are defined by b1-b6 as shown in Table A.10.

Table A.10/J.112 – Boundary positions (b1-b6)

(Note 1) (Note 2)	0	1	2	3	4	5	6	7	8	9
0 (Note 3)	0	1	2	3	4	5	6	7	8	9
1 (Note 3)		10	11	12	13	14	15	16	17	18
2 (Note 3)			19	20	21	22	23	24	25	26
3				27	28	29	30	31	32	33
4					34	35	36	37	38	39
5						40	41	42	43	44
6							45	46	47	48
7								49	50	51
8									52	53
9										54

Example: b0 = 0, b1-b6 = 22: Contention (1-2), reserved (3-5), Fixed rate (6-9).
 NOTE 1 – Row = Contention based / Reserved region boundary.
 NOTE 2 – Column = Reserved packet /Fixed rate based region boundary.
 NOTE 3 – When the ranging control slot indicator (b0) is set to "1", the values in rows 0-2 are illegal values, and values in row 3 means that there are no contention slots, because slots 1-3 are defined as ranging control slots.

The remaining values of the Slot Boundary Definition field are provided in Table A.11.

Table A.11/J.112 – Slot Boundary Definition field

b1-b6 value	Ranging control slots	Contention slots	Reservation slots	Fixed rate slots
55	1-6	7-9	–	–
56	1-6	7-8	–	9
57	1-6	7	8-9	–
58	1-6	7	8	9
59	1-6	7	–	8-9
60	1-6	–	7-8	9
61	1-6	–	7	8-9
62	1-6	–	–	7-9
63	1-9	–	–	–

NOTE 1 – For b1-b6 = 55-63, b0 must be set to 1. Note that for b1-b6 between 55 and 62, two ranging slots are provided (2 and 5). For b1-b6 = 63, three ranging slots are provided (2, 5, and 8).

The values in the above tables are derived from b1-b6 in the following manner:

$$b1 + (b2 \times 2) + (b3 \times 4) + (b4 \times 8) + (b5 \times 16) + (b6 \times 32)$$

Warning: This formula indicates that b6 is considered as msb of b1-b6 word, whereas b0 is msb of the entire word b0-b23. Although this "looks" inconsistent, it has not been changed for the purpose of compatibility with the DAVIC standard.

When the upstream data channel is a 256 kbit/s data channel, then only the first four rows and columns of Table A.10 are valid, and Table A.11 is not valid.

NOTE 2 – If slot boundary fields change while some NIUs have already been affected slots in the reservation slots area, these NIUs are responsible of updating the list of physical slots. Specifically, slots are assigned by MAC Reservation Grant messages, which contain a Reference slot that does not depend on the slot boundary fields and a Grant_slot_count which corresponds to the number of slots assigned within the reservation slots boundary field. If the field changes, the list of physical slots on which the NIU can transmit automatically changes accordingly.

Slot reception indicators (b7-b15): When a slot reception indicator is active ("1"), this indicates that a cell was received without collision. The relationship between a given US slot and its indicator is shown in Table A.11. When the indicator is inactive ("0"), this indicates that either a collision was detected or no cell was received in the corresponding upstream slot.

Slot reception indicators lead to the retransmission procedure only when contention access is used as described in A.5.5.2.4.

Reservation Control (b16-b17): When the reservation control field has the value of 0, no reservation attempts are allowed to be transmitted on the corresponding QPSK upstream channel during the slot positions associated with the next 3 ms period. When the Reservation Control field has the value of 1, reservation attempts can be made. The values 2 and 3 are reserved. A reservation attempt corresponds to sending a MAC Reservation Request message (see MAC section). b16 is msb.

Table A.12/J.112 – Relationship of US slot to DA indicator at the INA

	1.544 Mbit/s downstream	3.088 Mbit/s downstream
256 kbit/s upstream		
1.554 Mbit/s upstream		
3.088 Mbit/s upstream		
<p>NOTE 1 – 'I' indicates the downstream frame(s) in which indicators (contained within the MAC Flag Sets) are sent. These indicators control the upstream slots in the shaded area.</p> <p>NOTE 2 – In the 3.088 downstream, two successive frames contain MAC Flag Sets 1..16. Two successive MAC Flag Sets are used to control the 18 slots of a 3.088 upstream channel.</p> <p>NOTE 3 – This table refers to the position of US slots with respect to the positions of DS superframes at the INA receiver. NIUs should have their Time_Offset_Value of transmission set such that this table applies.</p>		

T0904550-97/d021

CRC-6 Parity (b18-b23): This field contain a CRC-6 parity value calculated over the previous 18 bits. The CRC-6 parity value is described in the SL-ESF frame format section. b18 is msb.

In the case where there is more than one OOB DS QPSK channel related to an upstream QPSK channel, the SL-ESF overhead bits and the payload R-bytes shall be identical in those OOB DS channels, with the exception of the overhead CRC (C1-C6) bits, which are specific to each of those OOB DS channels. Such related DS channels shall be synchronized (transmitted synchronously). This scenario applies for example when a lot more bandwidth is needed for DS information than for US information.

The MAC messages that are required to perform the MAC functions for the upstream channel shall be transmitted on each of its related OOB DS channels.

Trailer bytes

These bytes are not used. They are equal to 0.

A.5.3.2 Forward Interaction path (downstream IB)

The structure that is utilized when the downstream QAM channel is carrying MPEG-2 TS packets is shown in Figure A.20. MSBs of each field are transmitted first.

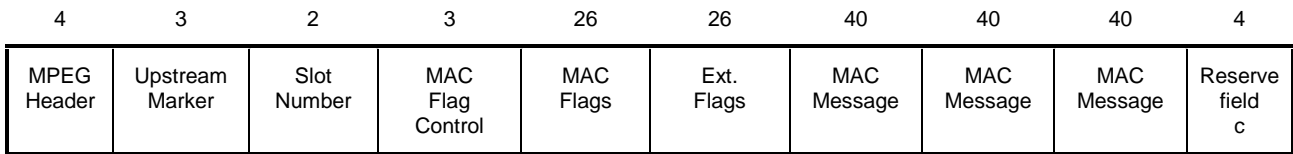

Figure A.20/J.112 – Frame structure (MPEG-2 TS format)

where:

MPEG Header is the 4-byte MPEG-2 Transport Stream Header as defined in ISO 13818-1 with a specific PID designated for MAC messages. This PID is to be specified by ETS 300 468, either within the PMT, PAT tables or as a default specific value (when MAC is considered as a SI section).

Upstream Marker is a 24-bit field which provides upstream QPSK synchronization information. (As mentioned in A.5.1.4, at least one packet with synchronization information must be sent in every period of 3 ms.) The definition of the field is as follows:

bit 0: upstream marker enable (msb)

When this field has the value '1', the slot marker pointer is valid. When this field has the value '0', the slot marker pointer is not valid.

bit 1-7: reserved

bit 8-23: upstream slot marker pointer (bit 23 MSB)

The slot marker pointer is a 16-bit unsigned integer which indicates the number of "symbol" clocks between the first symbol of the next Sync byte and the next 3 ms marker.

Slot Number is a 16-bit field which is defined as follows: (As mentioned in A.5.1.4, at least one packet with synchronization information must be sent in every period of 3 ms).

bit 0: slot position register enable (msb)

When this field has the value '1', the slot position register is valid. When this field has the value '0', the slot position register is not valid.

bit 1-3: reserved

bit 4 is set to the value '1'. This bit is equivalent to M12 in the case of OOB downstream.

bit 5: odd parity

This bit provides odd parity for upstream slot position register. This bit is equivalent to M11 in the case of OOB downstream.

bits 6-15: upstream slot position register

The upstream slot position register is a 10 bit counter which counts from 0 to n with bit 6 the msb. These bits are equivalent to M10-M1 in the case of OOB downstream.

(See A.5.4 for more information on the functionality of the upstream slot position register.)

MAC Flag Control is a 24-bit field (b0, b1, b2...b23) which provides control information which is used in conjunction with the MAC Flags and Extension Flags. The definition of the MAC Flag Control field is as follows:

- b0-b2 = channel 1 flag field control
- b3-b5 = channel 2 flag field control
- b6-b8 = channel 3 flag field control
- b9-b11 = channel 4 flag field control
- b12-b14 = channel 5 flag field control
- b15-b17 = channel 6 flag field control
- b18-b20 = channel 7 flag field control
- b21-b23 = channel 8 flag field control

Each of the above channel "x" flag field control fields are defined as follows:

channel x flag control (a,b,c) = (bx, bx + 1, bx + 2)

bit a: 0 – channel x flag field disabled

1 – channel x flag field enabled

bit b,c: 00 – all flags valid for second previous 3-ms period (out-of-band signalling equivalent)

01 – flags valid for 1st ms of previous 3-ms period

10 – flags valid for 2nd ms of previous 3-ms period

11 – flags valid for 3rd ms of previous 3-ms period

MAC Flags

MAC Flags is a 26 byte field containing 8 slot configuration fields (24 bits each) which contain slot configuration information for the related upstream channels followed by two reserved bytes (first 3 bytes correspond to channel 1, second 3 bytes to channel 2, etc.). The definition of each slot configuration field is defined as follows:

b0 = ranging control slot indicator for next 3-ms period (msb)

b1-b6 = slot boundary definition field for next 3-ms period

b7 = slot 1 reception indicator for [second] previous 3-ms period

b8 = slot 2 reception indicator for [second] previous 3-ms period

b9 = slot 3 reception indicator for [second] previous 3-ms period

b10 = slot 4 reception indicator for [second] previous 3-ms period

b11 = slot 5 reception indicator for [second] previous 3-ms period

b12 = slot 6 reception indicator for [second] previous 3-ms period

b13 = slot 7 reception indicator for [second] previous 3-ms period

b14 = slot 8 reception indicator for [second] previous 3-ms period

b15 = slot 9 reception indicator for [second] previous 3-ms period

b16-b17 = reservation control for next 3 ms period

b18-b23 = CRC-6 parity

The slot configuration fields are used in conjunction with the MAC Flag Control field defined above. Note that when the MAC Flag Control field designates that a 1 ms flag update is enabled:

- 1) the reception indicators refer to the previous 3-ms period (the bracketed term [second] is omitted from the definition);
- 2) only the reception indicators which relate to slots which occur during the designated 1-ms period are valid; and
- 3) the ranging control slot indicator, slot boundary definition field, and reservation control field are valid and consistent during each 3-ms period.

Extension Flags

Extension Flags is a 26-byte field which is used when one or more 3.088 Mbit/s upstream QPSK links are used. The definition of the Extension Flags field is identical to the definition of the MAC Flags field above.

When 3.088 Mbit/s QPSK upstream links are used, each 3.088 Mbit/s upstream channel utilizes two consecutive qpsk_slot_configuration fields. The definition of the first slot configuration field is unchanged. The definition of the second slot configuration field extends the boundary definition to slots 10 through 18, and the reception indicators cover slots 10 through 18.

MAC Message

The MAC Message field contains a 40-byte message, the general format defined in A.5.5.

reserve field c is a 4-byte field reserved for future use.

A.5.3.3 Return Interaction path (upstream)

A.5.3.3.1 Slot format

The format of the upstream slot is shown in Figure A.21 below. A Unique Word (UW) (4 bytes) provides a burst mode acquisition method. The payload area (53 bytes) contains a single message cell. The RS Parity field (6 bytes) provides $t = 3$ Reed-Solomon protection RS (59,53) over the payload area. The Guard band (1 byte) provides spacing between adjacent packets.

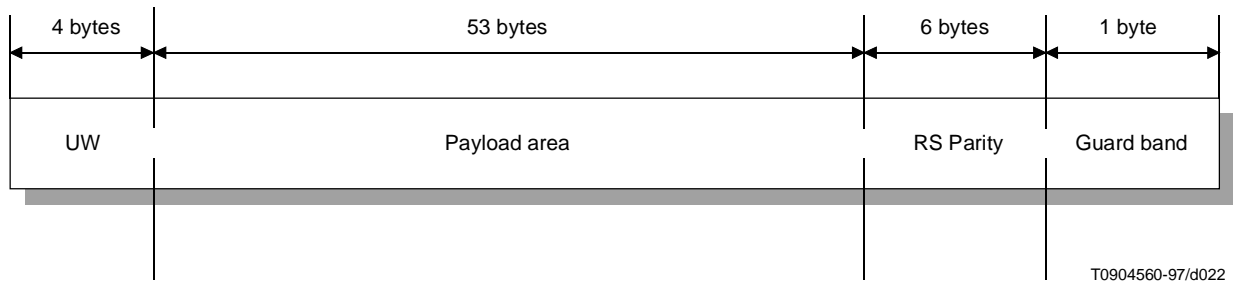

Figure A.21/J.112 – Slot format

The structure and field coding of the message cell shall be consistent with the structure and coding given in Recommendation I.361 for ATM UNI.

Unique word

The unique word is four bytes long: CC CC CC 0D hex.

ATM cell structure

The format for each ATM cell structure is illustrated in Figure A.22. This structure and field coding shall be consistent with the structure and coding given in Recommendation I.361 for ATM UNI.

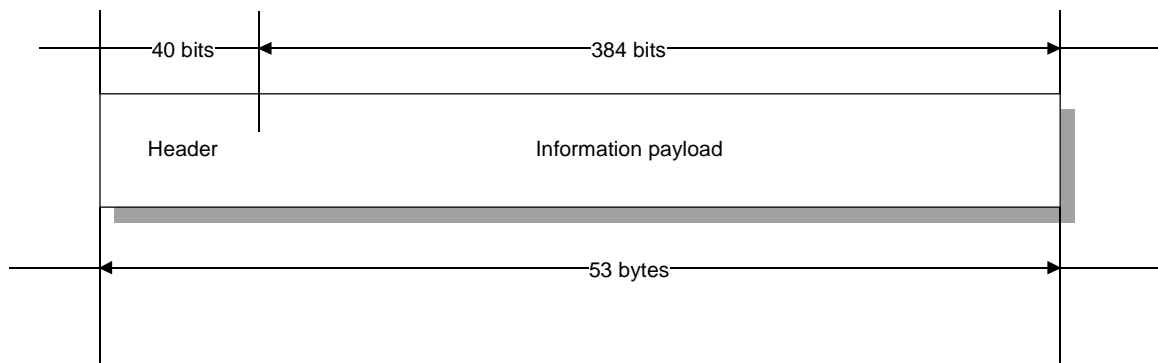

Figure A.22/J.112 – ATM cell format

Channel coding

Reed-Solomon encoding shall be performed on each ATM cell with $T = 3$. This means that 3 erroneous byte per ATM cell can be corrected. This process adds 6 parity bytes to the ATM cell to give a codeword of (59,53). The shortened Reed-Solomon Code shall be implemented by appending 196 bytes, all set to zero, before the information bytes at the input of a (255,249) encoder; after the coding procedure these bytes are discarded.

The Reed-Solomon code shall have the following generator polynomials:

- Code Generator Polynomial: $g(x) = (x + \mu^0) (x + \mu^1) (x + \mu^2) \dots (x + \mu^5)$
where $\mu = 02$ hex
- Field Generator Polynomial: $p(x) = x^8 + x^4 + x^3 + x^2 + 1$

Guard band

The guard band is 1 byte long (4 QPSK symbols). It provides some extra protection against synchronization errors.

A.5.4 Slot timing assignment

A.5.4.1 Downstream slot position reference (downstream OOB)

Upstream synchronization is derived from the downstream extended superframe (OOB) by noting the slot positions as shown in Table A.13.

Table A.13/J.112 – Downstream slot position reference

Frame number	Bit number	Overhead bit	Slot position reference
1	0	M1	◆ Slot position ^{a)}
2	193	C1	
3	386	M2	
4	579	F1 = 0	
5	772	M3	
6	965	C2	
7	1158	M4	
8	1351	F2 = 0	
9	1544	M5	◆ Slot position
10	1737	C3	
11	1930	M6	
12	2123	F3 = 1	
13	2316	M7	
14	2509	C4	
15	2702	M8	
16	2895	F4 = 0	
17	3088	M9	◆ Slot Position
18	3281	C5	
19	3474	M10	
20	3667	F5 = 1	
21	3860	M11	
22	4053	C6	
23	4246	M12	
24	4439	F6 = 1	

^{a)} The first slot position is also called the 3-ms time marker in the case of 1.544 Mbit/s rate downstream. For the 3.088 Mbit/s rate downstream, the 3-ms time marker only appears once every two superframes. The M12 bit (see A.5.4) is used to differentiate between the two superframes.

A.5.4.2 Downstream slot position reference (downstream IB)

Upstream synchronization is derived from the downstream extended superframe (IB) by noting the 3-ms time Marker Downstream as shown in Figure A.23. From the bits of the Upstream Marker field contained in the MPEG-2 TS packet, the 3-ms time marker is obtained by counting a number of symbol clocks equal to (b23-b8). This marker is equivalent to the first slot position of the superframe for the OOB case.

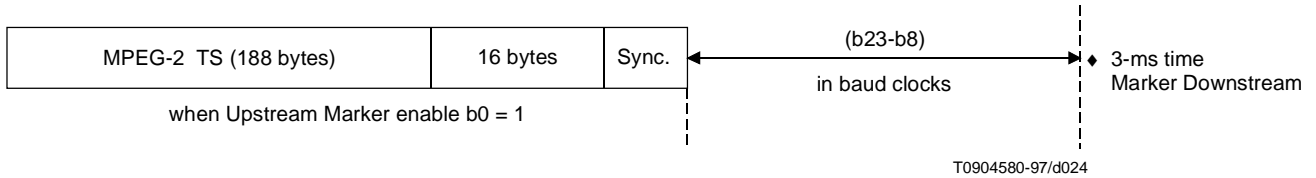

Figure A.23/J.112 – Position of the 3-ms time marker for IB signalling

In order to describe how the US slot position is derived from the location of the DS 3-ms time marker at the NIU, consider the system diagrams in Figure A.24.

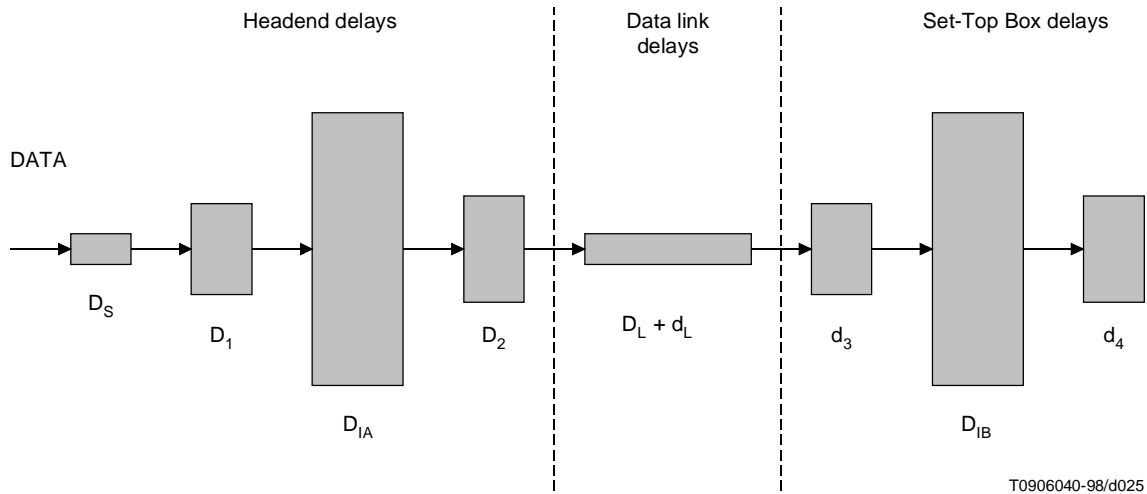

Figure A.24/J.112 – System model for timing analysis

The delay between the location of the end of the Upstream Marker and the beginning of the next Sync byte, designated as D_s , is a constant value for each bit rate equal to the equivalent time of 197 bytes, or:

$$(197 * 8 / x) \text{ symbol clocks}$$

where:

- x = 4, for 16 QAM
- 5, for 32-QAM
- 6, for 64 QAM
- 7, for 128-QAM
- 8, for 256 QAM

There will be some processing delay in the Headend hardware between the location where the Upstream Marker is inserted in the MAC packet and the arrival of the data into the interleaver. This should be a constant delay, D_1 , which is the same for every incoming byte, including the sync byte following the Upstream Marker.

The delay due to the interleaving process in the Headend is D_{IA} and will be zero for each sync byte.

There will be some processing delay in the Headend hardware between the output of the interleaver and the output of the QAM modulator. This should be a constant delay, D_2 , for every byte in the outgoing stream.

The data link is composed of two delay values, D_L , the constant link delay that every STU experiences, and d_L , the variable link delay for each STU which is due to the fact that each STU is located at a different distance from the Headend. This variable link delay is compensated for by the ranging operation.

There will be some processing delay in the STU hardware between the input of the QAM demodulator and the input of the de-interleaver. This delay is design dependent, d_3 , and may be a constant delay or a variable delay for each byte in the data stream.

The delay due to the de-interleaving process in the STU is D_{IB} , and will be equal to the entire interleave delay for each sync byte.

The total interleave delay:

$$D_I = D_{IA} + D_{IB}$$

will be constant for each byte. The value will be given by:

$$D_I = 204 * 8 * (\text{interleave_depth}-1) / \text{bit rate}$$

For example, if the modulation is QAM 64 with a baud rate of 5.0 Mbit/s:

$$D_I = 204 * 8 * 11/30M = 598.4 \text{ microseconds or } 2992 \text{ symbol clocks}$$

There will be some processing delay in the STU hardware between the output of the de-interleaver and the circuitry that utilizes the Upstream Marker and following sync byte for generating the local 3-ms marker. This delay, which includes Reed-Solomon FEC, is design dependent, d_4 , and may be a constant delay or a variable delay for each byte in the data stream.

The accumulated delay in the data link is composed of a number of constant terms and three variable terms. The constant terms will be identical for every STU that is utilizing a particular QAM channel for in-band timing and thus becomes a fixed offset between when the counter which is loading the Upstream Marker value and the actual location of the 3-ms marker at each STU. Each STU is responsible for compensating for the design dependent delays, d_3 and d_4 , before utilizing the Upstream Marker value for generating the 3-ms marker. The variable link delay, d_L , will be compensated for via the ranging algorithm, in the same way as performed when out-of-band signalling is employed.

A.5.4.3 Upstream slot positions

Transmission on each QPSK upstream channel is based on dividing access by multiple NIU units by utilizing a negotiated bandwidth allocation slot access method. A slotting methodology allows the transmit slot locations to be synchronized to a common slot position reference, which is provided via the related downstream MAC control channel. Synchronizing the slot locations increases message throughput of the upstream channels since the ATM cells do not overlap during transmission.

The slot position reference for upstream slot locations is received via the related downstream MAC control channel by each NIU. Since each NIU receives the downstream slot position reference at a slightly different time, due to propagation delay in the transmission network, slot position ranging is required to align the actual slot locations for each related upstream channel. The upstream slot rates are 6000 upstream slots/s when the upstream data rate is 3088 Mbit/s, 3000 upstream slots/s when the upstream data rate is 1.544 Mbit/s and 500 upstream slots/s when the upstream data rate is 256 kbit/s.

The number of slots available in any one second is given by:

$$\text{number of slots/s} = \text{upstream data rate} / 512 + (\text{extra guardband})$$

where extra guardband may be designated between groups of slots for alignment purposes.

The Mbits in the SL-ESF serve two purposes:

- to mark the slot positions for the upstream Contention based and Contentionless based signalling links (see A.5.4);
- to provide slot count information for upstream message bandwidth allocation management in the NIU.

Mbits M1, M5, and M9 mark the start of an upstream slot position for upstream message transmission.

A.5.4.3.1 Rate 256 kbit/s

In the case where the upstream data rate is 256 kbit/s and the downstream OOB rate is 1.544 Mbit/s, the upstream slots are numbered as follows:

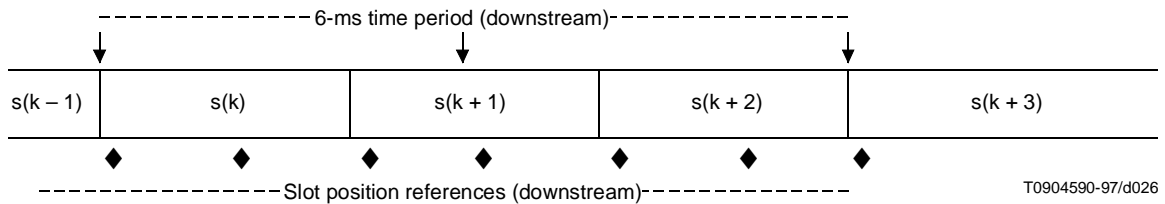

where k is a multiple of 3. In the case where the downstream OOB rate is 3.088 Mbit/s, there are 12 slot position references downstream during the transmission of 3 upstream packets. In the case of IB downstream, packet "k" is sent when the 3-ms time marker is received.

The relationship between the received slot position reference and the actual slot transmit position is given by:

$$\text{slot_transmit_position} = \text{slot_position_reference (integer)} + \text{slot_position_offset}$$

where only the slot_position_references corresponding to integer values are valid and the slot_position_offset is derived from the Time_Offset_Value provided via the Range_and_Power_Calibration_Message in the MAC protocol.

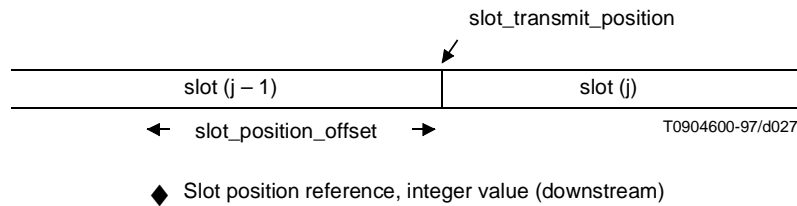

In the case where the upstream data rate is 256 kbit/s, the actual slot transmission locations correspond directly to the integer valued slot position references.

A.5.4.3.2 Rate 1.544 Mbit/s

In the case where the upstream data rate is 1.544 Mbit/s and the downstream OOB rate is 1.544 Mbit/s, the upstream slots are numbered as follows:

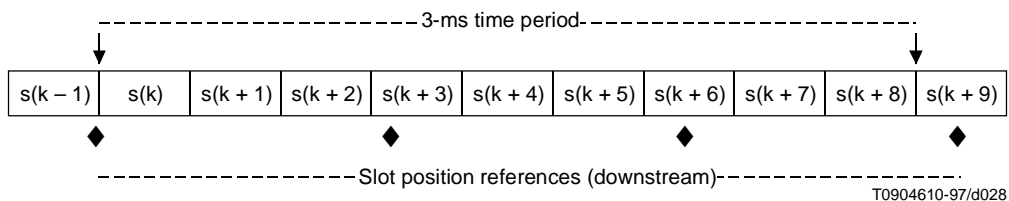

where k is a multiple of 9. In the case where the downstream OOB rate is 3.088 Mbit/s, there are 6 slot position references downstream during the transmission of 9 upstream packets. In the case of IB downstream, packet "k" is sent when the 3-ms time marker is received.

The relationship between the received slot position reference and the actual slot transmit position is given by:

$$\text{slot_transmit_position} = \text{slot_position_reference} + \text{slot_position_offset}$$

where $\text{slot_position_offset}$ is derived from the Time_Offset_Value provided via the $\text{Range_and_Power_Calibration_Message}$ in the MAC protocol.

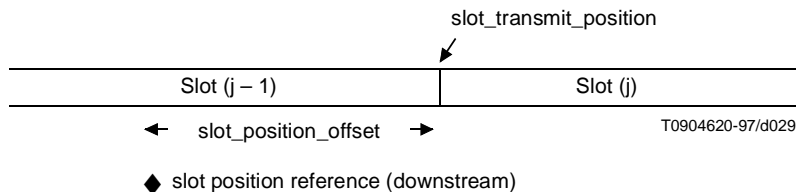

In the case where the upstream data rate is 1.544 Mbit/s, the actual slot transmission locations are given by:

$$\text{slot_transmission_location} (m) = \text{slot_transmit_position} + (m \times 512)$$

where $m = 0,1,2$ is the position of the slot with respect to the $\text{slot_transmit_position}$. This leaves a free time interval (FI = 8 bits) before the next $\text{slot_transmit_position}$ occurs, during which no NIU transmits anything.

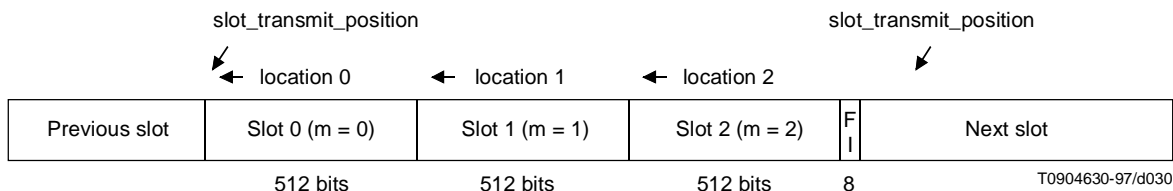

A.5.4.3.3 Rate 3.088 Mbit/s

In the case where the upstream data rate is 3.088 Mbit/s and the downstream OOB rate is 1.544 Mbit/s, the upstream slots are numbered as shown below, where k is a multiple of 18.

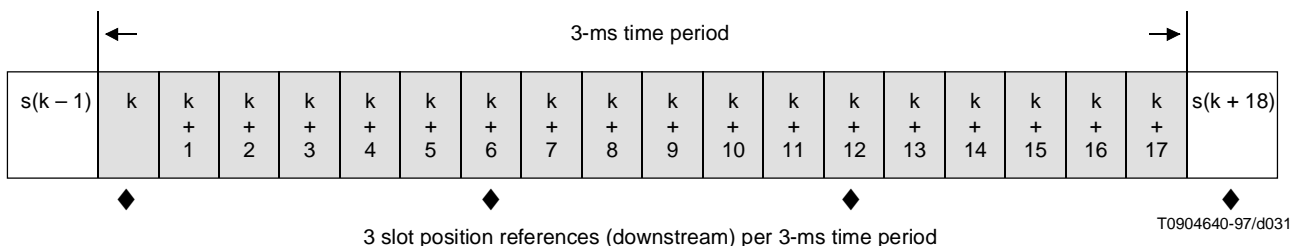

In the case where the downstream OOB rate is 3.088 Mbit/s, there are 6 slot position references downstream during the transmission of 18 upstream packets. In the case of IB downstream, packet "k" is sent when the 3-ms time marker is received.

The relationship between the received slot position reference and the actual slot transmit position is given by:

$$\text{slot_transmit_position} = \text{slot_position_reference} + \text{slot_position_offset}$$

where slot_position_offset is derived from the Time_Offset_Value provided via the Range_and_Power_Calibration_Message.

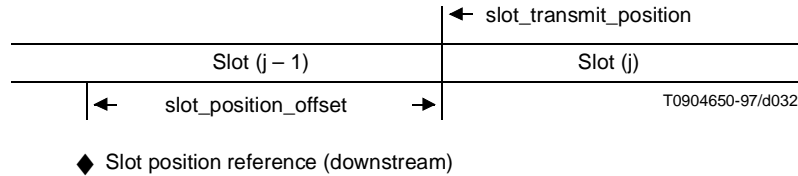

In the case where the upstream data rate is 3.088 Mbit/s, the actual slot transmission locations are given by:

$$\text{slot_transmission_location (m)} = \text{slot_transmit_position} + (m * 512)$$

where; m = 0,1,2,3,4,5 is the position of the slot with respect to the slot_transmit_position. This leaves a free time interval (FI = 16 bits) before the next slot_transmit_position occurs, during which no NIU transmits anything.

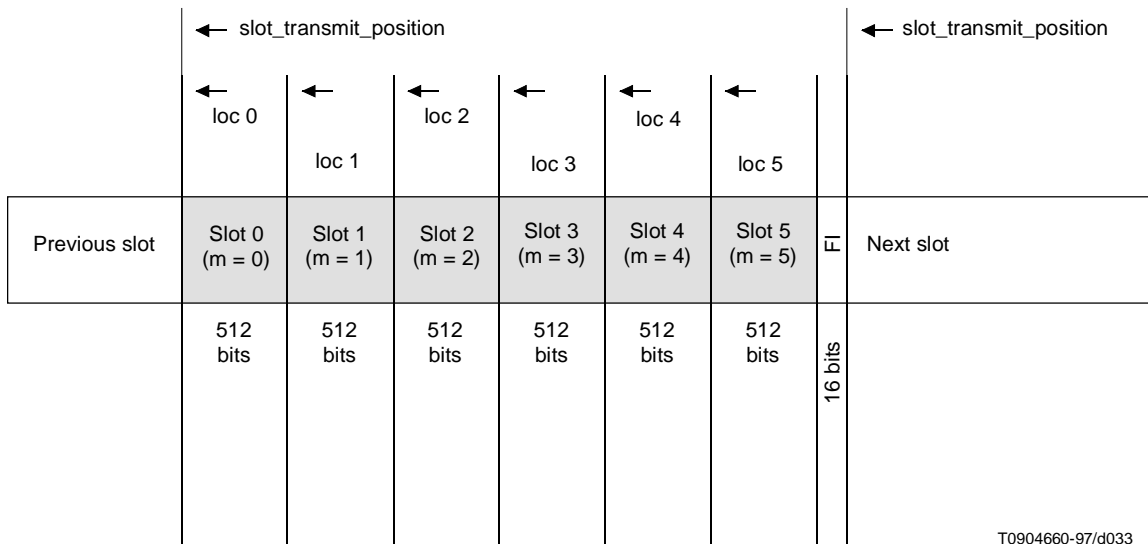

A.5.4.4 Slot position counter

Think of Mbits M10-M1 as a register (ESF counter), which counts from 0 to N, incrementing by one every 3-ms, where N an integer which indicates slot position cycle size (The value of N is calculated from Service_Channel_Last_Slot sent in the MAC Default Configuration Message and the upstream bit rate of the service channel. For the case of a 256 kbit/s service channel, the maximum value of Service_Channel_Last_Slot is 1535.). The upstream slot position register indicates the upstream slot positions that will correspond to the next SL-ESF frame. Upstream slot positions are counted from 0 to N. There are 6 upstream slots per ms when the upstream data rate is 3.088 Mbit/s, 3 upstream slots per ms when the upstream data rate is 1.544 Mbit/s, and there is 0.5 upstream slot per ms when the upstream data rate is 256 kbit/s. The corresponding upstream slot rates are, therefore, 6000 upstream slots/s

when the upstream data rate is 3.088 Mbit/s, 3000 upstream slots/s when the upstream data rate is 1.544 Mbit/s, and 500 upstream slots/s when the upstream data rate is 256 kbit/s. The algorithm to determine the upstream slot position counter value is given below:

```

if (downstream_rate == 3.088 Mbit/s) {n = 1;}
else      {n = 0;}

upstream_slot_position_register = value of Mbits latched at bit_position M11 (M10-M1)

if (upstream_rate == 1.544 Mbit/s)      {m = 3;}
else if (upstream_rate == 3.088 Mbit/s)  {m = 6;}
      else                               {m = 0.5}

if ( bit_position == M1 and previous M12 == 1)
      { upstream_slot_position_counter = upstream_slot_position_register * 3 * m; }

if ( bit_position == M5)
      if ( (n = 0) or (n == 1 and previous M12 == 0) )
            { upstream_slot_position_counter = upstream_slot_position_counter + m; }

if (bit_position == M9)
      if ( (n = 0) or (n = 1 and previous M12 == 1) )
            { upstream_slot_position_counter = upstream_slot_position_counter + m; }

if (bit_position == M11)
      { temp_upstream_slot_position_register = (M10, M9, M8, ..., M1); }

if (bit_position == M12 and M12 == 1)
      {upstream_slot_position_register = temp_upstream_slot_position_register;}

```

where the Mbits will be defined as follows:

- M1-M10 = 10-bit ESF counter which counts from 0 to n with M10 the Most Significant Bit (MSB);
- M11 = odd parity for the ESF counter, i.e. M11 = 1 if the ESF_value (M1-M10) has an even number of bits set to 1;
- M12 = 1: ESF counter valid;
0: ESF counter not valid.

The values assigned to M12 are as follows:

- 1) When the QPSK downstream channel bit rate is 1.544 Mbit/s, the M12 bit, is always set to the value '1'.
- 2) When the QPSK downstream channel bit rate is 3.088 Mbit/s, the information is always transmitted in pairs of superframe, where superframe-A is the first superframe in the pair, and superframe-B is the second superframe in the pair. In this case, the M12 bit of superframe-A is set to the value '0' and the M12 bit of superframe-B is set to the value '1'.
- 3) When the downstream channel is IB, M12 = 1.

A.5.5 MAC functionality

A.5.5.1 MAC reference model

The scope of this subclause is limited to the definition and specification of the MAC layer protocol. The detailed operations within the MAC layer are hidden from the above layers.

This subclause focuses on the required message flows between the INA and the NIU for Media Access Control. These areas are divided into four categories: Initialization, Provisioning and Sign-on Management, Connection Management and Link Management (see Figure A.25).

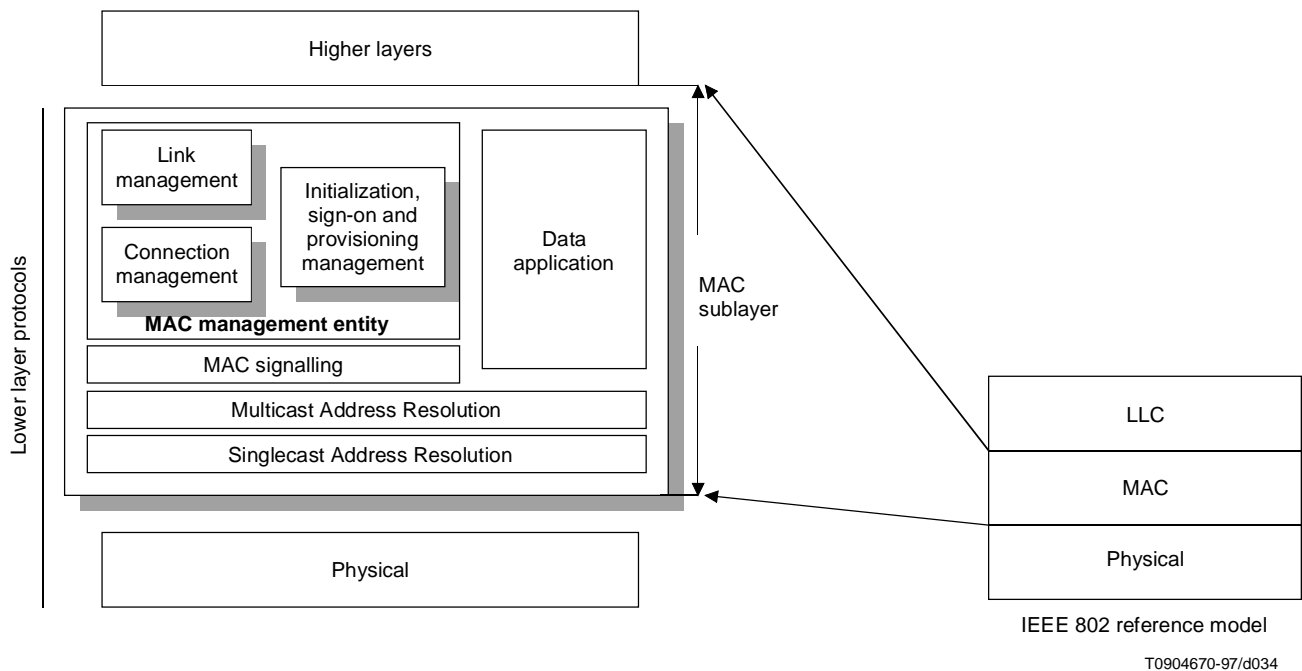

Figure A.25/J.112 – MAC reference model

A.5.5.2 MAC concept

A.5.5.2.1 Relationship between higher layers and MAC protocol

The goal of the MAC protocol is to provide tools for higher layer protocols in order to transmit and receive data transparently and independently of the physical layer. Higher layer services are provided by the INA to the STU. The INA is thus responsible of indicating the transmission mode and rate to the MAC layer for each type of service.

Specifically, for each connection provided by higher layers on the INA side (VPI/VCI), a connection ID is associated at the MAC layer. The maximum number of simultaneous connections that a NIU should support is defined as follows:

- Grade A: Only one connection at a time can be handled by a NIU.
- Grade B: As many connections as needed, defined dynamically by the INA, following higher layers requests. Note that in this case, all connections should be assigned to the same frequency upstream and downstream for implementation reasons.

Note however, that bandwidth (time slots) does not need to be assigned immediately by the INA for a given connection. This means that a connection ID may exist at the NIU side without associated slot numbers.

The INA is responsible for providing transmission bandwidth to the NIUs when needed by higher layers. However, since the NIU must transmit all data from the STU, the NIU is also responsible for requesting for more bandwidth if not already provided by the INA.

A default connection is initiated by the INA when STBs are first turned on. This connection can be used to send data from higher layers leading to further interactive connections. Note that this connection can be associated to a zero transmission rate (no initial bandwidth allocation).

A.5.5.2.2 Relationship between physical layer and MAC protocol

Up to 8 QPSK upstream channels can be related to each downstream channel which is designated as a MAC control channel. An example of frequency allocation is shown in Figure A.26. This relationship consists of the following items:

- 1) Each of these related upstream channels share a common slot position. This reference is based on 1 ms time markers that are derived via information transmitted via the downstream MAC control channel.
- 2) Each of these related upstream channels derive slot numbers from information provided in the downstream MAC control channel.
- 3) The Messaging needed to perform MAC functions for each of these related upstream channels is transmitted via the downstream MAC control channel.

The Media Access Control Protocol supports multiple downstream channels. In instances where multiple channels are used, the INA shall specify a single OOB frequency called the Provisioning Channel, where NIU's perform Initialization and Provisioning functions. If both 1.544 Mbit/s and 3.088 Mbit/s downstream OOB channels coexist on the network, there should be one Provisioning Channel with each rate. Also, in networks where IB NIUs exist, provisioning should be included in at least one IB channel. An aperiodic message is sent on each downstream control channel which points to the downstream Provisioning Channel. In instances where only a single frequency is in use, the INA shall utilize that frequency for Initialization and Provisioning functions.

The Media Access Control protocol supports multiple upstream channels. One of the upstream channels shall be designated the Service Channel. The Service Channel shall be used by NIU's entering the network via the Initialization and Provisioning procedure. The remaining upstream channels shall be used for upstream data transmission. In cases where only one upstream channel is utilized, the functions of the Service Channel shall reside in conjunction with regular upstream data transmission (see Figure A.26).

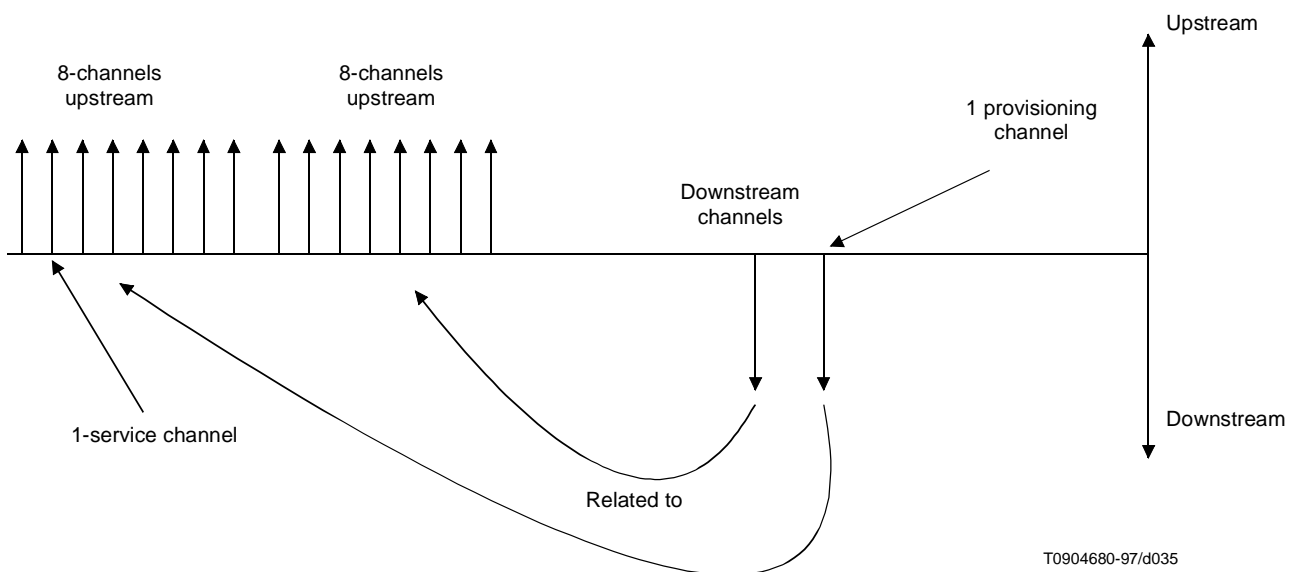

Figure A.26/J.112 – Example of frequency allocation

A.5.5.2.3 Relationship between physical layer slot position counter and MAC slot assignment

M10-M1 is a 10-bit superframe counter at the INA side, whereas the upstream slot position counter is an upstream slot counter at the NIUs side. The NIU slot position counter ($M10-M1 \times 3 \times m$, where $m = 0.5$ for 256 kbit/s, $m = 3$ for 1.544 Mbit/s and $m = 6$ for 3.088 Mbit/s) may be implemented as a 16-bit counter which is compared to the 16-bit slot numbers assigned by the INA in MAC messages (list assignment). When the counter value equals any assigned value, the NIU is allowed to send a packet upstream.

A.5.5.2.4 Access modes (Contention/Ranging/Fixed rate/Reservation)

Different access modes are provided to the NIUs within access regions specified by information contained in the slot boundary fields of the downstream superframes. The limits between access regions allow users to know when to send data on contention without risks of collision with contentionless type data. Also, the separation between reservation and fixed rate regions provides two ways of assigning slots to NIUs. The following rules define how to select access modes:

- *Data connections:*

When the INA assigns a connection ID to the NIU, it either specifies a slot list to be used (Fixed rate access) or the NIU shall use contention or reserved access by following this algorithm:

- When the NIU must send more cells than what was assigned by the INA, it can use contention access only if the number of cells to transmit is less than `Maximum_contention_access_message_length` (specified in the MAC Connect Message from the INA). In that case, it must wait for the slot reception indicator before it is allowed to send other cells with the same VPI/VCI value. The NIU can send one request for reservation access if the number of cells is less than `Maximum_reservation_access_message_length` (specified in the MAC Connect Message from the INA). If more cells must be transmitted, the NIU must send multiple requests for reservation access.

- *MAC messages:*

MAC messages can be sent on contention access or reservation access. MAC messages sent upstream must be less than 40 bytes long. If the MAC information exceeds 40 bytes, it must be segmented into multiple 40-bytes independent MAC messages. Ranging access can only be used for specific MAC messages.

Note that the VPI/VCI = 0/21 connection used for MAC messages is always set up, so the INA does not assign a particular connection ID which is normally used for reservation requests. Thus, in order to use reservation access, slots assigned for other connections may be used for MAC messages:

- a) *Contention Access*

`Contention Access` indicates that data (MAC or bursty data traffic) is sent in the slots assigned to the contention access region in the upstream channel. It can be used either to send MAC messages or data. The VPI, VCI of the ATM cells are then used to determine the type and direction of the data in higher layers. Contention based access provides instant channel allocation for the NIU.

The Contention based technique is used for multiple subscribers that will have equal access to the signalling channel. It is probable that simultaneous transmissions will occur. For each ATM cell transmitted by the NIU, a positive acknowledgement is sent back by the INA, utilizing the reception indicator field, for each successfully received ATM cell. In contention based access mode, a positive acknowledgement indicates that a collision did not occur. A collision occurs if two or more NIUs attempt ATM cell transmission during the same slot. A collision will be assumed if a NIU does not receive a positive acknowledgement. If a collision occurs, then the NIU will retransmit using a procedure to be defined.

For all the traffic sent contention access, a collision is assumed if the appropriate reception indicator of the slot used for transmission is not set. A counter at the NIU/STB records the number, denoted by `backoff_exponent`, of collisions encountered by a cell. The `backoff_exponent` counter starts from a value determined by the `Min_Backoff_Exponent` variable. The `backoff_exponent` is used to generate a uniform random number between 1 and $2^{\text{backoff_exponent}}$. This random number is used to schedule retransmission of the collided cell. In particular, the random number indicates the number of contention access slots the NIU/STB shall wait before it transmits. The first transmission is carried out in a random cell within the contention based access region. If the counter reaches the maximum number, determined by the `Max_Backoff_Exponent` variable, the value of the counter remains at this value regardless of the number of subsequent collisions. After a successful transmission, the `backoff_exponent` counter is reset to a value determined by the `Min_Backoff_Exponent` variable. Informational Statement: The random access algorithm is unstable; the NRC is expected to have intelligence to detect an unstable state of the random access algorithm and to solve it.

b) *Ranging Access*

`Ranging Access` indicates that the data is sent in a slot preceded and followed by slots not used by other users. These slots allow users to adjust their clock depending on their distance to the INA such that their slots fall within the correct allocated time. They are either contention based when the ranging control slot indicator `b0` received during the previous superframe was 1 (or when `b1-b6 = 55 to 63`), or reserved if the INA indicates to the NIU that a specific slot is reserved for ranging.

c) *Fixed rate Access*

NOTE – Fixed rate is called contentionless in DAVIC.

`Fixedrate Access` indicates that data is sent in slots assigned to the Fixed rate based access region in the upstream channel. These slots are uniquely assigned to a connection by the INA. No fixed rate access can be initiated by the NIU.

d) *Reservation Access*

`Reservation Access` implies that data is sent in the slots assigned to the reservation region in the upstream channel. These slots are uniquely assigned on a frame-by-frame basis to a connection by the INA. This assignment is made at the request of the NIU for a given connection.

A.5.5.2.5 MAC error handling procedures

Error handling procedures are under definition (Time out windows, power outage, etc.).

A.5.5.2.6 MAC messages

The MAC message types are divided into the logical MAC states of Initialization, Sign-on, Connection Management and Link Management. Messages in italic represent upstream transmission from NIU to INA. MAC messages are sent using Broadcast or Singlecast Addressing. Singlecast address shall utilize the 48-bit MAC address (see Table A.14).

Table A.14/J.112 – MAC messages

Message type value		Addressing type
	MAC Initialization, Provisioning and Sign-On messages	
0x01	Provisioning Channel message	Broadcast
0x02	Default Configuration message	Broadcast
0x03	Sign-on Request message	Broadcast
0x04	<i>Sign-on Response message</i>	Singlecast
0x05	Ranging and Power Calibration message	Singlecast
0x06	<i>Ranging and Power Calibration Response message</i>	Singlecast
0x07	Initialization Complete message	Singlecast
0x08-0x1F	[Reserved]	
	MAC Connection Establishment and Termination messages	
0x20-0x3F		
0x20	Connect message	Singlecast
0x21	<i>Connect Response message</i>	Singlecast
0x22	<i>Reservation Request message</i>	Singlecast
0x23	Reservation Response message	Broadcast
0x24	Connect Confirm message	Singlecast
0x25	Release message	Singlecast
0x26	<i>Release Response message</i>	Singlecast
0x28	Reservation Grant message	Broadcast
0x29	Reservation ID Assignment	Singlecast
0x2A	<i>Reservation Status Request</i>	Singlecast
0x2B	<i>Reservation ID Response message</i>	Singlecast
0x2C-0x3F	[Reserved]	
	MAC Link Management messages	
0x27	<i>Idle message</i>	Singlecast
0x40	Transmission Control message	Scast or Bcast
0x41	Reprovision message	Singlecast
0x42	<i>Link Management Response message</i>	Singlecast
0x43	Status Request message	Singlecast
0x44	<i>Status Response message</i>	Singlecast
0x45-0x5F	[Reserved]	

To support the delivery of MAC related information to and from the NIU, a dedicated Virtual Channel shall be utilized. The VPI,VCI for this channel shall be 0x000,0x0021:

- *Upstream MAC messages*
AAL5 (as specified in Recommendation I.363) adaptation shall be used to encapsulate each MAC PDU in an ATM cell. Upstream MAC information should be single 40-bytes cell messages.

- *Downstream OOB MAC messages*
AAL5 (as specified in Recommendation I.363) adaptation shall be used to encapsulate each MAC PDU in an ATM cell. Downstream OOB MAC information may be longer than 40-bytes.

- Downstream IB MAC messages

Downstream IB MAC information is limited to 120-bytes long messages. Longer messages must be split into separate messages. No AAL5 layer is defined for MPEG-2 TS cells. MAC messages must therefore be sent as explained in Figure A.27.

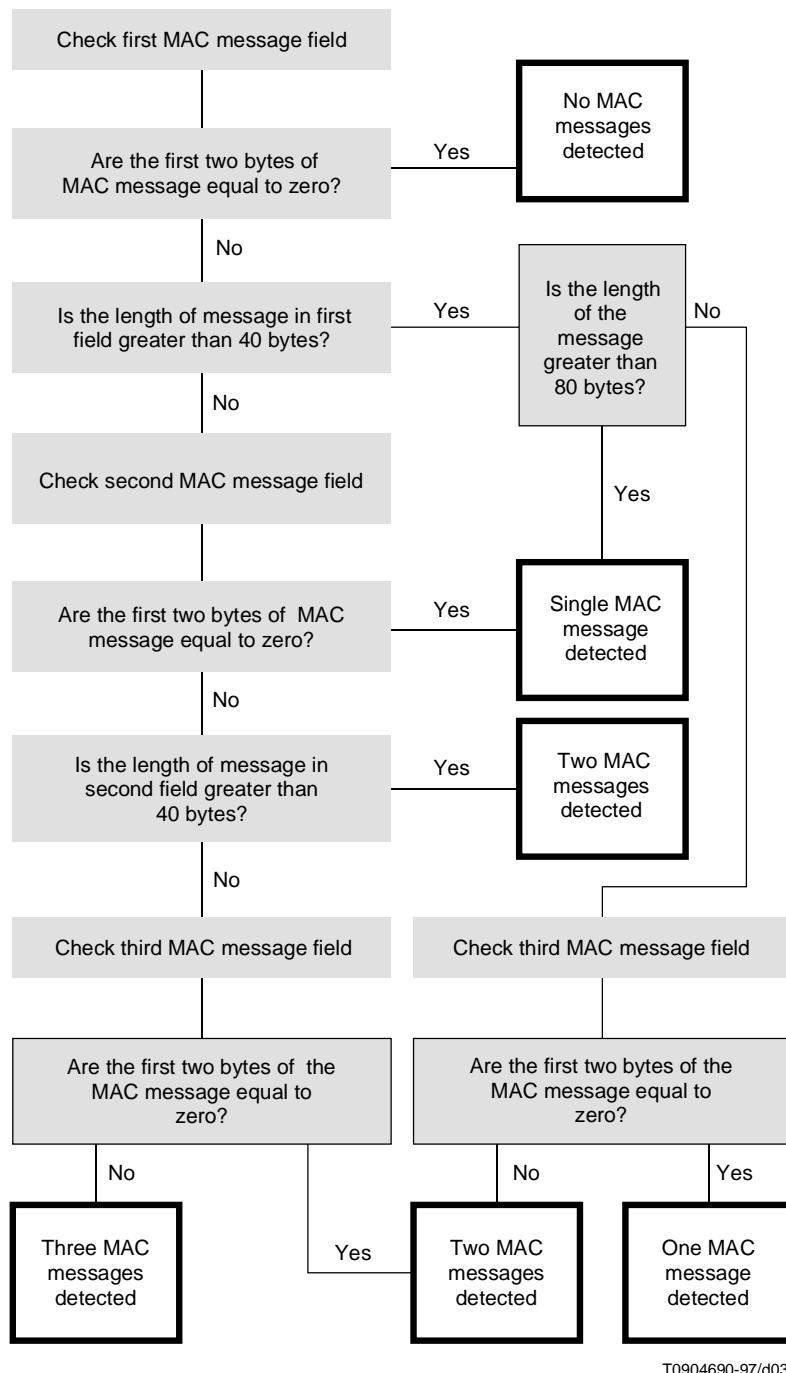

T0904690-97/d036

Figure A.27/J.112 – Algorithm when MAC messages are sent IB downstream

Since MAC related information is terminated at the NIU and INA, a privately defined message structure will be utilized. The format of this message structure is illustrated in Table A.15.

NOTE 1 – All messages are sent most significant bit first.

NOTE 2 – For all MAC messages where the parameter length is smaller than the field, the parameter shall be right justified with leading bits set to 0. All reserved fields in the MAC messages shall be set to 0.

NOTE 3 – Message 0x23 is not used in the present release of the MAC protocol. It refers to DAVIC 1.0 protocol which is not supported by this specification.

NOTE 4 – When no MAC_Address is specified in the message, it means that the message is sent broadcast. (Syntax_indicator = 000)

NOTE 5 – Negative integers are sent in 2's complement.

Table A.15/J.112 – MAC message structure

	Bits	Bytes	Bit number/Description
MAC_message(){			
Message_Configuration	8	1	
Protocol_Version	5		
Syntax_Indicator	3		
Message_Type	8	1	
If (syntax_indicator==001) {			
MAC_Address	(48)	(6)	
}			
{			
MAC_Information_Elements()		N	
} }			

Protocol Version

Protocol_Version is a 5-bit field used to identify the current MAC version. The value for this parameter is given in Table A.16.

Table A.16/J.112 – Protocol_version coding

Value	Definition
0	DAVIC 1.0 compliant device (not consistent with this specification)
1	DAVIC 1.1 compliant device
2	DAVIC 1.2 compliant device
3-31	Reserved

Syntax Indicator

Syntax_Indicator is a 3-bit enumerated type that indicates the addressing type contained in the MAC message.

```
Enum Syntax_Indicator {No_MAC_Address, MAC_Address_Included, reserved2..7};
```

MAC Address

MAC_Address is a 48-bit value representing the unique MAC address of the NIU. This MAC address may be hard coded in the NIU or be provided by external source.

A.5.5.3 MAC Initialization and Provisioning

This subclause defines the procedure for Initialization and Provisioning that the MAC shall perform during power on or Reset.

- 1) Upon a NIU becoming active (i.e. powered up), it must first find the current provisioning frequency. The NIU shall receive the **<MAC> Provisioning Channel Message**. This message shall be sent aperiodically on all downstream OOB channels when there are multiple channels. In the case of only a single channel, the message shall indicate the current channel to be utilized for Provisioning. Upon receiving this message, the NIU shall tune to the Provisioning Channel. In the case of IB downstream, the IB channel to be used during provisioning must be given by using ETS 300 468, no **<MAC> Provisioning Channel Message** is needed.
- 2) After a valid lock indication on a Provisioning Channel, the NIU shall await the **<MAC> DEFAULT CONFIGURATION MESSAGE**. When received, the NIU shall configure its parameters as defined in the default configuration message. The Default Configuration Parameters shall include default timer values, default power levels, default retry counts as well as other information related to the operation of the MAC protocol.

Figure A.28 shows the signalling sequence.

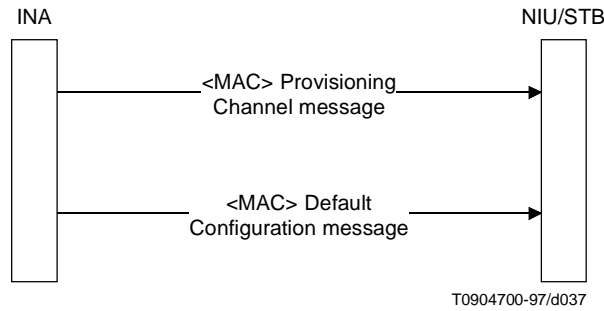

Figure A.28/J.112 – Initialization and Provisioning signalling

A.5.5.3.1 <MAC> Provisioning Channel Message (broadcast OOB downstream)

The **<MAC> PROVISIONING CHANNEL MESSAGE** is sent by the INA to direct the NIU to the proper Out-of-Band frequency where provisioning is performed. The format of the message is shown in Table A.17.

Table A.17/J.112 – Provisioning Channel Message format

	Bits	Bytes	Bit number/Description
Provisioning_Channel_Message() {			
Provisioning_Channel_Control_Field	8	1	
<i>reserved</i>	7		7-1:
provisioning_frequency_included	1		0: {no=0, yes=1}
<i>if (provisioning_frequency_included) {</i>			
Provisioning_Frequency	(32)	(4)	
DownStream_Type	8	1	
}			
}			

Provisioning Channel Control Field

Provisioning_Channel_Control_Field is used to specify the downstream frequency where the NIU will be provisioned.

Provisioning Frequency Included

provisioning_frequency_included is a boolean when set, indicates that a downstream OOB frequency is specified that the NIU should tune to begin the provisioning process. When cleared, indicates that the current downstream frequency is the provisioning frequency.

Provisioning Frequency

Provisioning_Frequency is a 32-bit unsigned integer representing the Out-of-band Frequency in which NIU provisioning occurs. The unit of measure is Hz.

Downstream Type

DownStream_Type is an 8-bit enumerated type indicating the modulation format for the down stream connection. {reserved, QPSK_1.544, QPSK_3.088, 3..255 reserved}

A.5.5.3.2 <MAC> Default Configuration Message (broadcast downstream)

The <MAC> DEFAULT CONFIGURATION MESSAGE is sent by the INA to the NIU. The message provides default parameter and configuration information to the NIU. The format of the message is shown in Table A.18.

Table A.18/J.112 – Default configuration message structure

	Bits	Bytes	Bit number/Description
Default_Configuration_Message(){			
Sign_On_Incr_Pwr_Retry_Count	8	1	
Service_Channel_Frequency	32	4	
Service_Channel_Control_Field		1	
MAC_Flag_Set	5		7-3
Service_Channel	3		2-0
Backup_Service_Channel_Frequency	32	4	
Backup_Service_Channel_Control_Field		1	
Backup_MAC_Flag_Set	5		7-3
Backup_Service_Channel	3		2-0
Service_Channel_Frame_Length	16	2	
Service_Channel_Last_Slot	16	2	
Max_Power_Level	8	1	
Min_Power_Level	8	1	
Upstream_Transmission_Rate	3	1	{enum}
Max_Backoff_Exponent	8	1	
Min_Backoff_Exponent	8	1	
Idle_Interval	16	2	
}			

Sign-On Increment Power Retry Count

`Sign_On_Incr_Pwr_Retry_Count` is an 8-bit unsigned integer representing the number of attempts the NIU should try to enter the system at the same power level before incrementing its power level by steps of 0.5 dB.

Service Channel Frequency

`Service_Channel_Frequency` is a 32-bit unsigned integer representing the upstream frequency assigned to the service channel. The unit of measure is in Hz.

MAC_Flag_Set

`MAC_Flag_Set` is a 5-bit field representing the MAC Flag set assigned to the service channel (i.e. R1a, R1b and R1c represent MAC Flag set 1). In the OOB downstream SL-ESF frame payload structure, each set of three bytes, denoted by Rxa-Rxc, comprise a Flag set. These eight flag sets are assigned the numbers 1-8. In the IB downstream timing, the 16 flag sets are assigned the numbers 1-16. In the case of a 3.088 Mbit/s upstream channel, two successive flag sets are required to define a 3-ms period. In this case, this parameter represents the first of two successively assigned flag sets. In the case of a 3.088 Mbit/s OOB downstream, two successive SL-ESF frames define the 3-ms interval. The Rxa-Rxc bytes of the first frame represent flag sets 1-8 while the Rxa-Rxc bytes of the second frame represent flag sets 9-16.

A downstream channel contains control information for each of its associated upstream channels. This information is contained within structures known as MAC Flags. A set of MAC Flags, represented by either 24 bits (denoted b0-b23) or by 3 bytes (denoted Rxa, Rxb and Rxc), are uniquely assigned to a given upstream channel.

In the OOB downstream case, each SL-ESF frame structure contains eight sets of MAC Flags represented by Rxa, Rxb and Rxc, where x is replaced by the numbers 1-8. In the case of a 1.544 Mbit/s downstream bit rate, only one SL-ESF frame occurs during a 3-ms interval providing 8 sets of MAC Flags. In the case of a 3.088 Mbit/s downstream bit rate, two SL-ESF frames occur during a 3-ms interval, providing 16 sets of MAC Flags. The second set of MAC Flags (contained in the second SL-ESF) are denoted by Rxa, Rxb and Rxc, where x is replaced by the numbers 9 through 16.

In the IB downstream case, the MAC Flags are contained in the MAC Control Message Structure which can contain as many as 16 MAC Flag sets. The MAC Flags 1-8 are contained in the "MAC Flags" field and the MAC Flags 9-16 are contained in the "Extension Flags" field.

In case of a 3.088 Mbit/s upstream channel, two sets of MAC Flags are required. In this case, the `MAC_Flag_Set` parameter represents the first of two successively assigned MAC Flag sets.

Service Channel

`Service_Channel` is a 3-bit field which defines the channel assigned to the `Service_Channel_Frequency`. Although the function provided by this parameter is superseded in this specification by the `MAC_Flag_Set`, it is retained in order to identify the logical channel assigned to the NIU/STB.

Backup Service Channel Frequency

`Backup_Service_Channel_Frequency` is a 32-bit unsigned integer representing the upstream frequency assigned to the backup service channel. The backup service channel is used when entry on the primary service channel fails. The unit of measure is in Hz.

Backup_MAC_Flag_Set

Backup_MAC_Flag_Set is a 5-bit field representing the MAC Flag set assigned to the backup service channel. The function of this field is the same as the MAC_Flag_Set above but with respect to the backup service channel.

Backup_Service_Channel

Backup_Service_Channel is a 3-bit field which defines the channel assigned to the Backup Service_Channel_Frequency. The function of this field is the same as the Service_Channel above but with respect to the backup channel.

Service_Channel_Frame_Length [reserved]

Unused in this version.

Service_Channel_Last_Slot

Service_Channel_Last_Slot is a 16-bit unsigned integer representing the largest slot value of the NIU slots position counter ($N \times 3 \times m$, where N is defined in A.5.4.3). In general, this value will be used for all other upstream channels. It will be a multiple of 3, 9 or 18 for 256 kbit/s, 1.544 Mbit/s, or 3.088 Mbit/s respectively.

Maximum Power Level

MAX_Power_Level is an 8-bit unsigned integer representing the maximum power the NIU shall be allowed to use to transmit upstream. The unit of measure is in dBmicroV (RMS) on 75 Ω .

Minimum Power Level

MIN_Power_Level is an 8-bit unsigned integer representing the minimum power the NIU shall be allowed to use to transmit upstream. The unit of measure is in dBmicroV (RMS) on 75 Ω .

Upstream Transmission Rate

Upstream_Transmission_Rate is a 3-bit enumerated type that indicates the upstream transmission rate.

enum Upstream_Transmission_Rate {Upstream_256K, Upstream_1-544M, Upstream_3-088M, reserved3..7};
--

MIN_Backoff_Exponent

MIN_Backoff_Exponent is an 8-bit unsigned integer representing the minimum value of the backoff exponent counter.

MAX_Backoff_Exponent

MAX_Backoff_Exponent is an 8-bit unsigned integer representing the minimum value of the backoff exponent counter.

Idle Interval

Idle_Interval is a 16-bit unsigned integer representing the predefined interval for the MAC Idle messages. The unit of the measure is in milliseconds.

A.5.5.4 Sign-On and Calibration

The NIU shall Sign On via the Sign-On procedure. The signalling flow for Sign-On is described below:

- The NIU shall tune to the downstream Provisioning Channel and the upstream Service Channel with the information provided in the Initialization and Provisioning sequence.
- The NIU shall await the **<MAC> Sign-On Request Message** from the INA Entity. The NIU shall utilize Contention based entry on the Service Channel to access the network.
- Upon receiving the **<MAC> Sign-On Request Message**, the NIU shall respond with the **<MAC> Sign-On Response Message**. The Sign-On Response message shall be transmitted on a Ranging Control Slot.
- The INA, upon receiving the Sign-On Response message shall validate the NIU and send the **<MAC> Ranging and Power Calibration Message**.
- The NIU shall respond to the **<MAC> Ranging and Power Calibration Message** with the **<MAC> Ranging and Power Calibration Response Message**. The **<MAC> Ranging and Power Calibration Response Message** shall be transmitted on a Ranging Control Slot (which can either be in the ranging region ($b_0 = 1$) or reserved region (if a ranging slot number is given in the message)).
- The INA shall send the **<MAC> Initialization Complete Message** when the NIU is calibrated. The NIU is assumed to be calibrated if the message arrives within a window of 1.5 symbols (upstream rate) and a power within a window of 1.5 dB from their optimal value.

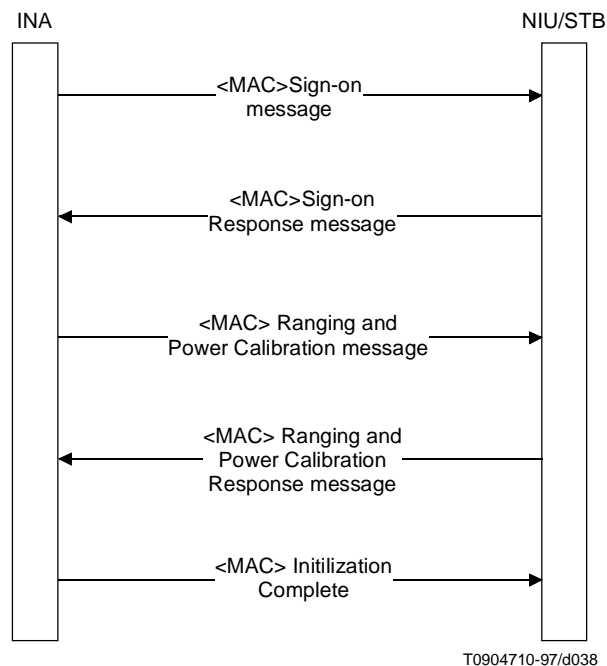
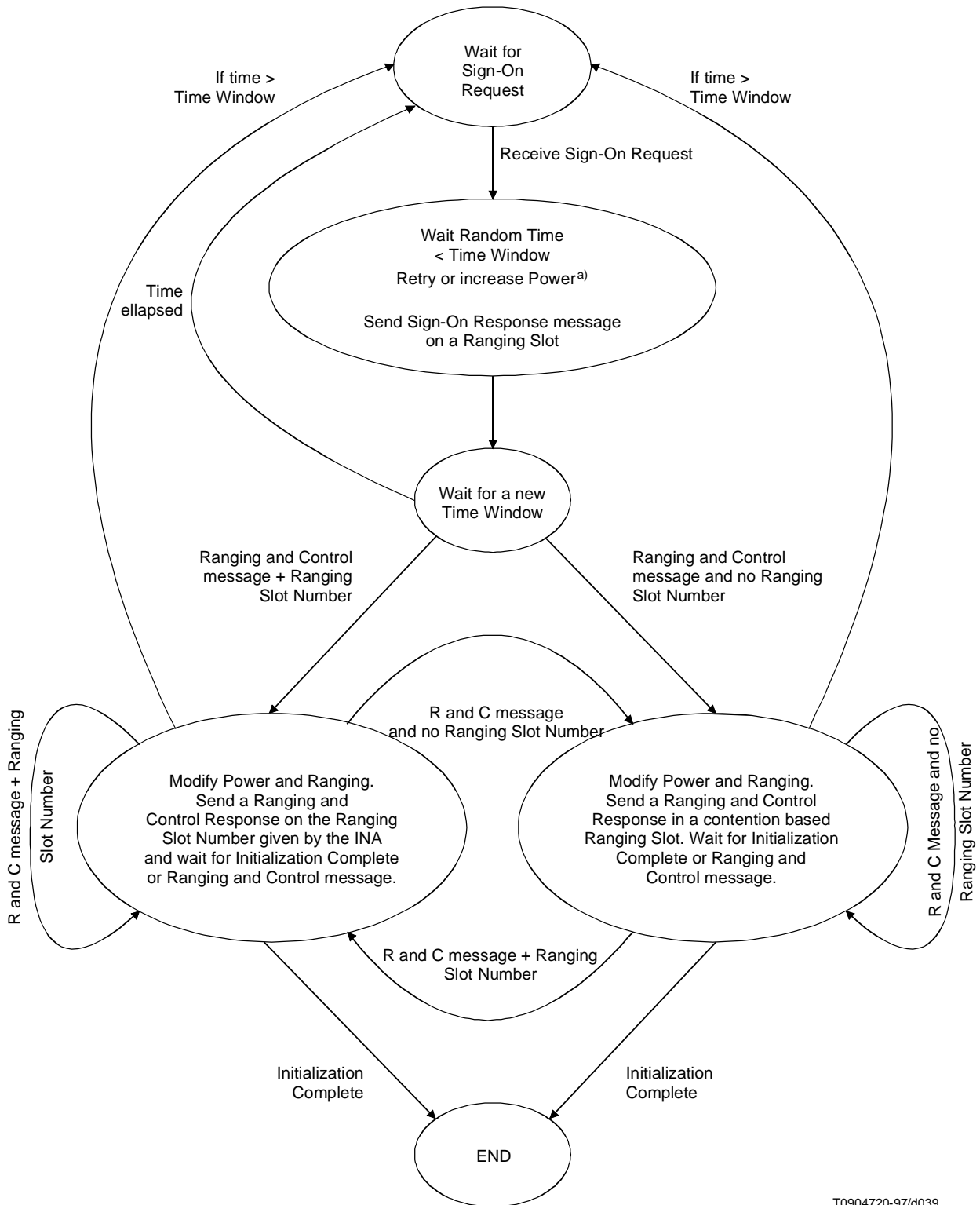

Figure A.29/J.112 – Ranging and calibration signalling

Figure A.30 state diagram details the procedure described above.



T0904720-97/d039

a) "Retry or Increase Power" means that the NIU should retry with the same power Sign_On_Incr_Pwr_Retry_Count times (given by the <MAC> default configuration message) and then increase the power by 0.5 dB.

Figure A.30/J.112 – State diagram for Ranging and calibration

NOTE – The Ranging and Control message shown in Figure A.30 corresponds to the <MAC> Ranging and Power Calibration Message. The Ranging and Control Response corresponds to the <MAC> Ranging and Power Calibration Response Message. "Sign-On Request" stands for <MAC> Sign-On Request Message, and similarly, "Sign-On Response" stands for <MAC> Sign-On Response Message.

A.5.5.4.1 <MAC> Sign-On Request Message (broadcast downstream)

The <MAC> SIGN-ON REQUEST message is issued periodically by the INA to allow a NIU to indicate its presence in the network. The format of this subcommand is shown in Table A.19.

Table A.19/J.112 – Sign-on Request message structure

	Bits	Bytes	Bit number/Description
Sign-On_Request_Message() {			
Sign-On_Control_Field	8	1	
Reserved	7		7-1
Address_Filter_Params_Included	1		0: {no,yes}
Response_Collection_Time_Window	16	2	
if (Sign-On_Control_Field= Address_Filter_Params_Included {			
Address_Position_Mask	(8)	(1)	
Address_Comparison_Value	(8)	(1)	
}			
}			

Sign-On Control Field

Sign-On_Control_Field specifies what parameters are included in the SIGN-ON REQUEST.

Address Filter Parameters Included

address_filter_params_included is a boolean, when set, indicates that the NIU should respond to the SIGN-ON REQUEST only if its address matches the filter requirements specified in the message.

Response Collection Time Window

Response_Collection_Time_Window is a 16-bit unsigned integer that specifies the duration of time the NIU has to respond to the SIGN-ON REQUEST. The unit of measure is the millisecond (ms).

Address Position Mask

Address_Position_Mask is an 8-bit unsigned integer that indicates the bit positions in the NIU MAC address that are used for address filtering comparison. The bit positions are comprised between bit number Mask and Mask+7. Mask = 0 corresponds to the 8 LSBs of the address, i.e. it represents the number of bits shifted to the left. The maximum value is 40.

Address Comparison Value

Address_Comparison_Value is an 8-bit unsigned integer that specifies the value that the NIU should use for MAC address comparison (see Figure A.31).

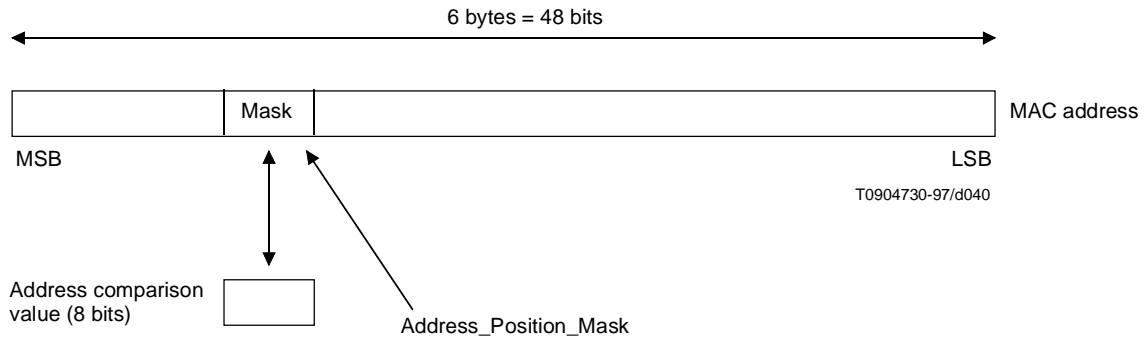

Figure A.31/J.112 – Position of Mask in MAC address

A.5.5.4.2 <MAC> Sign-On Response Message (upstream Contention or Ranging)

The <MAC> Sign-On Response Message is sent by the NIU in response to the <MAC> Sign-On Request Message issued by the INA Entity. The NIU shall wait for a random time less than Response_Collection_Time_Window to send this message (see Table A.20).

Table A.20/J.112 – Sign-On Response message structure

	Bits	Bytes	Bit number/Description
Sign-On_Response_Message() {			
[reserved]	32	4	
[reserved]	16	2	
Retry_Count	8	1	
}			

Retry Count

Retry_Count is an 8-bit unsigned integer that indicates the number of transmissions of the <MAC> Sign-On Response. This field is always included in the response to the <MAC> Sign-On Request.

A.5.5.4.3 <MAC> Ranging and Power Calibration Message (singlecast downstream)

The <MAC> RANGING AND POWER CALIBRATION MESSAGE is sent by the INA to the NIU to adjust the power level or time offset the NIU is using for upstream transmission. The format of this message is shown in Table A.21.

Table A.21/J.112 – Ranging and Power Calibration message structure

	Bits	Bytes	Bit number/description
Ranging_and_Power_Calibration_Message(){			
Range_Power_Control_Field	8	1	
<i>reserved</i>	5		7-3:
ranging_slot_included	1		2: {no, yes}
time_adjustment_included	1		1: {no, yes}
power_ajustment_included	1		0: {no, yes}
<i>if (range_power_control_field == time_adjustment_included) {</i>			
Time_Offset_Value	(16)	(2)	
<i>}</i>			
<i>if (range_power_control_field == power_adjustment_included) {</i>			
Power_Control_Setting	(8)	(1)	
<i>}</i>			
<i>if (range_power_control_field == ranging_slot_included) {</i>			
Ranging_Slot_Number	(16)	(2)	
<i>}</i>			

Range and Power Control Field

Range_Power_Control_Field specifies which Range and Power Control parameters are included in the message.

Time Adjustment Included

time_adjustment_included is a boolean when set, indicates that a relative Time Offset Value is included that the NIU should use to adjust its upstream slot transmit position.

Power Adjust Included

power_adjust_included is a boolean when set, indicates that a relative Power Control Setting is included in the message.

Ranging Slot Included

Ranging_Slot_Included is a boolean when set, indicates the calibration slot available. When this bit equals 1, the NIU must send its response on the slot number given by **Ranging Slot Number**. When this bit equals 0, the NIU must respond on a ranging slot as mentioned in Figure A.30.

Time Offset Value

Time_Offset_Value is a 16-bit short integer representing a relative offset of the upstream transmission timing. A negative value indicates an adjustment forward in time (later). A positive value indicates an adjustment back in time (earlier). The unit of measure is 100 ns (The NIU will adjust approximately its time offset to the closest value indicated by the Time_Offset_Value parameter, which implies that no extra clock is needed to adjust to the correct offset).

Power Control Setting

Power_Control_Setting is an 8-bit signed integer to be used to set the new power level of the NIU. (A positive value represents an increase of the output power level.)

$$\text{New output_power_level} = \text{current output_power_level} + \text{power_control_setting} \times 0.5 \text{ dB}$$

Ranging Slot Number

Ranging_Slot_Number is a 16-bit unsigned integer that represents the reserved access Slot Number assigned for Ranging the NIU. It shall be assigned by the INA in the reservation area. The INA shall assure that an unassigned slot precedes and follows the ranging slot.

A.5.5.4.4 <MAC> Ranging and Power Calibration Response Message (upstream reserved or contention ranging)

The <MAC> RANGING AND POWER CALIBRATION RESPONSE Message is sent by the NIU to the INA in response to the <MAC> RANGING AND POWER CALIBRATION MESSAGE. The format of the message is shown in Table A.22.

Table A.22/J.112 – Ranging and Power Calibration Response message structure

	Bits	Bytes	Bit number/Description
Ranging_Power_Response_Message() {			
Power_Control_Setting	8	1	
}			

Power Control Setting

Power_Control_Setting is an 8-bit signed integer defined as a copy of the power control setting parameter received from INA.

A.5.5.4.5 <MAC> Initialization Complete Message (singlecast downstream)

This message has no message body. It indicates the end of the MAC Sign-On and Provisioning procedure.

A.5.5.5 Default Connection Establishment

Once a NIU has completed the Calibration State, it shall enter the Connection State. A low bit rate permanent connection is assigned to a NIU by the INA. After the initial calibration procedure, the INA provides a Default Connection to the NIU that the NIU shall utilize to communicate to the network. The message flow for such Connection Establishment is shown below (see Figure A.32):

- 1) After Initialization, Provisioning and Sign-On procedures are complete, the INA shall assign a default upstream and downstream connection to the NIU. This connection can be assigned on any of the upstream channels except the upstream service channel ranging area. The INA shall assign the default connection by sending the <MAC> **Connect Message** to the NIU. This message shall contain the upstream connection parameters and downstream frequency on which the default connection is to reside.
- 2) The NIU, upon receiving the <MAC> **Connect Message** shall tune to the required upstream and downstream frequencies and send the <MAC> **Connect Response Message** confirming receipt of the message.
- 3) Upon receipt of the <MAC> **Connect Response Message**, the INA shall confirm the new connection to proceed by sending the <MAC> **Connect Confirm Message**.

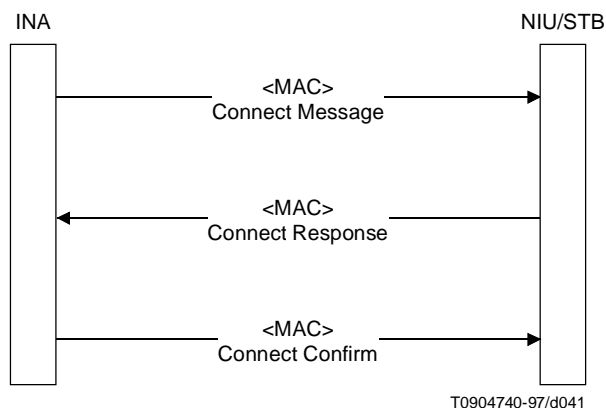

Figure A.32/J.112 – Connection signalling

A.5.5.5.1 <MAC> Connect Message (unicast downstream)

See Table A.23.

Table A.23/J.112 – Connect message structure

	Bits	Bytes	Numéro number/ Description
Connect_Message () {			
Connection_ID	32	4	
Session_Number	32	4	
Resource_Number	16	2	
Connection_Control_Field	8	1	
DS_ATM_CBD_Included	1		7: {no, yes}
DS_MPEG_CBD_Included	1		6: {no, yes}
US_ATM_CBD_Included	1		5: {no, yes}
Upstream_Channel_Number	3		4-2
Slot_List_Included	1		1: {no, yes}
Cyclic_Assignment	1		0: {no, yes}
Frame_Length	(16)	(2)	
Maximum_Contention_Access_Message_Length	(8)	(1)	
Maximum_Reservation_Access_Message_Length	(8)	(1)	
if (Connection_Control_Field &== DS_ATM_CBD_Included) {			
Downstream_ATM_CBD()	64	8	
}			
if (Connection_Control_Field &== DS_MPEG_CBD_Included) {			
Downstream_MPEG_CBD()	48	6	
}			
if (Connection_Control_Field &== US_ATM_CBD_Included) {			
Upstream_ATM_CBD()	64	8	
}			
if (Connection_Control_Field &== Slot_List_Included) {			
Number_Slots_Defined	8	1	
for (i=0; i<Number_Slots_Assigned; i++) {			
Slot_Number	(16)	(2)	
}			
}			
if (MAC_Control_Params == cyclic_Assignment){			Fixed Rate Access
Fixedrate_Start	(16)	(2)	
Fixedrate_Dist	(16)	(2)	
Fixedrate_End	(16)	(2)	
}}			

Connection ID

Connection_ID is a 32-bit unsigned integer representing a connection Identifier for the NIU Dynamic Connection.

Session Number

Session_Number is a 32-bit unsigned integer representing the Session that the connection parameters are associated. This parameter is not used by this specification.

Resource Number

Resource_Number is a 16-bit unsigned integer providing a unique number to the resource defined in the message. This parameter is not used by this specification.

Connection Control Field

DS_ATM_CBD_Included is a boolean that indicates that the Downstream ATM Descriptor is included in the message.

DS_MPEG_CBD_Included is a boolean that indicates that the Downstream MPEG Descriptor is included in the message.

US_ATM_CBD_Included is a boolean that indicates that the Upstream ATM Descriptor is included in the message.

Upstream_Channel_Number is a 3-bit unsigned integer that provides an identifier for the upstream channel. This parameter is not used in this specification.

Slot_List_Included is a boolean that indicates that the Slot List is included in the message.

Cyclic_Assignment is a boolean that indicates Cyclic Assignment.

Frame Length

Frame_length – This 16-bit unsigned number represents the number of successive slots in the fixed rate access region associated with each fixed rate slot assignment. In the slot_list method of allocating slots it represents the number of successive slots associated with each element in the list. In the cyclic method of allocating slots it represents the number of successive slots associated with the Fixedrate_Start_slot and those which are multiples of Fixedrate_Distance from the Fixedrate_Start_slot within the Fixed rate access region.

Maximum Contention Access Message Length

Maximum_contention_access_message_length is an 8-bit number representing the maximum length of a message in ATM sized cells that may be transmitted using contention access. Any message greater than this should use reservation access.

Maximum Reservation Access Message Length

Maximum_reservation_access_message_length is an 8-bit number representing the maximum length of a message in ATM sized cells that may be transmitted using a single reservation access. Any message greater than this should be transmitted by making multiple reservation requests.

Downstream ATM Connection Block Descriptor

See Table A.24.

Table A.24/J.112 – ATM Connection Block Descriptor substructure

	Bits	Bytes	Bit number/ Description
Downstream_ATM_CBD() {			
Downstream_Frequency	32	4	
Downstream_VPI	8	1	
Downstream_VCI	16	2	
Downstream_Type	8	1	
}			

Downstream Frequency

Downstream_Frequency is a 32-bit unsigned integer representing the Frequency where the connection resides. The unit of measure is in Hz.

Downstream Virtual Path Identifier

Downstream_VPI is an 8-bit unsigned integer representing the ATM Virtual Path Identifier that is used for downstream transmission over the Dynamic Connection.

Downstream Virtual Channel Identifier

Downstream_VCI is a 16-bit unsigned integer representing the ATM Virtual Channel Identifier that is used for downstream transmission over the Dynamic Connection.

DownStream_Type

DownStream_Type is an 8-bit enumerated type indicating the modulation format for the down stream connection. { reserved, QPSK_1.544, QPSK_3.088, 3..255 reserved}.

Downstream MPEG Connection Block Descriptor

See Table A.25.

Table A.25/J.112 – Downstream_MPEG_CBD substructure

	Bits	Bytes	Bit number/ Description
Downstream_MPEG_CBD() {			
Downstream_Frequency	32	4	
Program_Number	16	2	
}			

Downstream Frequency

Downstream_Frequency is a 32-bit unsigned integer representing the Frequency where the connection resides. The unit of measure is in Hz.

Program Number

Program_Number is a 16-bit unsigned integer uniquely referencing the downstream virtual connection assignment (PID of the MPEG-2 program).

Upstream ATM Connection Block Descriptor

See Table A.26.

Table A.26/J.112 – Upstream_CBD substructure

	Bits	Bytes	Bit number/ Description
Upstream_ATM_CBD() {			
Upstream_Frequency	32	4	
Upstream_VPI	8	1	
Upstream_VCI	16	2	
MAC_Flag_Set	5	1	7:3
Upstream_Rate	3		2:0
}			

Upstream Frequency

`Upstream_Frequency` is a 32-bit unsigned integer representing the channel on assigned to the connection. The unit of measure is in Hz.

Upstream Virtual Path Identifier

`Upstream_VPI` is an 8-bit unsigned integer representing the ATM Virtual Path Identifier that is used for upstream transmission over the Dynamic Connection.

Upstream Virtual Channel Identifier

`Upstream_VCI` is a 16-bit unsigned integer representing the ATM Virtual Channel Identifier that is used for upstream transmission over the Dynamic Connection.

MAC_Flag_Set

`MAC_Flag_Set` is a 5-bit field representing the MAC Flag set assigned to the connection. In the OOB downstream SL-ESF frame payload structure, each set of three bytes, denoted by `Rxa-Rxc`, comprise a flag set. These eight flag sets are assigned the numbers 1-8. In the IB downstream timing, the 16-flag sets are assigned the numbers 1-16. In the case of a 3.088 Mbit/s upstream channel, two successive flag sets are required to define a 3-ms period. In this case, this parameter represents the first of two successively assigned flag sets. In the case of a 3.088 Mbit/s OOB downstream, two successive SL-ESF frames define the 3-ms interval. The `Rxa-Rxc` bytes of the first frame represent flag sets 1-8 while the `Rxa-Rxc` bytes of the second frame represent flag sets 9-16.

Upstream_Rate

`Upstream_Rate` is a 3-bit enumerated type indicating the data rate for the upstream connection. { `Upstream_256K`, `Upstream_1.544M`, `Upstream_3.088M`, 3..7 reserved }

Number of Slots Defined

`Number_Slots_Defined` is an 8-bit unsigned integer that represents the number of slot assignments contained in the message. The unit of measure is slots.

Slot Number

`Slot_Number` is a 16-bit unsigned integer that represents the Fixed rate based Slot Number assigned to the NIU.

Fixed rate Start

`Fixedrate_Start` – This 16-bit unsigned number represents the starting slot within the fixed rate access region that is assigned to the NIU. The NIU may use the next `Frame_length` slots of the fixed rate access regions.

Fixed rate Distance

`Fixedrate_Distance` – This 16-bit unsigned number represents the distance in slots between additional slots assigned to the NIU. The NIU is assigned all slots that are a multiple of `Fixedrate_Distance` from the `Fixedrate_Start_slot` which do not exceed `Fixedrate_End_slot`. The NIU may use the next `Frame_length` slots. of the fixed rate access regions from each of these additional slots.

Fixed rate End

`Fixedrate_End` – This 16-bit unsigned number indicates the last slot that may be used for fixed rate access. The slots assigned to the NIU, as determined by using the `Fixedrate_Start_slot`, the `Fixedrate_Distance` and the `Frame_length`, cannot exceed this number.

A.5.5.5.2 <MAC> Connect Response (upstream contention, reserved or contention access)

The <MAC> CONNECT RESPONSE MESSAGE is sent to the INA from the NIU in response to the <MAC> CONNECT MESSAGE. The message shall be transmitted on the upstream frequency specified in the <MAC> CONNECT MESSAGE (see Table A.27).

Table A.27/J.112 – Connect response message structure

	Bits	Bytes	Bit number/ Description
Connect_Response() {			
Connection_ID	32	4	
}			

Connection ID

Connection_ID is a 32-bit unsigned integer representing a global connection Identifier for the NIU Dynamic Connection.

A.5.5.5.3 <MAC> Connect Confirm (singlecast downstream)

The <MAC> Connect Confirm message is sent from the INA to the NIU (see Table A.28).

Table A.28/J.112 – Connect Confirm message structure

	Bits	Bytes	Bit number/ Description
Connect_Confirm() {			
Connection_ID	32	4	
}			

Connection ID

Connection_ID is a 32-bit unsigned integer representing a global connection Identifier for the NIU Dynamic Connection.

A.5.5.6 Data connections

A connection is initiated by the INA using the <MAC> Connect Message explained in A.5.5.5.1. This message is either used to immediately assign time slots for a fixed rate connection or just to assign a connection ID and related parameters without time slot assignment. In particular, for reservation or contention access, no time slots are assigned in the Connect Message, but the connection ID shall be used in requests for slots by the NIU.

Connection Assignment

The INA can assign other connections by using the <MAC> **Connect message** described previously. The NIU cannot request a connection, it must be initiated by higher layers.

Connection Release

This subclause defines the MAC signalling requirements for connection release. Figure A.33 displays the signalling flow for releasing a connection. The NIU cannot release a connection, this must be initiated by higher layers. This message is thus initiated by the INA only:

- 1) Upon receiving the <MAC> **Release Message** from the INA, the NIU shall tear down the upstream connection established for the specified Connection_ID.
- 2) Upon teardown of the upstream connection, the NIU shall send the <MAC> **Release Response Message** on the upstream channel previously assigned for that connection.

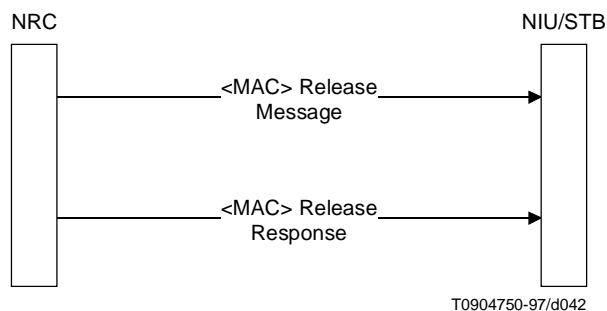

Figure A.33/J.112 – Connection release signalling

<MAC> Release Message (singlecast downstream)

The <MAC> Release Message is sent from the INA to the NIU to terminate a previously established connection (see Table A.29).

Table A.29/J.112 – Release message structure

	Bits	Bytes	Bit number/ Description
Release_Message(){			
Number_of_Connections	8	1	
<i>for(i=0;i<Number_of_Connections;i++){</i>			
Connection_ID }	32	4	
}			

Connection ID

Connection_ID is a 32-bit unsigned integer representing a global connection Identifier for the NIU Dynamic Connection.

<MAC> Release Response (upstream contention, reserved or contention)

The <MAC> RELEASE RESPONSE MESSAGE is sent by the NIU to the INA to acknowledge the release of a connection. The format of the message is shown in Table A.30.

Table A.30/J.112 – Release Response message structure

	Bits	Bytes	Bit number/ Description
Release_Response_Message (){			
Connection_ID	32	4	
}			

Connection ID

Connection_ID is a 32-bit unsigned integer representing the global connection Identifier used by the NIU for this connection.

A.5.5.6.1 Fixed rate access

Fixed rate access is provided by the INA using the <MAC> Connect Message.

A.5.5.6.2 Contention based access

The NIU shall use contention based slots specified by the slot boundary definition fields (Rx) to transmit contention based messages (see A.5.3). The format of contention based MAC messages is described by the MAC message format (see A.5.5.2.3).

A.5.5.6.3 Reservation access

This subclause defines the MAC signalling requirements for reservation access. Figure A.34 displays the signalling flow for reserving an access:

- 1) The NIU shall wait for a <MAC> Reservation ID Assignment Message from the INA before it can request reservation access.
- 2) At any time when needed after receiving the reservation ID, the NIU can request a certain number of slots to the INA using the <MAC> Reservation Request Message.
- 3) The INA shall respond to that message using the <MAC> Reservation Grant Message.
- 4) If the NIU has not received the <MAC> Reservation Grant Message before the Grant_Protocol_Timeout, it shall send a <MAC> Reservation Status Request to the INA. This leads back to 3).

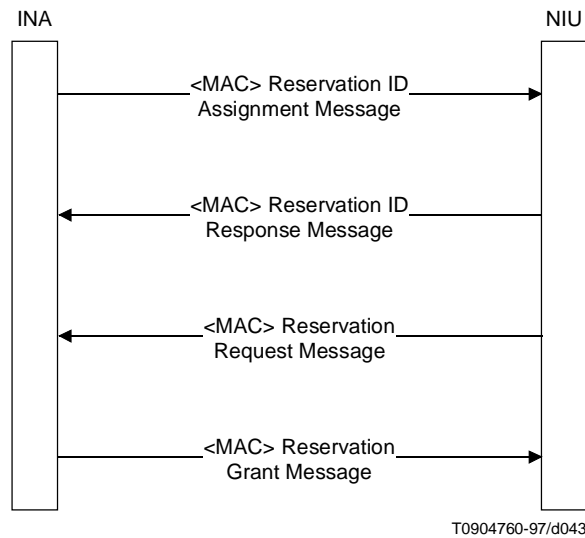

Figure A.34/J.112 – Reservation access signalling

<MAC> Reservation ID Assignment Message (unicast downstream)

The <MAC> Reservation ID Assignment Message is used to assign the NIU a Reservation_ID. The NIU identifies its entry in the Reservation_grant_message by comparing the Reservation_ID assigned to it by the Reservation_ID_assignment_message and the entries in the Reservation_Grant_message.

The format of the message is given in Table A.31.

Table A.31/J.112 – Reservation ID assignment message structure

	Bits	Bytes	Bit number/ Description
Reservation_ID_assignment_Message () {			
Connection_ID	32	4	
Reservation_ID	16	2	
Grant_protocol_timeout	16	2	
}			

Connection ID

Connection_ID is a 32-bit unsigned integer representing a global connection identifier for the NIU Dynamic Connection.

Reservation_ID

Reservation_ID is a 16-bit unsigned number representing a locally assigned identifier for the connection. This is used as a short identifier by the NIU to identify the appropriate Reservation_Grant_Messages.

Grant_protocol_timeout

Grant_protocol_timeout is a 16-bit unsigned number representing the time in milliseconds that the NIU should wait before verifying the status of pending grants. This parameter specifies the time that the NIU should wait after receiving the last <MAC> Reservation_grant_message, with an entry addressed to the NIU, before initiating a reservation status request. If the NIU has pending grants and the timeout occurs, it should send the Reservation_status_request message to the INA. The INA will respond with the Reservation_grant_message (probably without granting any slots) to inform the NIU of any remaining slots left to be granted. This allows the NIU to correct any problems, should they exist, such as issuing an additional request for slots or waiting patiently for additional grants.

<MAC> Reservation ID Response Message (upstream, contention or reserved access)

The <MAC> Reservation ID Response Message is used to acknowledge the receipt of the <MAC> Reservation_ID_Assignment message.

The format of the message is given below.

	Bits	Bytes	Bit number/ Description
Reservation_ID_Response_Message () {			
Connection_ID	32	4	
Reservation_ID	16	2	
}			

Connection ID

Connection_ID is a 32-bit unsigned integer representing a global connection identifier for the NIU/STB Dynamic Connection.

Reservation_ID

Reservation_ID is a 16-bit unsigned number representing a locally assigned identifier for the connection. This is used as a short identifier by the NIU/STB to identify the appropriate Reservation_Grant_Messages.

<MAC> Reservation Request Message (upstream contention, contention or reserved)

See Table A.32.

Table A.32/J.112 – Reservation Request message structure

	Bits	Bytes	Bit number/ Description
Reservation_Request_message () {			
Reservation_ID	16	2	
Reservation_request_slot_count	8	1	
}			

This message is sent from the NIU to the INA.

Reservation_ID

Reservation_ID is a 16-bit unsigned number representing a locally assigned identifier for the connection. This is used as a short identifier by the NIU to identify the appropriate Reservation_Grant_Messages.

Reservation Request Slot Count

Reservation_request_slot_count is an 8-bit unsigned number representing the number of slots requested by the NIU. This is the number of sequential slots that will be allocated in the reservation region of the upstream channel. The INA will respond with the Reservation_Grant message granting the request.

<MAC> Reservation Grant Message (broadcast downstream)

The <MAC> RESERVATION GRANT MESSAGE is used to indicate to the NIU which slots have been allocated in response to the Reservation Request message. The NIU identifies its entry in the Reservation_grant_message by comparing the Reservation_ID assigned to it by the Reservation_ID_assignment_message and the entries in the Reservation_Grant_message.

The format of the message is given in Table A.33.

Table A.33/J.112 – Reservation Grant message structure

	Bits	Bytes	Bit number/ Description
Reservation_grant_message () {			
Reference_slot	16	2	
Number_grants	8	1	
for (I=1; I<=Number_grants; I++){			
Reservation_ID	16	2	
		2	
Grant_slot_count	4		15-12
Remaining_slot_count	5		11-7
Grant_control	2		6-5
Grant_slot_offset	5		4-0
}			
}			

Reference_slot

Reference_slot is a 16-bit unsigned number indicating the reference point for the remaining parameters of this message. This represents a physical slot of the upstream channel. Since the upstream and downstream slots are not aligned, the INA shall send this message in a downstream slot such that it is received by the NIU before the Reference_slot exists on the upstream channel.

Number_grants

Number_grants is an 8-bit unsigned number representing the number of grants contained within this message. This can either correspond to grants for different NIUs, or to different connection_IDs for the same NIU.

Reservation_ID

Reservation_ID is a 16-bit unsigned number representing a locally assigned identifier for the connection. This is used as a short identifier by the NIU to identify the appropriate Reservation_Grant_Messages.

Grant_slot_count

`Grant_slot_count` is a 4-bit unsigned number representing the number of sequential slots currently granted for the upstream burst. Upon receipt of this message, the NIU is assigned `Grant_slot_count` sequential slots in the reservation access region of the upstream channel starting at the position indicated by the `Reference_slot` and `Grant_slot_offset` values (jumps are needed in the case where the number of slots granted exceeds the length of the reservation access region). A value of zero indicates that no slots are being granted. This would typically be the case in a response to a `Reservation_status_request` message.

Remaining_slot_count

`Remaining_slot_count` is a 5-bit unsigned number representing the remaining slots to be granted by the INA with subsequent grant messages. A value of 0x1f indicates that 31 or more slots will be made available in the future. A value of 0x0 indicates that no additional slots will be granted in the future and that the slots granted in this message represent the only remaining slots available for the connection. The NIU should monitor this count to determine if sufficient slots remain to satisfy current needs. Should additional slots be required because of lost grant messages or additional demand, additional slots should be requested using the `Reservation_request_message`. Additional `Reservation_request_messages` shall be sent only when the `Remaining_slot_count` is less than 15. To minimize contention on the upstream channel, the `Reservation_request_message` may be sent in one of the slots granted by the `Reservation_grant_message`.

Grant_Control

`Grant_Control` is a 2-bit unsigned number coded as 0 (reserved for future use).

Grant_slot_offset

`Grant_slot_offset` is a 5-bit unsigned number representing the starting slot to be used for the upstream burst. This number is added to the `Reference_slot` to determine the actual physical slot. Upon receipt of this message, the NIU is assigned `Grant_slot_count` sequential slots in the reservation access region of the upstream channel.

<MAC> Reservation Status Request (upstream contention, contention or reserved)

The <MAC> RESERVATION STATUS REQUEST Message is used to determine the status of the outstanding grants to be assigned by the INA. This message is only sent after the Grant protocol time-out is exceeded. The INA will respond with the `Reservation_grant_message` (possibly without granting any slots) to inform the NIU of any remaining slots left to be granted. This allows the NIU to correct any problems, should they exist, such as issuing an additional request for slots or waiting patiently for additional grants.

The format of the message is given in Table A.34.

Table A.34/J.112 – Reservation status request message structure

	Bits	Bytes	Bit number/ Description
<code>Reservation_Status_Request_Message () {</code>			
<code> Reservation_ID</code>	16	2	
<code> Remaining_request_slot_count</code>	8	1	
<code>}</code>			

Reservation_ID

`Reservation_ID` is a 16-bit unsigned number representing a locally assigned identifier for the connection. This is used as a short identifier by the NIU to identify the appropriate `Reservation_Grant_Messages`.

Remaining_request_slot_count

Remaining_request_slot_count is an 8-bit unsigned number representing the number of slots that the NIU is expecting to be granted.

A.5.5.7 MAC Link Management

The MAC Link Management tasks provide continuous monitoring and optimization of upstream resources. These functions include:

- Power and Timing Management;
- Fixed rate Allocation Management;
- Channel Error Management.

A.5.5.7.1 Power and Timing Management

Power and Timing Management shall provide continuous monitoring of upstream transmission from the NIU. The <MAC> **Ranging and Power Calibration Message** is used to maintain a NIU within predefined thresholds of power and time.

The Upstream Burst Demodulator shall continuously monitor the upstream burst transmissions from an NIU. Upon detection of an NIU outside the predefined range, the INA shall send the <MAC> **Ranging and Power Calibration Message** to the NIU.

A.5.5.7.2 TDMA Allocation Management

To ensure optimum assignment of TDMA resources, the INA shall ensure the upstream allocation of TDMA resources for various connections remain intact when allocating resources to a new connection. However, in the event that reconfiguration is required to minimize fragmentation of resources, then the INA shall dynamically reconfigure the upstream TDMA assignments to a NIU or group of NIUs. The <MAC> **Reprovision Message** is utilized to change previously established connection parameters.

<MAC> Reprovision Message (singlecast downstream)

The <MAC> REPROVISION MESSAGE is sent by the INA to the NIU to reassign upstream resources (maintaining the originally requested QOS parameters at the establishment of the connection.) This message is intended for Fixed rate based channel maintenance by the INA to redistribute or reassign resources allocated to a NIU (see Table A.35).

Table A.35/J.112 – Reprovision message structure

	Bits	Bytes	Bit number/ Description
Reprovision_Message () {			
Reprovision_Control_Field	8	1	
<i>Reserved</i>	2		7-6
New_Downstream_IB_Frequency	1		5: {no, yes}
New_Downstream_OOB_Frequency	1		4: {no, yes}
New_Upstream_Frequency_Included	1		3: {no, yes}
New_Frame_Length_Included	1		2: {no, yes}
New_Cyclical_Assignment_Included	1		1: {no, yes}
New_Slot_List_Included	1		0: {no, yes}
<i>if (Reprovision_Control_Field & = New_Downstream_IB_Frequency) {</i>			

Table A.35/J.112 – Reprovision message structure (end)

	Bits	Bytes	Bit number/ Description
New_Downstream_IB_Frequency }	(32)	(4)	
<i>if (Reprovision_Control_Field & = New_Downstream_OOB_Frequency) {</i>			
New_Downstream_OOB_Frequency	(32)	(4)	
DownStream_Type }	8	1	
<i>if (Reprovision_Control_Field & = New_Frequency_Included) {</i>			
New_Upstream_Frequency	(32)	(4)	
New Upstream Parameters		(2)	
New_Upstream_Channel_Number	3		7:5
reserved	2		4:3
Upstream_Rate	3		2:0:enum
MAC_Flag_Set	5		7:3
Reserved}	3		2:0
<i>if (Connection_Control_Field & = New_Frame_Length_Included){</i>			
New_Frame_Length }	(16)	(2)	9-0: Unsigned
<i>if (Reprovision_Control_Field & = New_Slot_List_Included New_Cyclical_Assignment_Included){</i>			
Number_of_Connections	(8)	(1)	
<i>for(i=0;i<Number_of_Connections;i++){</i>			
Connection_ID	(32)	(1)	
<i>if (Reprovision_Control_Field & = new_slot_list_included){</i>			Fixed Rate Access
Number_Slots_Defined	(8)	(1)	
<i>for(i=0;i<Number_Slots_Assigned;i++){</i>			
Slot_Number	(16)	(2)	
<i>}}</i>			
<i>if (Reprovision_Control_Field == new_cyclic_Assignment_included){</i>			Fixed Rate Access
Fixedrate_Start	(16)	(2)	
Fixedrate_Dist	(16)	(2)	
Fixedrate_End	(16)	(2)	
<i>}}}}</i>			

Reprovision Control Field

Reprovision_Control_Field specifies what modifications to upstream resources are included.

New Downstream OOB Frequency

New_Upstream_OOB_Frequency is a boolean that indicates that a new downstream OOB frequency is specified in the message.

New Downstream IB Frequency

New_Upstream_IB_Frequency is a boolean that indicates that a new downstream IB frequency is specified in the message.

New Upstream Frequency Included

New_Upstream_Frequency_Included is a boolean that indicates that a new upstream frequency is specified in the message.

New Frame Length Included

New_Frame_Length_Included is a boolean that indicates that a new upstream frame is specified in the message.

New Slot List Included

New_Slot_List_Included is a boolean that indicates that a new slot list is specified in the message.

New Cyclical Assignment Included

New_Cyclical_Assignment_Included is a boolean that indicates that a new cyclical assignment is specified in the message.

New Downstream IB Frequency

New_Downstream_IB_Frequency is a 32-bit unsigned integer representing the reassigned downstream IB carrier center frequency. The unit of measure is Hz.

New Downstream OOB Frequency

New_Downstream_OOB_Frequency is a 32-bit unsigned integer representing the reassigned downstream OOB carrier center frequency. The unit of measure is Hz.

DownStream_Type is an 8-bit enumerated type indicating the modulation format for the down stream connection. { reserved, QPSK_1.544, QPSK_3.088, 3..255 reserved }

New Upstream Frequency

New_Upstream_Frequency is a 32-bit unsigned integer representing the reassigned upstream carrier center frequency. The unit of measure is Hz.

UpstreamStream_Rate is a 3-bit enumerated type indicating the data rate for the upstream connection. { Upstream_256K, Upstream_1.544M, Upstream_3.088M, 3..7 reserved }

MAC_Flag_Set is a 5-bit field representing the MAC Flag set assigned to the connection. In the OOB downstream timing, the eight sets of flags are assigned the numbers 1-8. In the IB downstream timing, the 16 sets of flags are assigned the numbers 1-16. In the case of a 3.088 Mbit upstream channel, this parameter represents the first of two successively assigned flag sets.

New Frame Length

New_Frame_Length is a 16-bit unsigned integer representing the size of the reassigned upstream Fixed rate based frame. The unit of measure is in slots.

Number of Slots Defined

Number_Slots_Defined is an 8-bit unsigned integer that represents the number of slot assignments contained in the message. The unit of measure is slots.

Slot Number

Slot_Number is a 16-bit unsigned integer that represents the Fixed rate based Slot Number assigned to the Network Interface Unit.

A.5.5.7.3 Channel Error Management

During periods of connection inactivity, the NIU shall enter an Idle Mode. Idle Mode is characterized by periodic transmission by the NIU of a <MAC> **Idle Message**. The Idle Mode transmission shall occur at a periodic rate sufficient for the INA to establish Packet Error Rate statistics.

<MAC> Idle Message (upstream contention or reserved)

The <MAC> **Idle Message** is sent by the NIU within the STB to the INA at predefined intervals (between 1 and 10 minutes) when upstream connection buffers are empty (see Table A.36).

Table A.36/J.112 – Idle message structure

	Bits	Bytes	Bit number/ Description
<pre>Idle_Message(){ Idle_Sequence_Count Power_Control_Setting }</pre>	8	1	
	8	1	

Idle Sequence Count

Idle_Sequence_Count is an 8-bit unsigned integer representing the count of <MAC> IDLE MESSAGES transmitted while the NIU is Idle.

Power Control Setting

Power_Control_Setting is an 8-bit unsigned integer representing the absolute power attenuation that the NIU is using for upstream transmission.

A.5.5.7.4 Link management messages

<MAC> Transmission Control Message (singlecast or broadcast downstream)

The <MAC> TRANSMISSION CONTROL MESSAGE is sent to the NIU from the INA to control several aspects of the upstream transmission. This includes stopping upstream transmission, re-enabling transmission from a NIU or group of NIU's and rapidly changing the upstream frequency being used by a NIU or group of NIU's. To identify a group of NIU's for switching frequencies, the <MAC> TRANSMISSION CONTROL MESSAGE is sent in broadcast mode with the Old_Frequency included in the message. When broadcast with the Old_Frequency, the NIU shall compare its current frequency value to Old_Frequency. When equal, the NIU shall switch to the new frequency specified in the message. When unequal, the NIU shall ignore the new frequency and remain on its current channel (see Table A.37).

Table A.37/J.112 – Transmission Control message structure

	Bits	Bytes	Bit number/ Description
Transmission_Control_Message(){			
Transmission_Control_Field	8		
reserved	3		7-5:
Stop_Upstream_Transmission	1		4: {no, yes}
Start_Upstream_Transmission	1		3: {no, yes}
Old_Frequency_Included	1		2: {no, yes}
Switch_Downstream_OOB_Frequency	1		1: {no, yes}
Switch_Upstream_Frequency	1		0: {no, yes}
if (Transmission_Control_Field== Switch_Upstream_Frequency && Old_Frequency_Included){			
Old_Upstream_Frequency	(32)	(4)	
}			
if (Transmission_Control_Field== Switch_Upstream_Frequency){			
New_Upstream_Frequency	(32)	(4)	
New_Upstream_Channel_Number	3	1	7:5
reserved	2		4:3
Upstream_Rate	3		2:0
MAC_Flag_Set	5	1	7:3
Reserved	3		2:0
New_Upstream_Frequency	(32)	(4)	
}			
if (Transmission_Control_Field== Switch_Downstream_OOB_Frequency && Old_Frequency_Included){			
Old_Downstream_OOB_Frequency	(32)	(4)	
}			
if (Transmission_Control_Field== Switch_Downstream_OOB_Frequency){			
New_Downstream_OOB_Frequency	(32)	(4)	
DownStream_Type	8	1	
}			
}			

Transmission Control Field

`Transmission_Control_Field` specifies the control being asserted on the upstream channel.

Stop Upstream Transmission

`stop_upstream_transmission` is a boolean when set indicates that the NIU should halt its upstream transmission.

Start Upstream Transmission

`start_upstream_transmission` is a boolean when set indicates that the Network Interface Unit should resume transmission on its upstream channel. The NIU shall respond to the ranging and power calibration message regardless of the setting of the `start_upstream_transmission` bit.

Old Frequency Included

`Old_Frequency_Included` is a boolean when set indicates that the Old Frequency value is included in the message and should be used to determine if a switch in frequency is necessary.

Switch Downstream OOB Frequency

`switch_downstream_OOB_frequency` is a boolean when set indicates that a new downstream OOB frequency is included in the message.

Switch Upstream Frequency

`switch_upstream_frequency` is a boolean when set indicates that a new upstream frequency is included in the message. Typically, the `switch_upstream_frequency` and the `stop_upstream_transmission` are set simultaneously to allow the NIU to stop transmission and change channel. This would be followed by the <MAC> TRANSMISSION CONTROL MESSAGE with the `start_upstream_transmission` bit set.

Old Upstream Frequency

`Old_Upstream_Frequency` is a 32-bit unsigned integer representing the frequency that should be used by the NIU to compare with its current frequency to determine if a change in channel is required.

New Upstream Frequency

`New_Upstream_Frequency` is a 32-bit unsigned integer representing the reassigned upstream carrier center frequency. The unit of measure is Hz.

`MAC_Flag_Set` is a 5-bit field representing the MAC Flag set assigned to the connection. In the OOB downstream timing, the eight sets of flags are assigned the numbers 1-8. In the IB downstream timing, the 16 sets of flags are assigned the numbers 1-16. In the case of a 3.088 Mbit upstream channel, this parameter represents the first of two successively assigned flag sets.

`UpstreamStream_Rate` is a 3-bit enumerated type indicating the data rate for the upstream connection. {Upstream_256K, Upstream_1.544M, Upstream_3.088M, 3..7 reserved}

Old Downstream OOB Frequency

`Old_Downstream_OOB_Frequency` is a 32-bit unsigned integer representing the frequency that should be used by the NIU to compare with its current frequency to determine if a change in channel is required.

New Downstream OOB Frequency

`New_Downstream_OOB_Frequency` is a 32-bit unsigned integer representing the reassigned downstream OOB carrier centre frequency. The unit of measure is Hz.

`DownStream_Type` is an 8-bit enumerated type indicating the modulation format for the down stream connection. {reserved, QPSK_1.544, QPSK_3.088, 3..255 reserved}

Link Management Response Message (upstream contention, contention or reserved)

The <MAC> LINK MANAGEMENT RESPONSE MESSAGE is sent by the NIU to the INA to indicate reception and processing of the previously sent Link Management Message. The format of the message is shown in Table A.38.

Table A.38/J.112 – Link Management Acknowledge message format

	Bits	Bytes	Bit number/ Description
Link_Management_Acknowledge() {			
Link_Management_Msg_Number	16	2	
}			

Link Management Message Number

Link_Management_Msg_Number is a 16-bit unsigned integer representing the previously received link management message. The valid values for Link_Management_Msg_Number are shown in Table A.39.

Table A.39/J.112 – Link Management message number

Message Name	Link_Management_Msg_Number
Transmission Control Message	Transmission Control Message Type Value
Reprovision Message	Reprovision Message Type Value

<MAC> Status Request Message (downstream singlecast)

The STATUS REQUEST message is sent by the INA to the NIU to retrieve information about the NIU’s health, connection information and error states. The INA can request either the address parameters, error information, connection parameters or physical layer parameters from the NIU. The INA can only request one parameter type at a time to a particular NIU (see Table A.40).

Table A.40/J.112 – Status Request message structure

	Bits	Bytes	Bit number/ Description
Status_Request() {			
Status_Control_Field	8	1	
<i>reserved</i>	5		3-7:
Status_Type	3		0-2: {enum type}
}			

Status Control Field

Status_Control_Field is a 3-bit enumerated type that indicates the status information the NIU should return.

```
enum Status_Control_Field { Address_Params, Error_Params,
Connection_Params, Physical_Layer_Params, reserved 4..7};
```

<MAC> Status Response Message (Upstream Contention, contention or reserved)

The <MAC> STATUS RESPONSE MESSAGE is sent by the NIU in response to the <MAC> STATUS REQUEST MESSAGE issued by the INA. The contents of the information provided in this message will vary depending on the request made by the INA and the state of the NIU. The message must be dissociated into separate messages if the resulting length of the message exceeds 40 bytes (see Table A.41).

Table A.41/J.112 – Status Response message structure

	Bits	Bytes	Bit number/ Description
Status_Response(){			
NIU_Status	32	4	
Response_Fields_Included	8	1	
reserved	4		4-7:
Address_Params_Included	1		3:{no, yes}
Error_Information_Included	1		2:{no, yes}
Connection_Params_Included	1		1:{no, yes}
Physical_Layer_Params_Included	1		0:{no, yes}
<i>if (Response_Fields_Included == Address_Params_Included){</i>			
NSAP_Address	(160)	(20)	
MAC_Address	(48)	(6)	
}			
<i>if (Response_Fields_Included == Error_Information_Included){</i>			
Number_Error_Codes_Included	(8)	(1)	
<i>for(i=0;i<Number_Error_Codes_Included; i++){</i>			
Error_Param_code	(8)	(1)	
Error_Param_Value	(16)	(2)	
}			
}			
<i>if (Response_Fields_Included == Connection_Params_Included) {</i>			
Number_of_Connections	(8)	(1)	
<i>for(i=0;i<Number_of_Connections;i++){</i>			
Connection_ID	(32)	(4)	
}}			
<i>if (Response_Fields_Included == Physical_Layer_Params_Included) {</i>			
Power_Control_Setting	(8)	(1)	
Time_Offset_Value	(32)	(4)	
Upstream_Frequency	(32)	(4)	
Downstream_Frequency	(32)	(4)	
}			
}			

NIU Status

NIU_Status is a 32-bit unsigned integer that indicates the current state of the NIU.

```

NIU_Status { Calibration_Operation_Complete,
Default_Connection_Established,
Network_Address_Registered,
,reserved};

```

Response Fields Included

Response_Fields_Included is an 8-bit unsigned integer that indicates what parameters are contained in the upstream status response.

NSAP Address

NSAP_Address is a 20-byte address assigned to the NIU.

MAC Address

MAC_Address is a 6-byte address assigned to the NIU.

Number of Error Codes Included

Number_Error_Codes_Included is an 8-bit unsigned integer that indicates the number of error codes are contained in the response.

Error Parameter Code

Error_Parameter_Code is an 8-bit unsigned integers representing the type of error reported by the NIU (see Table A.42).

Table A.42/J.112 – Error parameter code

Error Parameter Code Name	Error Parameter Code
Framing_Bit_Error_Count	0x00
Slot_Configuration_CRC_Error_Count	0x01
Reed_Solomon_Error_Count	0x02
ATM_Packet_Loss_Count	0x03

Error Parameter Value

Error_Parameter_Value is a 16-bit unsigned integers representing error counts detected by the NIU.

Number of Connections

Number_of_Connections is an 8-bit unsigned integer that indicates the number of connections that are specified in the response. Specifically, if the number of connections is too large to have a MAC message with less than 40 bytes, it is possible to send separate messages with only the number of connections indicated in each message.

ConnectionID

Connection_ID is a 32-bit unsigned integer representing the global connection Identifier used by the NIU for this connection.

Power Control Setting

`Power_Control_Setting` is an 8-bit unsigned integer representing the absolute power attenuation that the NIU is using for upstream transmission.

Time Offset Value

`Time_Offset_Value` is a 16-bit short integer representing a relative offset of the upstream transmission timing. A negative value indicates an adjustment forward in time. A positive value indicates an adjustment back in time. The unit of measure is 100 ns.

Upstream Frequency

`Upstream_Frequency` is a 32-bit unsigned integer representing the channel assigned to the connection. The unit of measure is in Hz.

Downstream Frequency

`Downstream_Frequency` is a 32-bit unsigned integer representing the Frequency where the connection resides. The unit of measure is in Hz.

Annex B

Data-over-cable radio frequency interface

B.1 Scope and purpose

B.1.1 Scope

This annex is derived from radio-frequency interface specifications for high-speed data-over-cable systems that have been developed in North America.

B.1.2 Requirements

Throughout this Recommendation, the words that are used to define the significance of particular requirements are capitalized. These words are:

- "MUST" This word or the adjective "REQUIRED" means that the item is an absolute requirement of this specification.
- "MUST NOT" This phrase means that the item is an absolute prohibition of this specification.
- "SHOULD" This word or the adjective "RECOMMENDED" means that there may exist valid reasons in particular circumstances to ignore this item, but the full implications should be understood and the case carefully weighed before choosing a different course.
- "SHOULD NOT" This phrase means that there may exist valid reasons in particular circumstances when the listed behaviour is acceptable or even useful, but the full implications should be understood and the case carefully weighed before implementing any behaviour described with this label.
- "MAY" This word or the adjective "OPTIONAL" means that this item is truly optional. One vendor may choose to include the item because a particular marketplace requires it or because it enhances the product, for example, another vendor may omit the same item.

Other text is descriptive or explanatory.

B.1.3 Background

B.1.3.1 Service goals

Cable operators are interested in deploying high-speed data communications systems on cable television systems. Thus, it has been decided to prepare a series of interface specifications that will permit the early definition, design, development and deployment of data-over-cable systems on an uniform, consistent, open, non-proprietary, multi-vendor interoperable basis.

The intended service will allow transparent bi-directional transfer of Internet Protocol (IP) traffic, between the cable system headend and customer locations, over an all-coaxial or Hybrid-Fiber/Coax (HFC) cable network. This is shown in simplified form in Figure B.1-1.

The transmission path over the cable system is realized at the headend by a Cable Modem Termination System (CMTS), and at each customer location by a Cable Modem (CM). At the headend (or hub), the interface to the data-over-cable system is called the Cable Modem Termination System – Network-Side Interface (CMTS-NSI) and is specified in [MCNS3]. At the customer locations, the interface is called the cable-modem-to-customer-premises-equipment interface (CMCI) and is specified in [MCNS4]. The intent is for the MCNS operators to transparently transfer IP traffic between these interfaces, including but not limited to datagrams, DHCP, ICMP, and IP Group addressing (broadcast and multicast).

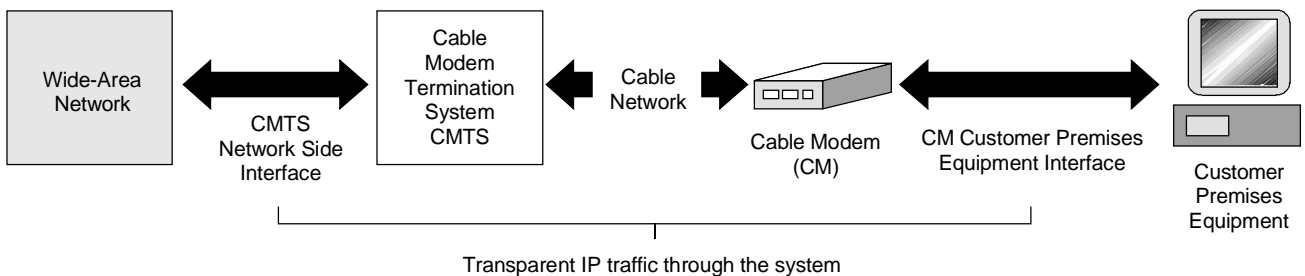

T0904770-97/d044

Figure B.1-1/J.112 – Transparent IP traffic through the data-over-cable system

B.1.3.2 Reference architecture

The reference architecture for the data-over-cable services and interfaces is shown in Figure B.1-2.

B.1.3.2.1 Categories of interface specification

The basic reference architecture of Figure B.1-2 involves three categories of interface. These have been developed in phases:

a) Phase 1

Data Interfaces – These are the CMCI [MCNS4] and CMTS-NSI [MCNS3], corresponding respectively to the cable-modem-to-Customer-Premises-Equipment (CPE) interface (for example, between the customer's computer and the cable modem), and the cable modem termination system network-side interface between the cable modem termination system and the data network.

b) Phase 2

Operations Support Systems Interfaces – These are network element management layer interfaces between the network elements and the high-level Operations Support Systems (OSSs) which support the basic business processes, and are documented in [MCNS5].

Telephone Return Interface – CMTRI – This is the interface between the cable modem and a telephone return path, for use in cases where the return path is not provided or not available via the cable network, and is documented in [MCNS6].

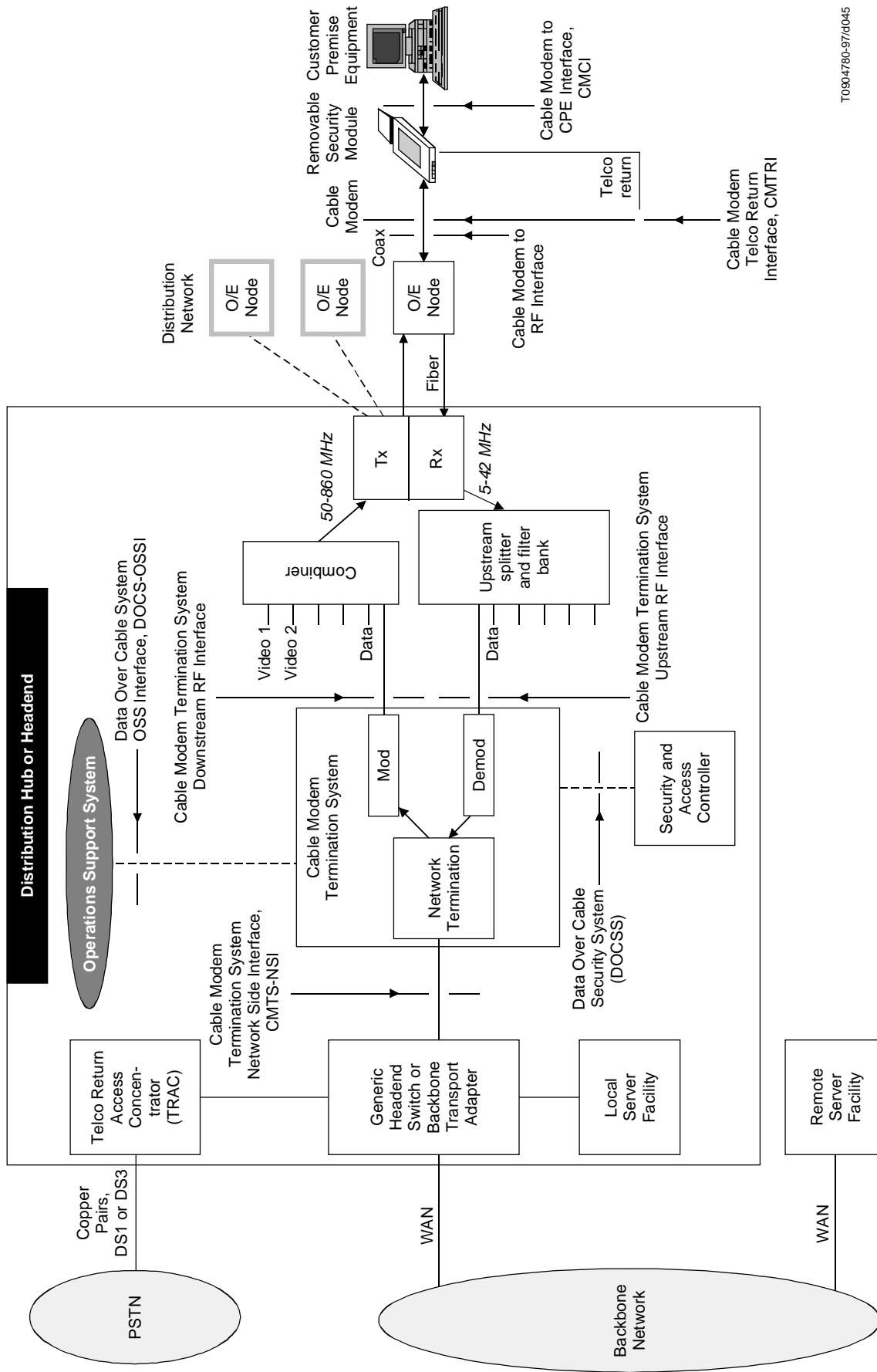

T0904780-97/d045

Figure B.1-2/J.112 – Data-over-cable reference architecture

c) **Phase 3**

RF Interfaces – The RF interfaces defined in this Recommendation are the following:

- between the cable modem and the cable network;
- between the CMTS and the cable network, in the downstream direction (traffic toward the customer);
- between the CMTS and the cable network, in the upstream direction (traffic from the customer).

Security requirements

- the Data Over Cable Security System (DOCSS) is defined in [MCNS2];
- the CM Removable Security Module (RSM) is defined in [MCNS7];
- Baseline data-over-cable security is defined in [MCNS8].

B.1.3.2.2 Data-Over-Cable Interface Documents

A list of the documents in the Data-Over-Cable Interface Specifications family is provided below. For updates, please refer to URL <http://www.cablemodem.com>.

Designation	Title
SP-CMCI	Cable Modem to Customer Premises Equipment Interface Specification
SP-CMTS-NSI	Cable Modem Termination System Network Side Interface Specification
SP-CMTRI	Cable Modem Telco Return Interface Specification
SP-OSSI	Operations Support System Interface Specification
SP-RFI	Radio Frequency Interface Specification
SP-DOCSS	Data Over Cable Security System (DOCSS) Specification
SP-RSM	Removable Security Module Specification
SP-BDS	Baseline Data-Over-Cable Security Specification
SP	Specification
TR	Technical Report (provides a context for understanding and applying the specification – documents of this type may be issued in the future.)

B.1.3.3 Server location

This annex refers to several servers which are central to the system operation (e.g. provision and security servers).

The message sequence charts used as examples within this annex show sample message exchanges in which access to the servers is via the CMTS. It is important to note that access to these servers need not necessarily be via the CMTS, but MAY be via any CM suitably configured. In this case, the scenarios become slightly more complex, as the message flows are as shown in Figure B.1-3. Allowing placement of these components to be at locations other than the CMTS allows the system operator the maximum flexibility in server placement and network configuration. Note that the CMTS MUST be able to initialize without access to the servers in Figure B.1-3.

B.2 Functional assumptions

This subclause describes the characteristics of cable television plant to be assumed for the purposes of operation of the data-over-cable system. It is not a description of CMTS or CM parameters. The data-over-cable system MUST operate satisfactorily in the environment described in this subclause.

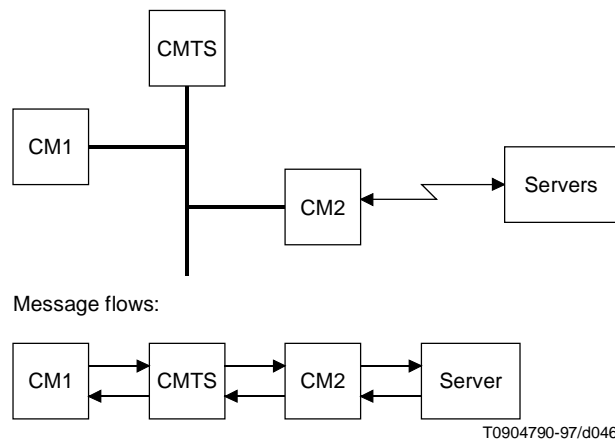

Figure B.1-3/J.112 – Server location not at CMTS

B.2.1 Broadband access network

A coaxial-based broadband access network is assumed. This may take the form of either an all-coax or Hybrid-Fiber/Coax (HFC) network. The generic term "cable network" is used here to cover all cases.

A cable network uses a shared-medium, tree-and-branch architecture with analogue transmission. The key functional characteristics assumed in this annex are the following:

- Two-way transmission.
- A maximum optical/electrical spacing between the CMTS and the most distant customer terminal of 100 miles, although typical maximum separation may be 10-15 miles.
- A maximum differential optical/electrical spacing between the CMTS and the closest and most distant modems of 100 miles, although this would typically be limited to 15 miles.

B.2.2 Equipment assumptions

B.2.2.1 Frequency plan

In the downstream direction, the cable system is assumed to have a passband with a lower edge at 50 or 54 MHz and an upper edge which is implementation-dependent but is typically in the range of 300 to 860 MHz. Within that passband, NTSC analogue television signals in 6 MHz channels are assumed to be present on the standard, HRC or IRC frequency plans of EIA Interim Standard IS-6, as well as other narrowband and wideband digital signals.

In the upstream direction, the cable system may have a subsplit (5-30 MHz) or extended subsplit (5-42 MHz) passband. NTSC analogue television signals in 6-MHz channels may be present, as well as other signals.

B.2.2.2 Compatibility with other services

The CM and CMTS MUST coexist with the other services on the cable network. In particular:

- they MUST operate satisfactorily in cable spectrum assigned for CMTS-CM interoperability while the balance of the cable spectrum is occupied by any combination of television and other signals; and
- they MUST NOT cause harmful interference to any other services that are assigned to the cable network in spectrum outside of that allocated to the CMTS.

B.2.2.3 Fault isolation impact on other users

As the data-over-cable system is a shared-media, point-to-multipoint system, fault-isolation procedures MUST take into account the potential harmful impact of faults and fault-isolation procedures on numerous users of the data-over-cable and other services.

B.2.3 RF channel assumptions

The data-over-cable system, configured with at least one set of defined physical-layer parameters (e.g. modulation, forward error correction, symbol rate, etc.) from the range of configuration settings described in this specification, must be capable of operating with a 1500-byte packet loss rate of less than one percent while forwarding at least 100 packets per second on cable networks having characteristics defined in B.2.3.

B.2.3.1 Transmission downstream

The RF channel transmission characteristics of the cable network in the downstream direction assumed for the purposes of minimal operating capability are described in Table B.2-1. This assumes nominal analogue video carrier level (peak envelope power) in a 6 MHz channel bandwidth. All conditions are present concurrently.

Table B.2-1/J.112 – Assumed downstream RF channel transmission characteristics

Parameter	Value
Frequency range	Cable system normal downstream operating range is from 50 MHz to as high as 860 MHz. However, the values in this table apply only at frequencies \geq 88 MHz.
RF channel spacing (design bandwidth)	6 MHz
Transit delay from headend to most distant customer	\leq 0.800 ms (typically much less)
Carrier-to-noise ratio in a 6 MHz band (analogue video level)	Not less than 35 dB (Note 4)
Carrier-to-interference ratio for total power (discrete and broadband ingress signals)	Not less than 35 dB within the design bandwidth
Composite triple beat distortion for analogue modulated carriers	Not greater than -50 dBc within the design bandwidth
Composite second order distortion for analogue modulated carriers	Not greater than -50 dBc within the design bandwidth
Cross-modulation level	Not greater than -40 dBc within the design bandwidth
Amplitude ripple	0.5 dB within the design bandwidth
Group delay ripple in the spectrum occupied by the CMTS	75 ns within the design bandwidth
Micro-reflections bound for dominant echo	-10 dBc @ \leq 0.5 μ s, -15 dBc @ \leq 1.0 μ s -20 dBc @ \leq 1.5 μ s, -30 dBc @ $>$ 1.5 μ s
Carrier hum modulation	Not greater than -26 dBc (5%)
Burst noise	Not longer than 25 μ s at a 10 Hz average rate
Seasonal and diurnal signal level variation	8 dB
Signal level slope, 50-750 MHz	16 dB
Maximum analogue video carrier level at the CM input, inclusive of above signal level variation	17 dBmV
Lowest analogue video carrier level at the CM input, inclusive of above signal level variation	-5 dBmV
<p>NOTE 1 – Transmission is from the headend combiner to the CM input at the customer location.</p> <p>NOTE 2 – For measurements above, the normal downstream operating frequency band (except hum), impairments are referenced to the highest-frequency NTSC carrier level.</p> <p>NOTE 3 – For hum measurements above, the normal downstream operating frequency band, a continuous-wave carrier is sent at the test frequency at the same level as the highest-frequency NTSC carrier.</p> <p>NOTE 4 – This presumes that the digital carrier is operated at analogue peak carrier level. When the digital carrier is operated below the analogue peak carrier level, this C/N may be less.</p> <p>NOTE 5 – Measurement methods defined in [NCTA] or [CableLabs2].</p>	

B.2.3.2 Transmission upstream

The RF channel transmission characteristics of the cable network in the upstream direction assumed for the purposes of minimal operating capability are described in Table B.2-2. All conditions are present concurrently.

Table B.2-2/J.112 – Assumed upstream RF channel transmission characteristics

Parameter	Value
Frequency range	5 to 42 MHz edge to edge
Transit delay from the most distant CM to the nearest CM or CMTS	≤ 0.800 ms (typically much less)
Carrier-to-noise ratio	Not less than 25 dB
Carrier-to-ingress power (the sum of discrete and broadband ingress signals) ratio	Not less than 25 dB (Note 2)
Carrier-to-interference (the sum of noise, distortion, common-path distortion and cross-modulation) ratio	Not less than 25 dB
Carrier hum modulation	Not greater than –23 dBc (7.0 %)
Burst noise	Not longer than 10 μs at a 1 kHz average rate for most cases (Notes 3, 4 and 5)
Amplitude ripple	5-42 MHz: 0.5 dB/MHz
Group delay ripple	5-42 MHz: 200 ns/MHz
Micro-reflections – Single echo	–10 dBc @ ≤ 0.5 μs –20 dBc @ ≤ 1.0 μs –30 dBc @ > 1.0 μs
Seasonal and diurnal signal level variation	Not greater than 8 dB min to max
NOTE 1 – Transmission is from the CM output at the customer location to the headend. NOTE 2 – Ingress avoidance or tolerance techniques MAY be used to ensure operation in the presence of time-varying discrete ingress signals that could be as high as 0 dBc [CableLabs1]. NOTE 3 – Amplitude and frequency characteristics sufficiently strong to partially or wholly mask the data carrier. NOTE 4 – CableLabs report containing distribution of return-path burst noise measurements and measurement method is forthcoming. NOTE 5 – Impulse noise levels more prevalent at lower frequencies (<15 MHz).	

B.2.3.2.1 Availability

Typical cable network availability is considerably greater than 99 %.

B.2.4 Transmission levels

The nominal power level of the downstream CMTS 64 QAM signal(s) within a 6 MHz channel is targeted to be in the range –10 dBc to –6 dBc relative to analogue video carrier level and will normally not exceed analogue video carrier level. The nominal power level of the upstream CM signal(s) will be as low as possible to achieve the required margin above noise and interference. Uniform power loading per unit bandwidth is commonly followed in setting upstream signal levels, with specific levels established by the cable network operator to achieve the required carrier-to-noise and carrier-to-interference ratios.

B.2.5 Frequency inversion

There will be no frequency inversion in the transmission path in either the downstream or upstream directions, i.e. a positive change in frequency at the input to the cable network will result in a positive change in frequency at the output.

B.3 Communication protocols

This subclause provides a high-level overview of the communication protocols that **MUST** be used in the data-over-cable system. Detailed specifications for the physical media dependent, downstream transmission, and media access control sublayers are provided in B.4, B.5, and B.6, respectively.

B.3.1 Protocol stack

The CM and CMTS operate as forwarding agents and also as end-systems (hosts). The protocol stacks used in these modes differ as shown below.

The principal function of the cable modem system is to transmit Internet Protocol (IP) packets transparently between the headend and the subscriber location. Certain management functions also ride on IP, so that the protocol stack on the cable network is as shown in Figure B.3-1 (this does not restrict the generality of IP transparency between the headend and the customer). These management functions include, for example, supporting spectrum management functions and the downloading of software.

B.3.1.1 CM and CMTS as hosts

CMs and CMTSs will operate as IP and LLC hosts in terms of IEEE Standard 802 [IEEE 802] for communication over the cable network. The protocol stack at the CM and CMTS RF interfaces is shown in Figure B.3-1.

The CM and CMTS **MUST** function as IP hosts. As such, the CM and CMTS **MUST** support IP and ARP over DIX link-layer framing (see [DIX]). The CM and CMTS **MAY** also support IP and ARP over SNAP framing [RFC-1042].

The CM and CMTS also **MUST** function as LLC hosts. As such, the CM and CMTS **MUST** respond appropriately to TEST and XID requests per [ISO/IEC 8802-2].

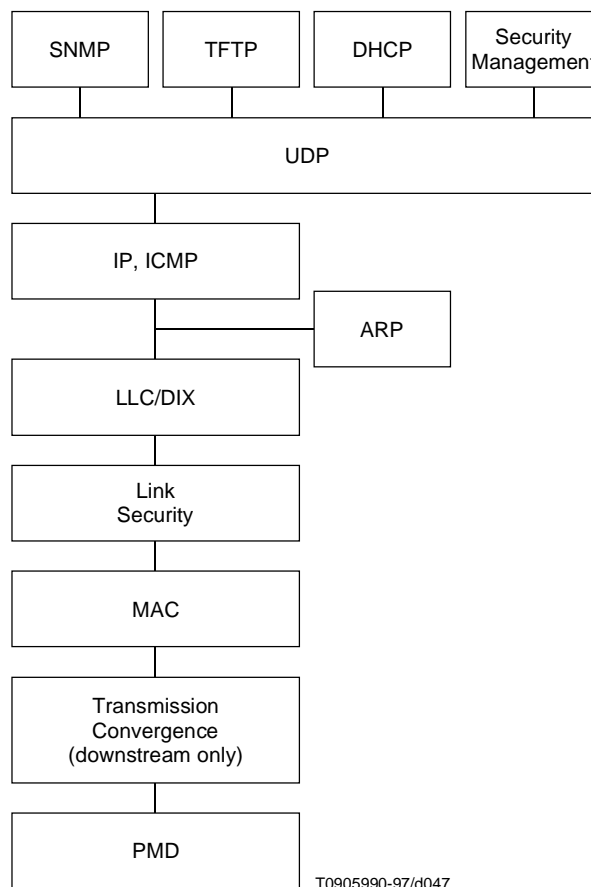

Figure B.3-1/J.112 – Protocol stack on the RF interface

B.3.1.2 Data forwarding through the CM and CMTS

B.3.1.2.1 General

Data forwarding through the CMTS MAY be transparent bridging, or MAY employ network-layer forwarding (routing, IP switching) as shown in Figure B.3-2.

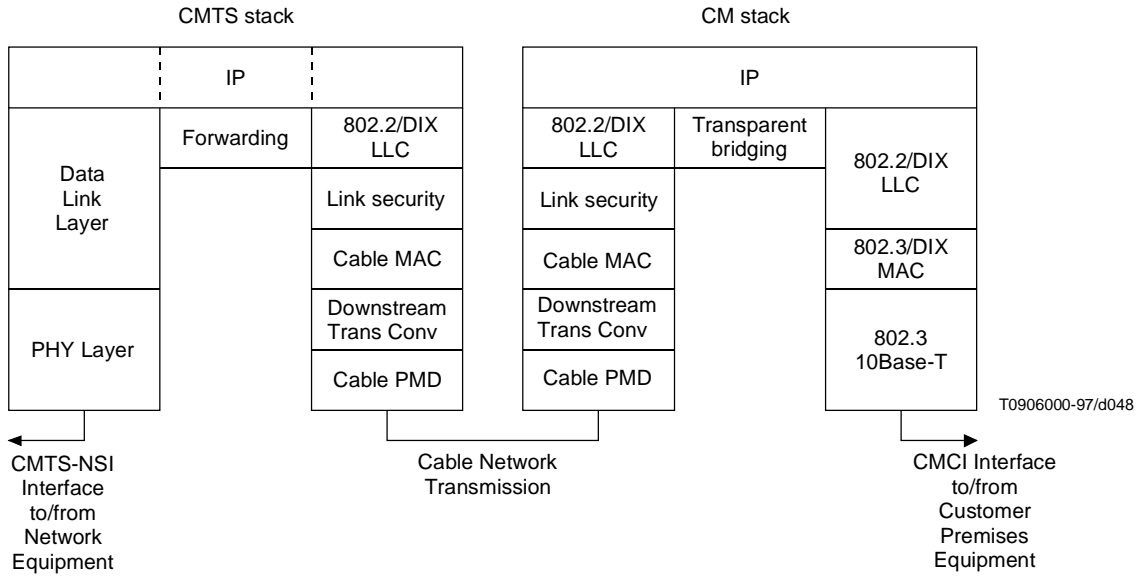

Figure B.3-2/J.112 – Data forwarding through the CM and CMTS

Data forwarding through the CM is link-layer transparent bridging, as shown in Figure B.3-2. Forwarding rules are similar to [ISO/IEC 10038] with the modifications described in B.3.1.2.2 and B.3.1.2.3. This allows the support of multiple network layers.

Forwarding of IP traffic **MUST** be supported. Support of other network layer protocols is **OPTIONAL**. The ability to restrict the network layer to a single protocol such as IP is **REQUIRED**.

Support for the 802.1d spanning tree protocol of [ISO/IEC 10038] with the modifications described in B.3.1.2.3 is **OPTIONAL** for CMs intended for residential use. CMs intended for commercial use and bridging CMTSs **MUST** support this version of spanning tree (see Appendix B.VIII). CMs and CMTSs **MUST** include the ability to filter (and disregard) 802.1d BPDUs.

This specification assumes that CMs intended for residential use will not be connected in a configuration which would create network loops such as that shown in Figure B.3-3.

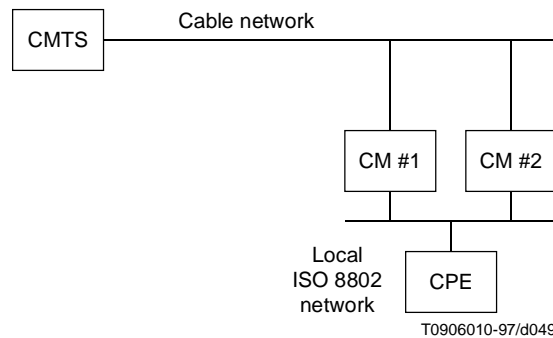

Figure B.3-3/J.112 – Example condition for network loops

B.3.1.2.2 CMTS forwarding rules

At the CMTS, if link-layer forwarding is used, then it **MUST** conform to the following general 802.1d guidelines:

- Link-layer frames between a given pair of end-stations **MUST** be delivered in order.
- Link-layer frames **MUST NOT** be duplicated.
- Stale frames (those that cannot be delivered in a timely fashion) **MUST** be discarded.

The address-learning and -aging mechanisms used are vendor-dependent.

If network-layer forwarding is used, then the CMTS should conform to IETF Router Requirements [RFC-1812] with respect to its CMTS-RFI and CMTS-NSI interfaces.

Conceptually, the CMTS forwards data packets at two abstract interfaces: between the CMTS-RFI and the CMTS-NSI, and between the upstream and downstream channels. The CMTS **MAY** use any combination of link-layer (bridging) and network-layer (routing) semantics at each of these interfaces. The methods used at the two interfaces need not be the same.

Forwarding between the upstream and downstream channels within a MAC layer differs from traditional LAN forwarding in that:

- A single channel is simplex, and cannot be considered a complete interface for most protocol (e.g. 802.1d spanning tree, Routing Information Protocol per [RFC-1058]) purposes.
- Upstream channels are essentially point-to-point, whereas downstream channels are shared-media.
- As a public network, policy decisions may override full connectivity.

For these reasons, an abstract entity called the MAC Forwarder exists within the CMTS to provide connectivity between stations within a MAC domain (see B.3.2).

B.3.1.2.3 CM forwarding rules

Data forwarding through the CM is link-layer bridging with the following specific rules.

B.3.1.2.3.1 Address learning

- The CM **MUST** acquire Ethernet MAC addresses of connected CPE devices, either from the provisioning process or from learning, until the CM acquires its maximum number of CPE addresses (a device-dependent value). Once the CM acquires its maximum number of CPE addresses, then newly discovered CPE addresses **MUST NOT** replace previously acquired addresses. The CM must support acquisition of at least one CPE address.
- The CM **MUST** allow configuration of CPE addresses during the provisioning process (up to its maximum number of CPE addresses) to support configurations in which learning is not practical nor desired.
- Addresses provided during the CM provisioning **MUST** take preference over learned addresses.
- CPE addresses **MUST NOT** be aged out.
- On a CM reset (e.g. a power cycle), all learned addresses **MUST** be discarded (they are not retained in non-volatile storage, to allow modification of user MAC addresses or movement of the CM).

B.3.1.2.3.2 Forwarding

CM forwarding in both directions **MUST** conform to the following general 802.1d guidelines:

- Link-layer frames between a given pair of end-stations **MUST** be delivered in order.
- Link-layer frames **MUST NOT** be duplicated.
- Stale frames (those that cannot be delivered in a timely fashion) **MUST** be discarded.

Cable-Network-to-Ethernet forwarding MUST follow the following specific rules:

- Frames addressed to unknown destinations MUST NOT be forwarded from the cable port to the Ethernet port.
- Broadcast frames MUST be forwarded to the Ethernet port, unless they are from source addresses which are provisioned or learned as supported CPE devices, in which case they MUST NOT be forwarded.
- Multicast frames MUST be forwarded to the Ethernet ports in accordance with filtering configuration settings specified by the cable operator’s operations and business support systems, unless they are from source addresses which are provisioned or learned as supported CPE devices, in which case they MUST NOT be forwarded.

Ethernet-to-Cable-Network forwarding MUST follow the following specific rules:

- Frames addressed to unknown destinations MUST be forwarded from the Ethernet port to the cable port.
- Broadcast frames MUST be forwarded to the cable port.
- Multicast frames MUST be forwarded to the cable port in accordance with filtering configuration settings specified by the cable operator’s operations and business support systems.
- Frames from source addresses other than those provisioned or learned as supported CPE devices MUST NOT be forwarded.
- If a single-user CM has learned a supported address, it MUST NOT forward data from a second source. Other (non-supported) CPE source addresses MUST be learned from the Ethernet port and this information used to filter local traffic as in a traditional learning bridge.
- If a single-user CM has learned A as its supported CPE device and learned B as a second device connected to the Ethernet port, it MUST filter any traffic from A to B.

B.3.2 The MAC Forwarder

The MAC Forwarder is a MAC sublayer that resides on the CMTS just below the MAC Service Access Point (MSAP) interface, as shown in Figure B.3-4. It is responsible for delivering upstream frames to:

- one or more downstream channels;
- the MSAP interface.

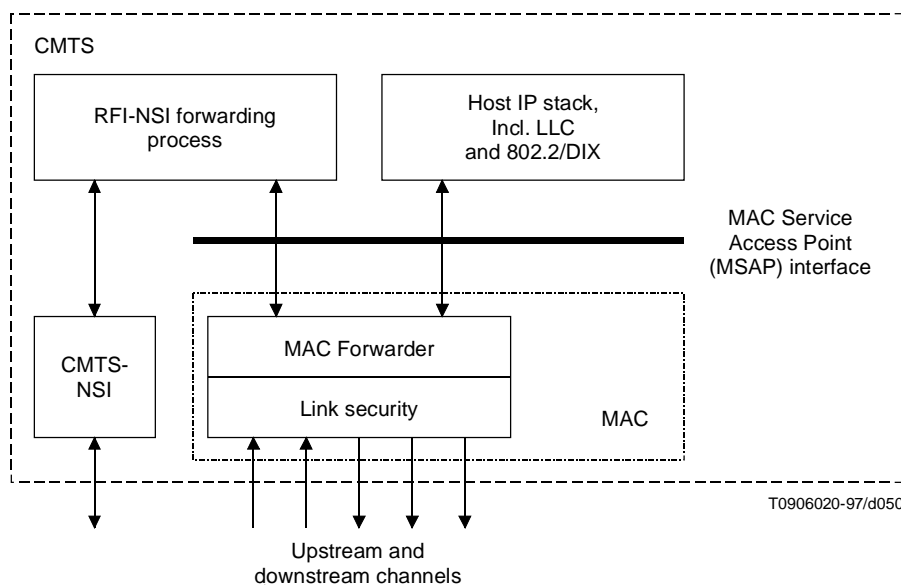

Figure B.3-4/J.112 – MAC Forwarder

In Figure B.3-4, the LLC sublayer and link security sublayers of the upstream and downstream channels on the cable network terminate at the MAC Forwarder.

The MSAP interface user MAY be the NSI-RFI Forwarding process or the CMTS's host protocol stack.

Delivery of frames may be based on data-link-layer (bridging) semantics, network-layer (routing) semantics, or some combination. Higher-layer semantics may also be employed (e.g. filters on UDP port numbers). The CMTS MUST provide IP connectivity between hosts attached to cable modems, and must do so in a way that meets the expectations of Ethernet-attached customer equipment. For example, the CMTS must either forward ARP packets or it must facilitate a proxy ARP service. The CMTS MAC Forwarder MAY provide service for non-IP protocols.

Note that there is no requirement that all upstream and downstream channels be aggregated under one MSAP as shown above. The vendor could just as well choose to implement multiple MSAPs, each with a single upstream and downstream channel.

B.3.2.1 Example rules for Data-Link-Layer forwarding

If the MAC Forwarder is implemented using only data-link-layer semantics, then the requirements in this subclause apply.

Delivery of frames is dependent on the Destination Address within the frame. The means of learning the location of each address is vendor-dependent, and MAY include:

- transparent-bridging-like source-address learning and aging;
- gleaning from MAC Registration Request messages;
- administrative means.

If the destination address of a frame is unicast, and that address is associated with a particular downstream channel, then the frame MUST be forwarded to that channel¹.

If the destination address of a frame is unicast, and that address is known to reside on the other (upper) side of the MSAP interface, then the frame MUST be delivered to the MSAP interface.

If the destination address is broadcast, multicast², or unknown, the frame MUST BE delivered to both the MSAP and to all downstream channels.

Delivery rules are similar to those for transparent bridging:

- Frames from a specific source to a particular destination MUST be delivered in order.
- Frames MUST NOT be duplicated.
- Frames that cannot be delivered in a timely fashion MUST be discarded.
- The Frame Check Sequence SHOULD be preserved rather than regenerated.

B.3.3 Network Layer

As stated above, the purpose of the data-over-cable system is to transport IP traffic transparently through the system.

The Network Layer protocol is the Internet Protocol (IP) version 4, as defined in RFC-791, and migrating to IP version 6.

This annex imposes no requirements for reassembly of IP packets.

B.3.4 Above the Network Layer

The subscribers will be able to use the transparent IP capability as a bearer for higher-layer services. Use of these services will be transparent to the CM.

¹ Vendors may implement extensions, similar to static addresses in 802.1d/ISO 10038 bridging, that cause such frames to be filtered or handled in some other manner.

² The all-CMTSs multicast address (see Appendix B.I) is an exception. 802.1d/ISO 10038 Spanning Tree Bridge PDUs must be forwarded.

In addition to the transport of user data, there are several network management and operation capabilities which depend upon the Network Layer. These include:

- SNMP (Simple Network Management Protocol, [RFC-1157]), for network management.
- TFTP (Trivial File Transfer Protocol, [RFC-1350]), a file transfer protocol, for downloading software and configuration information.
- DHCP (Dynamic Host Configuration Protocol, DHCP [RFC-1541]), a framework for passing configuration information to hosts on a TCP/IP network.
- A security management protocol as defined in [MCNS2].

B.3.5 Data Link Layer

The Data Link Layer is divided into sublayers in accordance with [IEEE 802], with the addition of Link-Layer security in accordance with [MCNS2] and [MCNS8]. The sublayers, from the top, are:

- Logical Link Control (LLC) sublayer (Class 1 only);
- Link-Layer security sublayer;
- Media Access Control (MAC) sublayer.

B.3.5.1 LLC sublayer

The LLC sublayer **MUST** be provided in accordance with [ISO/IEC 10039]. Address resolution **MUST** be used as defined in [RFC-826]. The MAC-to-LLC service definition is specified in [ISO/IEC 10039].

B.3.5.2 Link-layer security sublayer

Link-layer security **MUST** be provided in accordance with [MCNS2] and [MCNS8].

B.3.5.3 MAC sublayer

The definition, in detail, of the MAC sublayer and associated interfaces is provided in B.6.

The MAC sublayer defines a single transmitter for each downstream channel – the CMTS. All CMs listen to all frames transmitted on the downstream channel upon which they are registered and accept those where the destinations match the CM itself or CPEs reached via the CMCI port. CMs can communicate with other CMs only through the CMTS.

The upstream channel is characterized by many transmitters (CMs) and one receiver (the CMTS). Time in the upstream channel is slotted, providing for Time Division Multiple Access at regulated time ticks. The CMTS provides the time reference and controls the allowed usage for each interval. Intervals may be granted for transmissions by particular CMs, or for contention by all CMs. CMs may contend to request transmission time. To a limited extent, CMs may also contend to transmit actual data. In both cases, collisions can occur and retries are used.

Subclause B.6 describes the MAC-sublayer messages from the CMTS which direct the behaviour of the CMs on the upstream channel, as well as messaging from the CMs to the CMTS.

B.3.5.3.1 Overview

Some of the MAC protocol highlights include:

- bandwidth allocation controlled by CMTS;
- a stream of mini-slots in the upstream;
- dynamic mix of contention- and reservation-based upstream transmit opportunities;
- bandwidth efficiency through support of variable-length packets;
- extensions provided for future support of ATM or other Data PDU;
- class-of-service support;
- Extensions provided for security at the Data Link layer;
- Support for a wide range of data rates.

B.3.5.3.2 MAC service definition

The MAC sublayer service definition is in Appendix B.IV.

B.3.6 Physical layer

The Physical (PHY) layer is comprised of two sublayers:

- Transmission Convergence sublayer (present in the downstream direction only).
- Physical Media Dependent (PMD) sublayer.

B.3.6.1 Downstream Transmission Convergence sublayer

The Downstream Transmission Convergence sublayer exists in the downstream direction only. It provides an opportunity for additional services over the physical-layer bitstream. These additional services might include, for example, digital video. Definition of any such additional services is beyond the scope of this annex.

This sublayer is defined as a continuous series of 188-byte MPEG [ITU-T H.222.0] packets, each consisting of a 4-byte header followed by 184 bytes of payload. The header identifies the payload as belonging to the data-over-cable MAC. Other values of the header may indicate other payloads. The mixture of payloads is arbitrary and controlled by the CMTS.

The Downstream Transmission Convergence sublayer is defined in B.5.

B.3.6.2 PMD sublayer

B.3.6.2.1 Overview

The PMD sublayer involves digitally modulated RF carriers on the analogue cable network.

In the downstream direction, the PMD sublayer is based on [ITU-T J.83 B], with the exceptions called out in B.4.3.2, and includes these features:

- 64 and 256 QAM modulation formats;
- 6-MHz occupied spectrum coexists with all other signals on the cable plant;
- concatenation of Reed-Solomon block code and Trellis code supports operation in a higher percentage of North American cable networks;
- variable-depth interleaver supports both latency-sensitive and -insensitive data.

The features in the upstream direction are as follows:

- flexible and programmable CM under control of the CMTS;
- frequency agility;
- time division multiple access;
- QPSK and 16 QAM modulation formats;
- support of both fixed-frame and variable-length PDU formats;
- multiple symbol rates;
- programmable Reed-Solomon block coding;
- programmable preambles.

B.3.6.2.2 Interface points

Three RF interface points are defined at the PMD sublayer:

- a) downstream output on the CMTS;
- b) upstream input on the CMTS;
- c) cable in/out at the cable modem.

Separate downstream output and upstream input interfaces on the CMTS are required for compatibility with typical downstream and upstream signal combining and splitting arrangements in headends.

B.4 Physical media dependent sublayer specification

B.4.1 Scope

This specification defines the electrical characteristics and protocol for a Cable Modem (CM) and Cable Modem Termination System (CMTS). It is the intent of this specification to define an interoperable CM and CMTS such that any implementation of a CM can work with any CMTS. It is not the intent of this specification to imply any specific implementation.

B.4.2 Upstream

B.4.2.1 Overview

The upstream Physical Media Dependent (PMD) sublayer uses a FDMA/TDMA burst modulation format, which provides five symbol rates and two modulation formats (QPSK and 16QAM). The modulation format includes pulse shaping for spectral efficiency, is carrier-frequency agile, and has selectable output power level. The PMD sublayer format includes a variable-length modulated burst with precise timing beginning at boundaries spaced at integer multiples of 6.25 μ s apart (which is 16 symbols at the highest data rate).

Each burst supports a flexible modulation, symbol rate, preamble, randomization of the payload, and programmable FEC encoding.

All of the upstream transmission parameters associated with burst transmission outputs from the CM are configurable by the CMTS via MAC messaging. Many of the parameters are programmable on a burst-by-burst basis.

The PMD sublayer can support a near-continuous mode of transmission, wherein ramp-down of one burst *MAY* overlap the ramp-up of the following burst, so that the transmitted envelope is never zero. The system timing of the TDMA transmissions from the various CMs *MUST* provide that the centre of the last symbol of one burst and the centre of the first symbol of the preamble of an immediately following burst are separated by at least the duration of five symbols. The guard time *MUST* be greater than or equal to the duration of five symbols plus the maximum timing error. Timing error is contributed by both the CM and CMTS. CM timing performance is specified in B.4. Maximum timing error and guard time may vary with CMTSs from different vendors.

The upstream modulator is part of the cable modem which interfaces with the cable network. The modulator contains the actual electrical-level modulation function and the digital signal-processing function; the latter provides the FEC, preamble prepend, symbol mapping, and other processing steps. This specification is written with the idea of buffering the bursts in the signal processing portion, and with the signal processing portion:

- 1) accepting the information stream a burst at a time;
- 2) processing this stream into a complete burst of symbols for the modulator; and
- 3) feeding the properly-timed burst symbol stream to a memoryless modulator at the exact burst transmit time.

The memoryless portion of the modulator only performs pulse shaping and quadrature upconversion.

At the Demodulator, similar to the Modulator, there are two basic functional components: the demodulation function and the signal processing function. Unlike the Modulator, the Demodulator resides in the CMTS and the specification is written with the concept that there will be one demodulation function (not necessarily an actual physical demodulator) for each carrier frequency in use. The demodulation function would receive all bursts on a given frequency.

NOTE – The unit design approach should be cognizant of the multiple-channel nature of the demodulation and signal processing to be carried out at the headend, and partition/share functionality appropriately to optimally leverage the multi-channel application. A Demodulator design supporting multiple channels in a Demodulator unit may be appropriate.

The demodulation function of the Demodulator accepts a varying-level signal centred around a commanded power level and performs symbol timing and carrier recovery and tracking, burst acquisition, and demodulation. Additionally, the demodulation function provides an estimate of burst timing relative to a reference edge, an estimate of received signal power, an estimate of signal-to-noise ratio, and may engage adaptive equalization to mitigate the effects of:

- a) echoes in the cable plant;
- b) narrowband ingress; and
- c) group delay.

The signal-processing function of the Demodulator performs the inverse processing of the signal-processing function of the Modulator. This includes accepting the demodulated burst data stream and decoding, etc., and possibly multiplexing the data from multiple channels into a single output stream. The signal-processing function also provides the edge-timing reference and gating-enable signal to the demodulators to activate the burst acquisition for each assigned burst slot. The signal-processing function may also provide an indication of successful decoding, decoding error, or fail-to-decode for each code word and the number of corrected Reed-Solomon symbols in each code word. For every upstream burst, the CMTS has a prior knowledge of the exact burst length in symbols (see B.4.2.6, B.4.2.10.1 and B.I.2).

B.4.2.2 Modulation formats

The upstream modulator **MUST** provide both QPSK and 16 QAM modulation formats.

The upstream demodulator **MUST** support QPSK, 16 QAM, or both modulation formats.

B.4.2.2.1 Modulation rates

The upstream modulator **MUST** provide QPSK at 160, 320, 640, 1280, and 2560 ksym/s, and 16 QAM at 160, 320, 640, 1280, and 2560 ksym/s.

This variety of modulation rates, and flexibility in setting upstream carrier frequencies, permits operators to position carriers in gaps in the pattern of narrowband ingress, as discussed in Appendix B.VI.

The upstream symbol rate **MUST** be fixed for each upstream frequency.

B.4.2.2.2 Symbol mapping

The modulation mode (QPSK or 16 QAM) is programmable. The symbols transmitted in each mode and the mapping of the input bits to the I and Q constellation **MUST** be as defined in Table B.4-1. In the table, I_1 is the MSB of the symbol map, Q_1 is the LSB for QPSK, and Q_0 is the LSB for 16 QAM. Q_1 and I_0 have intermediate bit positions in 16 QAM. The MSB **MUST** be the first bit in the serial data into the symbol mapper.

Table B.4-1/J.112 – I/Q mapping

QAM mode	Input bit definitions
QPSK	$I_1 Q_1$
16 QAM	$I_1 Q_1 I_0 Q_0$

The upstream QPSK symbol mapping MUST be as shown in Figure B.4-1.

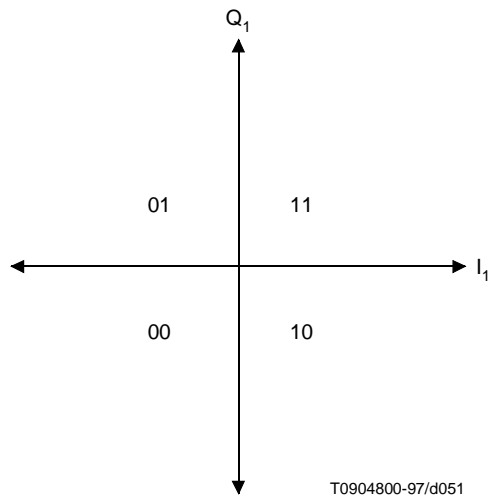

Figure B.4-1/J.112 – QPSK symbol mapping

The 16 QAM non-inverted (Gray-coded) symbol mapping MUST be as shown in Figure B.4-2.

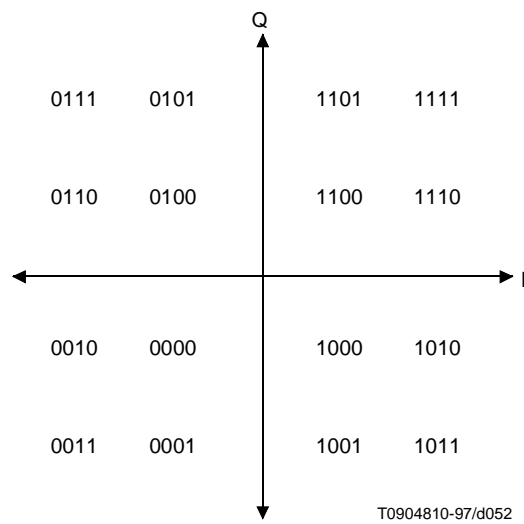

Figure B.4-2/J.112 – 16 QAM Gray-coded symbol mapping

The 16 QAM differential symbol mapping MUST be as shown in Figure B.4-3.

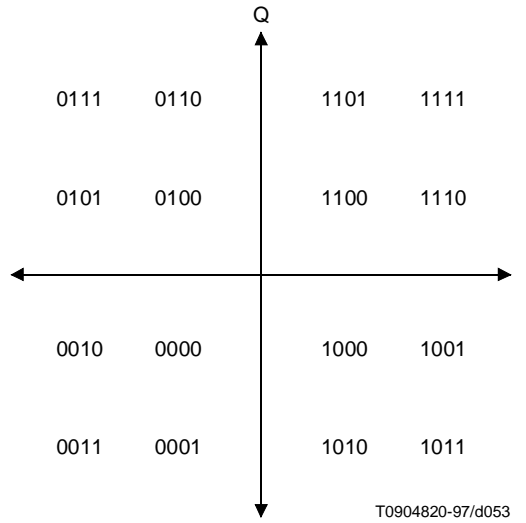

Figure B.4-3/J.112 – 16 QAM differential-coded symbol mapping

If differential quadrant encoding is enabled, then the currently-transmitted symbol quadrant is derived from the previously-transmitted symbol quadrant and the current input bits via Table B.4-2.

Table B.4-2/J.412 – Derivation of currently-transmitted symbol quadrant

Current input bits I(1) Q(1)	Quadrant phase change	MSBs of previously transmitted symbol	MSBs for currently transmitted symbol
00	0°	11	11
00	0°	01	01
00	0°	00	00
00	0°	10	10
01	90°	11	01
01	90°	01	00
01	90°	00	10
01	90°	10	11
11	180°	11	00
11	180°	01	10
11	180°	00	11
11	180°	10	01
10	270°	11	10
10	270°	01	11
10	270°	00	01
10	270°	10	00

B.4.2.2.3 Spectral shaping

The upstream PMD sublayer MUST support a 25% Nyquist square root raised cosine shaping.

The occupied spectrum MUST NOT exceed the channel widths shown in Table B.4-3.

Table B.4-3/J.112 – Maximum channel width

Symbol rate (ksym/s)	Channel width (kHz) ^{a)}
160	200
320	400
640	800
1280	1600
2560	3200
^{a)} Channel width is the –30 dB bandwidth.	

B.4.2.2.4 Upstream frequency agility and range

The upstream PMD sublayer MUST support operation over the frequency range of 5-42 MHz edge-to-edge.

Offset frequency resolution MUST be supported having a range of ± 32 kHz (increment = 1 Hz; implement within ± 10 Hz).

B.4.2.2.5 Spectrum format

The upstream modulator MUST provide operation with the format $s(t) = I(t) * \cos(\omega t) - Q(t) * \sin(\omega t)$, where t denotes time and ω denotes angular frequency.

B.4.2.3 FEC Encode

B.4.2.3.1 FEC Encode modes

The upstream modulator MUST be able to provide the following selections: Reed-Solomon codes over GF(256) with $T = 1$ to 10 or no FEC coding.

The following Reed-Solomon generator polynomial MUST be supported:

$$g(x) = (x + \alpha^0)(x + \alpha^1)...(x + \alpha^{2T-1})$$

where the primitive element alpha is 0x02 hex

The following Reed-Solomon primitive polynomial MUST be supported:

$$p(x) = x^8 + x^4 + x^3 + x^2 + 1$$

The upstream modulator MUST provide code words from a minimum size of 18 bytes (16 information bytes [k] plus two parity bytes for $T = 1$ error correction) to a maximum size of 255 bytes (k-bytes plus parity-bytes). The uncoded word size can have a minimum of one byte.

In Shortened Last Code Word mode, the CM MUST provide the last code word of a burst shortened from the assigned length of k data bytes per code word as described in B.4.2.10.1.2.

The value of T MUST be configured in response to the Upstream Channel Descriptor from the CMTS.

B.4.2.3.2 FEC Bit-to-symbol ordering

The input to the Reed-Solomon Encoder is logically a serial bit stream from the MAC layer of the CM, and the first bit of the stream MUST be mapped into the MSB of the first Reed-Solomon symbol into the encoder. The MSB of the first symbol out of the encoder MUST be mapped into the first bit of the serial bit stream fed to the Scrambler.

Note that the MAC byte-to-serial upstream convention calls for the byte LSB to be mapped into the first bit of the serial bit stream per B.6.2.1.3.

B.4.2.4 Scrambler (Randomizer)

The upstream modulator MUST implement a scrambler (shown in Figure B.4-4) where the 15-bit seed value MUST be arbitrarily programmable.

At the beginning of each burst, the register is cleared and the seed value is loaded. The seed value MUST be used to calculate the scrambler bit which is combined in an XOR with the first bit of data of each burst (which is the MSB of the first symbol following the last symbol of the preamble).

The scrambler seed value MUST be configured in response to the Upstream Channel Descriptor from the CMTS.

The polynomial MUST be $x^{15} + x^{14} + 1$.

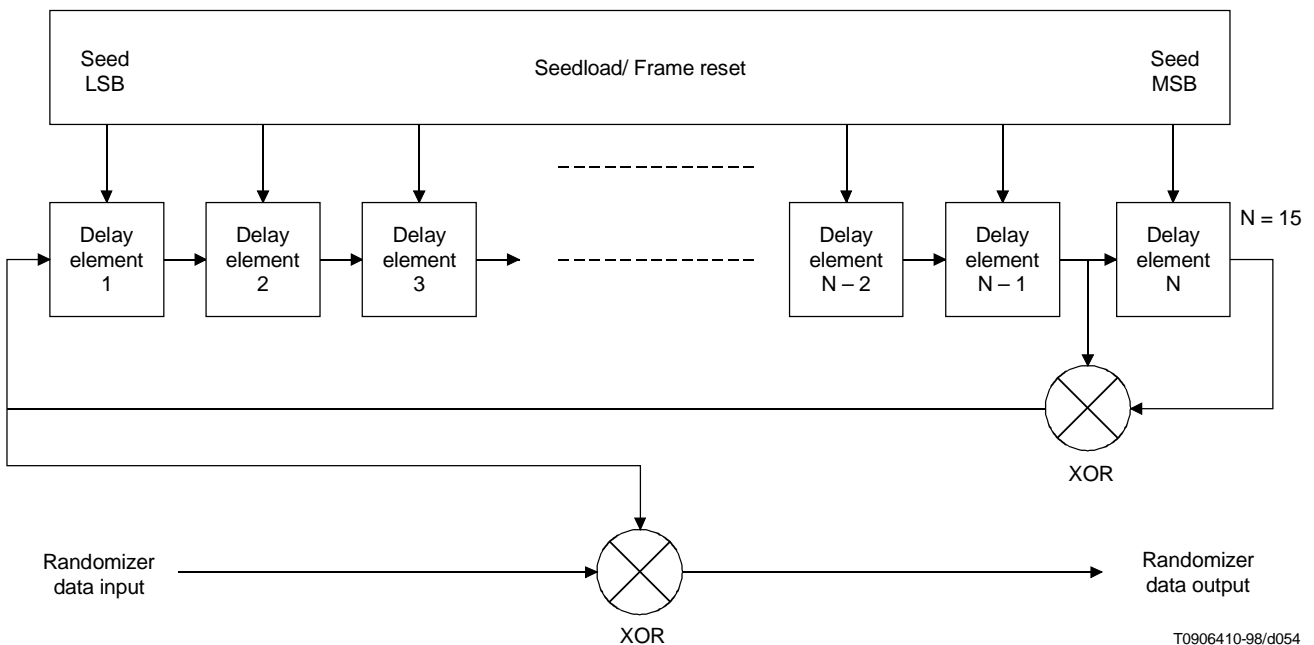

Figure B.4-4/J.112 – Scrambler structure

B.4.2.5 Preamble prepend

The upstream PMD sublayer MUST support a variable-length preamble field that is prepended to the data after they have been randomized and Reed-Solomon encoded.

The first bit of the Preamble Pattern is the first bit into the symbol mapper (see Figure B.4-8), and is I_1 in the first symbol of the burst (see B.4.2.2.2). The first bit of the Preamble Pattern is designated by the Preamble Value Offset as described in Table B.6-15, B.6.3.2.2.

The value of the preamble that is prepended MUST be programmable and the length MUST be 0, 2, 4, ..., or 1024 bits for QPSK and 0, 4, 8, ..., or 1024 bits for 16 QAM. Thus, the maximum length of the preamble is 512 QPSK symbols or 256 QAM symbols.

The preamble length and value MUST be configured in response to the Upstream Channel Descriptor message transmitted by the CMTS.

B.4.2.6 Burst profiles

The transmission characteristics are separated into three portions:

- a) Channel parameters;
- b) Burst Profile attributes; and
- c) User Unique parameters.

The Channel parameters include:

- i) the symbol rate (five rates from 160 ksym/s to 2.56 Msym/s in octave steps);
- ii) the center frequency (Hz); and
- iii) the 1024-bit Preamble Superstring.

The Channel parameters are further described in B.6.3.2.2, Table B.6-14; these characteristics are shared by all users on a given channel. The Burst Profile Attributes are listed in Table B.4-4, and are further described in B.6.3.2.2, Table B.6-15; these parameters are the shared attributes corresponding to a burst type. The User Unique Parameters may vary for each user even when using the same burst type on the same channel as another user (for example, Power Level) and are listed in Table B.4-5.

Table B.4-4/J.112 – Burst Profile attributes

Burst Parameter attributes	Configuration settings
Modulation	QPSK, 16 QAM
Diff Enc	On/Off
Preamble Length	0-1024 bits (B.4.2.5)
Preamble Value offset	0 to 1022
FEC Error Correction (T bytes)	0 to 10 (0 implies FEC = off)
FEC Code word Information Bytes (k)	Fixed: 16 to 253 (assuming FEC on) Shortened: 16 to 253 (assuming FEC on)
Scrambler Seed	15 bits
Maximum Burst Length (minislots) (Note)	0 to 255
Guard Time	5 to 255 Symbols
Last Code word Length	Fixed, shortened
Scrambler On/Off	On/Off
NOTE – A burst length of 0 mini-slots in the Channel Profile means that the burst length is variable on that channel for that burst type. The burst length, while not fixed, is granted explicitly by the CMTS to the CM in the MAP.	

Table B.4-5/J.112 – User Unique Burst parameters

User Unique parameter	Configuration settings
Power Level (Note)	+8 to +55 dBmV (16 QAM) +8 to +58 dBmV (QPSK) 1 -dB steps
Offset Frequency (Note)	Range = ± 32 kHz; increment = 1 Hz; implement within ± 10 Hz
Ranging Offset	0 to $(2^{16} - 1)$, increments of 6.25 μ sec/64
Burst Length (mini-slots) if variable on this channel (changes burst-to-burst)	1 to 255 mini-slots
Transmit Equalizer Coefficients (Note) (advanced modems only)	Up to 64 coefficients; 4 bytes per coefficient: 2 real and 2 complex
NOTE – Values in table apply for this given channel and symbol rate.	

The CM MUST generate each burst at the appropriate time as conveyed in the mini-slot grants provided by the CMTS MAPs (see B.6.3.2.3).

The CM MUST support all burst profiles commanded by the CMTS via the Burst Descriptors in the UCD (see B.6.3.2.2), and subsequently assigned for transmission in a MAP (see B.6.3.2.3).

The CM MUST implement the Offset Frequency to within ± 10 Hz.

Ranging Offset is the delay correction applied by the CM to the CMTS Upstream Frame Time derived at the CM, in order to synchronize the upstream transmissions in the TDMA scheme. The Ranging Offset is an advancement equal to roughly the round-trip delay of the CM from the CMTS. The CMTS MUST provide feedback correction for this offset to the CM, based on reception of one or more successfully received bursts (i.e. satisfactory result from each technique employed: error correction and/or CRC), with accuracy within 1/2 symbol and resolution of 1/64 of the frame tick increment ($6.25 \mu\text{s}/64 = 0.09765625 \mu\text{s} = 1/4$ the symbol duration of the highest symbol rate = 10.24 MHz^{-1}). The CMTS sends adjustments to the CM, where a negative value implies the Ranging Offset is to be decreased, resulting in later times of transmission at the CM. CM MUST implement the correction with resolution of at most 1 symbol duration (of the symbol rate in use for a given burst), and (other than a fixed bias) with accuracy within $\pm 0.25 \mu\text{s}$ plus $\pm 1/2$ symbol owing to resolution. The accuracy of CM burst timing of $\pm 0.25 \mu\text{s}$ plus $\pm 1/2$ symbol is relative to the mini-slot boundaries derivable at the CM based on an ideal processing of the timestamp signals received from the CMTS.

The CM MUST be capable of switching burst profiles with no reconfiguration time required between bursts except for changes in the following parameters:

- 1) Output Power;
- 2) Modulation;
- 3) Symbol Rate;
- 4) Offset frequency;
- 5) Channel Frequency; and
- 6) Ranging Offset.

For Symbol Rate, Offset frequency and Ranging Offset, the CM MUST be able to transmit consecutive bursts as long as the CMTS allocates at least 96 symbols in between the last symbol centre of one burst and the first symbol centre of the following burst. The maximum reconfiguration time of 96 symbols should compensate for the ramp down time of one burst and the ramp up time of the next burst as well as the overall transmitter delay time including the pipeline delay and optional pre-equalizer delay. For modulation type changes, the CM MUST be able to transmit consecutive bursts as long as the CMTS allocates at least 96 symbols in between the last symbol centre of one burst and the first symbol centre of the following burst. Output Power, Symbol Rate, Offset frequency, Channel Frequency and Ranging Offset MUST NOT be changed until the CM is provided sufficient time between bursts by the CMTS. Transmitted Output Power, Symbol Rate, Offset frequency, Channel Frequency and Ranging Offset MUST NOT change while more than -30 dB of any symbol's energy of the previous burst remains to be transmitted, or more than -30 dB of any symbol's energy of the next burst has been transmitted. The modulation MUST NOT change while more than -30 dB of any symbol's energy of the previous burst remains to be transmitted, or more than -30 dB of any symbol's energy of the next burst has been transmitted, EXCLUDING the effect of the transmit equalizer (if present in the CM). (This is to be verified with the transmit equalizer providing no filtering; delay only, if that. Note that if the CMTS has decision feedback in its equalizer, it may need to provide more than the 96 symbol gap between bursts of different modulation type which the same CM may use; this is a CMTS decision.) Negative ranging offset adjustments will cause the 96 symbol guard to be violated. The CMTS must assure that this does not happen by allowing extra guard time between bursts that is at least equal to the amount of negative ranging offset.

If Channel Frequency is to be changed, then the CM MUST be able to implement the change between bursts as long as the CMTS allocates at least 96 symbols plus 100 ms between the last symbol centre of one burst and the first symbol of the following burst.

The Channel Frequency of the CM MUST be settled within the phase noise and accuracy requirements of B.4.2.9.5 and B.4.2.9.6 within 100 ms from the beginning of the change.

If Output Power is to be changed by 1 dB or less, then the CM MUST be able to implement the change between bursts as long as the CMTS allocates at least 96 symbols plus 5 μ s between the last symbol centre of one burst and the first symbol centre of the following burst.

If Output Power is to be changed by more than 1 dB, then the CM MUST be able to implement the change between bursts as long as the CMTS allocates at least 96 symbols plus 10 μ s between the last symbol centre of one burst and the first symbol centre of the following burst.

The Output Power of the CM MUST be settled to within ± 0.1 dB of its final output power level:

- a) within 5 μ s from the beginning of a change of 1 dB or less; and
- b) within 10 μ s from the beginning of a change of greater than 1 dB.

The output transmit power MUST be maintained constant within a TDMA burst to within less than 0.1 dB (excluding the amount theoretically present due to pulse shaping, and amplitude modulation in the case of 16 QAM).

B.4.2.7 Burst timing convention

Figure B.4-5 illustrates the nominal burst timing.

Figure B.4-6 indicates worst-case burst timing. In this example, burst N arrives 1.5 symbols late, and burst N + 1 arrives 1.5 symbols early, but separation of 5 symbols is maintained; 8-symbol guard band shown.

At a symbol rate of R_s , symbols occur at a rate of one each $T_s = 1/R_s$ seconds. Ramp up and Ramp down are the spread of a symbol in the time domain beyond T_s duration owing to the symbol-shaping filter. If only one symbol were transmitted, its duration would be longer than T_s due to the shaping filter impulse response being longer than T_s . The spread of the first and last symbols of a burst transmission effectively extends the duration of the burst to longer than $N * T_s$, where N is the number of symbols in the burst.

B.4.2.8 Transmit power requirements

The upstream PMD sublayer MUST support varying the amount of transmit power. Requirements are presented for:

- 1) the range of commanded transmit power;
- 2) the step size of the power commands; and
- 3) the accuracy (actual output power compared to the commanded amount) of the response to the command.

The mechanism by which power adjustments are performed is defined in B.7.2.5. Such adjustments MUST be within the ranges of tolerances described below.

B.4.2.8.1 Output power agility and range

The output transmit power in the design bandwidth MUST be variable over the range of +8 dBmV to 55 dBmV (16 QAM), or 58 dBmV (QPSK), in 1-dB steps.

The absolute accuracy of the transmitted power MUST be ± 2 dB, and the step size accuracy ± 0.4 dB, with an allowance for hysteresis while switching in/out a step attenuator (e.g. 20 dB) in which case the accuracy requirement is relaxed to ± 1.4 dB. For example, the actual power increase resulting from a command to increase the power level by 1 dB in a CM's next transmitted burst MUST be between 0.6 and 1.4 dB.

The step resolution MUST be 1 dB or less. When a CM is commanded with finer resolution than it can implement, it MUST round to the nearest supported step size. If the commanded step is half way between two supported step sizes, the CM MUST choose the smaller step. For example, with a supported step resolution of 1 dB, a command to step ± 0.5 dB would result in no step, while a command to step ± 0.75 dB would result in a ± 1 dB step.

a) Nominal burst profile (no timing errors); 8-symbol guard band is illustrated; 10-symbol ramp up and ramp down is illustrated.

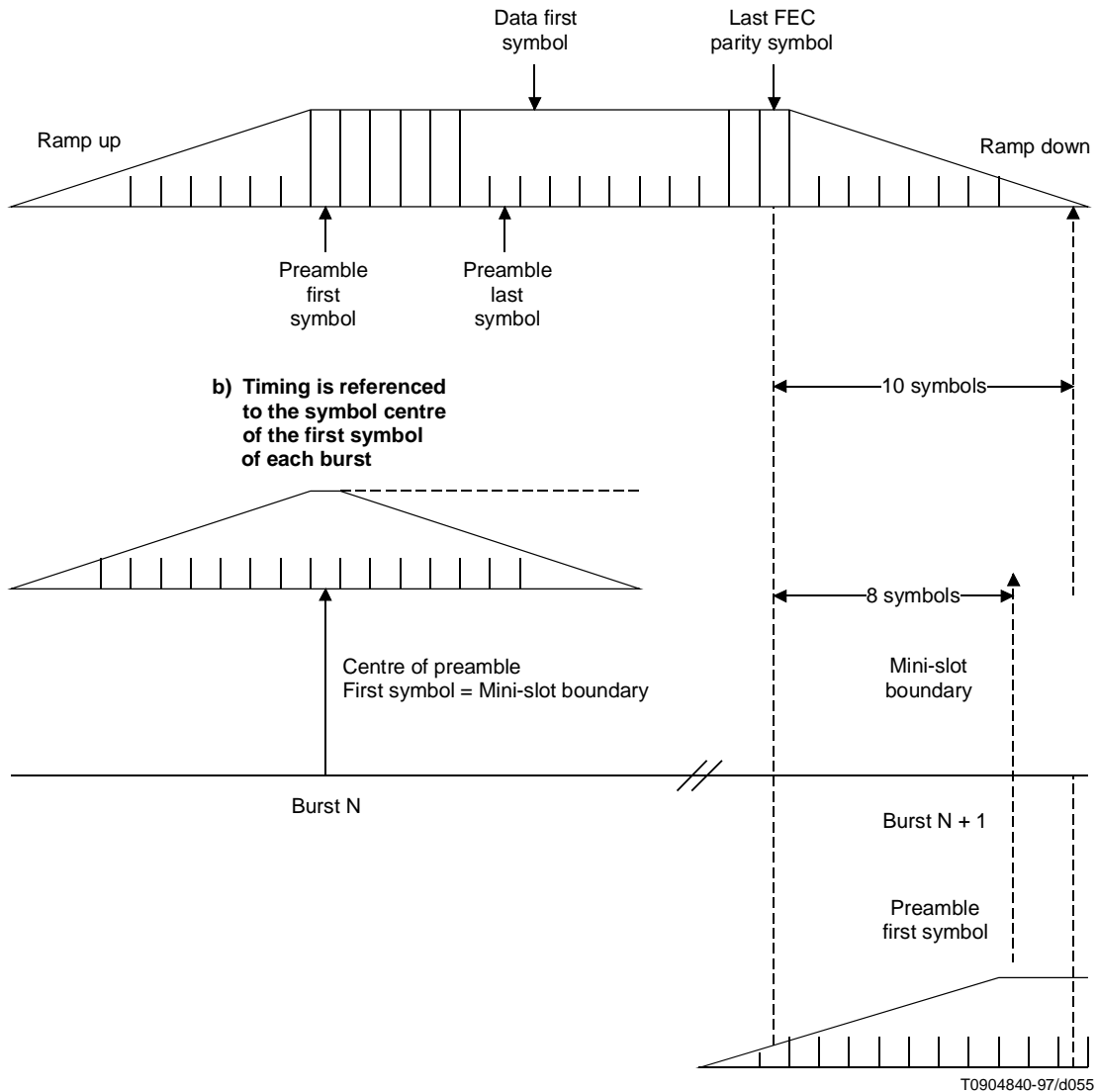

T0904840-97/d055

NOTE – Ramp down of one burst can overlap ramp up of following burst even with one transmitter assigned both bursts.

Figure B.4-5/J.112 – Nominal burst timing

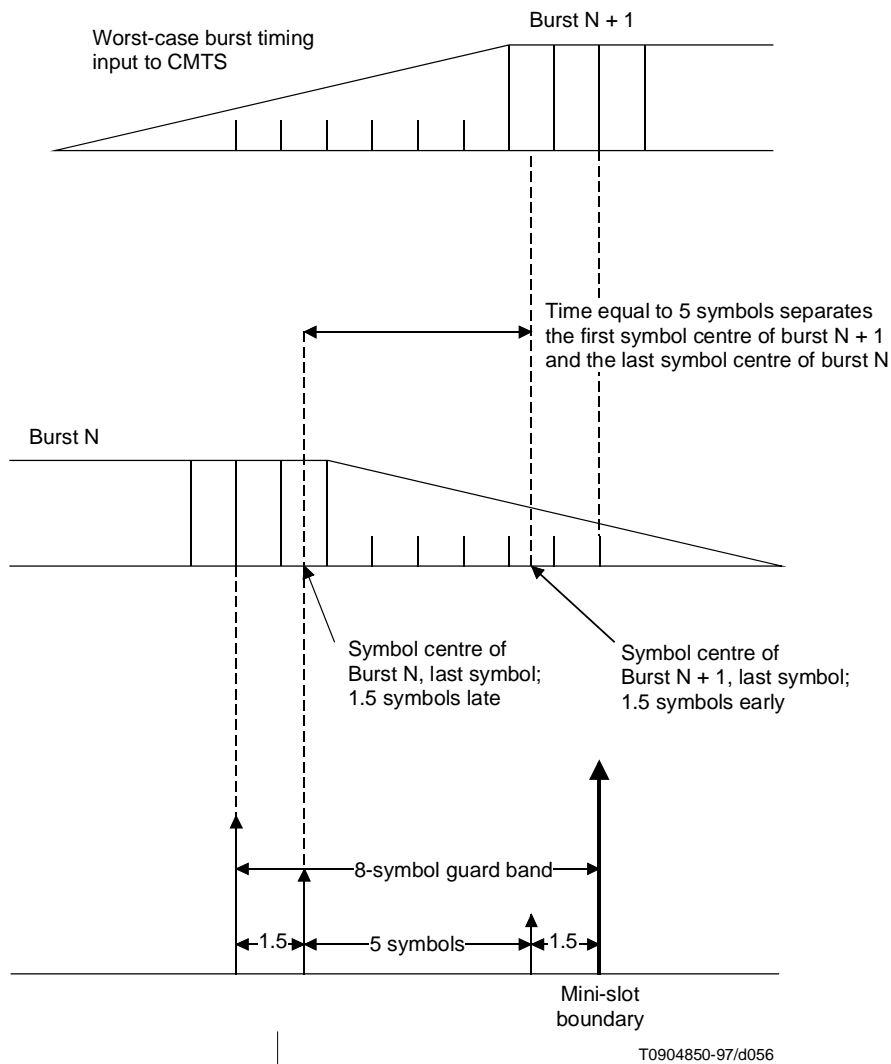

Figure B.4-6/J.112 – Worst-case burst timing

B.4.2.9 Fidelity requirements

B.4.2.9.1 Spurious emissions

The noise and spurious power **MUST NOT** exceed the levels given in Tables B.4-6, B.4-7 and B.4-8.

In Table B.4-6, In-band spurious includes noise, carrier leakage, clock lines, synthesizer spurious products, and other undesired transmitter products. It does not include ISI. The measurement bandwidth for In-band spurious is equal to the symbol rate (e.g. 160 kHz for 160 ksymb/s).

The measurement bandwidth for the 3 (or fewer) Carrier-Related Frequency Bands (below 42 MHz) is 160 kHz, with up to 3 is 160 kHz bands, each with no more than -47 dBc, allowed to be excluded from the "Bands within 5 to 42 MHz Transmitting Burst" specs of Table B.4-8.

The measurement bandwidth is also 160 kHz for the Between bursts specs of Table B.4-6 below 42 MHz; the Transmitting burst specs apply during the mini-slots granted to the CM (when the CM uses all or a portion of the grant), and for a mini-slot before and after the granted mini-slots. (Note that a mini-slot may be as short as 32 symbols, or $12.5 \mu\text{s}$ at the 2.56 Msym/s rate, or as short as $200 \mu\text{s}$ at the 160 ksymb/s rate.) The Between bursts specs apply except during a used grant of mini-slots, and the mini-slot before and after the used grant.

Table B.4-6/J.112 – Spurious emissions

Parameter	Transmitting burst	Between bursts
In-band [In-band spurious includes noise, carrier leakage, clock lines, synthesizer spurious products, and other undesired transmitter products. It does not include Inter Symbol Interference (ISI)].	-40 dBc	The greater of -72 dBc or -59 dBmV
Adjacent Band	See Table B.4-7	The greater of -72 dBc or -59 dBmV
3 or Fewer Carrier-Related Frequency Bands (such as second harmonic, if < 42 MHz)	-47 dBc	The greater of -72 dBc or -59 dBmV
Bands within 5 to 42 MHz (excluding assigned channel, adjacent channels, and carrier-related channels)	See Table B.4-8	The greater of -72 dBc or -59 dBmV
CM Integrated Spurious Emissions Limits (all in 4 MHz, includes discretely ^{a)} 42 to 54 MHz 54 to 60 MHz 60 to 88 MHz 88 to 860 MHz	max -40 dBc, -26 dBmV -35 dBmV -40 dBmV -45 dBmV	-26 dBmV -40 dBmV -40 dBc max -45 dBmV, -40 dBc ^{b)}
CM Discrete Spurious Emissions Limits ^{a)} 42 to 54 MHz 54 to 88 MHz 88 to 860 MHz	max -50 dBc, -36 dBmV -50 dBmV -50 dBmV	-36 dBmV -50 dBmV -50 dBmV
^{a)} These spec limits exclude a single discrete spur related to the tuned received channel; this single discrete spur MUST be no greater than -40 dBmV. ^{b)} 'dBc' is relative to the received downstream signal level. Some spurious outputs are proportional to the receive signal level.		

B.4.2.9.1.1 Adjacent channel spurious emissions

Spurious emissions from a transmitted carrier may occur in an adjacent channel which could be occupied by a carrier of the same or different symbol rates. Table B.4-7 lists the required adjacent channel spurious emission levels for all combinations of transmitted carrier symbol rates and adjacent channel symbol rates. The measurement is performed in an adjacent channel interval that is of appropriate bandwidth and distance from the transmitted carrier based on the symbol rates of the transmitted carrier and the carrier in the adjacent channel.

Table B.4-7/J.112 – Adjacent channel spurious emissions

Transmitted carrier symbol rate	Specification in the interval	Measurement interval and distance from carrier edge	Adjacent channel carrier symbol rate
160 Ksym/s	-45 dBc	20 to 180 kHz	160 ksym/s
	-45 dBc	40 to 360 kHz	320 ksym/s
	-45 dBc	80 to 720 kHz	640 ksym/s
	-42 dBc	160 to 1440 kHz	1280 ksym/s
	-39 dBc	320 to 2880 kHz	2560 ksym/s
All other symbol rates	-45 dBc	20 to 180 kHz	160 ksym/s
	-45 dBc	40 to 360 kHz	320 ksym/s
	-45 dBc	80 to 720 kHz	640 ksym/s
	-44 dBc	160 to 1440 kHz	1280 ksym/s
	-41 dBc	320 to 2880 kHz	2560 ksym/s

B.4.2.9.1.2 Spurious emissions in 5 to 42 MHz

Spurious emissions, other than those in an adjacent channel or carrier related emissions listed above, may occur in intervals that could be occupied by other carriers of the same or different symbol rates. To accommodate these different symbol rates and associated bandwidths, the spurious emissions are measured in an interval equal to the bandwidth corresponding to the symbol rate of the carrier that could be transmitted in that interval. This interval is independent of the current transmitted symbol rate.

Table B.4-8 lists the possible symbol rates that could be transmitted in an interval, the required spurious level in that interval, and the initial measurement interval at which to start measuring the spurious emissions. Measurements should start at the initial distance and be repeated at increasing distance from the carrier until the upstream band edge, 5 MHz or 42 MHz, is reached. Measurement intervals should not include carrier related emissions.

Table B.4-8/J.112 – Spurious emissions in 5 to 42 MHz

Possible symbol rate in this interval	Specification in the interval	Initial measurement interval and distance from carrier edge
160 ksym/s	-53 dBc	220 to 380 kHz
320 ksym/s	-50 dBc	240 to 560 kHz
640 ksym/s	-47 dBc	280 to 920 kHz
1280 ksym/s	-44 dBc	360 to 1640 kHz
2560 ksym/s	-41 dBc	520 to 3080 kHz

B.4.2.9.2 Spurious emissions during burst on/off transients

Each transmitter MUST control spurious emissions, prior to and during ramp up and during and following ramp down, before and after a burst in the TDMA scheme.

On/off spurious emissions, such as the change in voltage at the upstream transmitter output due to enabling or disabling transmission, MUST be no more than 100 mV, and such a step MUST be dissipated no faster than 2 μ s of constant slewing. This requirement applies when the CM is transmitting at +55 dBmV or more; at backed-off transmit levels, the maximum change in voltage MUST decrease by a factor of 2 for each 6-dB decrease of power level from +55 dBmV, down to a maximum change of 7 mV at 31 dBmV and below. This requirement does not apply to CM power-on and power-off transients.

B.4.2.9.3 Symbol Error Rate (SER)

Modulator performance MUST be within 0.5 dB of theoretical SER vs C/N (i.e. E_s/N_o), for SER as low as 10^{-6} uncoded, for QPSK and 16 QAM.

The SER degradation is determined by the cluster variance caused by the transmit wave form at the output of an ideal square-root raised-cosine receive filter. It includes the effects of ISI, spurious, phase noise, and all other transmitter degradations.

Cluster SNR should be measured on a modulation analyzer using a square-root raised cosine receive filter with $\alpha = 0.25$. The measured SNR MUST be better than 30 dB.

B.4.2.9.4 Filter distortion

The following requirements assume that any pre-equalization is disabled.

B.4.2.9.4.1 Amplitude

The spectral mask MUST be the ideal square root raised cosine spectrum with $\alpha = 0.25$, within the ranges given below:

$f_c - R_s/4$ Hz to $f_c + R_s/4$ Hz: -0.3 dB to $+0.3$ dB

$f_c - 3R_s/8$ Hz to $f_c - R_s/4$ Hz, and $f_c + R_s/4$ Hz to $f_c + 3R_s/8$ Hz: -0.5 dB to 0.3 dB

$f_c - R_s/2$ Hz and $f_c + R_s/2$ Hz: -3.5 dB to -2.5 dB

$f_c - 5R_s/8$ Hz and $f_c + 5R_s/8$ Hz: no greater than -30 dB

where f_c is the centre frequency, R_s is the symbol rate, and the spectral density is measured with a resolution bandwidth of 10 KHz or less.

B.4.2.9.4.2 Phase

$f_c - 5R_s/8$ Hz to $f_c + 5R_s/8$ Hz: Group Delay Variation MUST NOT be greater than 100 ns.

B.4.2.9.5 Carrier phase noise

The upstream transmitter total integrated phase noise (including discrete spurious noise) MUST be less than or equal to -43 dBc summed over the spectral regions spanning 1 kHz to 1.6 MHz above and below the carrier.

B.4.2.9.6 Channel frequency accuracy

The CM MUST implement the assigned channel frequency within ± 50 parts per million over a temperature range of 0 to 40 degrees C up to five years from date of manufacture.

B.4.2.9.7 Symbol rate accuracy

The upstream modulator MUST provide an absolute accuracy of symbol rates ± 50 parts per million over a temperature range of 0 to 40 degrees C up to five years from date of manufacture.

B.4.2.9.8 Symbol timing jitter

Peak-to-peak symbol jitter, referenced to the previous symbol zero-crossing, of the transmitted waveform, MUST be less than 0.02 of the nominal symbol duration over a 2-s period. In other words, the difference between the maximum and the minimum symbol duration during the 2-s period shall be less than 0.02 of the nominal symbol duration for each of the five upstream symbol rates.

The peak-to-peak cumulative phase error, referenced to the first symbol time and with any fixed symbol frequency offset factored out, MUST be less than 0.04 of the nominal symbol duration over a 0.1-s period. In other words, the difference between the maximum and the minimum cumulative phase error during the 0.1-s period shall be less than 0.04 of the nominal symbol duration for each of the five upstream symbol rates. Factoring out a fixed symbol frequency offset is to be done by using the computed mean symbol duration during the 0.1 s.

B.4.2.10 Frame structure

Figure B.4-7 shows two examples of the frame structure: one where the packet length equals the number of information bytes in a code word, and another where the packet length is longer than the number of information bytes in one code word, but less than in two code words. Example 1 illustrates the fixed code-word length mode, and Example 2 illustrates the shortened last code-word mode. These modes are defined in B.4.2.10.1.

Example 1 – Packet length = number of information bytes in code word = k

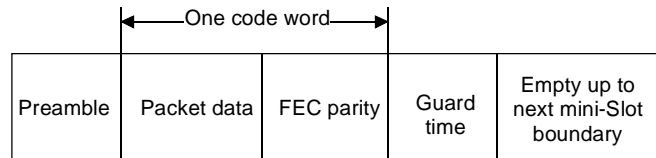

Example 2 – Packet length = k + remaining information bytes in 2nd code word = $k + k' \leq k + k'' \leq 2k$ bytes

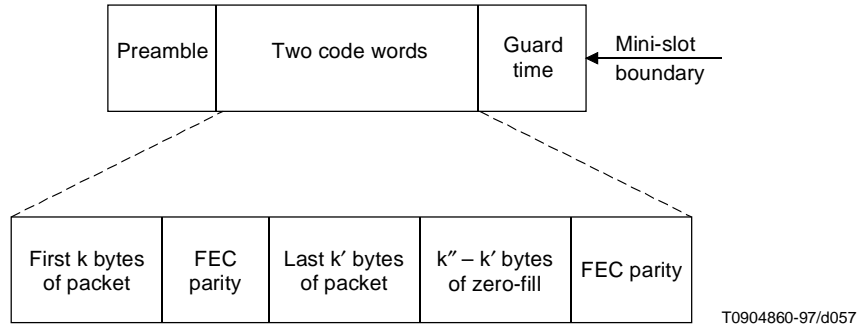

Figure B.4-7/J.112 – Example frame structures with flexible burst length mode

B.4.2.10.1 Code-word length

The CM operates in fixed-length code-word mode or with shortened code-word capability enabled. The minimum number of information bytes in a code word, for fixed or shortened mode, is 16 bytes. Shortened code-word capability is available with $k \geq 16$ bytes, where k is the number of information bytes in a code word. With $k < 16$, shortened code word capability is not available.

The following descriptions apply to an allocated grant of mini-slots in both contention and non-contention regions. (Allocation of mini-slots is discussed in B.6.) The intent of the description is to define rules and conventions such that CMs request the proper number of mini-slots and the CMTS PHY knows what to expect regarding the FEC framing in both fixed code-word length and shortened last code-word modes.

B.4.2.10.1.1 Fixed code-word length

With the fixed-length code words, after all the data are encoded, zero-fill will occur in this code word if necessary to reach the assigned k data bytes per code word, and zero-fill MUST continue up to the point when no additional fixed-length code words can be inserted before the end of the last allocated mini-slot in the grant, accounting for FEC parity and guard-time symbols.

B.4.2.10.1.2 Shortened last code word

As shown in Figure B.4-7, let k' = the number of information bytes that remain after partitioning the information bytes of the burst into full-length (k burst data bytes) code words. The value of k' is less than k . Given operation in a shortened last code-word mode, let k'' = the number of burst data bytes plus zero-fill bytes in the shortened last code word. In shortened code-word mode, the CM will encode the data bytes of the burst (including MAC header) using the assigned code-word size (k information bytes per code word) until:

- 1) all the data are encoded; or
- 2) a remainder of data bytes is left over which is less than k .

Shortened last code words shall not have less than 16 information bytes, and this is to be considered when CMs make requests of mini-slots. In shortened last code-word mode, the CM will zero-fill data if necessary until the end of the mini-slot allocation, which in most cases will be the next mini-slot boundary, accounting for FEC parity and guard-time symbols. In many cases, only $k'' - k'$ zero-fill bytes are necessary to fill out a mini-slot allocation with $16 \leq k'' \leq k$ and $k' \leq k''$. However, note the following.

More generally, the CM is required to zero-fill data until the point when no additional fixed-length code words can be inserted before the end of the last allocated mini-slot in the grant (accounting for FEC parity and guard-time symbols), and then, if possible, a shortened last code word of zero-fill shall be inserted to fit into the mini-slot allocation.

If, after zero-fill of additional code words with k information bytes, there are less than 16 bytes remaining in the allocated grant of mini-slots, accounting for parity and guard-time symbols, then the CM shall not create this last shortened code word.

B.4.2.11 Signal processing requirements

The signal processing order for each burst packet type MUST be compatible with the sequence shown in Figure B.4-8 and MUST follow the order of steps in Figure B.4-9.

B.4.2.12 Upstream demodulator input power characteristics

The maximum total input power to the upstream demodulator MUST NOT exceed 35 dBmV in the 5-42 MHz frequency range of operation.

The intended received power in each carrier MUST be within the values shown in Table B.4-9.

The demodulator MUST operate within its defined performance specifications with received bursts within ± 6 dB of the nominal commanded received power.

Table B.4-9/J.112 – Maximum range of commanded nominal receive power in each carrier

Symbol rate (ksym/s)	Maximum range (dBmV)
160	-16 to +14
320	-13 to +17
640	-10 to +20
1280	-7 to +23
2560	-4 to +26

B.4.2.13 Upstream electrical output from the CM

The CM MUST output an RF modulated signal with the characteristics delineated in Table B.4-10.

Table B.4-10/J.112 – Electrical output from CM

Parameter	Value
Frequency	5 to 42 MHz edge-to-edge
Level range (one channel)	+8 to +55 dBmV (16 QAM) +8 to +58 dBmV (QPSK)
Modulation type	QPSK and 16 QAM
Symbol rate (nominal)	160, 320, 640, 1280 and 2560 ksym/s
Bandwidth	200, 400, 800, 1600 and 3200 kHz
Output impedance	75 ohms
Output return loss	> 6 dB (5-42 MHz)
Connector	F connector per [IPS-SP-401] (common with the input)

B.4.3 Downstream

B.4.3.1 Downstream protocol

The downstream PMD sublayer MUST conform to Annex B/J.83 for Low-Delay Video Applications [ITU-T J.83 B], with the exceptions called out in B.4.3.2.

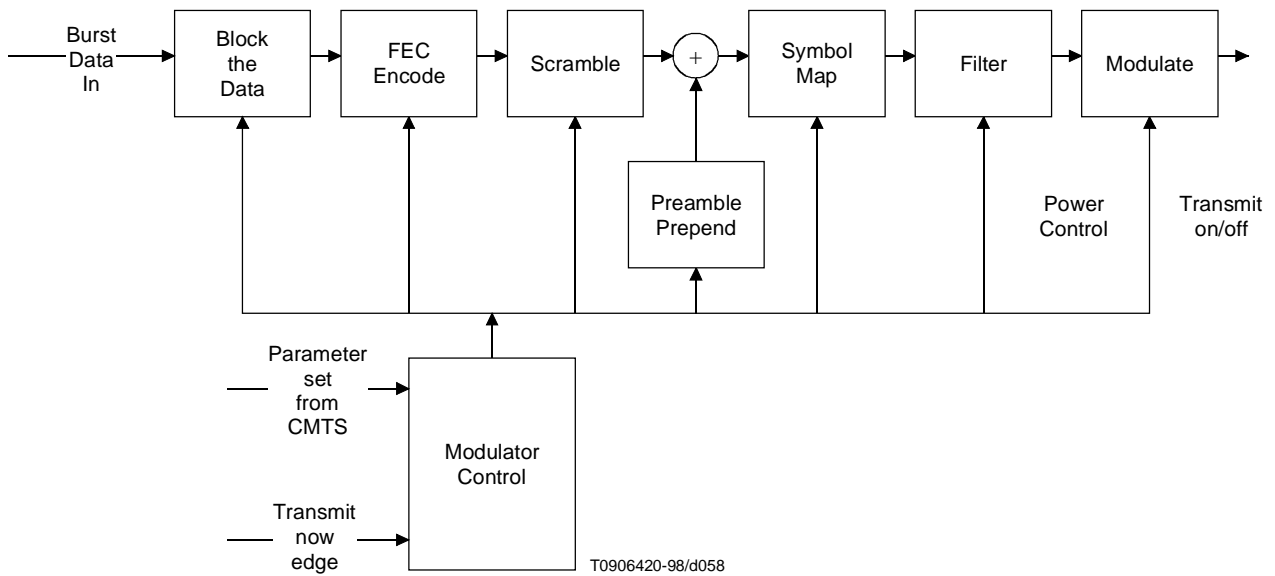

Figure B.4-8/J.112 – Signal-processing sequence

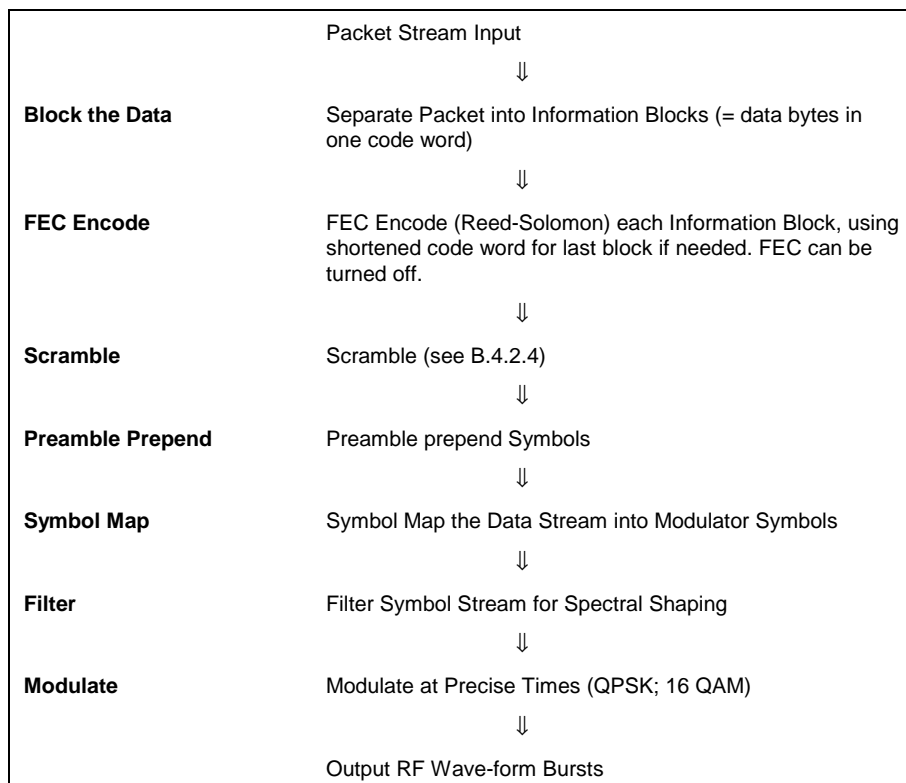

Figure B.4-9/J.112 – TDMA upstream transmission processing

B.4.3.2 Scalable interleaving to support low latency

The downstream PMD sublayer MUST support a variable-depth interleaver with the characteristics defined in Table B.4-11. This table contains a subset of interleaver modes found in [ITU-T J.83 B].

Table B.4-11/J.112 – Interleaver characteristics

I (Number of taps)	J (Increment)	Burst protection 64 QAM/256 QAM	Latency 64 QAM/256 QAM
8	16	5.9 μ s/4.1 μ s	0.22 ms/0.15 ms
16	8	12 μ s/8.2 μ s	0.48 ms/0.33 ms
32	4	24 μ s/16 μ s	0.98 ms/0.68 ms
64	2	47 μ s/33 μ s	2.0 ms/1.4 ms
128	1	95 μ s/66 μ s	4.0 ms/2.8 ms

The interleaver depth, which is coded in a 4-bit control word contained in the FEC frame synchronization trailer, always reflects the interleaving in the immediately-following frame. In addition, errors are allowed while the interleaver memory is flushed after a change in interleaving is indicated.

Refer to [ITU-T J.83 B] for the control bit specifications required to specify which interleaving mode is used.

B.4.3.3 Downstream frequency plan

The downstream frequency plan should comply with Harmonic Related Carrier (HRC), Incremental Related Carrier (IRC) or Standard (STD) North American frequency plans per [IS-6]. However, operation below a centre frequency of 91 MHz is not required.

B.4.3.4 CMTS output electrical

The CMTS MUST output an RF modulated signal with the following characteristics defined in Table B.4-12.

B.4.3.5 Downstream electrical input to CM

The CM MUST accept an RF modulated signal with the following characteristics (see Table B.4-13.)

B.4.3.6 CM BER performance

The bit-error-rate performance of a CM MUST be as described in this subclause. The requirements apply to the I = 128, J = 1 mode of interleaving.

B.4.3.6.1 64 QAM

B.4.3.6.1.1 64 QAM CM BER Performance

Implementation loss of the CM MUST be such that the CM achieves a post-FEC BER less than or equal to 10^{-8} when operating at a carrier to noise ratio (E_s/N_o) of 23.5 dB or greater.

B.4.3.6.1.2 64 QAM image rejection performance

Performance as described in B.4.3.6.1.1 MUST be met with analogue or digital signal at +10 dBc in any portion of the RF band other than the adjacent channels.

B.4.3.6.1.3 64 QAM Adjacent channel performance

Performance as described in B.4.3.6.1.1 MUST be met with digital signal at 0 dBc in the adjacent channels.

Performance as described in B.4.3.6.1.1 MUST be met with analogue signal at +10 dBc in the adjacent channels.

Performance as described in B.4.3.6.1.1, with an additional 0.2-dB allowance, MUST be met with digital signal at +10 dBc in the adjacent channels.

B.4.3.6.2 256 QAM

B.4.3.6.2.1 256 QAM CM BER performance

Implementation loss of the CM MUST be such that the CM achieves a post-FEC BER less than or equal to 10^{-8} when operating at a carrier to noise ratio (E_s/N_o) of 30 dB or greater.

Table B.4-12/J.112 –CMTS output

Parameter	Value
Centre Frequency (f_c)	91 to 857 MHz \pm 30 kHz ^{a)}
Level	Adjustable over the range 50 to 61 dBmV
Modulation type	64 QAM and 256 QAM
Symbol rate (nominal) 64 QAM 256 QAM	5.056941 Msym/s 5.360537 Msym/s
Nominal channel spacing	6 MHz
Frequency response 64 QAM 256 QAM	~18% square root raised cosine shaping ~12% square root raised cosine shaping
Total discrete spurious In-band ($f_c \pm 3$ MHz) In-band spurious and noise ($f_c \pm 3$ MHz) Adjacent channel ($f_c \pm 3.0$ MHz) to ($f_c \pm 3.75$ MHz) Adjacent channel ($f_c \pm 3.75$ MHz) to ($f_c \pm 9$ MHz) Next adjacent channel ($f_c \pm 9$ MHz) to ($f_c \pm 15$ MHz) Other channels (47 MHz to 1000 MHz)	< -57 dBc < -48 dBc; where channel spurious and noise includes all discrete spurious, noise, carrier leakage, clock lines, synthesizer products, and other undesired transmitter products. Noise within ± 50 kHz of the carrier is excluded. < -58 dBc in 750 kHz. < -62 dBc in 5.25 MHz, excluding up to 3 spurs, each of which must be < -60 dBc when each is measured with 10 kHz bandwidth. < -65 dBc in 6 MHz, excluding up to three discrete spurs. The total power in the spurs must be < -60 dBc when each is measured with 10 kHz bandwidth. < -12 dBmV in each 6 MHz channel, excluding up to three discrete spurs. The total power in the spurs must be < -60 dBc when each is measured with 10 kHz bandwidth.
Phase noise	1 kHz-10 kHz: -33 dBc double sided noise power 10 kHz-50 kHz: -51 dBc double sided noise power 50 kHz-3 MHz: -51 dBc double sided noise power
Output impedance	75 ohms
Output return loss	> 14 dB within an output channel up to 750 MHz; > 13 dB in an output channel above 750 MHz
Connector	F connector per [IPS-SP-401]
a) ± 30 kHz includes an allowance of 25 kHz for the largest FCC frequency offset normally built into upconverters.	

Table B.4-13/J.112 – Electrical input to CM

Parameter	Value
Centre Frequency	91 to 857 MHz \pm 30 kHz
Level Range (one channel)	-15 dBmV to +15 dBmV
Modulation Type	64 QAM and 256 QAM
Symbol Rate (nominal)	5.056941 Msym/s (64 QAM) and 5.360537 Msym/s (256 QAM)
Bandwidth	6 MHz (18% square root raised cosine shaping for 64 QAM and 12% square root raised cosine shaping for 256 QAM)
Total Input Power (40-900 MHz)	< 30 dBmV
Input (load) Impedance	75 ohms
Input Return Loss	> 6 dB (88 to 860 MHz)
Connector	F connector per [IPS-SP-401] (common with the output)

B.4.3.6.2.2 256 QAM image rejection performance

Performance as described in B.4.3.6.2.1 MUST be met with analogue or digital signal at +10 dBc in any portion of the RF band other than the adjacent channels.

B.4.3.6.2.3 256 QAM adjacent channel performance

Performance as described in B.4.3.6.2.1 MUST be met with analogue or digital signal at 0 dBc in the adjacent channels.

Performance as described in B.4.3.6.2.1, with an additional 0.5-dB allowance, MUST be met with analogue signal at +10 dBc in the adjacent channels.

Performance as described in B.4.3.6.2.1, with an additional 1.0-dB allowance, MUST be met with digital signal at +10 dBc in the adjacent channels.

B.4.3.7 CMTS timestamp jitter

The peak-to-peak jitter, measured at the output of the CMTS, MUST be less than 500 ns. This includes jitter from both the value in the timestamp message, and time of transmission of that message.

The CM is expected to meet the burst timing accuracy requirements in B.4.2.6 when the time stamps contain this worst-case jitter.

NOTE – Jitter is the error (i.e. measured) relative to the CMTS Master Clock. (The CMTS Master Clock is the 10.24 MHz clock used for generating the timestamps.)

The CMTS 10.24 MHz Master Clock MUST have frequency stability of $\leq \pm 5$ ppm, drift rate $\leq 10^{-8}$ per second, and edge jitter of ≤ 10 ns peak-to-peak (± 5 ns). (The drift rate and jitter requirements on the CMTS Master Clock implies that the duration of two adjacent segments of 10 240 000 cycles will be within 30 ns, due to 10 ns jitter on each segments' duration, and 10 ns due to frequency drift. Durations of other counter lengths also may be deduced: adjacent 1 024 000 segments, ≤ 21 ns; 1 024 000 length segments separated by one 10 240 000 cycles, ≤ 30 ns; adjacent 102 400 000 segments, ≤ 120 ns. The CMTS Master Clock MUST meet such test limits in 99% or more measurements.)

B.5 Downstream transmission convergence sublayer**B.5.1 Introduction**

In order to improve demodulation robustness, facilitate common receiving hardware for both video and data, and provide an opportunity for the possible future multiplexing of video and data over the PMD sublayer bitstream defined in B.4, a sublayer is interposed between the downstream PMD sublayer and the Data-Over-Cable MAC sublayer.

The downstream bitstream is defined as a continuous series of 188-byte MPEG [ITU-T H.222.0] packets. These packets consist of a 4-byte header followed by 184 bytes of payload. The header identifies the payload as belonging to the Data-Over-Cable MAC. Other values of the header may indicate other payloads. The mixture of MAC payloads and those of other services is optional and is controlled by the CMTS.

Figure B.5-1 illustrates the interleaving of Data-Over-Cable (DOC) MAC bytes with other digital information (digital video in the example shown).

Header = DOC	DOC MAC payload
Header = video	Digital video payload
Header = video	Digital video payload
Header = DOC	DOC MAC payload
Header = video	Digital video payload
Header = DOC	DOC MAC payload
Header = video	Digital video payload
Header = video	Digital video payload
Header = video	Digital video payload

Figure B.5-1/J.112 – Example of interleaving MPEG packets in downstream

B.5.2 MPEG Packet format

The format of an MPEG Packet carrying MCNS data is shown in Figure B.5-2. The packet consists of a 4-byte MPEG Header, a pointer_field (not present in all packets) and the MCNS Payload.

MPEG Header (4 bytes)	pointer_field (1 byte)	MCNS Payload (183 or 184 bytes)
--------------------------	---------------------------	------------------------------------

Figure B.5-2/J.112 – Format of an MPEG Packet

B.5.3 MPEG Header for MCNS Data-Over-Cable

The format of the MPEG Transport Stream Header is defined in 2.4/H.222.0 [ITU-T H.222.0]. The particular field values that distinguish Data-Over-Cable MAC streams are defined in Table B.5-1. Field names are from the ITU specification.

The MPEG Header consists of 4 bytes that begin the 188-byte MPEG Packet. The format of the header for use on an MCNS Data-Over-Cable PID is restricted to that shown in Table B.5-1. The Header format conforms to the MPEG standard, but its use is restricted in this specification to NOT ALLOW inclusion of an adaptation_field in the MPEG packets.

B.5.4 MPEG Payload for MCNS Data-Over-Cable

The MPEG Payload portion of the MPEG Packet will carry the MCNS MAC frames. The first byte of the MPEG payload will be a 'pointer_field' if the payload_unit_start_indicator (PUSI) of the MPEG Header is set.

Table B.5-1/J.112 – MPEG Header format for MCNS Data-Over-Cable packets

Field	Length (bits)	Description
sync_byte	8	0x47; MPEG Packet Sync byte.
transport_error_indicator	1	Indicates an error has occurred in the reception of the packet. This bit is reset to zero by the sender, and set to one whenever an error occurs in transmission of the packet.
payload_unit_start_indicator	1	A value of one indicates the presence of a pointer_field as the first byte of the payload (fifth byte of the packet)
transport_priority	1	Reserved; set to zero.
PID (see Note)	13	MCNS Data-Over-Cable well-known PID (0x1FFE)
transport_scrambling_control	2	Reserved; set to '00'.
adaptation_field_control	2	'01'; use of the adaptation_field is NOT ALLOWED on the MCNS PID.
continuity_counter	4	Cyclic counter within this PID
NOTE – In the future, additional PIDs MAY be assigned to a CM. See B.9.3.		

stuff_byte

This standard defines a stuff_byte pattern having a value (0xFF) that is used within the MCNS Payload to fill any gaps between the MCNS MAC frames. This value is chosen as an unused value for the first byte of the MCNS MAC frame. The 'FC' byte of the MAC Header will be defined to never contain this value. (FC_TYPE = '11' indicates a MAC-specific frame, and FC_PARM = '11111' is not currently used and, according to this specification, is defined as an illegal value for FC_PARM.)

pointer_field

The pointer_field is present as the fifth byte of the MPEG packet (first byte following the MPEG Header) whenever the PUSI is set to one in the MPEG Header. The interpretation of the pointer_field is as follows.

The pointer_field contains the number of bytes in this packet that immediately follow the pointer_field that the CM decoder must skip past before looking for the beginning of an MCNS MAC Frame. A pointer field MUST be present if it is possible to begin a Data-Over-Cable MAC Frame in the packet, and MUST point to either:

- 1) the beginning of the first MAC frame to start in the packet; or
- 2) any stuff_byte preceding the MAC frame.

B.5.5 Interaction with the MAC sublayer

MAC frames may begin anywhere within an MPEG Packet, MAC frames may span MPEG packets, and several MAC frames may exist within an MPEG Packet.

The following figures show the format of the MPEG packets that carry MCNS MAC frames. In all cases, the PUSI flag indicates the presence of the pointer_field as the first byte of the MPEG Payload.

Figure B.5-3 shows a MAC Frame that is positioned immediately after the pointer_field byte. In this case, pointer_field is zero, and the MCNS decoder will begin searching for a valid FC byte at the byte immediately following the pointer_field.

Figure B.5-4 shows the more general case where a MAC Frame is preceded by the tail of a previous MAC Frame and a sequence of stuffing bytes. In this case, the pointer_field still identifies the first byte after the tail of Frame #1 (a stuff_byte) as the position where the decoder should begin searching for a legal MAC sublayer FC value. This format allows the multiplexing operation in the CMTS to immediately insert a MAC Frame that is available for transmission if that frame arrives after the MPEG header and pointer_field have been transmitted.

MPEG Header (PUSI = 1)	pointer_field (= 0)	MAC Frame (up to 183 bytes)	stuff_byte(s) (0 or more)
---------------------------	------------------------	--------------------------------	------------------------------

Figure B.5-3/J.112 – Packet format where a MAC Frame immediately follows the pointer_field

In order to facilitate multiplexing of the MPEG packet stream carrying MCNS data with other MPEG-encoded data, the CMTS SHOULD NOT transmit MPEG packets with the MCNS PID which contain only stuff_bytes in the payload area. MPEG null packets SHOULD be transmitted instead. Note that there are timing relationships implicit in the MCNS MAC sublayer which must also be preserved by any MPEG multiplexing operation.

MPEG Header (PUSI = 1)	pointer_field (= M)	Tail of MAC Frame #1 (M bytes)	stuff_byte(s) (0 or more)	Start of MAC Frame #2
---------------------------	------------------------	-----------------------------------	------------------------------	--------------------------

Figure B.5-4/J.112 – Packet format with MAC Frame preceded by stuffing bytes

Figure B.5-5 shows that multiple MAC frames may be contained within the MPEG Packet. The MAC frames may be concatenated one after the other or be separated by an optional sequence of stuffing bytes.

MPEG Header (PUSI = 1)	pointer_field (= 0)	MAC Frame #1	MAC Frame #2	stuff_byte(s) (0 or more)	MAC Frame #3
---------------------------	------------------------	-----------------	-----------------	------------------------------	-----------------

Figure B.5-5/J.112 – Packet format showing multiple MAC frames in a single packet

Figure B.5-6 shows the case where a MAC Frame spans multiple MPEG packets. In this case, the pointer_field of the succeeding frame points to the byte following the last byte of the tail of the first frame.

The Transmission Convergence sublayer must operate closely with the MAC sublayer in providing an accurate timestamp to be inserted into the Time Synchronization message (refer to B.6.3.2.1 and B.6.5).

MPEG Header (PUSI = 1)	pointer_field (= 0)	stuff_byte(s) (0 or more)	Start of MAC Frame #1 (up to 183 bytes)	
MPEG Header (PUSI = 0)	Continuation of MAC Frame # 1 (184 bytes)			
MPEG Header (PUSI = 1)	pointer_field (= M)	Tail of MAC Frame #1 (M bytes)	stuff_byte(s) (0 or more)	Start of MAC Frame #2 (M bytes)

Figure B.5-6/J.112 – Packet format where a MAC Frame spans multiple packets

B.5.6 Interaction with the Physical layer

The MPEG-2 packet stream MUST be encoded according to [ITU-T J.83 B], including MPEG-2 transport framing using a parity checksum as described in [ITU-T J.83 B].

B.5.7 MPEG Header synchronization and recovery

The MPEG-2 packet stream SHOULD be declared "in frame" (i.e. correct packet alignment has been achieved) when five consecutive correct parity checksums, each 188 bytes from the previous one, have been received.

The MPEG-2 packet stream SHOULD be declared "out of frame", and a search for correct packet alignment started, when nine consecutive incorrect parity checksums are received.

The format of MAC frames is described in detail in B.6.

B.6 Media access control specification

B.6.1 Introduction

B.6.1.1 Overview

This subclause describes version 1.0 of the MCNS MAC protocol. Some of the MAC protocol highlights include:

- Bandwidth allocation controlled by CMTS.
- A stream of mini-slots in the upstream.
- Dynamic mix of contention- and reservation-based upstream transmit opportunities.
- Bandwidth efficiency through support of variable-length packets.
- Extensions provided for future support of ATM or other Data PDU.
- Class of service support.
- Extensions provided for security at the Data Link layer.
- Support for a wide range of data rates.

B.6.1.2 Definitions

B.6.1.2.1 MAC-sublayer domain

A MAC-sublayer domain is a collection of upstream and downstream channels for which a single MAC Allocation and Management protocol operates. Its attachments include one CMTS and some number of CMs. The CMTS MUST service all of the upstream and downstream channels; each CM MAY access one or more upstream and downstream channels.

B.6.1.2.2 MAC service access point

A MAC Service Access Point (MSAP) is an attachment to a MAC-sublayer domain.

B.6.1.2.3 Service ID

The concept of Service IDs is central to the operation of the MAC protocol. Service IDs provide both device identification and class-of-service management. In particular, they are integral to upstream bandwidth allocation.

A Service ID defines a particular mapping between a CM and the CMTS. This mapping is the basis on which bandwidth is allocated to the CM by the CMTS and by which class of service is implemented. Within a MAC-sublayer domain, all Service IDs MUST be unique.

The CMTS MAY assign one or more Service IDs (SIDs) to each CM, corresponding to the classes of service required by the CM. This mapping MUST be negotiated between the CMTS and the CM during CM registration.

In a basic CM implementation, a single Service ID can be used, for example to offer best-effort IP service. However, the Service ID concept allows for more complex CMs to be developed with support for multiple service classes while supporting interoperability with more basic modems. In particular, the Service ID concept is expected to support the concept of "data flows" on which protocols such as RSVP and RTP are based.

The Service ID is unique within a single MAC-sublayer domain. The length of the Service ID is 14 bits (although the Service ID is sometimes carried in the low-order bits of a 16-bit field).

B.6.1.2.4 Upstream intervals, Mini-slots and 6.25-μs increments

The upstream transmission time-line is divided into intervals by the upstream bandwidth allocation mechanism. Each interval is an integral number of mini-slots. A "mini-slot" is the unit of granularity for upstream transmission opportunities. There is no implication that any PDU can actually be transmitted in a single mini-slot. Each interval is labeled with a usage code which defines both the type of traffic that can be transmitted during that interval and the physical-layer modulation encoding. A mini-slot is a power-of-two multiple of 6.25-μs increments, i.e. 1, 2, 4, 8, 16, 32, 64, or 128 times 6.25 μs. The relationship between mini-slots, bytes, and time ticks is described further in B.6.5.4. The usage code values are defined in Table B.6-16 and allowed use is defined in B.6.3. The binding of these values to physical-layer parameters is defined in Table B.6-14.

B.6.1.2.5 Frame

A frame is a unit of data exchanged between two (or more) entities at the Data Link Layer. A MAC Frame consists of a MAC Header (beginning with a Frame Control byte; see Figure B.6-3), and may incorporate ATM cells or a variable-length data PDU. The variable-length PDU includes a pair of 48-bit addresses, data, and a CRC sum. In special cases, the MAC Header may encapsulate multiple MAC frames (see B.6.2.5.4).

B.6.1.3 Future use

A number of fields are defined as being "for future use" in the various MAC frames described in this annex. These fields MUST NOT be interpreted or used in any manner by this version (1.0) of the MAC protocol.

B.6.2 MAC Frame formats

B.6.2.1 Generic MAC Frame format

A MAC Frame is the basic unit of transfer between MAC sublayers at the CMTS and the cable modem. The same basic structure is used in both the upstream and downstream directions. MAC frames are variable in length. The term "Frame" is used in this context to indicate a unit of information that is passed between MAC sublayer peers. This is not to be confused with the term "framing" that indicates some fixed timing relationship.

There are three distinct regions to consider, as shown in Figure B.6-1. Preceding the MAC Frame is either PMD sublayer overhead (upstream) or an MPEG transmission convergence header (downstream). The first part of the MAC Frame is the MAC Header. The MAC Header uniquely identifies the contents of the MAC Frame. Following the header is the optional Data PDU region. The format of the Data PDU and whether it is even present is described in the MAC Header.

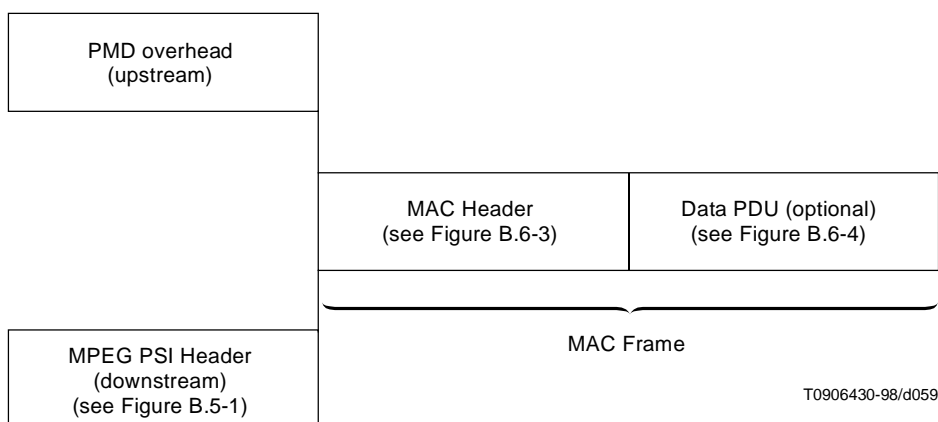

Figure B.6-1/J.112 – Generic MAC Frame format

B.6.2.1.1 PMD overhead

In the upstream direction, the PHY layer indicates the start of the MAC Frame to the MAC sublayer. From the MAC sublayer's perspective, it only needs to know the total amount of overhead so it can account for it in the Bandwidth Allocation process. More information on this may be found in the PMD sublayer clause (see B.6.4).

The FEC overhead is spread throughout the MAC frame and is assumed to be transparent to the MAC data stream. The MAC sublayer does need to be able to account for the overhead when doing Bandwidth Allocation. More information on this may be found in the Upstream Bandwidth Allocation clause (see B.6.4).

B.6.2.1.2 MAC Frame transport

The transport of MAC frames by the PMD sublayer for upstream channels is shown in Figure B.6-2.

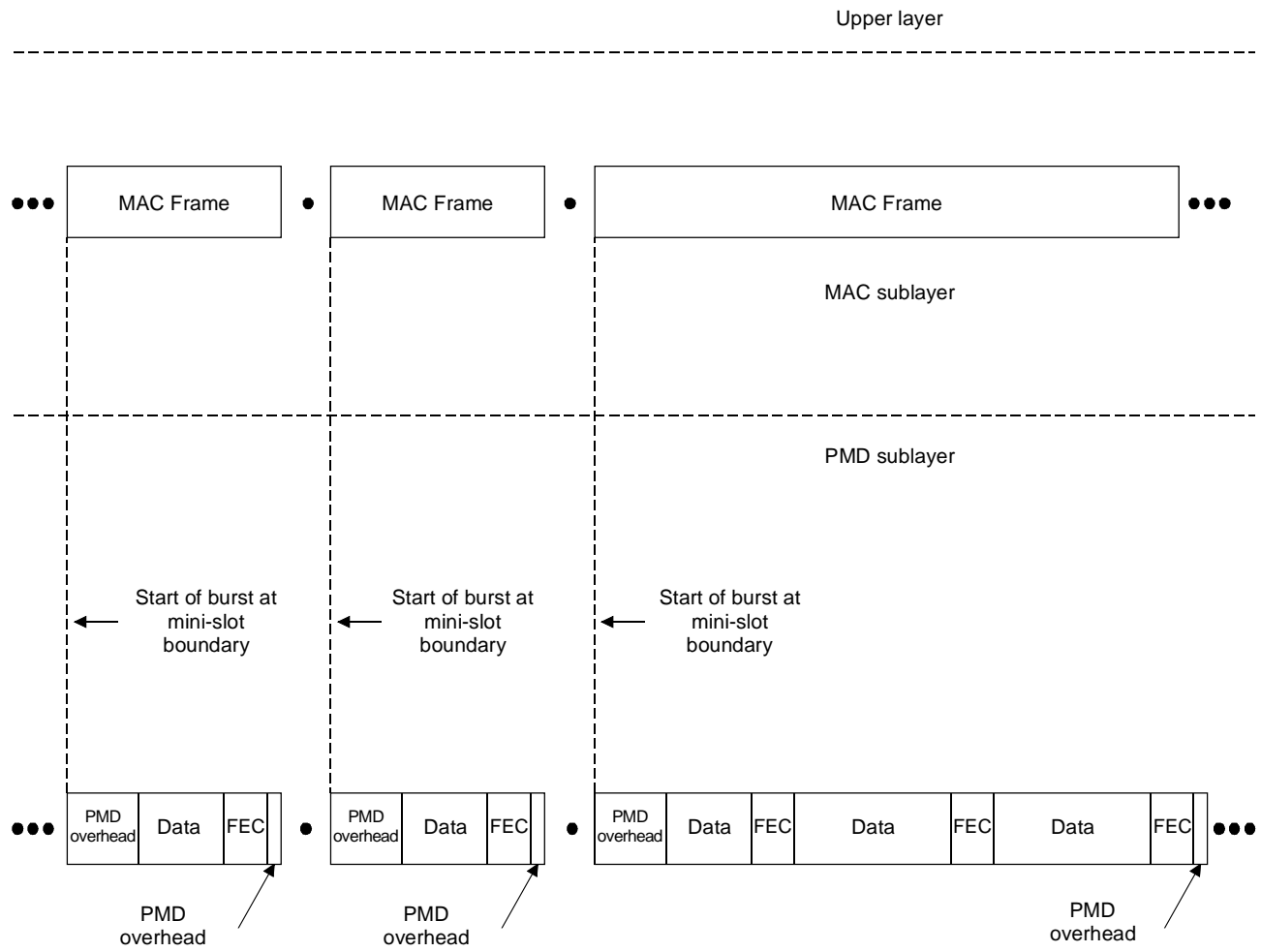

Figure B.6-2/J.112 – Upstream MAC/PMD convergence

The layering of MAC frames over MPEG in the downstream channel is described in B.5.

B.6.2.1.3 Ordering of bits and octets

Within an octet, the least-significant bit is the first transmitted on the wire. This follows the convention used by Ethernet and [ISO/IEC 8802-3]. This is often called bit-little-indian order³.

³ This applies to the upstream channel only. For the downstream channel, the MPEG transmission convergence sublayer presents an octet-wide interface to the MAC, so the MAC sublayer does not define the bit order.

Within the MAC layer, when numeric quantities are represented by more than one octet (i.e. 16-bit and 32-bit values), the octet containing the most-significant bits is the first transmitted on the wire. This subclause follows the textual convention that when bit-fields are presented in tables, the most-significant bits are topmost in the table. For example, in Table B.6-2, FC_TYPE occupies the two most-significant bits and EHDR_ON occupies the least-significant bit. This is sometimes called byte-big-indian order.

B.6.2.1.3.1 Representing negative numbers

Signed integer values will be transmitted and received in two's complement format.

B.6.2.1.4 MAC Header format

The MAC Header format MUST be as shown in Figure B.6-3.

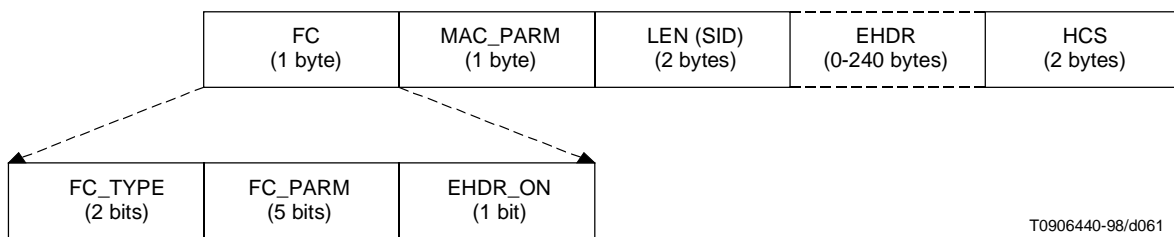

Figure B.6-3/J.112 – MAC Header format

All MAC headers MUST have the general format as shown in Table B.6-1. The Frame Control (FC) field is the first byte and uniquely identifies the rest of the contents within the MAC Header. The FC field is followed by 3 bytes of MAC control; an OPTIONAL Extended Header (EHDR) field; plus a Header Check Sequence (HCS) to ensure the integrity of the MAC Header.

Table B.6-1/J.112 – Generic MAC Header format

MAC Header field	Usage	Size
FC	Frame Control: identifies type of MAC Header	8 bits
MAC_PARM	Parameter field whose use is dependent on FC: if EHDR_ON = 1; used for EHDR field length (ELEN) else if for concatenated frames (see Table B.6-14) used for MAC frame count else (for Requests only) indicates the number of mini-slots and/or ATM cells requested	8 bits
LEN (SID)	The length of the MAC frame: the length is defined to be the sum of the number of bytes in the extended header (if present) and the number of bytes following the HCS field. (For a REQ Header, this field is the Service ID instead)	16 bits
EHDR	Extended MAC Header (where present; variable size).	0-240 bytes
HCS	MAC Header check sequence	2 bytes
	Length of a MAC Header	6 bytes + EHDR

The HCS field is a 16-bit CRC that ensures the integrity of the MAC Header, even in a collision environment. The HCS field coverage MUST include the entire MAC Header, starting with the FC field and including any EHDR field that may be present. The HCS is calculated using CRC-CCITT ($x^{16} + x^{12} + x^5 + 1$) as defined in [ITU-T X.25].

The FC field is broken down into the FC_TYPE sub-field, FC_PARM sub-field and an EHDR_ON indication flag. The format of the FC field MUST be as shown in Table B.6-2.

Table B.6-2/J.112 – FC field format

FC field	Usage	Size
FC_TYPE	MAC Frame Control type field: 00: Packet PDU MAC Header 01: ATM PDU MAC Header 10: Reserved PDU MAC Header 11: MAC-specific Header	2 bits
FC_PARM	Parameter bits, use dependent on FC_TYPE.	5 bits
EHDR_ON	When = 1, indicates that EHDR field is present. [Length of EHDR (ELEN) determined by MAC_PARM field]	1 bit

The FC_TYPE sub-field is the two MSBs of the FC field. These bits MUST always be interpreted in the same manner to indicate one of four possible MAC frame formats. These types include: MAC Header with Packet PDU; MAC Header with ATM cells; MAC Header reserved for future PDU types; or a MAC Header used for specific MAC control purposes. These types are spelled out in more detail in the remainder of this subclause.

The five bits following the FC_TYPE sub-field form the FC_PARM sub-field. The use of these bits is dependent on the type of MAC Header. The LSB of the FC field is the EHDR_ON indicator. If this bit is set, then an Extended Header (EHDR) is present. The EHDR provides a mechanism to allow the MAC Header to be extensible in an interoperable manner.

The Transmission Convergence Sublayer stuff-byte pattern is defined to be a value of 0xFF. This precludes the use of FC byte values which have FC_TYPE = '11' and FC_PARM = '11111'.

The MAC_PARM field of the MAC Header serves several purposes depending on the FC field. If the EHDR_ON indicator is set, then the MAC_PARM field MUST be used as the Extended Header length (ELEN). The EHDR field MAY vary from 0 to 240 bytes. If this is a concatenation MAC Header, then the MAC_PARM field represents the number of MAC frames (CNT) in the concatenation (see B.6.2.5.4). If this is a Request MAC Header (REQ) (see B.6.2.5.3), then the MAC_PARM field represents the amount of bandwidth being requested. In all other cases, the MAC_PARM field is reserved for future use.

The third field has two possible uses. In most cases, it indicates the length (LEN) of this MAC frame. In one special case, the Request MAC Header, it is used to indicate the cable modem's Service ID since no PDU follows the MAC Header.

The Extended Header (EHDR) field provides extensions to the MAC frame format. It is used to implement data link security and can be extended to add support for additional functions in future releases. Initial implementations SHOULD pass this field to the processor. This will allow future software upgrades to take advantage of this capability. (Refer to B.6.2.6, "Extended MAC Headers", for details.)

B.6.2.1.5 Data PDU

The MAC Header MAY be followed by a Data PDU. The type and format of the Data PDU is defined in the Frame Control field of the MAC Header. The FC field explicitly defines a Packet Data PDU, an ATM Data PDU, a MAC Header only frame (no PDU) and a reserved code point (used as an escape mechanism for future extensions). All CMs MUST use the length in the MAC Header to skip over any reserved data.

B.6.2.2 Packet-Based MAC frames

B.6.2.2.1 Variable-length packets

The MAC sublayer MUST support a variable-length Ethernet and [ISO/IEC 8802-3] type Packet Data PDU. The Packet PDU MUST be passed across the network in its entirety, including its original CRC. A unique Packet MAC Header is appended to the beginning. The frame format without an Extended header MUST be as shown in Figure B.6-4 and Table B.6-3.

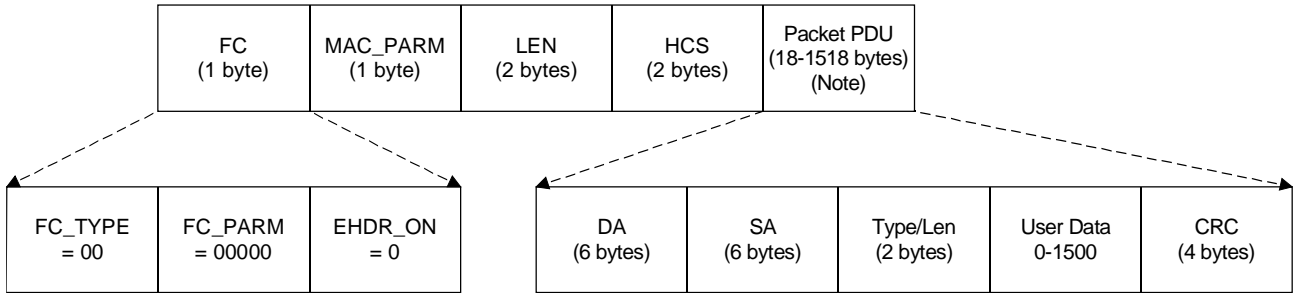

T0904910-97/d062

NOTE – Frame size is limited to 1518 bytes in the absence of VLAN tagging. Cooperating devices which implement IEEE 802.1Q VLAN tagging MAY use a frame size up to 1522 bytes.

Figure B.6-4/J.112 – Ethernet and ISO/IEC 8802-3 Packet PDU format

Table B.6-3/J.112 – Packet PDU format

Field	Usage	Size
FC	FC_TYPE = 00; Packet MAC Header. FC_PARM[4:0] = 00000; other values reserved for future use and ignored. EHDR_ON = 0; no EHDR present in this example.	8 bits
MAC_PARM	Reserved, MUST be set to zero if there is no EHDR; otherwise set to length of EHDR.	8 bits
LEN	LEN = n; length of Packet PDU in bytes.	16 bits
EHDR	Extended MAC Header not present in this example	0 bytes
HCS	MAC Header check sequence	2 bytes
Packet data	Packet PDU: DA – 48 bit Destination address SA – 48 bit Source address Type/Len – 16-bit Ethernet type or [ISO/IEC 8802-3] length field User Data (variable length, 0-1500 bytes) CRC – 32-bit CRC over packet PDU (as defined in Ethernet and [ISO/IEC 8802-3])	n bytes
	Length of Packet MAC frame	6 + n bytes

B.6.2.3 ATM cell MAC frames

ATM transport is not defined in this specification.

In order to allow current frame-based CMs to operate in a possible future downstream channel in which ATM cells and frames are mixed, a code point for ATM has been defined. This will allow current modems to ignore ATM cells while receiving frames. The frame format MUST be as shown in Figure B.6-5 and Table B.6-4.

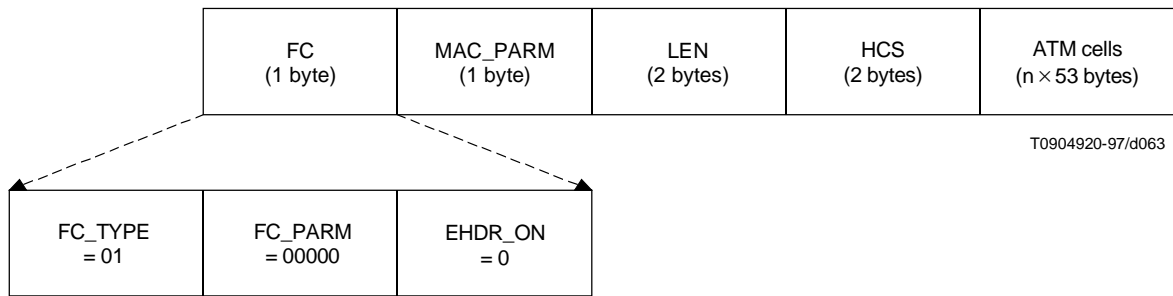

Figure B.6-5/J.112 – ATM cell MAC Frame format

Table B.6-4/J.112 – ATM cell MAC Frame format

Field	Usage	Size
FC	FC_TYPE = 01; ATM cell format MAC Header. FC_PARM[4:0] = 00000; other values reserved for future use and ignored. EHDR_ON = 0; no EHDR present in this example.	8 bits
MAC_PARM	Reserved, MUST be set to zero if there is no EHDR; otherwise set to length of EHDR.	8 bits
LEN	LEN = $n \times 53$; length of ATM cell PDU, in bytes	16 bits
EHDR	Extended MAC Header not present in this example	0 bytes
HCS	MAC Header check sequence	2 bytes
ATM data	ATM cell PDU	$n \times 53$ bytes
	Length of ATM cells based MAC Frame	$6 + n \times 53$ bytes

B.6.2.4 Reserved PDU MAC frames

The MAC sublayer provides a reserved FC code point to allow for support of future (to be defined) PDU formats. The FC field of the MAC Header indicates that a Reserved PDU is present. This PDU MUST be silently discarded by MAC implementations of this version (1.0) of the specification. Compliant version 1.0 implementations MUST use the length field to skip over the Reserved PDU.

The format of the Reserved PDU without an extended header MUST be as shown in Figure B.6-6 and Table B.6-5.

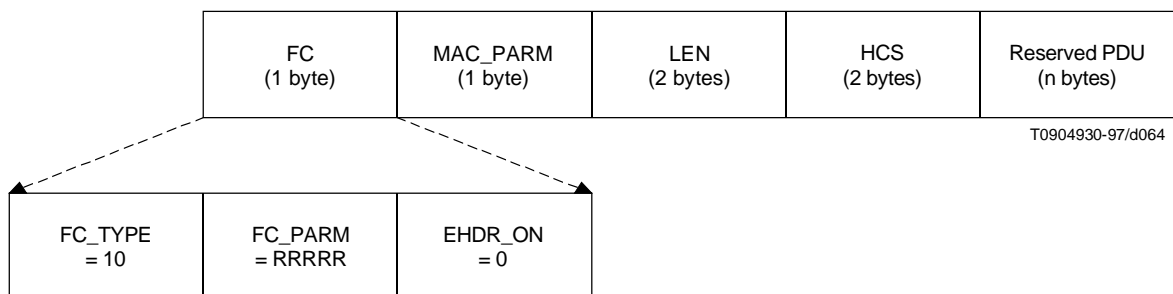

Figure B.6-6/J.112 – Reserved PDU format

Table B.6-5/J.112 – Reserved PDU format

Field	Usage	Size
FC	FC_TYPE = 10; Reserved PDU MAC Header. FC_PARM[4:0]; reserved for future use. EHDR_ON = 0; no EHDR present in this example.	8 bits
MAC_PARM	Reserved for future use	8 bits
LEN	LEN = n; length of Reserved PDU in bytes.	16 bits
EHDR	EHDR = 0; extended MAC Header not present in this example.	0 bytes
HCS	MAC Header check sequence	2 bytes
User data	Reserved Data PDU	n bytes
	Length of a Reserved PDU MAC Frame	6 + n bytes

B.6.2.5 MAC-specific headers

There are several MAC headers which are used for very specific functions. These functions include support for downstream timing and upstream ranging/power adjust, requesting bandwidth and concatenating multiple MAC frames.

B.6.2.5.1 Timing Header

A specific MAC Header is identified to help support the timing and adjustments required. In the downstream, this MAC Header MUST be used to transport the Global Timing Reference to which all cable modems synchronize. In the upstream, this MAC Header MUST be used as part of the Ranging message needed for a cable modem’s timing and power adjustments. The Timing MAC Header is followed by a Packet Data PDU. The format MUST be as shown in Figure B.6-7 and Table B.6-6.

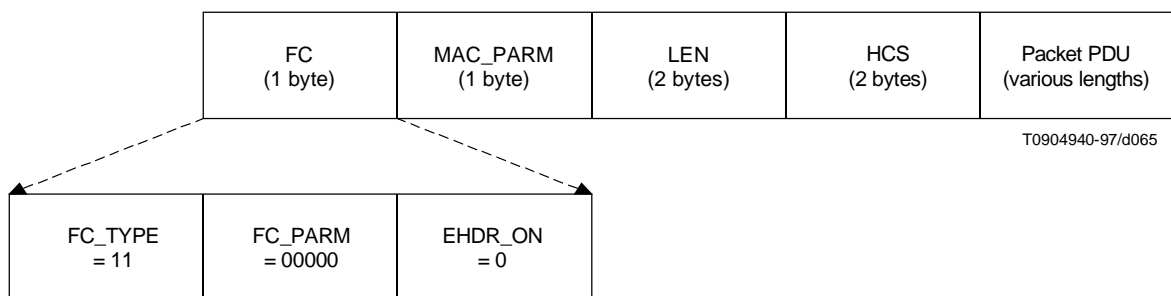

Figure B.6-7/J.112 – Timing MAC Header

B.6.2.5.2 MAC management Header

A specific MAC Header is identified to help support the MAC management messages required. This MAC Header MUST be used to transport all MAC management messages (refer to B.6.3). The format MUST be as shown Figure B.6-8 and Table B.6-7.

Table B.6-6/J.112 – Timing MAC Header format

Field	Usage	Size
FC	FC_TYPE = 11; MAC-specific Header. FC_PARM[4:0] = 00000; timing MAC Header. EHDR_ON = 0; extended header prohibited for SYNC and RNG-REQ.	8 bits
MAC_PARM	Reserved for future use	8 bits
LEN	LEN = n; length of Packet PDU in bytes.	16 bits
EHDR	Extended MAC Header not present	0 bytes
HCS	MAC Header check sequence	2 bytes
Packet data	MAC Management message: SYNC message (downstream only) RNG-REQ (upstream only)	n bytes
	Length of Timing Message MAC Frame	6 + n bytes

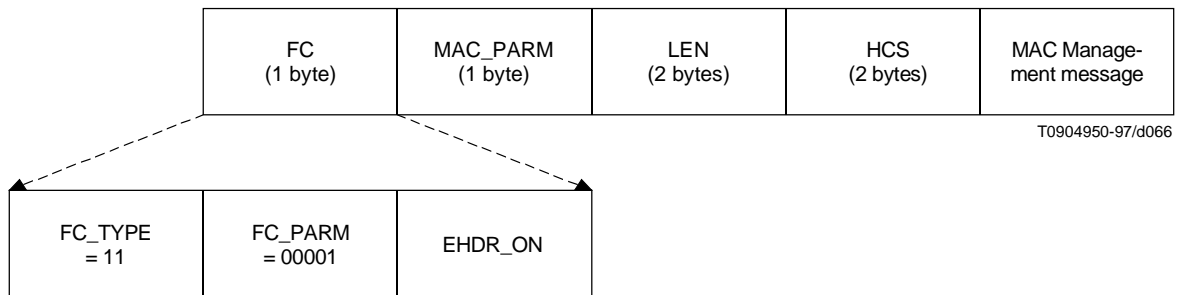

Figure B.6-8/J.112 – Management MAC Header

Table B.6-7/J.112 – Management MAC Header format

Field	Usage	Size
FC	FC_TYPE = 11; MAC-specific Header. FC_PARM[4:0] = 00001 EHDR_ON	8 bits
MAC_PARM	Reserved for future use	8 bits
LEN	LEN = n; length of Packet PDU in bytes.	16 bits
EHDR	Extended MAC Header not present in this example	0 bytes
HCS	MAC Header check sequence	2 bytes
Packet data	MAC Management message	n bytes
	Length of Management MAC Frame	6 + n bytes + EHDR

B.6.2.5.3 Request MAC Header

The Request MAC Header is the basic mechanism that a cable modem uses to request bandwidth. As such, it is only applicable in the upstream. There MUST be no Data PDUs following the Request MAC Header. The general format of the Request MUST be as shown in Figure B.6-9 and Table B.6-8.

Because the Request MAC Header does not have a Data PDU following it, the LEN field is not needed. The LEN field MUST be replaced with an SID. The SID MUST uniquely identify a particular service queue within a given station.

The bandwidth request, REQ, MUST be specified in either mini-slots or in ATM cells. The REQ field MUST indicate the current total amount of bandwidth requested for this service queue including appropriate allowance for the PHY overhead.

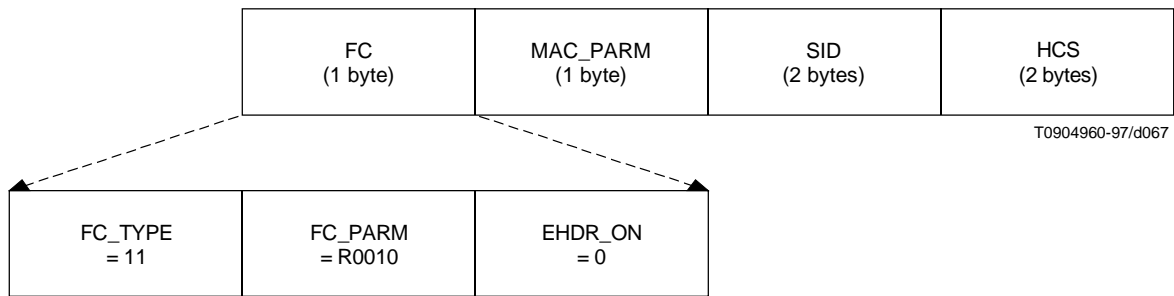

Figure B.6-9/J.112 – Request MAC Header format

Table B.6-8/J.112 – Request MAC Header (REQ) format

Field	Usage	Size
FC	FC_TYPE = 11; MAC-specific Header. FC_PARM[3:0] = 0010; MAC Header only; no data PDU following. FC_PARM[4] indicates if REQ is in mini-slots or ATM cells. [4] = 0; mini-slot REQ. [4] = 1; ATM cell REQ. EHDR_ON = 0; no EHDR allowed.	8 bits
MAC_PARM	REQ, total amount of bandwidth requested (upstream only): if FC_PARM[4] = 0; REQ is number of mini-slots. if FC_PARM[4] = 1; REQ is number of ATM cells.	8 bits
SID	Service ID (0 ...0x3FFF)	16 bits
EHDR	Extended MAC Header not allowed	0 bytes
HCS	MAC Header check sequence	2 bytes
	Length of a REQ MAC Header	6 bytes

B.6.2.5.4 Concatenation

A Specific MAC Header is defined to allow multiple MAC frames to be concatenated. This allows a single MAC "burst" to be transferred across the network. The PHY overhead and the Concatenation MAC Header only occur once. Concatenation of multiple MAC frames MUST be as shown in Figure B.6-10.

A compliant CMTS & CM MAY support concatenation.

NOTE – Concatenation only applies to upstream traffic. Concatenation MUST NOT be used on downstream traffic.

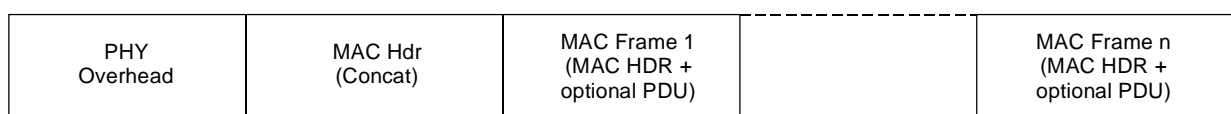

Figure B.6-10/J.112 – Concatenation of multiple MAC frames

Only one Concatenation MAC Header MUST be present per MAC "burst". Nested concatenation MUST NOT be allowed. Immediately following the Concatenation MAC Header MUST be the MAC Header of the first MAC Frame. Information within the MAC Header indicates the length of the first MAC Frame and provides a means to find the start of the next MAC Frame. Each MAC Frame within a concatenation MUST be unique and MAY be of any type. This means that Packet, ATM, Reserved PDU and MAC-specific frames MAY be mixed together. The embedded MAC frames MAY be addressed to different destinations and MUST be delivered as if they were transmitted individually.

The format of the Concatenation MAC Header MUST be as shown in Figure B.6-11 and Table B.6-9.

The MAC_PARM field MUST be used to indicate the total count of MAC frames (CNT) in this concatenation burst. If the count equals zero, then there is an unspecified number of MAC frames. The LEN field indicates the length of the entire concatenation. This is slightly different than the LEN field within an individual MAC Header which only indicates the length of that MAC frame.

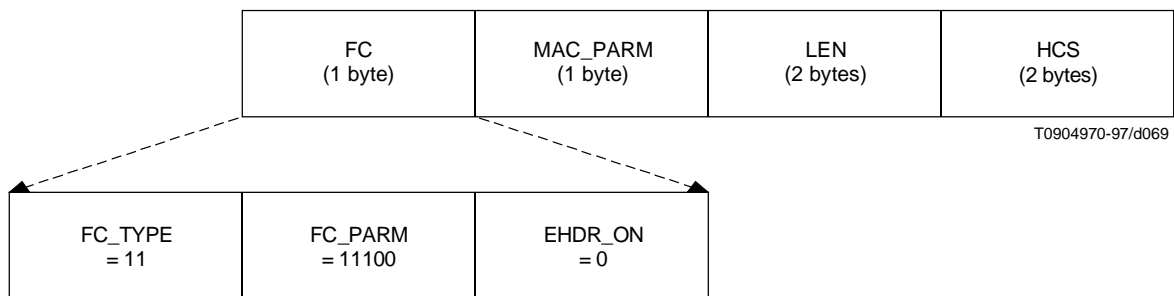

Figure B.6-11/J.112 – Concatenation MAC Header format

Table B.6-9/J.112 – Concatenated MAC Frame format

Field	Usage	Size
FC	FC_TYPE = 11; MAC-specific Header FC_PARM[4:0] = 11100; Concatenation MAC Header EHDR_ON = 0; no EHDR with Concatenation Header	8 bits
MAC_PARM	CNT, number of MAC frames in this concatenation CNT = 0 indicates unspecified number of MAC frames	8 bits
LEN	LEN = x + ... + y; length of all following MAC frames in bytes	16 bits
EHDR	Extended MAC Header MUST NOT be used	0 bytes
HCS	MAC Header check sequence	2 bytes
MAC Frame 1	first MAC frame: MAC Header plus OPTIONAL data PDU	x bytes
MAC Frame n	last MAC frame: MAC Header plus OPTIONAL data PDU	y bytes
	Length of Concatenated MAC Frame	6 + LEN bytes

B.6.2.6 Extended MAC headers

Every MAC Header, except the Timing, Concatenation MAC Header and Request Frame, has the capability of defining an Extended Header field (EHDR). The presence of an EHDR field MUST be indicated by the EHDR_ON flag in the FC field being set. Whenever this bit is set, then the MAC_PARM field MUST be used as the EHDR length (ELEN). The minimum defined EHDR is 1 byte. The maximum EHDR length is 240 bytes.

A compliant CMTS & CM MUST support extended headers.

The format of a generic MAC Header with an Extended Header included MUST be as shown in Figure B.6-12 and Table B.6-10.

NOTE – Extended Headers MUST NOT be used in a Concatenation MAC Header, but MAY be included as part of the MAC headers within the concatenation.

Extended headers MUST NOT be used in Request and Timing MAC headers.

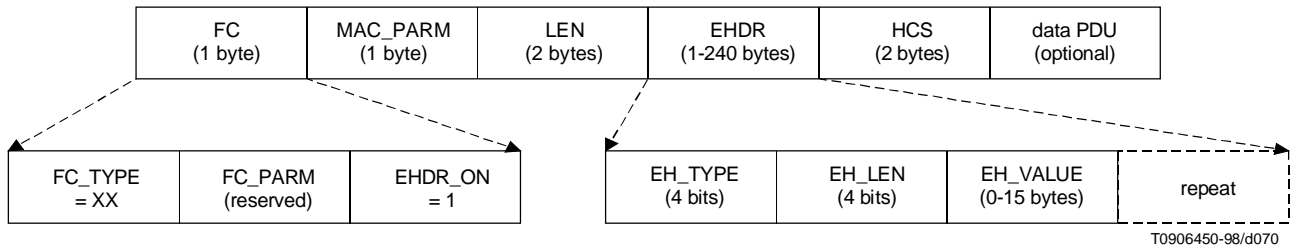

Figure B.6-12/J.112 – Extended MAC format

Table B.6-10/J.112 – Extended Header format

Field	Usage	Size
FC	FC_TYPE = XX; applies to all MAC Headers. FC_PARM[4:0] = XXXXX; dependent on FC_TYPE. EHDR_ON = 1; EHDR present in this example.	8 bits
MAC_PARM	ELEN = x; length of EHDR in bytes.	8 bits
LEN	LEN = x + y; length of EHDR plus OPTIONAL data PDU in bytes.	16 bits
EHDR	Extended MAC Header present in this example	x bytes
HCS	MAC Header check sequence	2 bytes
PDU	OPTIONAL data PDU	y bytes
	Length of MAC Frame with EHDR	6 + x + y bytes

Since the EHDR increases the length of the MAC frame, the LEN field MUST be increased to include both the length of the Data PDU and the length of the EHDR.

The EHDR field consists of one or more EH elements. Each EH element is variable sized. The first byte of the EH element MUST contain a type and a length field. Every CM MUST use this length to skip over any unknown EH elements. The format of an EH element MUST be as shown in Table B.6-11.

Table B.6-11/J.112 – EH element format

EH element fields	Usage	Size
EH_TYPE	EH element type field	4 bits
EH_LEN	Length of EH_VALUE	4 bits
EH_VALUE	EH element data	0-15 bytes

The types of EH element defined in Table B.6-12 MUST be supported. Reserved and extended types are undefined at this point and SHOULD be ignored.

The first eight EH element types are intended for one-way transfer between the cable modem and the CMTS. The next seven EH element types are for end-to-end usage within a MAC-sublayer domain. Thus, the information attached to the EHDR on the upstream MUST also be attached when the information is forwarded. The final EH element type is an escape mechanism that allows for more types and longer values, and MUST be as shown in Table B.6-12.

Table B.6-12/J.112 – EH element format

EH_TYPE	EH_LEN	EH_VALUE
0	0	Null configuration setting; may be used to pad the extended header. The EH_LEN MUST be zero, but the configuration setting may be repeated.
1	3	Request: mini-slots requested (1 byte); SID (2 bytes) [CM → CMTS].
2	2	Acknowledgment requested; SID (2 bytes) [CM → CMTS].
3 (= BP_UP)	4	Upstream Privacy EH element [MCNS8]
4 (= BP_DOWN)	4	Downstream Privacy EH element [MCNS8]
5 (= SS_UP)	8 or 9	Upstream Security Header [MCNS2]
6 (= SS_DOWN)	8 or 9	Downstream Security Header [MCNS2]
7		Reserved
8	4	Reserved
10-14		Reserved [CM ↔ CM]
15	XX	Extended EH element: EHX_TYPE (1 byte), EHX_LEN (1 byte), EH_VALUE (length determined by EHX_LEN).

B.6.2.7 Error-Handling

The cable network is a potentially harsh environment that may cause several different error conditions to occur. This subclause, together with B.7.2.17, describes the procedures that are required when an exception occurs at the MAC framing level.

The most obvious type of error occurs when the HCS on the MAC Header fails. This may be a result of noise on the network or possibly by collisions in the upstream channel. Framing recovery on the downstream channel is performed by the MPEG transmission convergence sublayer. In the upstream channel, framing is recovered on each transmitted burst, such that framing on one burst is independent of framing on prior bursts. Hence, framing errors within a burst are handled by simply ignoring that burst, i.e. errors are unrecoverable until the next burst.

A second exception, which applies only to the upstream, occurs when the Length field is corrupted and the MAC thinks the frame is longer than it actually is. Synchronization will recover at the next valid upstream data interval.

For every MAC transmission, the HCS MUST be verified. When a bad HCS is detected, the MAC Header and any payload MUST be dropped.

For Packet PDU transmissions, a bad CRC MAY be detected. Since the CRC only covers the Data PDU and the HCS covers the MAC Header; the MAC Header is still considered valid. Thus, the Packet PDU MUST be dropped, but any pertinent information in the MAC Header (e.g. bandwidth request information) MAY be used.

B.6.3 MAC Management messages

B.6.3.1 MAC Management message Header

MAC management messages MUST be encapsulated in an LLC unnumbered information frame per [ISO/IEC 8802-2], which in turn is encapsulated within the cable network MAC framing, as shown in Figure B.6-13. Figure B.6-13 shows the MAC Header and the MAC Management Message Header fields which are common across all MAC Management messages.

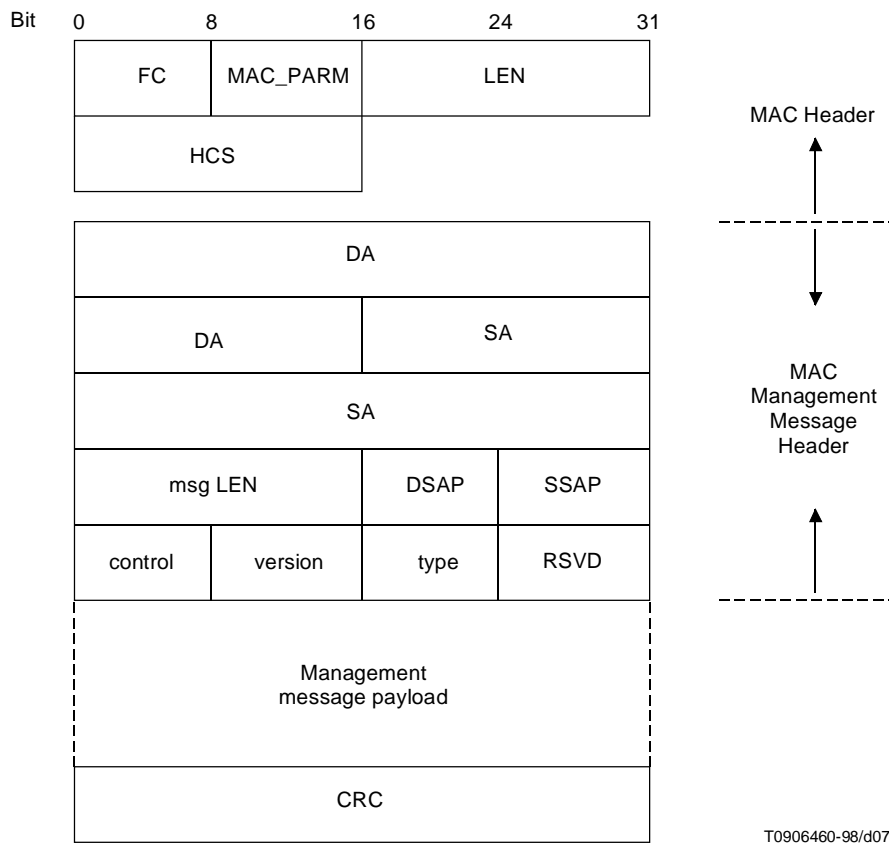

Figure B.6-13/J.112 – MAC Header and MAC Management Message Header fields

The fields MUST be as defined below:

FC, MAC_PARM, LEN, HCS	Common MAC frame header – Refer to B.6.2.1.4 for details. All messages use a MAC-specific header.
Destination Address (DA)	MAC management frames will be addressed to a specific CM unicast address or to the MCNS management multicast address. These MCNS MAC management addresses are described in Appendix B.I.
Source Address (SA)	The MAC address of the source CM or CMTS system.
Msg Length	Length of the MAC message from DSAP to the end of the payload.
DSAP	The LLC null SAP (00) as defined by [ISO/IEC 8802-2].
SSAP	The LLC null SAP (00) as defined by [ISO/IEC 8802-2].
Control	Unnumbered information frame (03) as defined by [ISO/IEC 8802-2].
Version	1 octet This field defines the version of the MAC management protocol in use. Set to 1 for this version.
Type	1 octet This field defines the type of this particular MAC management message.
RSVD	1 octet This field is used to align the message payload on a 32-bit boundary. Set to 0 for this version.
Management Message Payload	Variable length As defined for each specific management message.
CRC	Covers message including header fields (DA, SA, ...). Polynomial defined by [ISO/IEC 8802-3].

Table B.6-13/J.112 – MAC Management message types

Type value	Message name	Message description
1	SYNC	Timing Synchronization
2	UCD	Upstream Channel Descriptor
3	MAP	Upstream Bandwidth Allocation
4	RNG-REQ	Ranging Request
5	RNG-RSP	Ranging Response
6	REG-REQ	Registration Request
7	REG-RSP	Registration Response
8	UCC-REQ	Upstream Channel Change Request
9	UCC-RSP	Upstream Channel Change Response
10	TRI-TCD	Telephony Channel Descriptor [MCNS6]
11	TRI-TSI	Termination System Information [MCNS6]
12	BPKM-REQ	Privacy Key Management Request [MCNS8]
13	BPKM-RSP	Privacy Key Management Response [MCNS8]
14-255		Reserved for future use

B.6.3.2 MAC management messages

A compliant CMTS or CM MUST support the following management message types.

B.6.3.2.1 Time Synchronization (SYNC)

Time Synchronization (SYNC) MUST be transmitted by CMTS at a periodic interval to establish MAC sublayer timing. This message MUST use an FC field of type: Timing. This MUST be followed by a Packet PDU in the format shown in Figure B.6-14.

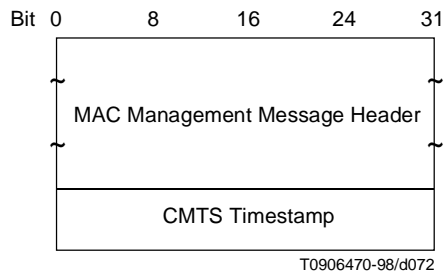

Figure B.6-14/J.112 – Format of Packet PDU following the timing Header

The parameters shall be as defined below:

CMTS Timestamp An incrementing 32-bit timestamp based on a timebase reference clock at the CMTS. Units are in 1/64th of a Timebase Tick (i.e. $6.25/64 \mu s^4$).

⁴ Since the SYNC message applies to all upstream channels within this MAC domain, units were chosen to be independent of the symbol rate of any particular upstream channel. A Timebase Tick represents the smallest possible mini-slot at the highest possible symbol rate. See B.6.5.4 for time-unit relationships.

B.6.3.2.2 Upstream Channel Descriptor (UCD)

An Upstream Channel Descriptor MUST be transmitted by the CMTS at a periodic interval to define the characteristics of an upstream channel (see Figure B.6-15). A separate message MUST be transmitted for each active upstream.

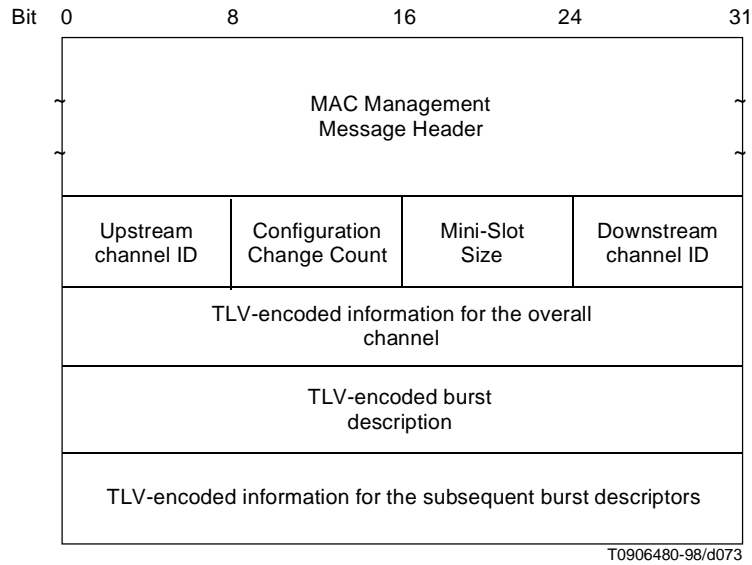

Figure B.6-15/J.112 – Upstream channel descriptor

To provide for flexibility, the message parameters following the channel ID MUST be encoded in a Type/Length/Value (TLV) form in which the type and length fields are each 1 octet long. Using this encoding, new parameters MAY be added which not all CMs can interpret. A CM which does not recognize a parameter type MUST skip over this parameter and MUST NOT treat the event as an error condition.

A CMTS MUST generate UCDs in the format shown in Figure B.6-15, including all of the following parameters:

- Configuration Change Count** Incremented by one (modulo the field size) by the CMTS whenever any of the values of this channel descriptor change. If the value of this count in a subsequent UCD remains the same, the CM can quickly decide that the remaining fields have not changed, and may be able to disregard the remainder of the message. This value is also referenced from the MAP.
- Mini-Slot Size** The size T of the Mini-Slot for this upstream channel in units of the Timebase Tick of 6.25 μs. Allowable values are $T = 2^M$, $M = 0, 1, \dots, 7$. That is, $T = 1, 2, 4, 8, 16, 32, 64, \text{ or } 128$.
- upstream channel ID** The identifier of the upstream channel to which this message refers. This identifier is arbitrarily chosen by the CMTS and is only unique within the MAC-sublayer domain.
- downstream channel ID** The identifier of the downstream channel on which this message has been transmitted. This identifier is arbitrarily chosen by the CMTS and is only unique within the MAC-sublayer domain.

All other parameters are coded as TLV tuples. Channel-wide parameters (types 1-3 in Table B.6-14) must precede burst descriptors (type 4 below).

Table B.6-14/J.112 – Channel TLV parameters

Name	Type (1 byte)	Length (1 byte)	Value (Variable length)
Symbol Rate	1	1	Multiples of base rate of 160 ksym/s. (Value is 1, 2, 4, 8, or 16.)
Frequency	2	4	Upstream center frequency (Hz)
Preamble Pattern	3	1-128	Preamble superstring. All burst-specific preamble values are chosen as bit-substrings of this string. The first byte of the Value field contains the first 8 bits of the superstring, with the first bit of the preamble superstring in the MSB position of the first Value field byte, the eighth bit of the preamble superstring in the LSB position of the first Value field byte; the second byte in the Value field contains the second eight bits of the superstring, with the ninth bit of the superstring in the MSB of the second byte and sixteenth bit of the preamble superstring in the LSB of the second byte, and so forth.
Burst Descriptor	4		May appear more than once; described below. The length is the number of bytes in the overall object, including embedded TLV items.

Burst Descriptors are compound TLV encodings that define, for each type of upstream usage interval, the physical-layer characteristics that are to be used during that interval. The upstream interval usage codes are defined in the MAP message (see B.6.3.2.3 and Figure B.6-16).

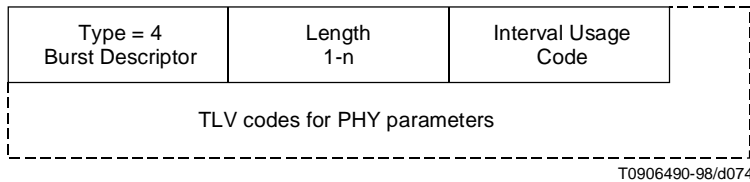

Figure B.6-16/J.112 – Top-level encoding for a Burst Descriptor

A Burst Descriptor **MUST** be included for each interval usage code that is to be used in the allocation MAP. The interval usage code above must be one of the values from Table B.6-16.

Within each Burst Descriptor is an unordered list of Physical-layer attributes, encoded as TLV values. These attributes are shown in Table B.6-15.

B.6.3.2.2.1 Example of UCD encoded TLV data

An example of UCD encoded TLV data is given in Figure B.6-17.

Table B.6-15/J.112 – Upstream Physical-Layer Burst Attributes

Name	Type (1 byte)	Length (1 byte)	Value (Variable Length)
Modulation Type	1	1	1 = QPSK, 2 = 16 QAM
Differential Encoding	2	1	1 = on, 2 = off
Preamble Length	3	2	Up to 1024 bits. The value must be an integral number of symbols (a multiple of 2 for QPSK and 4 for 16 QAM)
Preamble Value Offset	4	2	Identifies the bits to be used for the preamble value. This is specified as a starting offset into the Preamble Pattern (see Table B.6-14). That is, a value of zero means that the first bit of the preamble for this burst type is the value of the first bit of the Preamble Pattern. A value of 100 means that the preamble is to use the 101st and succeeding bits from the Preamble Pattern. This value must be a multiple of the symbol size. The first bit of the Preamble Pattern is the first bit into the symbol mapper (Figure B.4-8), and is I_1 in the first symbol of the burst (see B.4.2.2.2).
FEC Error Correction (T bytes)	5	1	0-10 bytes: zero implies no Forward Error Correction.
FEC Codeword Length (k)	6	1	Fixed: 16 to 253 (assuming FEC on) Shortened: 16 to 253 (assuming FEC on)
Scrambler Seed	7	2	The 15-bit seed value.
Maximum Burst Size	8	1	The maximum number of mini-slots that can be transmitted during this burst type. Absence of this configuration setting implies that the burst size is limited elsewhere. This value MUST be used when the interval type is Short Data Grant.
Guard Time Size	9	1	Number of symbol times which must follow the end of this burst. (Although this value may be derivable from other network and architectural parameters, it is included here to ensure that the CMs and CMTS all use the same value.)
Last Codeword Length	10	1	1 = fixed; 2 = shortened.
Scrambler on/off	11	1	1 = on; 2 = off.

Type 1	Length 1	Symbol Rate	
Type 2	Length 4	Frequency	
Type 3	Length 1-128	Preamble Superstring	
Type 4	Length N	First Burst Descriptor	
Type 4	Length N	Second Burst Descriptor	
Type 4	Length N	Third Burst Descriptor	
Type 4	Length N	Fourth Burst Descriptor	

T0905860-97/d075

Figure B.6-17/J.112 – Example of UCD encoded TLV data

B.6.3.2.3 Upstream Bandwidth Allocation Map (MAP)

A CMTS MUST generate MAPs in the format shown in Figure B.6-18.

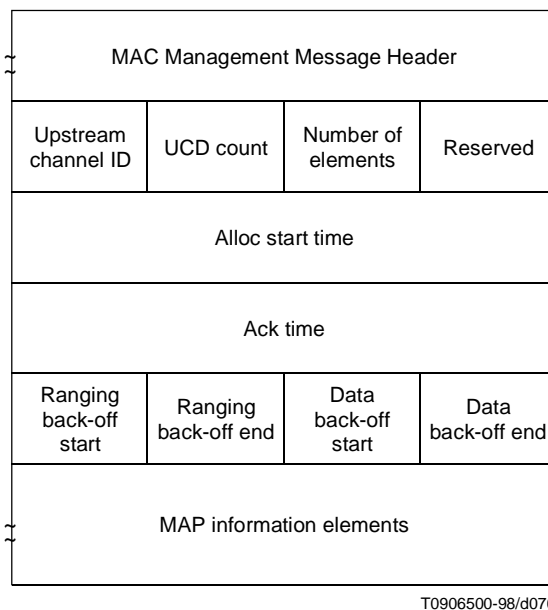

Figure B.6-18/J.112 – MAP format

The parameters MUST be as follows:

- Upstream Channel ID** The identifier of the upstream channel to which this message refers.
- UCD Count** Matches the value of the Configuration Change Count of the UCD which describes the burst parameters which apply to this map. See B.7.2.15.
- Number Elements** Number of information elements in the map.
- Reserved** Reserved field for alignment.

Alloc Start Time	Effective start time from CMTS initialization (in mini-slots) for assignments within this map.
Ack Time	Latest time, from CMTS initialization, (mini-slots) processed in upstream. This time is used by the CMs for collision detection purposes. See B.6.4.4.
Ranging Backoff Start	Initial back-off window for initial ranging contention, expressed as a power of two. Values range 0-15 (the highest order bits must be unused and set to 0).
Ranging Backoff End	Final back-off window for initial ranging contention, expressed as a power of two. Values range 0-15 (the highest order bits must be unused and set to 0).
Data Backoff Start	Initial back-off window for contention data and requests, expressed as a power of two. Values range 0-15 (the highest order bits must be unused and set to 0).
Data Backoff End	Final back-off window for contention data and requests, expressed as a power of two. Values range 0-15 (the highest order bits must be unused and set to 0).
MAP information elements	MUST be in the format defined in Figure B.6-19 and Table B.6-16. Values for IUCs are defined in Table B.6-16 and are described in detail in B.6.4.1.

First interval	SID	IUC	Offset = 0
Second interval	SID	IUC	Offset
	⋮		
Last interval	SID	IUC	Offset
End-of-list (Null IE)	SID = 0	IUC = 7	Offset = map length
	SID	IUC	Offset = map length
Acknowledgements and Deferrals	⋮		
	SID	IUC	Offset = map length

T0905030-97/d077

Figure B.6-19/J.112 – MAP information element structure

Table B.6-16/J.112 – Allocation MAP Information Elements (IE)

IE name	Interval Usage Code (IUC) (4 bits)	SID (14 bits)	Mini-slot offset (14 bits)
Request	1	Any	Starting offset of REQ region
REQ/Data (refer to Appendix B.I for multicast definition)	2	Multicast	Starting offset of IMMEDIATE Data region Well-known multicasts define start intervals
Initial Maintenance	3	Broadcast/ multicast	Starting offset of MAINT region (used in Initial Ranging)
Station Maintenance (Note 1)	4	Unicast	Starting offset of MAINT region (used in Periodic Ranging)
Short Data Grant (Note 2)	5	Unicast	Starting offset of Data Grant assignment; If inferred length = 0, then it is a Data Grant pending.
Long Data Grant	6	Unicast	Starting offset of Data Grant assignment; If inferred length = 0, then it is a Data Grant pending.
Null IE	7	Zero	Ending offset of the previous grant. Used to bound the length of the last actual interval allocation.
Data Ack	8	Unicast	CMTS sets to 0.
Reserved	9-14	Any	Reserved
Expansion	15	Expanded IUC	# of additional 32-bit words in this IE

NOTE 1 – Although the distinction between Initial Maintenance and Station Maintenance is unambiguous from the Service ID type, separate codes are used to ease physical-layer configuration (see burst descriptor encodings, Table B.6-15).

NOTE 2 – The distinction between long and short data grants is related to the amount of data that can be transmitted in the grant. A short data grant interval may use FEC parameters that are appropriate to short packets while a long data grant may be able to take advantage of greater FEC coding efficiency.

NOTE 3 – Each IE is a 32-bit quantity, of which the most significant 14 bits represent the SID, the middle 4 bits the IUC, and the low-order 14 bits the mini-slot offset.

NOTE 4 – The SID used in the Station Maintenance IE MUST be a Temporary SID, or the first Registration SID (and maybe the only one) that was assigned in the REG-RSP message to a CM.

B.6.3.2.4 Ranging Request (RNG-REQ)

A Ranging Request MUST be transmitted by a CM at initialization and periodically on request from CMTS to determine network delay. This message MUST use an FC field of type: Timing. This MUST be followed by a Packet PDU in the format shown in Figure B.6-20.

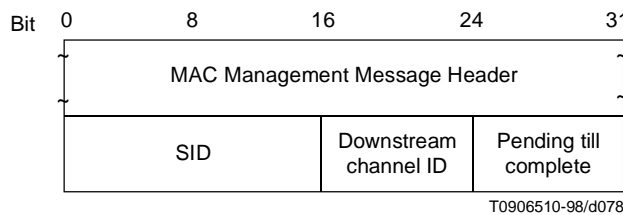

Figure B.6-20/J.112 – Packet PDU following the Timing Header

Parameters MUST be as follows:

SID

For RNG-REQ messages transmitted in Initial Maintenance intervals:

- initialization SID if modem is attempting to join the network;
- initialization SID if modem has not yet registered and is changing downstream (or both downstream and upstream) channels as directed by a downloaded parameter file;
- temporary SID if modem has not yet registered and is changing upstream (not downstream) channels as directed by a downloaded parameter file;
- registration SID (previously assigned in REG-RSP) if modem is registered and is changing upstream channels.

For RNG-REQ messages transmitted in Station Maintenance intervals:

- assigned SID.

This is a 16-bit field of which the lower 14 bits define the SID with bits 14, 15 defined to be 0.

Downstream channel ID

The identifier of the downstream channel on which the CM received the UCD which described this upstream. This is an 8-bit field.

Pending Till Complete

If zero, then all previous Ranging Response attributes have been applied prior to transmitting this request. If non-zero, then this is time estimated to be needed to complete assimilation of ranging parameters. Note that only equalization can be deferred. Units are in unsigned centiseconds (10 ms).

B.6.3.2.5 Ranging Response (RNG-RSP)

A Ranging Response MUST be transmitted by a CMTS in response to received RNG-REQ in the format shown in Figure B.6-21. The state machines describing the ranging procedure appear in B.7.2.5. In that procedure it may be noted that, from the point of view of the CM, reception of a Ranging Response is stateless. In particular, the CM MUST be prepared to receive a Ranging Response at any time, not just following a Ranging Request.

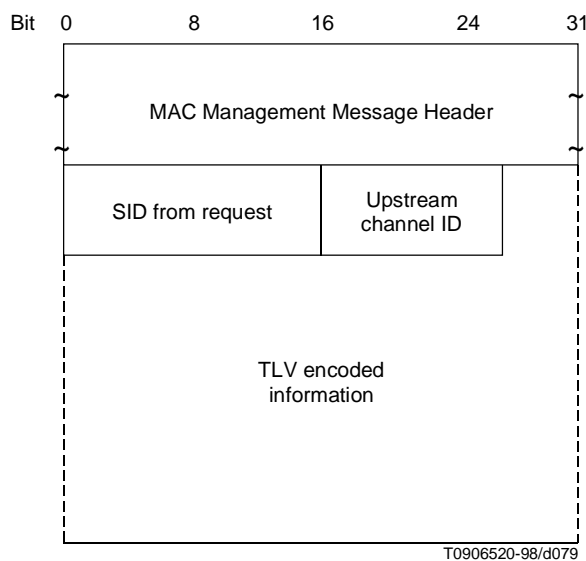

Figure B.6-21/J.112 – Ranging Response

To provide for flexibility, the message parameters following the Upstream Channel ID MUST be encoded in a type/length/value (TLV) form. Using this encoding, new parameters can be added which not all CMs can interpret. A CM which does not recognize a parameter type MUST simply skip over this parameter and MUST NOT treat the event as an error condition.

Parameters MUST be as follows:

SID	If the modem is being instructed by this response to move to a different channel, this is initialization SID. Otherwise, this is the SID from the corresponding RNG-REQ to which this response refers, except that if the corresponding RNG-REQ was an initial ranging request specifying a initialization SID, then this is the assigned temporary SID.
Upstream channel ID	The identifier of the upstream channel on which the CMTS received the RNG-REQ to which this response refers.
Timing adjust information	The time by which to offset frame transmission so that frames arrive at the expected mini-slot time at the CMTS.
Power adjust information	Specifies the relative change in transmission power level that the CM is to make in order that transmissions arrive at the CMTS at the desired power.
Frequency adjust information	Specifies the relative change in transmission frequency that the CM is to make in order to better match the CMTS. (This is fine-frequency adjustment within a channel, not re-assignment to a different channel.)
CM transmitter equalization information	If the CM implements transmission equalization, this provides the equalization coefficients (optional).
Ranging status	Used to indicate whether upstream messages are received within acceptable limits by CMTS.
Downstream Frequency Override	An optional parameter. The downstream frequency with which the modem should redo initial ranging.
Upstream Channel ID Override	An optional parameter. The identifier of the upstream channel with which the modem should redo initial ranging.

B.6.3.2.5.1 Encodings

The type values used MUST be those defined in Table B.6-17 and Figure B.6-22. These are unique within the ranging response message but not across the entire MAC message set. The type and length fields MUST each be 1 octet in length.

Table B.6-17/J.112 – Ranging Response message encodings

Name	Type (1 byte)	Length (1 byte)	Value (Variable Length)
Timing Adjust	1	4	TX timing offset adjustment [signed 32 bit, units of (6.25 μs/64)]
Power Level Adjust	2	1	TX Power offset adjustment (signed 8 bit, 1/4-dB units)
Offset Frequency Adjust	3	2	TX frequency offset adjustment (signed 16 bit, Hz units)
Transmit Equalization Adjust	4	n	TX equalization data – See details below
Ranging Status	5	1	1 = continue, 2 = abort, 3 = success
Downstream frequency override	6	4	Centre frequency of new downstream channel in Hz
Upstream channel ID override	7	1	Identifier of the new upstream channel
Reserved	8-255	n	Reserved for future use

Type 4	Length	Number of taps per symbol
Number of forward taps (N)	Number of reverse taps (M)	
First coefficient F_0 (real)	First coefficient F_0 (imaginary)	
⋮		
Last coefficient F_N (real)	Last coefficient F_N (imaginary)	
First reverse coefficient D_0 (real)	First reverse coefficient D_0 (imaginary)	
⋮		
Last reverse coefficient D_M (real)	Last reverse coefficient D_M (imaginary)	

T0905060-97/d080

Figure B.6-22/J.112 – Generalized decision feedback equalization coefficients

The total number of taps per symbol **MUST** be in the range 1 to 4.

The total number of taps **MAY** range up to 64. Each tap consists of a real and imaginary coefficient entry in the table.

If more than 255 bytes are needed to represent equalization information, then several type-4 elements **MAY** be used. Data **MUST** be treated as if byte-concatenated, that is, the first byte after the length field of the second type-4 element is treated as if it immediately followed the last byte of the first type-4 element.

The coefficients that are sent to the CM may be coefficients of a CMTS demodulator equalizer such as shown in Figure B.6-23, which, after acquisition, will have tap values that represent the channel distortion. Other equalization methods may be devised in the future. If so, they will use a different type-value so that the element is not overloaded. This is a vendor-specific issue which is not described here.

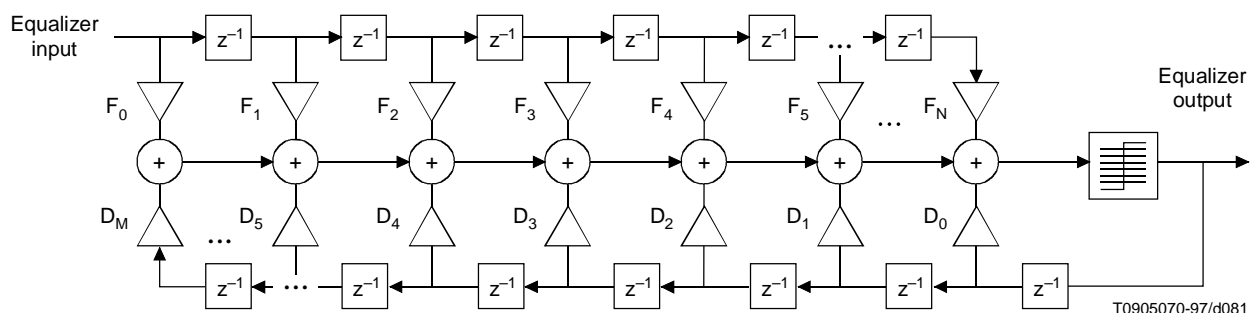

T0905070-97/d081

Figure B.6-23/J.112 – CMTS demodulator equalizer tap location definition

B.6.3.2.5.2 Example of TLV data

An example of TLV data is given in Figure B.6-24.

Type 1	Length 4	Timing adjust	
Type 2	Length 1	Power adjust	
Type 3	Length 2	Frequency adjust information	
Type 4	Length x	x bytes of CM transmitter equalization information	
Type 5	Length 1	Ranging status	

T0905080-97/d082

Figure B.6-24/J.112 – Example of TLV data

B.6.3.2.5.3 Overriding channels

The RNG-RSP message allows the CMTS to instruct the modem to move to a new downstream and/or upstream channel and to repeat initial ranging. However, the CMTS may do this only in response to an initial ranging request from a modem that is attempting to join the network, or in response to any of the unicast ranging requests that take place immediately after this initial ranging and up to the point where the modem successfully completes periodic ranging. From this point on, only Appendix B.III.8.4 and UCC-REQ mechanisms are available for moving the modem to a new upstream channel, and only Appendix B.III.8.3 mechanism is available for moving the modem to a new downstream channel.

If a downstream frequency override is specified in the RNG-RSP, the modem MUST reinitialize its MAC and perform initial ranging using the specified downstream center frequency as the first scanned channel. For the upstream channel, the modem may select any valid channel based on received UCD messages.

If an upstream channel ID override is specified in the RNG-RSP, the modem MUST reinitialize its MAC and perform initial ranging using for its first attempt the upstream channel specified in the RNG-RSP and the same downstream frequency on which the RNG-RSP was received.

If both downstream frequency and upstream channel ID overrides are present in the RNG-RSP, the modem MUST reinitialize its MAC and perform initial ranging using for its first attempt the specified downstream frequency and upstream channel ID.

Note that when a modem with an assigned temporary SID is instructed to move to a new downstream and/or upstream channel and to redo initial ranging, the modem MUST consider the temporary SID to be deassigned. The modem MUST redo initial ranging using the zero SID.

Configuration file settings (see Appendix B.III.3) for upstream channel ID and downstream frequency are optional but, if specified in the configuration file, they take precedence over the ranging response parameters.

B.6.3.2.6 Registration Request (REG-REQ)

A Registration Request, in the format shown in Figure B.6-25, MUST be transmitted by a CM at initialization after receipt of a CM parameter file.

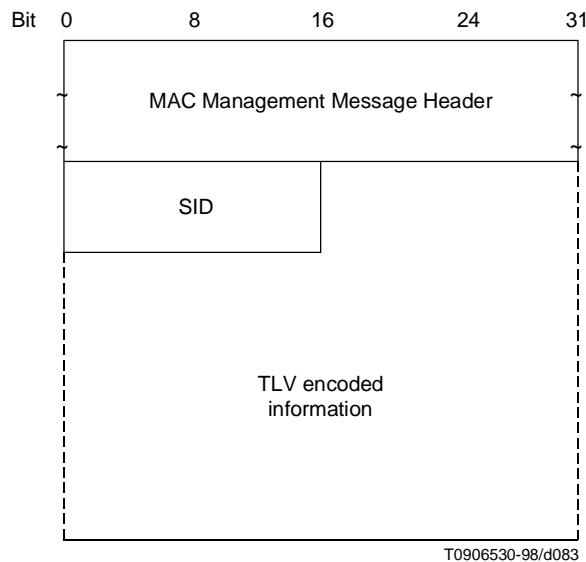

T0906530-98/d083

Figure B.6-25/J.112 – Registration Request

To provide for flexibility, the message parameters following the SID **MUST** be encoded in a type/length/value form. Using this encoding, new parameters **MAY** be added which not all CMTSs can interpret. A CMTS which does not recognize a parameter type **MUST** simply skip over this parameter and **MUST** not treat the event as an error condition.

Parameters **MUST** be as follows:

SID	Initialization SID for this CM.
Configuration settings for this modem	As defined in Appendix B.III: <ul style="list-style-type: none"> • downstream frequency configuration setting; • upstream channel ID configuration setting; • network access configuration setting; • class of service configuration setting; • modem capabilities configuration setting; • modem IP address; • baseline privacy configuration setting.

NOTE – The CM **MUST** be capable of supporting these standard configuration settings.

Vendor-specific data	As defined in Appendix B.III: <ul style="list-style-type: none"> • vendor ID configuration setting (vendor ID of CM); • vendor-specific extensions.
-----------------------------	---

Message Integrity Checks	As defined in Appendix B.III: <ul style="list-style-type: none"> • CM MIC configuration setting; • CMTS MIC configuration setting.
---------------------------------	--

B.6.3.2.6.1 Encodings

The type values used are unique within the registration request message but not across the entire MAC message set. They **MUST** be those defined in Appendix B.III.

NOTE – The CM **MUST** forward the vendor-specific configuration settings to the CMTS in the same order in which they were received in the configuration file to allow the message integrity check to be performed.

B.6.3.2.6.2 Example

An example of type value encodings is given in Figure B.6-26.

Type 1	Length 4	Downstream frequency	
Type 2	Length 1	Upstream channel	
Type 3	Length 1	Network access	
Type 4	Length 28	Service class definition class 1	
Type 4	Length 28	Service class definition class 2	
Type 4	Length 28	Service class definition class n	
Type 5	Length 3	Modem capabilities	
Type 12	Length 4	Modem IP address	
Type 8	Length 3	Vendor ID	
Type 43	Length n	n bytes of vendor-specific data	
Type 6	Length 16	CM message integrity check	
Type 7	Length 16	CMTS message integrity check	

T0906540-98/d084

Figure B.6-26/J.112 – Example of Registration Request type value encodings

B.6.3.2.7 Registration Response (REG-RSP)

A Registration Response, in the format shown in Figure B.6-27, **MUST** be transmitted by CMTS in response to received REG-REQ.

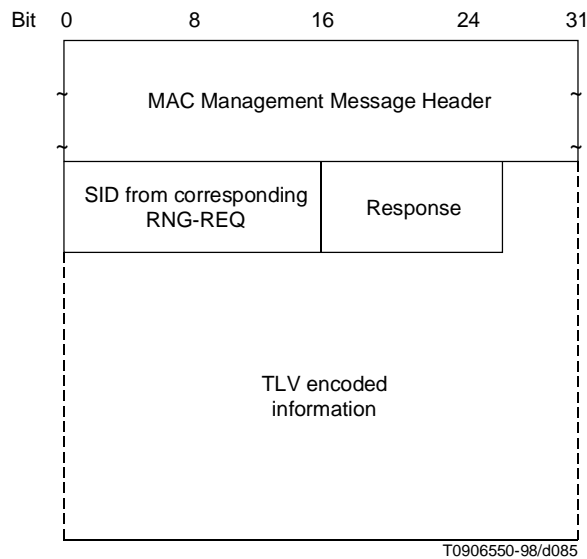

T0906550-98/d085

Figure B.6-27/J.112 – Registration Response format

To provide for flexibility, the message parameters following the SID MUST be encoded in a type/length/value form. Using this encoding, new parameters MAY be added which not all CMs can interpret. A CM which does not recognize a parameter type MUST skip over this parameter and MUST NOT treat the event as an error condition.

Parameters MUST be as follows:

SID from Corresponding REG-REQ	SID from corresponding REG-REQ to which this response refers
Response	0 = ok 1 = authentication failure 2 = class of service failure
Modem Capabilities	The CMTS response to the capabilities of the modem
Service Class Data	Returned when Response = ok Service ID / service class tuple for each class of service granted
Service Not Available	Returned when Response = class of service failure. If a service class cannot be supported, this configuration setting is returned in place of the service class data. If this is received, the entire registration request is considered to have failed and must be repeated.
Vendor-Specific Data	As defined in Appendix B.III: <ul style="list-style-type: none">• Vendor ID Configuration Setting (vendor ID of CMTS)• Vendor-specific extensions

NOTE 1 – Service class IDs MUST be those requested in the corresponding REG-REQ.

NOTE 2 – The initialization SID MUST no longer be used once the REG-RSP is received.

B.6.3.2.7.1 Encodings

The type values used MUST be those shown below. These are unique within the registration response message but not across the entire MAC message set. The type and length fields MUST each be 1 octet.

B.6.3.2.7.1.1 Modem capabilities

This field defines the CMTS response to the modem capability field in the Registration Request. The CMTS responds to the modem capabilities to indicate whether they may be used. If the CMTS does not recognize a modem capability, it must return this as "off" in the Registration Response.

Only capabilities set to "on" in the REG-REQ may be set "on" in the REG-RSP as this is the handshake indicating that they have been successfully negotiated.

Encodings are as defined for the Registration Request.

B.6.3.2.7.1.2 Service class data

This encoding defines the parameters associated with a requested class of service. It is somewhat complex in that it is composed from a number of encapsulated type/length/value fields. The encapsulated fields define the particular class of service parameters for the class of service in question. Note that the type fields defined are only valid within the encapsulated service class data configuration setting string. A single service class data configuration setting MUST be used to define the parameters for a single service class. Multiple class definitions MUST use multiple service class data configuration setting sets.

Type	Length	Value
1	n	Encoded service class data

Internal service class data encodings

Class ID

The value of the field MUST specify the identifier for the class of service to which the encapsulated string applies. This MUST be a class which was requested in the associated REG-REQ.

Type	Length	Value
1	1	from REG-REQ

Valid Range

The class ID MUST be in the range 1 to 16.

Service ID

The value of the field MUST specify the SID associated with this service class.

Type	Length	Value
2	2	SID

B.6.3.2.7.2 Registration Response encoding example

An example of Registration Response encoding is given in Figure B.6-28.

Type 1	Length 7	Service class definition class 1
Type 1	Length 7	Service class definition class 2
Type 1	Length 7	Service class definition class n
Type 6	Length 6	Modem capability

T0905880-97/d086

Figure B.6-28/J.112 – Example of Registration Response encoding

B.6.3.2.7.3 Sample service class data encoding

Sample service class data encodings are provided in Table B.6-18.

Table B.6-18/J.112 – Sample service class data encoding

Type	Length	VALUE (sub)type	Length	Value	Description
1	7	1 2	1 2	1 123	Service class data configuration setting Service class 1 SID for this class
1	7	1 2	1 2	2 244	Service class data configuration setting Service class 2 SID for this class
1	7	1 2	1 2	n 345	Service class data configuration setting Service class n SID for this class

B.6.3.2.8 Upstream Channel Change Request (UCC-REQ)

An Upstream Channel Change Request MAY be transmitted by a CMTS to cause a CM to change the upstream channel on which it is transmitting. The format of an UCC-REQ message is shown in Figure B.6-29.

Parameters MUST be as follows:

Upstream channel ID The identifier of the upstream channel to which the CM is to switch for upstream transmissions. This is an 8-bit field.

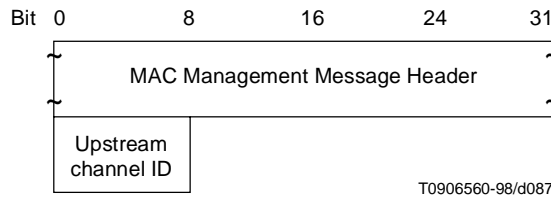

Figure B.6-29/J.112 – Upstream Channel Change Request

B.6.3.2.9 Upstream Channel Change Response (UCC-RSP)

An Upstream Channel Change Response MUST be transmitted by a CM in response to a received Upstream Channel Change Request message to indicate that it has received and is complying with the UCC-REQ. The format of a UCC-RSP message is shown in Figure B.6-30.

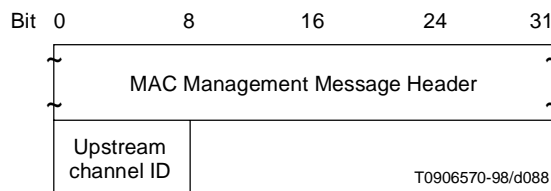

Figure B.6-30/J.112 – Upstream Channel Change Response

Before it begins to switch to a new upstream channel, a CM MUST transmit a UCC-RSP on its existing upstream channel. A CM MAY ignore an UCC-REQ message while it is in the process of performing a channel change. When a CM receives a UCC-REQ message requesting that it switch to an upstream channel that it is already using, the CM MUST respond with a UCC-RSP message on that channel indicating that it is already using the correct channel.

To switch to a new upstream channel, a CM will begin a new ranging procedure for that channel, and upon completion of ranging will proceed without re-performing registration. The full procedure for changing channels is described in B.7.2.16.

Parameters MUST be as follows:

Upstream channel ID The identifier of the upstream channel to which the CM is to switch for upstream transmissions. This is the same Channel ID specified in the UCC-REQ message. This is an 8-bit field.

B.6.4 Upstream bandwidth allocation

The upstream channel is modelled as a stream of mini-slots. The CMTS MUST generate the time reference for identifying these slots. It MUST also control access to these slots by the cable modems. For example, it MAY grant some number of contiguous slots to a CM for it to transmit a data PDU. The CM MUST time its transmission so that the CMTS receives it in the time reference specified. This subclause describes the elements of protocol used in requesting, granting, and using upstream bandwidth. The basic mechanism for assigning bandwidth management is the allocation map. Please refer to Figure B.6-31.

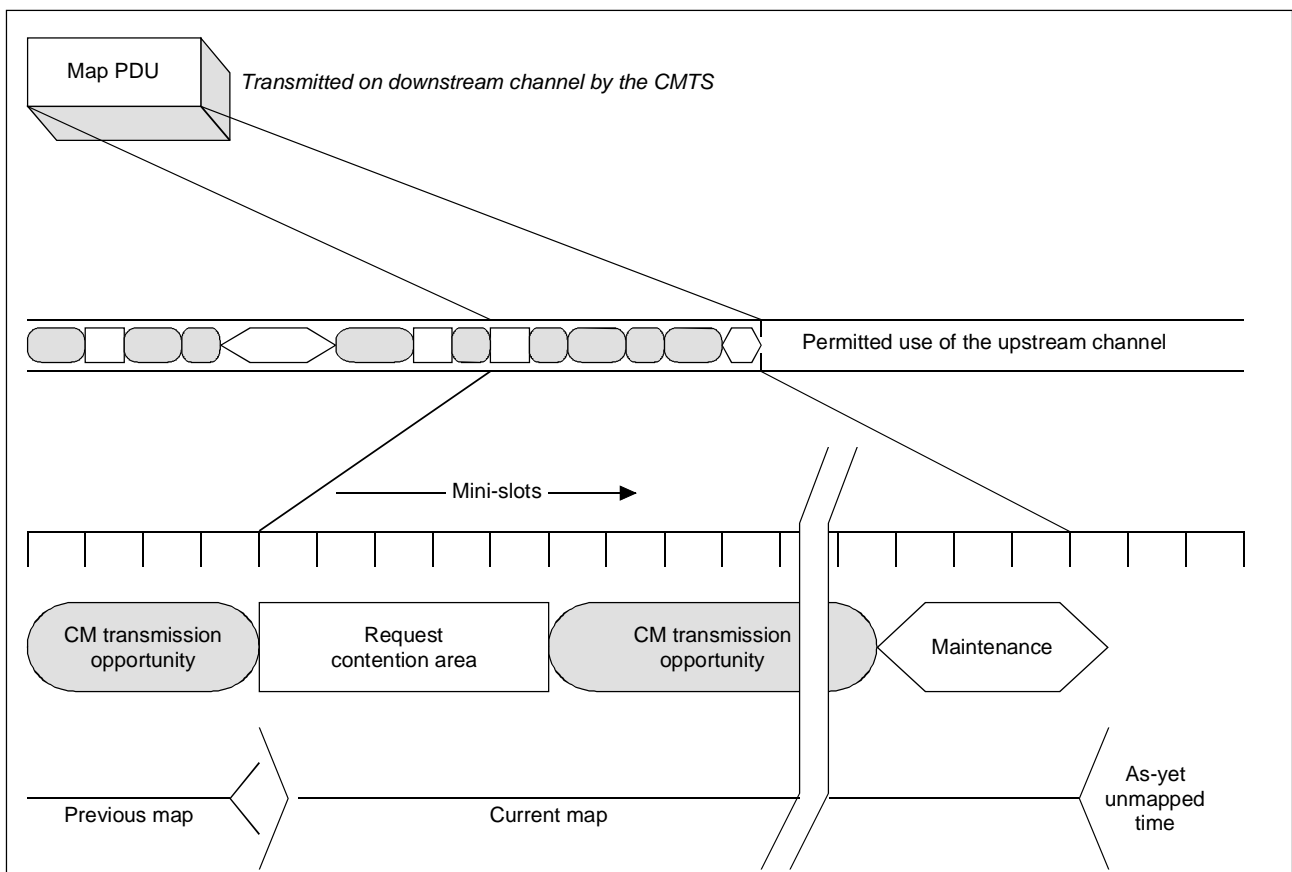

T0905110-97/d089

Figure B.6-31/J.112 – Allocation map

The allocation map is a MAC Management message transmitted by the CMTS on the downstream channel which describes, for some interval, the uses to which the upstream mini-slots MUST be put. A given map MAY describe some slots as grants for particular stations to transmit data in, other slots as available for contention transmission, and other slots as an opportunity for new stations to join the link.

Many different scheduling algorithms MAY be implemented in the CMTS by different vendors; this specification does not mandate a particular algorithm. Instead, it describes the protocol elements by which bandwidth is requested and granted.

The bandwidth allocation MUST include the following basic elements:

- Each CM has one or more short (14-bit) service identifiers as well as a 48-bit address.
- Upstream bandwidth is divided into a stream of mini-slots. Each mini-slot is numbered relative to a master reference maintained by the CMTS. The clocking information is distributed to the CMs by means of SYNC packets.
- CMs MAY issue requests to the CMTS for upstream bandwidth.

The CMTS MUST transmit allocation map PDUs on the downstream channel defining the allowed usage of each mini-slot. The map is described below.

B.6.4.1 The Allocation Map MAC Management message

The allocation map is a varying-length MAC Management message that is transmitted by the CMTS to define transmission opportunities on the upstream channel. It includes a fixed-length header followed by a variable number of Information Elements (IEs) in the format shown in B.6.3.2.3. Each information element defines the allowed usage for a range of mini-slots.

Note that it should be understood by both CM and CMTS that the lower (26-M) bits of alloc start and ack times MUST be used as the effective MAP start and ack times, where M is defined in B.6.3.2.2. The relationship between alloc start/ack time counters and the timestamp counter is further described in B.6.5.4.

B.6.4.1.1 Information elements

Each IE consists of a 14-bit Service ID, a 4-bit type code, and a 14-bit starting offset as defined in B.6.3.2.3. Since all stations MUST scan all IEs, it is critical that IEs be short and relatively fixed format. IEs within the map are strictly ordered by starting offset. For most purposes, the duration described by the IE is inferred by the difference between the IE's starting offset and that of the following IE. For this reason, a null IE MUST terminate the list. Refer to Table B.6-16.

Four types of Service IDs are defined:

- 1) 0x3FFF – Broadcast, intended for all stations.
- 2) 0x2000-0x3FFE – Multicast, purpose is defined administratively. See Appendix B.I.
- 3) 0x0001-0x1FFF – Unicast, intended for a particular CM or a particular service within that CM.
- 4) 0x0000 – Null address, addressed to no station.

The types of information elements which MUST be supported are defined below.

B.6.4.1.1.1 The Request IE

The Request IE provides an upstream interval in which requests MAY be made for bandwidth for upstream data transmission. The character of this IE changes depending on the class of Service ID. If broadcast, this is an invitation for CMs to contend for requests. Subclause B.6.4.4 describes which contention transmit opportunity may be used. If unicast, this is an invitation for a particular CM to request bandwidth. Unicasts MAY be used as part of a class-of-service implementation (see below). Packets transmitted in this interval MUST use the Request MAC Header format (see B.6.2.5.3).

B.6.4.1.1.2 The Request/Data IE

The Request/Data IE provides an upstream interval in which requests for bandwidth or short data packets MAY be transmitted. This IE is distinguished from the Request IE in that:

- It provides a means by which allocation algorithms MAY provide for "immediate" data contention under light loads, and a means by which this opportunity can be withdrawn as network loading increases.

- Multicast Service IDs **MUST** be used to specify maximum data length, as well as allowed random starting points within the interval. For example, a particular multicast ID **MAY** specify a maximum of 64-byte data packets, with random starting points of every fourth slot.

A small number of well-known multicast Service IDs are defined in Appendix B.I. Others are available for vendor-specific algorithms.

Since data packets transmitted within this interval may collide, the CMTS **MUST** acknowledge any that are successfully received. The data packet **MUST** indicate in the MAC Header that a data acknowledgment is desired (see Table B.6-12).

B.6.4.1.1.3 The Initial Maintenance IE

The Initial Maintenance IE provides an interval in which new stations may join the network. A long interval, equivalent to the maximum round-trip propagation delay plus the transmission time of the Ranging Request (RNG-REQ) message (see B.6.3.2.4), **MUST** be provided to allow new stations to perform initial ranging.

Packets transmitted in this interval **MUST** use the RNG-REQ MAC Management message format (see B.6.3.2.4).

B.6.4.1.1.4 The Station Maintenance IE

The Station Maintenance IE provides an interval in which stations are expected to perform some aspect of routine network maintenance, such as ranging or power adjustment. The CMTS **MAY** request that a particular CM perform some task related to network maintenance, such as periodic transmit power adjustment. In this case, the Station Maintenance IE is unicast to provide upstream bandwidth in which to perform this task. Packets transmitted in this interval **MUST** use the RNG-REQ MAC Management message format (see B.6.3.2.4).

B.6.4.1.1.5 Short and Long Data Grant IEs

The Data Grant IE provides an opportunity for a CM to transmit one or more upstream PDUs. These IEs **MAY** also be used with an inferred length of zero mini-slots (a zero length grant), to indicate that a request has been received and is pending (a Data Grant Pending). This IE is issued either in response to a request from a station, or because of an administrative policy providing some amount of bandwidth to a particular station (see class-of-service discussion below).

Short Data Grants are used with intervals less than or equal to the maximum burst size for this usage specified in the Upstream Channel Descriptor. If Short Data bursts are defined in the UCD, then all Long Data Grants **MUST** be for a larger number of mini-slots than the maximum for Short Data. The distinction between Long and Short Data Grants may be exploited in physical-layer forward-error-correction coding; otherwise, it is not meaningful to the bandwidth allocation process.

If this IE is a Data Grant Pending (a zero length grant), it **MUST** follow all actual Data Grants (non-zero length grants). This allows cable modems to process all allocations first, before scanning the Map for request acknowledgements and data acknowledgements.

B.6.4.1.1.6 Data Acknowledge IE

The Data Acknowledge IE acknowledges that a data PDU was received. The CM **MUST** have requested this acknowledgment within the data PDU (normally this would be done for PDUs transmitted within a contention interval in order to detect collisions).

This IE **MUST** follow all non-null-interval IEs. This allows cable modems to process all actual interval allocations first, before scanning the Map for request acknowledgements and data acknowledgements.

B.6.4.1.1.7 Expansion IE

The Expansion IE provides for extensibility, if more than 16-code points or 32 bits are needed for future IEs.

B.6.4.1.1.8 Null IE

A Null IE terminates all actual allocations in the IE list. It is used to infer a length for the last interval. All data acknowledgements and all null data grants follow the Null IE.

B.6.4.1.2 Requests

Only one type of upstream request is inherent to the allocation protocol: a request for upstream bandwidth. This request MAY be transmitted any time that either a request or a data PDU is allowed from the particular station. It MAY be transmitted during an interval described by any of:

- a Request IE;
- a Request/Data IE;
- a Data Grant IE.

In addition, it MAY be piggybacked⁵ on a data transmission. The request includes:

- the Service ID making the request;
- the number of mini-slots or ATM cells requested.

The number of mini-slots requested MUST be the total number that is desired by the CM at the time of the request (including any physical layer overhead)⁶, subject to administrative limits⁷. The CM MUST request a number of mini-slots corresponding to one or more complete packets. A non-concatenating CM MUST request only the necessary mini-slots for one MAC frame per request. If, for whatever reason, a previous request has not been satisfied when the CM is making a new request, it MUST include the number of slots from the old request in the new total. Note that only one request at a time (per Service ID) will be outstanding. Because the CMTS MUST continue to issue null grants for as long as a request is unsatisfied, the CM is able to unambiguously determine when its request is still pending.

Administrative limits MAY be assigned, either globally or per Service ID, on the number of mini-slots that MAY be requested at once. The global limit is configured as the maximum transmission burst size.

B.6.4.2 Map Transmission and Timing

The allocation map MUST be transmitted in time to propagate across the physical cable and be received and handled by the receiving CMs. As such, it MAY be transmitted considerably earlier than its effective time. The components of the delay are:

- Worst-case round-trip propagation delay – May be network-specific, but in the order of hundreds of microseconds.
- Queuing delays within the CMTS – Implementation-specific.
- Processing delays within the CMs – MUST allow a minimum processing time by each CM as specified in Appendix B.II (CM MAP Processing Time).
- PMD-layer FEC interleaving.

Within these constraints, vendors MAY wish to minimize this delay so as to minimize latency of access to the upstream channel.

The number of mini-slots described MAY vary from map to map. At a minimum, a map MAY describe a single mini-slot. This would be wasteful in both downstream bandwidth and in processing time within the CMs. At a maximum, a map MAY stretch to tens of milliseconds. Such a map would provide poor upstream latency. Allocation algorithms MAY vary the size of the maps over time to provide a balance of network utilization and latency under varying traffic loads.

⁵ When piggybacked, these values are carried in the Extended Header (Subclause 6.2.6, EH_TYPE = 1).

⁶ Physical layer overhead that MUST be accounted for in a request includes: guard band, preamble, and FEC which are dependent on the burst profile.

⁷ The CM is limited by the Maximum Transmit Burst for the service class, as defined in Appendix B.III.

At a minimum, a map MUST contain two Information Elements: one to describe an interval and a null IE to terminate the list. At a maximum, a map MUST be bounded by a limit of 240 information elements. Maps are also bounded in that they MUST NOT describe more than 4096 mini-slots into the future. The latter limit is intended to bound the number of future mini-slots that each CM is required to track. Even though several maps may be outstanding, the sum of the number of mini-slots they describe MUST NOT exceed 4096.

The set of all maps, taken together, MUST describe every mini-slot in the upstream channel. If a CM fails to receive a map describing a particular interval, it MUST NOT transmit during that interval.

Multiple maps MAY be outstanding at once.

B.6.4.3 Protocol example

This subclause illustrates the interchange between the CM and the CMTS when the CM has data to transmit (see Figure B.6-32). Suppose a given CM has a data PDU available for transmission.

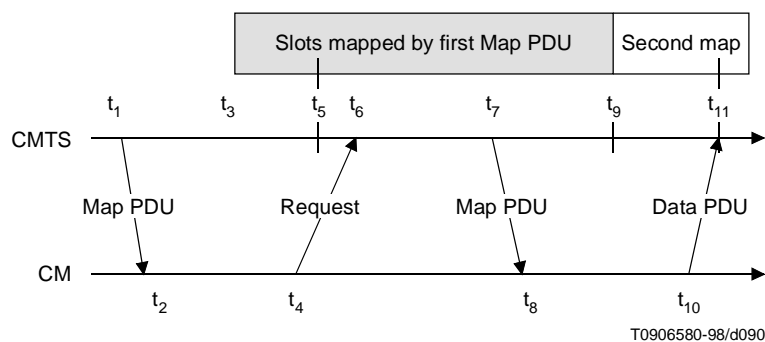

Figure B.6-32/J.112 – Protocol example

Description

- 1) At time t_1 , the CMTS transmits a map whose effective starting time is t_3 . Within this map is a Request IE which will start at t_5 . The difference between t_1 and t_3 is needed to allow for:
 - downstream propagation delay (including FEC interleaving) to allow all CMs to receive the Map;
 - processing time at the CM (allows the CMs to parse the Map and translate it into transmission opportunities);
 - upstream propagation delay (to allow the CM's transmission of the first upstream data to begin in time to arrive at the CMTS at time t_3).
- 2) At t_2 , the CM receives this map and scans it for request opportunities. In order to minimize request collisions, it calculates t_6 as a random offset based on the Data Back-off Start value in the most recent Map (see B.6.4.4, also the multicast SID definitions in B.I.2).
- 3) At t_4 , the CM transmits a request for as many mini-slots as needed to accommodate the PDU. Time t_4 is chosen based on the ranging offset (see B.6.3.2.5) so that the request will arrive at the CMTS at t_6 .
- 4) At t_6 , the CMTS receives the request and schedules it for service in the next map. (The choice of which requests to grant will vary with the class of service requested, any competing requests, and the algorithm used by the CMTS.)
- 5) At t_7 , the CMTS transmits a map whose effective starting time is t_9 . Within this map, a data grant for the CM will start at t_{11} .
- 6) At t_8 , the CM receives the map and scans for its data grant.
- 7) At t_{10} , the CM transmits its data PDU so that it will arrive at the CMTS at t_{11} . Time t_{10} is calculated from the ranging offset as in step 3).

Steps 1) and 2) need not contribute to access latency if CMs routinely maintain a list of request opportunities.

At step 3), the request may collide with requests from other CMs and be lost. The CMTS does not directly detect the collision. The CM determines that a collision (or other reception failure) occurred when the next map fails to include acknowledgment of the request. The CM MUST then perform a back-off algorithm and retry.

At step 4), the CMTS scheduler MAY fail to accommodate the request within the next map. If so, it MUST reply with a zero-length grant in that map or discard the request by giving no grant at all. It MUST continue to report this zero-length grant in all succeeding maps until the request can be granted or is discarded. This MUST signal to the CM that the request is still pending. So long as the CM is receiving a zero-length grant, it MUST NOT issue new requests for that service queue.

B.6.4.4 Contention Resolution

The CMTS controls assignments on the upstream channel through the MAP and determines which mini-slots are subject to collisions. The CMTS MAY allow collisions on either Requests or Data PDUs.

The mandatory method of contention resolution which MUST be supported is based on a truncated binary exponential back-off, with the initial back-off window and the maximum back-off window controlled by the CMTS. The values are specified as part of the Bandwidth Allocation Map (MAP) MAC message and represent a power-of-two value. For example, a value of 4 indicates a window between 0 and 15; a value of 10 indicates a window between 0 and 1023.

When a CM has information to send and wants to enter the contention resolution process, it sets its internal back-off window equal to the Data Back-off Start defined in the MAP currently in effect.

The CM MUST randomly select a number within its back-off window. This random value indicates the number of contention transmit opportunities which the CM MUST defer before transmitting. A CM MUST only consider contention transmit opportunities for which this transmission would have been eligible. These are defined by either Request IEs or Request/Data IEs in the MAP.

NOTE 1 – Each IE can represent multiple transmission opportunities.

As an example, consider a CM whose initial back-off window is 0 to 15 and it randomly selects the number 11. The CM must defer a total of 11 contention transmission opportunities. If the first available Request IE is for 6 requests, the CM does not use this and has 5 more opportunities to defer. If the next Request IE is for 2 requests, the CM has 3 more to defer. If the third Request IE is for 8 requests, the CM transmits on the fourth request, after deferring for 3 more opportunities.

After a contention transmission, the CM waits for a Data Grant (Data Grant Pending) or Acknowledgment in a subsequent MAP. Once either is received, the contention resolution is complete. The CM determines that the contention transmission was lost when it finds a MAP without a Data Grant (Data Grant Pending) or Acknowledgment for it and with an Ack time more recent than the time of transmission. The CM MUST now increase its back-off window by a factor of two, as long as it is less than the maximum back-off window. The CM MUST randomly select a number within its new back-off window and repeat the deferring process described above.

This retry process continues until the maximum number of retries (16) has been reached, at which time the PDU MUST be discarded.

NOTE 2 – The maximum number of retries is independent of the initial and maximum back-off windows that are defined by the CMTS.

If the CM receives a unicast Request or Data Grant at any time while deferring for this SID, it MUST stop the contention resolution process and use the explicit transmit opportunity.

The CMTS has much flexibility in controlling the contention resolution. At one extreme, the CMTS MAY choose to set up the Data Back-off Start and End to emulate an Ethernet-style back-off with its associated simplicity and distributed nature, but also its fairness and efficiency issues. This would be done by setting initial = 0 and max = 10 in the MAP. At the other end, the CMTS MAY make the Data Back-off Start and End identical and frequently update these values in the MAP so all cable modems are using the same, and hopefully optimal, back-off window.

A Transmit Opportunity is defined as any mini-slot in which a CM may be allowed to start a transmission. Transmit Opportunities typically apply to contention opportunities and are used to calculate the proper amount to defer in the contention resolution process.

The number of Transmit Opportunities associated with a particular IE in a MAP is dependent on the total size of the region as well as the allowable size of an individual transmission. As an example, assume a REQ IE defines a region of 12 mini-slots. If the UCD defines a REQ that fits into a single mini-slot, then there are 12 Transmit Opportunities associated with this REQ IE, i.e. one for each mini-slot. If the UCD defines a REQ that fits in two mini-slots, then there are six Transmit Opportunities and a REQ can start on every other mini-slot.

As another example, assume a REQ/Data IE that defines a 24 mini-slot region. If it is sent with an SID of 0x3FF4 (see Appendix B.I), then a CM can potentially start a transmit on every fourth mini-slot; so this IE contains a total of six Transmit Opportunities (TX OP). Similarly, a SID of 0x3FF6 implies four TX OPs; 0x3FF8 implies three TX OPs; and 0x3FFC implies two TX OPs.

For an Initial Maintenance IE, a CM MUST start its transmission in the first mini-slot of the region; therefore it has a single Transmit Opportunity. The remainder of the region is used to compensate for the round-trip delays since the CM has not yet been ranged.

Station Maintenance, Short and Long Data Grant IEs are specified for unicast and thus are NOT typically associated with contention Transmit Opportunities. They represent a single dedicated, or reservation-based, Transmit Opportunity.

In summary (see Table B.6-19).

Table B.6-19/J.112 – Transmit Opportunity

Interval	SID type	Transmit Opportunity
Request	Broadcast	# mini-slots required for a Request
Request	Multicast	# mini-slots required for a Request
Request/Data	Broadcast	Not allowed
Request/Data	Well-known Multicast	As defined by SID in Appendix B.I
Request/Data	Multicast	Vendor specific algorithms
Initial Maintenance	Broadcast	Entire interval is a single tx opportunity
Initial Maintenance	Multicast	Entire interval is a single tx opportunity

B.6.4.5 CM Behaviour

The following rules govern the response a CM may make when processing maps:

- 1) A CM MUST first use any Grants assigned to it. Next, the CM MUST use any unicast REQ for it. Finally, the CM MUST use the next available broadcast/multicast REQ or REQ/Data IEs for which it is eligible.
- 2) Only one Request may be outstanding at a time for a particular Service ID.
- 3) If a CM has a Request pending, it MUST NOT use intervening contention intervals for that Service ID.

B.6.4.6 Support for multiple channels

Vendors MAY choose to offer various combinations of upstream and downstream channels within one MAC service access point. The upstream bandwidth allocation protocol allows for multiple upstream channels to be managed via one or many downstream channels.

If multiple upstream channels are associated with a single downstream channel, then the CMTS MUST send one allocation map per upstream channel. The map's channel identifier, taken with the Upstream Channel Descriptor Message (see B.6.3.2.2), MUST specify to which channel each map applies. There is no requirement that the maps be synchronized across channels. Appendix B.VII provides an example.

If multiple downstream channels are associated with a single upstream channel, the CMTS MUST ensure that the allocation map reaches all CMs. That is, if some CMs are attached to a particular downstream channel, then the map MUST be transmitted on that channel. This MAY necessitate that multiple copies of the same map be transmitted. The slot reference in the map header MUST always relate to the SYNC reference on the downstream channel on which it is transmitted.

If multiple downstream channels are associated with multiple upstream channels, the CMTS MAY need to transmit multiple copies of multiple maps to ensure both that all upstream channels are mapped and that all CMs have received their needed maps.

B.6.4.7 Classes of service

This specification does not provide explicit classes of service, but provides the means for vendors to provide a variety of types of service.

This subclause illustrates how the available mechanisms can be used to provide support for the service classes defined in [RFC-1633] "Integrated Services in the Internet Architecture: An Overview".

[RFC-1633] divides applications into elastic applications which will always wait for data to arrive and inelastic applications in which the data must arrive within a certain time to be useful.

Within the inelastic category, further subdivisions can be defined:

- Delay-intolerant – The data must arrive within a perfectly reliable upper bound on delay.
- Delay-tolerant – The data must arrive within a fairly reliable but not perfectly reliable delay bound.

Within the elastic category the following application types can be distinguished:

- interactive burst;
- interactive bulk.

The service model should be able to support both types of inelastic application and to allow for lower delays for interactive elastic applications than for bulk elastic applications.

Inelastic delay-intolerant – The CMTS provides a Data Grant of fixed size to a configured Service ID once every N mini-slots. This Service ID MAY be assigned to all traffic for a CM, or it MAY only be used for this particular service within the CM.

Inelastic delay-tolerant – The CMTS periodically provides a unicast Request IE to a configured Service ID. It then grants the request based on the negotiated delay variation, bandwidth, and other considerations. The CM has guaranteed access in which to make requests, and the CMTS's scheduling algorithm provides the negotiated service. As an alternative, the minimum data rate of the service negotiation MAY be provided in the same way that inelastic delay-intolerant traffic is handled.

Elastic application support – Is provided by a contention/FIFO service strategy, in which CMs contend for request slots, and the CMTS services requests as they arrive. Service priorities can allow differential delays between interactive and bulk applications.

B.6.4.7.1 Resource-sharing

In order to support multiple end systems sharing the same upstream and downstream links, it is necessary to provide resource-sharing mechanisms for the link bandwidth. The following are some examples of this:

Link-usage feedback is provided implicitly by contention and by the CMTS's scheduling algorithm, so no explicit congestion notifications are needed.

Guaranteed Minimum Bit Rate can be provided in much the same manner as inelastic delay-tolerant application support.

Guaranteed Maximum Bit Rate MAY be provided by a number of implementation mechanisms, including the CMTS's allocation algorithm and throttling within the CM.

Service Priorities MUST be implemented by applying different service criteria to different Service IDs. It is anticipated that a particular CM MAY have several Service IDs, each corresponding to a particular service class. The particular services offered MAY vary from vendor to vendor.

Contention that is limited to a service class MAY be accomplished with multicast Request IEs and Request/Data IEs. Creation of such multicast groups is vendor-specific.

B.6.5 Timing and synchronization

One of the major challenges in designing a MAC protocol for a cable network is compensating for the large delays involved. These delays are an order of magnitude larger than the transmission burst time in the upstream. To compensate for these delays, the cable modem MUST be able to time its transmissions precisely to arrive at the CMTS at the start of the assigned mini-slot.

To accomplish this, two pieces of information are needed by each cable modem:

- a global timing reference sent downstream from the CMTS to all cable modems;
- a timing offset, calculated during a ranging process, for each cable modem.

B.6.5.1 Global timing reference

The CMTS MUST create a global timing reference by transmitting the Time Synchronization (SYNC) MAC management message downstream at a nominal frequency. The message contains a timestamp that exactly identifies when the CMTS transmitted the message. Cable modems MUST then compare the actual time the message was received with the timestamp and adjust their local clock references accordingly.

The Transmission Convergence sublayer must operate closely with the MAC sublayer to provide an accurate timestamp for the SYNC message. As mentioned in the Ranging subclause below (see B.6.5.3), the model assumes that the timing delays through the remainder of the PHY layer MUST be relatively constant. Any variation in the PHY delays MUST be accounted for in the guard time of the PHY overhead.

It is intended that the nominal interval between SYNC messages be tens of milliseconds. This imposes very little downstream overhead while letting cable modems acquire their global timing synchronization quickly.

B.6.5.2 CM channel acquisition

Any cable modem MUST NOT use the upstream channel until it has successfully synchronized to the downstream.

First, the cable modem MUST establish PMD sublayer synchronization. This implies that it has locked onto the correct frequency, equalized the downstream channel, recovered any PMD sublayer framing and the FEC is operational (refer to B.7.2.2). At this point, a valid bit stream is being sent to the transmission convergence sublayer. The transmission convergence sublayer performs its own synchronization (see B.5). On detecting the well-known MCNS PID, along with a payload unit start indicator per [ITU-T H.222.0], it delivers the MAC frame to the MAC sublayer.

The MAC sublayer MUST now search for the Timing Synchronization (SYNC) MAC management messages. The cable modem achieves MAC synchronization once it has received at least two SYNC messages and has verified that its clock tolerances are within specified limits.

A cable modem remains in "SYNC" as long as it continues to successfully receive the SYNC messages. If the Lost SYNC Interval (see Appendix B.II) has elapsed without a valid SYNC message, a cable modem MUST NOT use the upstream and MUST try to re-establish synchronization again.

B.6.5.3 Ranging

Ranging is the process of acquiring the correct timing offset such that the cable modem's transmissions are aligned to the correct mini-slot boundary. The timing delays through the PHY layer **MUST** be relatively constant. Any variation in the PHY delays **MUST** be accounted for in the guard time of the upstream PMD overhead.

First, a cable modem **MUST** synchronize to the downstream and learn the upstream channel characteristics through the Upstream Channel Descriptor MAC management message. At this point, the cable modem **MUST** scan the Bandwidth Allocation MAP message to find an Initial Maintenance Region. Refer to B.6.4.1.1.4. The CMTS **MUST** make an Initial Maintenance region large enough to account for the variation in delays between any two CMs.

The cable modem **MUST** put together a Ranging Request message to be sent in an Initial Maintenance region. The SID field **MUST** be set to the non-initialized CM value (zero).

Ranging adjusts each CM's timing offset such that it appears to be located right next to the CMTS. The CM **MUST** set its initial timing offset to the amount of internal fixed delay equivalent to putting this CM next to the CMTS. This amount includes delays introduced through a particular implementation, and **MUST** include the downstream PHY interleaving latency.

When the Initial Maintenance transmit opportunity occurs, the cable modem **MUST** send the Ranging Request message. Thus, the cable modem sends the message as if it was physically right at the CMTS.

Once the CMTS has successfully received the Ranging Request message, it **MUST** return a Ranging Response message addressed to the individual cable modem. Within the Ranging Response message **MUST** be a temporary SID assigned to this cable modem until it has completed the registration process. The message **MUST** also contain information on RF power level adjustment and offset frequency adjustment as well as any timing offset corrections.

The cable modem **MUST** now wait for an individual Station Maintenance region assigned to its temporary SID. It **MUST** now transmit a Ranging Request message at this time using the temporary SID along with any power level and timing offset corrections.

The CMTS **MUST** return another Ranging Response message to the cable modem with any additional fine tuning required. The ranging request/response steps **MUST** be repeated until the response contains a Ranging Successful notification. At this point, the cable modem **MUST** join normal data traffic in the upstream. See B.7 for complete details on the entire initialization sequence. In particular, state machines and the applicability of retry counts and timer values for the ranging process are defined in B.7.2.5.

NOTE – The burst type to use for any transmission is defined by the Interval Usage Code (IUC). Each IUC is mapped to a burst type in the UCD message.

B.6.5.4 Timing units and relationships

The SYNC message conveys a time reference that is measured in 6.25-ms ticks. Additional resolution of 6.25/64 ms is also present in the SYNC message to allow the CM to track the CMTS clock with a small phase offset. These units were chosen as the greatest-common-divisor of the upstream mini-slot time across various modulations and symbol rates. As this is decoupled from particular upstream channel characteristics, a single SYNC time reference may be used for all upstream channels associated with the downstream channel.

The bandwidth allocation MAP uses time units of "mini-slots". A mini-slot represents the byte-time needed for transmission of a fixed number of bytes. The mini-slot is expected to represent 16 byte-times, although other values could be chosen. The size of the mini-slot, expressed as a multiple of the SYNC time reference, is carried in the Upstream Channel Descriptor. The example in Table B.6-20 relates mini-slots to the SYNC time ticks.

The reader is encouraged to try other symbol rates and modulations. Note that the symbols/byte is a characteristic of an individual burst transmission, not of the channel. A mini-slot in this instance could represent either 16 or 32 bytes, depending on the modulation choice.

A "mini-slot" is the unit of granularity for upstream transmission opportunities. There is no implication that any PDU can actually be transmitted in a single mini-slot.

Table B.6-20/J.112 – Example relating mini-slots to time ticks

Parameter	Example value
Time tick	6.25 ms
Bytes per mini-slot	16 (nominal, when using QPSK modulation)
Symbols/byte	4 (assuming QPSK)
Symbols/s	2 560 000
Mini-slots/s	40 000
Microseconds/mini-slot	25
Ticks/mini-slot	4

The MAP counts mini-slots in a 32-bit counter that normally counts to $(2^{32} - 1)$ and then wraps back to zero. The least-significant bits (i.e. bit 0 to bit 25-M) of the mini-slot counter MUST match the most-significant bits (i.e. bit 6 + M to bit 31) of the SYNC timestamp counter. That is, mini-slot N begins at timestamp reference $(N * T * 64)$, where $T = 2^M$ is the UCD multiplier that defines the mini-slot (i.e. the number of time ticks per mini-slot).

NOTE – The unused upper bits of the 32-bit mini-slot counter (i.e. bit 26-M to bit 31) are not needed by the CM and MAY be ignored.

Note that the constraint that the UCD multiplier be a power of two has the consequence that the number of bytes per mini-slot must also be a power of two.

B.6.6 Data link encryption support

The procedures to support data link encryption are defined in [MCNS2], [MCNS7] and [MCNS8]. The interaction between the MAC layer and the security system is limited to the items defined below.

B.6.6.1 MAC messages

MAC Management messages (see B.6.3) MUST NOT be encrypted.

B.6.6.2 Framing

The following rules MUST be followed when the encryption is applied to the frame:

- Security specific header (Security Header of [MCNS2] or Privacy EH element of [MCNS8]) MUST be in the extended header and MUST be the first EH element of the Extended Header (EHDR) field.
- Encrypted data is carried as Data PDU to the Cable MAC transparently.
- When Security System Specification [MCNS2] is applied, Data PDU MUST be encrypted and decrypted using the mechanism defined in B.6.6.2.1.

B.6.6.2.1 Example of security system encryption

This example is defined for a frame received by a CM at the CMCI and transferred over the cable network to the CMTS and forwarded via an Ethernet-based NSI. For frames travelling in the NSI-to-CMCI direction, the roles of CM and CMTS are reversed.

B.6.6.2.1.1 CMCI to RF

Refer to Figure B.6-33.

B.6.6.2.1.2 RF to CMTS-NSI

Refer to Figure B.6-34.

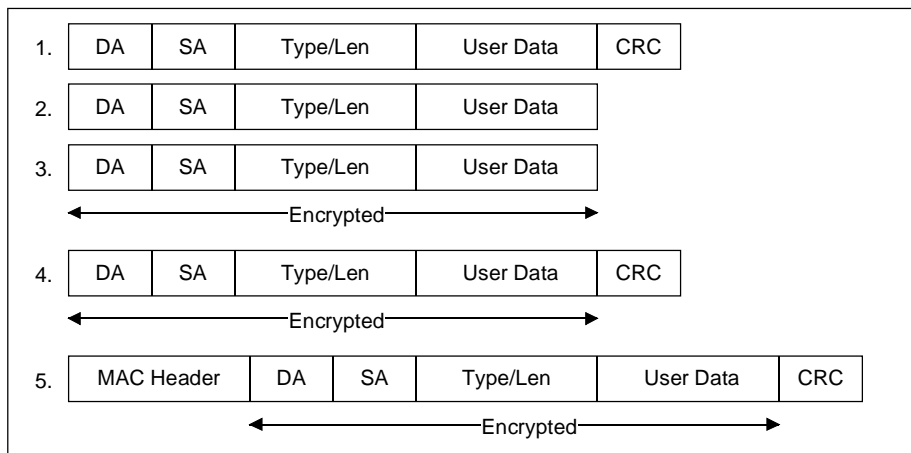

T0906590-98/d091

1. CM receives frame from Ethernet
2. Check and discard Ethernet CRC
3. Encrypt payload (DA, SA, Type/Len and User_Data)
4. Calculate new CRC over encrypted payload
5. Add MAC_Header including security header as the first EH element of the Extended Header (EHDR) field

Figure B.6-33/J.112 – Example of security framing at the CM

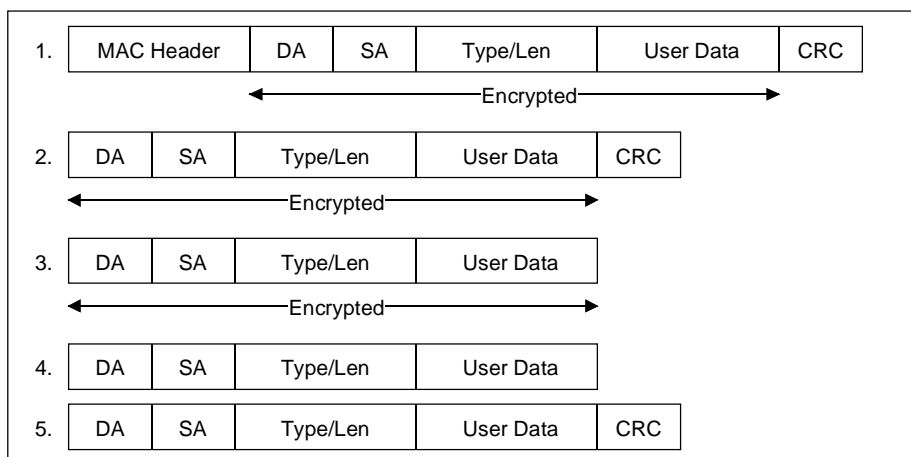

T0906600-98/d092

1. Receive frame from RF interface
2. Check and discard MAC Header including security header
3. Check and discard CR
4. Decrypt payload
5. Recalculate CRC and forward frame to CMTS-NSI

Figure B.6-34/J.112 – Example of security framing at the CMTS

B.7 Cable modem – CMTS interaction

This subclause covers key requirements for interaction between the cable modem and CMTS. The interaction can be broken down into five basic categories: modem initialization, authentication, configuration, authorization, and signalling.

B.7.1 CMTS initialization

The mechanism utilized for CMTS initialization (local terminal, file download, SNMP, etc.) is described in [MCNS5]. It MUST meet the following criteria for system interoperability:

- The CMTS MUST be able to reboot and operate in a stand-alone mode using configuration data retained in non-volatile storage.

- If valid parameters are not available from non-volatile storage or via another mechanism such as the Spectrum Management System (see [SMS]), the CMTS MUST not generate any downstream messages (including SYNC). This will prevent CMs from transmitting.
- The CMTS MUST provide the information defined in B.6 to CMs for each upstream channel.

B.7.2 Cable modem initialization

The procedure for initialization of a cable modem MUST be as shown in Figure B.7-1. This figure shows the overall flow between the stages of initialization in a CM. This shows no error paths, and is simply to provide an overview of the process. The more detailed finite state machine representations of the individual subclauses (including error paths) are shown in the subsequent figures. Timeout values are defined in Appendix B.II.

The procedure can be divided into the following phases:

- Removable Security Module (RSM) Detection.
- Scan for downstream channel and establish synchronization with the CMTS.
- Obtain transmit parameters (from UCD message).
- Perform ranging.
- Establish IP connectivity.
- Establish time of day.
- Establish Security Association (if RSM is present).
- Transfer operational parameters.
- Baseline Privacy initialization (if RSM is not present and CM is provisioned to run Baseline Privacy).

Each CM contains the following information when shipped from the manufacturer:

- A unique IEEE 802 48-bit MAC address which is assigned during the manufacturing process. This is used to identify the modem to the various provisioning servers during initialization.
- Security information as defined in [MCNS2 and MCNS8] (e.g. X.509 certificate) used to authenticate the CM to the security server and authenticate the responses from the security and provisioning servers.

The Specification and Description Language (SDL) notation used in the following figures is shown in Figure B.7-2 (refer to Recommendation Z.100 [ITU-T Z.100]).

B.7.2.1 RSM detection

When a CM is turned on, the CM determines whether Removable Security Module (RSM) is present in RSM slot or not as defined in [MCNS7].

B.7.2.2 Scanning and synchronization to downstream

On initialization or after signal loss, the cable modem MUST acquire a downstream channel. The CM MUST have non-volatile storage in which the last operational parameters are stored and MUST first try to re-acquire this downstream channel. If this fails, it MUST begin to continuously scan the 6-MHz channels of the downstream frequency band of operation until it finds a valid downstream signal.

A downstream signal is considered to be valid when the modem has achieved the following steps:

- synchronization of the QAM symbol timing;
- synchronization of the FEC framing;
- synchronization of the MPEG packetization;
- recognition of SYNC downstream MAC messages.

While scanning, it is desirable to give an indication to the user that the CM is doing so.

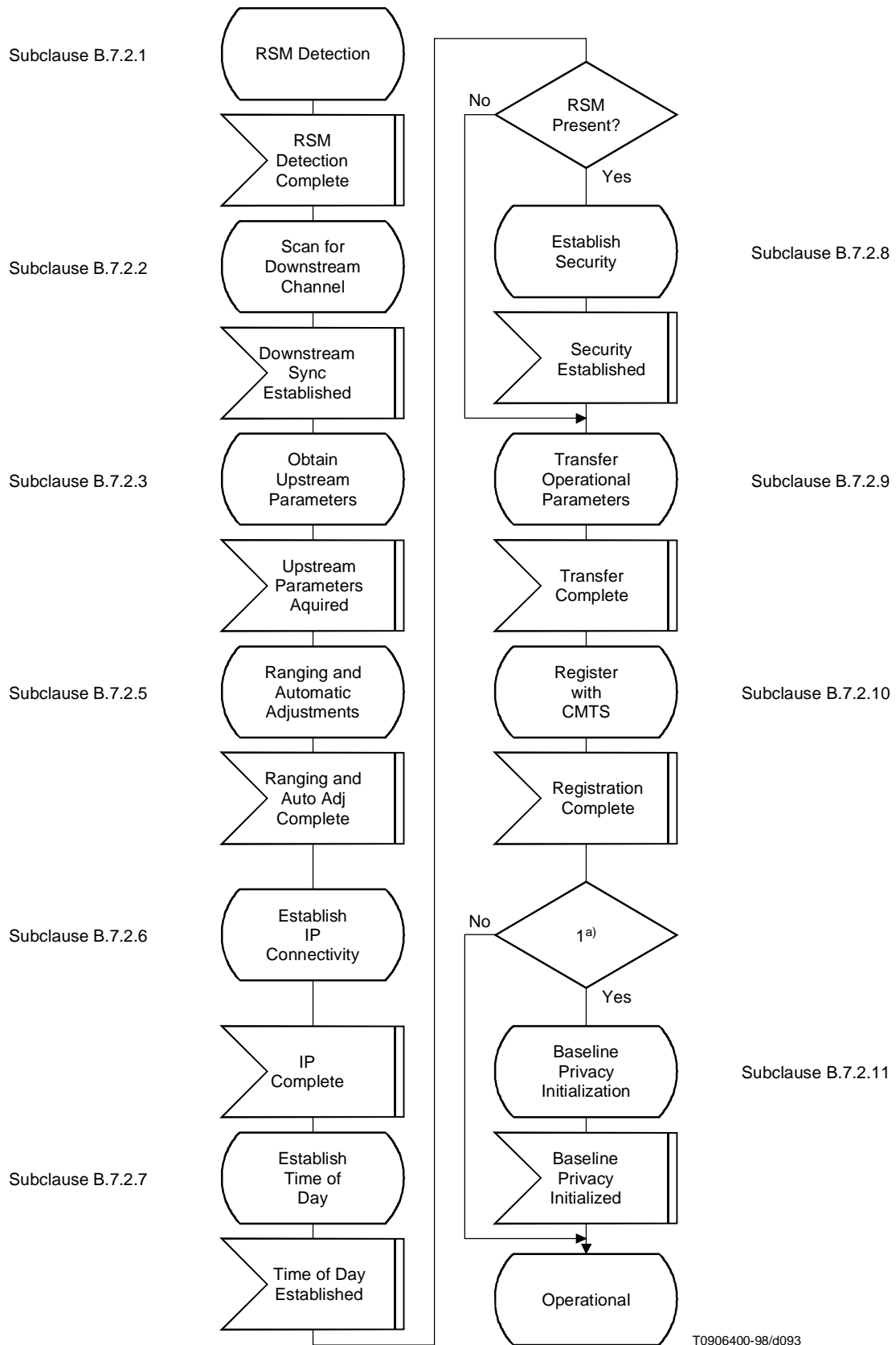

T0906400-98/d093

a) RSM not present and Baseline Privacy enabled.

Figure B.7-1/J.112 – CM initialization overview

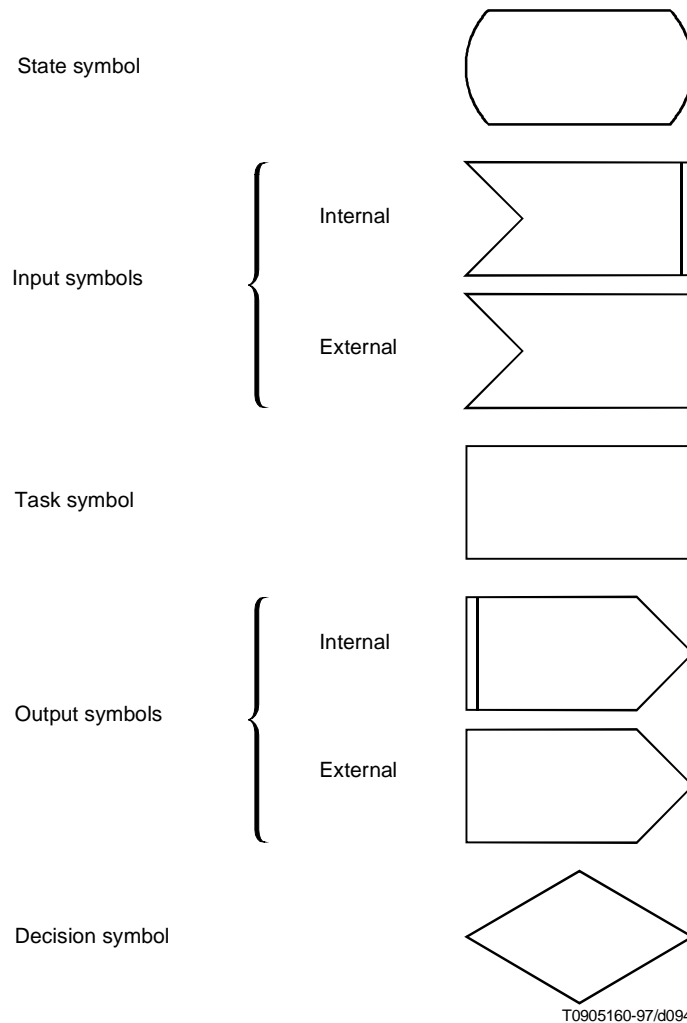

Figure B.7-2/J.112 – SDL notation

B.7.2.3 Obtain upstream parameters

Refer to Figure B.7-3 after synchronization, the CM MUST wait for an Upstream Channel Descriptor message (UCD) from the CMTS in order to retrieve transmission parameters for the upstream channel. These messages are transmitted periodically from the CMTS for all available upstream channels and are addressed to the MAC broadcast address. The CM MUST determine whether it can use the upstream channel from the channel description parameters. If the channel is not suitable, then the CM MUST wait for a Channel Description message for a channel which it can use. If no channel can be found after a suitable timeout period, then the CM MUST continue scanning to find another downstream channel.

When the cable modem finds an upstream channel with acceptable transmission parameters, it MUST extract the parameters for this upstream from the UCD. It then MUST wait for the next SYNC message⁸ and extract the upstream mini-slot timestamp from this message. The CM then MUST wait for a bandwidth allocation map for the selected channel. It MAY then begin transmitting upstream in accordance with the MAC operation and the bandwidth allocation mechanism.

It is desirable to give an indication to the user that the CM has finished searching and has detected a valid downstream signal and upstream channel.

⁸ Alternatively, since the SYNC message applies to all upstream channels, the CM may have already acquired a time reference from previous SYNC messages. If so, it need not wait for a new SYNC.

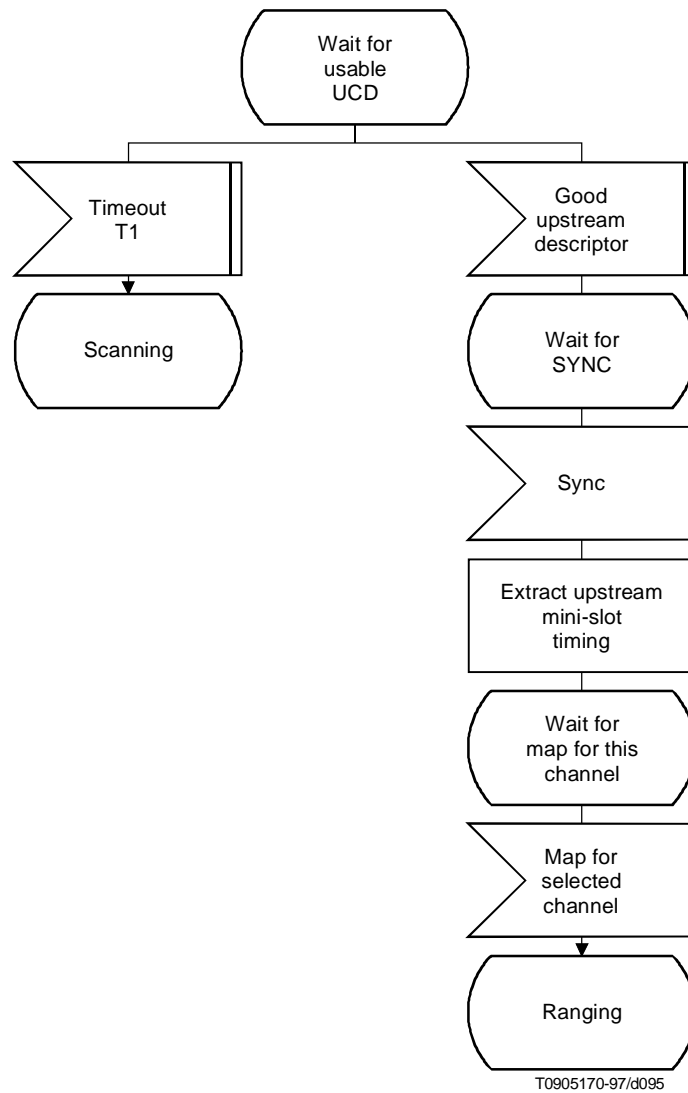

Figure B.7-3/J.112 – Obtaining upstream parameters

B.7.2.4 Message flows during scanning and Upstream parameter acquisition

The CMTS MUST generate SYNC and UCD messages on the downstream at periodic intervals within the ranges defined in B.6. These messages are addressed to all CMs. Refer to Figure B.7-4.

B.7.2.5 Ranging and automatic adjustments

The ranging and adjustment process is fully defined in B.6 and in the following subclauses. The message sequence chart and the finite state machines on the following pages define the ranging and adjustment process which MUST be followed by compliant CMs and CMTSs. Refer to Figures B.7-5 through B.7-8.

NOTE – MAPs are transmitted as described in B.6.

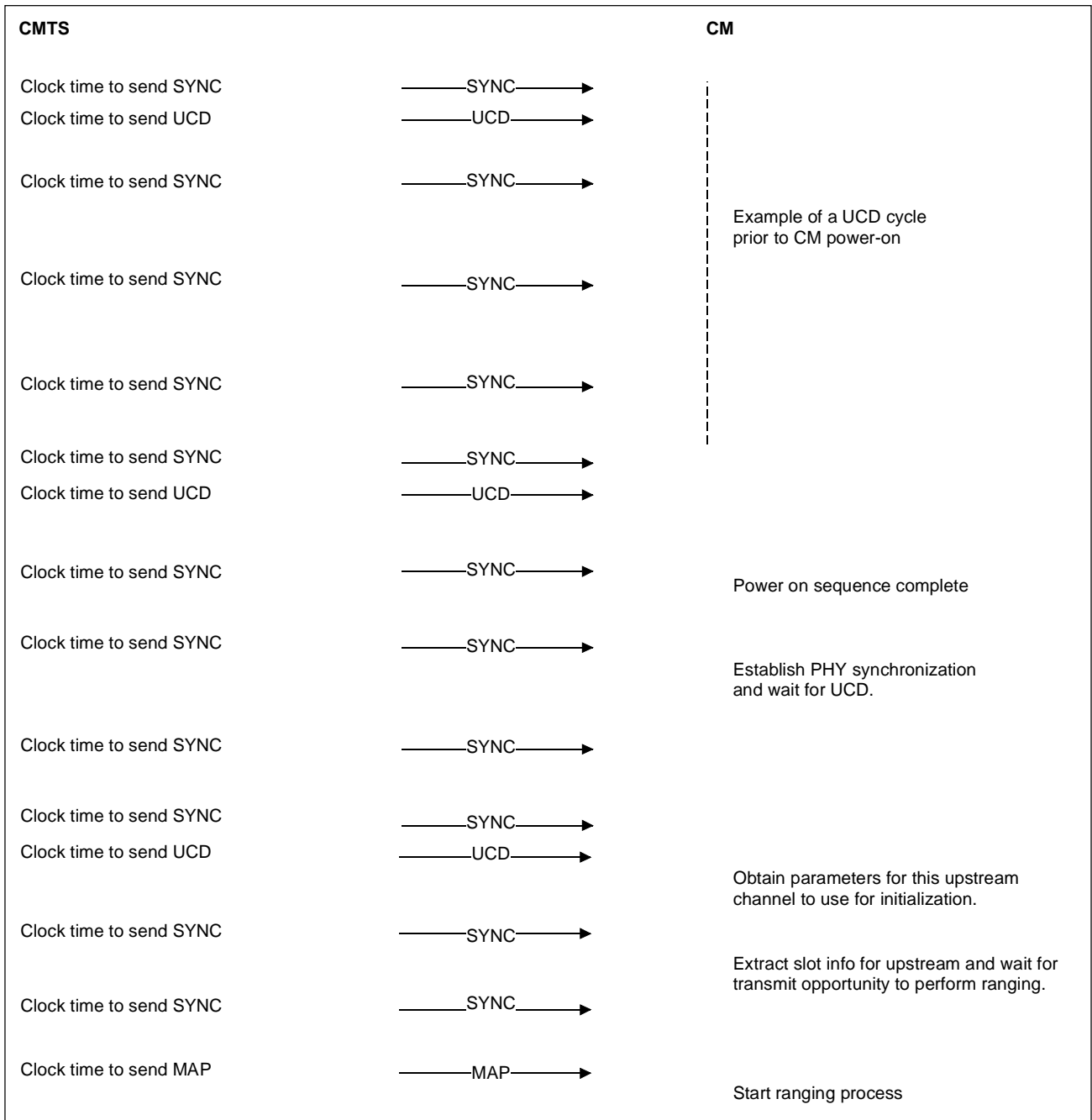

T0906750-98/d096

Figure B.7-4/J.112 – Message flows during scanning and Upstream parameter acquisition

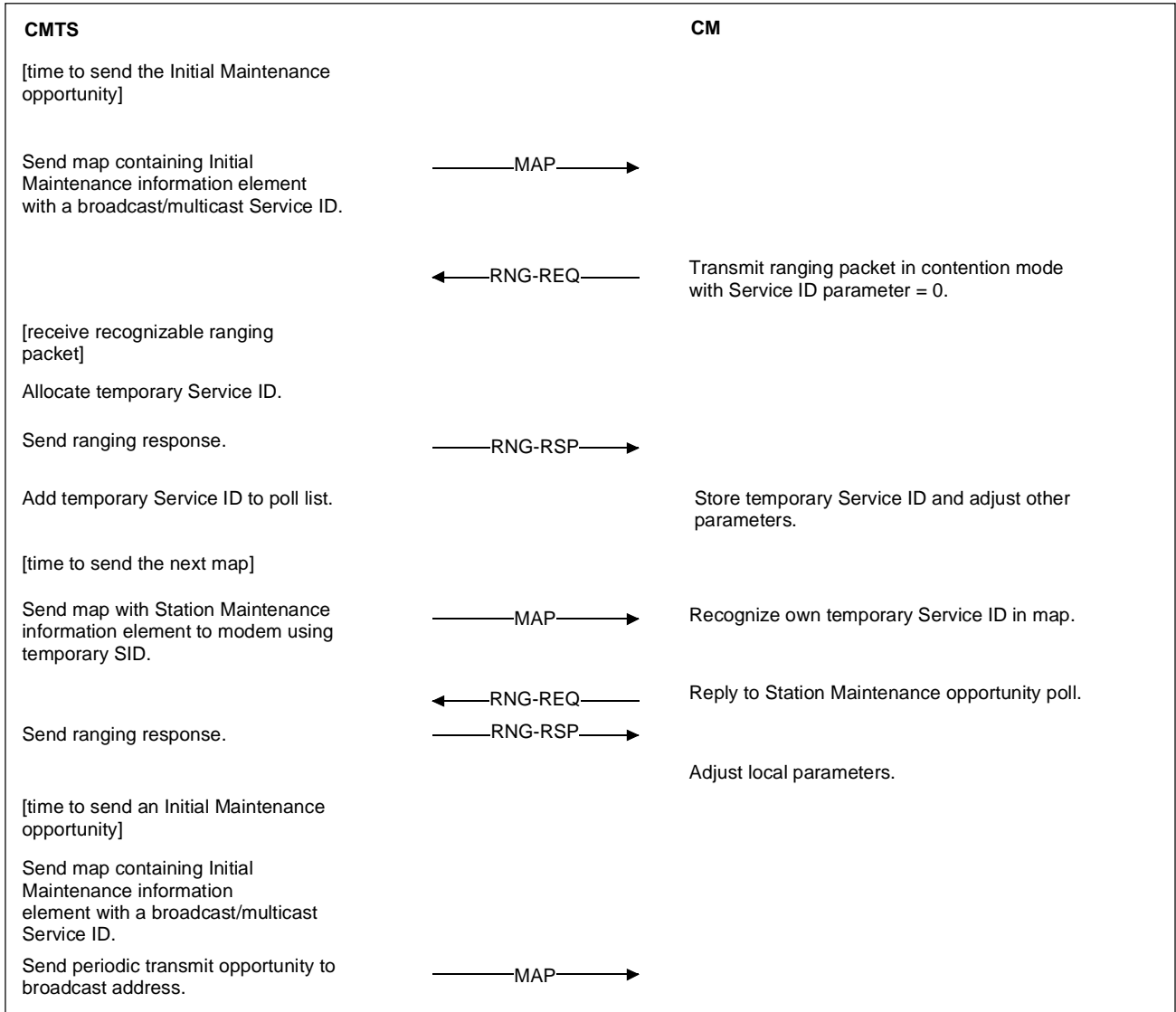

T0906760-98/d097

NOTE – The CMTS MUST allow the CM sufficient time to have processed the previous RNG-RSP (i.e. to modify the transmitter parameters) before sending the CM a specific ranging opportunity. This is defined as CM Ranging Response Time in Appendix B.II.

Figure B.7-5/J.112 – Ranging and automatic adjustment procedure

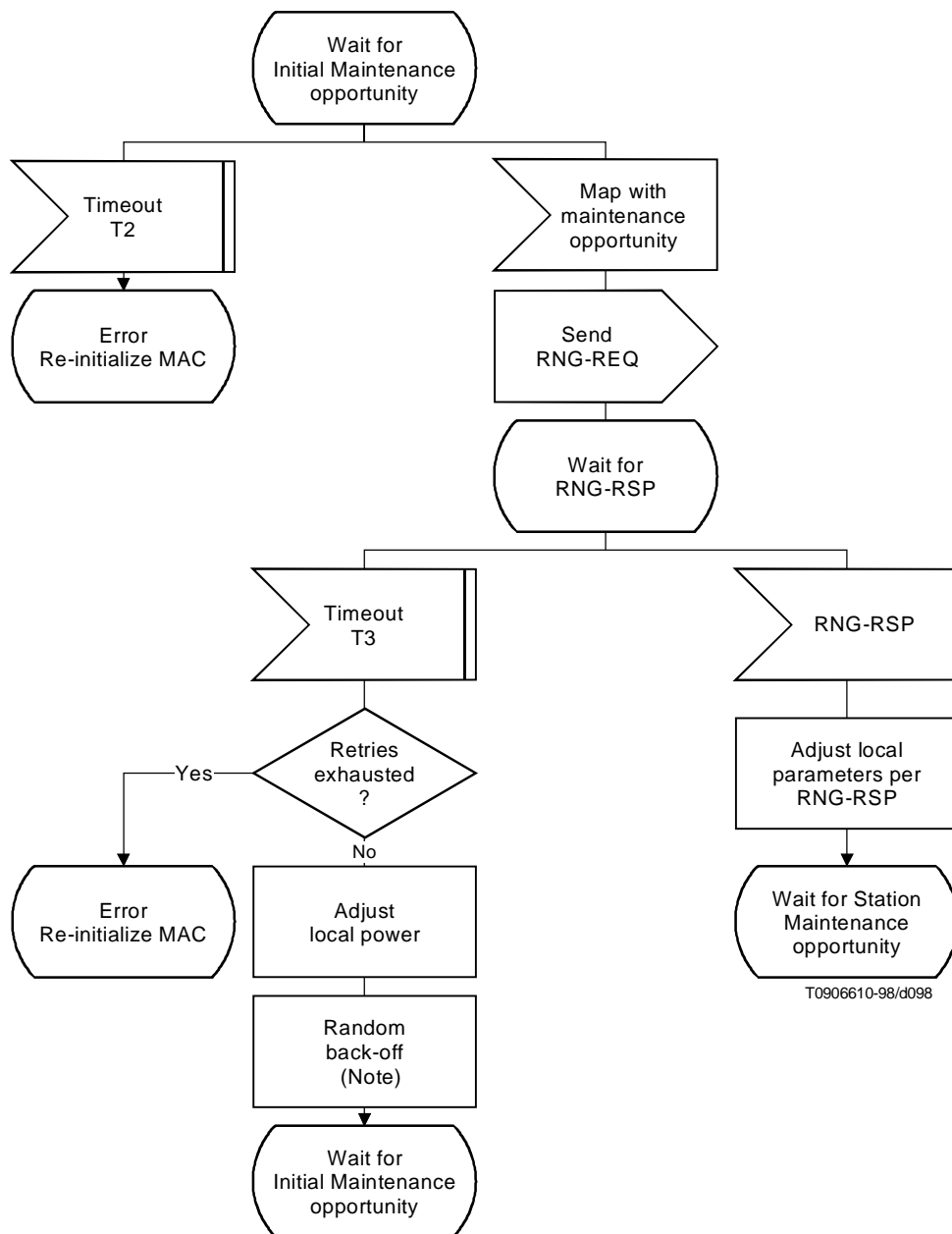

NOTE – Timeout T3 may occur because the RNG-REQs from multiple modems collided. To avoid these modems repeating the loop in lockstep, a random back-off is required. This is a back-off over the ranging window specified in the MAP.

Figure B.7-6/J.112 – Initial Ranging – CM

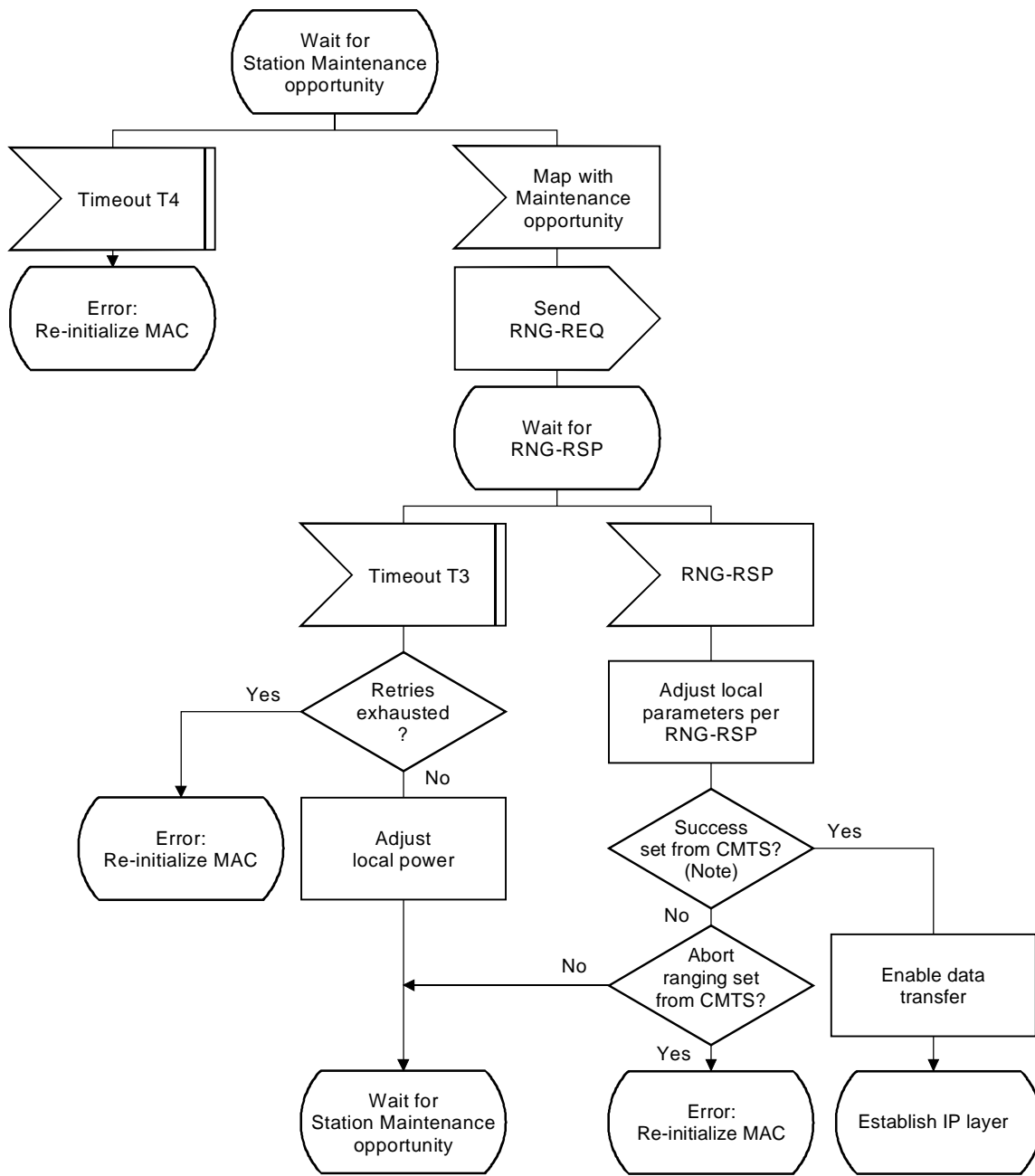

T0906620-98/d099

NOTE – Ranging Request is within the tolerance of the CMTS.

Figure B.7-7/J.112 – Initial Ranging – CM

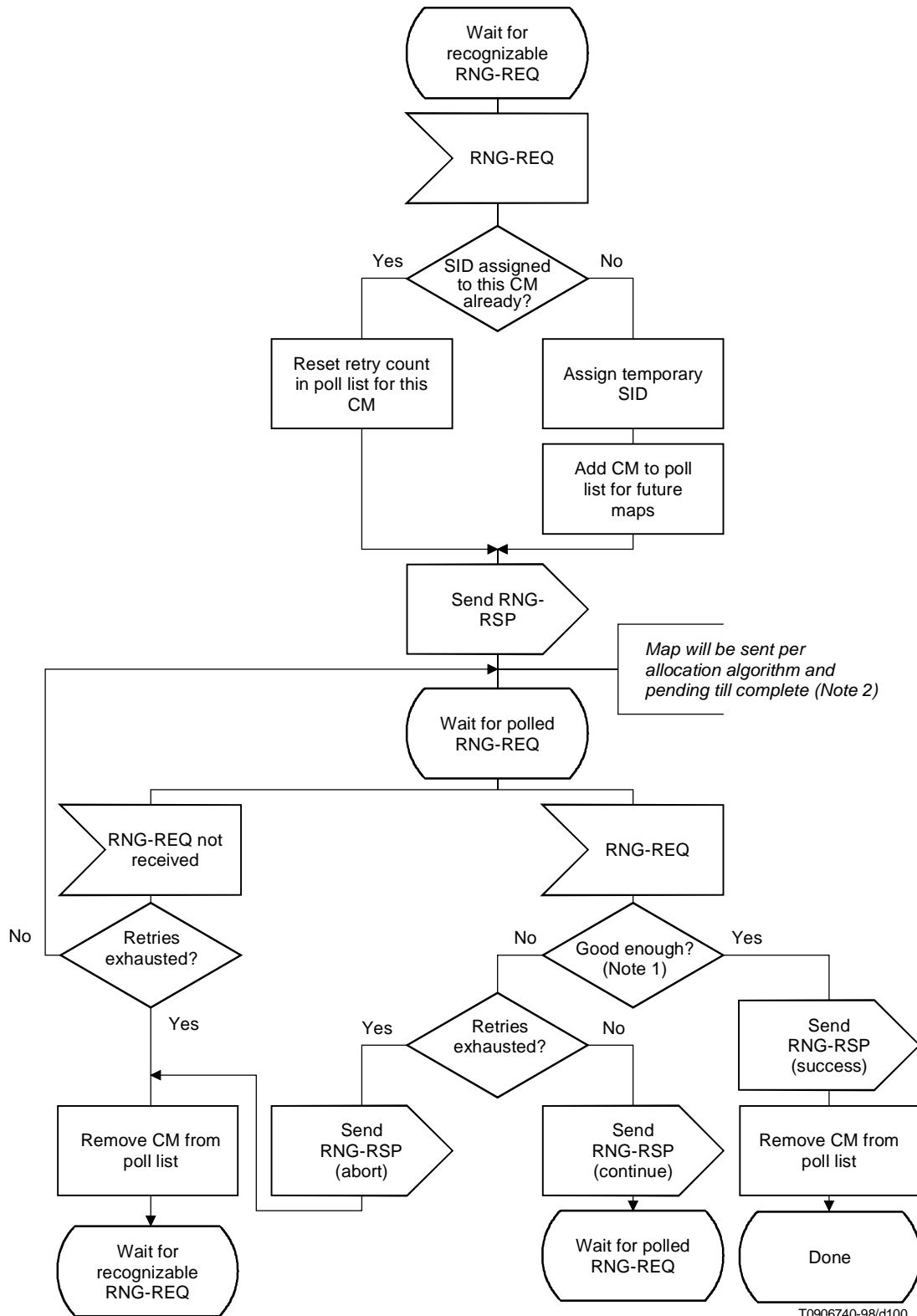

T0906740-98/d100

NOTE 1 – Means ranging is within the tolerable limits of the CMTS.

NOTE 2 – RNG-REQ pending-till-complete was non-zero, the CMTS SHOULD hold off the station maintenance opportunity accordingly, unless needed, for example, to adjust the CM's power level. If opportunities are offered prior to the pending-till-complete expiry, the "good-enough" test which follows receipt of a RNG-RSP MUST NOT judge the CM's transmit equalization until pending-till-complete expires.

Figure B.7-8/J.112 – Initial Ranging – CMTS

B.7.2.5.1 Ranging parameter adjustment

Adjustment of local parameters (e.g. transmit power) in a CM as a result of the receipt (or non-receipt) of an RNG-RSP is considered to be implementation-dependent with the following restrictions (refer to B.6.2.7):

- All parameters MUST be within the approved range at all times.
- Power adjustment MUST start from the minimum value unless a valid power is available from non-volatile storage, in which case this MUST be used as a starting point.
- Power adjustment MUST be capable of being reduced or increased by the specified amount in response to RNG-RSP messages.
- If power is adjusted to the maximum value, it MUST wrap back to the minimum.

B.7.2.5.2 Periodic ranging

The CMTS MUST provide each CM a Periodic Ranging opportunity at least once every T4 s. The CMTS MUST send out Periodic Ranging opportunities at an interval sufficiently shorter than T4 that a MAP could be missed without the CM timing out. The size of this "subinterval" is CMTS dependent.

The CM MUST reinitialize its MAC layer after T4 s have elapsed without receiving a Periodic Ranging opportunity.

B.7.2.6 Establish IP connectivity

At this point, the CM MUST invoke DHCP mechanisms [RFC-1541] in order to obtain an IP address and any other parameters needed to establish IP connectivity (see Appendix B.III). The DHCP response MUST contain the name of a file which contains further configuration parameters. Refer to Figure B.7-9.

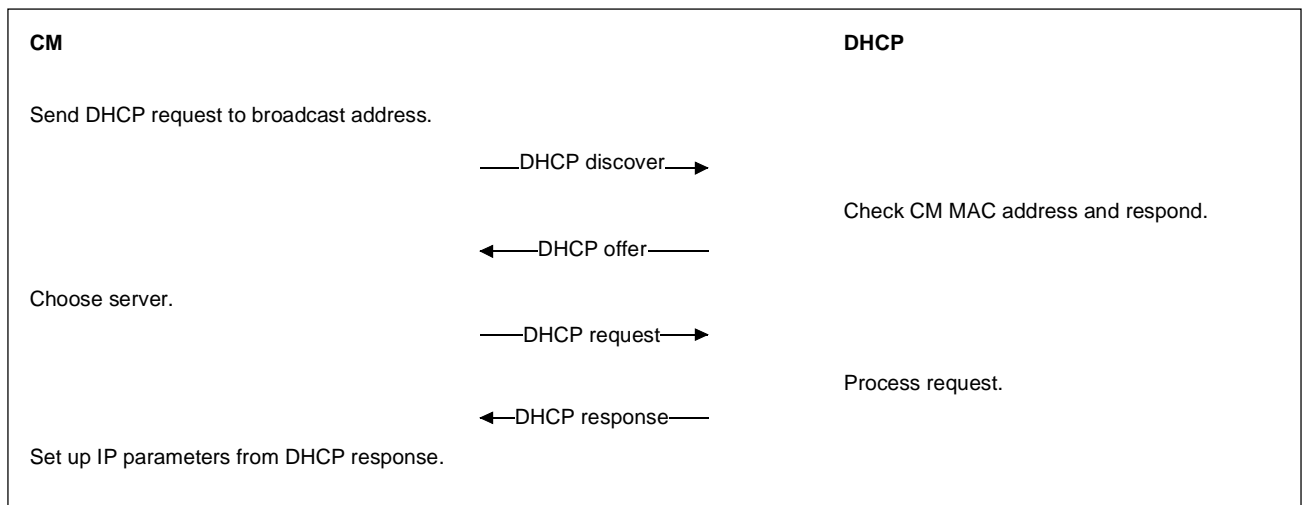

T0906630-98/d101

Figure B.7-9/J.112 – Establishing IP connectivity

B.7.2.7 Establish time of day

The CM and CMTS need to have the current date and time. This need not be authenticated and need only be accurate to the nearest second [MCNS2].

This is required for:

- time-stamping logged events which can be retrieved by the management system;
- key management by the security system.

The protocol by which the time of day is retrieved will be as defined in [RFC-868]. Refer to Figure B.7-10.

The request and response will be transferred using UDP.

The time retrieved from the server (UTC) will be combined with the time offset received from the DHCP response to create the current local time.

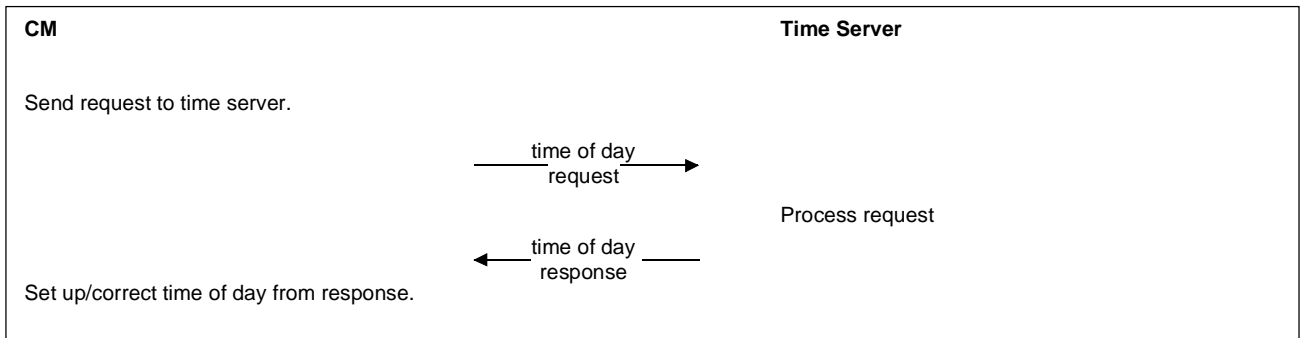

T0906640-98/d102

Figure B.7-10/J.112 – Establishing time of day

B.7.2.8 Establish security association

If the RSM module is detected and no security association has been established, the CM MUST establish a security association at this point. The IP address of the security server (or servers) MUST be provided as part of the DHCP response. The procedures required are fully defined in [MCNS2].

B.7.2.9 Transfer operational parameters

After the DHCP and security association operations are successful, the modem MUST download the parameter file using TFTP, as shown in Figure B.7-11. The TFTP configuration parameter server is specified by the "siaddr" field of the DHCP response.

The parameter fields required in the DHCP response and the format and content of the configuration file MUST be as defined in Appendix B.III. Note that these fields are the minimum required for interoperability.

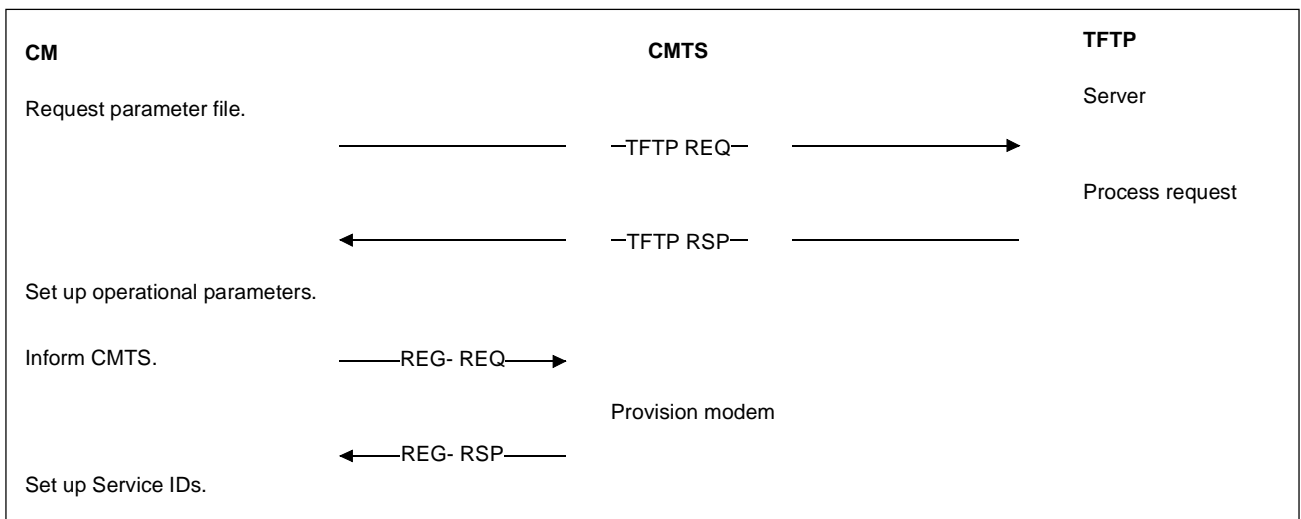

T0906650-98/d103

Figure B.7-11/J.112 – Transferring operational parameters and registration

B.7.2.10 Registration

A CM MUST be authorized to forward traffic into the network once it is initialized, authenticated and configured. Refer to Figure B.7-11.

The configuration parameters downloaded to the CM MUST include a network access control object (see Appendix B.III.8.5). If this is set to "no forwarding", the CM MUST not forward data to the network. It MUST respond to network management requests. This allows the CM to be configured in a mode in which it is manageable but will not forward data.

The CM MUST forward the operational parameters to the CMTS as part of a registration request. The CMTS MUST perform the following operations to confirm the CM authorization:

- check the MAC and the authentication signature on the parameter list;
- build a profile for the modem based on the standard configuration settings (see Appendix B.III);
- assign a Service ID based on the classes of service supported;
- reply to the modem registration request.

Vendor-specific configuration settings MUST be ignored (except for inclusion in message authorization code calculation).

B.7.2.11 Baseline Privacy initialization

Following registration, if the RSM module is NOT detected and the CM is provisioned to run Baseline Privacy, the CM MUST initialize Baseline Privacy operations, as described in [MCNS8]. A CM is provisioned to run Baseline Privacy if its configuration file includes a Baseline Privacy Configuration Setting.

B.7.2.12 Service IDs during CM initialization

After completion of the Registration process (see B.7.2.10), the CM will have been assigned Service IDs (SIDs) to match its class of service provisioning. However, the CM must complete a number of protocol transactions prior to that time (e.g. Ranging, DHCP, etc.), and requires a temporary Service ID in order to complete those steps.

On reception of an Initial Ranging Request, the CMTS MUST allocate a temporary SID and assign it to the CM for initialization use. The CMTS MAY monitor use of this SID and restrict traffic to that needed for initialization. It MUST inform the CM of this assignment in the Ranging Response.

On receiving a Ranging Response addressed to it, the CM MUST use the assigned temporary SID for further initialization transmission requests until the Registration Response is received.

On receiving a Ranging Response instruction to move to a new downstream frequency and/or upstream channel ID, the CM MUST consider any previously assigned temporary SID to be deassigned, and must obtain a new temporary SID via initial ranging.

It is possible that the Ranging Response may be lost after transmission by the CMTS. The CM MUST recover by timing out and re-issuing its Initial Ranging Request. Since the CM is uniquely identified by the source MAC address in the Ranging Request, the CMTS MAY immediately re-use the temporary SID previously assigned. If the CMTS assigns a new temporary SID, it MUST make some provision for aging out the old SID that went unused (see B.6.3.2.7).

When assigning class-of-service-provisioned SIDs on receiving a Registration Request, the CMTS may re-use the temporary SID, assigning it to one of the class of service classes requested. If so, it MUST continue to allow initialization messages on that SID, since the Registration Response could be lost in transit. If the CMTS assigns all-new SIDs for class-of-service provisioning, it MUST age out the temporary SID. The aging-out MUST allow sufficient time to complete the registration process in case the Registration Response is lost in transit.

B.7.2.13 Multiple-channel support

In the event that more than one downstream signal is present in the system, the CM MUST operate using the first valid downstream signal that it encounters when scanning. It will be instructed via the parameters in the configuration file (see Appendix B.III) to shift operation to different downstream and/or upstream frequencies if necessary.

Both upstream and downstream channels MUST be identified where required in MAC management messages using channel identifiers.

B.7.2.14 Remote RF signal level adjustment

RF signal level adjustment at the CM is performed through a periodic maintenance function using the RNG-REQ and RNG-RSP MAC messages. This is similar to initial ranging and is shown in Figures B.7-12 and B.7-13. On receiving a RNG-RSP, the CM MUST NOT transmit until the RF signal has been adjusted in accordance with the RNG-RSP and has stabilized (refer to B.4).

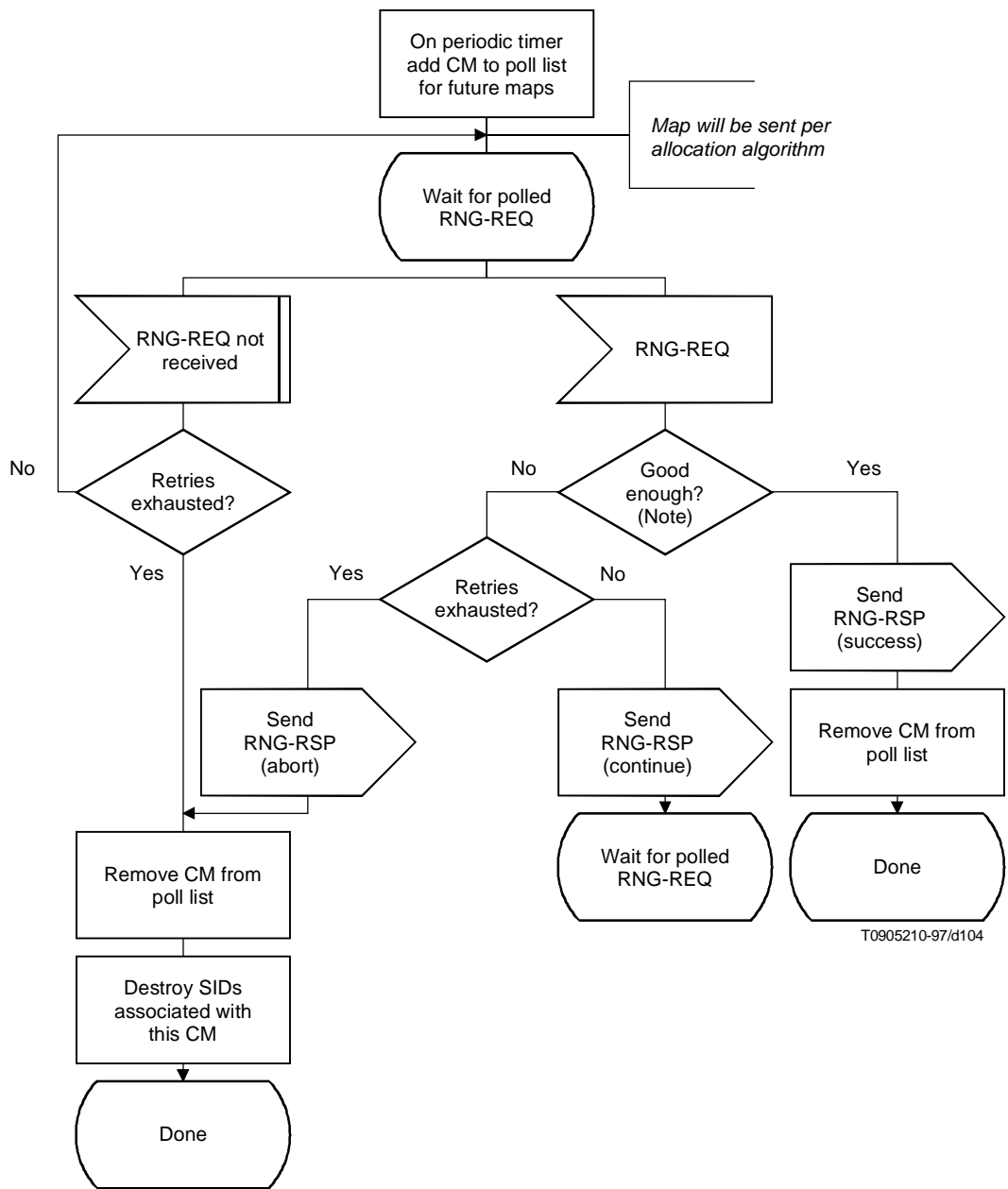

T0905210-97/d104

NOTE – Means Ranging Request is within the tolerance limits of the CMTS for power and transmit equalization (if supported).

Figure B.7-12/J.112 – Periodic Ranging – CMTS

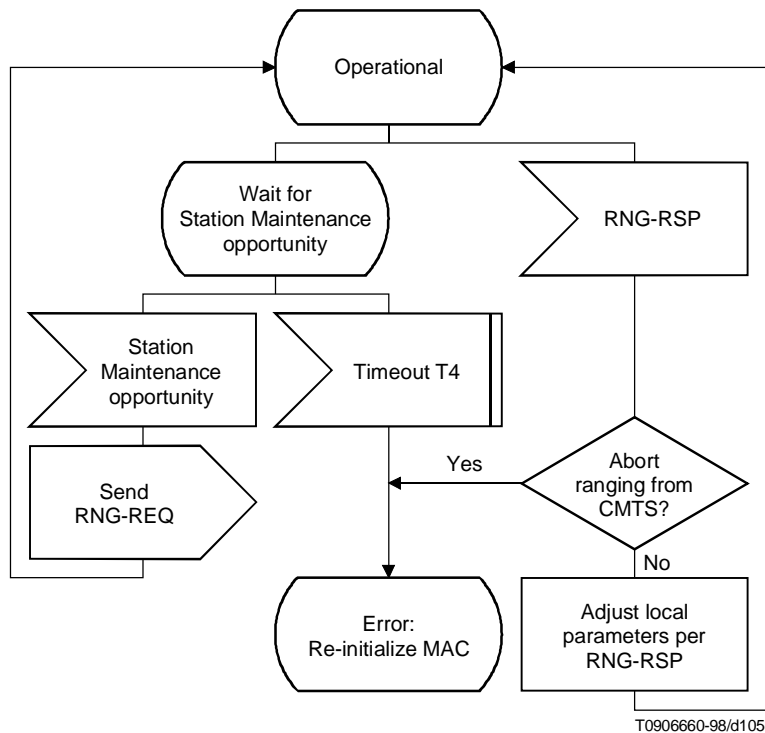

Figure B.7-13/J.112 – Periodic Ranging – CM View

B.7.2.15 Changing upstream burst parameters

Whenever the CMTS is to change any of the upstream burst characteristics, it must provide for an orderly transition from the old values to the new values by all CMs. Whenever the CMTS is to change any of the upstream burst values, it **MUST**:

- Announce the new values in an Upstream Channel Descriptor message. The Configuration Change Count field must be incremented to indicate that a value has changed.

After transmitting one or more UCD messages with the new value, the CMTS transmits a MAP message with a UCD Count matching the new Configuration Change Count. The first interval in the MAP **MUST** be a data grant of at least 1 ms to the null Service ID (zero). That is, the CMTS **MUST** allow one millisecond for cable modems to change their PMD sublayer parameters to match the new set. This millisecond is in addition to other MAP timing constraints (see B.6.4.2).

- The CMTS **MUST NOT** transmit MAPs with the old UCD Count after transmitting the new UCD.

The CM **MUST** use the parameters from the UCD corresponding to the MAP's "UCD Count" for any transmissions it makes in response to that MAP. If the CM has, for any reason, not received the corresponding UCD, it cannot transmit during the interval described by that MAP.

B.7.2.16 Changing upstream channels

At any time after registration, the CMTS **MAY** direct the CM to change its upstream channel. This may be done for traffic balancing, noise avoidance, or any of a number of other reasons which are beyond the scope of this specification. Figure B.7-14 shows the procedure that **MUST** be followed by the CMTS. Figure B.7-15 shows the corresponding procedure at the CM.

Note that if the CMTS retries the UCC-REQ, the CM may have already changed channels (if the UCC-RSP was lost in transit). Consequently, the CMTS **MUST** listen for the UCC-RSP on both the old and the new channels.

The CM MUST successfully establish initial ranging on a new channel before using that channel. It MUST NOT perform re-registration, since its provisioning and MAC domain remain valid on the new channel. If the CM has previously established ranging on the new channel, and if that ranging on that channel is still current (T4 has not elapsed since the last successful ranging), then the CM MAY use cached ranging information and may omit initial ranging.

B.7.2.17 Fault detection and recovery

Fault detection and recovery occurs at multiple levels:

- At the physical level, FEC is used to correct errors where possible – refer to B.4 for details.
- The MAC protocol protects against errors through the use of checksum fields across both the MAC Header and the data portions of the packet – refer to B.6 for details.
- All MAC management messages are protected with a CRC covering the entire message, as defined in B.6. Any message with a bad CRC MUST be discarded by the receiver.

Table B.7-1 shows the recovery process that MUST be taken following the loss of a specific type of MAC message.

Messages at the network layer and above are considered to be data packets by the MAC sublayer. These are protected by the CRC field of the data packet and any packets with bad CRCs are discarded. Recovery from these lost packets is in accordance with the upper layer protocol.

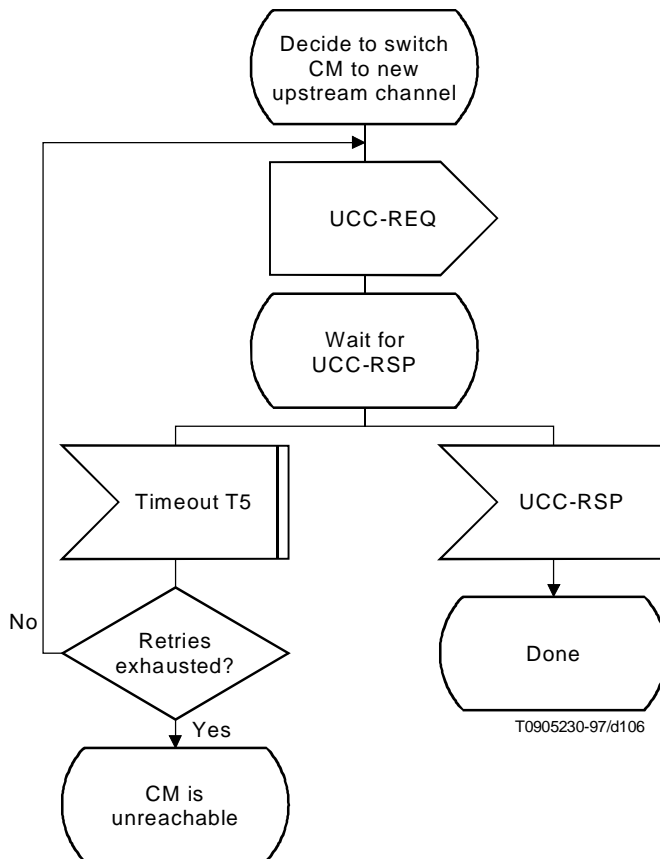

Figure B.7-14/J.112 – Changing upstream channels – CMTS view

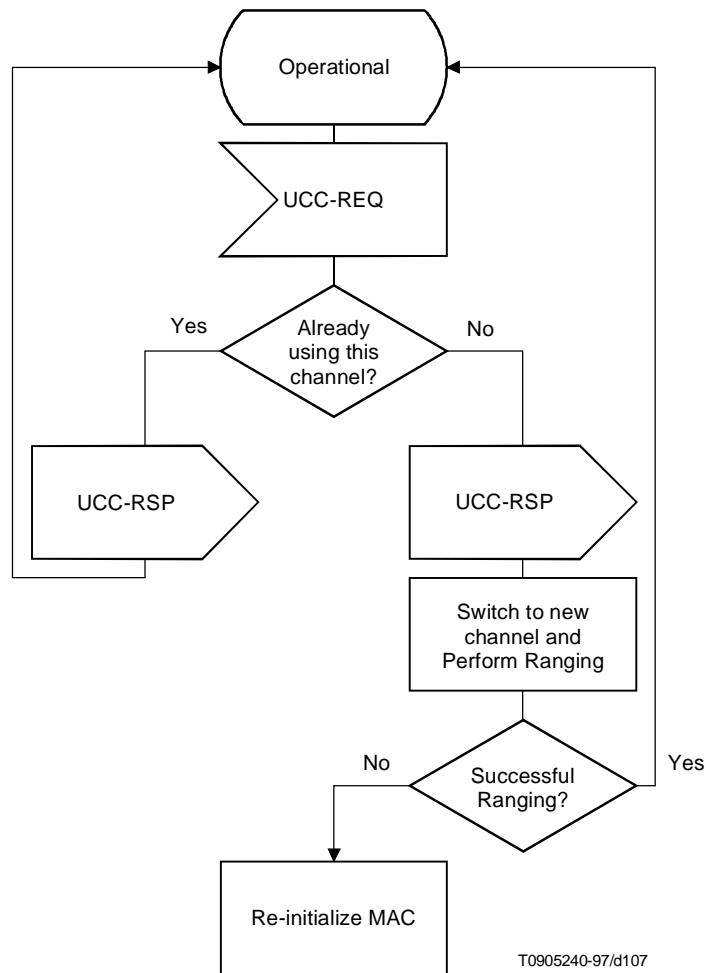

Figure B.7-15/J.112 – Changing Upstream Channels – CM view

Table B.7-1/J.112 – Recovery process on loss of specific MAC messages

Message name	Action following message loss
SYNC	The CM can lose SYNC messages for a period of the loss SYNC interval (see Appendix B.II) before it has lost synchronization with the network. When this occurs, it follows the same procedures to re-acquire connectivity as during initialization.
UCD	A CM MUST receive a valid UCD before transmitting on the upstream. Failure to receive a valid UCD within the timeout period MUST cause the modem to reset and re-initialize its MAC connection.
MAP	A CM MUST NOT transmit without a valid upstream bandwidth allocation. If a MAP is missed due to error, the CM MUST NOT transmit for the period covered by the MAP.
RNG-REQ RNG-RSP	If a CM fails to receive a valid Ranging Response within a defined timeout period after transmitting a request, the request MUST be retried a number of times (as defined in Appendix B.II). Failure to receive a valid Ranging Response after the requisite number of attempts MUST cause the modem to reset and re-initialize its MAC connection.
REG-REQ REG-RSP	If a CM fails to receive a valid registration response within a defined timeout period after transmitting a request, the request will be retried a number of times (as defined in Appendix B.II). Failure to receive a valid registration response after the requisite number of attempts will cause the modem to reset and re-initialize its MAC connection.
UCC-REQ UCC-RSP	If a CMTS fails to receive a valid upstream channel change response within a defined timeout period after transmitting a request, the request MUST be retried a number of times (as defined in Appendix B.II). Failure to receive a valid response after the requisite number of attempts MUST cause the CMTS to consider the CM as unreachable.

B.7.2.18 Prevention of unauthorized transmissions

A CM SHOULD include a means for terminating RF transmission if it detects that its own carrier has been on continuously for longer than the longest possible valid transmission.

B.8 Supporting future new cable modem capabilities

B.8.1 Setting up communications on an enhanced basis

In the future, new types of CM or CMTS with enhanced characteristics may be introduced. Future-proofing is provided, in the protocols described herein, to permit these new types of CM or CMTS to set up communication on an enhanced basis.

Two methods are provided to accomplish this: one for use when the downstream channel supports upstream channels of varying capability and the other for the case where enhanced downstream channels are available.

B.8.1.1 Upstream enhanced / Downstream standard

The procedure MUST be as follows:

- a) The enhanced CM acquires a standard downstream CMTS signal.
- b) The CM receives and interprets Upstream Channel Descriptor (UCD) messages forwarded from the CMTS until it finds one for a channel with the enhanced characteristics which it wishes to use. It joins the upstream transmission stream of this channel which has been assigned to enhanced CMs in accordance with the information in the downstream CMTS signal.

B.8.1.2 Downstream enhanced / Upstream enhanced or standard

The procedure MUST be as follows:

- a) The enhanced CM acquires a standard downstream CMTS signal.
- b) The CM receives and interprets Upstream Channel Descriptor (UCD) messages forwarded from the CMTS until it finds one for a channel with the best match to the enhanced characteristics which it wishes to use. It joins the upstream transmission stream of this channel which has been assigned to enhanced CMs in accordance with the information in the downstream CMTS signal.
- c) The enhanced CM interacts with the provisioning server for the purposes of agreeing upon the operating frequencies, modulation, data rate and other characteristics for enhanced operation.
- d) The enhanced CM changes operating frequencies and other characteristics accordingly, if necessary, and commences enhanced operation on a different downstream channel, if necessary, under conditions that will not interfere with the standard CMs.
- e) The CM acquires the new downstream CMTS signal and waits on appropriate UCD on this new channel.

B.8.2 Downloading cable modem operating software

A CMTS SHOULD be capable of being remotely reprogrammed in the field via a software download via the network.

The cable modem device MUST be capable of being remotely reprogrammed in the field via a software download over the network. This software download capability MUST allow the functionality of the cable modem to be changed without requiring that cable system personnel physically revisit and reconfigure each unit. It is expected that this field programmability will be used to upgrade cable modem software to improve performance, accommodate new functions and features (such as enhanced class of service support), correct any design deficiencies discovered in the software, and to allow a migration path as the Data Over Cable Interface Specification evolves.

The mechanism used for download MUST be TFTP file transfer. The mechanism by which transfers are secured and authenticated is in [MCNS2]. The transfer MUST be initiated in one of two ways:

- An SNMP manager requests the CM to upgrade.
- The configuration parameter file delivered to the CM from the provisioning server MUST include the desired filename from which the desired software image can be retrieved. If the filename does not match the current software image of the CM, the CM MUST request the specified file from a TFTP server.

The CM MUST write the new software image to non-volatile storage. Once the file transfer is complete, the CM MUST restart itself with the new code image.

If the CM is unable to complete the file transfer for any reason, it MUST remain capable of accepting new software downloads, even if power is interrupted between attempts. The CM MUST log the failure and MAY report it asynchronously to the network manager.

Following upgrade of the operational software, the CM MAY need to follow one of the procedures described above in order to change channels to use the enhanced functionality.

If the CM is to continue to operate in the same upstream and downstream channels as before the upgrade, then it MUST be capable of inter-working with other CMs which MAY be running previous releases of software.

Where software has been upgraded to meet a new version of the specification, then it is critical that it MUST inter-work with the previous version in order to allow a gradual transition of units on the network.

The periodic SYNC message transmitted on the downstream channel MUST indicate the protocol revision at which the channel is operating.

B.9 Provision for other future capabilities

It is anticipated that cable modem networks will, in the future, support capabilities that cannot be adequately defined today. These capabilities may include:

- new physical-layer modulation encoding;
- improvements to, or new configuration settings within, the defined physical-layer encoding;
- differing traffic flows and classes of service (e.g. STM telephony).

It is the intent of this specification to provide for interoperability with future devices and networks to whatever extent is practical. The minimum level of interoperability is that future-capability modems and modems conforming to this specification are assigned to different frequency bands, and all modems can automatically scan to find a congenial frequency band.

B.9.1 Anticipated physical-layer changes

Existing MAC signalling provides for optional transmitter equalization (see B.6.3.2.5).

Other forms of upstream transmission manipulation, such as Tomlinson-Harashima precoding, may be developed in the future. Signalling to support such can be added as optional TLV-encodings for the Ranging Response message.

This configuration setting can be phased into existing networks without placing new requirements on existing devices.

When developing a new network, it may be necessary to know modem capabilities before coming to rely on a feature like this. The "Modem Capabilities" mask, exchanged as part of the CM-to-CMTS registration process (see B.6.3.2.7) is intended to provide this information.

B.9.1.1 Adding upstream channel and burst configuration settings

In future, configuration settings may be provided for new upstream channel characteristics:

- Higher-symbol-rate signalling

and new upstream burst characteristics:

- Trellis-coded modulation (2 bits/sym and 4 bits/sym)
- Interleaving within a burst.

These are defined through new encodings of the Upstream Channel Descriptor. A CM which finds characteristics which it does not implement is required to either abstain from that burst type, or to find a different upstream channel (see B.8.1.1). This is also controllable by administrative policy if enough commonality is present to complete the registration process.

As with transmission precoding, a modem-capabilities flag may be needed if the CMTS is to choose least-common-denominator capability.

B.9.1.1.1 Channel burst parameters for advanced modems

Configuration settings for channel burst parameters for advanced modems are given in Table B.9-1.

It should be possible to program these capabilities separately to users on a given channel. For example, two users should be able to be commanded to operate at a given channel frequency and symbol rate, with one user having any or all of these features: 8 PSK TCM, Interleaving, and TH Precoding; while the other user employs QPSK and none of the other features (i.e. this user is not an advanced cable modem).

Table B.9-1/J.112 – Channel burst parameters for advanced modems

Parameter	Configuration settings
Modulation (additional configuration settings)	Trellis Coded Modulation available: 1) 8 PSK-2 bits/s (analogous to QPSK); 2) 32 QAM-4 bits/s (analogous to 16 QAM). 2 encoder configuration settings available for each.
Interleaving N rows by M columns transmitter fills columns	N = 0 to 255; 0 = no interleaving M = 1 to 256
Tomlinson-Harashima Precoding	1) TH Precoding 2) Conventional transmit FIR equalization 3) None

B.9.1.2 Downstream channel improvements

Downstream channel improvements may require additional frequencies to implement for interoperability. The modem initialization process defined herein provides that if the CM is unable to complete satisfactory exchanges with the CMTS, then it will scan for a more suitable frequency (see B.8.1.2).

B.9.2 New network service requirements

The types of network service expected on a cable network are apt to change over the lifetime of equipment conforming to this specification. This specification anticipates use of ATM-style traffic parameters by giving the CMTS centralized control over bandwidth allocation and jitter. Future networks may include classes of data other than those explicitly provided (802-like and ATM). These may be implemented by using the Reserved code point in the MAC FC field. Because this specification does not require a particular bandwidth allocation algorithm, future algorithms may be developed which take into account policies and traffic types that are not yet well-understood.

B.9.2.1 Multicast Service IDs

Multicast Service IDs provide extensibility to the interval usage codes that are defined herein in the upstream bandwidth allocation map. The multicast ID reflects, not just group membership, but also the access rules that apply to whatever interval is assigned to that ID. The following examples of Request/Data IEs illustrate some of the possibilities for use of a particular ID:

- the grant is for contention space for all high-priority (as defined locally) data PDUs from a select group of CMs;
- the grant is for ATM cells only.

It may be necessary to develop an extension to the MAC signalling protocol to distribute the definition of attributes associated with particular multicast Service IDs.

B.9.2.2 RSVP support for upstream traffic

The Resource ReSerVation Protocol (RSVP) is a resource reservation set-up protocol currently being standardized by the Internet Engineering Task Force. RSVP provides receiver-initiated set-up of resource reservations for multicast and unicast data flows. This subclause serves to anticipate and guide the definition of new MAC management messages to support resource reservation for upstream traffic in the Data-over-Cable context.

RSVP assumes the implementation of two modules on each RSVP-capable node to forward data packets: the "packet classifier" and the "packet scheduler". The packet classifier determines the route and class-of-service class for each packet, and sends the packet to the packet scheduler. The RSVP packet classifier uses a "filter spec" (which matches a particular source IP address and TCP/UDP port number) to classify and restrict traffic that consumes reservation resources. The packet scheduler makes packet forwarding decisions (e.g. queuing decisions) to achieve the promised class of service on the interface. The RSVP packet scheduler uses a "flow spec" (which identifies token bucket parameters, peak data rate, etc.) to identify the desired class of service.

In the context of RSVP for upstream traffic in the data-over-cable system, it is desirable for the CM to perform the "packet classifier" function; however the CMTS should perform most of the "packet scheduler" function. The support for this split of functions suggests the future definition of three new MAC management messages: "Dynamic Service Addition", "Dynamic Service Deletion", and "Dynamic Service Response."

The Dynamic Service Addition message is periodically transmitted from the CMTS to the CM to announce the allocation of a new SID. The Dynamic Service Addition message contains the new SID value, and type/length/value fields which can encode the RSVP filter specification and RSVP "clean-up timeout" interval (to support the RSVP "soft state" approach). The CM is expected to use the new SID exclusively for upstream traffic that matches the filter specification. The CM should assume that the new SID is refreshed by the receipt of another Dynamic Service Addition message within the clean-up timeout interval; otherwise, the SID is ignored by the CM at the conclusion of the interval.

The Dynamic Service Deletion message is transmitted from the CMTS to the CM to delete an unused SID immediately (to support the RSVP explicit "teardown" message). The Dynamic Service Response message is transmitted from the CM to the CMTS to acknowledge receipt of a Dynamic Service Addition or Dynamic Service Deletion message.

The interaction between RSVP "Path" and "Resv" messages, and the Dynamic Service Addition and Dynamic Service Response messages, is proposed to be as follows:

- 1) The data flow source-node (behind a CM) generates an RSVP Path message, and sends the message toward the data flow destination-node.
- 2) The CM forwards the upstream RSVP Path message to the destination-node without processing.
- 3) The CMTS intercepts the upstream RSVP Path message, stores "path state" from the message, updates the "previous hop address" in the message, and forwards the message.
- 4) The data flow destination-node receives the RSVP Path message, and replies with an RSVP Resv message to request a reservation of resources for the data flow from the source-node to itself. The RSVP Resv message is sent to the "previous hop" of the Path message – the CMTS.

- 5) The CMTS receives the downstream RSVP Resv message, and processes the message flow spec using its "admission control" and "policy control" modules (in cooperation with the CMTS upstream bandwidth scheduler). Note that the CMTS must account for available resources on the CMTS-NSI as well as the RFI. The rest of this subclause assumes that the reservation message is accepted by the CMTS.
- 6) The CMTS sends the "Dynamic Service Addition" MAC message to the CM. The message includes a new SID and the "filter spec" from the RSVP Resv message.
- 7) The CM receives the "Dynamic Service Addition" MAC message, stores the new SID and "filter spec", and sends the "Dynamic Service Response" MAC message to the CMTS.
- 8) The CMTS receives the "Dynamic Service Response" MAC message, and forwards the RSVP Resv message to its "previous hop."
- 9) The CM forwards the downstream RSVP Resv message to the source-node without processing.

B.9.3 PID filtering capability

This specification uses a single well-known PID for all data-over-cable traffic. CMs MAY use additional PIDs for differentiation of traffic types or to provide streams to individual CMs. PID assignments MAY be facilitated by the appropriate MAC control message extensions. As an example, this could facilitate services that use MPEG packet-level encryption. Any such services are beyond the scope of this version of the specification.

An additional modem capability configuration setting could be added in the Registration Request (REG-REQ) message to indicate the number of PIDs, in addition to the well-known PID, that the CM can filter. A "0" would indicate that the CM can only filter on the well-known PID.

An extension to the encodings in the Registration Response (REG-RSP) could be used to assign to a CM additional PIDs on which to filter.

Appendix B.I

Well-Known Addresses

B.I.1 MAC addresses

MAC addresses described here are defined using the Ethernet/ISO IEC 8802-3 convention as bit-little-indian.

The following multicast address **MUST** be used to address the set of all CM MAC sublayers; for example, when transmitting Allocation Map PDUs.

01-E0-2F-00-00-01

The following multicast address **MUST** be used to address all CMTSs within the MAC-sublayer domain:

01-E0-2F-00-00-02

Note that in nearly all cases the unicast CMTS address is preferred. The address range:

01-E0-2F-00-00-03 through 01-E0-2F-00-00-0F

is reserved for future definition. Frames addressed to any of these addresses **SHOULD NOT** be forwarded out of the MAC-sublayer domain.

B.I.2 MAC Service IDs

The following MAC Service IDs have assigned meanings. Those not included in this table are available for assignment, either by the CMTS or administratively.

- 0x0000 Addressed to no CM.
- 0x3FFF Addressed to all CMs.
- 0x3FF1-0x3FFE Addressed to all CMs. Available for small data PDUs, as well as requests (used only with request/data IEs). The last digit indicates the frame length and transmission opportunities as follows.
- 0x3FF1 Within the interval specified, a transmission may start at any mini-slot, and must fit within one mini-slot.
- 0x3FF2 Within the interval specified, a transmission may start at every other mini-slot, and must fit within two mini-slots (e.g. a station may start transmission on the first mini-slot within the interval, the third mini-slot, the fifth, etc.).
- 0x3FF3 Within the interval specified, a transmission may start at any third mini-slot, and must fit within three mini-slots (e.g. starts at first, fourth, seventh, etc.).
- 0x3FF4 Starts at first, fifth, ninth, etc.
- ...
- 0x3FFD Starts at first, fourteenth (14th), twenty-seventh (27th), etc.
- 0x3FFE Within the interval specified, a transmission may start at any 14th mini-slot, and must fit within 14 mini-slots.

B.I.3 MPEG PID

All MCNS data **MUST** be carried in MPEG-2 packets with the header PID field set to 0x1FFE.

Appendix B.II

Parameters and constants

System	Name	Time reference	Minimum value	Default value	Maximum value
CMTS	Sync Interval	Nominal time between transmission of SYNC messages (B.6.3.2.1)			200 ms
CMTS	UCD Interval	Time between transmission of UCD messages_ (B.6.3.2.2)			2 s
CMTS	Max MAP Pending	The number of mini-slots that a CMTS is allowed to map into the future (B.6.3.2.3)			4096 mini-slot times
CMTS	Ranging Interval	Time between transmission of broadcast Ranging Requests (B.6.3.2.4)			2 s
CM	Lost Sync Interval	Time since last received Sync message before synchronization is considered lost			600 ms
CM	Contention Ranging Retries	Number of Retries on contention Ranging Requests (B.7.2.5)		16	
CM, CMTS	Invited Ranging Retries	Number of Retries on inviting Ranging Requests_ (B.7.2.5)		16	
CM	Request Retries	Number of retries on bandwidth allocation requests		16	
CM	Registration Request Retries	Number of retries on registration requests		3	
CM	Data Retries	Number of retries on immediate data transmission		16	
CMTS	CM MAP processing time	Time provided between arrival of the last bit of a MAP at a CM and effectiveness of that MAP (B.6.4.1)	200 μ s		
CMTS	CM Ranging Response processing time	Minimum time allowed for a CM following receipt of a ranging response before it is expected to reply to an invited Ranging Request	1 ms		
CM	T1	Wait for UCD timeout.			5 * UCD interval maximum value
CM	T2	Wait for broadcast ranging timeout.			5 * ranging interval
CM	T3	Wait for Ranging Response.	50 ms	200 ms	200 ms
CM	T4	Wait for unicast ranging opportunity. If the pending-till-complete field was used earlier by this modem, then the value of that field must be added to this interval.			30 s
CMTS	T5	Wait for Upstream Channel Change response.			2 s
CM	T6	Wait for registration response.			3 s
CM CMTS	Mini-slot size	Size of mini-slot for upstream transmission. Must be a power of 2 (in units of the Timebase Tick).	32 symbol times		
CM CMTS	Timebase Tick	System timing unit		6.25 μ s	

Appendix B.III

CM configuration interface specification

B.III.1 DHCP fields used by the CM

The following fields are required in the DHCP request from the CM:

- the hardware type SHOULD be set to Ethernet;
- the hardware address of the CM (used as the key to identify the CM during the DHCP process).

The following fields are required in the DHCP response returned to the CM:

- The IP address to be used by the CM.
- The subnet mask to be used by the CM.
- If the DHCP server is on a different network (requiring a relay agent), then the relay agent MUST set the gateway address field of the DHCP response.
- The name of the CM configuration file to be read from the TFTP server by the CM.
- The time offset of the CM from Universal Coordinated Time (UTC) – Used by the CM to calculate the local time to use in time-stamping error logs.
- Time-server option – Provides a list of [RFC-868] time-servers from which the current time may be obtained.
- The IP address of the next server to use in the bootstrap process (TFTP server) is returned in the siaddr field.
- The IP address of the security server SHOULD be set if security is required. This is encoded using the code 128 (which is reserved for site specific information per reference [RFC-1533]) as shown below.

Type	Length	Value
128	4	ip1,ip2,ip3,ip4

B.III.2 CM binary configuration file format

The CM-specific configuration data MUST be contained in a file which is downloaded to the CM via TFTP. This is a binary file in the same format defined for DHCP vendor extension data [RFC-1533].

It MUST consist of a number of configuration settings (1 per parameter) each of the form:

type : length : valeur

where:

- type is a single-octet identifier which defines the parameter;
- length is a single octet containing the length of the value field in octets (not including type and length fields);
- value is from one to 254 octets containing the specific value for the parameter.

The configuration settings MUST follow each other directly in the file, which is a stream of octets (no record markers).

Configuration settings are divided into three types:

- Standard configuration settings which MUST be present;
- Standard configuration settings which MAY be present;
- Vendor-specific configuration settings.

CMs MUST be capable of processing all standard configuration settings.

Authentication of the provisioning information is provided by two Message Integrity Check (MIC) configuration settings, CM MIC and CMTS MIC:

- CM MIC is a digest which ensures that the data sent from the provisioning server were not modified en route. This is NOT an authenticated digest (it does not include any shared secret).
- CMTS MIC is a digest used to authenticate the provisioning server to the CMTS during registration. It is taken over a number of fields one of which is a shared secret between the CMTS and the provisioning server.

Use of the CM MIC allows the CMTS to authenticate the provisioning data without needing to receive the entire file.

Thus the file structure is of the form shown in Figure B.III-1:

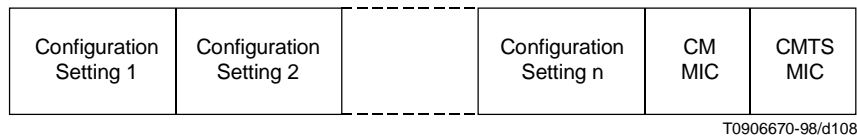

NOTE – Not all configuration settings need to be present in a given file.

Figure B.III-1/J.112 – Binary configuration file format

B.III.3 Configuration file settings

The following configuration settings MUST be included in the configuration file and MUST be supported by all CMs:

- Network Access Configuration Setting;
- End Configuration Setting.

The following configuration settings MAY be included in the configuration file and if present MUST be supported by all CMs:

- Downstream Frequency Configuration Setting;
- Upstream Channel ID Configuration Setting;
- Class of Service Configuration Setting;
- Vendor ID Configuration Setting;
- Baseline Privacy Configuration Setting;
- Software Upgrade Filename Configuration Setting;
- SNMP Write-Access Control;
- SNMP MIB Object;
- Pad Configuration Setting.

The following configuration setting MAY be included in the configuration file and if present MAY be supported by a CM:

- Vendor-Specific Configuration Settings

B.III.4 Configuration file creation

The sequence of operations required to create the configuration file is as shown in Figure B.III-1 through Figure B.III-5.

- 1) Create the type/length/value entries for all the parameters required by the CM.

type, length, value for parameter 1
type, length, value for parameter 2
...
type, length, value for parameter n

Figure B.III-2/J.112 – Create TLV entries for parameters required by the CM

- 2) Calculate the CM Message Integrity Check (MIC) configuration setting as defined in B.III.5 and add to the file following the last parameter using code and length values defined for this field.

type, length, value for parameter 1
type, length, value for parameter 2
...
type, length, value for parameter n
type, length, value for CM MIC

Figure B.III-3/J.112 – Add CM MIC

- 3) Calculate the CMTS Message Integrity Check (MIC) configuration setting as defined in B.III.6 and add to the file following the CM MIC using code and length values defined for this field.

type, length, value for parameter 1
type, length, value for parameter 2
...
type, length, value for parameter n
type, length, value for CM MIC
type, length, value for CMTS MIC

Figure B.III-4/J.112 – Add CMTS MIC

- 4) Add the end of data marker.

type, length, value for parameter 1
type, length, value for parameter 2
...
type, length, value for parameter n
type, length, value for CM MIC
type, length, value for CMTS MIC
end of data marker

Figure B.III-5/J.112 – Add end of data marker

B.III.5 CM MIC calculation

The CM message integrity check configuration setting **MUST** be calculated by performing an MD5 digest over the bytes of the configuration setting field. It is calculated over the bytes of these settings as they appear in the TFTPed image, without regard to TLV ordering or contents. There are two exceptions to this disregard of the contents of the TFTPed image:

- 1) The bytes of the CM MIC TLV itself are omitted from the calculation. This includes the type, length, and value fields.
- 2) The bytes of the CMTS MIC TLV are omitted from the calculation. This includes the type, length, and value fields.

On receipt of a configuration file, the CM **MUST** recompute the digest and compare it to the CM MIC configuration setting in the file. If the digests do not match, then the configuration file **MUST** be discarded.

B.III.6 CMTS MIC calculation

The CMTS message integrity check configuration setting **MUST** be calculated by performing an MD5 digest over the following configuration setting fields, when present in the configuration file, in the order shown:

- Downstream Frequency Configuration Setting;
- Upstream Channel ID Configuration Setting;
- Network Access Configuration Setting;
- Class of Service Configuration Setting;
- Vendor ID Configuration Setting;
- Baseline Privacy Configuration Setting;
- Vendor specific Configuration Settings;
- CM MIC Configuration Setting;
- Authentication string.

The configuration setting fields are treated as if they were contiguous data when calculating the MD5 digest.

The digest **MUST** be added to the configuration file as its own configuration setting field using the CMTS MIC Configuration Setting encoding.

The authentication string is a shared secret between the provisioning server (which creates the configuration files) and the CMTS. It allows the CMTS to authenticate the CM provisioning.

The mechanism by which the shared secret is managed is up to the system operator.

On receipt of a configuration file, the CM **MUST** forward the CMTS MIC as part of the registration request (REG-REQ).

On receipt of a REG-REQ, the CMTS **MUST** recompute the digest over the included fields and the authentication string and compare it to the CMTS MIC configuration setting in the file. If the digests do not match, the registration request **MUST** be rejected by setting the authentication failure result in the registration response status field.

B.III.6.1 Digest calculation

The digest fields **MUST** be calculated using the mechanism defined in [RFC-2104].

B.III.7 Registration configuration settings

The following configuration settings are used in the registration messages. Refer to B.6.3.2 for details on these messages.

Registration Request

- Downstream Frequency Configuration Setting;
- Upstream Channel ID Configuration Setting;
- Network Access Configuration Setting;

- Class of Service Configuration Setting;
- Modem Capabilities Configuration Setting;
- Vendor ID Configuration Setting;
- Baseline Privacy Configuration Setting;
- Vendor specific extensions;
- CM MIC;
- CMTS MIC;
- Modem IP address.

Registration Response

- Class of Service Configuration Setting;
- Modem Capabilities Configuration Setting;
- Vendor ID Configuration Setting;
- Vendor-Specific extensions.

B.III.8 Encodings

The following type/length/value encodings **MUST** be used in both the configuration file and in CM registration requests and CMTS responses. All multi-octet quantities are in network-byte order, i.e. the octet containing the most-significant bits is the first transmitted on the wire.

The following configuration settings **MUST** be supported by all CMs which are compliant with this specification.

B.III.8.1 End-of-data marker

This is a special marker for end of data.

It has no length or value fields:

```
type
255
```

B.III.8.2 Pad configuration setting

This has no length or value fields and is only used following the end of data marker to pad the file to an integral number of 32-bit words.

```
type
0
```

B.III.8.3 Downstream frequency configuration setting

The receive frequency to be used by the CM. It is an override for the channel selected during scanning. This is the center frequency of the downstream channel in Hz stored as a 32-bit binary number.

Type	Length	rx frequency
1	4	rx1 rx2 rx3 rx4

Valid range

The receive frequency **MUST** be a multiple of 62 500 Hz.

B.III.8.4 Upstream channel ID configuration setting

The upstream channel ID which the CM MUST use. The CM MUST listen on the defined downstream channel until an upstream channel description message with this ID is found. It is an override for the channel selected during initialization.

Type	Length	Value
2	1	channel ID

B.III.8.5 Network Access Control Object

If the value field is a 1 this CM is allowed access to the network; if a 0 it is not.

Type	Length	On/Off
3	1	1 or 0

B.III.8.6 Class of Service Configuration Setting

This field defines the parameters associated with a class of service. It is somewhat complex in that it is composed from a number of encapsulated type/length/value fields. The encapsulated fields define the particular class of service parameters for the class of service in question. Note that the type fields defined are only valid within the encapsulated class of service configuration setting string. A single class of service configuration setting is used to define the parameters for a single service class. Multiple class definitions use multiple class of service configuration setting sets.

Type	Length	Value
4	n	

B.III.8.6.1 Internal class of service encodings

B.III.8.6.1.1 Class ID

The value of the field specifies the identifier for the class of service to which the encapsulated string applies.

Type	Length	Value
1	1	

Valid range

The class ID MUST be in the range 1 to 16.

B.III.8.6.1.2 Maximum downstream rate configuration setting

The value of the field specifies the maximum data rate in bit/s allowed from this service class on the downstream path. That is, it is the peak data rate for Packet PDU data (including destination MAC address and the CRC) over a one-second interval. This is a limit on the modem, not a guarantee that this rate is available

Type	Length	Value
2	4	

B.III.8.6.1.3 Maximum upstream rate configuration setting

The value of the field specifies the maximum data rate in bit/s allowed from this service class on the upstream channel. That is, it is the peak data rate for Packet PDU data (including destination MAC address and the CRC) over a one-second interval. This is a limit on the modem, not a guarantee that this rate is available.

Type	Length	Value
3	4	

B.III.8.6.1.4 Upstream channel priority configuration setting

The value of the field specifies the relative priority assigned to this service class for data transmission in the upstream channel. Higher numbers indicate higher priority.

Type	Length	Value
4	1	

Valid range

0 → 7

B.III.8.6.1.5 Guaranteed minimum upstream channel data rate configuration setting

The value of the field specifies the data rate in bit/s which will be guaranteed to this service class on the upstream channel.

Type	Length	Value
5	4	

B.III.8.6.1.6 Maximum upstream channel transmit burst configuration setting

The value of the field specifies the maximum transmit burst (in units of mini-slots) which this service class is allowed on the upstream channel.

Type	Length	Value
6	2	255

Valid range

0 → 255 for initial version.

NOTE – The 2-byte length field is retained to support possible future expansion of allowed burst sizes.

B.III.8.6.1.7 Class of service privacy enable

This configuration setting enables/disables Baseline Privacy on a provisioned COS. See [MCNS8].

Type	Length	Enable/Disable
7 (= CoS_BP_ENABLE)	1	1 or 0

Table B.III-1/J.112 – Sample Class of Service Encoding

Type	Length	Value (sub)type	Length	Value	
4	28	1	1	1	Class of service configuration setting
		2	4	10 000 000	Service class 1
		3	4	2 000 000	Max. forward rate of 10 Mbit/s
		4	1	5	Max. return rate of 2 Mbit/s
		5	4	64 000	Return path priority of 5
		6	2	100	Min. guaranteed 64 kb/s
4	28	1	1	2	Max. transmission burst of 100 mini-slots
		2	4	5 000 000	Class of service configuration setting
		3	4	1 000 000	Service class 2
		4	1	3	Max. forward rate of 5 Mbit/s
		5	4	32 000	Max. return rate of 1 Mbit/s
		6	2	50	Return path priority of 3
					Min. guaranteed 32 kb/s
					Max. transmission burst of 50 mini-slots

B.III.8.7 Modem capabilities configuration setting

The value field describes the capabilities of a particular modem, i.e. those OPTIONAL features which the modem can support. It is composed from a number of encapsulated type/length/value fields. The encapsulated fields define the specific capabilities for the modem in question. Note that the type fields defined are only valid within the encapsulated capabilities configuration setting string.

Type	Length	Value
5	n	

The set of possible encapsulated fields is described below.

B.III.8.7.1 Concatenation support

If the value field is a 1, this modem can support concatenation; if a 0 it cannot.

Type	Length	On/Off
1	1	1 or 0

Table B.III-2/J.112 – Sample capability encoding

Type	Length	Value (sub)type	Length	Value	
5		1	1	1	Modem capability configuration setting concatenation supported

B.III.8.8 CM Message Integrity Check (MIC) configuration setting

The value field contains the CM message integrity check code. This is used to detect unauthorized modification or corruption of the configuration file.

Type	Length	Value
6	16	d1 d2 ... d16

B.III.8.9 CMTS Message Integrity Check (MIC) configuration setting

The value field contains the CMTS message integrity check code. This is used to detect unauthorized modification or corruption of the configuration file.

Type	Length	Value
7	16	d1 d2 ... d16

B.III.8.10 Vendor ID configuration setting

The value field contains the vendor identification specified by the three-byte vendor-specific Organization Unique Identifier of the CM MAC address.

Type	Length	Value
8	3	v1, v2, v3

B.III.8.11 Software upgrade filename

The filename of the software upgrade file for the CM. This is a filename only, not a complete path. The file should reside in the TFTP public directory.

Type	Length	Value
9	n	Filename

NOTE – Filename length MUST be less than or equal to 64 bytes.

B.III.8.12 SNMP write-access control

This object makes it possible to disable SNMP "Set" access to individual MIB objects. Each instance of this object controls access to all of the writable MIB objects whose Object ID (OID) prefix matches. This object may be repeated to disable access to any number of MIB objects.

Type	Length	Value
10	n	OID prefix plus control flag

where n is the size of the ASN.1 Basic Encoding Rules [ISO/IEC 8825] encoding of the OID prefix plus one byte for the control flag.

The control flag may take values:

- 0 Allow write-access
- 1 Disallow write-access

Any OID prefix may be used. The Null OID 0.0 may be used to control access to all MIB objects. (The OID 1.3.6.1 will have the same effect.)

When multiple instances of this object are present and overlap, the longest (most specific) prefix has precedence. Thus, one example might be:

- someTable Disallow write-access
- someTable.1.3 Allow write-access

This example disallows access to all objects in someTable except for someTable.1.3.

B.III.8.13 SNMP MIB object

This object allows arbitrary SNMP MIB objects to be set via the TFTP-Registration process.

Type	Length	Value
11	n	Variable binding

where the value is an SNMP VarBind as defined in [RFC-1157]. The VarBind is encoded in ASN.1 Basic Encoding Rules, just as it would be if part of an SNMP Set request.

The cable modem MUST treat this object as if it were part of an SNMP Set Request with the following caveats:

- It MUST treat the request as fully authorized (it cannot refuse the request for lack of privilege).
- SNMP Write-Control provisions (see previous subclause) do not apply.
- No SNMP response is generated by the CM.

This object MAY be repeated with different VarBinds to "Set" a number of MIB objects. All such Sets MUST be treated as if simultaneous.

Each VarBind MUST be limited to 255 bytes.

B.III.8.14 Vendor-specific information

Vendor-specific information for cable modems, if present, MUST be encoded in the configuration file using the vendor-specific information code (43) following the rules defined in [RFC-1533]. The vendor identifier field MUST be present if this configuration setting is used. This configuration setting MAY appear multiple times.

Type	Length	Value
43	n	Per vendor definition

B.III.8.15 Modem IP address

This object informs the CMTS of the provisioned IP address of the cable modem.

Type	Length	Value
12	4	IP address

This object appears only in the Registration Request message.

This address plays no part in the protocols defined in this specification, but is included to assist with network management.

B.III.8.16 Service(s) not available response

This configuration setting MUST be included in the Registration Response message if the CMTS is unable or unwilling to grant any of the requested classes of service that appeared in the Registration Request. Although the value applies only to the failed service class, the entire Registration Request MUST be considered to have failed (none of the class-of-service configuration settings are granted).

Type	Length	Value
13	3	Class ID, type, reason

where:

- class ID is the class-of-service class from the request which is not available;
- type is the specific class-of-service object within the class which caused the request to be rejected;

- reason is the reason for the rejection from the following:
 - reason-other(1);
 - reason-unrecognized-configuration-setting(2);
 - reason-temporary(3);
 - reason-permanent(4).

The reason codes MUST be used in the following way:

- Reason-other(1) is used when none of the other reason codes apply:
- Reason-unrecognized-configuration-setting(2) is used when a class-of-service type is not recognized or when its value is outside of the specified range.
- Reason-temporary(3) indicates that the current loading of service IDs or traffic policies at the CMTS prevents granting the request, but that the request might succeed at another time.
- Reason-permanent(4) indicates that, for policy, configuration, or CMTS capabilities reasons, the request would never be granted unless the CMTS were manually reconfigured or replaced.

B.III.8.17 CPE Ethernet MAC address

This object configures the CM with the Ethernet MAC address of a CPE device (see B.3.1.2.3.1). This object may be repeated to configure any number of CPE device addresses.

Type	Length	Value
14	6	Ethernet MAC address of CPE

This object appears only in the configuration file.

B.III.8.18 Telephone settings option

This configuration setting describes parameters which are specific to telephone return systems. It is composed from a number of encapsulated type/length/value fields. See [MCNS6].

Type	Length	Value
15 (= TRI_CFG01)	n	

B.III.8.19 SNMP IP address

This is the IP address of the SNMP Manager. The CM uses this address to report a problem with the cable network.

Type	Length	Value
16 (= TRI_CFG02)	4	IntegerIPAddress

B.III.8.20 Baseline Privacy configuration settings option

This configuration setting describes parameters which are specific to Baseline Privacy. It is composed from a number of encapsulated type/length/value fields. See [MCNS8].

Type	Length	Value
17 (= BP_CFG)	n	

Appendix B.IV

MAC sublayer service definition

The MAC sublayer will provide the following services, consistent with [ISO/IEC 15802-1]. This is an internal interface within the CM and CMTS and is provided for reference purposes only.

B.IV.1 Service at the CM

The following service primitives are provided by the MAC sublayer to the higher-layer protocol entity. These represent an abstraction of the service provided and do not imply a particular implementation:

MAC_CM_802_DATA.request
MAC_CM_DIX_DATA.request
MAC_CM_ATM_DATA.request
MAC_CM_802_DATA.indication
MAC_CM_DIX_DATA.indication
MAC_CM_ATM_DATA.indication
MAC_CM_DATA.acknowledgment

B.IV.2 MAC_CM_802_DATA.request

Issued by the higher-layer to request transmission from the CM on an upstream channel. Parameter:

- channel_ID - MAY be implicit if the device supports attachment to a single channel.
- service_ID.
- contention_and_acknowledgment_constraints – Specifies whether or not this request MAY be satisfied in a contention interval. Ordinarily, the CM will request that contention data be acknowledged by the CMTS.
- destination_address.
- source_address (OPTIONAL) – If not explicitly overwritten, the address at this MSAP is used.
- LLC_pdu.
- Padding (OPTIONAL) – MAY be used if the LLC PDU is less than 60 bytes and it is desired to maintain ISO 8802-3 transparency.
- frame_check_sequence (OPTIONAL) – MAY be supplied if ISO 8802-3 transparency is desired. Otherwise, a 32-bit CRC sum is calculated by the MAC sublayer.
- Length.

B.IV.3 MAC_CM_DIX_DATA.request

Issued by the higher-layer to request transmission from the CM on an upstream channel. Parameters:

- channel_ID – MAY be implicit if the device supports attachment to a single channel.
- service_ID.
- contention_and_acknowledgment_constraints – Specifies whether or not this request MAY be satisfied in a contention interval. Ordinarily, the CM will request that contention data be acknowledged by the CMTS.
- destination_address.
- source_address (OPTIONAL) – If not explicitly overwritten, the address at this MSAP is used.
- Ethernet type.
- ethernet_dix_pdu.
- Length.

B.IV.4 MAC_CM_ATM_DATA.request

Issued by the higher-layer to request transmission from the CM on an upstream channel. Parameters:

- channel_ID – MAY be implicit if the device supports attachment to a single channel.
- service_ID.
- contention_and_acknowledgment_constraints – Specifies whether or not this request MAY be satisfied in a contention interval. Ordinarily, the CM will request that contention data be acknowledged by the CMTS.
- One or more ATM cells. Cells need not be within the same virtual circuit or virtual path.
- Length.

B.IV.5 MAC_CM_802_DATA.indication

Issued by the CM MAC to indicate reception of data from the downstream channel. Parameters:

- channel_ID – MAY be implicit if the device supports attachment to a single channel.
- destination_address.
- source_address.
- LLC_pdu.
- Padding (OPTIONAL) - MAY be present if the LLC PDU was less than 60 bytes and ISO 8802-3 transparency was desired.
- frame_check_sequence.
- Length.

B.IV.6 MAC_CM_DIX_DATA.indication

Issued by the CM MAC to indicate reception of data from the downstream channel. Parameters:

- channel_ID – MAY be implicit if the device supports attachment to a single channel.
- destination_address.
- source_address.
- Ethernet type.
- ethernet_dix_pdu.
- frame_check_sequence.
- Length.

B.IV.7 MAC_CM_ATM_DATA.indication

Issued by the CM MAC to indicate reception of data on the downstream channel. Parameters:

- channel_ID – MAY be implicit if the device supports attachment to a single channel.
- service_ID.
- One or more ATM cells – Cells need not be within the same virtual circuit or virtual path.
- Length.

B.IV.8 MAC_CM_DATA.acknowledgment

Issued by the CM MAC to indicate reception of an acknowledgment on the downstream channel. (An acknowledgment is an information element in an MAP PDU (see B.6.4.1.1). The CMTS MUST include this IE in response to an upstream data transmission that includes an acknowledgment request.) Parameters:

- channel_ID – The downstream channel on which the acknowledgment was received. May be implicit if the device supports attachment to a single channel.
- service_ID.
- Length.

Appendix B.V

Example Burst Profiles

B.V.1 Introduction

Table B.V-1 through Table B.V-4 contain example Channel Burst Profiles for various modulation format and symbol rate combinations. The column labeled Column #1 in Table B.V-1 through Table B.V-4 corresponds to the Request burst type. The other columns correspond to the Communication (or Data) burst type. Table B.V-5 contains example Channel Burst Profiles corresponding to Power-Up burst types, or Acquisition burst types (for use on a new channel – or simply for refinement of user-unique parameters).

A burst length of 0 mini-slots in the Channel Profile means that the burst length is variable on that channel for that burst type, and will be assigned by the CMTS for each burst.

A programmable preamble superstring, up to 1024-bits-long, is part of the channel-wide profile or attributes, common to the all burst profiles on the channel (see B.6.3.2.2 and Table B.6-14), but with each burst profile able to specify the start location within this sequence of bits and the length of the preamble (see B.6.3.2.2 and Table B.6-15). The first bit of the Preamble Pattern is designated by the Preamble Value Offset as described in Table B.6-15 and B.6.3.2.2. The first bit of the Preamble Pattern is the first bit into the symbol mapper (see Figure B.4-8), and is I_1 in the first symbol of the burst (see B.4.2.2.2). As an example, per Table B.6-15, for Preamble Offset Value = 100, the 101st bit of the preamble superstring is the first bit into the symbol mapper, and the 102nd bit is the second bit into the mapper, and is mapped to Q1, and so on. An example 1024-bit-long preamble superstring is given in B.V.2.

Table B.V-6 contains the frame formats for each of the symbol rates with QPSK modulation for the example Request burst and for three code-word lengths for the Communication bursts, with one code word per burst. Additionally, frame formats are shown for each of the rates with two of the example code-word lengths with four code words per burst. In each format example, the information rate of the burst is calculated and given in the table. For the Request burst, the 6 bytes of "data" are assumed to be the information, and the rest is overhead. In the Communication bursts, the preamble, spacing (guard time), FEC parity, and the example 6 bytes of MAC Header are assumed overhead for the purposes of calculating information rate.

Table B.V-7 is structured the same as Table B.V-6, but with the example formats for 16 QAM modulation.

B.V.2 Example preamble sequence

The following is the example 1024-bit preamble sequence for Table B.V-1 through Table B.V-5:

Bits 1 through 128:

```
1100 1100 1111 0000 1111 1111 1100 0000 1111 0011 1111 0011 0011 0000 0000 1100
0011 0000 0011 1111 1111 1100 1100 1100 1111 0000 1111 0011 1111 0011 1100 1100
```

Bits 129 through 256:

```
0011 0000 1111 1100 0000 1100 1111 1111 0000 1100 1100 0000 1111 0000 0000 1100
0000 0000 1111 1111 1111 0011 0011 0011 1100 0011 1100 1111 1100 1111 0011 0000
```

Bits 257 through 384:

```
1100 0011 1111 0000 0011 0011 1111 1100 0011 0011 0000 0011 1100 0000 0011 0000
0000 1110 1101 0001 0001 1110 1110 0101 0010 0101 0010 0101 1110 1110 0010 1110
```

Bits 385 through 512:

```
0010 1110 1110 0010 0010 1110 1110 1110 1110 1110 0010 0010 0010 1110 1110 0010
1110 1110 1110 0010 1110 0010 1110 0010 0010 0010 0010 1110 0010 0010 1110 0010
```

Bits 513 through 640:

```
0010 0010 1110 1110 1110 1110 1110 1110 0010 1110 0010 1110 0010 1110 1110 0010
0010 1110 1110 0010 1110 1110 1110 0010 1110 1110 0010 1110 0010 0010 1110 0010
```

Bits 641 through 768:

0010 1110 1110 1110 0010 0010 0010 1110 0010 1110 1110 1110 1110 0010 0010 1110
 0010 1110 0010 0010 0010 1110 1110 0010 0010 0010 0010 1110 0010 0010 0010 0010

Bits 769 through 896:

0010 1110 1110 1110 1110 1110 1110 0010 1110 0010 1110 0010 1110 1110 0010 0010
 1110 1110 0010 1110 1110 1110 0010 1110 1110 0010 1110 0010 0010 1110 0010 0010

Bits 897 through 1024:

1110 1110 1110 0010 0010 0010 1110 0010 1110 1110 1110 1110 0010 0010 1110 0010
 1110 0010 0010 0010 1110 1110 0010 0010 0010 0010 1110 0010 0010 0010 0010 1110

B.V.3 Example Burst Profiles

See Tables B.V-1 to B.V-7.

Table B.V-1/J.112 – Example Channel Burst parameter values for QPSK operation at 160, 320, and 640 ksym/s

Parameter	Config. settings	#1	#2	#3	#4	#5
Modulation	QPSK, 16 QAM	QPSK	QPSK	QPSK	QPSK	QPSK
Diff Enc	On/Off	Off	Off	Off	Off	Off
Symbol Rate	5 configuration settings	160, 320 or 640 ksym/s	160, 320 or 640 ksym/s	160, 320 or 640 ksym/s	160, 320 or 640 ksym/s	160, 320 or 640 ksym/s
Preamble Length	0, 4-1024 bits	56 bits	64 bits	64 bits	64 bits	64 bits
Preamble Start Location	1024 configuration settings	15	7	7	7	7
Preamble Values	1024 programmable bits	c)	c)	c)	c)	c)
FEC On/Off	On/Off	Off	On	On	On	On
FEC Code word Information Bytes (k)	1 to 255	N/A	32	56	64	220
FEC Error Correction (T bytes)	0 to 10	N/A	4	7	8	10
Last Code-word Length	Fixed or Shortened	N/A	Fixed	Fixed	Fixed	Fixed
Scrambler On/Off	On/Off	On	On	On	On	On
Scrambler Seed	15 bits ^{b)}	Default	Default	Default	Default	Default
Burst Length mini-slots ^{a)}	0 to 255	3	0	0	0	0

a) A burst length of 0 mini-slots in the Channel Profile means that the burst length is variable on that channel for that burst type.

b) 15 bits in a 16-bit field.

c) Refer to B.V.2.

Table B.V-2/J.112 – Example Channel Burst parameter values for QPSK operation at 1.28 and 2.56 Msym/s

Parameter	Config. settings	#1	#2	#3	#4	#5
Modulation	QPSK, 16 QAM	QPSK	QPSK	QPSK	QPSK	QPSK
Diff Enc	On/Off	Off	Off	Off	Off	Off
Symbol Rate	5 configuration settings	1.28 or 2.56 Msym/s	1.28 or 2.56 Msym/s	1.28 or 2.56 Msym/s	1.28 or 2.56 Msym/s	1.28 or 2.56 Msym/s
Preamble Length	0,4-1024 bits	48 bits	96 bits	96 bits	96 bits	96 bits
Preamble Start Location	1024 configuration settings	19	125	125	125	125
Preamble Values	1024 programmable bits	c)	c)	c)	c)	c)
FEC On/Off	On/Off	Off	On	On	On	On
FEC Code-word Information Bytes (k)	1 to 255	N/A	40	56	64	220
FEC Error Correction (T bytes)	0 to 10	N/A	4	4	4	10
Last Code-word Length	Fixed or Shortened	N/A	Fixed	Fixed	Fixed	Fixed
Scrambler On/Off	On/Off	On	On	On	On	On
Scrambler Seed	15 bits ^{b)}	Default	Default	Default	Default	Default
Burst Length mini-slots ^{a)}	0 to 255	4	0	0	0	0
<p>a) A burst length of 0 mini-slots in the Channel Profile means that the burst length is variable on that channel for that burst type.</p> <p>b) 15 bits in a 16-bit field.</p> <p>c) Refer to B.V.2.</p>						

**Table B.V-3/J.112 – Example Channel Burst parameter values for
16 QAM operation at 160, 320, and 640 ksym/s**

Parameter	Config. settings	#1	#2	#3	#4	#5
Modulation	QPSK, 16 QAM	16 QAM	16 QAM	16 QAM	16 QAM	16 QAM
Diff Enc	On/Off	Off	Off	Off	Off	Off
Symbol Rate	5 configuration settings	160, 320 or 640 ksym/s	160, 320 or 640 ksym/s	160, 320 or 640 ksym/s	160, 320 or 640 ksym/s	160, 320 or 640 ksym/s
Preamble Length	0, 4-1024 bits	80 bits	128 bits	128 bits	128 bits	128 bits
Preamble Start Location	1024 configuration settings	429	385	385	385	385
Preamble Values	1024 programmable bits	c)	c)	c)	c)	c)
FEC On/Off	On/Off	Off	On	On	On	On
FEC Code-word Information Bytes (k)	1 to 255	N/A	32	56	64	220
FEC Error Correction (T bytes)	0 to 10	N/A	4	7	8	10
Last Code-word Length	Fixed or Shortened	N/A	Fixed	Fixed	Fixed	Fixed
Scrambler On/Off	On/Off	On	On	On	On	On
Scrambler Seed	15 bits ^{b)}	Default	Default	Default	Default	Default
Burst Length mini-slots ^{a)}	0 to 255	2	0	0	0	0
<p>a) A burst length of 0 mini-slots in the Channel Profile means that the burst length is variable on that channel for that burst type.</p> <p>b) 15 bits in a 16-bit field.</p> <p>c) Refer to B.V.2.</p>						

**Table B.V-4/J.112 – Example Channel Burst parameter values for
16 QAM operation at 1.28 and 2.56 Msym/s**

Parameter	Config. settings	#1	#2	#3	#4	#5
Modulation	QPSK, 16 QAM	16 QAM	16 QAM	16 QAM	16 QAM	16 QAM
Diff Enc	On/Off	Off	Off	Off	Off	Off
Symbol Rate	5 configuration settings	1.28 or 2.56 Msym/s	1.28 or 2.56 Msym/s	1.28 or 2.56 Msym/s	1.28 or 2.56 Msym/s	1.28 or 2.56 Msym/s
Preamble Length	0,4-1024 bits	144 bits	192 bits	192 bits	192 bits	192 bits
Preamble Start Location	1024 configuration settings	709	621	621	621	621
Preamble Values	1024 programmable bits	c)	c)	c)	c)	c)
FEC On/Off	On/Off	Off	On	On	On	On
FEC Code-word Information Bytes (k)	1 to 255	N/A	40	56	64	220
FEC Error Correction (T bytes)	0 to 10	N/A	4	4	4	10
Last Code-word Length	Fixed or Shortened	N/A	Fixed	Fixed	Fixed	Fixed
Scrambler On/Off	On/Off	On	On	On	On	On
Scrambler Seed	15 bits ^{b)}	Default	Default	Default	Default	Default
Burst Length mini- slots ^{a)}	0 to 255	4	0	0	0	0
<p>a) A burst length of 0 mini-slots in the Channel Profile means that the burst length is variable on that channel for that burst type.</p> <p>b) 15 bits in a 16-bit field.</p> <p>c) Refer to B.V.2.</p>						

Table B.V-5/J.112 – Example Channel Burst parameter values for power-up and acquisition in a new channel

Parameter	Config. settings	#1	#2	#3	#4
Modulation	QPSK, 16 QAM	QPSK	QPSK	16 QAM	16 QAM
Diff Enc	On/Off	Off	Off	Off	Off
Symbol Rate	5 configuration settings	160, 320 or 640 ksym/s	1.28 or 2.56 Msym/s	160, 320 or 640 ksym/s	1.28 or 2.56 Msym/s
Preamble Length	0,4-1024 bits	1024 bits	1024 bits	1024 bits	1024 bits
Preamble Start Location	1024 configuration settings	1	1	1	1
Preamble Values	1024 programmable bits	c)	c)	c)	c)
FEC On/Off	On/Off	On	On	On	On
FEC Code-word Information Bytes (k)	1 to 255	60	60	60	60
FEC Error Correction (T bytes)	0 to 10	10	10	10	10
Last Code-word Length	Fixed or Shortened	Fixed	Fixed	Fixed	Fixed
Scrambler On/Off	On/Off	On	On	On	On
Scrambler Seed	15 bits ^{b)}	Default	Default	Default	Default
Burst Length mini-slots ^{a)}	0 to 255	42	53	21	27
<p>a) A burst length of 0 mini-slots in the Channel Profile means that the burst length is variable on that channel for that burst type.</p> <p>b) 15 bits in a 16-bit field.</p> <p>c) Refer to B.V.2.</p>					

Table B.V-6/J.112 – Frame format examples with QPSK operation

Parameter	160 ksym/s	320 ksym/s	640 ksym/s	1.28 Msym/s	2.56 Msym/s
Request Burst					
Spacing symbols (bytes) i.e. (guard time symbols –1)	8 (2)	8 (2)	8 (2)	16 (4)	16 (4)
Data symbols (bytes)	24 (6)	24 (6)	24 (6)	24 (6)	24 (6)
Preamble symbols (bytes)	28 (7)	28 (7)	28 (7)	24 (6)	24 (6)
Total symbols (bytes)	60 (15)	60 (15)	60 (15)	64 (16)	64 (16)
Total burst duration (mini-slots)	3	3	3	4	4
Total burst duration (microseconds)	375	187.5	93.75	50	25
Information rate (6 bytes per burst)	128 kbit/s	256 kbit/s	512 kbit/s	960 kbit/s	1.92 Mbit/s
Communication Burst					
Code words/burst	1 ^{a)}	1 ^{a)}	1 ^{a)}	1 ^{a)}	1 ^{a)}
Errors corrected per code word	4	4	4	4	4
Spacing symbols (bytes) i.e. (guard time symbols –1)	8 (2)	8 (2)	8 (2)	16 (4)	16 (4)
Data symbols (bytes)	128 (32)	128 (32)	128 (32)	160 (40)	160 (40)
Parity symbols (bytes)	32 (8)	32 (8)	32 (8)	32 (8)	32 (8)
Preamble symbols (bytes)	32 (8)	32 (8)	32 (8)	48 (12)	48 (12)
Total symbols (bytes)	200 (50)	200 (50)	200 (50)	256 (64)	256 (64)
Total burst duration (mini-slots)	2 + 8 = 10	2 + 8 = 10	2 + 8 = 10	4 + 12 = 16	4 + 12 = 16
Total burst duration (microseconds)	1250	625	312.5	200	100
Information rate (excluding MAC Header)	166.4 kbit/s	332.8 kbit/s	665.6 kbit/s	1.360 Mbit/s	2.720 Mbit/s
Communication Burst					
Code words/burst	1 ^{a)}	1 ^{a)}	1 ^{a)}	1 ^{a)}	1 ^{a)}
Errors corrected per code word	8	8	8	4	4
Spacing symbols (bytes) i.e. (guard time symbols –1)	8 (2)	8 (2)	8 (2)	16 (4)	16 (4)
Data symbols (bytes)	256 (64)	256 (64)	256 (64)	256 (64)	256 (64)
Parity symbols (bytes)	64 (16)	64 (16)	64 (16)	32 (8)	32 (8)
Preamble symbols (bytes)	32 (8)	32 (8)	32 (8)	48 (12)	48 (12)
Total symbols (bytes)	360 (90)	360 (90)	360 (90)	352 (88)	352 (88)
Total burst duration (mini-slots)	2 + 16 = 18	2 + 16 = 18	2 + 16 = 18	4 + 18 = 22	4 + 18 = 22
Total burst duration (microseconds)	2250	1125	562.5	275	137.5
Information rate (excluding MAC Header)	206.2 kbit/s	412.4 kbit/s	824.9 kbit/s	1.687 Mbit/s	3.375 Mbit/s
Communication Burst					
Code words/burst	1 ^{a)}	1 ^{a)}	1 ^{a)}	1 ^{a)}	1 ^{a)}
Errors corrected per code word	10	10	10	10	10

Table B.V-6/J.112 – Frame format examples with QPSK operation (end)

Parameter	160 ksym/s	320 ksym/s	640 ksym/s	1.28 Msym/s	2.56 Msym/s
Spacing symbols (bytes) i.e. (guard time symbols –1)	8 (2)	8 (2)	8 (2)	16 (4)	16 (4)
Data symbols (bytes)	880 (220)	880 (220)	880 (220)	880 (220)	880 (220)
Parity symbols (bytes)	80 (20)	80 (20)	80 (20)	80 (20)	80 (20)
Preamble symbols (bytes)	32 (8)	32 (8)	32 (8)	48 (12)	48 (12)
Total symbols (bytes)	1000 (250)	1000 (250)	1000 (250)	1024 (256)	1024 (256)
Total burst duration (mini-slots)	2 + 48 = 50	2 + 48 = 50	2 + 48 = 50	4 + 60 = 64	4 + 60 = 64
Total burst duration (microseconds)	6250	3125	1562.5	800	400
Information rate (excluding MAC Header)	273.9 kbit/s	547.8 kbit/s	1.096 Mbit/s	2.140 Mbit/s	4.280 Mbit/s
Communication Burst					
Code words/burst	4 ^{a)}	4 ^{a)}	4 ^{a)}	4 ^{a)}	4 ^{a)}
Errors corrected per code word	8	8	8	4	4
Spacing symbols (bytes) i.e. (guard time symbols –1)	8 (2)	8 (2)	8 (2)	16 (4)	16 (4)
Data symbols (bytes)	1024 (256)	1024 (256)	1024 (256)	1024 (256)	1024 (256)
Parity symbols (bytes)	256 (64)	256 (64)	256 (64)	128 (32)	128 (32)
Preamble symbols (bytes)	32 (8)	32 (8)	32 (8)	48 (12)	48 (12)
Total symbols (bytes)	1320 (330)	1320 (330)	1320 (330)	1216 (304)	1216 (304)
Total burst duration (mini-slots)	2 + 16 × 4 = 66	2 + 16 × 4 = 66	2 + 16 × 4 = 66	4 + 18 × 4 = 76	4 + 18 × 4 = 76
Total burst duration (microseconds)	8250	4125	2062.5	950	475
Information rate (excluding MAC Header)	242.4 kbit/s	484.8 kbit/s	969.7 kbit/s	2.105 Mbit/s	4.211 Mbit/s
Communication Burst					
Code words/burst	4 ^{a)}	4 ^{a)}	4 ^{a)}	4 ^{a)}	1 ^{a)}
Errors corrected per code word	10	10	10	10	10
Spacing symbols (bytes) i.e. (guard time symbols –1)	8 (2)	8 (2)	8 (2)	16 (4)	16 (4)
Data symbols (bytes)	3520 (880)	3520 (880)	3520 (880)	3520 (880)	3520 (880)
Parity symbols (bytes)	320 (80)	320 (80)	320 (80)	320 (80)	320 (80)
Preamble symbols (bytes)	32 (8)	32 (8)	32 (8)	48 (12)	48 (12)
Total symbols (bytes)	3880 (970)	3880 (970)	3880 (970)	3904 (976)	3904 (976)
Total burst duration (mini-slots)	2 + 48 × 4 = 194	2 + 48 × 4 = 194	2 + 48 × 4 = 194	4 + 60 × 4 = 244	4 + 60 × 4 = 244
Total burst duration (microseconds)	24 250	12 125	6062.5	3050	1525
Information rate (excluding MAC Header)	288.3 kbit/s	576.7 kbit/s	1.153 Mbit/s	2.292 Mbit/s	4.585 Mbit/s
^{a)} The numbers in the table are given for four code words per burst, but more or fewer code words can be used, with the same data and parity lengths as given in the table.					

Table B.V-7/J.112 – Frame format examples with 16 QAM operation

Parameter	160 ksym/s	320 ksym/s	640 ksym/s	1.28 Msym/s	2.56 Msym/s
Request Burst					
Spacing symbols (bytes) i.e. (guard time symbols –1)	8 (4)	8 (4)	8 (4)	16 (8)	16 (8)
Data symbols (bytes)	12 (6)	12 (6)	12 (6)	12 (6)	12 (6)
Preamble symbols (bytes)	20 (10)	20 (10)	20 (10)	36 (18)	36 (18)
Total symbols (bytes)	40 (20)	40 (20)	40 (20)	64 (32)	64 (32)
Total burst duration (mini-slots)	2	2	2	4	4
Total burst duration (microseconds)	250	125	62.5	50	25
Information rate (6 bytes per burst)	192 kbit/s	384 kbit/s	768 kbit/s	960 kbit/s	1.920 Mbit/s
Communication Burst					
Code words/burst	1 ^{a)}	1 ^{a)}	1 ^{a)}	1 ^{a)}	1 ^{a)}
Errors corrected per code word	4	4	4	4	4
Spacing symbols (bytes) i.e. (guard time symbols –1)	8 (4)	8 (4)	8 (4)	16 (8)	16 (8)
Data symbols (bytes)	64 (32)	64 (32)	64 (32)	80 (40)	80 (40)
Parity symbols (bytes)	16 (8)	16 (8)	16 (8)	16 (8)	16 (8)
Preamble symbols (bytes)	32 (16)	32 (16)	32 (16)	48 (24)	48 (24)
Total symbols (bytes)	120 (60)	120 (60)	120 (60)	160 (80)	160 (80)
Total burst duration (mini-slots)	2 + 4 = 6	2 + 4 = 6	2 + 4 = 6	4 + 6 = 10	4 + 6 = 10
Total burst duration (microseconds)	750	375	187.5	125	62.5
Information rate (excluding MAC Header)	277.3 kbit/s	554.7 kbit/s	1.109 Mbit/s	2.176 Mbit/s	4.352 Mbit/s
Communication Burst					
Code words/burst	1 ^{a)}	1 ^{a)}	1 ^{a)}	1 ^{a)}	1 ^{a)}
Errors corrected per code word	7	7	7	4	4
Spacing symbols (bytes) i.e. (guard time symbols –1)	8 (4)	8 (4)?	8 (4)	16 (8)	16 (8)
Data symbols (bytes)	128 (64)	128 (64)	128 (64)	128 (64)	128 (64)
Parity symbols (bytes)	32 (16)	32 (16)	32 (16)	16 (8)	16 (8)
Preamble symbols (bytes)	32 (16)	32 (16)	32 (16)	48 (24)	48 (24)
Total symbols (bytes)	200 (100)	200 (100)	200 (100)	208 (104)	208 (104)
Total burst duration (mini-slots)	2 + 8 = 10	2 + 8 = 10	2 + 8 = 10	4 + 9 = 13	4 + 9 = 13
Total burst duration (microseconds)	1250	625	312.5	162.5	81.25
Information rate (excluding MAC Header)	371.2 kbit/s	742.4 kbit/s	1.455 Mbit/s	2.855 Mbit/s	5.711 Mbit/s
Communication Burst					
Code words/burst	1 ^{a)}	1 ^{a)}	1 ^{a)}	1 ^{a)}	1 ^{a)}
Errors corrected per code word	10	10	10	10	10

Table B.V-7/J.112 – Frame format examples with 16 QAM operation (end)

Parameter	160 ksym/s	320 ksym/s	640 ksym/s	1.28 Msym/s	2.56 Msym/s
Spacing symbols (bytes) i.e. (guard time symbols –1)	8 (4)	8 (4)	8 (4)	16 (8)	16 (8)
Data symbols (bytes)	440 (220)	440 (220)	440 (220)	440 (220)	440 (220)
Parity symbols (bytes)	40 (20)	40 (20)	40 (20)	40 (20)	40 (20)
Preamble symbols (bytes)	32 (16)	32 (16)	32 (16)	48 (24)	48 (24)
Total symbols (bytes)	520 (260)	520 (260)	520 (260)	544 (272)	544 (272)
Total burst duration (mini-slots)	$2 + 24 = 26$	$2 + 24 = 26$	$2 + 24 = 26$	$4 + 30 = 34$	$4 + 30 = 34$
Total burst duration (microseconds)	3250	1625	812.5	425	212.5
Information rate (excluding MAC Header)	526.8 kbit/s	1.054 Mbit/s	2.107 Mbit/s	4.028 Mbit/s	8.056 Mbit/s
Communication Burst					
Code words/burst	4 ^{a)}	4 ^{a)}	4 ^{a)}	4 ^{a)}	4 ^{a)}
Errors corrected per code word	7	7	7	4	4
Spacing symbols (bytes) i.e. (guard time symbols –1)	8 (4)	8 (4)	8 (4)	16 (8)	16 (8)
Data symbols (bytes)	512 (256)	512 (256)	512 (256)	512 (256)	512 (256)
Parity symbols (bytes)	128 (64)	128 (64)	128 (64)	64 (32)	64 (32)
Preamble symbols (bytes)	32 (16)	32 (16)	32 (16)	48 (24)	48 (24)
Total symbols (bytes)	680 (340)	680 (340)	680 (340)	640 (320)	640 (320)
Total burst duration (mini-slots)	$2 + 8 \times 4 = 34$	$2 + 8 \times 4 = 34$	$2 + 8 \times 4 = 34$	$4 + 9 \times 4 = 40$	$4 + 9 \times 4 = 40$
Total burst duration (microseconds)	4250	2125	1062.5	500	250
Information rate (excluding MAC Header)	470.6 kbit/s	941.2 kbit/s	1.882 Mbit/s	4.000 Mbit/s	8.000 Mbit/s
Communication Burst					
Code words/burst	4 ^{a)}	4 ^{a)}	4 ^{a)}	4 ^{a)}	4 ^{a)}
Errors corrected per code word	10	10	10	10	10
Spacing symbols (bytes) i.e. (guard time symbols –1)	8 (4)	8 (4)	8 (4)	16 (8)	16 (8)
Data symbols (bytes)	1760 (880)	1760 (880)	1760 (880)	1760 (880)	1760 (880)
Parity symbols (bytes)	160 (80)	160 (80)	160 (80)	160 (80)	160 (80)
Preamble symbols (bytes)	32 (16)	32 (16)	32 (16)	48 (24)	48 (24)
Total symbols (bytes)	1960 (980)	1960 (980)	1960 (980)	1984 (992)	1984 (992)
Total burst duration (mini-slots)	$2 + 24 \times 4 = 98$	$2 + 24 \times 4 = 98$	$2 + 24 \times 4 = 98$	$4 + 30 \times 4 = 124$	$4 + 30 \times 4 = 124$
Total burst duration (microseconds)	12 250	6125	3062.5	1550	775
Information rate (excluding MAC Header)	570.8 kbit/s	1.142 Mbit/s	2.283 Mbit/s	4.511 Mbit/s	9.022 Mbit/s
^{a)} The numbers in the table are given for four code words per burst, but more or fewer code words can be used, with the same data and parity lengths as given in the table.					

Appendix B.VI

Upstream modulation rates

B.VI.1 Introduction

The sources of ingress are not randomly distributed throughout the upstream cable network spectrum, but are grouped in frequency bands accordance with the International Radio Regulations, which is an international treaty subscribed to by most countries of the world. In some bands, higher powers are used, so ingress is more likely to be found there. The pattern of allocations can be readily recognized by examination of the upstream cable network band with a spectrum analyzer.

The upstream modulation rates and flexibility in selecting upstream carrier frequencies defined in this appendix permit operators to position carriers in those portions of the upstream cable network spectrum which are less prone to narrowband ingress.

B.VI.2 Sources of narrowband ingress

Radio transmitters in the High-Frequency (HF) portion of the radio spectrum (3 to 30 MHz) are the major sources of narrowband ingress. The transmitters that can affect upstream cable network paths may be local, domestic or in other countries.

B.VI.2.1 HF Propagation

HF propagation is largely influenced by bending of radio waves in the ionosphere, which is a region between about 60 and 200 miles above the earth, so propagation distances can be very large. The bending is caused by ionization of free electrons by ultra-violet rays from the sun. There are several reflecting layers at various heights with differing characteristics, so the maximum usable frequency and distance reached depend on the time of day and solar activity.

Diurnal Variation – During local daytime, the higher frequencies are propagated over long distances and the lower frequencies are absorbed. During local night-time, the lower frequencies are propagated over distances which are not quite so large, and the higher frequencies experience diminished or no propagation.

Solar Cycle – Ionization is at its greatest during the peak of the 11-year sunspot cycle. At the largest sunspot peaks, strong distant signals can be heard across the HF band at most times of the day. At sunspot minima, long-distance propagation can be rare above about 15 MHz. Note that the cycle is currently at a minimum, so ingress is likely to affect cable systems on an increasing basis and at higher frequencies over the next 5 to 6 years.

B.VI.2.2 Users of the HF radio spectrum

The main users of the HF radio spectrum are:

- Broadcasting;
- Maritime mobile;
- Aeronautical mobile;
- Aeronautical navigation;
- Fixed (i.e. point-to-point);
- Standard frequency and time signals;
- Amateur;
- Citizens Band (CB).

The service of greatest concern for ingress is the Broadcasting Service. The Amateur and Citizens Band services are also of concern.

B.VI.2.3 Broadcasting

The main ingress signals seen on typical cable networks are short-wave Broadcasting signals. The Broadcasting service is designed to provide very high field strengths in target markets so that the public can receive clear signals with simple receivers. Thus the service generally has these characteristics:

- amplitude-modulated signals;
- very high transmitter powers;
- high-gain, directive antenna arrays;
- simultaneous transmission on multiple frequencies in different parts of the HF spectrum, to combat HF propagation variability;
- very large field strengths over a wide geographic area, affecting entire cable systems.

The frequencies allocated to the Broadcasting Service on a world-wide basis are shown in Table B.VI-1.

Table B.VI-1/J.112 – Broadcasting allocations between 5 and 42 MHz

Frequency, kHz	
From	To
5 950	6 200
7 100	7 300
9 500	9 900
11 650	12 050
13 600	13 800
15 100	15 600
17 550	17 900
21 450	21 850
25 670	26 100
NOTE – Although 7100-7300 kHz is not allocated to Broadcasting in ITU Region 2 (the Americas), strong signals reach the USA and Canada from the other ITU Regions.	

B.VI.2.4 Amateur and CB

The Amateur Service is of concern, but for different reasons. Amateur transmitters operate at far lower powers than the Broadcasting Service, but are located in residential neighborhoods close to the cable plant, so they can represent potential localized sources of ingress in different bands across the HF spectrum. Radiation from the upstream cable plant may also cause interference into amateur receivers.

The Citizens Band Service operates at powers which are very much lower and are less likely to be sources of ingress. However, CB receivers may be capable of picking up interference from cable plant radiation.

The allocations in the USA and Canada for the Amateur and Citizens Band Services between 5 and 42 MHz are indicated in Table B.VI-2.

B.VI.2.5 Other services

The other services in the HF spectrum operate at powers which are lower than Broadcasting, and are usually not located in residential areas, so they are less likely to be of concern. In the low VHF region between 30 and 42 MHz, there may be a localized effect from high-power paging in the vicinity of 35 MHz.

Table B.VI-2/J.112 – Amateur and Citizens Band allocations between 5 and 42 MHz

Frequency, kHz	
From	To
7 000	7 300
10 100	10 150
14 000	14 350
18 068	18 168
21 000	21 450
24 890	24 990
26 960	27 240
28 000	29 700

B.VI.3 Fitting data carriers within the ingress gaps

The range of modulation rates and the flexibility in setting upstream carrier frequencies defined in this appendix permit operators to fit data-over-cable carriers in the gaps between the short-wave Broadcasting bands, to avoid this significant source of ingress. They also permit operators to avoid the Amateur and Citizens Band bands as well.

Table B.VI-3 illustrates the quantity of data carriers that can be derived in the gaps between the Broadcasting allocations at the channel widths specified in this appendix, and the resulting utilization of the available spectrum. Table B.VI-4 shows a similar illustration for the gaps between the Broadcasting, Amateur and CB allocations. A conservative upper limit of 40 MHz is used.

Table B.VI-3/J.112 – Data carriers in the gaps between broadcasting bands

Non-broadcast spectrum, kHz			Data carrier width, kHz				
			200	400	800	1600	3200
From	To	Gap	Data carriers available				
5 000	5 950	950	4	2	1	0	0
6 200	7 100	900	4	2	1	0	0
7 300	9 500	2 200	11	5	2	1	0
9 900	11 650	1 750	8	4	2	1	0
12 050	13 600	1 550	7	3	1	0	0
13 800	15 100	1 300	6	3	1	0	0
15 600	17 550	1 950	9	4	2	1	0
17 900	21 450	3 550	17	8	4	2	1
21 850	25 670	3 820	19	9	4	2	1
26 100	40 000	13 900	69	34	17	8	4
Least gap, kHz		900					
Total carriers			154	74	35	15	6
Total bandwidth, kHz		31 870	30 800	29 600	28 000	24 000	19 200
Utilization, %			97	93	88	75	60

Table B.VI-4/J.112 – Data carriers in the gaps between Broadcasting, Amateur and CB bands

Spectrum other than Broadcast, Amateur, CB, kHz			Data carrier width, kHz				
			200	400	800	1600	3200
From	To	Gap	Data carriers available				
5 000	5 950	950	4	2	1	0	0
6 200	7 000	800	4	2	1	0	0
7 300	9 500	2 200	11	5	2	1	0
9 900	10 100	200	1	0	0	0	0
10 150	11 650	1 500	7	3	1	0	0
12 050	13 600	1 550	7	3	1	0	0
13 800	14 000	200	1	0	0	0	0
14 350	15 100	750	3	1	0	0	0
15 600	17 550	1 950	9	4	2	1	0
17 900	18 068	168	0	0	0	0	0
18 168	21 000	2 832	14	7	3	1	0
21 850	24 890	3 040	15	7	3	1	0
24 990	25 670	680	3	1	0	0	0
26 100	26 960	860	4	2	1	0	0
27 410	28 000	590	2	1	0	0	0
29 700	40 000	10 300	51	25	12	6	3
Least gap, kHz		168					
Total carriers			136	63	27	10	3
Total bandwidth, kHz		28 750	27 200	25 200	21 600	16 000	9600
Utilization, %			95	88	76	56	34

Appendix B.VII

Example: Multiple upstream channels

This appendix presents an example of several upstream channels served by a single downstream channel. This is meant to illustrate one topology and one implementation of that topology.

Suppose one downstream channel is used in conjunction with four upstream channels as shown in Figure B.VII-1. In this case, the four upstream channels are separate fibers serving four geographical communities of modems.

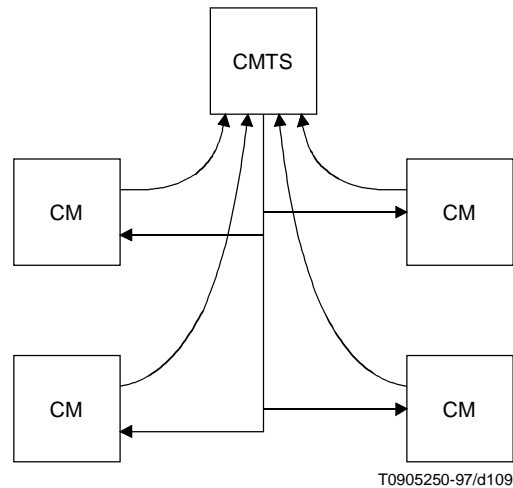

Figure B.VII-1/J.112 – One downstream and four upstream channels

In this topology, the CMTS transmits four Upstream Channel Descriptors (UCDs) and four MAPs. Unfortunately, each CM cannot determine to which upstream channel it is attached, because there is no way to convey the geographical information on the shared downstream channel. The CM must assume (at least at initialization) that the UCD and MAP apply to the channel to which it is attached. The CM chooses an Initial Maintenance opportunity on any of the channels and transmits a Ranging Request. The CMTS will receive the request and will redirect the CM to the appropriate upstream channel identifier. From then on, the CM will be using the MAP that is appropriate to the fiber branch to which it is connected.

A number of constraints are imposed by this topology:

- All of the upstream channels must operate at the same frequency. Since the CM is choosing a channel descriptor at random, it would be transmitting on the wrong frequency if it chose the UCD that applied to a different fiber path.
- All of the upstream channels must operate at the same symbol rate. If not, the CMTS would be unable to demodulate the Ranging Request if transmitted at the wrong symbol rate for the particular channel.
- All Initial Maintenance opportunities across all fiber branches must be aligned. When the CM randomly chooses a MAP to use, the CMTS must be prepared to receive a Ranging Request at that time.
- All Initial Maintenance opportunities must use the same burst characteristics so that the CMTS can demodulate the Ranging Request.

Note that only the initialization intervals must be aligned. Once the CM is assigned its proper channel ID, its activities need only be aligned with other users of its fiber branch. Ordinary data transmission and requests for bandwidth may occur independently across the four upstream channels.

Appendix B.VIII

The data-over-cable spanning tree protocol

Subclause B.3.1.2.1 requires the use of the spanning tree protocol on CMs that are intended for commercial use and on bridging CMTSs. This appendix describes how the 802.1d spanning tree protocol is adapted to work for data over cable systems.

B.VIII.1 Background

A spanning tree protocol is frequently employed in a bridged network in order to deactivate redundant network connections, i.e. to reduce an arbitrary network mesh topology to an active topology that is a rooted tree that spans all of the network segments. The spanning tree algorithm and protocol should not be confused with the data-forwarding function itself; data forwarding may follow transparent learning bridge rules, or may employ any of several other mechanisms. By deactivating redundant connections, the spanning tree protocol eliminates topological loops, which would otherwise cause data packets to be forwarded forever for many kinds of forwarding devices.

A standard spanning tree protocol [IEEE 802.1d] is employed in most bridged local area networks. This protocol was intended for private LAN use and requires some modification for cable data use.

B.VIII.2 Public Spanning Tree

To use a spanning tree protocol in a public-access network such as data-over-cable, several modifications are needed to the basic IEEE 802.1d process. Primarily, the public spanning tree must be isolated from any private spanning tree networks to which it is connected. This is to protect both the public cable network and any attached private networks. Figure B.VIII-1 illustrates the general topology.

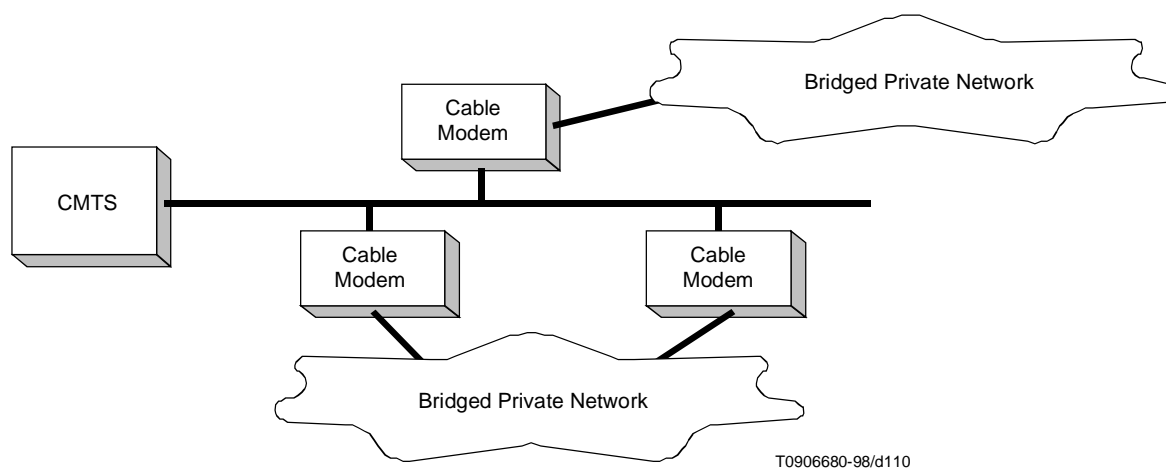

Figure B.VIII-1/J.112 – Spanning tree topology

The task for the public spanning tree protocol, with reference to Figure B.VIII-1, is to:

- Isolate the private bridged networks from each other. If the two private networks merge spanning trees, then each is subject to instabilities in the other's network. Also, the combined tree may exceed the maximum allowable bridging diameter.
- Isolate the public network from the private networks' spanning trees. The public network must not be subject to instabilities induced by customers' networks; nor should it change the spanning tree characteristics of the customers' networks.
- Disable one of the two redundant links into the cable network, so as to prevent forwarding loops. This should occur at the cable modem, rather than at an arbitrary bridge within the customer's network.

The spanning tree protocol must also serve the topology illustrated in Figure B.VIII-2:

In Figure B.VIII-2, in normal operation the spanning tree protocol should deactivate a link at one of the two cable modems. It should not divert traffic across the private network. Note that in some circumstances, such as deactivation of Link-X, spanning tree *will* divert traffic onto the private network (although limits on learned MAC addresses will probably throttle most transit traffic). If this diversion is undesirable, then it must be prevented by means external to spanning tree; for example, by using routers.

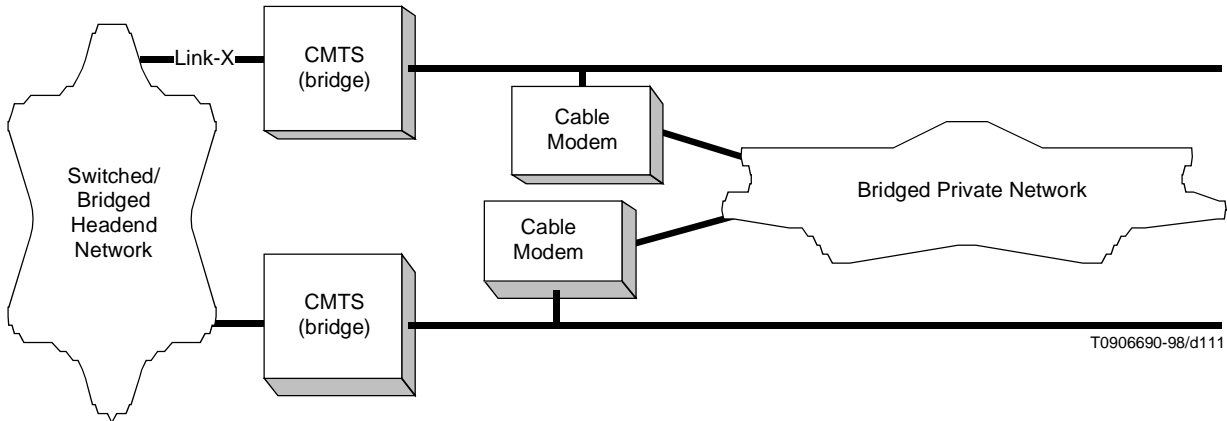

Figure B.VIII-2/J.112 – Spanning tree across CMTSs

B.VIII.3 Public spanning tree protocol details

The Data over Cable Spanning Tree algorithm and protocol is identical to that defined in [IEEE 802.1d], with the following exceptions:

- When transmitting Configuration Bridge Protocol Data Units (BPDUs), the Data over Cable Spanning Tree Multicast Address 01-E0-2F-00-00-03 is used rather than that defined in IEEE 802.1d. These BPDUs will be forwarded rather than recalculated by ordinary IEEE 802.1d bridges.
- When transmitting Configuration BPDUs, the SNAP header AA-AA-03-00-E0-2F-73-74 is used rather than the LLC 42-42-03 header employed by 802.1d. This is to further differentiate these BPDUs from those used by IEEE 802.1d bridges, in the event that some of those bridges do not correctly identify multicast MAC addresses⁹.
- IEEE 802.1d BPDUs are ignored and silently discarded.
- Topology Change Notification (TCN) PDUs are not transmitted (or processed). TCNs are used in IEEE networks to accelerate the aging of the learning database when the network topology may have changed. Since the learning mechanism within the cable network typically differs, this message is unnecessary and may result in unnecessary flooding.
- CMTSs operating as bridges must participate in this protocol and must be assigned higher priorities (more likely to be root) than cable modems. The NSI interface on the CMTS **SHOULD** be assigned a port cost equivalent to a link speed of at least 100 Mbit/s. These two conditions, taken together, should ensure that:
 - 1) a CMTS is the root; and
 - 2) any other CMTS will use the head-end network rather than a customer network to reach the root.
- The MAC Forwarder of the CMTS **MUST** forward BPDUs from upstream to downstream channels, whether or not the CMTS is serving as a router or a bridge.

⁹ It is likely that there are a number of spanning tree bridges deployed which rely solely on the LSAPs to distinguish 802.1d packets. Such devices would not operate correctly if the data-over-cable BPDUs also used LSAP = 0x42.

Note that CMs with this protocol enabled will transmit BPDUs onto subscriber networks in order to identify other CMs on the same subscriber network. These public spanning tree BPDUs will be carried transparently over any bridged private subscriber network. Similarly, bridging CMTSs will transmit BPDUs on the NSI as well as on the RFI interface. The multicast address and SNAP header defined above are used on all links.

B.VIII.4 Spanning tree parameters and defaults

Subclause 4.10.2 of [IEEE 802.1d] specifies a number of recommended parameter values. Those values should be used, with the exceptions listed below.

Path Cost

In [IEEE 802.1d], the following formula is used:

$$\text{Path_Cost} = 1000 / \text{Attached_LAN_speed_in_Mbit/s}$$

For CMs, this formula is adapted as:

$$\text{Path_Cost} = 1000 / (\text{Upstream_symbol_rate} * \text{bits_per_symbol_for_long_data_grant})$$

That is, the modulation type (QPSK or 16 QAM) for the Long Data Grant IUC is multiplied by the raw symbol rate to determine the nominal path cost. Table B.VIII-1 provides the derived values.

For CMTSs, this formula is:

$$\text{Path_Cost} = 1000 / (\text{Downstream_symbol_rate} * \text{bits_per_symbol})$$

Table B.VIII-1/J.112 – CM path cost

Symbol rate	Default path cost	
	QPSK	16 QAM
ksym/s		
160	3125	1563
320	1563	781
640	781	391
1280	391	195
2560	195	98

Bridge Priority

The Bridge Priority for CMs SHOULD default to 28672 (0x7000). This is to bias the network so that the root will tend to be at the CMTS. The CMTS SHOULD default to 32768, as per 802.1d.

Note that both of these recommendations affect only the *default* settings. These parameters, as well as others defined in 802.1d, SHOULD be manageable throughout their entire range through the Bridge MIB (RFC-1493) or other means.

Annex C

Multimedia data transmission equipment over cable television network

C.1 Introduction

This annex is derived from work done on multimedia data transmission equipment designed to be used in cable television networks in Japan. An asymmetrical multimedia data system is described, for use on cable television systems of up to 770 MHz, to enable bi-directional IP datagram transmission.

C.2 Definition of reference system and Interfaces

Figure C.2-1 depicts the reference system and the interface points to define the overall multimedia data transmission system and equipment.

The multimedia transmission system comprises Multimedia Center (MC) equipment, an administrative system, a security system, and Multimedia Home (MH) equipment. MC is usually installed at a cable television Head End or Center and is connected to external interface equipment. MH is mainly installed in residential homes or offices and is connected to customer premises equipment, i.e. personal computers. MC has two major functions; one is the distribution of multimedia data, including IP traffic, from an external network to hundreds of MH equipment connected to the CATV network. The other is the collection of upstream data from MHs. The role of the administrative system is to control daily operations, maintenance, tariff and billings, etc., required to support CATV network systems. MC may include these facilities in the case of a small network. A security system should be installed to intercept third party theft or tampering with data between MC and MH. In some cases, this system may also be included in MC equipment.

Five interface points, A, B, C, D and E, are shown in Figure C.2-1. However, the description of interface points D and E are out of the scope of this annex.

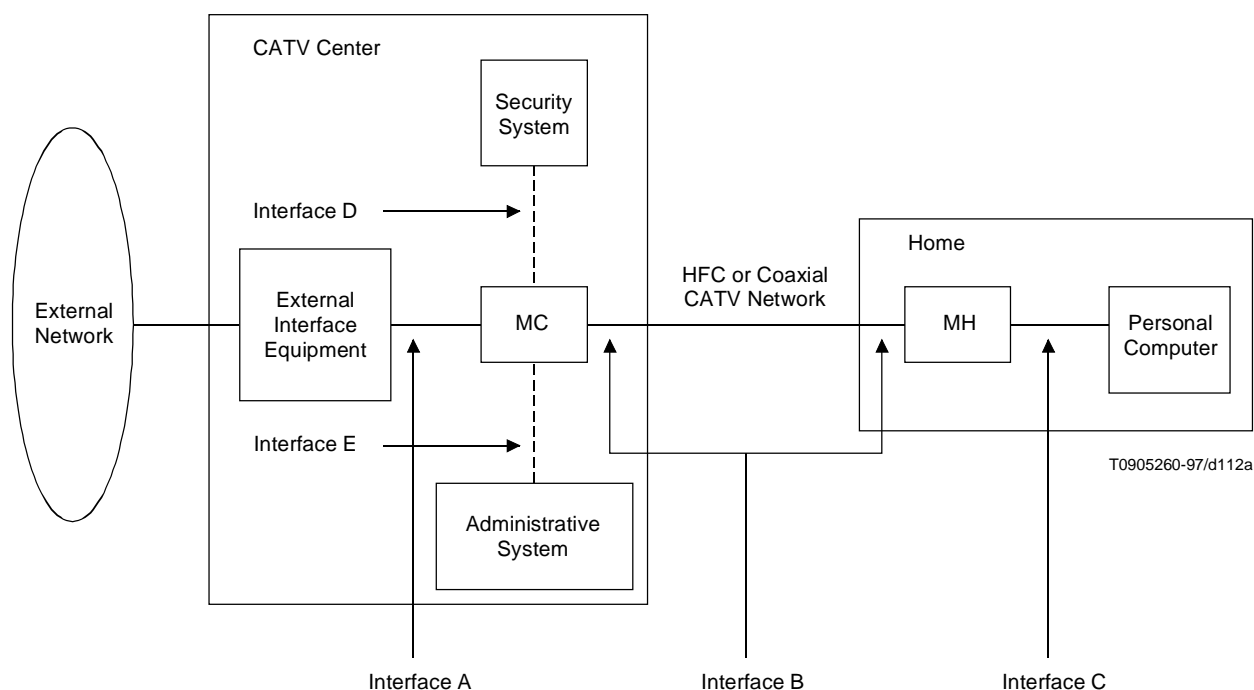

MC Multimedia Center Equipment
MH Multimedia Home Equipment

Figure C.2-1/J.112 – Reference system and interface points

C.3 Protocol stacks

C.3.1 Interface A protocol stack

Figure C.3-1 depicts the protocol stack at Interface A, connecting MC and external interface equipment. This shows the required protocols for IP over IEEE 802 implementations as an example. Other possible implementations using IP over ATM, or IP over FDDI, should adopt open protocols that are in common use.

Network Layer IP
Data Link Layer 802.2 LLC [802.3 MAC
Physical Layer 10 Base-T, 100 Base-T

Figure C.3-1/J.112 – Protocol stack for Interface A

C.3.2 Interface A physical layer and data link layer

The physical layer and data link layer at Interface A should have at least one function to carry IP traffic as defined as follows. The IP data shall be transmitted transparently and bi-directionally through the layers.

- ATM STS-3C
- FDDI
- IEEE 802.3 10 Base-T
- IEEE 802.3 100 Base-T
- Ethernet 10 Base-T
- Ethernet 100 Base-T

C.3.3 Interface A network layer

The network layer of interface A should be Internet Protocol (IP), version 4. This Recommendation is expected to evolve to support IP version 6 (IETF RFC 1883) as it becomes an accepted standard. The IP data shall be transmitted transparently and bi-directionally through the layer.

C.3.4 Interface B protocol stack

Figure C.3-2 shows the protocol stack of interface B to be specified between MC and MH. The most important task of MC and MH is to transmit IP datagrams transparently between cable head end and customer premises. Both MC and MH should work as an IP host, which means supporting IP over LLC/DIX protocol as a part of the Data Link Layer. The physical layer should consist of a Transmission Convergence (TC) layer and a PMD (Physical Media Dependent) layer.

Data Link Layer
Physical Layer

Figure C.3-2/J.112 – Protocol stack of Interface B

C.3.5 Interface C protocol stack

Figure C.3-3 depicts a protocol stack for Interface C, combining MH and PC.

Network Layer
Data Link Layer
Physical Layer

Figure C.3-3/J.112 – Protocol stack at Interface C

C.3.6 Interface C physical layer and data link layer

As the IP traffic must be passed transparently to the PC, LLC and MAC protocols should be adopted in the data link layer. IEEE 802.3 10 Base-T or Ethernet 10 Base-T should be the physical layer protocol. The following protocols should be implemented in the data link layer and physical layer.

- 802.2/DIX
- 802.3/DIX
- IEEE 802.3 10 Base-T
- Ethernet 10 Base-T

C.3.7 Interface C network layer

The network layer of interface C should be Internet Protocol (IP), version 4. This specification is expected to evolve to support IP version 6 (IETF RFC 1883) as it becomes an accepted standard. The IP data shall be transmitted transparently and bi-directionally through the layer.

C.4 Physical layer specification

C.4.1 Upstream

C.4.1.1 Modulation method

QPSK modulation method should be applied for upstream channel.

C.4.1.2 Signal constellation diagram and phase shift rule

In the following Table C.4-1, I_n is in-phase component, while Q_n denotes quadrant component. I_1 means the MSB (Most Significant Bit) of the symbol map.

Table C.4-1/J.112 – Definition of data I_n and Q_n

Modulation method	Input bit definitions
QPSK	$I_1 Q_1$

Equipment should have differential-coded QPSK. Figure C.4-1 shows the signal constellation diagram for QPSK modulation in general form, and Table C.4-2 provides the phase shift rule of differential-coded QPSK modulation.

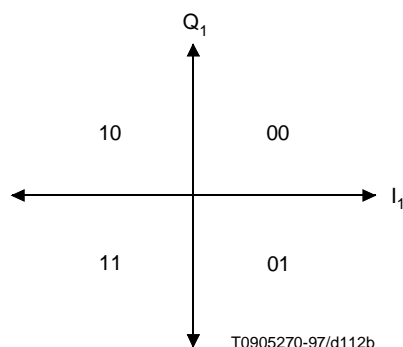

Figure C.4-1/J.112 – QPSK Signal Constellation Diagram

Table C.4-2/J.112 – Phase shift rule for differential-coded QPSK

Input I_1 Q_1	Phase Shift Output
0 0	0 degree
1 0	+90 degrees
1 1	+180 degrees
0 1	+270 degrees

C.4.1.3 Symbol Rate, Bandwidth and Roll Off

In some countries, the upstream channel has been used to transmit several 6 MHz video signals. In order to utilize the limited bandwidth efficiently, the bandwidth of the upstream channel is strongly recommended to be integer-divided value of 6 MHz or 6 MHz/n.

The value "n" shall be carefully chosen to form a series of integer-related upstream bandwidths. Appropriate Roll Off value should be selected from the viewpoint of effective band separation and manufacturing. Furthermore, the preferable symbol rate should be multiples of 8kHz, for synchronization with external transmission lines if required. The resulting values of "n" should be 2, 4, 8, 16 and 32. The Roll Off factor should be 25%.

Table C.4-3 summarizes Integer n, Bandwidth and Symbol Rate. The upstream channel must support all symbol rates shown.

Table C.4-3/J.112 – Integer n, Bandwidth and Symbol Rate

Integer n	6 MHz/n Bandwidth (kHz)	Symbol Rate (ksym/s)
2	3000.0	2304
4	1500.0	1152
8	750.0	576
16	375.0	288
32	187.5	144

C.4.1.4 Frequency range

The upstream channel must support a 10 MHz to 55 MHz frequency range.

C.4.1.5 Error correction

Error correction functionality shall be considered for the noise environment in the cable television network. A Reed-Solomon Code should be implemented as an error correction function for the upstream modulator.

The original Reed-Solomon code is defined as follows:

- Field generator polynomial: $p(X) = X^8 + X^4 + X^3 + X^2 + 1$.
- Code generator polynomial: $g(X) = (X + \alpha^0)(X + \alpha^1)\dots(X + \alpha^{2T-1})$,

where T is error correcting capability of a Reed-Solomon code and α is 02H and one of roots of equation $p(X) = 0$.

C.4.1.6 Randomization

The upstream modulator should provide a randomization function. The polynomial should be $X^{15} + X^{14} + 1$.

C.4.1.7 Transmission signal level

The transmitting signal level at MH output connector should be adjustable over the range +70 to +110 dB μ V. Level adjustment step should be 1dB.

C.4.1.8 Receiving signal level

The operational receiving signal level at MC input connector should satisfy the values in Table C.4-4.

In the case that transmission level control is applied, signals can be received within a part of the range mentioned above.

Table C.4-4/J.112 – Symbol Rate and nominal receive level

Symbol Rate (ksym/s)	Nominal receive level (dB μ V)
144	+44 to +72
288	+47 to +75
576	+50 to +78
1152	+53 to +81
2304	+56 to +84

C.4.1.9 Transmission spurious

The noise and spurious power should not exceed the values shown in Table C.4-5.

The measurement bandwidth is equal to the symbol rate for the requirement below 55 MHz.

The digital carrier level is expected to be –10 dB lower than the analogue NTSC carrier.

Table C.4-5/J.112 – Noise and spurious powers

Frequency	Active period	Inactive period
10 to 55 MHz, Inband	Less than –40 dBc	Less than +30 dB μ V
10 to 55 MHz, Outband including adjacent band, carrier-related band and other noise powers within 10 to 55 MHz	Less than –45 dBc	
55 to 90 MHz	Less than +35 dBmV	
90 to 770 MHz	Less than +35 dB μ V	

C.4.1.10 Bit error rate

Bit error rate of the upstream signal should be less than 10^{-6} at $C/N = 20$ dB (Nyquist bandwidth) without error correction.

C.4.1.11 Frame structure

The frame structure should have the following general format (see Figure C.4-2). Actual length in bits should be defined in the data link layer protocol specifications.



T0905940-97/d113

GT Guard Time
FEC Forward Error Correction

Figure C.4-2/J.112 – Frame structure

C.4.1.12 Channel frequency accuracy

Channel frequency accuracy should be within ± 50 ppm over a temperature range of 0 to 40 degrees C.

C.4.1.13 Symbol rate accuracy

Symbol rate accuracy should be within ± 50 ppm over a temperature range of 0 to 40 degrees C.

C.4.2 Downstream

C.4.2.1 Modulation method

The modulation method should be 64 QAM.

C.4.2.2 Signal constellation diagram and phase shift rule

The signal constellation diagram and phase shift rule should be compliant with Annex C/J.83.

C.4.2.3 Symbol rate and bandwidth

The symbol rate should be 5.274 Msym/s. Bandwidth should be 6 MHz. Other parameters related to symbol rate and bandwidth should be compliant with Annex C/J.83.

C.4.2.4 Frequency range

The downstream channel must support a 90 MHz to 770 MHz frequency range.

C.4.2.5 Error correction

Error correction functionality shall be considered for the noise environment in the cable television network. Code length and information byte length should be in accordance with Annex C/J.83.

The original Reed-Solomon code is defined as follows:

- Field generator polynomial: $p(X) = X^8 + X^4 + X^3 + X^2 + 1$.
- Code generator polynomial: $g(X) = (X + \alpha^0)(X + \alpha^1)\dots(X + \alpha^{2T-1})$,

where T is error correcting capability of a Reed-Solomon code and α is 02H and one of roots of equation $p(X) = 0$.

C.4.2.6 Randomization

A randomization function should be provided. The generator polynomial should be compliant with Annex C/J.83.

C.4.2.7 Interleave

The interleave method should be compliant with Annex C/J.83.

C.4.2.8 Transmission signal level

The transmission signal level at MC output connector should be adjustable over the range of +100 to +110 dB μ V.

C.4.2.9 Receiving signal level

MH should be able to operate at the level within a range of +53 dB μ V to +85 dB μ V at MH input connector.

C.4.2.10 Transmission spurious

Transmission spurious level should be less than -55 dBc over the range of 90 MHz to 770 MHz. The digital carrier level is expected to be 10 dB lower than the analogue NTSC carrier.

C.4.2.11 Bit error rate

Bit error rate should be less than 10^{-8} at CNR = 27 dB (Nyquist bandwidth) with error correction.

C.4.2.12 Channel frequency accuracy

Channel frequency accuracy should be within ± 20 ppm over a temperature range of 0 to 40° C.

C.4.2.13 Symbol rate accuracy

Symbol rate accuracy should be within ± 20 ppm over a temperature range of 0 to 40° C.

C.4.2.14 Impedance, Return Loss and Connector

Impedance, Return Loss and Connector at MH In/Output, MC Output and MC Input should meet the requirements shown in Table C.4-6.

Table C.4-6/J.112 – Impedance, Return Loss and Connector

	Impedance	Return Loss	Connector
MH In/Output	75 Ω	6 dB 10-55 and 90-770 MHz	F-type, Female
MC Output	75 Ω	14 dB 90-770 MHz	F-type, Female
MC Input	75 Ω	6 dB 10-55 MHz	F- type, Female

C.5 Transmission convergence sublayer specification

C.5.1 Introduction

A Transmission Convergence (TC) sublayer is provided for MPEG video and data services. In order to facilitate multiplexing and demultiplexing at TC sublayer, the physical layer is divided into transmission convergence layer and physical media dependent layer. The frame for TC layer is based on Recommendation H.222.0 (188 bytes MPEG packet). An MPEG packet consists of a 4-byte header and 184-byte payload. The payload type can be discriminated by the header. As shown in Figure C.5-1, Video and DOC (Data over Cable) headers are defined to identify the payload type.

header = DOC	DOC MAC payload
header = video	digital video payload
header = video	digital video payload
header = DOC	DOC MAC payload
header = video	digital video payload
header = DOC	DOC MAC payload
header = video	digital video payload
header = video	digital video payload
header = video	digital video payload

Figure C.5-1/J.112 – Downstream TC layer framing

C.5.2 MPEG Packet format

Figure C.5-2 depicts the format of an MPEG Packet. The pointer field shall be inserted if necessary.

MPEG Header (4 bytes)	Pointer_field (1 byte)	Payload (183 or 184 bytes)
--------------------------	---------------------------	-------------------------------

Figure C.5-2/J.112 –MPEG Packet format

C.5.3 MPEG Header

The header of the MPEG transport stream is based on the definition of Recommendation H.222.0 as shown in Table C.5-1.

Table C.5-1/J.112 – MPEG Packet format

Field	Length (bits)	Description
sync_byte	8	0x47; MPEG Packet Sync byte
transport_error_indicator	1	Indicates an error has occurred in the reception of the packet. This bit is reset to zero by the sender, and set to one whenever an error occurs in transmission of the packet.
payload_unit_start_indicator	1	A value of one indicates the presence of a pointer_field as the first byte of the payload (fifth byte of the packet)
transport_priority	1	Reserved, set to zero.
PID (Note)	13	Data over Cable PID (0x1FFE)
transport_scrambling_control	2	Reserved, set to '00'.
adaptation_field_control	2	'01'; use of the adaptation_field is NOT ALLOWED on the PID.
continuity_counter	4	Cyclic counter within this PID
NOTE – In the future, additional PIDs MAY be assigned to an MH.		

C.5.4 Interface with MAC sublayer

There shall be several cases for the relationship of MAC frames to MPEG packets. An MPEG Packet can contain multiple MAC frames, or contain one MAC Frame that applies over multiple MPEG packets.

Figure C.5-3 shows a MAC Frame starting immediately after a pointer field. In this case the pointer field is set to "0" and the decoder shall recognize the head of the MAC Frame after searching the next bytes, except for 0xFF pattern.

MPEG Header (PUSI = 1)	pointer_field (= 0)	MAC Frame (up to 183 bytes)	stuff_byte(s) (0 or more)
---------------------------	------------------------	--------------------------------	------------------------------

Figure C.5-3/J.112 – MAC Frame mapping (1)

Figure C.5-4 shows the case where a MAC Frame continues from the tail of the previous MAC Frame. The pointer shows the next byte of MAC Frame #1. The decoder shall search byte by byte until it finds the pattern, except for 0xFF, from the next byte of the last MAC Frame #1.

MPEG Header (PUSI = 1)	pointer_field (= M)	Tail of MAC Frame #1 (M bytes)	stuff_byte(s) (0 or more)	Start of MAC Frame #2
---------------------------	------------------------	--------------------------------------	------------------------------	--------------------------

Figure C.5-4/J.112 – MAC Frame mapping (2)

Figure C.5-5 shows that multiple MAC frames exist in an MPEG Packet. The pointer should detect the head of MAC Frame #1. The head of the second MAC Frame shall be found after searching patterns except for 0xFF from the position of the head of MAC Frame #1 and succeeding frame length. Thus the MAC Frame should be detected by the end of the MPEG Packet.

MPEG Header (PUSI = 1)	pointer_field (= 0)	MAC Frame #1	MAC Frame #2	stuff_byte(s) (0 or more)	MAC Frame #3
---------------------------	------------------------	-----------------	-----------------	------------------------------	-----------------

Figure C.5-5/J.112 – MAC Frame mapping (3)

Figure C.5-6 shows the case of a MAC Frame overrunning multiple MPEG packets. In this case the pointer field of the succeeding frame points to the byte following the last byte of the tail of the first frame.

MPEG Header (PUSI = 1)	pointer_field (= 0)	stuff_byte(s) (0 or more)	Start of MAC Frame #1 (up to 183 bytes)	
MPEG Header (PUSI = 0)	Continuation of MAC Frame #1 (184 bytes)			
MPEG Header (PUSI = 1)	pointer_field (= M)	Tail of MAC Frame #1 (M bytes)	stuff_byte(s) (0 or more)	Start of MAC Frame #2 (M bytes)

Figure C.5-6/J.112 – MAC Frame mapping (4)

C.5.5 Physical layer interaction

The MPEG-2 packet stream should be encoded in accordance with Annex C/J.83.

C.5.6 MPEG Header synchronization and recovery

The MPEG-2 Packet stream should be in "in frame" state after receiving consecutive five packets without parity check errors. The MPEG-2 Packet should be in "out of frame" state after receiving nine consecutive packets with parity check errors.

C.6 MAC layer specification

C.6.1 Introduction

C.6.1.1 Overview

Figure C.6-1 shows an aspect of the multimedia data transmission system and MAC sublayer domain. The MAC sublayer domain consists of a Multimedia Center (MC) equipment and multiple upstreams and downstreams that connect MC and multimedia Home (MH) equipment. The transmission speed of the downstream is about 30 Mbit/s while the upstream is from about 100 kbit/s to a few Mbit/s. An MH can access an upstream and downstream pair.

Bandwidth assignment for downstream is controlled by the combination of FDM and TDM. Each MH has an assigned receiving channel among multiple downstream channels, and multiple data for MH are multiplexed on a time division basis over the downstream. Bandwidth assignment for upstream is controlled by the combination of FDMA and TDMA. MH has an assigned transmission channel among upstream channels and transmits data after time assignment of upstream channel by multi-access control.

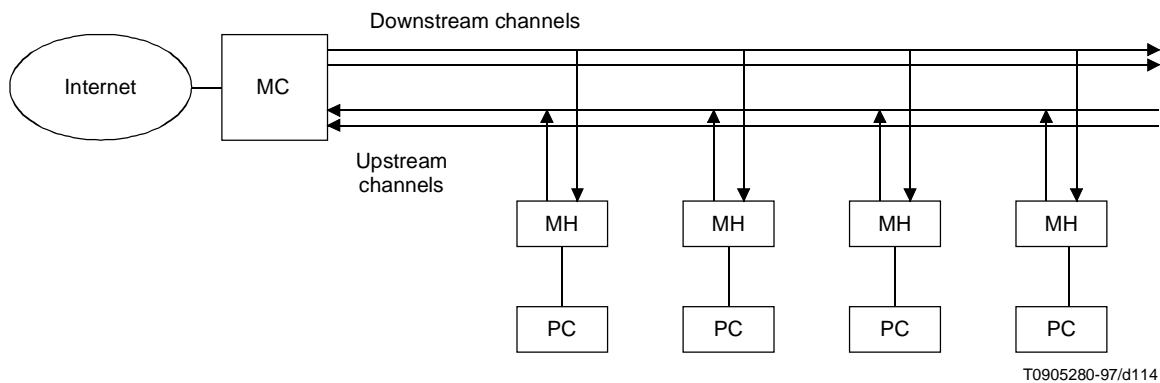

Figure C.6-1/J.112 – Network construction

C.6.1.2 Bandwidth assignment

Figure C.6-2 depicts bandwidth assignment by mini-slots and messages. The upstream channel is divided into small slots called mini-slots. The size of a mini-slot is in multiples of a timebase tick that is selected to be a multiple of the reciprocal of highest symbol rate in upstream. The MC can assign several mini-slots to MH as needed and MH transmits data by combining these mini-slots. Mini-slot assignment is controlled by messages and MC shall transmit the bandwidth assignment message called MAP. MAP contains information for bandwidth assignment as Information Elements (IE). Each IE contains mini-slot start index, mini-slot number to be assigned, service ID and usage of the bandwidth. In Figure C.6-2, mini-slot #N is for random reservation which all MH can access, mini-slots #N + 1 to N + 3 are for random access, mini-slots #N + 4 to N + 7 are for the data domain of specific MH (#a). After receiving MAP, MH should start analysis of IE in the MAP, then transmit data at available mini-slots.

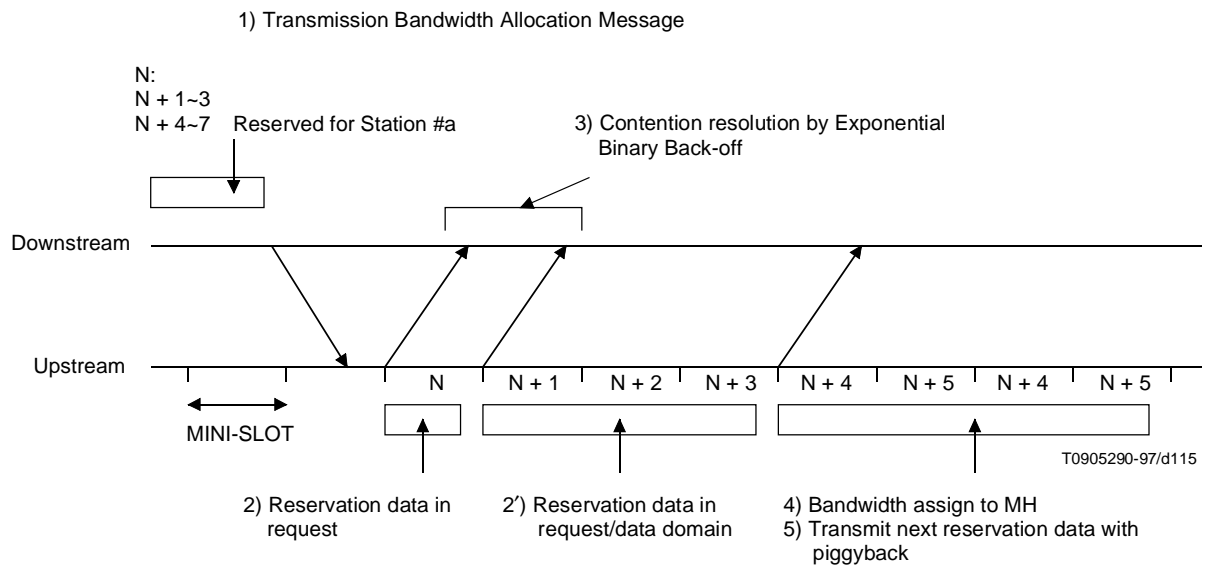

Figure C.6-2/J.112 – Bandwidth assignment by mini-slot and message

C.6.1.3 Mini-slot synchronization

Figure C.6-3 shows mini-slot synchronization that enables the synchronization of mini-slot numbers and boundaries for all MHs connected.

- 0) MC measures Round Trip Delay (RTD) between MC and each MH and notifies it to MH in advance.
- 1) MC keeps a Global Time (GT) counter operated by a timebase tick and informs periodically this counter value to all MHs as timestamp information.
MC controls mini-slot number and boundary based on GT.
- 2) Each MH adjusts Local Time (LT) by timestamp received.
- 3) MH recognizes the mini-slot boundary and number by LT. The mini-slot number N is defined as $N = LT/M$, where M is defined as $LT \bmod M = 0$.
- 4) MH transmits data to assigned mini-slot # N .
- 5) The data arrives at MC at GT that equals $N \times M$.

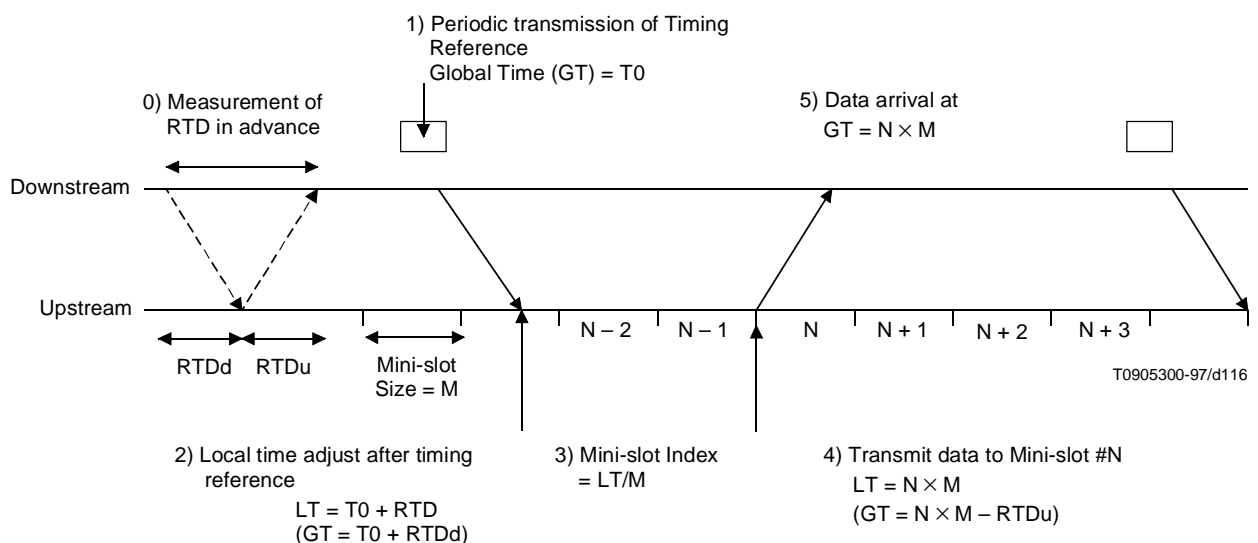

Figure C.6-3/J.112 – Global timing synchronization

C.6.1.4 Access sequence

The access sequence is primarily based on random reservation, however random access shall be available according to traffic volume. Descriptions are given in the following.

C.6.1.4.1 Random reservation

Figure C.6-4 shows the random reservation sequence. MC assigns a domain for the upstream channel to transmit reservation information periodically. MC notifies MH with mini-slot domain information set in MAP. The MH with data to be transmitted can transmit reservation information in the domain. If a collision occurs, MH can resend reservation information by binary exponential back-off algorithm. After resolution of collision, MC notifies MH the band assignment with mini-slot information. After receiving the information, MH should transmit data in the assigned domain.

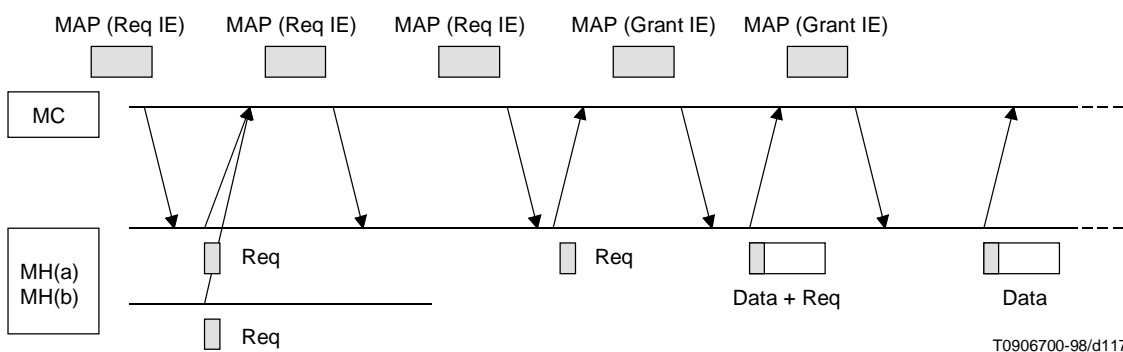

Figure C.6-4/J.112 – Random reservation sequence

C.6.1.4.2 Random access

Generally random reservation realizes a high throughput because of less loss of capacity due to collisions. However it needs a reservation procedure before transmission, and thus increases latency. Random access does not need such a reservation procedure and reduces latency.

Figure C.6-5 depicts the random access sequence. MC should set, regularly, mini-slot domain information that allows random access in MAP. MH should send data within the range of request/data IE indicated. In the case of a collision that means simultaneous data transmission by multiple MHs, retransmission can be done by the binary exponential back-off like random reservation. After receiving data acknowledgement, MH should quit retransmission. MC can stop random access if network traffic becomes heavy.

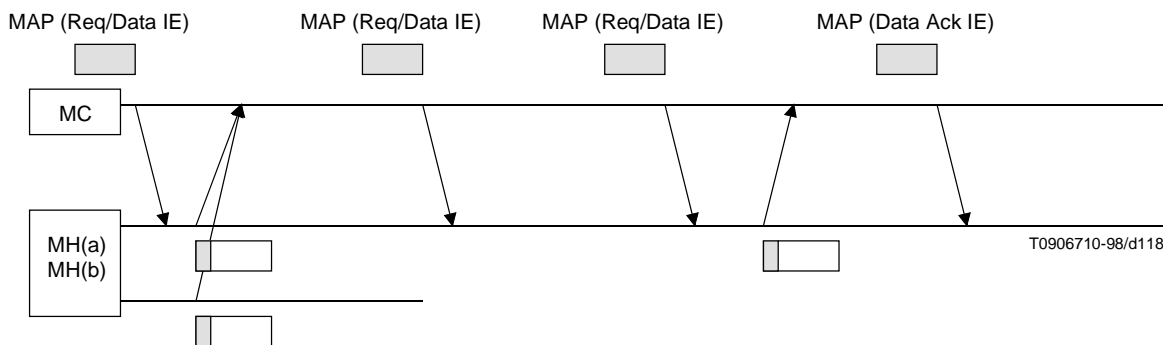

Figure C.6-5/J.112 – Random access sequence

C.6.1.5 QOS by Service ID

In order to assign the upstream bandwidth, a descriptor called Service ID (SID) is used. The purpose of SID is classifying MH and service type. MH should send SID in the reservation information in reservation status to make known to MC the required service grade and bandwidth assignment. MC can also authorize the service grade and MH to be assigned by an indication of SID.

A minimum bandwidth information is defined at this moment as QOS information. MH can request several services besides best effort type service of minimum bandwidth. Upon receipt of the request, MC should assign SID for each service grade.

C.6.2 MAC Frame format

C.6.2.1 Generic MAC Frame format

Figure C.6-6 shows a generic MAC Frame consisting physical layer overheads, MAC Header and Data PDU. PMD overhead includes preamble and synchronization pattern for upstream and MPEG PSI header for downstream.

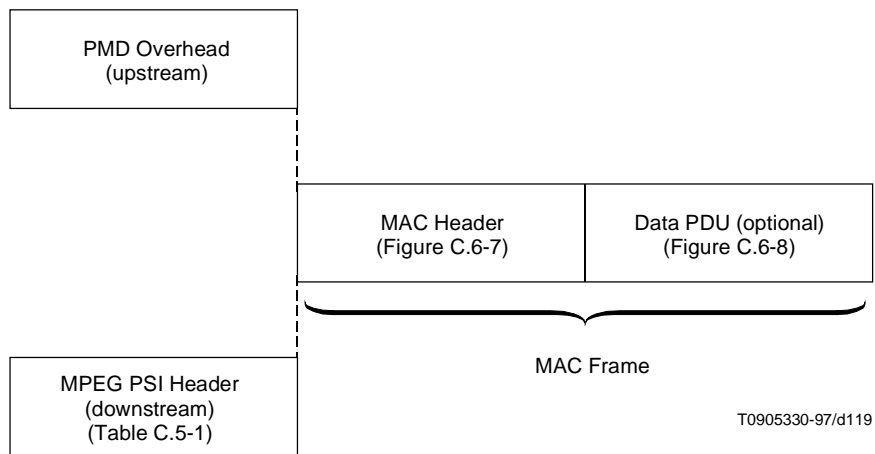

Figure C.6-6/J.112 – MAC Frame

C.6.2.2 MAC Header format

An MAC Header format is shown in Figure C.6-7 and Table C.6-1. MAC Header specifies MAC Frame type and length as well as optional Extended Header (EHDR). EHDR can contain reservation information and extended information for virtual LAN descriptor.

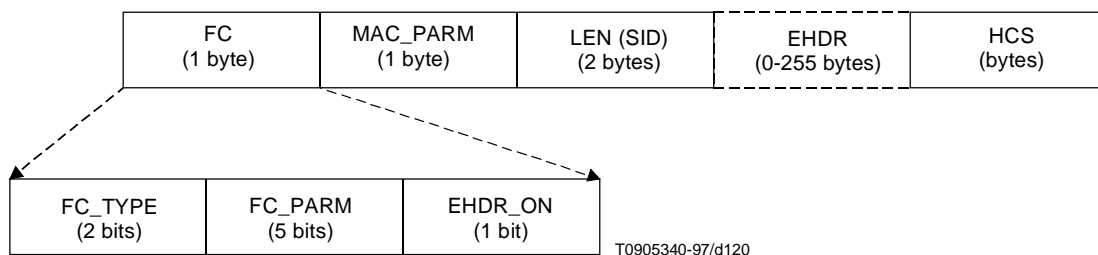

Figure C.6-7/J.112 – MAC Header format

Table C.6-1/J.112 – MAC Header format

MAC Header Field	Usage	Size
FC	Frame Control: Identifies type of MAC Header	8 bits
MAC_PARM	Parameter field whose use is dependent on FC: if EHDR_ON = 1; used for EHDR field length (ELEN) else if for concatenated frames (Table C.6-8) used for MAC frame count else (for Requests only) indicates the number of mini-slots and/or ATM cells requested	8 bits
LEN (SID)	The length of the MAC frame. The length is defined to be the sum of the number of bytes in the extended header (if present) and the number of bytes following the HCS field. (For a REQ Header, this field is the Service ID instead).	16 bits
EHDR	Extended MAC Header (where present; variable size)	0-255 bytes
HCS	MAC Header check sequence	2 bytes
	Length of a MAC Header	6 bytes + EHDR

Table C.6-2 shows Frame Control (FC) field.

Table C.6-2/J.112 – FC field

FC Field	Usage	Size
FC_TYPE	MAC Frame Control Type field: 00: Packet PDU MAC Header 01: ATM PDU MAC Header 10: Reserved PDU MAC Header 11: MAC Specific Header	2 bits
FC_PARM	Parameter bits, use dependent on FC_TYPE.	5 bits
EHDR_ON	When = 1, indicates that EHDR field is present. [Length of EHDR (ELEN) determined by MAC_PARM field]	1 bit

C.6.2.3 Data PDU

A data PDU succeeds a MAC header. As the Data PDU is an option, only the MAC header is transmitted in some cases. Data PDU type and format should be defined by FC field of MAC Header.

C.6.2.4 Packet-based MAC frames

MAC sublayer should support transmission of Ethernet/ISO/IEC 8802-3 type Packet Data PDU. Packet PDU contains DA to CRC but preamble and Start Frame Delimiter (SFD) in the Ethernet frame are as shown in Figure C.6-8.

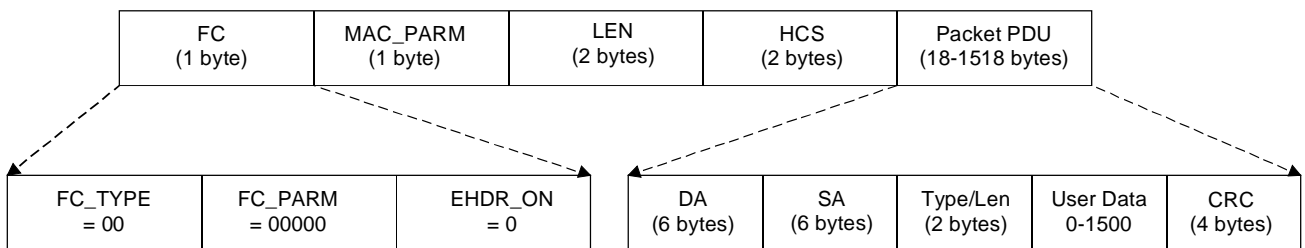

T0905350-97/d121

Figure C.6-8/J.112 – Packet-based MAC frame

Table C.6-3/J.112 – Packet-based MAC Frame format

Field	Usage	Size
FC	FC_TYPE = 00; Packet MAC Header. FC_PARM[4] = Data Link Encryption (DLE). If 1, then a security header for data link encryption is present (B.6.6). If zero, then no security header is present. FC_PARM[3:0] = 000; other values reserved for future use and ignored. EHDR_ON = 0; no EHDR present in this example.	8 bits
MAC_PARM	Reserved, MUST be set to zero if there is no EHDR; otherwise set to length of EHDR.	8 bits
LEN	LEN = n; length of Packet PDU in bytes.	16 bits
EHDR	Extended MAC Header not present in this example	0 bytes
HCS	MAC Header check sequence	2 bytes
Packet Data	Packet PDU: DA – 48-bit Destination Address SA – 48-bit Source Address Type/Len – 16-bit Ethernet Type or [ISO/IEC 8802-3] Length Field User Data (variable length, 0-1500 bytes) CRC – 32-bit CRC over packet PDU (as defined in Ethernet/[ISO/IEC 8802-3])	n bytes
	Length of Packet MAC Frame	6 + n bytes

C.6.2.5 MAC-specific headers

MAC-specific header should control downstream timing, upstream ranging/power adjustment, bandwidth reservation and connection of multiple MAC frames.

C.6.2.5.1 Timing header

A timing header should be used for both upstream and downstream. MAC control messages should be set in a packet PDU. In the case of downstream, a timing header should be used for MC to send Global Timing Reference to synchronize with all MHs. A timing header should be also used for MH to send Ranging message to adjust timing and signal level in upstream channel (see Figure C.6-9 and Table C.6-4).

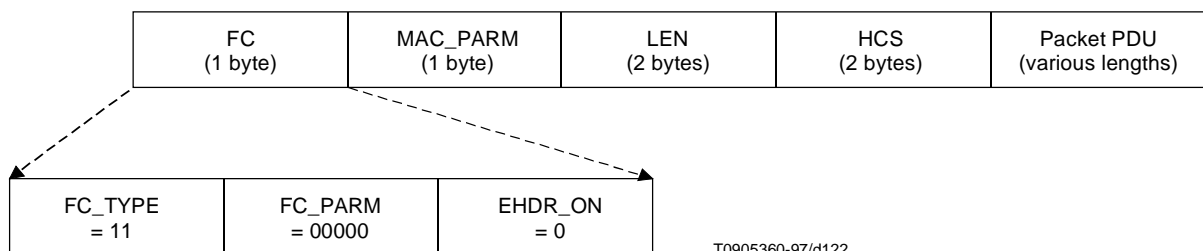

T0905360-97/d122

Figure C.6-9/J.112 – MAC timing header

Table C.6-4/J.112 – MAC timing header format

Field	Usage	Size
FC	FC_TYPE = 11; MAC-specific Header. FC_PARM[4:0] = 00000; Timing MAC Header. EHDR_ON = 0; extended header prohibited for SYNC and RNG-REQ.	8 bits
MAC_PARM	Reserved for future use	8 bits
LEN	LEN = n; length of Packet PDU in bytes.	16 bits
EHDR	Extended MAC Header not present in this example	0 bytes
HCS	MAC Header check sequence	2 bytes
Packet Data	MAC Management message: SYNC message (downstream only) RNG-REQ (upstream only)	n bytes
	Length of Packet MAC Frame	6 + n bytes

C.6.2.5.2 Management header

A management header indicates the head of a MAC Management message. A MAC Management message should be set in packet PDU domain (see Figure C.6-10 and Table C.6-5).

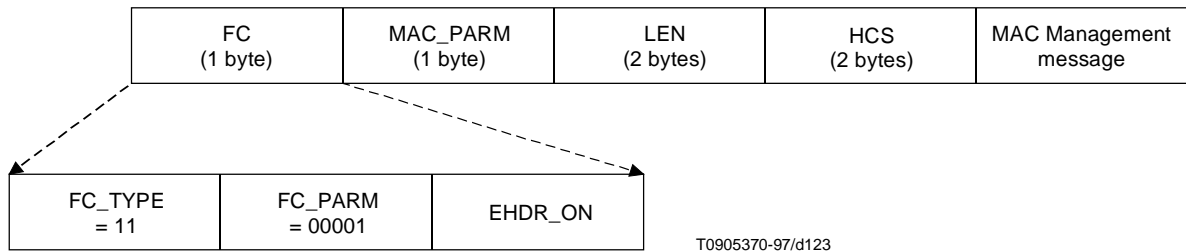

Figure C.6-10/J.112 – MAC management header

Table C.6-5/J.112 – MAC management header format

Field	Usage	Size
FC	FC_TYPE = 11; MAC-specific Header. FC_PARM[4:0] = 00001 EHDR_ON	8 bits
MAC_PARM	Reserved for future use	8 bits
LEN	LEN = n; length of Packet PDU in bytes.	16 bits
EHDR	Extended MAC Header not present in this example	0 bytes
HCS	MAC Header check sequence	2 bytes
Packet Data	MAC Management message	n bytes
	Length of Packet MAC Frame	6 + n bytes + EHDR

C.6.2.5.3 Request header

MH should use MAC Header to reserve bandwidth in the upstream only. The header contains SID and necessary slot numbers/cell numbers information for MH to discriminate data priority. Figure C.6-11 and Table C.6-6 show request header and its format.

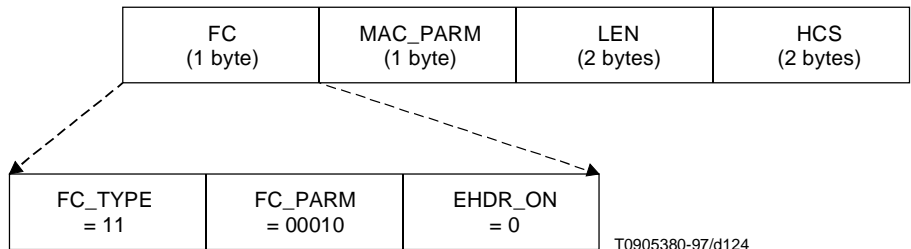

Figure C.6-11/J.112 – MAC request header

Table C.6-6/J.112 – MAC request header format

Field	Usage	Size
FC	FC_TYPE = 11; MAC-specific Header. FC_PARM[3:0] = 0010; MAC Header only; no data PDU following. FC_PARM[4] indicates if REQ is in mini-slots or ATM cells. [4] = 0; mini-slot REQ. [4] = 1; ATM cell REQ. EHDR_ON = 0; no EHDR allowed.	8 bits
MAC_PARM	REQ, total amount of bandwidth requested (upstream only): if FC_PARM[4] = 0; REQ is number of mini-slots. if FC_PARM[4] = 1; REQ is number of ATM cells.	8 bits
SID	Service ID (0 ...0x3FFF)	16 bits
EHDR	Extended MAC Header not allowed	0 bytes
HCS	MAC Header check sequence	2 bytes
	Length of a REQ MAC Header	6 bytes

C.6.2.5.4 Concatenation

In order to transmit multiple MAC frames by one burst, a specific MAC Header is defined.

A concatenation MAC Header appears only once at the head of MAC Frame. It contains MAC Frame number(n) and then n MAC frames follow after the header as shown in Figure C.6-12.

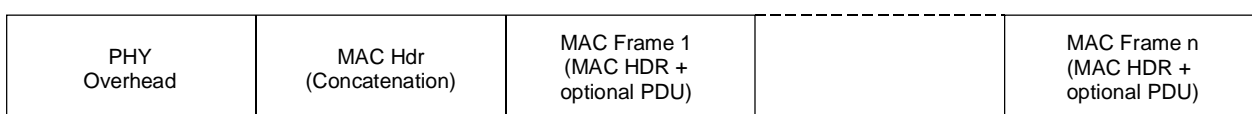

Figure C.6-12/J.112 – MAC Concatenation Frame

MAC Concatenation Header should allow any type of MAC Frame to enable mixture use of Packet, reserved PDU and MAC-specific frame (see Figure C.6-13 and Table C.6-7).

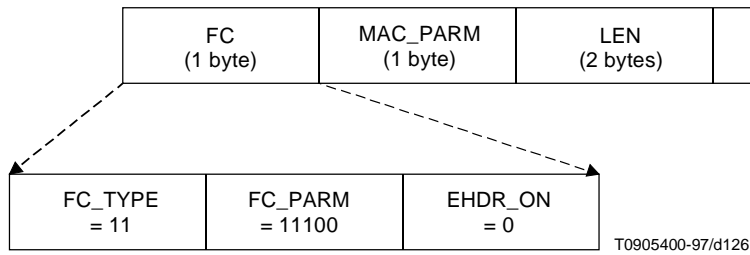

Figure C.6-13/J.112 – MAC Concatenation Header

Tableau C.6-7/J.112 – MAC Concatenation Header format

Field	Usage	Size
FC	FC_TYPE = 11; MAC-specific Header. FC_PARM[4:0] = 11100; Concatenation MAC Header. EHDR_ON = 0; no EHDR with Concatenation Header.	8 bits
MAC_PARM	CNT, number of MAC frames in this concatenation. CNT = 0 indicates unspecified number of MAC frames.	8 bits
LEN	LEN = x + . . . + y; length of all following MAC frames in bytes.	16 bits
EHDR	Extended MAC Header MUST NOT be used.	0 byte
HCS	MAC Header check sequence	2 bytes
MAC frame 1	First MAC frame: MAC Header plus OPTIONAL data PDU.	x bytes
MAC frame n	Last MAC frame: MAC Header plus OPTIONAL data PDU.	y bytes
	Length of Concatenated MAC Frame	6 + LEN bytes

C.6.2.5.5 Extended header

The MAC Frame, besides timing, concatenation MAC Header and request, should have an Extended MAC Header (EHDR) in order to send next reservation information as shown in Figure C.6-14 and Table C.6-8.

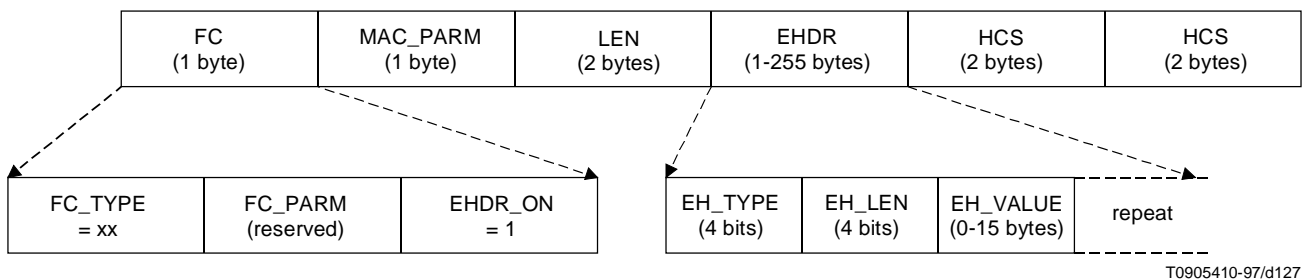

Figure C.6-14/J.112 – Extended MAC Header

Table C.6-8/J.112 – Extended MAC Header format

Field	Usage	Size
FC	FC_TYPE = XX; applies to all MAC Headers. FC_PARM[4:0] = XXXXX; dependent on FC_TYPE. EHDR_ON = 1; EHDR present in this example.	8 bits
MAC_PARM	ELEN = x; length of EHDR in bytes.	8 bits
LEN	LEN = x + y; length of EHDR plus OPTIONAL data PDU in bytes.	16 bits
EHDR	Extended MAC Header present in this example	x bytes
HCS	MAC Header check sequence	2 bytes
PDU	OPTIONAL data PDU	y bytes
	Length of MAC Frame with EHDR	6 + x + y bytes

EHDR should contain multiple EH elements. Table C.6-9 shows the format of EH element that has variable length TLV (Type-Length-Value) format.

Table C.6-9/J.112 – Element format of EHDR

EH element fields	Usage	Size
EH_TYPE	EH Element Type Field	4 bits
EH_LEN	Length of EH element	4 bits
EH_VALUE	EH element data	0-15 bytes

Table C.6-10 shows the type of EH. The first eight EH elements are used between MC and MH. The next seven elements are for MAC sublayer domain, that means in between MC and MH or in between MHs.

Table C.6-10/J.112 – EH element format

EH_TYPE	EH_LEN	EH_VALUE
0	0	Null configuration setting; may be used to pad the extended header. The EH_LEN MUST be zero, but the configuration setting may be repeated.
1	3	Request: mini-slots requested (1 byte); SID (2 bytes) [MH → MC].
2	2	Acknowledgment requested; SID (2 bytes) [MH → MC].
3-7		Reserved [MH → MC]
8	4	Virtual LAN tag [MH ↔ MH]
10-14		Reserved [MH ↔ MH]
15	XX	Extended EH element: EHX_TYPE (1 byte), EHX_LEN (1 byte), EH_VALUE. (length determined by EHX_LEN)

C.6.2.6 MAC Frame error handling

When an error occurs in upstream or downstream, that error may be detected by the Header Check Sequence (HCS). In the case of downstream errors, no specific process is required as the framing recovery is done by MPEG TC layer automatically and the MAC layer disposes of that erroneous frame. For an upstream error, the erroneous frame should be simply discarded and the next frame should start synchronization from the top of frame.

C.6.3 MAC Management message

The MAC management message is the message for MAC access control or initialization, and forms a kernel of the entire MAC control. All the MAC management messages should be encapsulated into LLC frames and be transmitted with MAC-specific header as shown in Figure C.6-15 and Table C.6-11. Table C.6-12 classifies MAC management messages.

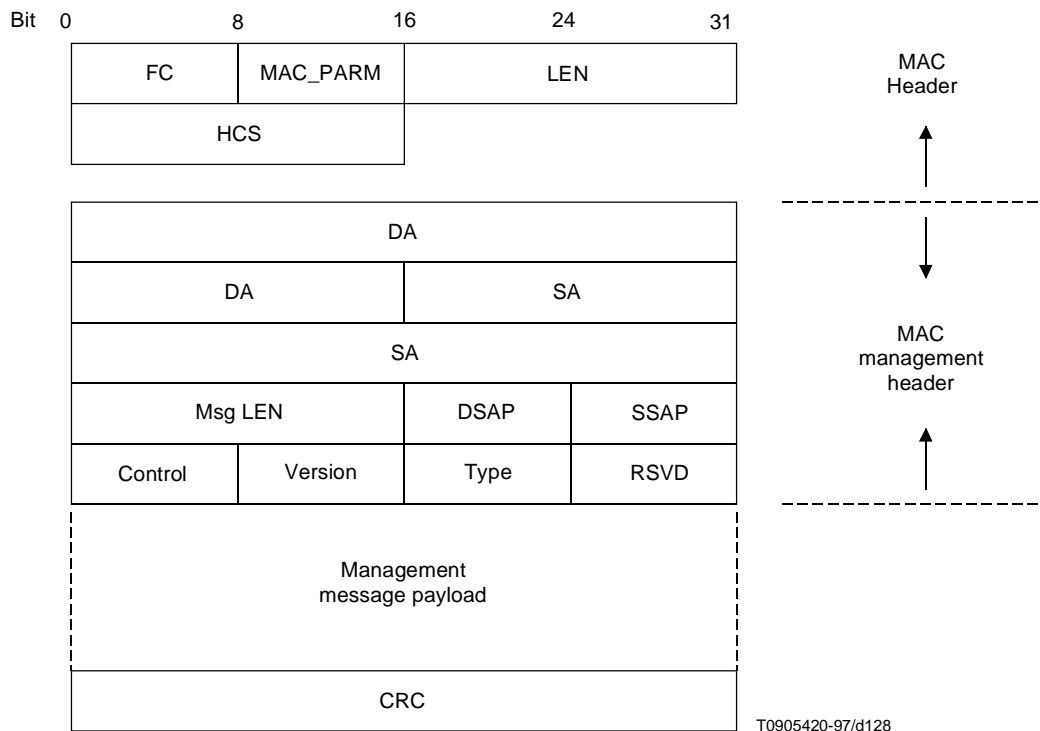

Figure C.6-15/J.112 – MAC management message

Table C.6-11/J.112 – MAC Management message format

Field	Usage	Size
FC, MAC_PARM, LEN, HCS	Common MAC Frame Header. All messages use a MAC-specific header.	
Destination Address (DA)	MAC management frames will be addressed to a specific MH unicast address or to the management multicast address.	6 bytes
Source Address (SA)	The MAC address of the source MH or MC system	6 bytes
Msg Length	The total length of the MAC message from DA to CRC inclusive	2 bytes
DSAP	The LLC null SAP (00) as defined by [ISO/IEC 8802-2]	1 byte
SSAP	The LLC null SAP (00) as defined by [ISO/IEC 8802-2]	1 byte
Control	Unnumbered information frame (03) as defined by [ISO/IEC 8802-2]	1 byte
Version	This field defines the version of the MAC management protocol in use. Set to 1 for this version.	1 byte
Type	This field defines the type of this particular MAC management message.	1 byte
RSVD	This field is used to align the message payload on a 32-bit boundary. Set to 0 for this version.	1 byte
Management Message Payload	As defined for each specific management message	Variable length
CRC	Covers message including header fields (DA, SA, ...). Polynomial defined by [ISO/IEC 8802-3].	4 bytes

Table C.6-12/J.112 – MAC Management message classification

Type value	Message name	Message description
1	SYNC	Timing synchronization
2	UCD	Upstream channel descriptor
3	MAP	Upstream bandwidth allocation
4	RNG-REQ	Ranging Request
5	RNG-RSP	Ranging Response
6	REG-REQ	Registration Request
7	REG-RSP	Registration Response
8	UCC-REQ	Upstream channel change Request
9	UCC-RSP	Upstream channel change Response
10-255		Reserved for future use

C.6.3.1 Time synchronization

The Synchronization (SYNC) message should be transmitted periodically and simultaneously to MHs from MC to synchronize within the MAC sublayer. Figure C.6-16 depicts the format. The MC timestamp is a 32-bit timestamp based on the timebase reference clock.

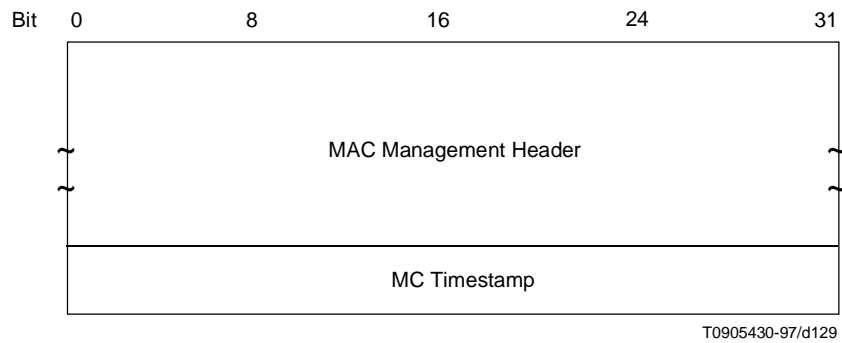

T0905430-97/d129

Figure C.6-16/J.112 – SYNC Message

C.6.3.2 Upstream Channel Descriptor

MC should periodically transmit the Upstream Channel Descriptor (UCD) to notify upstream channel parameters. UCD contains a common parameter such as symbol rate or mini-slot size and multiple burst descriptors. A burst descriptor should contain several parameters of modulation method and FEC code length in accordance with MAC Frame.

Figure C.6-17 shows a format of UCD which contains one header and multiple TLV type parameters, Table C.6-13 classifies UCD message formats.

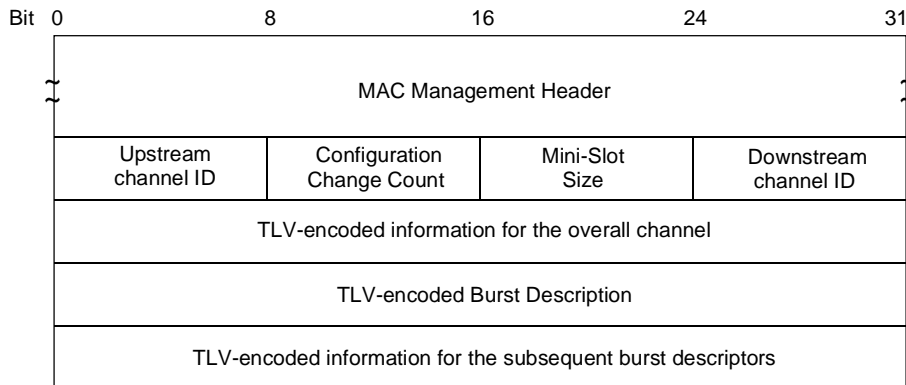

T0905440-97/d130

Figure C.6-17/J.112 – UCD message

Table C.6-13/J.112 – UCD Message format

Field	Usage	Size
Upstream channel ID	The identifier of the upstream channel to which this message refers. This identifier is arbitrarily chosen by the MC and is only unique within the MAC-sublayer domain.	1 byte
Configuration Change Count	Incremented by one (modulo the field size) by the MC whenever any of the values of this channel descriptor change. If the value of this count in a subsequent UCD remains the same, the MH can quickly decide that the remaining fields have not changed, and may be able to disregard the remainder of the message. This value is also referenced from the MAP.	1 byte
Mini-Slot Size	The size of the Mini-Slot for this upstream channel in units of the Timebase Tick (see SYNC message).	1 byte
Downstream channel ID	The identifier of the downstream channel on which this message has been transmitted. This identifier is arbitrarily chosen by the MC and is only unique within the MAC-sublayer domain.	1 byte

Type 1-3 of Table C.6-14 shows common parameters for all MAC frames to be sent upstream. Type 4-burst descriptor is a set of physical parameters.

Table C.6-14/J.112 – UCD Message parameters

Name	Type (1 byte)	Length (1 byte)	Value (variable length)
Symbol Rate	1	1	1-16 Multiples of base rate of 144 ksym/s
Frequency	2	4	Upstream center frequency (Hz)
Preamble Pattern	3	1-128	Preamble superstring. All burst-specific preamble values are chosen as bit-substrings of this string.
Burst Descriptor	4		May appear more than once; described below. The length is the number of bytes in the overall object, including embedded TLV items.

The burst descriptor, as shown in Figure C.6-18, is a set of composite information including TLV type objects. Length indicates byte number of the following data after interval usage code. Interval usage code is a descriptor of Physical Layer parameter set defined by each frame. Upon receipt of UCD, MH should pick up the burst descriptor information contained and record it. In the case of upstream bandwidth assignment, MC should assign interval usage code. MH should pick up the corresponding burst descriptor and set the physical layer parameters.

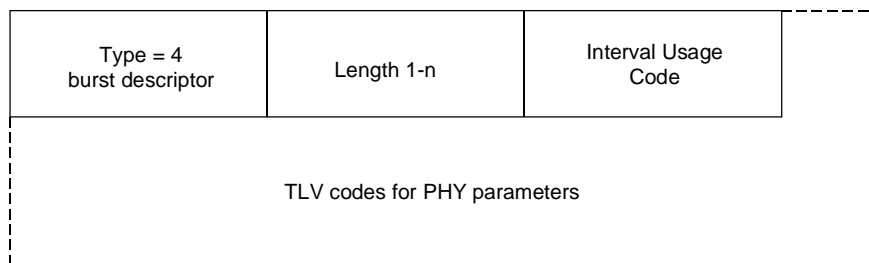

T0905950-97/d131

Figure C.6-18/J.112 – Burst Descriptor format

Burst descriptor should accept unordered lists of physical layer attributes. Each attribute should be described in TLV format (see Table C.6-15).

Table C.6-15/J.112 – Burst Descriptor parameters

Name	Type (1 byte)	Length (1 byte)	Value (variable length)
Modulation Type	1	1	1 = QPSK
Differential Encoding	2	1	1 = on 2 = off
Preamble Length	3	2	Up to 1024 bits. The value must be an integral number of symbols (a multiple of 2 for QPSK).
Preamble Value Offset	4	2	Identifies the bits to be used for the preamble value. This is specified as a starting offset into the Preamble Pattern (see Table C.6-14). That is, a value of zero means that the first bit of the preamble for this burst type is the value of the first bit of the Preamble Pattern. A value of 100 means that the preamble is to use the 101st and succeeding bits from the Preamble Pattern. This value must be a multiple of the symbol size.
FEC Error Correction (T bytes)	5	1	0-10 bytes. Zero implies no Forward Error Correction.
FEC Codeword Length (k)	6	1	Fixed: 1 to 255 Shortened: 16 to 255
Scrambler Seed	7	2	The 15-bit seed value.
Maximum Burst Size	8	1	The maximum number of mini-slots that can be transmitted during this burst type. Absence of this configuration setting implies that the burst size is limited elsewhere. This value MUST be used when the interval type is Short Data Grant.
Guard Time Size	9	1	Number of symbol times which must follow the end of this burst. (Although this value may be derivable from other network and architectural parameters, it is included here to ensure that the MHs and MC all use the same value.)
Last Codeword Length	10	1	1 = fixed 2 = shortened
Scrambler on/off	11	1	1 = on 2 = off

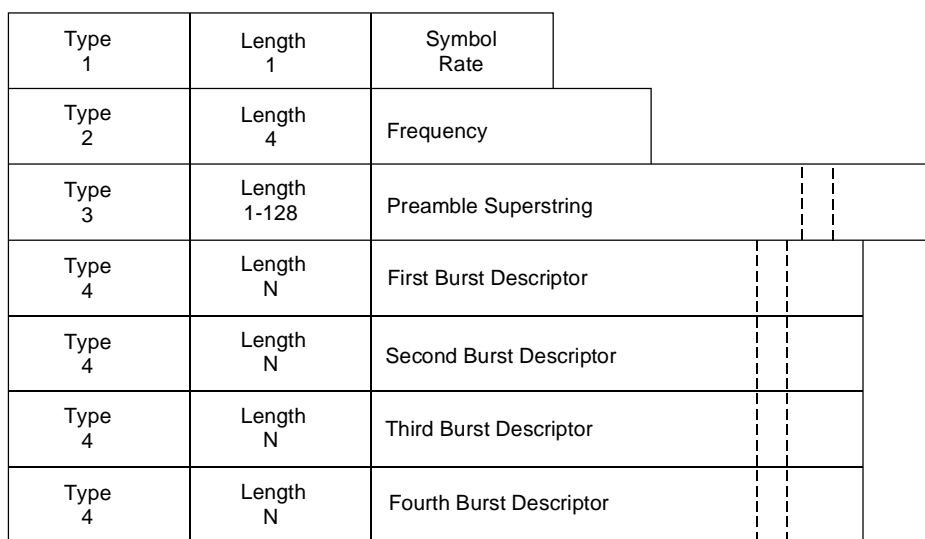

T0905960-97/d132

Figure C.6-19/J.112 – A Sample of Burst Descriptor coding

C.6.3.3 Upstream bandwidth allocation map

Upstream bandwidth allocation map (MAP) is a message for upstream channel bandwidth assignment conveyed from MC to MH. Figure C.6-20 shows the MAP message and Table C.6-16 its format.

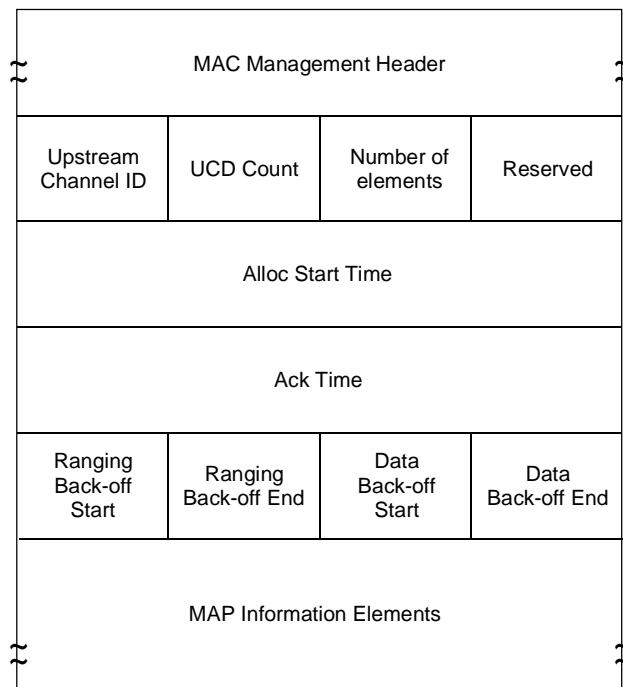

T0905450-97/d133

Figure C.6-20/J.112 – MAP message

Table C.6-16/J.112 – MAP message format

Field	Usage	Size
Upstream channel ID	The identifier of the upstream channel to which this message refers	1 byte
UCD Count	Matches the value of the Configuration Change Count of the UCD which describes the burst parameters which apply to this map.	1 byte
Number of Elements	Number of information elements in the map	1 byte
Reserved	Reserved field for alignment	1 byte
Alloc Start time	Effective start time from MC initialization (in mini-slots) for assignments within this map	4 bytes
Ack time	Latest time, from MC initialization, (mini-slots) processed in up-stream that generated a Grant, Grant Pending or Data Ack	4 bytes
Ranging Back-off Start	Initial back-off window for initial ranging contention, expressed as a power of two. Values range 0-15.	1 byte
Ranging Back-off End	Final back-off window for initial ranging contention, expressed as a power of two. Values range 0-15.	1 byte
Data Back-off Start	Initial back-off window for contention data and requests, expressed as a power of two. Values range 0-15.	1 byte
Data Back-off End	Final back-off window for contention data and requests, expressed as a power of two. Values range 0-15.	1 byte
MAP information elements	Bandwidth assignment information	

MAP information elements should be in the format shown in Figure C.6-21 and Table C.6-17.

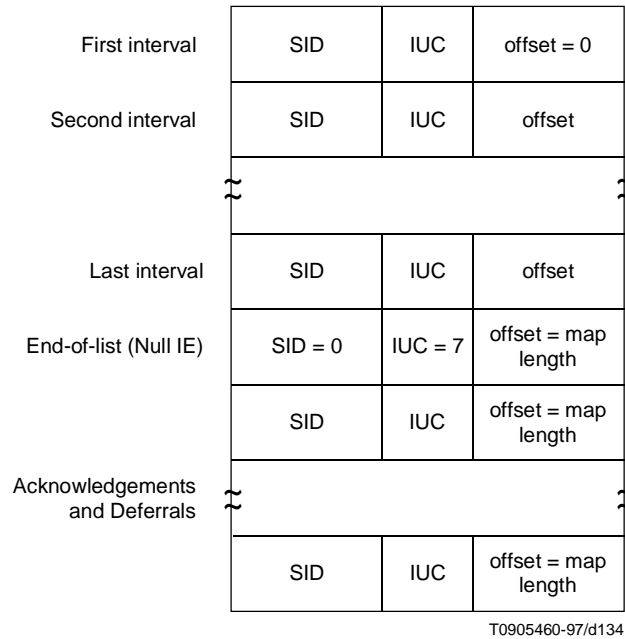

Figure C.6-21/J.112 – MAP information element coding

Table C.6-17/J.112 – IE format

Field	Usage	Size
SID	Bandwidth and service class assign to MH	14 bits
IUC (Information Usage Code)	Usage of assigned band (for request, for grant)	4 bits
Offset	Indicate first offset value of mini-slot domain	14 bits

Information Usage Code (IUC) indicates a usage of allocated bandwidth. The list of IUCs is given in Table C.6-18.

C.6.3.4 Ranging Request

Ranging Request (RNG-REQ) is a requirement for ranging to be sent from MH to MC. After receiving RNG-REQ, MC should start measurement of latency and signal level and notify its adjustment value to MH by Ranging Response (RNG-RSP) that is described in the following paragraph. Figure C.6-22 shows RNG-REQ message and Table C.6-19, RNG-REQ message format.

Table C.6-18/J.112 – Information elements

IE Name	Information Usage Code (IUC) (4 bits)	SID (14 bits)	Mini-slot Offset (14 bits)
Request	1	Any	Starting offset of REQ region
REQ/Data (refer to Appendix B.I for multicast definition)	2	Multicast	Starting offset of IMMEDIATE Data region well-known multicasts define start intervals
Initial Maintenance	3	Broadcast/multicast	Starting offset of MAINT region (used in Initial Ranging)
Station Maintenance	4	Unicast	Starting offset of MAINT region (used in Periodic Ranging)
Short Data Grant	5	Unicast	Starting offset of Data Grant assignment; if inferred length = 0, then it is a Data Grant pending.
Long Data Grant	6	Unicast	Starting offset of Data Grant assignment; if inferred length = 0, then it is a Data Grant Pending.
Null IE	7	Zero	Ending offset of the previous grant. Used to bound the length of the last actual interval allocation.
Data Ack	8	Unicast	MC sets to 0
Reserved	9-14	Any	Reserved
Expansion	15	Expanded IUC	# of additional 32-bit words in this IE

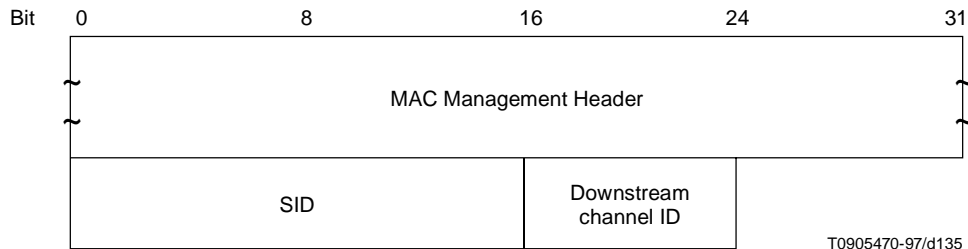

T0905470-97/d135

Figure C.6-22/J.112 – RNG-REQ message

Table C.6-19/J.112 – RNG-REQ message format

Field	Usage	Size
SID	Initialization SID or assigned SID for periodic requests (this is a 16-bit field of which the lower 14 bits define the SID with bits 14,15 defined to be 0.)	2 bytes
Downstream Channel ID	The identifier of the downstream channel on which the MH received the UCD which described this upstream.	1 byte

C.6.3.5 Ranging Response

Ranging Response (RNG-RSP) is sent to MH from MC according to RNG-REQ message. RNG-RSP should indicate the values of timing or signal level to be adjusted at MH. Figure C.6-23 depicts RNG-RSP message, Table C.6-20 gives RNG-RSP message encodings.

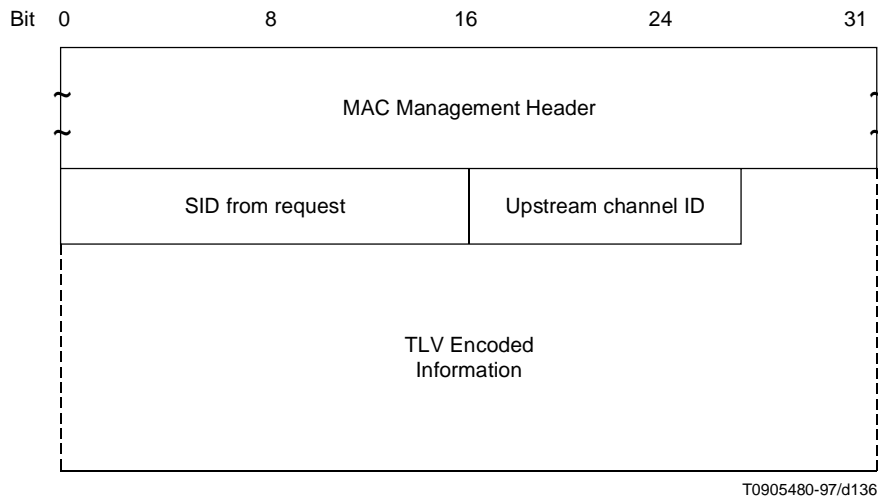

Figure C.6-23/J.112 – RNG-RSP message

Table C.6-20/J.112 – RNG-RSP message encodings

Name	Type (1 byte)	Length (1 byte)	Value (variable length)
Timing Adjust	1	4	TX timing offset adjustment (signed 16-bit)
Power Level Adjust	2	1	TX Power offset adjustment (signed 8-bit, 1dB units)
Offset Frequency Adjust	3	2	TX frequency offset adjustment (signed 16-bit, Hz units)
Transmit Equalization Adjust	4	n	TX equalization data – See details below
Ranging Status	5	1	1 = continue, 2 = abort, 3 = success.
Reserved	6-255	n	Reserved for future use

If equalization functionality is needed, the coefficients of the equalizer (Tap Values) should be sent as an RNG-RSP message. Figure C.6-24 shows general equalization coefficients, Figure C.6-25 is for equalizer tap location and Figure C.6-26 is for TLV parameter coding.

Type 4	Length	Number of taps per symbol
Number of forward taps (N)	Number of reverse taps (M)	
First coefficient F_0 (real)		First coefficient F_0 (imaginary)

}}

Last coefficient F_N (real)		Last coefficient F_N (imaginary)
First reverse coefficient D_0 (real)		First reverse coefficient D_0 (imaginary)

}}

Last reverse coefficient D_M (real)		Last reverse coefficient D_M (imaginary)
---------------------------------------	--	--

T0905490-97/d137

Figure C.6-24/J.112 – Equalizer coefficients

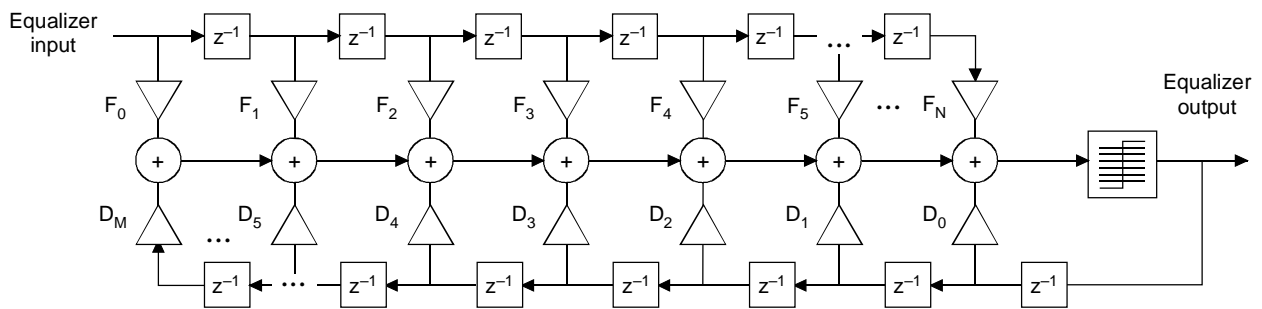

T0905500-97/d138

Figure C.6-25/J.112 – Equalizer tap location

Type 1	Length 4	Timing adjust
Type 2	Length 1	Power adjust
Type 3	Length 2	Frequency adjust information
Type 4	Length x	x bytes of MH transmitter equalization information
Type 5	Length 1	Ranging status

T0905970-97/d139

Figure C.6-26/J.112 – TLV Type parameter coding

C.6.3.6 Registration Request

In the initialization, MH should receive a parameter file and set first operation parameters. Then MH should transmit a Registration Request (REG-REQ) to negotiate each parameter such as frequency assignment of upstream and downstream or supporting of optional function with MC. The REG-REQ message should also contain an SID request in accordance with service grade. Figures C.6-27 and C.6-28 show REG-REQ messages and an example of encoding, respectively.

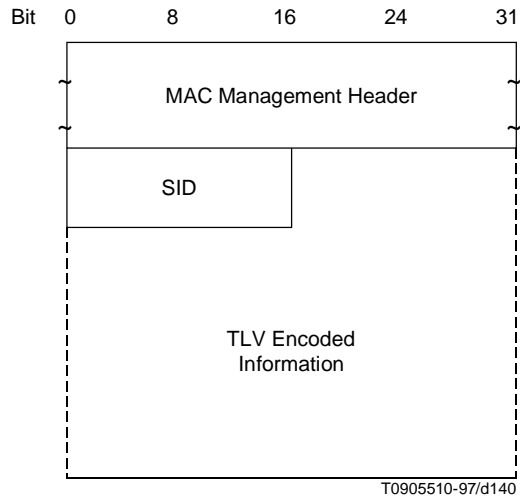

Figure C.6-27/J.112 – REG-REQ message

Type 1	Length 4	Downstream Frequency	
Type 2	Length 1	Upstream channel	
Type 3	Length 1	Network access	
Type 4	Length 28	Service class definition class 1	
Type 4	Length 28	Service class definition class 2	
Type 4	Length 28	Service class definition class n	
Type 5	Length 6	Modem capabilities	
Type 12	Length 4	Modem IP address	
Type 8	Length 3	Vendor ID	
Type 43	Length n	n-bytes of vendor-specific data	
Type 6	Length 16	MH message integrity check	
Type 7	Length 16	MC message integrity check	

T0905980-97/d141

Figure C.6-28/J.112 – A sample of REG-REQ encodings

C.6.3.7 Registration Response

Registration Response (REG-RSP) is a message from MC to MH in response to an REG-REQ message. MC should allocate upstream/downstream frequency, optional supporting function and SID to MH. Figures C.6-29 and C.6-30 depict REG-RSP message and an example of encoding, respectively.

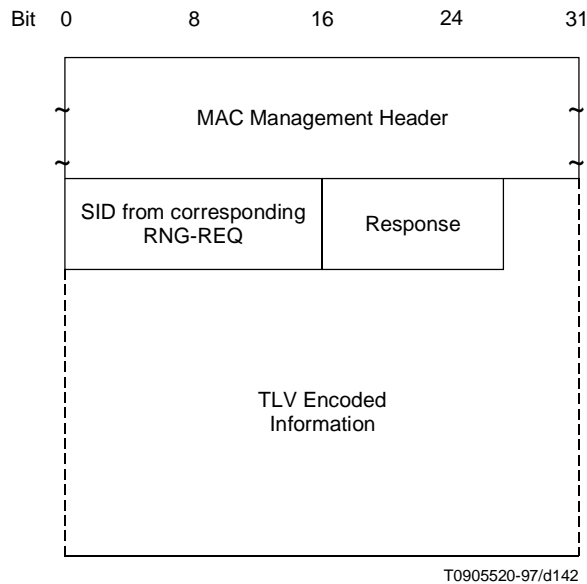

Figure C.6-29/J.112 – REG-RSP message

Type 1	Length 7	Service class definition class 1
Type 1	Length 7	Service class definition class 2
...		
Type 1	Length 7	Service class definition class n
Type 6	Length 6	Modem capability

T0905530-97/d143

Figure C.6-30/J.112 – A sample of REG-RSP encodings

Service Class Data is a composite parameter consisted of multiple parameters. Each service parameter should include only one parameter related to one service class. Table C.6-21 shows an example of service class encoding.

Table C.6-21/J.112 – A sample of service class data encodings

Type	Length	Value (sub)type	Length	Value	Description
1	7	1	1	1	Service class data configuration setting
		2	2	123	Service class 1 SID for this class
1	7	1	1	2	Service class data configuration setting
		2	2	244	Service class 2 SID for this class
1	7	1	1	n	Service class data configuration setting
		2	2	345	Service class n SID for this class

C.6.3.8 Upstream Channel Change Request

Upstream Channel Change Request (UCC-REQ) should be transmitted to indicate the upstream channel change to MH from MC. Figure C.6-31 shows a format for a UCC-REQ message.

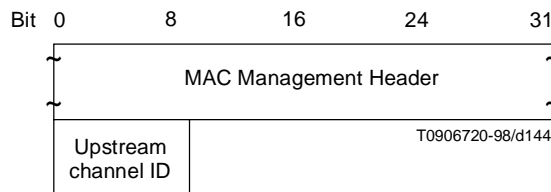

Figure C.6-31/J.112 – UCC-REQ message

C.6.3.9 Upstream Channel Change Response

MH should transmit Upstream Channel Change Response (UCC-RSP) message to MC in response to a UCC-REQ message. After transmission of UCC-RSP, MH should change upstream channel. MH should ignore UCC-REQ in the case of upstream channel change. If UCC-REQ indicates that the current channel is in use, MH should return a UCC-RSP message to MC nevertheless. Figure C.6-32 shows a format for a UCC-RSP message.

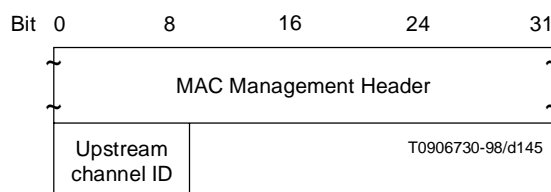

Figure C.6-32/J.112 – UCC-RSP message

ITU-T RECOMMENDATIONS SERIES

Series A	Organization of the work of the ITU-T
Series B	Means of expression: definitions, symbols, classification
Series C	General telecommunication statistics
Series D	General tariff principles
Series E	Overall network operation, telephone service, service operation and human factors
Series F	Non-telephone telecommunication services
Series G	Transmission systems and media, digital systems and networks
Series H	Audiovisual and multimedia systems
Series I	Integrated services digital network
Series J	Transmission of television, sound programme and other multimedia signals
Series K	Protection against interference
Series L	Construction, installation and protection of cables and other elements of outside plant
Series M	TMN and network maintenance: international transmission systems, telephone circuits, telegraphy, facsimile and leased circuits
Series N	Maintenance: international sound programme and television transmission circuits
Series O	Specifications of measuring equipment
Series P	Telephone transmission quality, telephone installations, local line networks
Series Q	Switching and signalling
Series R	Telegraph transmission
Series S	Telegraph services terminal equipment
Series T	Terminals for telematic services
Series U	Telegraph switching
Series V	Data communication over the telephone network
Series X	Data networks and open system communications
Series Y	Global information infrastructure
Series Z	Programming languages