



INTERNATIONAL TELECOMMUNICATION UNION

ITU-T

TELECOMMUNICATION
STANDARDIZATION SECTOR
OF ITU

I.365.3

(11/95)

**INTEGRATED SERVICES DIGITAL
NETWORK (ISDN)**

**OVERALL NETWORK ASPECTS
AND FUNCTIONS**

**B-ISDN ATM ADAPTATION LAYER
SUBLAYERS: SERVICE SPECIFIC
COORDINATION FUNCTION TO PROVIDE
THE CONNECTION-ORIENTED TRANSPORT
SERVICE**

ITU-T Recommendation I.365.3

(Previously "CCITT Recommendation")

FOREWORD

The ITU-T (Telecommunication Standardization Sector) is a permanent organ of the International Telecommunication Union (ITU). The ITU-T is responsible for studying technical, operating and tariff questions and issuing Recommendations on them with a view to standardizing telecommunications on a worldwide basis.

The World Telecommunication Standardization Conference (WTSC), which meets every four years, establishes the topics for study by the ITU-T Study Groups which, in their turn, produce Recommendations on these topics.

The approval of Recommendations by the Members of the ITU-T is covered by the procedure laid down in WTSC Resolution No. 1 (Helsinki, March 1-12, 1993).

ITU-T Recommendation I.365.3 was prepared by ITU-T Study Group 13 (1993-1996) and was approved under the WTSC Resolution No. 1 procedure on the 2nd of November 1995.

NOTE

In this Recommendation, the expression "Administration" is used for conciseness to indicate both a telecommunication administration and a recognized operating agency.

© ITU 1996

All rights reserved. No part of this publication may be reproduced or utilized in any form or by any means, electronic or mechanical, including photocopying and microfilm, without permission in writing from the ITU.

CONTENTS

		<i>Page</i>
1	Scope	1
2	Normative References	1
3	Definitions	2
4	Abbreviations	2
5	Conventions	3
6	General Description	3
7	Services provided by the SSCF-COTS	4
8	Functions of the SSCF-COTS	6
9	Elements for layer-to-layer communication	7
	9.1 Primitives between SSCF-COTS and SCF	7
	9.1.1 Definition of primitives	7
	9.1.2 Parameter definition	8
	9.2 Signals between SSCF-COTS and SSCF-COTS Layer Management	9
	9.2.1 Signal definition	9
	9.2.2 Parameter definition	9
	9.2.3 States at the boundary between SSCF-COTS and Layer Management	10
	9.3 Signals between SSCF-COTS and SSCOP	10
	9.3.1 Definition of signals	10
	9.3.2 Parameter definition	10
	9.4 State transition diagram for sequences of signals at the layer boundaries of SSCF-COTS	11
10	Protocol elements for peer-to-peer communication	13
	10.1 SSCF-COTS PDUs	14
	10.1.1 SSCF-COTS PDUs utilizing the unassured data transfer	14
	10.1.2 SSCF-COTS PDUs utilizing the assured data transfer	15
	10.1.3 SSCF-COTS PDUs utilizing data transfer capabilities in SSCOP connection control services	15
	10.2 SSCF-COTS PDU formats	15
	10.2.1 Coding conventions	15
	10.2.2 PDU length	17
	10.3 SSCF-COTS PDU fields	17
	10.4 SSCF-COTS state variables	19
	10.4.1 Transmitter state variables	19
	10.4.2 Receiver state variables	20
	10.4.3 Common state variables	20
	10.5 SSCF-COTS timers	20
	10.6 SSCF-COTS protocol parameter	20
11	Specification of the SSCF-COTS	20
	11.1 Overview	20
	11.1.1 Idle	20
	11.1.2 Establishment and release	21
	11.1.3 Data transfer	22
	11.2 State transition table	22
	11.3 SDL diagrams	22

Annex A – Management error indications	42
Annex B – Default values for SSCOP parameters and timers	43
Annex C – Expedited Data Transfer service.....	44
C.1 Protocol elements for peer-to-peer communication	44
C.1.1 SSCF-COTS PDUs	44
C.1.2 SSCF-COTS PDU formats	44
C.1.3 SSCF-COTS PDU parameter fields	45
C.1.4 Additional states of the SSCF-COTS protocol entity.....	46
C.1.5 Additional SSCF-COTS state variables	46
C.1.6 SSCF-COTS timers	47
C.2 Specification of the Expedited Data service procedure.....	48
Annex D – Quality of Service parameter negotiation.....	56
D.1 Parameters and their negotiation for the “Empty” QOS set.....	56
D.2 Parameters and their negotiation for the “Standard CONS” QOS set.....	56
D.2.1 QOS Parameters at the SSCF-COTS/SSCF-COTS user boundary	57
D.2.2 Negotiation of QOS Parameters	57
Annex E – Supplementary specification for the SCF (Recommendation Q.923).....	59
E.1 Adaptation of the primitive names to the Transport Service.....	60
E.1.1 Introduction	60
E.1.2 Abbreviations	60
E.1.3 Interpretation	60
E.1.4 X.214 type of service	60
E.1.5 Summary of the Sub-N-Service primitives at the N(c)C endpoint.....	60
E.1.6 Deletion of the Reset service.....	61
E.1.7 State transition table	62
E.2 Selection of predicates	62
E.3 Mapping of the C-plane Sub-N-Service.....	62
Appendix I – T(u)-primitive sequences at the UNI for connection establishment and release within the U-plane and their relationship to AA-signals and SSCOP PDU sequences	64
Appendix II – Further considerations for the default values for the SSCOP parameters and timers.....	75
II.1 Definitions.....	75
II.2 Goal.....	75
II.3 Frame size	76
II.4 Qualitative Analysis.....	76
II.4.1 Assumptions	76
II.4.2 Timing in the absence of errors	76
II.4.3 Timing for single corrupted data frame correction.....	77
II.4.4 Timing for single corrupted POLL or STAT PDU	78
II.4.5 Multiple errors.....	78
II.5 Conclusion	78

SUMMARY

The ATM Adaptation Layer (AAL) is defined to enhance the services provided by the ATM layer to support the functions required by the next higher layer. One particular type of service supported by the AAL is the Connection Oriented Transport Service (COTS). The AAL for COTS comprises functions necessary to support COTS data communications between peer entities in the user plane.

The AAL for COTS consists of a Segmentation And Reassembly (SAR) function, and a Convergence Sublayer which is specified as two sublayers: a Common Part Convergence Sublayer (CPCS) and a Service Specific Convergence Sublayer (SSCS). The CPCS is defined in clause 6/I.363 and is used as the underlying protocol for the service specific part for COTS. The SSCS is functionally divided into two parts: the Service Specific Connection Oriented Protocol (SSCOP), which provides an assured data transfer service, and the Service Specific Coordination Function (SSCF). The SSCOP is defined in Recommendation Q.2110 [4] and is suitable for use by various SSCFs. This Recommendation specifies the SSCF for COTS.

This Recommendation describes for the SSCF-COTS the mapping of primitives from the Synchronization and Coordination Function (SCF) (defined in Recommendation Q.923 [3]) to signals of the SSCOP and vice versa. It also specifies the exchange of signals between Layer Management and the SSCF-COTS.

KEYWORDS

Asynchronous Transfer Mode (ATM), ATM Adaptation Layer (AAL), Broadband Integrated Services Digital Network (B-ISDN), Connection Oriented Transport Service (COTS), Service Specific Coordination Function (SSCF).

B-ISDN ATM ADAPTATION LAYER SUBLAYERS: SERVICE SPECIFIC COORDINATION FUNCTION TO PROVIDE THE CONNECTION ORIENTED-TRANSPORT SERVICE

(Geneva, 1995)

1 Scope

This Recommendation specifies a function that is part of the ATM Adaptation Layer to support the OSI Connection Oriented Transport Service (COTS) within the B-ISDN. This function is used to map the service of the Service Specific Connection Oriented Protocol (SSCOP) of the AAL to the requirements of a Transport Service user as defined in Recommendation X.214 [7]. This function is called Service Specific Coordination Function to provide COTS (SSCF-COTS).

This Recommendation covers the specification of the SSCF identified in the complete AAL structure for connection oriented data communications defined in Recommendation I.363 [2] and describes the relationship to the protocol entity providing the Transport Service defined in Recommendation X.214 [7], the Service Specific Connection Oriented Protocol defined in Recommendation Q.2110 [4] and Layer Management.

This Recommendation is applicable to equipment to be attached to a B-ISDN User Network Interface (UNI) or B-ISDN Network Node Interface (NNI) when the OSI Connection Oriented Transport Service is to be supported.

2 Normative References

The following Recommendations and other references contain provisions which, through reference in this text, constitute provisions of this Recommendation. At the time of publication, the editions indicated were valid. All Recommendations and other references are subject to revision: all users of this Recommendation are therefore encouraged to investigate the possibility of applying the most recent edition of the Recommendations and other references listed below. A list of the currently valid ITU-T Recommendations is regularly published.

- [1] ITU-T Recommendation I.361 (1993), *B-ISDN ATM layer specification*.
- [2] ITU-T Recommendation I.363 (1993), *B-ISDN ATM Adaptation Layer (AAL) specification*.
- [3] ITU-T Recommendation Q.923 (1995), *Specification of a synchronization and coordination function for the provision of the OSI connection-mode network service in an ISDN environment*.
- [4] ITU-T Recommendation Q.2110 (1994), *B-ISDN ATM Adaptation Layer-Service Specific Connection Oriented Protocol (SSCOP)*.
- [5] ITU-T Recommendation X.200 (1994), *Information technology – Open Systems Interconnection – Basic reference model: The basic model*.
- [6] ITU-T Recommendation X.210 (1993), *Information technology – Open Systems Interconnection – Basic reference model: conventions for the definition of OSI services*.
- [7] ITU-T Recommendation X.214 (1993), *Information technology – Open Systems Interconnection – Transport service definition*.
- [8] ITU-T Recommendation X.223 (1993), *Use of X.25 to provide the OSI connection-mode network service for ITU-T applications*.

- [9] ITU-T Recommendation Q.2951 (1995), *Stage 3 description for number identification supplementary services using D-ISDN Digital Subscriber Signalling System No. 2 – Basic Call – Clause 8 – Sub-addressing (SUB)*.
- [10] ITU-T Recommendation Q.2957 (1995), *Stage 3 description for additional information transfer supplementary services using B-ISDN Digital Subscriber Signalling System No. 2 (DSS 2) – Basic Call – Clause 1 – User-to-User Signalling (UUS)*.
- [11] CCITT Recommendation X.650 (1992), *Open Systems Interconnection (OSI) – Reference model for naming and addressing*.
- [12] ISO/IEC ISP 10609-3: 1992, *Information technology – International Standardized Profiles TB, TC, TD and TE – Connection-mode Transport Service over connection-mode Network Service – Part 3: Subnetwork-type independent requirements for Group TD*.

3 Definitions

This Recommendation is based upon the concepts developed in Recommendation X.200 [5] and makes use of the following terms defined in that Recommendation:

- a) connection oriented;
- b) expedited data transfer;
- c) Transport Layer;
- d) Transport Service;
- e) Transport Service Access Point.

This Recommendation is based upon the concepts developed in Recommendation I.363 [2] and makes use of the following terms defined in that Recommendation:

- a) Asynchronous Transfer Mode Adaptation Layer;
- b) Common Part Convergence Sublayer;
- c) Segmentation and Reassembly Sublayer;
- d) Service Specific Convergence Sublayer.

Furthermore, this Recommendation is based upon the concepts developed in Recommendation Q.2110 [4] and makes use of the following terms defined in that Recommendation:

- a) Service Specific Coordination Function;
- b) Service Specific Connection Oriented Protocol.

4 Abbreviations

For the purposes of this Recommendation, the following abbreviations are used.

AAL	ATM Adaptation Layer
ATM	Asynchronous Transfer Mode
CC	Connection Establishment – Confirmation (PDU)
COTS	Connection Oriented Transport Service
CP	Common Part
CPCS	Common Part Convergence Sublayer
CR	Connection Establishment – Request (PDU)
DATA	(normal) Data (PDU)
DR	Connection Release – Disconnect (PDU)
ED	Expedited Data (PDU)
EDAK	Expedited Data Acknowledgement (PDU)
PCI	Protocol Control Information

PDU	Protocol Data Unit
QOS	Quality of Service
SAAL	AAL for Signalling
SAP	Service Access Point
SAR	Segmentation And Reassembly
SCF	Synchronization and Coordination Function
SDL	Specification and Description Language
SDU	Service Data Unit
SSCF	Service Specific Coordination Function
SSCS	Service Specific Convergence Sublayer
SSCOP	Service Specific Connection Oriented Protocol
SSCOP-UU	SSCOP User-to-User parameter
TS	(OSI) Transport Service
TSAP	(OSI) Transport Service Access Point
T-SDU	Transport Service Data Unit

5 Conventions

The primitives at the AAL type 5 SAP are conventionally called “AAL-primitives”. However, as defined in the General Descriptions (see 6) and shown in Figure 2, the SCF as defined in Recommendation Q.923 [3] is the immediate user of this AAL type 5 and the primitives there are defined in terms of T(u)-primitives, this Recommendation defines the primitives across the AAL type 5 SAP also as T(u)-primitives.

6 General Description

The Service Specific Coordination Function providing the Connection Oriented Transport Service (SSCF-COTS) resides in the Service Specific Convergence Sublayer (SSCS) of the ATM Adaptation Layer (AAL). It deploys the services provided by the Service Specific Connection Oriented Protocol (SSCOP) defined in Recommendation Q.2110 [4]. SSCOP also resides in the SSCS. Figure 1 illustrates the structure of the AAL.

The SSCF-COTS provides for the service that is requested by the Synchronization and Coordination Function (SCF) defined in Recommendation Q.923 [3]. This SCF in turn provides the Connection Oriented Transport Service (COTS) as defined in Recommendation X.214 [7]. The SCF also utilizes the signalling capabilities defined for the C-plane. Figure 2A illustrates the B-ISDN structure of the U-plane and C-plane for switched ATM connections. For permanent ATM connections, the SCF interfaces with the M-plane instead of with the C-plane; this situation is shown in Figure 2B.

Supplementary specifications for the SCF as required by Recommendation Q.923 [3] are defined in Annex E.

The definition of the SSCF-COTS takes into consideration the principles and terminology of Recommendations X.200 [5] and X.210 [6], the reference model and the service conventions for Open Systems Interconnection (OSI).

This Recommendation specifies:

- the interactions between the SSCF-COTS and the SCF sublayer;
- the interactions between the SSCF-COTS and the SSCOP sublayer;
- the interactions between the SSCF-COTS and the AAL management; and
- the peer-to-peer protocol that enhances the SSCOP service to provide the Connection Oriented Transport Service (COTS).

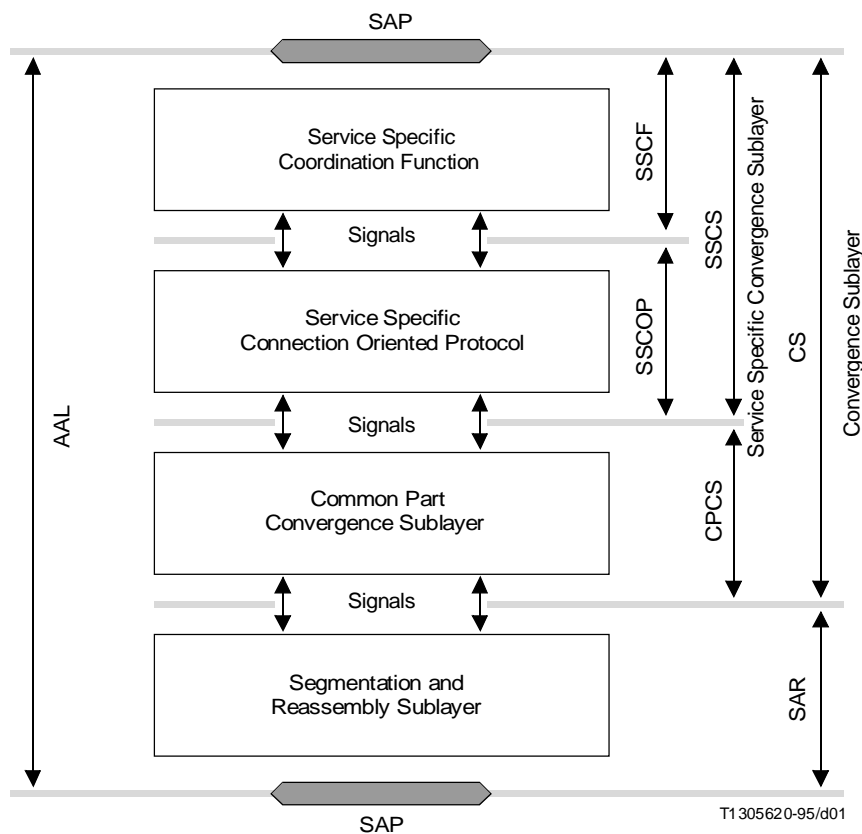

FIGURE 1/I.365.3

AAL structure

7 Services provided by the SSCF-COTS

The SSCF-COTS provides for the transparent transfer of data, i.e. SSCF-COTS user data between SSCF-COTS users. The supporting communication resources to achieve this transfer stay invisible to the SSCF-COTS user.

In particular, the SSCF-COTS service provides for:

- a) *Independence from the underlying transmission media*

The SSCF-COTS service relieves its users from all concerns of the manner in which the SSCF-COTS service is provided. Except for possible influences of the quality of service, the transfer of data over heterogenous underlying networks is, thus, invisible.

- b) *Transparency of the information transferred*

The SSCF-COTS service provides for the transparent transfer of octet-aligned SSCF-COTS user data and/or control information. It does not restrict the content, format, or coding of the information nor is there ever a need to interpret its structure or meaning.

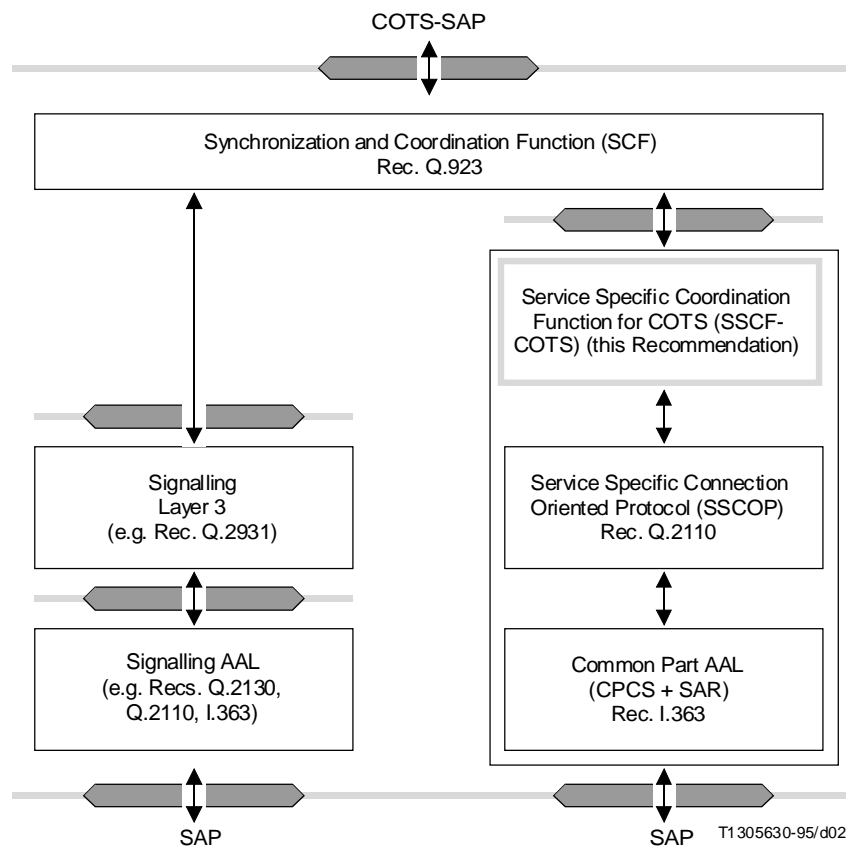

FIGURE 2A/I.365.3

Structure of the COTS provider deploying switched ATM connections

c) *Connection establishment and release*

The SSCF-COTS service assists the SSCF-COTS user in the connection establishment and release. During connection establishment, the “use” or “not use” of the optional Expedited Data service is selected. Simultaneous connection establishment from both sides leads to at most one connection.

d) *Quality of Service selection*

The SSCF-COTS service makes available to its users the means to request and agree to a quality of service for the transfer of SSCF-COTS user data. Quality of Service is specified by means of QOS-parameters representing characteristics such as throughput, transit delay, accuracy and reliability. Throughput and transit delay are subject to negotiation during connection establishment.

e) *SSCF-COTS user addressing*

The SSCF-COTS service utilizes a system of addressing (TSAP addressing) which allows SSCF-COTS users to refer unambiguously to one another.

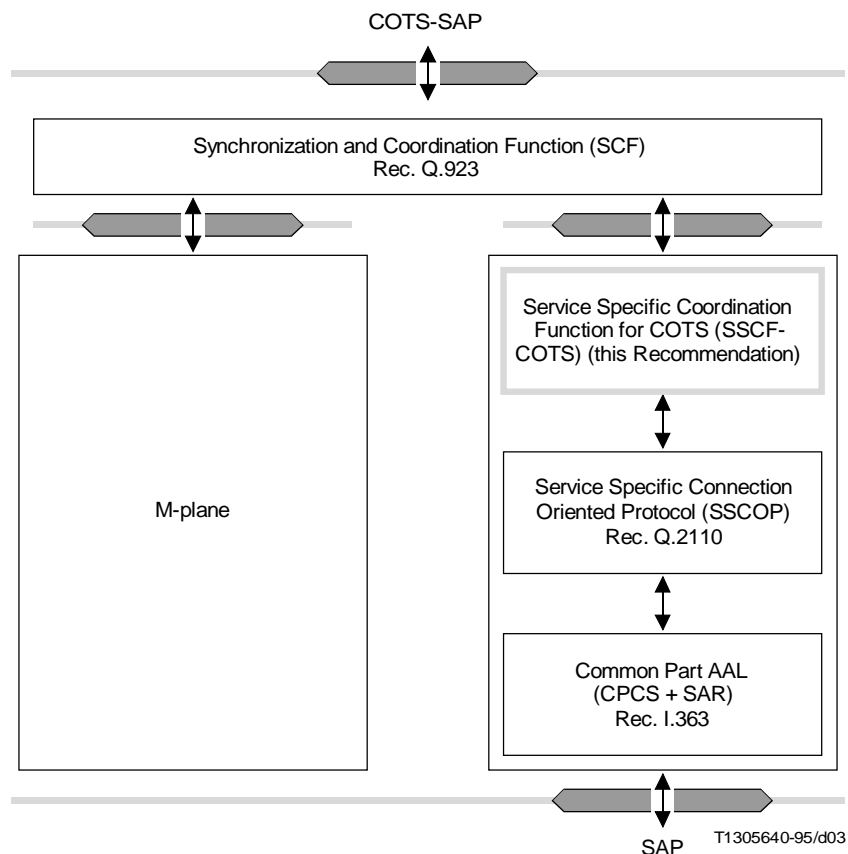

FIGURE 2B/I.365.3
Structure of the COTS provider deploying permanent ATM connections

8 Functions of the SSCF-COTS

The SSCF-COTS performs the following functions:

a) *Segmentation and Reassembly*

This function assures that the T-SDUs that exceed the maximum length dictated by the underlying sublayer specified in Recommendation Q.2110 [4] is segmented by the transmitting SSCF-COTS entity, transferred piece by piece and reassembled by the receiving SSCF-COTS entity.

b) *Error reporting to layer management*

This function reports errors which have occurred to layer management.

c) *Connection establishment*

This function provides for the establishment of a T(u)-connection.

NOTE – The connection below the sublayer specified in Recommendation Q.2110 [4] may be established either on demand or permanently.

d) *Connection release*

This function provides for the unconditional, and therefore possibly destructive, release of a T(u)-connection by either the SSCF-COTS user or the SSCF-COTS provider.

In addition, the following SSCOP services are utilized (see Recommendation Q.2110 [4]):

- e) Sequence Integrity of T-SDUs.
- f) Error Correction of T-SDUs.
- g) Flow Control of T-SDUs.
- h) Keep alive.
- i) Unassured data transfer.

The following function is a COTS service provider option:

- j) *Expedited data transfer*

This function provides the means of transferring separate expedited T-SDUs in sequence. Expedited T-SDUs are limited in length and their transmission is subject to a different flow control from normal data. Errors in the transfer of expedited T-SDUs are corrected by retransmission. This function is specified in Annex C.

9 Elements for layer-to-layer communication

This clause defines the primitives and signals and state transition diagram for sequences of signals between SSCF-COTS and SCF, SSCOP and Layer Management.

9.1 Primitives between SSCF-COTS and SCF

The primitives between SSCF-COTS and SCF are also defined in Recommendation Q.923 [3]; where there is a difference between the two definitions, the one in Recommendation Q.923 [3] is definitive.

The confirmed release configuration of SCF applies. The repertoire of T(u)-primitives between SCF and SSCF-COTS is defined in Table 1.

TABLE 1/I.365.3

Primitives and parameters between SCF and SSCF-COTS

Generic name	Type			
	request	indication	response	confirm
T(u)-CONNECT	called address calling address exp-data-sel TS-user-data Quality of Service	called address calling address exp-data-sel TS-user-data Quality of Service	responding address exp-data-sel TS-user-data Quality of Service	responding address exp-data-sel TS-user-data Quality of Service
T(u)-Disconnect	TS-user-data	reason TS-user-data	N/A	–
T(u)-DATA	TS-user-data	TS-user-data	N/A	N/A
T(u)-EXPEDITED-DATA (Note)	TS-user-data	TS-user-data	N/A	N/A
–	The primitive has no parameters	exp-data-sel	expedited data option	
N/A	The primitive is not defined			
NOTE – This primitive may only be used if the Expedited Data transfer option is implemented and has been selected at connection establishment.				

9.1.1 Definition of primitives

The definition of these primitives is as follows:

- a) T(u)-CONNECT

The T(u)-CONNECT primitives are used to establish a point-to-point connection for assured information transfer between peer user entities.

b) T(u)-DISCONNECT

The T(u)-DISCONNECT primitives are used to terminate a point-to-point connection for assured information transfer between peer user entities.

c) T(u)-DATA

The T(u)-DATA primitives are used for the assured point-to-point (normal) transfer of T-SDUs between peer user entities.

d) T(u)-EXPEDITED-DATA

The T(u)-EXPEDITED-DATA primitives are used for the assured point-to-point (expedited) transfer of T-SDUs between peer user entities.

9.1.2 Parameter definition

Table 1 lists the parameters associated with the T(u)-primitives. The definition of the parameters is as follows:

a) *TS-user-data*

During connection establishment and release, the parameter “TS-user-data” is used to transfer any integer number of octets of user data. The length of this parameter may be 0, i.e. no TS-user-data needs to be conveyed; the upper bound is determined by the capability of SSCOP (see Table B.1, parameter j).

In expedited data transfer, the parameter is used to carry any integer number of octets between 1 and 16 inclusive of COTS user’s expedited data constituting an expedited T-SDU.

In normal data transfer, the parameter is used to carry any integer number of octets greater than or equal to 1 of COTS user’s data constituting a T-SDU.

b) *Expedited data selection*

The parameter “expedited data selection” is used during connection establishment to negotiate the use of the expedited data transfer option. The value of this parameter is either “use of expedited data” or “no use of expedited data”.

c) *Reason*

The parameter “reason” is used during a connection release to indicate the reason for the action. The value of this parameter is summarized in Table 2.

TABLE 2/I.365.3

Value of the “reason” parameter

Primitive	Value of the “reason” parameter
T(u)-DISCONNECT-indication	normal condition lack of local or remote resources of the TS provider QOS below minimum level misbehaviour of TS provider called TS user unknown called TS user unavailable unknown reason

d) *Called address*

The called address parameter is used during connection establishment and conveys an address identifying the TSAP to which the connection is to be established.

e) *Calling address*

The calling address parameter is used during connection establishment and conveys the address of the TSAP from which the connection has been requested.

f) *Responding address*

The responding address parameter is used during connection establishment and conveys the address of the TSAP to which the connection has been established.

g) *Quality of Service*

The Quality of Service parameter is used during connection establishment to negotiate throughput and transit delay values. The T(u)-CONNECT-request primitive indicates “(sustained) target” and “minimum acceptable” values. The T(u)-CONNECT-indication primitive indicates “(sustained) available” and “minimum acceptable” values. The T(u)-CONNECT-response and the T(u)-CONNECT-confirm primitive indicate “selected” values.

NOTE – QOS parameters other than throughput and transit delay are not supported.

9.2 Signals between SSCF-COTS and SSCF-COTS Layer Management

The repertoire of MT(u)-signals between SSCF-COTS and SSCF-COTS Layer Management is defined in Table 3.

9.2.1 Signal definition

a) MT(u)-ERROR

The MT(u)-ERROR signal is used to report errors to the SSCF-COTS Layer Management.

b) MT(u)-STATE

The MT(u)-STATE signal is used to report state changes to the SSCF-COTS Layer Management.

c) MT(u)-REPORT

The MT(u)-REPORT signal is used to inform Layer Management of user data and control information exchanged with the SSCF-COTS’ peer entity.

d) MT(u)-DISCONNECT

The MT(u)-DISCONNECT signal is used to request the release of a T(u)-connection by the SSCF-COTS Layer Management.

TABLE 3/I.365.3

Signals and parameters between SSCF-COTS and SSCF-COTS Layer Management

Generic name	Type			
	request	indication	response	confirm
MT(u)-ERROR	N/A	code	N/A	N/A
MT(u)-STATE	N/A	state	N/A	N/A
MT(u)-REPORT	N/A	direction, type	N/A	N/A
MT(u)-DISCONNECT	–	N/A	N/A	N/A
–	The signal has no parameters			
N/A	The signal is not defined			

9.2.2 Parameter definition

a) *Code*

The parameter “code” indicates the actual error that is reported. The values of this parameter are summarized in Annex A.

b) *State*

The parameter “state” indicates the new state (according to Figure 5) to Layer Management.

c) *Direction*

The parameter “direction” indicates whether information was sent (“snd”) or received (“rcv”).

d) *Type*

The parameter “type” indicates the type of the information exchanged; it is represented by the following symbols:

CR	Connection Establishment – Request
CC	Connection Establishment – Confirmation
DR	Connection Release – Disconnect
DATA	(normal) Data
ED	Expedited Data
EDAK	Expedited Data Acknowledgement

9.2.3 States at the boundary between SSCF-COTS and Layer Management

At the boundary between SSCF-COTS and Layer Management, the following states are defined:

- *State 1 – Idle*
In this state, the T(u)-connection does not exist (or is currently releasing).
- *State 2 – Establishing*
In this state, the T(u)-connection is being established.
- *State 3 – Data Transfer Ready*
In this state, the T(u)-connection is in the Data Transfer state.

9.3 Signals between SSCF-COTS and SSCOP

The signals between SSCF-COTS and SSCOP are defined in Recommendation Q.2110 [4]. They are summarized in Table 4. If there is a difference between the summary and the definition in Q.2110 [4], the one in the Recommendation Q.2110 [4] is definitive.

Neither the data retrieval function nor the resynchronization function of SSCOP is used. Receipt of an AA-RESYNC-indication is treated as an error and the connection is released. Further, the parameter “BR” is always set to the value “YES”.

9.3.1 Definition of signals

- The AA-ESTABLISH signals are used to establish a point-to-point connection for assured information transfer between peer SSCF-COTS entities.
- The AA-RELEASE signals are used to terminate a point-to-point connection for assured information transfer between peer SSCF-COTS entities.
- The AA-DATA signals are used for the assured point-to-point transfer of SDUs between peer SSCF-COTS entities.
- The AA-RESYNC signals are used to resynchronize the SSCOP connection.
- The AA-RECOVER signals are used during recovery from protocol errors.
- The AA-UNITDATA signals are used for the non-assured transfer of SDUs between peer SSCF-COTS entities.

9.3.2 Parameter definition

- The Message Unit (MU) parameter is used during information transfer to convey a variable-length message. In AA-DATA-request and AA-UNITDATA-request signals, this parameter is mapped transparently into the information field of an SSCOP PDU. For AA-DATA-indication and AA-UNITDATA-indication signals, this parameter contains the contents of the information field of the received SSCOP PDU. The MU is an integral multiple of one octet.

TABLE 4/I.365.3

Signals and parameters between SSCF-COTS and SSCOP

Generic name	Type			
	request	indication	response	confirm
AA-ESTABLISH	SSCOP-UU BR	SSCOP-UU	SSCOP-UU BR	SSCOP-UU
AA-RELEASE	SSCOP-UU	SSCOP-UU Source	N/A	–
AA-DATA	MU	MU SN	N/A	N/A
AA-RESYNC (Note)	SSCOP-UU	SSCOP-UU	–	–
AA-RECOVER	N/A	–	–	N/A
AA-UNITDATA	MU	MU	N/A	N/A
– The signal has no parameters N/A The signal is not defined NOTE – Neither AA-RESYNC-request nor AA-RESYNC-response are used; receipt of an AA-RESYNC-indication is treated as an error and the T(u)-connection is released.				

- b) The SSCOP User-to-User (SSCOP-UU) parameter is used during connection control to convey a variable length user-to-user message. The transfer of SSCOP-UU in BGN, BGAK, BGREJ and END PDUs cannot be guaranteed. In request and response signals, this parameter is mapped transparently into the SSCOP-UU (SSCOP User-to-User) field of an SSCOP PDU. For indication and confirm signals, this parameter contains the contents of the SSCOP-UU field of the received SSCOP PDU. The SSCOP-UU is an integral multiple of one octet, if it is present. The SSCOP-UU may be null (no data present).
- c) The Sequence Number (SN) parameter is ignored by the SSCF-COTS entity.
- d) The Buffer Release (BR) parameter is not used by the SSCF-COTS entity; its value is always set to “YES”.
- e) The Source parameter indicates to the SSCF-COTS entity whether the SSCOP layer or the peer SSCF-COTS entity originated the connection release. This parameter may take on one of two values: “SSCOP” or “User”; if the value is “User”, the peer SSCF-COTS entity is the originator.

9.4 State transition diagram for sequences of signals at the layer boundaries of SSCF-COTS

This subclause defines the constraints on the sequences in which the signals may occur at the layer boundaries of SSCF-COTS. The sequences are related to the states at one point-to-point SSCF-COTS endpoint, between the SCF and SSCF-COTS and between SSCF-COTS and SSCOP.

The possible overall sequences of signals at a point-to-point SSCF-COTS connection endpoint are shown in the state transition diagram, Figure 3, for the convenience of the reader. These primitives and state transitions are defined in Recommendation Q.923 [3]. If any discrepancy is detected between the representation here and the one in Recommendation Q.923 [3], the definition in Q.923 [3] shall apply.

The possible overall sequences of signals at a point-to-point SSCOP endpoint are shown in the state transition diagram, Figure 4, for the convenience of the reader. These signals and state transitions are defined in Recommendation Q.2110 [4]. If any discrepancy is detected between the representation here and the one in Recommendation Q.2110 [4], the definition in Q.2110 [4] shall apply.

The model illustrates the behaviour of SSCF-COTS as seen by the SCF or the subset of behaviour of the SSCOP as deployed by the SSCF-COTS. This model assumes that a request or response signal is never issued at the same time as an indication or confirm signal. The model also assumes that the signals are serviced immediately and in zero time. In the diagram:

- a) Any primitive which is not shown as resulting in a transition (from one state to the same state, or from one state to a different state) is not permitted in that state.
- b) It is assumed that the primitives passed between SCF and SSCF-COTS as well as the signals passed between the SSCF-COTS and SSCOP are coordinated such that collisions do not occur.
- c) The IDLE state (state 1) reflects the absence of a connection. It is the initial and final state of any sequence and once it has been re-entered, the connection is released.

The possible overall sequences of signals at the Layer Management boundary of SSCF-COTS is shown in the state transition diagram, Figure 5. The states 1 to 3 in Figure 5 are defined in 9.2.3.

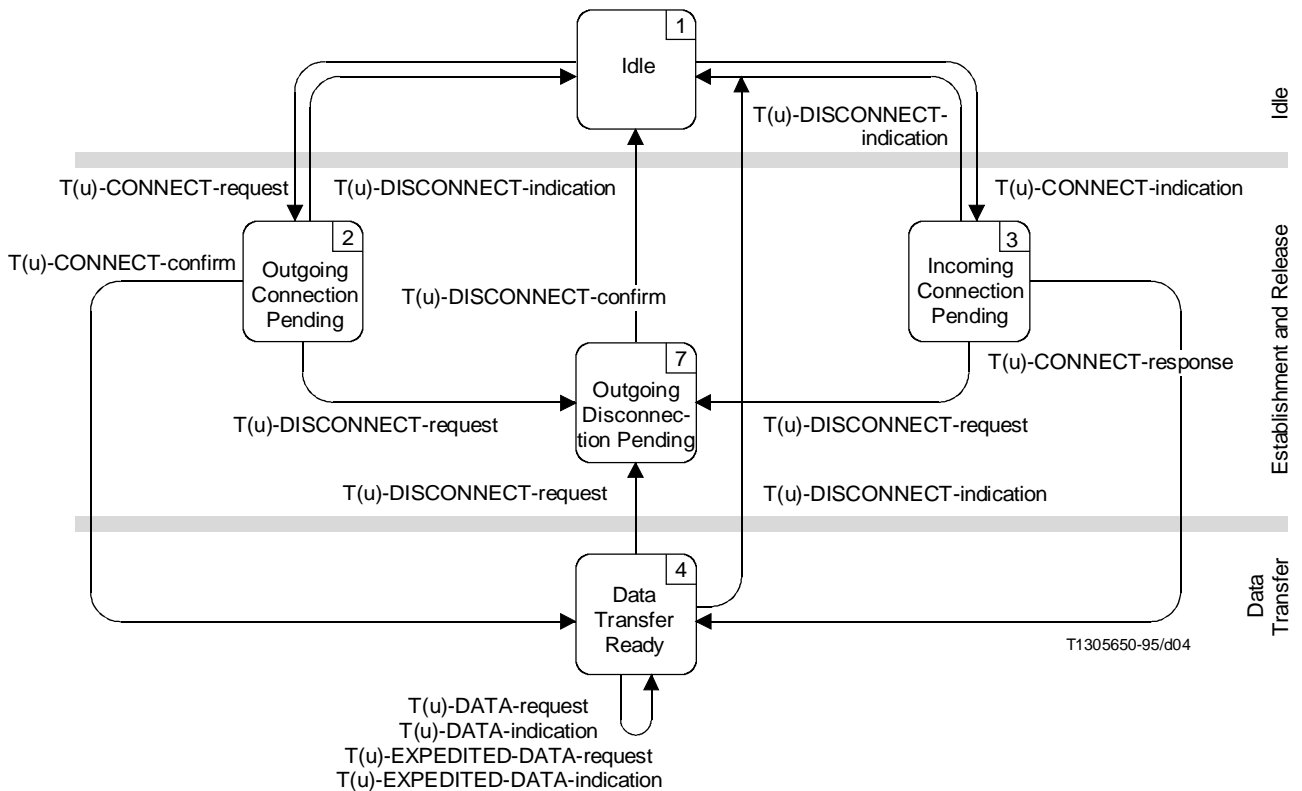

FIGURE 3/I.365.3

State transition diagram for sequences of primitives between SCF and SSCF-COTS

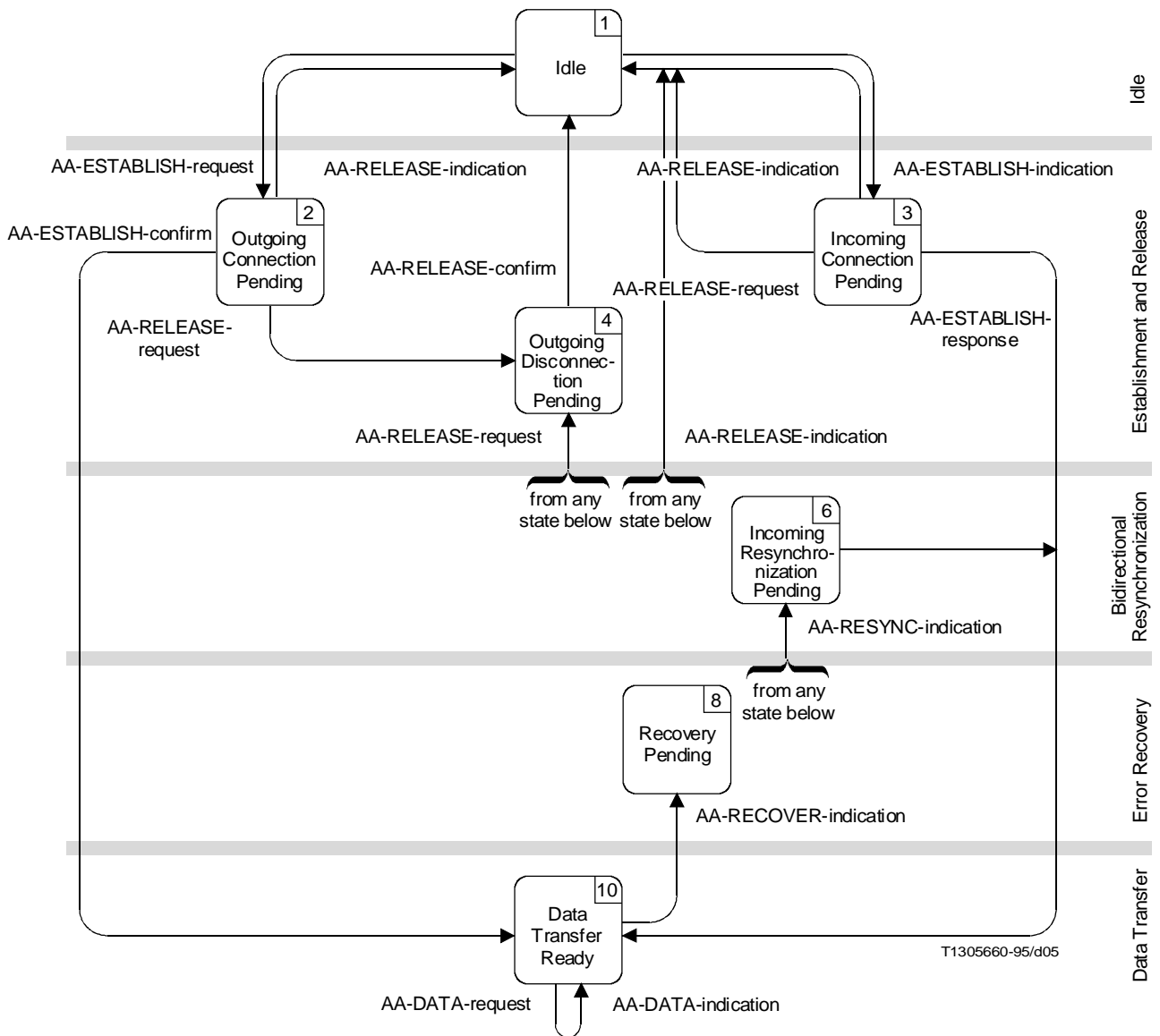

FIGURE 4/I.365.3
State transition diagram for sequences of signals between SSCF-COTS and SSCOP

10 Protocol elements for peer-to-peer communication

The peer-to-peer SSCF-COTS protocol utilizes the mechanisms provided by the underlying sublayer (SSCOP, Recommendation Q.2110 [4]). In particular:

- Connection establishment and release use the corresponding service of SSCOP, i.e. the signals AA-ESTABLISH and AA-RELEASE. Additional information is conveyed via the SSCOP-UU parameter.
- Normal data transfer utilizes SSCOP's assured data transfer service including the imbedded flow control mechanism.

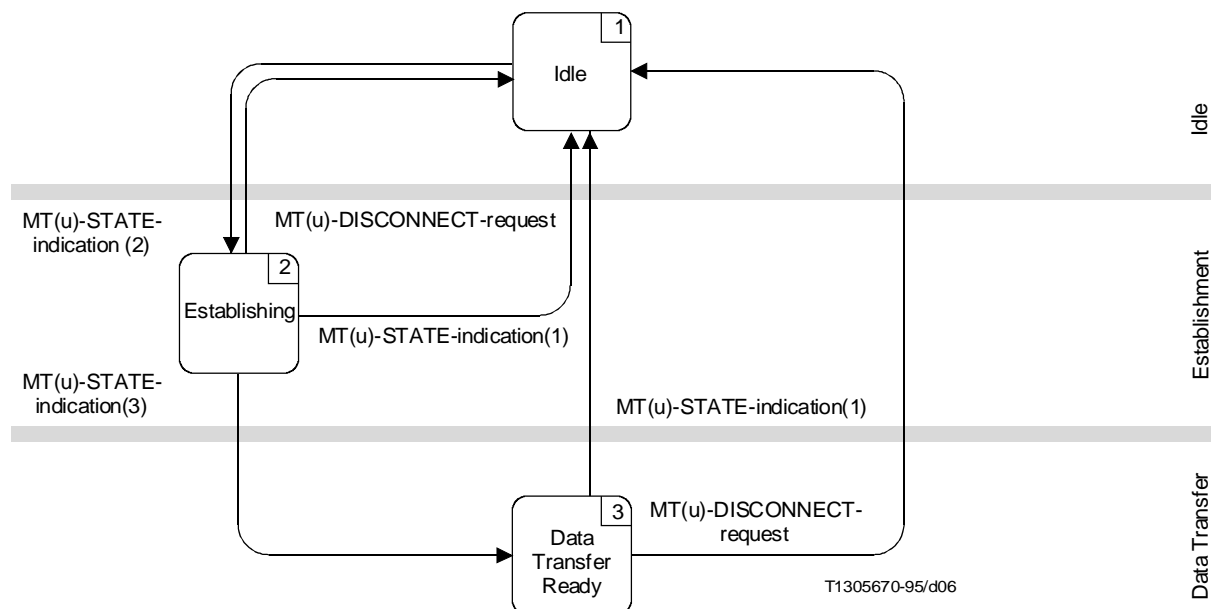

FIGURE 5/I.365.3

State transition diagram for sequences of signals between SSCF-COTS and Layer Management

- The use of SSCOP's resynchronization service by the peer SSCF-COTS entity is an error and is mapped into a TS-provider initiated connection release.
- SSCOP's error recovery service is mapped into a TS-provider initiated connection release.
- SSCOP's data retrieval service is not used, i.e. SSCF-COTS never issues the signals AA-RETRIEVE-request and, hence, never receives the signals AA-RETRIEVE-indication and AA-RETRIEVE-COMplete-indication.

For the implementation of the optional SSCF-COTS service, SSCOP services are utilized as follows:

- The expedited data transfer service makes use of the unassured data stream that is independent of the flow control of the assured service. Error recovery from transmission errors by retransmission and a separate flow control is handled by a peer-to-peer protocol within the SSCF-COTS sublayer. The SSCOP signal used is AA-UNITDATA.

10.1 SSCF-COTS PDUs

The repertoire of PDUs is shown in Table 5.

10.1.1 SSCF-COTS PDUs utilizing the unassured data transfer

SSCF-COTS PDUs utilizing the unassured data transfer are only deployed if the Expedited Data transfer option is implemented and has been selected at connection establishment.

10.1.2 SSCF-COTS PDUs utilizing the assured data transfer

There is one SSCF-COTS PDU utilizing the assured data transfer:

- *DATA PDU*

The DATA PDU is used to transfer T-SDUs between peer SSCF-COTS user entities. T-SDUs may be segmented to adjust the DATA PDU size to the requirements of the maximum PDU length defined for the underlying SSCOP sublayer.

If the Expedited Data transfer option is implemented and has been selected at connection establishment, the DATA PDU also carries synchronization information to allow the receiving SSCF-COTS entity to assure that regular data does not bypass expedited data. The fields carrying this information are N(E) and N(TS).

TABLE 5/I.365.3

Repertoire of SSCF-COTS PDUs

PDU name	Description
CR PDU CC PDU DR PDU	Connection Establishment – Request Connection Establishment – Confirmation Connection Release – Disconnect
DATA PDU	(normal) Data
ED PDU EDAK PDU	Expedited Data Expedited Data Acknowledgement

10.1.3 SSCF-COTS PDUs utilizing data transfer capabilities in SSCOP connection control services

- *Connection request and confirmation PDUs*

The CR PDU and CC PDU are used for the exchange of T(u)-connection parameters and TS-user-data during the simultaneous connection establishment of SSCF-COTS and SSCOP. The CR PDU is communicated via the SSCOP-UU parameter in the AA-ESTABLISH-request and AA-ESTABLISH-indication signals. The CC PDU is communicated via the SSCOP-UU parameter in the AA-ESTABLISH-response and AA-ESTABLISH-confirm signals.

- *Disconnect request PDU*

The DR PDU is used for the disconnect service to communicate TS-user-data and the reason for the disconnection. The DR PDU is communicated via the SSCOP-UU parameter in the AA-RELEASE-request and AA-RELEASE-indication signals.

10.2 SSCF-COTS PDU formats

Figures 6 to 8 illustrate the format of the SSCF-COTS PDUs utilized for the mandatory SSCF-COTS services.

10.2.1 Coding conventions

The coding of the SSCF-COTS PDUs conforms to the coding conventions specified in 2.1/I.361 [1].

NOTE – SSCF-COTS is trailer oriented the same as SSCOP, i.e. the Protocol Control Information (PCI) is transmitted last.

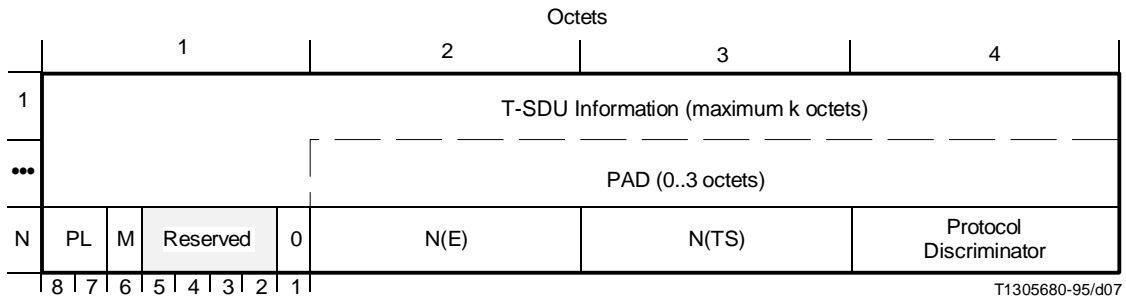
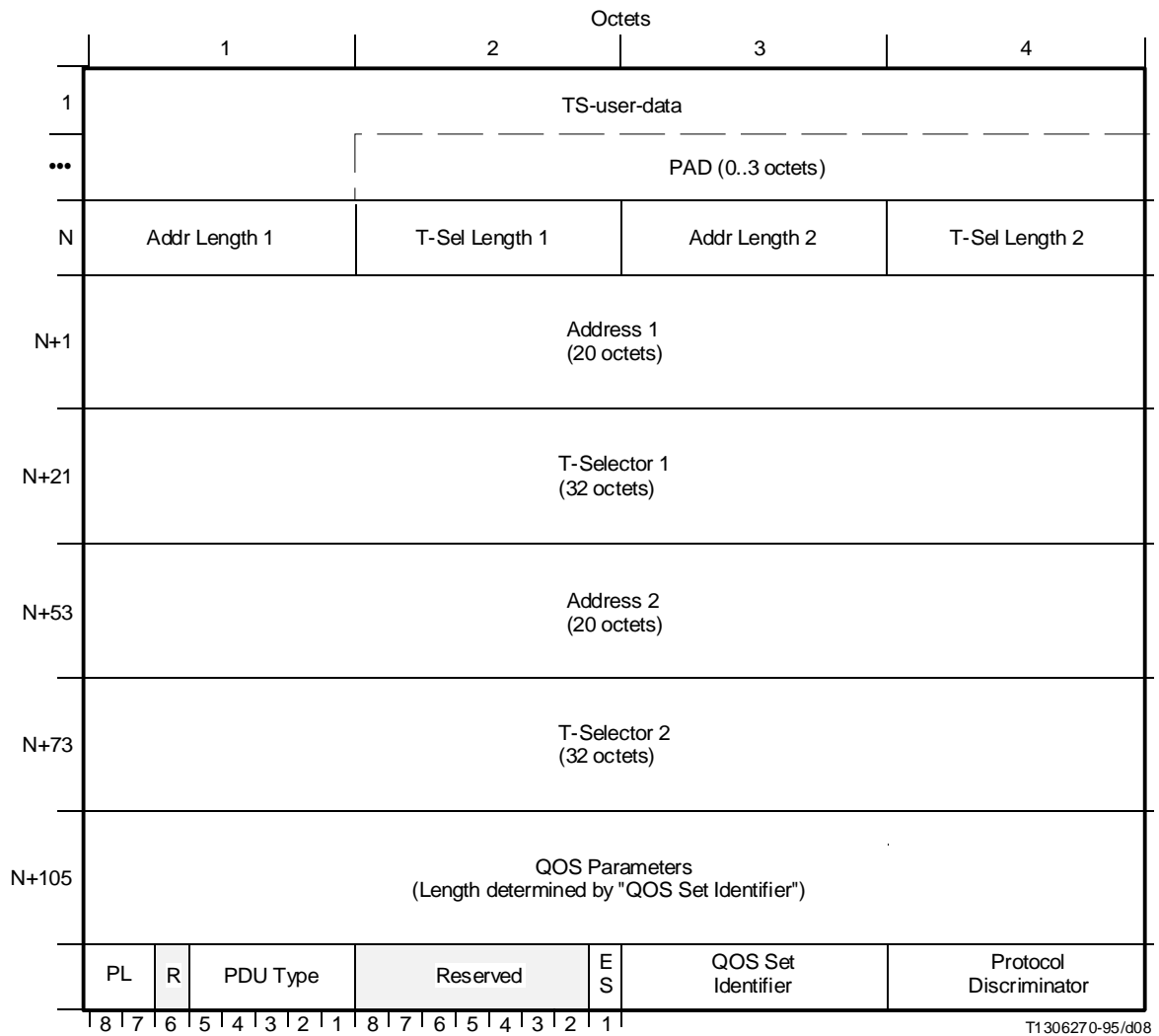

FIGURE 6/I.365.3
T-SDU information (DATA PDU)



NOTE – The mechanism to derive the T-Selector and the (NSAP-) address from the address in the T-CONNECT primitives is an implementation matter.

FIGURE 7/I.365.3
Connection establishment: CR PDU and CC PDU

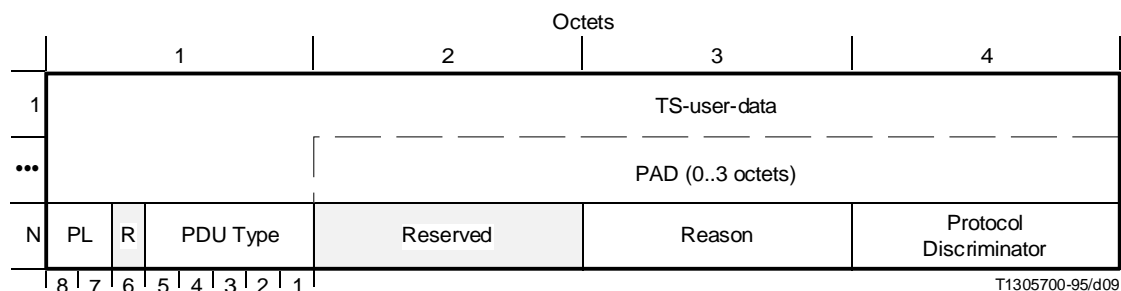

FIGURE 8/I.365.3
Connection release: DR PDU

10.2.2 PDU length

The maximum length of the information field in the DATA PDU is k octets. The maximum value of k is 65 524 octets. The value of k is established as part of size negotiation procedures outside SSCF-COTS or upon bilateral agreement. It may depend on the error characteristics of the layers below the AAL. The minimum value of k is 256.

10.3 SSCF-COTS PDU fields

The SSCF-COTS PDUs contain the following fields:

a) *T-SDU Information field*

The T-SDU Information field in the DATA PDU contains (part of) a T-SDU.

b) *TS-user-data field*

The TS-user-data field in the CR PDU, CC PDU, or DR PDU contains the value of the TS-user-data parameter of the T(u)-CONNECT or T(u)-DISCONNECT primitive. The maximum length of this field is the maximum length of the SSCOP-UU parameter in the AA-ESTABLISH and AA-RELEASE primitives minus the SSCF-COTS PCI information depicted in Figure 7 (see Table B.1, parameter j).

c) *M – More Data field*

The M field in the DATA PDU is set to “1” if a T-SDU is segmented and the information field does not carry the last part of the T-SDU; otherwise, it is set to “0”.

d) *Reason – Reason field*

The Reason field in the DR PDU conveys the information about the reason for the primitive between the two peer SSCF-COTS entities. The coding is shown in Table 6.

e) *N(E) – Expedited Data Synchronization field*

The N(E) field in the DATA PDU is used for the synchronization of normal and expedited data. If the Expedited Data transfer option is not implemented or has not been selected at connection establishment, this field is treated like a “Reserved” field [see item t)].

f) *ES – Expedited Data Transfer Selection field*

The ES field in the CR PDU or CC PDU is used for the Expedited Data Transfer selection between the two peer SSCF-COTS entities. If the Expedited Data transfer option is not implemented, this field is treated like a “Reserved” field [see item t)].

g) *Address Length 1*

This field specifies the length in octets of the NSAP address contained in the Address 1 field.

TABLE 6/I.365.3

SSCF-COTS PDU field coding

Field	Code	Value
Reason field	0	Reserved
AA-RELEASE request	1	Normal condition
AA-RELEASE indication	2	Lack of local or remote resources of the TS provider
	3	QOS below minimum level
	4	Misbehaviour of TS provider
	5	Called TS user unknown
	6	Called TS user unavailable
	7	Unknown reason

h) *Address 1 field*

In the CR PDU, the Address 1 field carries the called party NSAP address; in the CC PDU and the DR PDU, the responding party NSAP address is carried. The called resp. responding NSAP address shall be coded according to the “preferred binary encoding” defined in Recommendation X.214 [7]. Example codings are given in Recommendation X.223 [8].

i) *T-Sel Length 1*

This field specifies the length in octets of the T-Selector in the T-Selector 1 field.

j) *T-Selector 1*

In the CR PDU, the T-Selector 1 field carries the T-Selector part of the called address supplied by the Transport user [11]; in the CC PDU, the T-Selector part of the responding address is carried. The semantics and coding of this field is specified by the local administration of the called resp. responding end system [12].

k) *Address Length 2*

In the CR PDU, this field specifies the length in octets of the NSAP address contained in the Address 2 field. In the CC PDU, the field is treated like a “Reserved” field [see item t)].

l) *Address 2 field*

In the CR PDU, the Address 2 field carries the calling party NSAP address. The calling NSAP address shall be coded according to the “preferred binary encoding” defined in Recommendation X.213 [7]. Example codings are given in Recommendation X.223 [8]. In the CC PDU, the field is treated like a “Reserved” field [see item t)].

m) *T-Sel Length 2*

This field specifies the length in octets of the T-Selector in the T-Selector 2 field; in the CC PDU, the field is treated like a “Reserved” field [see item t)].

n) *T-Selector 2*

In the CR PDU, the T-Selector 2 field carries the T-Selector part of the calling address supplied by the Transport user [11]; the CC PDU, the field is treated like a “Reserved” field [see item t)]. The semantics and coding of this field is specified by the local administration of the calling end system [12].

o) *Address 2 field*

In the CR PDU, the Address 2 field carries the called party TSAP address; in the CC PDU, the field is treated like a “Reserved” field [see item t)].

p) *QOS Set Identifier field*

The QOS Set Identifier field is defined in Annex D.

q) *QOS Parameters*

The QOS Parameters are defined in Annex D.

r) *PAD – PAD field*

Between the end of the T-SDU Information field in the DATA PDU or the Expedited T-SDU Information field in the ED PDU, or the TS-user-data in the CR PDU, CC PDU, or DC PDU and the PCI trailer, there are from 0 to 3 unused octets. These unused octets are called the Padding (PAD) field; they are strictly used as filler octets and do not convey any information. Any coding is acceptable. This Padding field complements the PDU to an integral number of 4 octets.

s) *PL – PAD Length field*

The PL field in the PDU indicates the number of octets in the Padding field present. It can take on any integer value from 0 to 3 inclusive.

t) *R – Reserved field*

There is one or two fields of reserved bits (R, Reserved) in each PDU. One function of the Reserved field is to achieve 32 bit alignment. Other functions are for further study. Where no functions other than 32 bit alignment are defined, the fields shall be coded as “0” and shall be ignored by the receiver.

u) *PDU Type field*

The PDU Type field carries identification to unambiguously determine the type of the PDU. The coding is shown in Table 7. Where not needed, this field is not verified by the receiving SSCF-COTS entity.

NOTE 1 – The PDU Type field is redundant in those cases where the SSCOP signal already determines the type of the PDU; the PDU Type field is retained and checked also in those cases for consistency with implementations on services other than SSCOP.

v) *Protocol Discriminator field*

The Protocol Discriminator field is reserved for a Protocol Discriminator and treated like a “Reserved” field [see item t)].

NOTE 2 – In the future, this parameter may be used to discriminate SSCF-COTS from future versions of the SSCF-COTS protocol or other protocols which use the last octet of the trailer as a protocol discriminator.

w) *N(TS) – Data Transfer State Sequence Number field*

In the DATA PDU, this field carries the current value of the transmitter state variable VT(TS). If the Expedited Data transfer option is not implemented or has not been selected at connection establishment, this field is treated like a “Reserved” field [see item t)].

TABLE 7/I.365.3

SSCF-COTS PDU names and coding of the PDU Type field

PDU name	PDU type field	Description
CR PDU CC PDU DR PDU	00001 00011 00101	Connection Establishment – Request Connection Establishment – Confirmation Connection Release – Disconnect
DATA PDU	xxxx0	(normal) Data
ED PDU EDAK PDU	00111 01001	Expedited Data Expedited Data Acknowledgement

10.4 SSCF-COTS state variables

This subclause describes the state variables used in the specification of the SSCF-COTS peer-to-peer protocol. The DATA PDUs are sent via the assured data transfer service of SSCOP, no sequencing information needs to be added.

10.4.1 Transmitter state variables

The state variables at the transmitter to support the Expedited Data Transfer option are defined in Annex C. Otherwise, the SSCF-COTS maintains no state variables at the transmitter.

10.4.2 Receiver state variables

The state variables at the receiver to support the Expedited Data Transfer option are defined in Annex C. Irrespective of the use of this option, the SSCF-COTS maintains the following state variables at the receiver:

- *Reassembly Buffer*

This state variable provides for the mechanism to reassemble a segmented T-SDU; its size is application dependent.

10.4.3 Common state variables

The SSCF-COTS maintains the following common state variables at the transmitter and receiver:

- *EDsel*

If the Expedited Data transfer option is not implemented or has not been selected at connection establishment, this state variable is fixed at the value “0”.

NOTE – In the absence of the implementation of the optional service, the items described above are not “variables” in the usual sense. They are introduced here to allow for their use in the SDL diagrams (see 11.3).

10.5 SSCF-COTS timers

In the absence of options, the SSCF-COTS entity supports no timers. The timers to support the Expedited Data Transfer option are defined in Annex C.

10.6 SSCF-COTS protocol parameter

The value of each SSCF-COTS protocol parameter is application specific and may be defined in other ITU-T Recommendations which reference this Recommendation. The following SSCF-COTS protocol parameter is defined:

- *MaxDATALength*

The protocol parameter MaxDATALength defines the maximum length of the information field of a DATA PDU. It is used during T-SDU segmentation. The value must be an integral multiple of 4; the value shall be between 256 and 65 524 inclusive.

11 Specification of the SSCF-COTS

This clause provides a set of SDL diagrams defining the procedures of the U-plane Service Specific Coordination Function (SSCF-COTS). These SDL diagrams are the definitive description of the procedures and in case of conflict with the text, the SDL diagrams take precedence.

11.1 Overview

Figure 9 gives an overview over the states of SSCF-COTS and the major transitions between them. These states are grouped into communication control services.

These states are used in the specification of the peer-to-peer protocol. The states are conceptual and reflect general conditions of the SSCF-COTS entity in the sequences of signals and PDU exchanges with its user, peer, underlying sublayer, or Layer Management. In addition, other conditions are used in the description in order to avoid the identification of additional states, as detailed in the SDL diagrams (see 11.2).

The state numbers reflect the state of the interfaces at the three layer boundaries of SSCF-COTS. They are of the form “U.L.M” where “U” represents the state of the interface at the upper layer boundary (see Figure 3), “L” the one at the lower layer boundary (see Figure 4) and “M” at the Layer Management boundary (see Figure 5).

11.1.1 Idle

State 1.1.1 Idle

In this state, no connection is established. No data may be communicated.

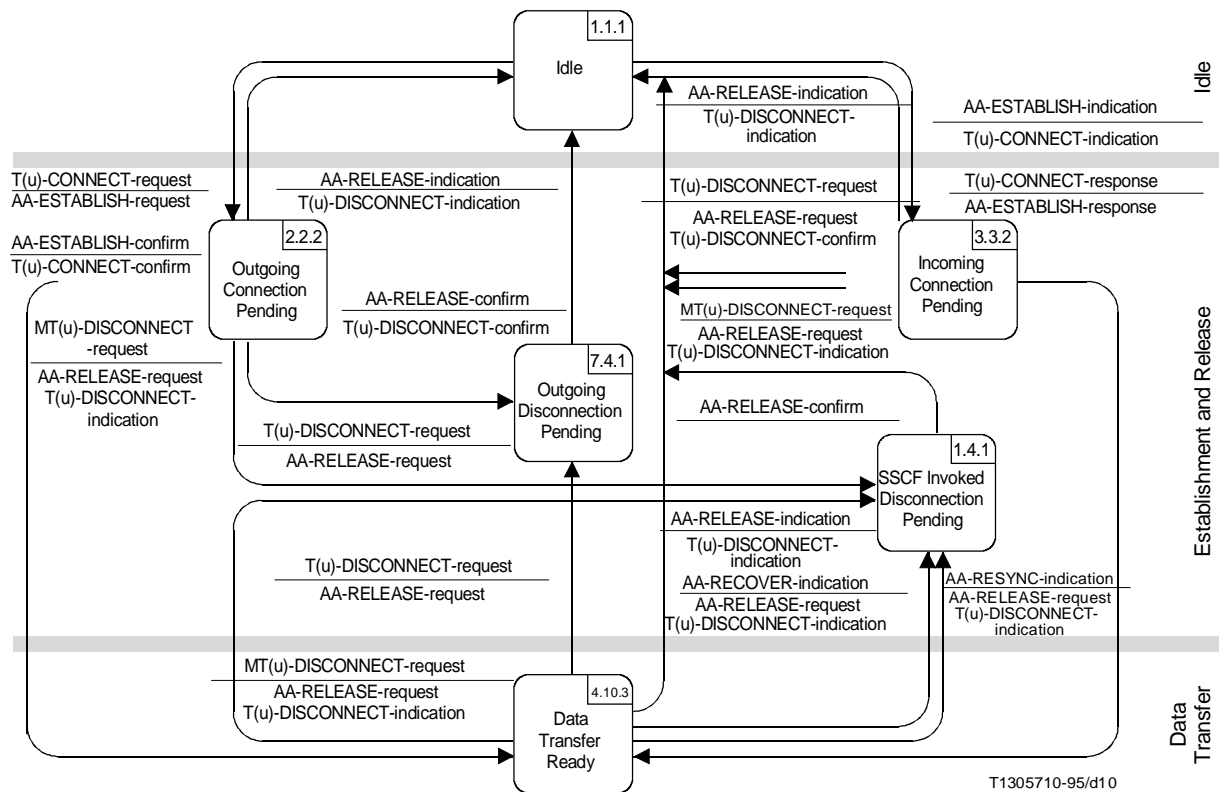

NOTE – No indications to Layer Management are shown.

FIGURE 9/I.365.3
Overview of SSCF-COTS states and major transition between states

11.1.2 Establishment and release

The states in this connection control service assist SCF and Layer Management in establishing and releasing T-connections. Establishment and release takes precedence over the Data Transfer connection control service. The following states are defined:

State 2.2.2 Outgoing Connection Pending

In this state, the local SCF instructed SSCF-COTS to establish a new connection with its peer and awaits the peer's response.

State 3.3.2 Incoming Connection Pending

In this state, SSCF-COTS received the indication that its peer wants to establish a new connection and has notified the SCF. SSCF-COTS is awaiting the response from the SCF.

State 7.4.1 Outgoing Disconnection Pending

In this state, the SCF has instructed the SSCF-COTS to release the current connection. SSCF-COTS awaits confirmation from its peer.

State 1.4.1 SSCF Invoked Disconnection Pending

In this state, Layer Management has instructed the SSCF-COTS to release the current connection. SSCF-COTS awaits confirmation from its peer.

NOTE – This state is also entered if either an AA-RESYNC-indication or an AA-RECOVER-indication signal was received.

11.1.3 Data transfer

The state in this connection control service allows data transfer.

State 4.10.3 Data Transfer Ready

In this state, data transfer takes place.

If the Expedited Data transfer option is implemented and has been selected at connection establishment, the Expedited Data service procedure is running and may leave state E1.

11.2 State transition table

The State Transition Table (Table 8) for SSCF-COTS describes the primitives and signals that lead to state transitions. The table only shows the major transition paths; the SDL diagrams in 11.3 show the full transitions.

11.3 SDL diagrams

The SDL diagrams are represented in Figures 10 to 12.

NOTE – Macros defined in Annex C can be ignored if the Expedited Data option is not implemented.

TABLE 8/I.365.3

State transition table

Event	State					
	1.1.1	7.4.1	1.4.1	2.2.2	3.3.2	4.10.3
T(u)-CONNECT-request	AA-ESTABLISH-request 2.2.2	–	(Note 1)	–	–	–
T(u)-CONNECT-response	–	–	–	–	AA-ESTABLISH-response 4.10.3	–
T(u)-DISCONNECT-request	–	–	–	AA-RELEASE-request 7.4.1	AA-RELEASE-request T(u)-DISCONNECT-confirm 1.1.1	AA-RELEASE-request 7.4.1
T(u)-DATA-request	–	–	–	–	–	AA-DATA-request 4.10.3
MT(u)-DISCONNECT-request	–	–	–	T(u)-DISCONNECT-indication AA-RELEASE-request 1.4.1	T(u)-DISCONNECT-indication AA-RELEASE-request 1.1.1	T(u)-DISCONNECT-indication AA-RELEASE-request 1.4.1
AA-ESTABLISH-indication	T(u)-CONNECT-indication 3.3.2	–	–	–	–	–

TABLE 8/I.365.3 (continued)

Event	State					
	1.1.1	7.4.1	1.4.1	2.2.2	3.3.2	4.10.3
AA-ESTABLISH-confirm	–	–	–	T(u)-CONNECT-confirm 4.10.3	–	–
AA-RELEASE-indication	–	–	–	T(u)-DISCONNECT-indication 1.1.1	T(u)-DISCONNECT-indication 1.1.1	T(u)-DISCONNECT-indication 1.1.1
AA-RELEASE-confirm	–	T(u)-DISCONNECT-confirm 1.1.1	1.1.1	–	–	–
AA-RESYNC-indication	–	–	–	–	–	T(u)-DISCONNECT-indication AA-RELEASE-request 1.4.1
AA-RECOVER-indication	–	–	–	–	–	T(u)-DISCONNECT-indication AA-RELEASE-request 1.4.1
AA-DATA-indication	–	–	–	–	–	T(u)-DATA-indication 4.10.3
AA-UNITDATA-indication	(Note 3) 1.1.1	(Note 3) 7.4.1	(Note 3) 1.4.1	(Note 3) 2.2.2	(Note 3) 3.3.2	(Note 4) 4.10.3
error	(Note 2) 1.1.1	–	–	T(u)-DISCONNECT-indication AA-RELEASE-request 1.4.1	–	4.10.3

NOTES

- 1 This event is legal in this state; however, if this event occurs, its action is deferred until the current state has been left.
- 2 If the error was detected after receipt of a T(u)-CONNECT-request primitive, the T(u)-DISCONNECT-indication primitive is issued; if the error was detected after receipt of an AA-ESTABLISH-indication signal, the AA-RELEASE-request signal is issued.
- 3 In this state, all AA-UNITDATA-indication signals are legal; however, they are ignored.
- 4 In this state, the PDU Type field of the “MU” parameter (i.e. the possible PDU) is decoded. If the Expedited Data transfer option is not implemented or has not been selected at connection establishment and an ED PDU or EDAK PDU is detected, as well if the PDU field is unrecognizable, an error is indicated to Layer Management.
- 5 No indications to Layer Management are shown.

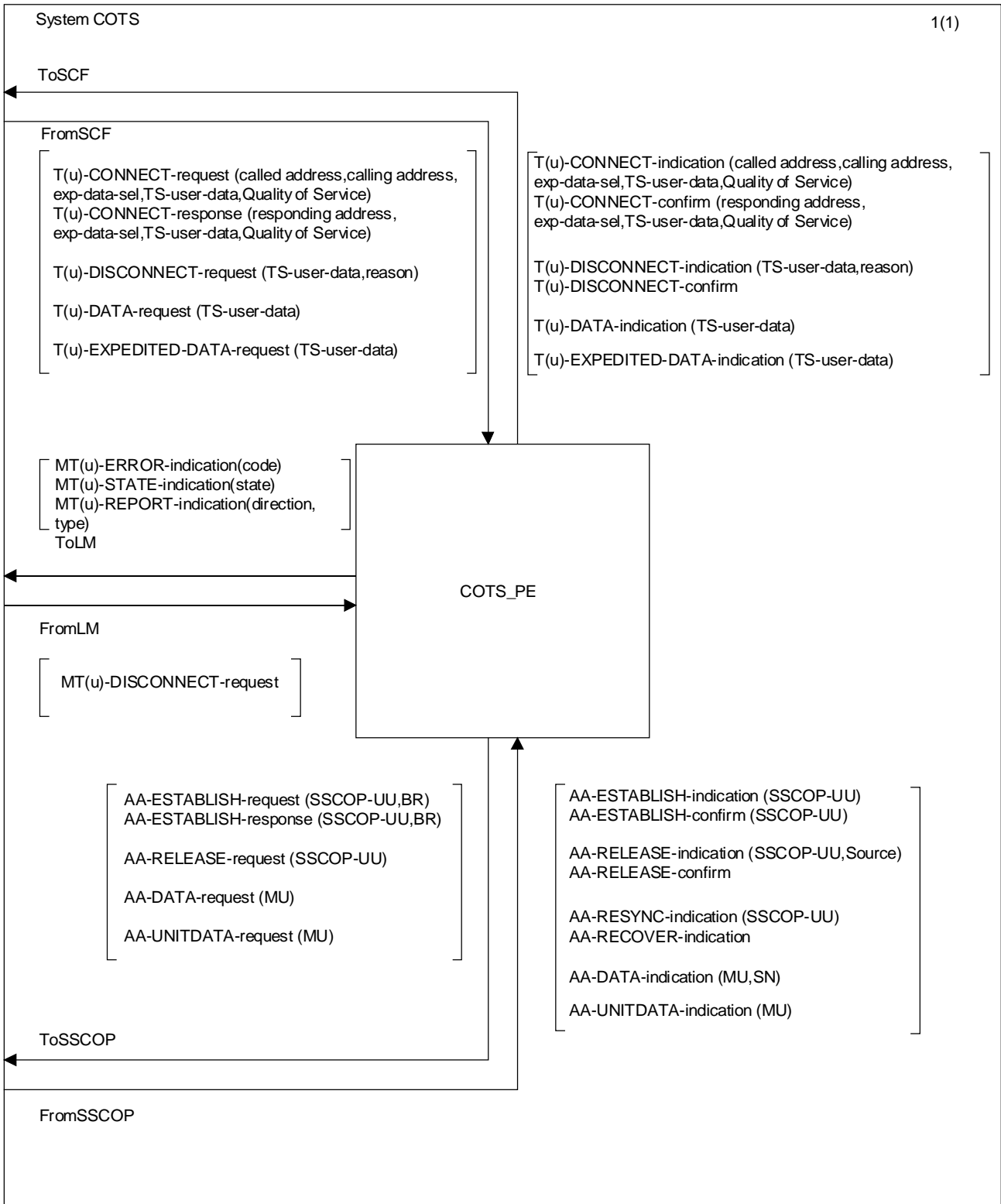

T1305720-95/d11

FIGURE 10/I.365.3
System SSCF-COTS SDL diagram

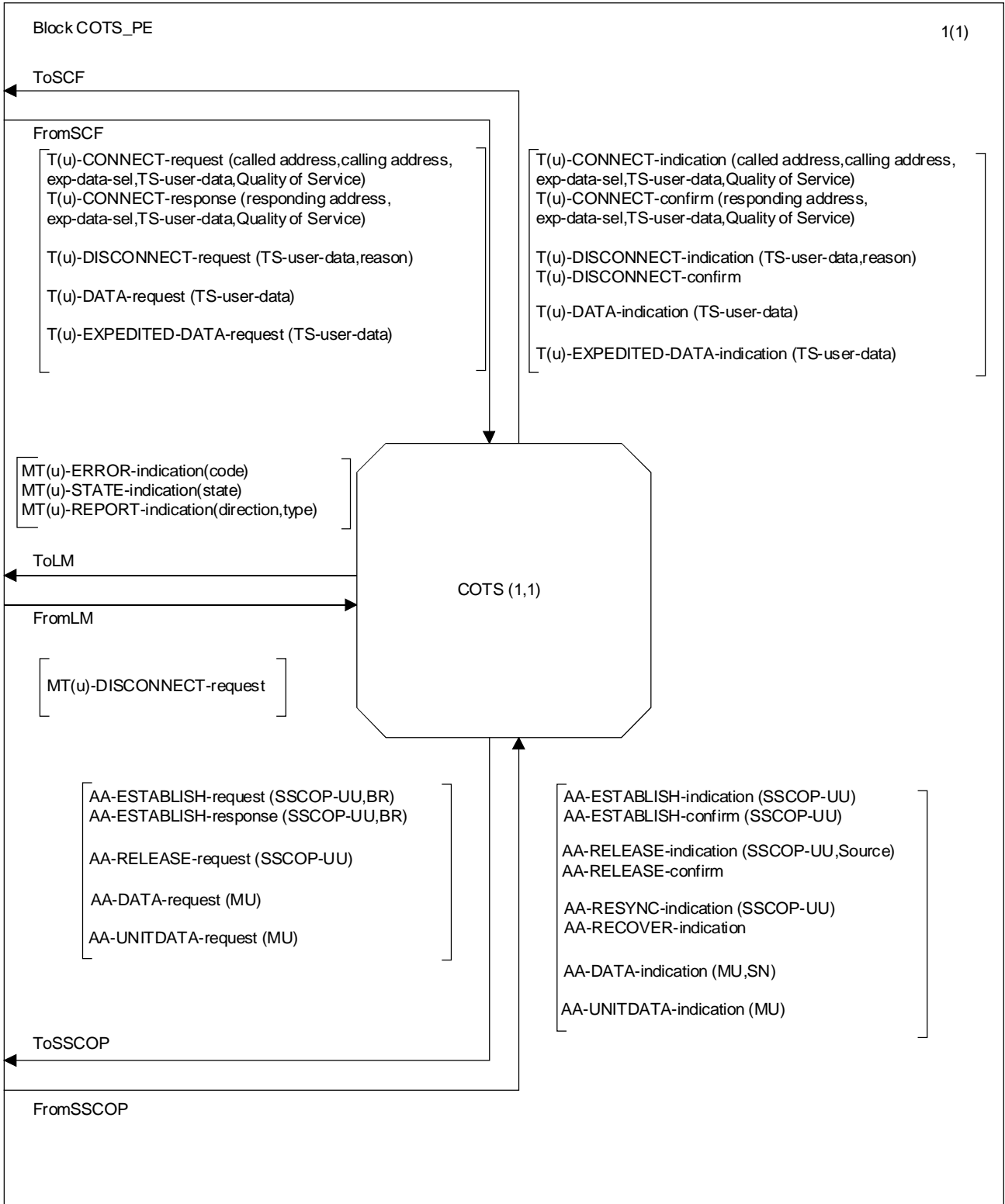

T1305730-95/d12

FIGURE 11/I.365.3
Block SSCF-COTS SDL diagram

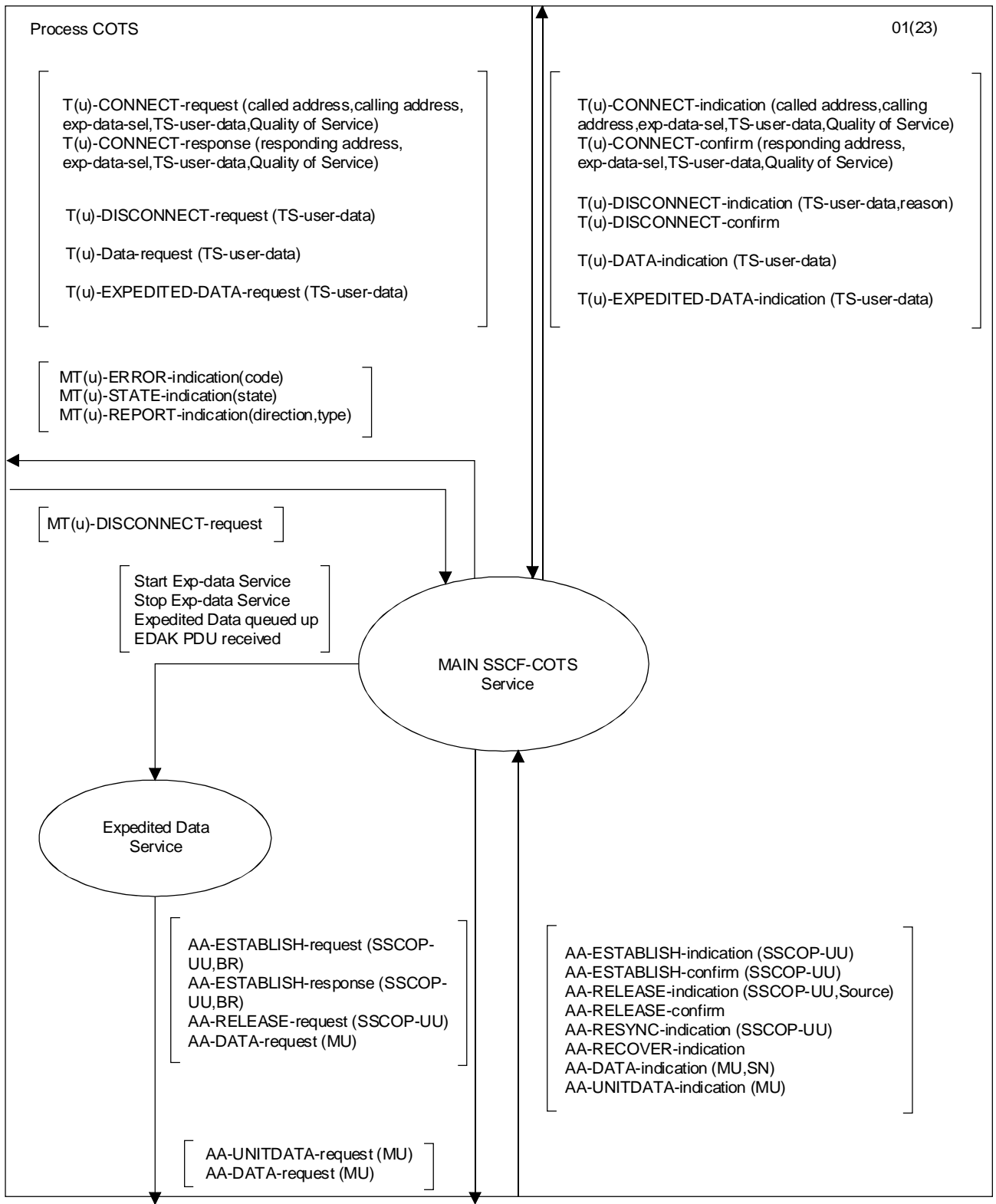

FIGURE 12/I.365.3 (sheet 1 of 16)
Procedure SSCF-COTS – Main Service SDL diagram

Primitives to/from SCF (defined in 9.1; parameters are listed between parentheses):

T(u)-CONNECT-request (called address,calling address, exp-data-sel,TS-user-data,Quality of Service)
 T(u)-CONNECT-indication (called address,calling address, exp-data-sel,TS-user-data,Quality of Service)
 T(u)-CONNECT-response (responding address, exp-data-sel,TS-user-data,Quality of Service)
 T(u)-CONNECT-confirm (responding address, exp-data-sel,TS-user-data,Quality of Service)

T(u)-DISCONNECT-request (TS-user-data,reason)
 T(u)-DISCONNECT-indication (TS-user-data,reason)
 T(u)-DISCONNECT-confirm

T(u)-DATA-request (TS-user-data)
 T(u)-DATA-indication (TS-user-data)

T(u)-EXPEDITED-DATA-request (TS-user-data)
 T(u)-EXPEDITED-DATA-indication (TS-user-data)

Signals to/from Layer Management (defined in 9.2; parameters are listed between parentheses)

MT(u)-ERROR-indication(code)
 MT(u)-STATE-indication(state)
 MT(u)-REPORT-indication(direction,type)
 MT(u)-DISCONNECT-request

Signals to/from SSCOP (defined in 9.3; parameters are listed between parentheses)

AA-ESTABLISH-request (SSCOP-UU,BR)
 AA-ESTABLISH-indication (SSCOP-UU)
 AA-ESTABLISH-response (SSCOP-UU,BR)
 AA-ESTABLISH-confirm (SSCOP-UU)

AA-RELEASE-request (SSCOP-UU)
 AA-RELEASE-indication (SSCOP-UU,Source)
 AA-RELEASE-confirm

AA-RESYNC-indication (SSCOP-UU)
 AA-RECOVER-indication

AA-DATA-request (MU)
 AA-DATA-indication (MU,SN)

AA-UNITDATA-request (MU)
 AA-UNITDATA-indication (MU)

Message to/from peer SSCF-COTS (defined in 1.1; messages are placed in the MU parameter of the AA-UNITDATA-request and AA-UNITDATA-indication signal)

ED, EDAK

Default Parameter Values of SSCF-COTS signals: In order to simplify the SDL representation of SSCF-COTS, the SDL diagrams assume default values of parameters in SSCF-COTS indication and confirm primitives. Unless otherwise specified in the SDL diagrams, the parameters of the indication and confirm primitives shall contain the default values specified here (described by the format "PDU.field" or "variable")

T(u)-CONNECT-indication TS-user-data CR.TS-user-data
 exp-data-sel EDsel (if expedited data is not implemented: "0")

T(u)-CONNECT-confirm TS-user-data CC.TS-user-data
 exp-data-sel EDsel (if expedited data is not implemented: "0")

T(u)-DISCONNECT-indication TS-user-data DR.TS-user-data
 reason DR.reason

T(u)-DATA-indication TS-user-data AA-DATA.MU(T-SDU)

T(u)-EXPEDITED-DATA-indication TS-user-data AA-UNITDATA.MU (Expedited T-SDU)

In order to simplify the SDL representation of SSCF-COTS, the SDL diagrams assume default values for the fields in the SSCF-COTS PDUs. Unless otherwise specified in the SDL diagrams, the fields (i.e. SSCF-COTS PDU parameters) of the transmitted SSCF-COTS PDUs shall be assigned the default values specified here (default values are either state variables, signal parameter values, or received PDU parameters).

DATA	E	tempE
	N(TS)	VT(TS)
	Information	T(u)-DATA(TS-user-data)
ED	N	VT(SE)
	N(TS)	VT(TS)
	Information	T(u)-EXPEDITED-DATA (TS-user-data)
EDAK	N	VR(SE)
	N(TS)	VT(TS)
CR/CC	TS-user-data	T(u)-CONNECT(TS-user-data)
	ES	EDsel (if expedited data is not implemented: "0")
DR	TS-user-data	T(u)-DISCONNECT(TS-user-data)

FIGURE 12/I.365.3 (sheet 2 of 16)
Procedure SSCF-COTS – Main Service SDL diagram

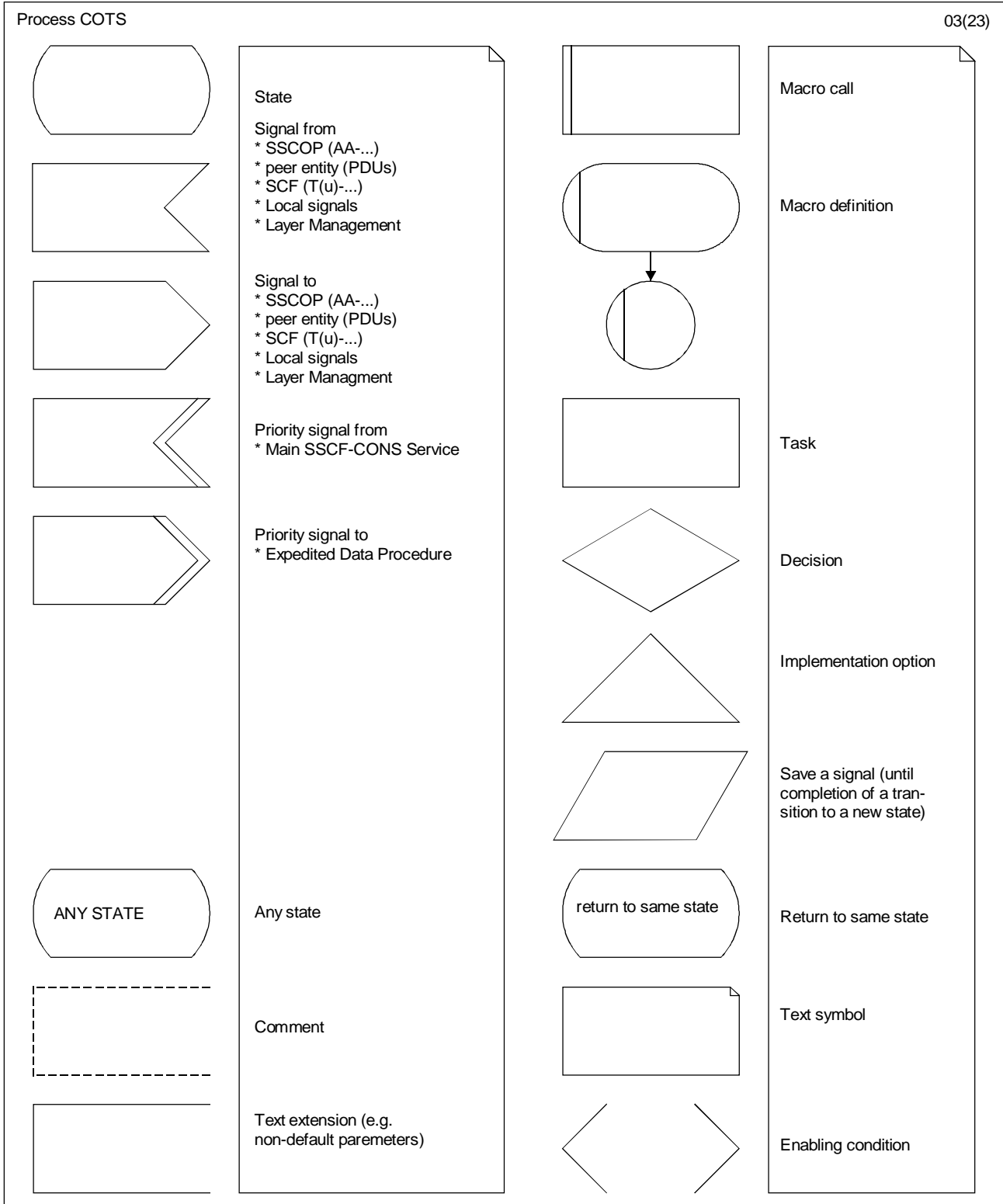

T1305760-95/d15

FIGURE 12/I.365.3 (sheet 3 of 16)

Procedure SSCF-COTS – Main Service SDL diagram

NOTES

1 (On the use of queues and buffers): To enable a satisfactory representation of the SSCF-COTS entity, a conceptual queue for the ED PDU has been explicitly brought out. This conceptual queue (ED queue) is finite but unbounded and should in no way restrict the implementation of the point-to-point procedures. One internal (local) signal has been provided in order to cause the servicing of this queue to be initiated: "ED PDU queued up". In the SDL diagrams, this signal is handled by the same "event queue" that handles other signals entering this process. The data itself is kept in the queue, hence, the order of the internal signals in the SDL event queue is insignificant.

In addition, the SDL diagrams assume the following queues and buffers: At the receiver: Delivery queue (assured data not yet to be delivered until an Expedited T-SDU has been delivered) and Reassembly buffer (assured segmented data being reassembled). Also these conceptual queues and buffers are finite but unbounded as above.

2 Signals which are ignored for a given state (inopportune signals) are not included in the SDL diagrams.

3 Modulo arithmetic is performed on the following state variables: VT(SE) and VR(SE). VT denotes a transmitter variable and VR denotes a receiver variable. The modulus equals 2 for VT(SE) and VR(SE).

4 The variables "tempE", "tempPDU", "tempL", "base" and "len" are temporary variables used in some transitions within the SDL diagrams. These variables do not constitute SSCF-COTS state variables or parameters.

5 In the SDL diagrams, the following abbreviations of variable names are used: exp-data-sel expedited data option

The value of the parameters in the T(u)-DISCONNECT primitive is shown as a code whose interpretation is defined in Table 6.

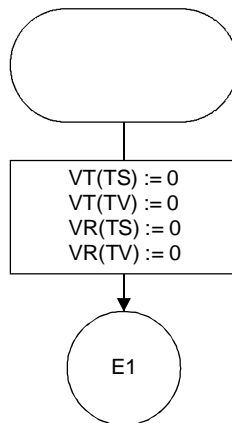

NOTE – If the Expedited Data is not implemented, the variables VT(TS), VT(TV), VR(TS) and VR(TV) are clamped to zero.

FIGURE 12/I.365.3 (sheet 4 of 16)

Procedure SSCF-COTS – Main Service SDL diagram

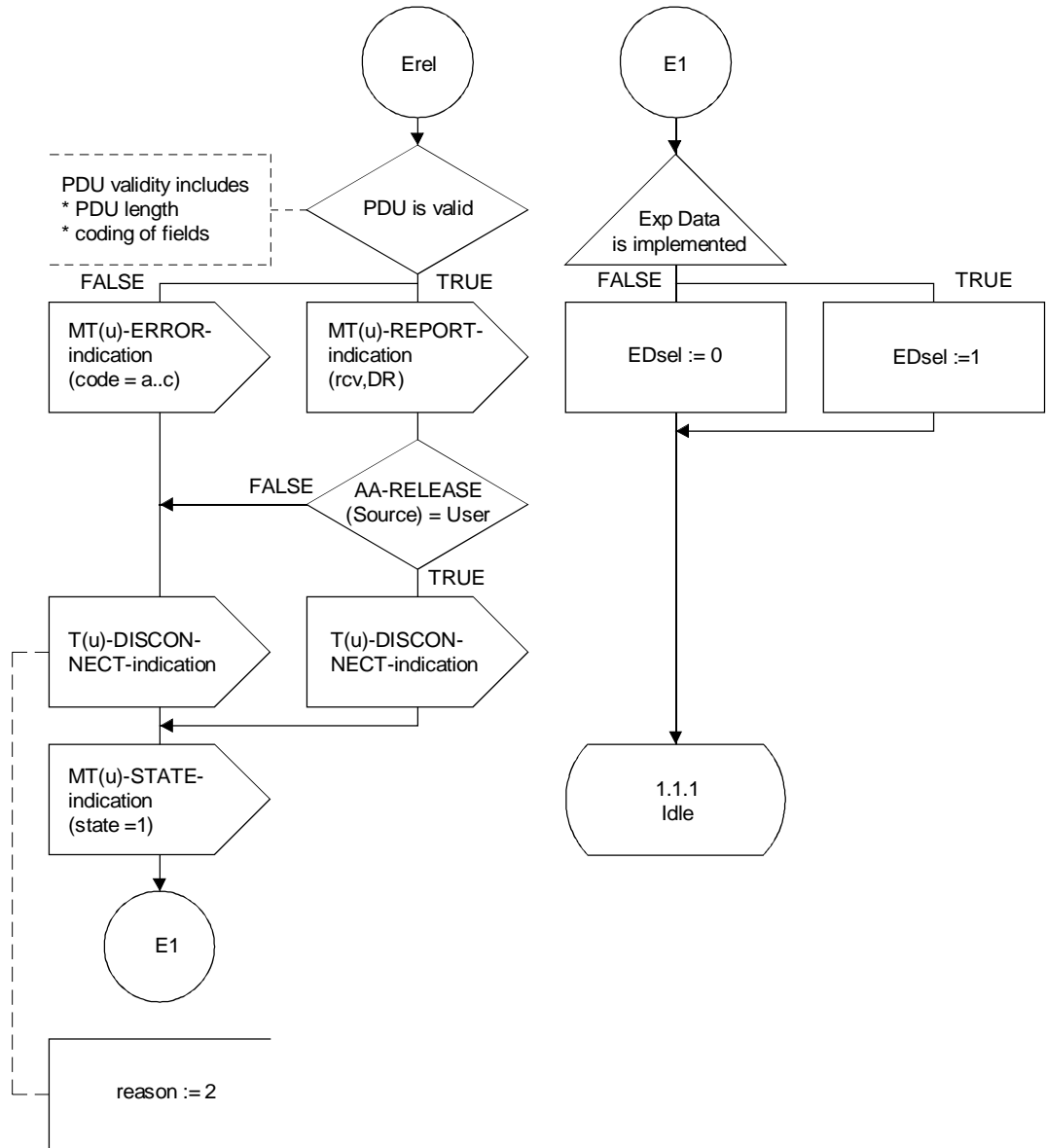

NOTE – If the Expedited Data service is not implemented, the variable EDsel is clamped to zero

FIGURE 12/I.365.3 (sheet 5 of 16)
Procedure SCSF-COTS – Main Service SDL diagram

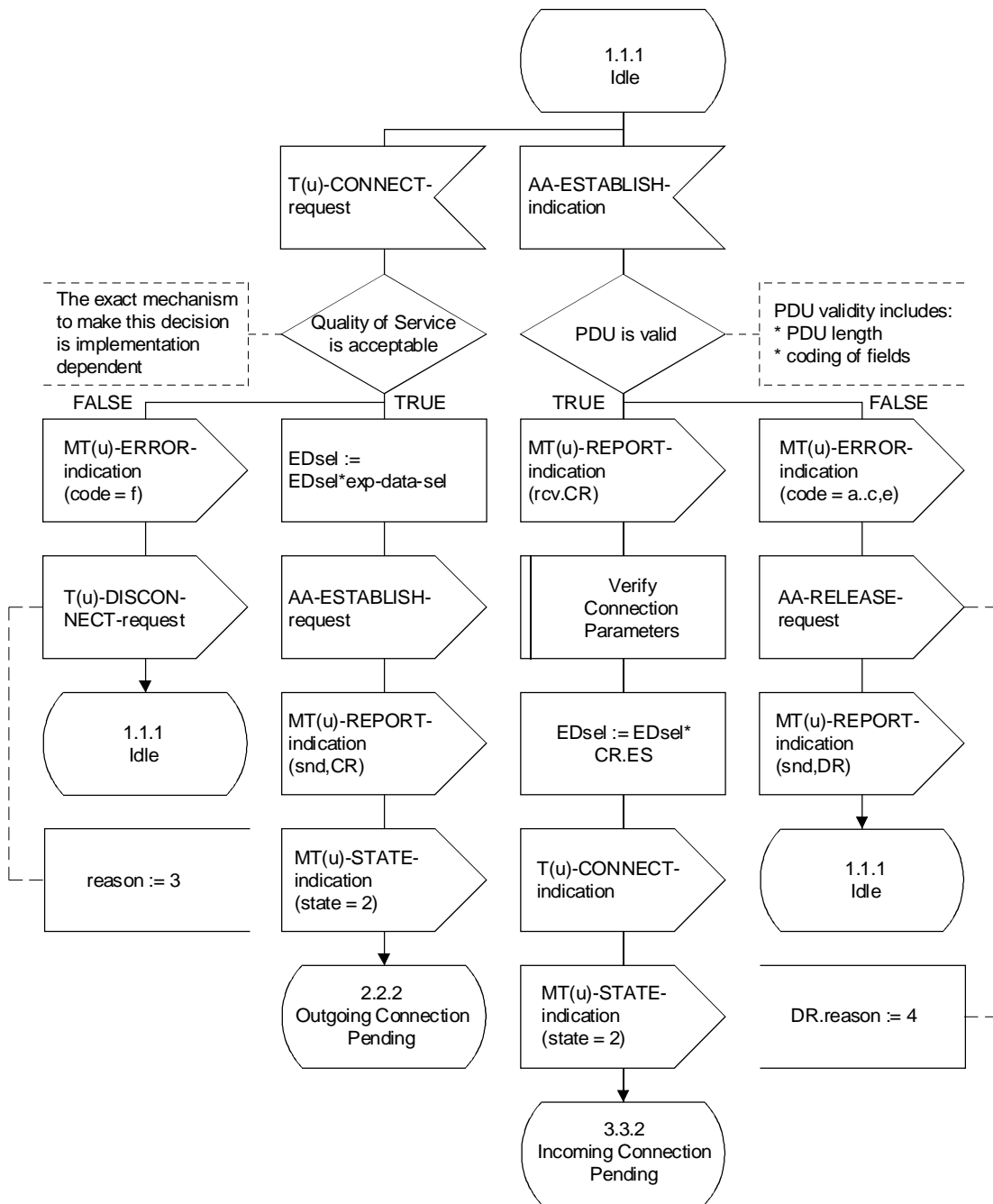

T1305790-95/d18

FIGURE 12/I.365.3 (sheet 6 of 16)
Procedure SSCF-COTS – Main Service SDL diagram

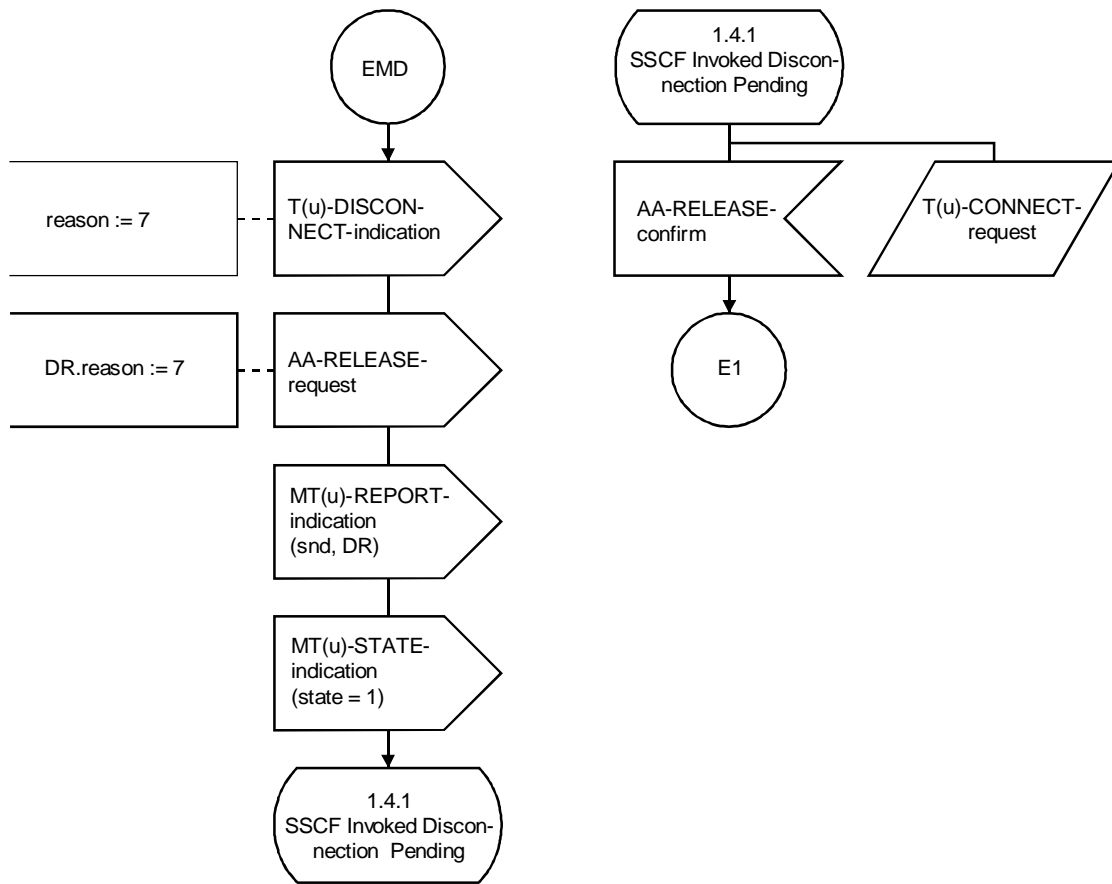

T11305800-95/d19

FIGURE 12/I.365.3 (sheet 7 of 16)
Procedure SSCF-COTS – Main Service SDL diagram

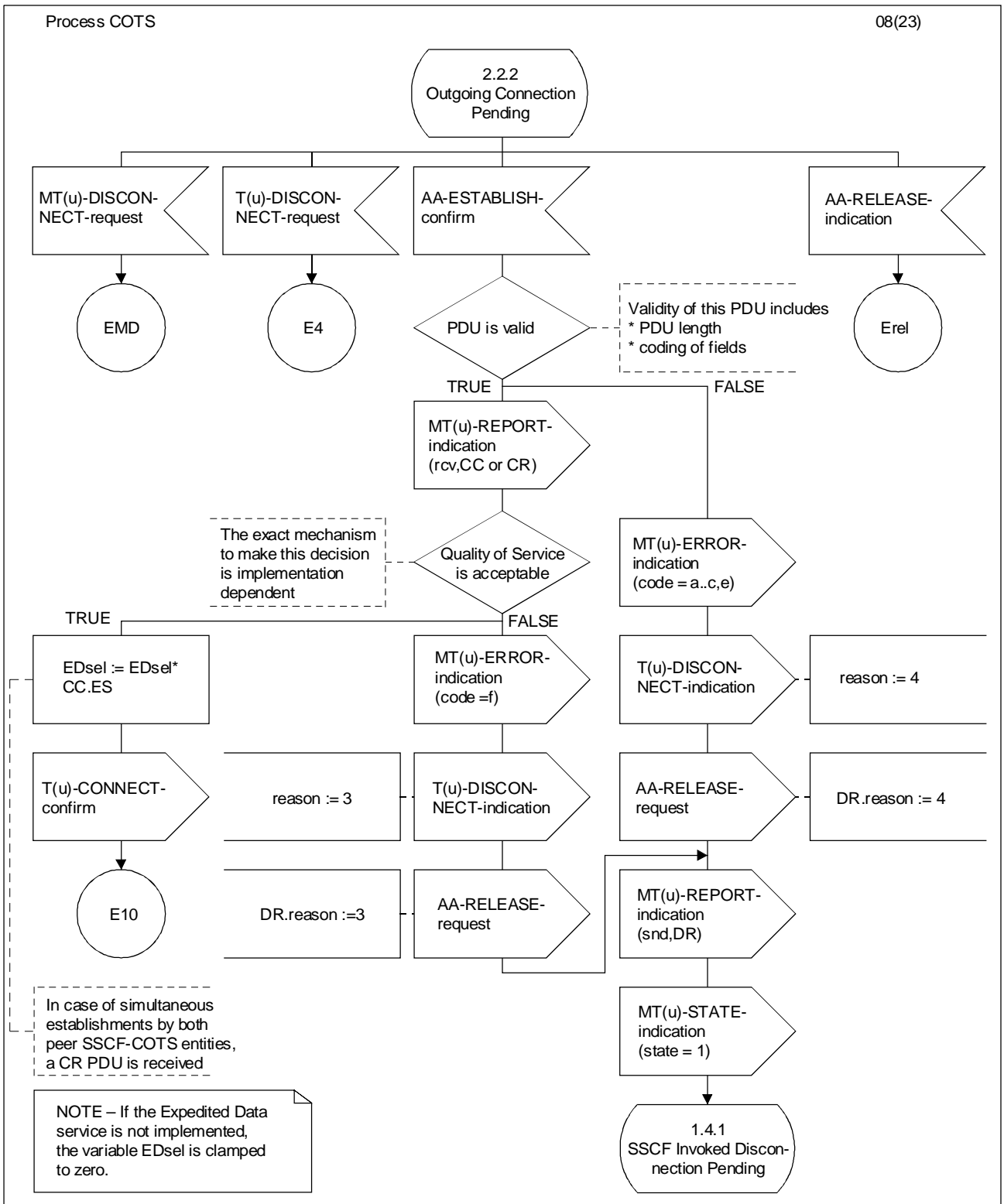
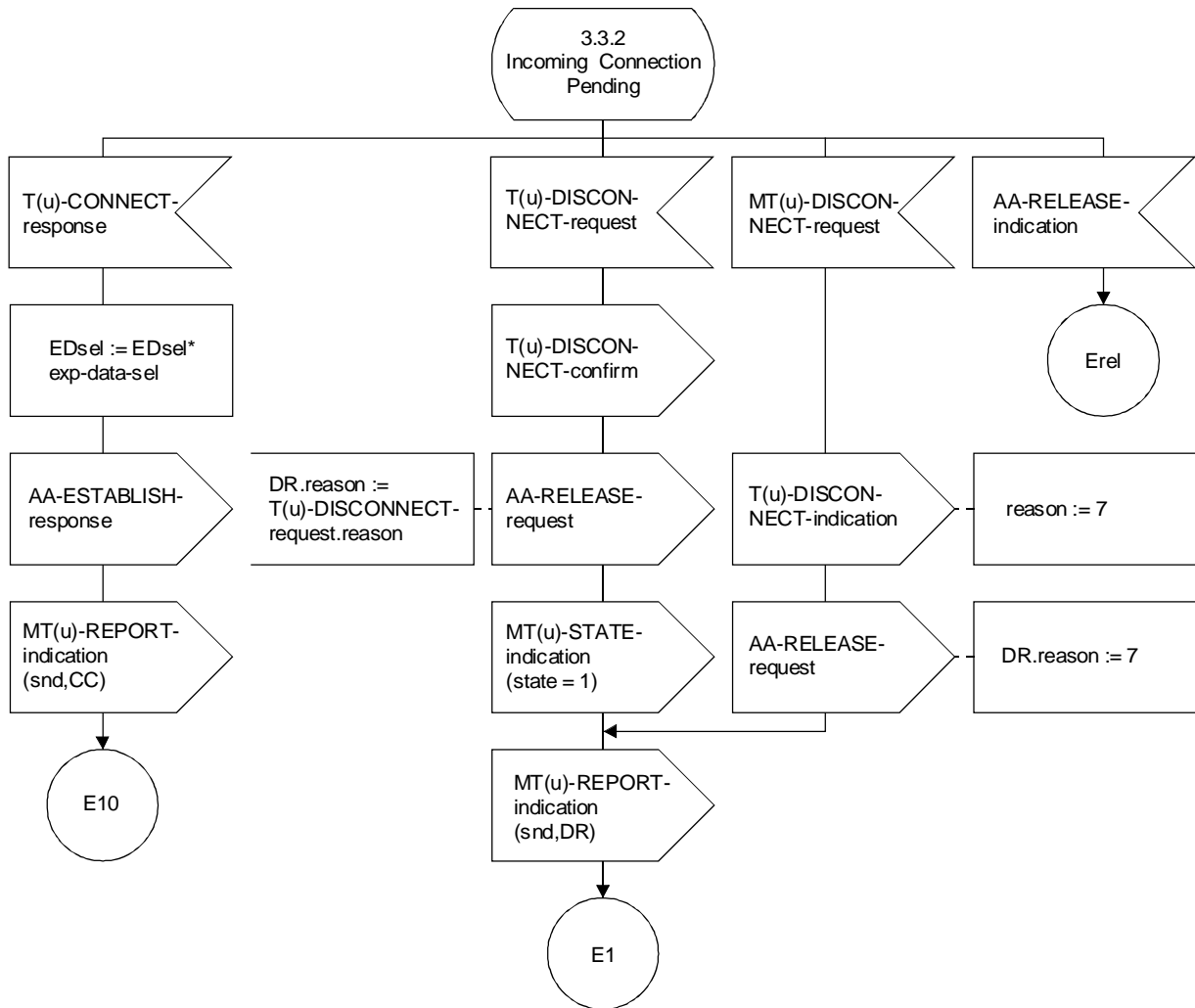
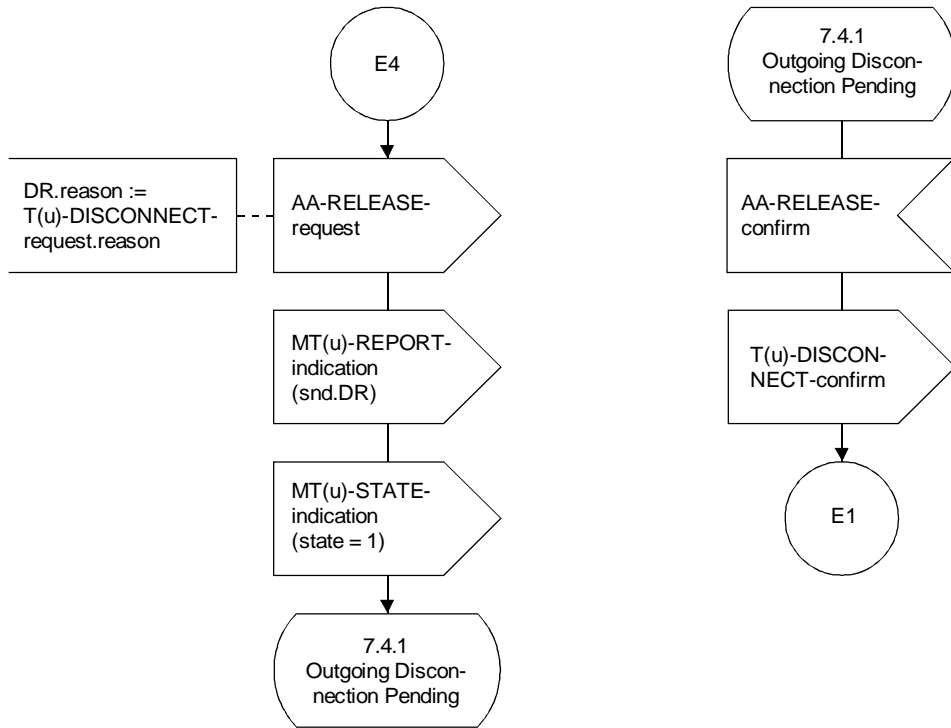

FIGURE 12/I.365.3 (sheet 8 of 16)
Procedure SSCF-COTS – Main Service SDL diagram



NOTE – If the Expedited Data service is not implemented, the variable EDsel is clamped to zero.

FIGURE 12/I.365.3 (sheet 9 of 16)
 Procedure SSCF-COTS – Main Service SDL diagram



T1305830-95/d22

FIGURE 12/I.365.3 (sheet 10 of 16)
Procedure SSCF-COTS – Main Service SDL diagram

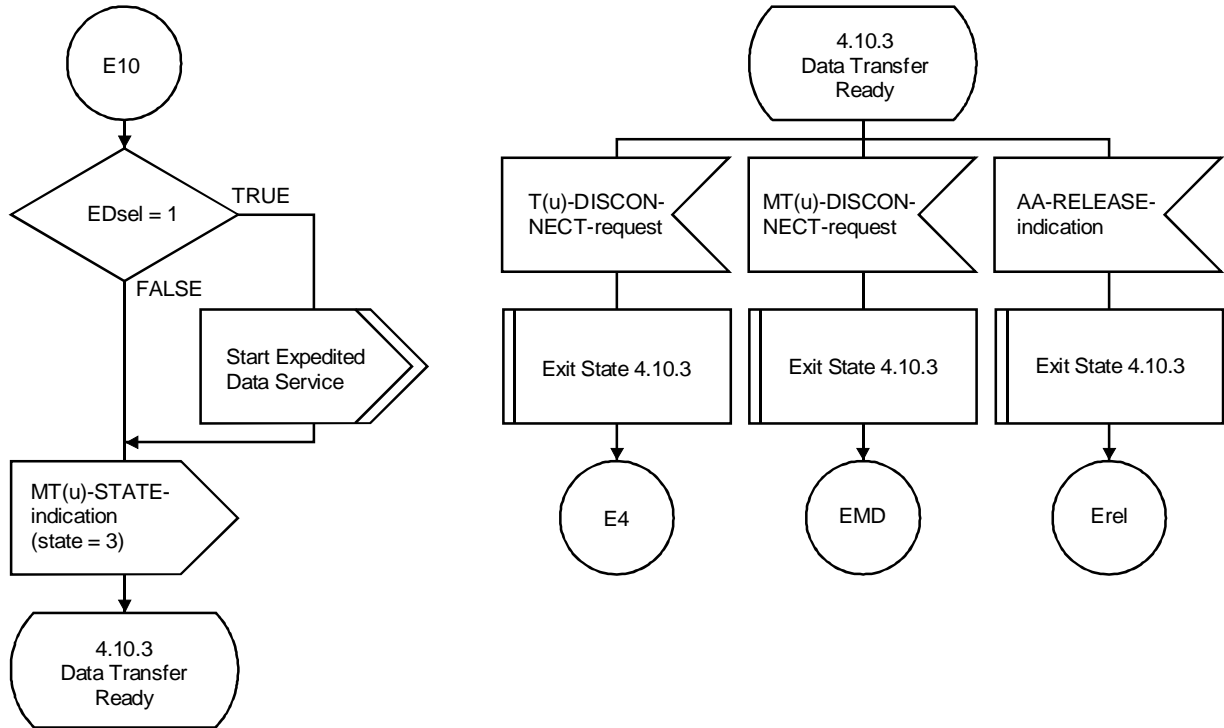

NOTE – If the Expedited Data service is not implemented, the variable EDsel is clamped to zero.

FIGURE 12/I.365.3 (sheet 11 of 16)

Procedure SSCF-COTS – Main Service SDL diagram

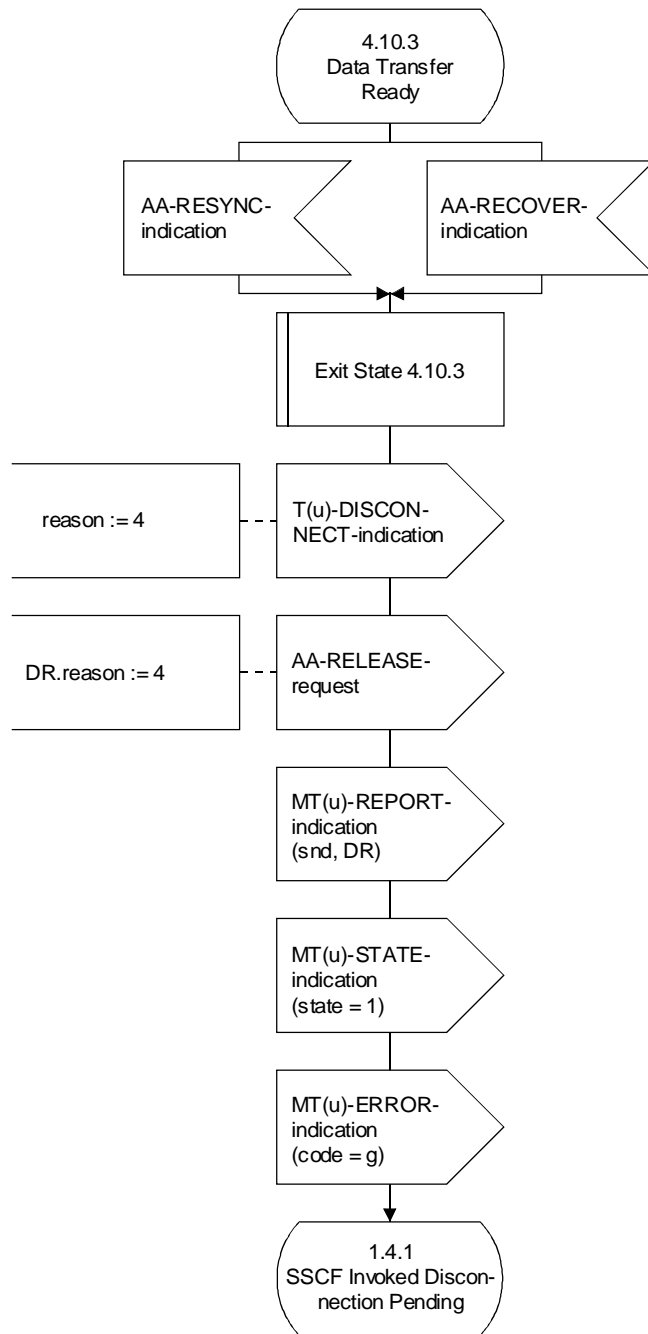

T1305850-95/d24

FIGURE 12/I.365.3 (sheet 12 of 16)

Procedure SSCF-COTS – Main Service SDL diagram

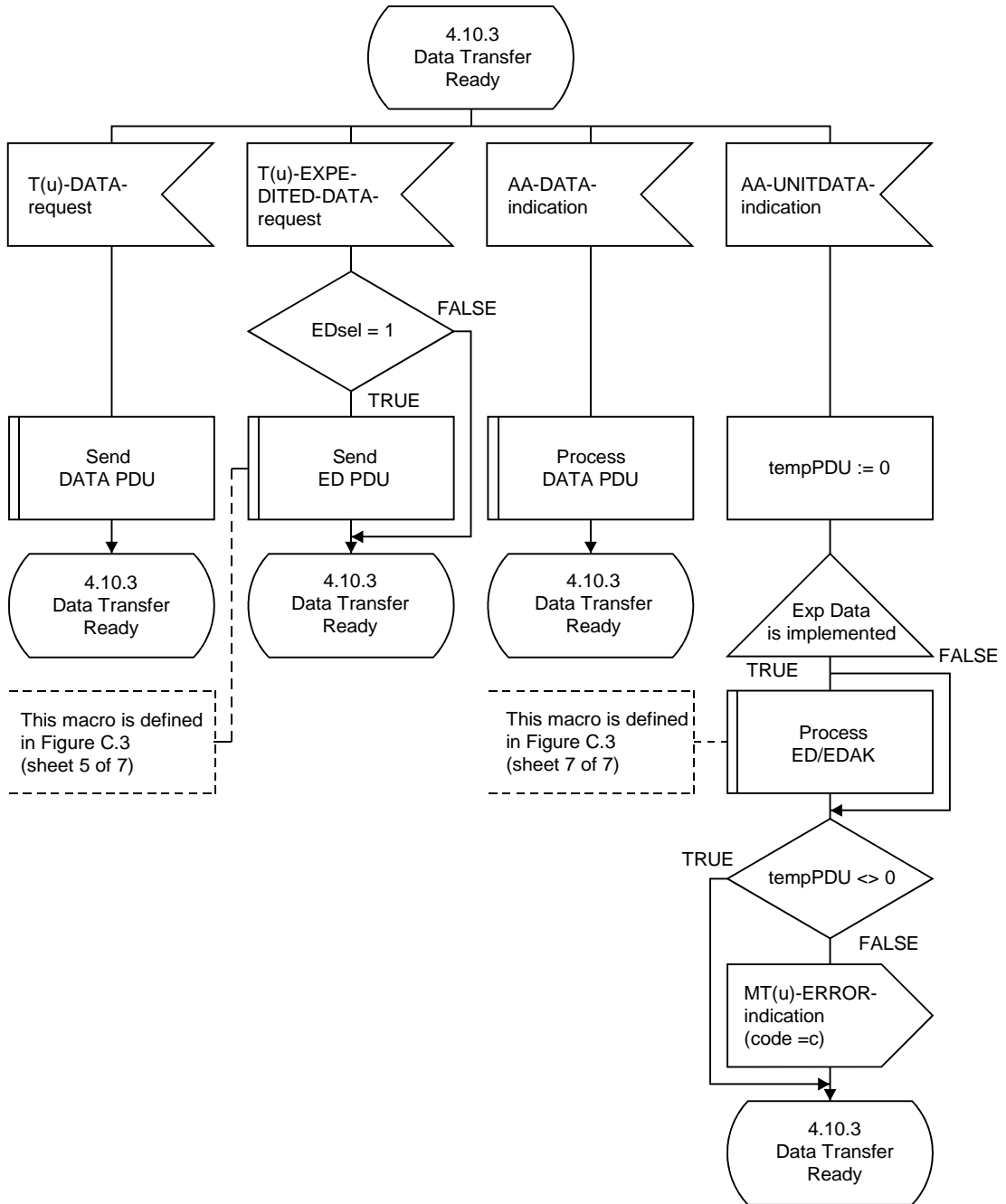

T1305860-95/d25

FIGURE 12/I.365.3 (sheet 13 of 16)
Procedure SSCF-COTS – Main Service SDL diagram

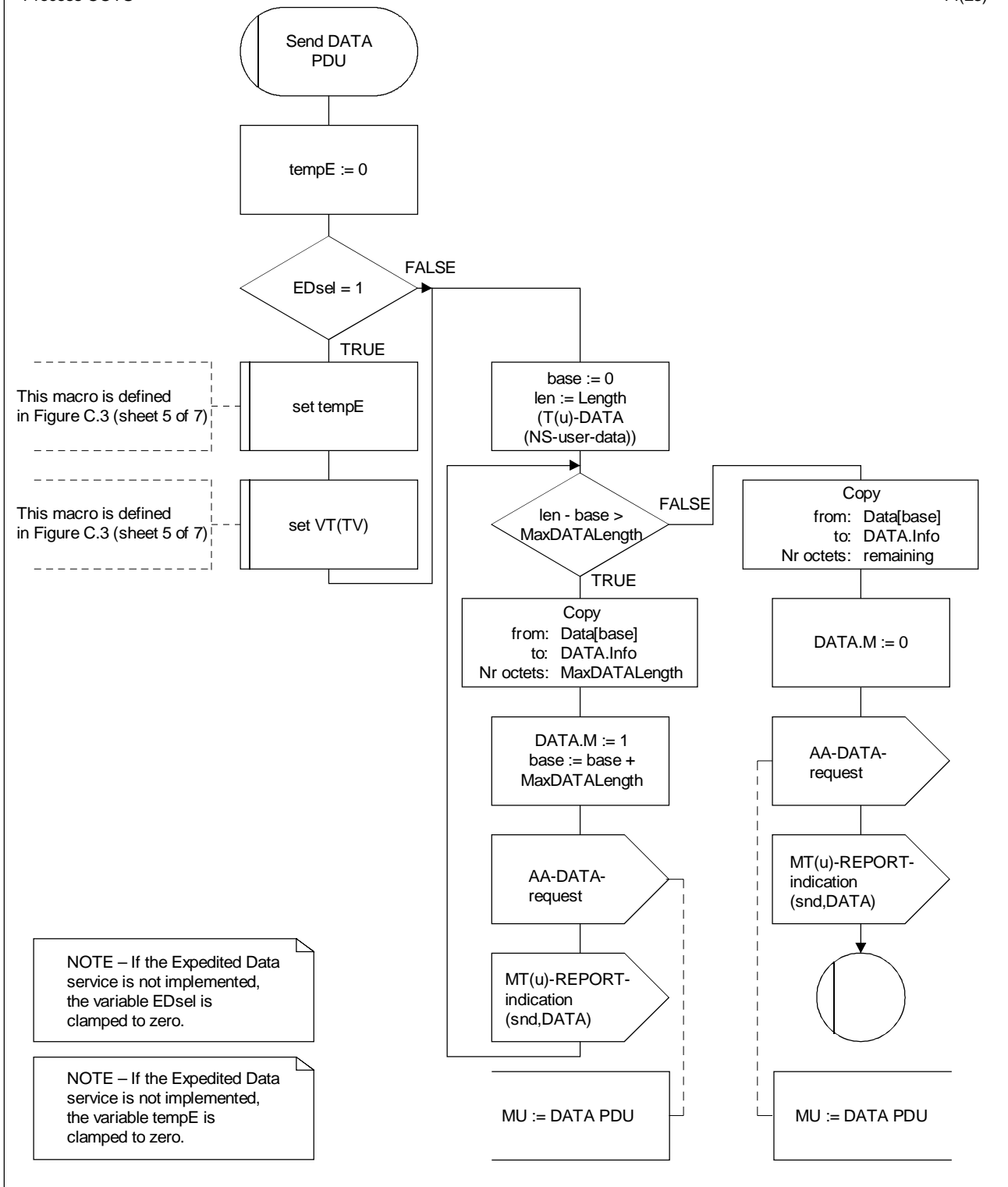

T1305870-95/d26

FIGURE 12/I.365.3 (sheet 14 of 16)
Procedure SSCF-COTS – Main Service SDL diagram

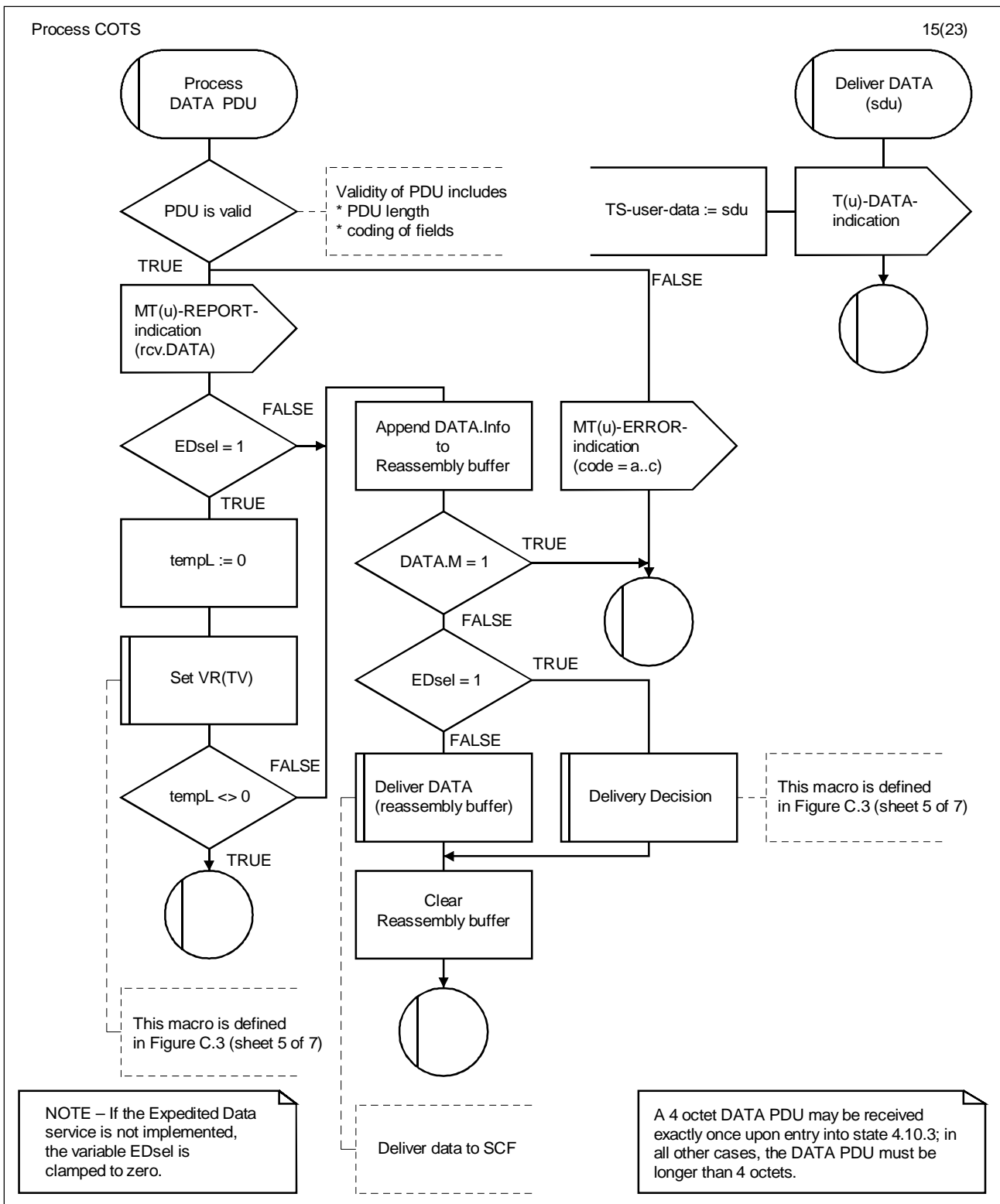
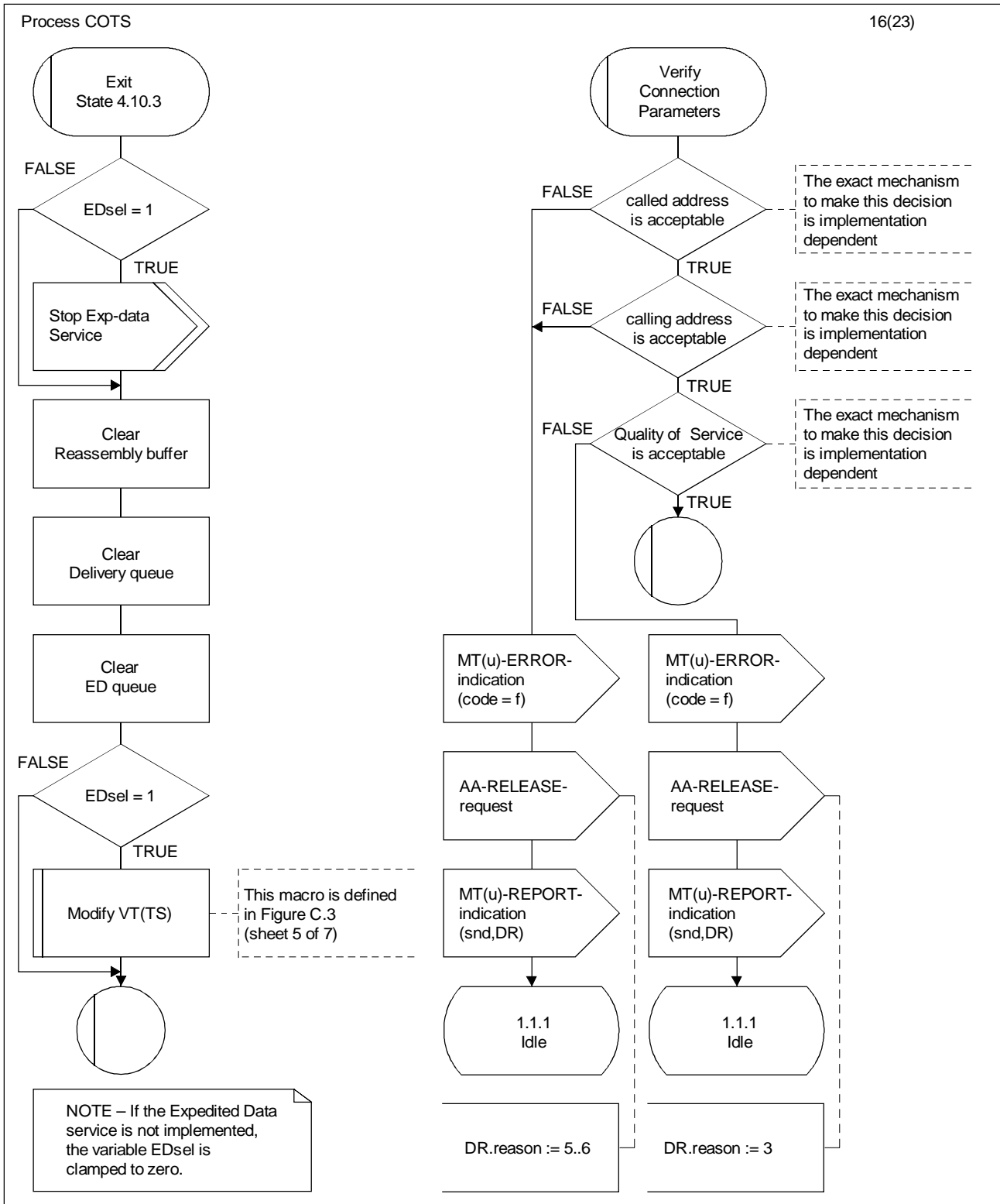

FIGURE 12/I.365.3 (sheet 15 of 16)

Procedure SSCF-COTS – Main Service SDL diagram



T1305890-95/d28

FIGURE 12/I.365.3 (sheet 16 of 16)
Procedure SSCF-COTS – Main Service SDL diagram

Annex A

Management error indications

(This annex forms an integral part of this Recommendation)

A number of events will cause errors to be submitted to the layer management entity. The associated error parameter contains the error code that describes the specific error conditions.

The column entitled “Error condition” together with the “Affected states” describes specific protocol error events and the state of the SSCF-COTS entity at the point that the MT(u)-ERROR-indication primitive is generated. See Table A.1.

TABLE A.1/I.365.3

Error conditions reported to Layer management

Error class		Error code	Error condition	Affected states
i)	SSCOP errors	A - X	Defined in Recommendation Q.2110	reported by SSCOP
ii)	Illegal PDU	a	Invalid ED or EDAK PDU	1.1.1, 2.2.2, 4.10.3
		b	Invalid PDU of recognizable PDU Type (other than ED, EDAK, RC, or RCAF)	1.1.1, 2.2.2, 4.10.3
		c (Note)	Unrecognizable PDU Type	1.1.1, 2.2.2, 4.10.3
iii)	Inopportune PDU	d	Inopportune ED or EDAK PDU	4.10.3
iv)	Illegal or inopportune PDU parameter	e	Inappropriate parameter in PDU of recognizable PDU Type	1.1.1, 2.2.2
v)	SSCF-COTS initiated causes	f	Local SSCF-COTS rejected connection (unacceptable QOS or address)	1.1.1, 2.2.2
		g	Inopportune SSCOP signal	4.10.3
NOTE – If the expedited data service is not implemented, the corresponding PDUs are treated as unrecognizable PDUs.				

Annex B

Default values for SSCOP parameters and timers

(This annex forms an integral part of this Recommendation)

This annex provides for suggested SSCOP parameter values that can be used for supporting SSCF-COTS. Table B.1 summarizes the default protocol parameters for four environments; however, these values provide satisfactory performance over a wider range of operating environments. A proper set of parameters may differ depending on the use, condition, link rate, round trip delay, and receiver resequencing buffer size; therefore, the parameters should be configurable. As a general guide, Timer_POLL should be set to as large a value as possible that still maintains throughput efficiency and satisfies the average and maximum delay requirements for delivery of data.

The tolerance of timers is not addressed in this Recommendation.

NOTE – Appendix II gives further considerations for the default values for the SSCOP's parameters and timers.

TABLE B.1/I.365.3

Default values for SSCOP parameters and timers

Parameter	Value				Unit
Condition: Bitrate at Interface (UNI) max. SSCF-COTS PDU rate Round trip Delay	1.544 1.366 60	2.048 1.811 60	155.520 132.530 10	155.520 132.530 600	Mbit/s Mbit/s ms
k (maximum SSCOP SDU size)	4096	4096	4096	4096	octet
j (maximum SSCOP-UU size)	256	256	256	256	octet
Timer_POLL	100	100	10	500	ms
Timer_NO-RESPONSE	2000	2000	200	1000	ms
Timer_KEEPALIVE	300	300	50	500	ms
Timer_IDLE	1 ... 5	1 ... 5	0.2	1.0	s
Timer_CC	100	100	100	700	ms
MaxCC	4	4	4	4	
MaxPD	500	500	500	500	
MaxSTAT	67	67	67	67	
NOTE – For Timer_POLL and Timer_KEEPALIVE it does not matter if the first expiry occurs in less time than the stated value, but subsequent expiries shall occur within the nominal tolerance of the stated value.					

Annex C

Expedited Data Transfer service

(This annex forms an integral part of this Recommendation)

This annex specifies the protocol elements and the protocol for the Expedited Data Transfer option.

NOTE – Unlike in Recommendation X.214 [7] (1988), the Expedited Data option is defined as a TS provider option; this is in line with newer Transport Service and Transport layer protocol developments.

C.1 Protocol elements for peer-to-peer communication

The Expedited Data transfer service makes use of the unassured data stream that is independent of the flow control of the assured service. Error recovery from transmission errors by retransmission and a separate flow control is handled by a peer-to-peer protocol within the SSCF-COTS sublayer. The SSCOP signal type used is AA-UNITDATA.

C.1.1 SSCF-COTS PDUs

The Protocol Data Units (PDUs) are listed and described in Table 7.

The definitions of the SSCF-COTS PDUs utilizing the unassured data transfer are as follows:

a) *ED PDU (Expedited Data)*

The ED PDU is used to transfer Expedited T-SDUs between the two peer TS-users.

b) *EDAK PDU (Expedited Data Acknowledgement)*

The EDAK PDU is used to acknowledge receipt of an ED PDU; it is also used for flow control of the expedited data transfer.

C.1.2 SSCF-COTS PDU formats

Figures C.1 and C.2 illustrate the format of the PDUs for the Expedited Data Transfer service.

The maximum length of the information field in the ED PDU is 16 octets; its minimum length is 1 octet.

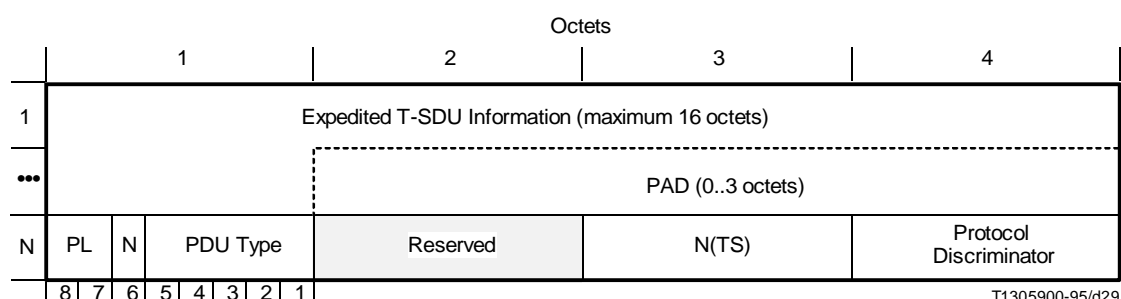

FIGURE C.1/I.365.3
Expedited Data (ED PDU)

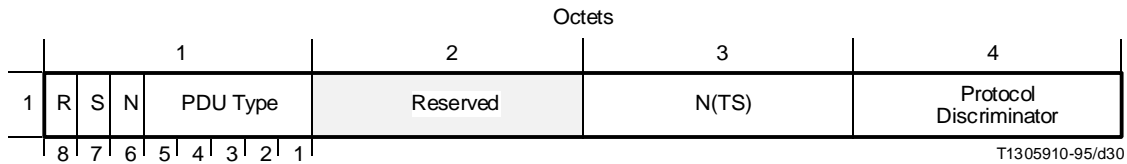

FIGURE C.2/I.365.3
Expedited Data Acknowledgement (EDAK PDU)

NOTE – 16 octets of TS-user-data plus 4 octets of SSCF-COTS PCI plus 4 octets of SSCOP PCI plus 8 octets of AAL type 5 Common Part (see clause 6/I.363 [2]) PCI fits into a single ATM information field.

C.1.3 SSCF-COTS PDU parameter fields

The SSCF-COTS PDUs contain the following parameter fields in addition to those specified in 10.3:

- a) *PDU Type – PDU Type field*
 The PDU Type field’s coding is defined in Table 7.
- b) *Expedited T-SDU Information field*
 The Expedited T-SDU Information field in the ED PDU contains the value of the TS-user-data parameter of the T(u)-EXPEDITED-DATA primitive.
- c) *S – Expedited Data Flow Control field*
 The S field (stop bit) in the EDAK PDU is set to “0” if transmission of further ED PDUs is allowed; otherwise, the S field is set to “1”.
- d) *N – Expedited Data Sequence Number field*
 The N field carries the current value of the state variable VT(SE) in the ED PDU and the value of the state variable VR(SE) in the EDAK PDU.

The SSCF-COTS PDU parameters already defined in 10.3 that are “reserved” in the absence of the implementation and the selection at connection establishment are defined as follows:

- e) *N(TS) – Data Transfer State Identity Number field*
 In the ED PDU and EDAK PDU, this field carries the current value of the transmitter state variable VT(TS).
- f) *ES – Expedited Data Transfer Selection field*
 During connection establishment, the ES field in the CR or CC PDUs conveys the Expedited Data Transfer selection between the two peer SSCF-COTS entities (see Figure 7 and 10.3). The coding is shown in Table C.1.
- g) *N(E) – Expedited Data Synchronization field*
 The N(E) field in the DATA PDU contains the value of the state variable VT(E) before it is set to “0”; it represents the number of T(u)-Expedited-Data-indications that must be delivered before the T(u)-DATA-indication associated with this DATA PDU may be delivered (see Figure 6 and 10.3). If segmentation occurs, the N(E) field is set to the same value in all DATA PDUs.

TABLE C.1/I.365.3
SSCF-COTS PDU field coding

Field	Code	Value
ES field	0	No use of expedited data
	1	User of expedited data

C.1.4 Additional states of the SSCF-COTS protocol entity

For the assured transfer of expedited data, a service procedure is running whenever the SSCF-COTS entity is in the Data Transfer Ready state (state 4.10.3). This Expedited Data service procedure has the following basic states:

State E0 Expedited Data Wait

The Expedited Data service procedure of an SSCF-COTS entity is conceptually initiated in the Expedited Data Wait state. It remains or returns to this state unless the SSCF-COTS entity is in the Data Transfer Ready state (state 4.10.3).

State E1 Expedited Data Idle

When the SSCF-COTS entity is in state 4.10.3 and no acknowledgement of an ED PDU is outstanding, the Expedited Data service procedure is in the Expedited Data Idle state.

State E2 Expedited Data Sent

The Expedited Data service procedure has transmitted an ED PDU and is awaiting its acknowledgement in the Expedited Data Sent state.

State E3 Expedited Data Busy

The Expedited Data service procedure has received the acknowledgement of a transmitted ED PDU but has not received credit to send further ED PDUs; credit is awaited in the Expedited Data Busy state.

C.1.5 Additional SSCF-COTS state variables

The ED PDUs are sequentially numbered; as only one ED PDU acknowledgement is allowed to be outstanding, a sequence number modulo 2 is sufficient.

NOTE – The Expedited Data service procedure shares the state variables with the main procedure.

C.1.5.1 Transmitter state variables

To support the Expedited Data Transfer option, SSCF-COTS maintains the following state variables at the transmitter:

a) $VT(SE)$ – Expedited Data Send state variable

This state variable contains the sequence number of the next ED PDU to be transmitted. It is incremented after the acknowledgement of an ED PDU. When the SSCF-COTS entity enters state 4.10.3 (Data Transfer Ready), this state variable is set to “0”. Arithmetic on the value of this state variable is modulo 2.

b) $VT(E)$ – Expedited Data Synchronization Send state variable

This state variable counts the number of T(u)-EXPEDITED-DATA-request primitives received between normal T(u)-DATA-request primitives. When the SSCF-COTS entity enters state 4.10.3 (Data Transfer Ready), this state variable is set to “0”. The value of this state variable is copied into the Expedited Data Synchronization field N(E); otherwise, no arithmetic is performed on this state variable.

NOTE – The N(E) field in the DATA PDU contains a value other than “0” if T(u)-EXPEDITED-DATA-request primitives were received between this and the last T(u)-DATA-request; otherwise, the N(E) field is set to “0”. If segmentation occurs, the N(E) field is set to the same value in all DATA PDUs.

c) $VT(TS)$ – Data Transfer State Identity Number state variable

This state variable contains the identity number of the entry into the Data Transfer Ready state (state 4.10.3, see Figure 10). This state variable is copied into the N(TS) field of the DATA PDU, ED PDU, and EDAK PDU.

d) $VT(TV)$ – Data Transfer State Identity Validity state variable

This state variable contains the information whether the identity number in the state variable VT(TS) has been sent in a DATA PDU with an appropriately set N(TS).

C.1.5.2 Receiver state variables

To support the Expedited Data Transfer option, SSCF-COTS maintains the following state variables at the receiver:

a) *VR(SE) – Expedited Data Receive state variable*

This state variable contains the sequence number of the next in-sequence ED PDU expected. It is incremented after the receipt of the next in-sequence ED PDU. This state variable assists the receiver to detect retransmissions. When the SSCF-COTS entity enters state 4.10.3 (Data Transfer Ready), this state variable is set to "0". Arithmetic on the value of this state variable is modulo 2.

b) *VR(E) – Expedited Data Synchronization Receive state variable*

This state variable contains synchronization information to assure that normal data may not bypass expedited data. When an ED PDU is received, this state variable is incremented; the N(E) field of a DATA PDU is subtracted from this state variable before a delivery decision is made. When the SSCF-COTS entity enters state 4.10.3 (Data Transfer Ready), this state variable is set to "0". Whenever the value of this state variable is negative, received normal data may not be delivered to the SSCF-COTS user but must be queued until the value of this state variable becomes zero or greater.

NOTE 1 – Buffers may be shared with SSCOP and SSCOP's flow control may be used to protect also the resources possibly being consumed by the queueing described; however, this is not subject to standardization.

c) *VR(TS) – Data Transfer State Identity Number state variable*

This state variable contains the identity number of the entry into the Data Transfer Ready state (state 4.10.3, see Figure 10) from the peer transmitter. It is set with the value of the N(TS) field of received DATA PDUs.

NOTE 2 – An ED PDU or EDAK PDU with a different N(TS) field is considered to be out of place and is discarded.

d) *VR(TV) – Data Transfer State Identity Validity state variable*

This state variable contains the information whether the identity number in the state variable VR(TS) has been updated by a received DATA PDU with an appropriately set N(TS).

C.1.5.3 Common state variables

For the support of the Expedited Data Transfer option, the SSCF-COTS maintains the following common state variables at the transmitter and receiver:

- *EDsel*

This state variable contains the result of the Expedited Data Transfer option selection. If the option is selected, this state variable is set to "1"; otherwise, it is set to "0".

C.1.6 SSCF-COTS timers

The Expedited Data service procedure requires the following timers:

NOTE – The timers are only active, if the Expedited Data transfer option is implemented and has been selected at connection establishment and if the SSCF-COTS entity is in state 4.10.3 (Data Transfer Ready).

a) *Timer_ECC*

If the Expedited Data service procedure is in state E2 (Expedited Data Sent), the Timer_ECC is running. It protects the transfer of Expedited T-SDUs against transmission errors. Expiry of this timer may lead to retransmissions of ED PDUs. This timer should be greater than a round trip delay.

b) *Timer_Ebusy*

If the Expedited Data service procedure is in state E3 (Expedited Data Busy), the Timer_Ebusy is running. It polls the peer SSCF-COTS entity until a credit to transmit a further Expedited T-SDUs is received. Expiry of this timer may lead to retransmissions of ED PDUs.

C.2 Specification of the Expedited Data service procedure

The State Transition Table (Table C.2) for SSCF-COTS describes the signals and events that lead to state transitions in the Expedited Data service procedure. The table only shows the major transition paths; the SDL diagrams show the full transitions.

SDL diagrams for the Expedited Data service procedure are represented in Figure C.3.

TABLE C.2/I.365.3

State transition table

Event	State			
	E0	E1	E2	E3
Main service moves into state 4.10.3	if (EDsel = 1) then E1 else E0	–	–	–
Main service leaves state 4.10.3	E0	E0	E0	E0
Expedited data queued up	–	AA-UNITDATA- request(ED PDU) E2	E2	E3
timer_ECC expires	–	–	AA-UNITDATA- request(ED PDU) E2	–
timer_Ebusy expires	–	–	–	AA-UNITDATA- request(ED PDU) E2
AA-UNITDATA-indication (EDAK PDU) AND EDAK.S=0 AND valid EDAK.N(TS)	–	–	E1	E1
AA-UNITDATA-indication (EDAK PDU) AND EDAK.S=1 AND valid EDAK.N(TS)	–	–	E3	E3
AA-UNITDATA-indication (EDAK PDU) AND invalid EDAK.N(TS)	E0	E1	E2	E3

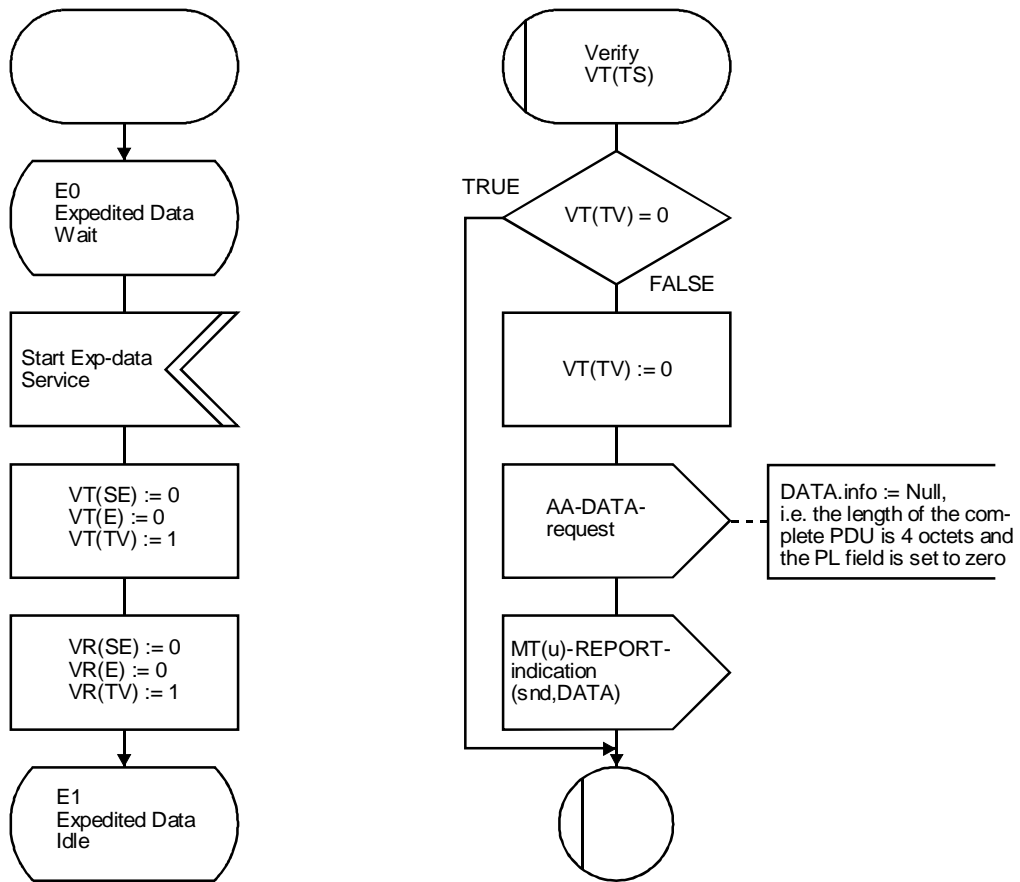

T1305920-95/d31

FIGURE C.3/I.365.3 (sheet 1 of 7)
Procedure SSCF-CITS – Service Expedited Data SDL diagram

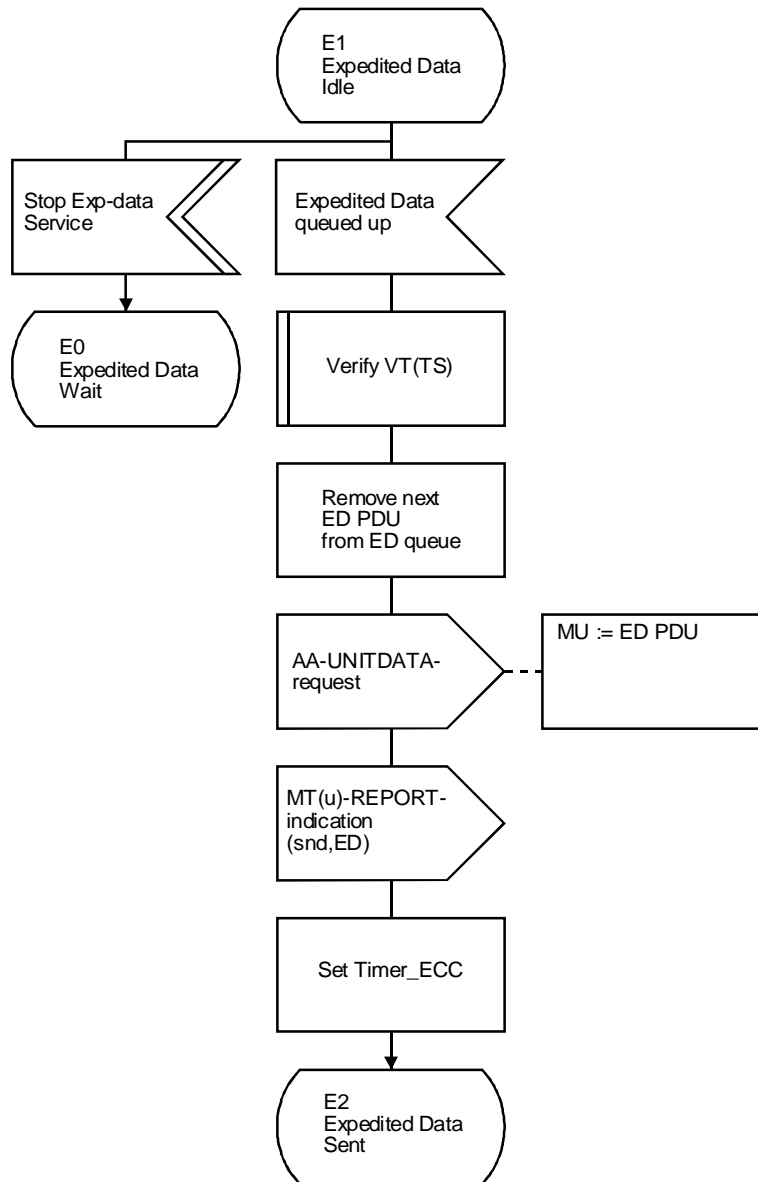

T1305930-95/d32

FIGURE C.3/I.365.3 (sheet 2 of 7)
 Procedure SSCF-COTS – Service Expedited Data SDL diagram

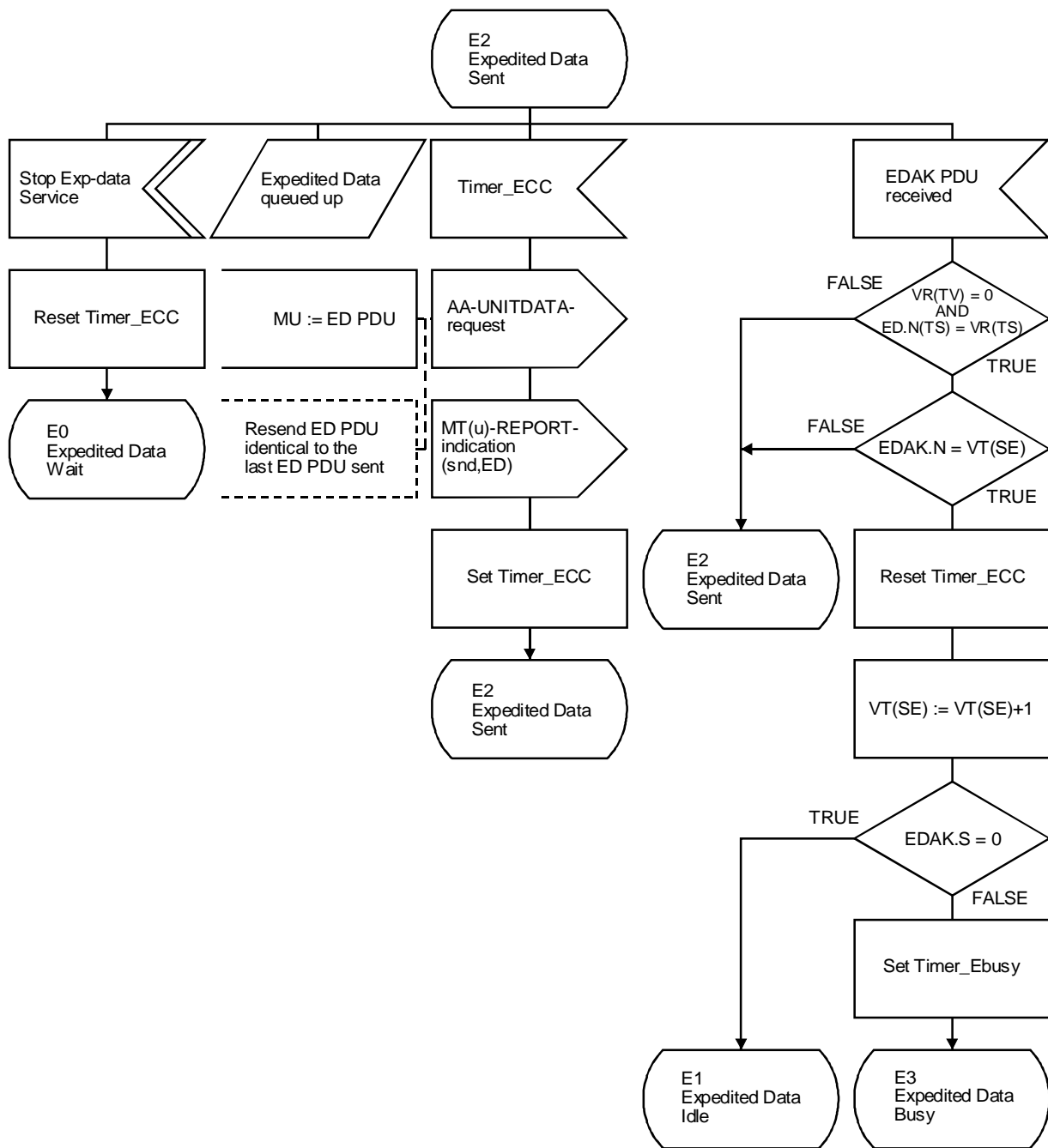

T1305940-95/d33

FIGURE C.3/I.365.3 (sheet 3 of 7)
 Procedure SSCF-COTS – Service Expedited Data SDL diagram

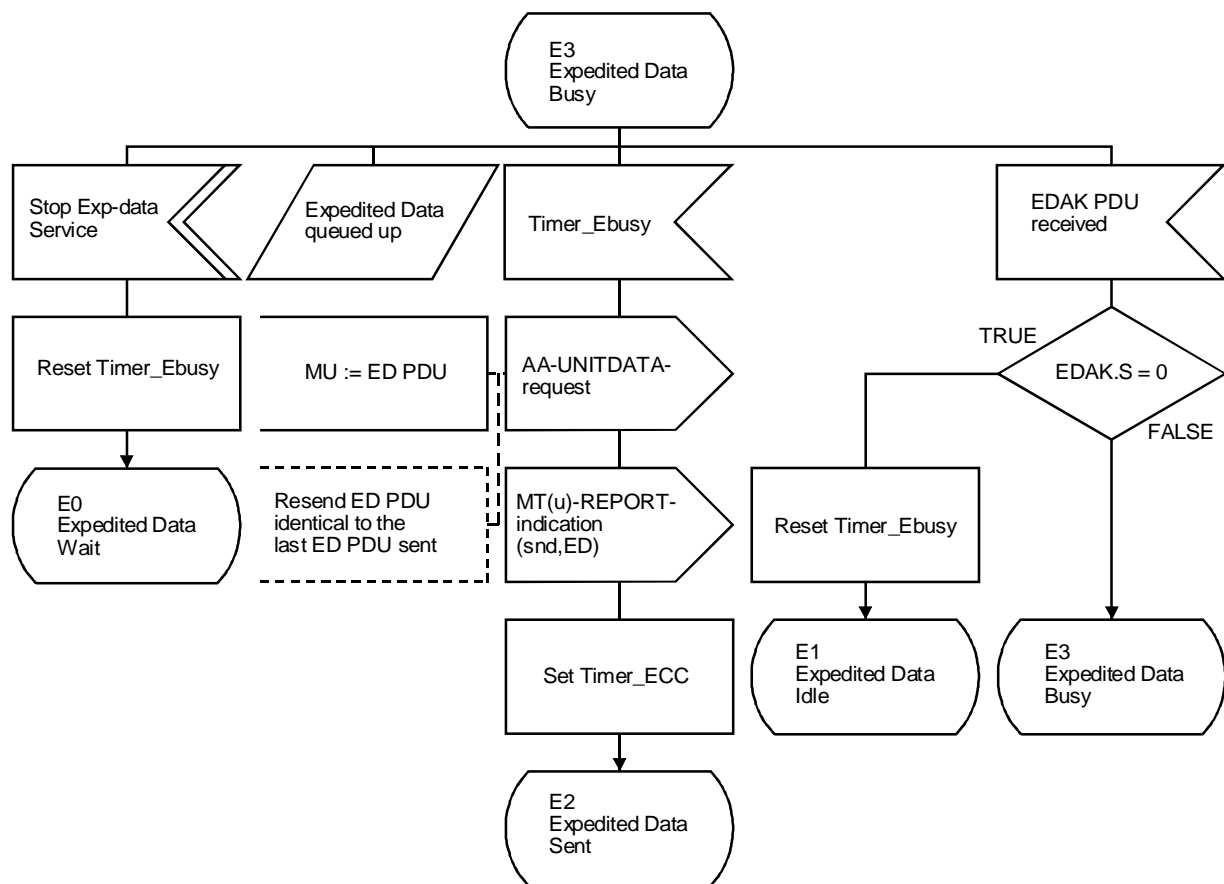

T1305950-95/d34

FIGURE C.3/I.365.3 (sheet 4 of 7)
 Procedure SSCF-COTS – Service Expedited Data SDL diagram

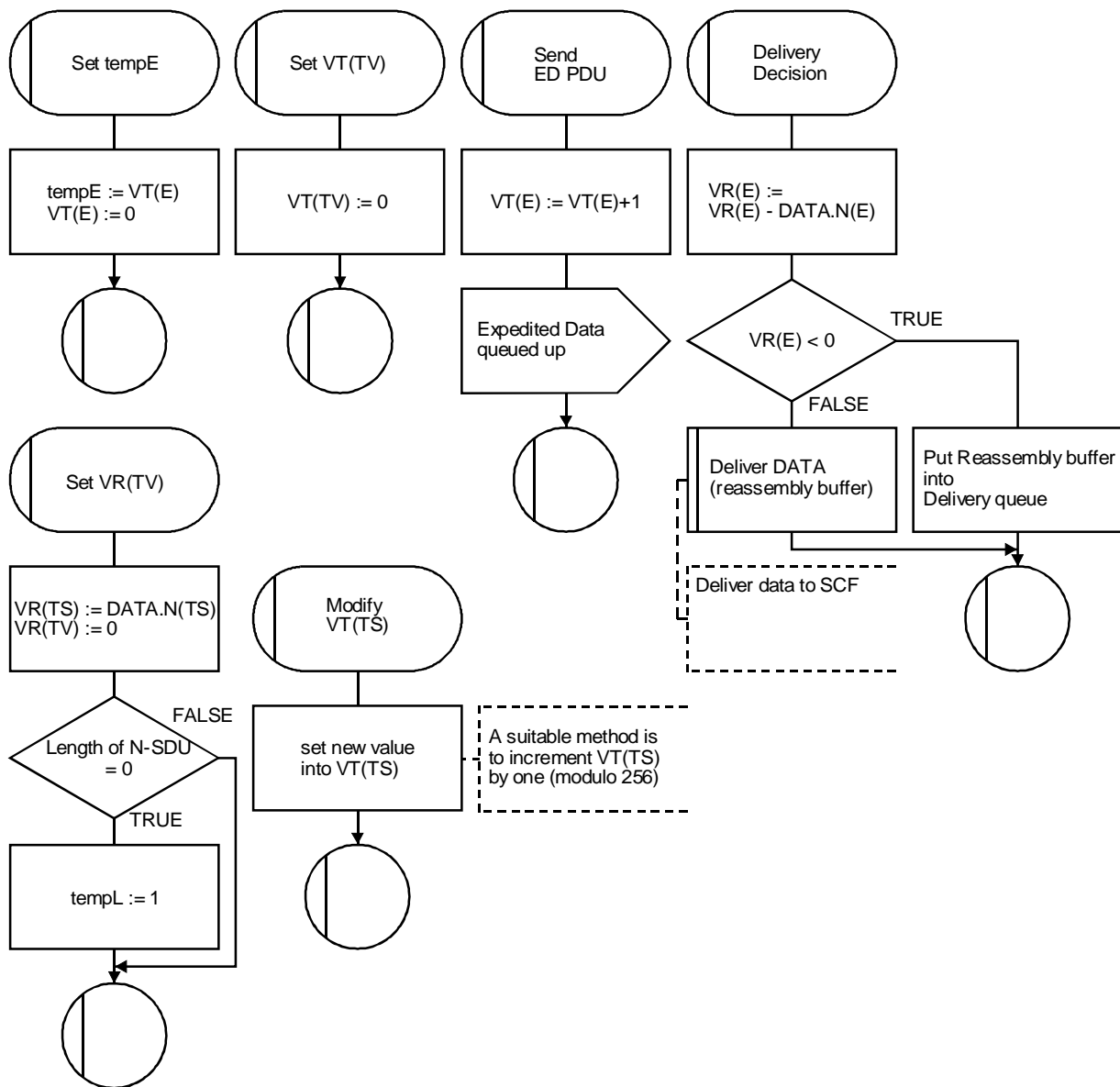

NOTE – If the Expedited Data service is not implemented, the variables tempE, VT(E), VR(TS), and VR(E) are clamped to zero.

FIGURE C.3/I.365.3 (sheet 5 of 7)
 Procedure SSCF-COTS – Service Expedited Data SDL diagram

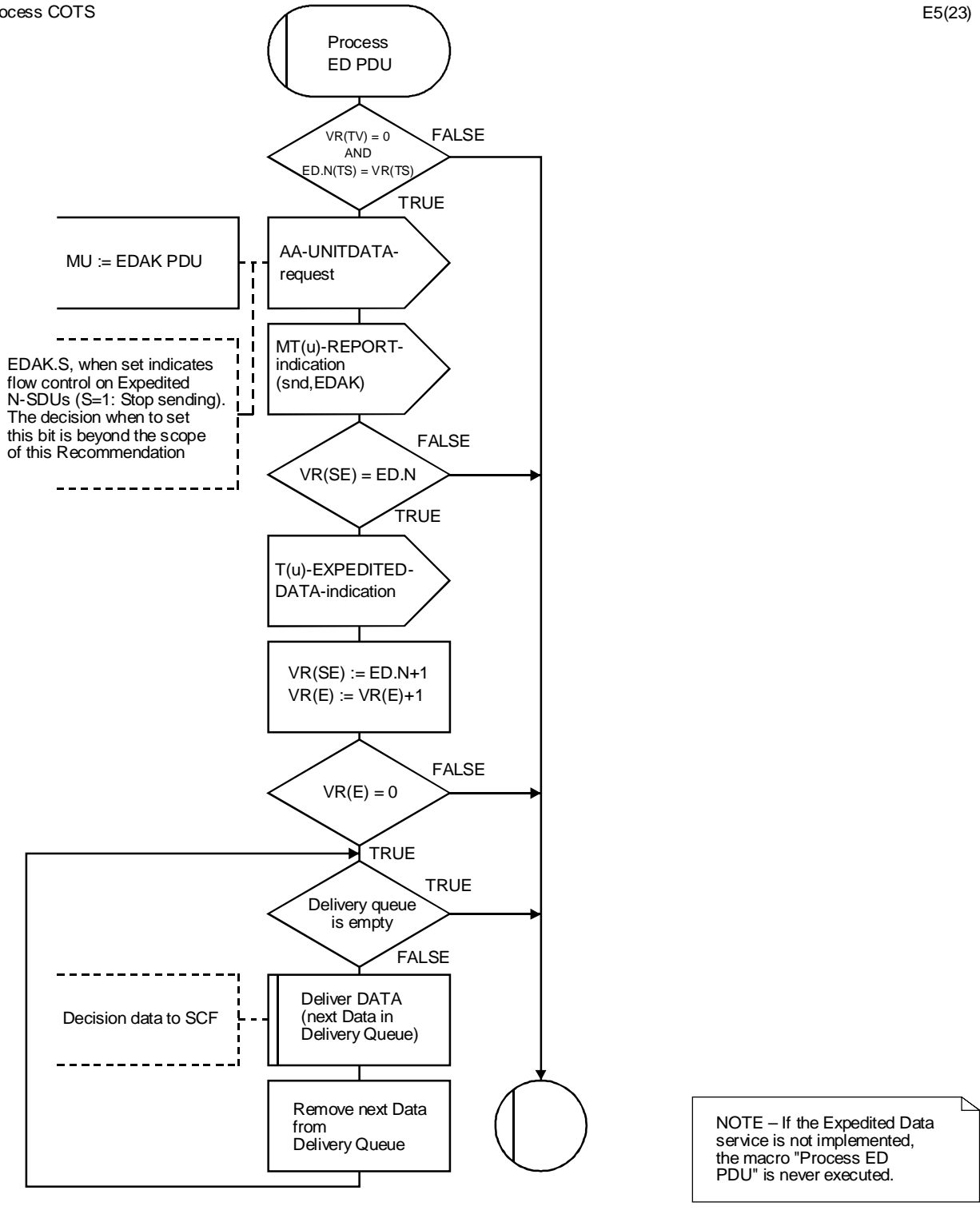

T1305970-95/d36

FIGURE C.3/I.365.3 (sheet 6 of 7)

Procedure SSCF-COTS – Service Expedited Data SDL diagram

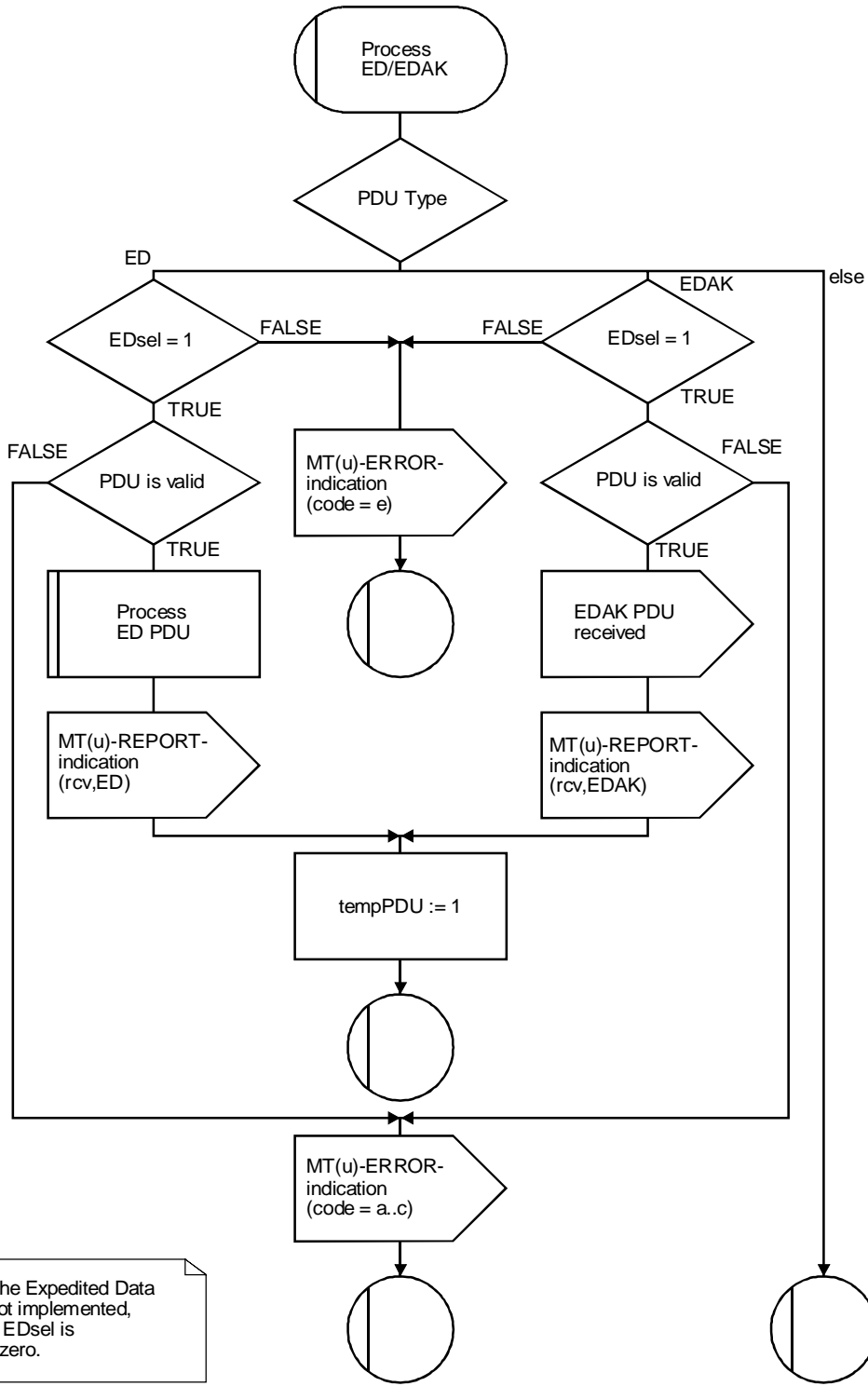

NOTE – If the Expedited Data service is not implemented, the variable EDsel is clamped to zero.

T1305980-95/d37

FIGURE C.3/I.365.3 (sheet 7 of 7)
 Procedure SSCF-COTS – Service Expedited Data SDL diagram

Annex D

Quality of Service parameter negotiation

(This annex forms an integral part of this Recommendation)

This annex defines sets of QOS parameters, the coding of these parameters in the CR PDU and CC PDU, and the negotiation procedures within the SSCF-COTS applicable to connection establishment. Within the CR PDU and the CC PDU, the correct interpretation of the set of parameters is derived from the coding of the “QOS Set Identifier” field of these PDUs. The coding of the QOS Set Identifier field is shown in Table D.1. The negotiation procedures applicable for each QOS parameter set are discussed in the subsequent subclauses of this annex.

Other QOS Parameter sets and the associated procedures are for further study.

TABLE D.1/I.365.3

QOS negotiation set and the coding of the QOS Set Identifier field of CC and CR PDUs

QOS Set Identifier	QOS Set Name	Description
0	Empty	No QOS negotiation
1	Standard	QOS negotiation supporting Recommendation X.214
All Others		Reserved for future QOS parameter sets

D.1 Parameters and their negotiation for the “Empty” QOS set

No QOS parameter negotiation takes place; hence, no parameters need to be transmitted nor are any procedures defined.

D.2 Parameters and their negotiation for the “Standard CONS” QOS set

The format of the QOS parameter set transmitted in the CR PDU and the CC PDU is shown in Figure D.1. For the format of the entire PDUs, see 10.2.

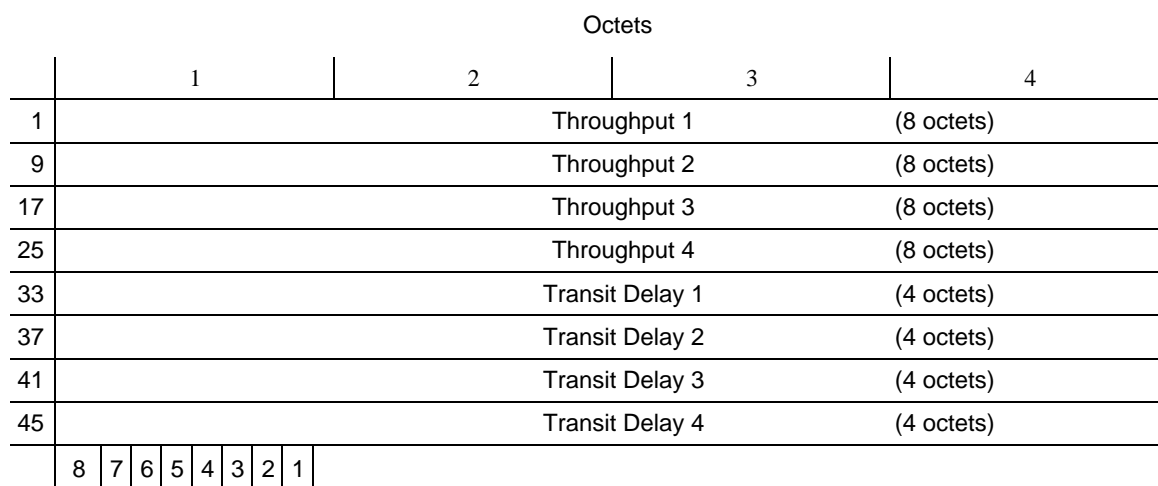

NOTE – Throughput fields are binary counts in units of 100 bytes/sec. Transit Delay fields are binary counts in units of milliseconds.

FIGURE D.1/I.365.3

Format of the Standard QOS Set parameters

D.2.1 QOS Parameters at the SSCF-COTS/SSCF-COTS user boundary

The parameters defined by Recommendation X.214 for modelling negotiation of throughput and delay QOS parameters in support of COTS and the relevant primitives across the SSCF-COTS/SSCF-COTS user boundary are summarized in Table D.2.

TABLE D.2/I.365.3

QOS parameters used in T(u)-CONNECT type primitives

Primitive	QOS Parameters		
	Local to peer	Peer to local	Both
T(u)-CONNECT-request	OU_TFL, OU_TFT	OU_TBL, OU_TBT	OU_DL, OU_DT
T(u)-CONNECT-indication	RU_TFL, RU_TFT	RU_TBL, RU_TBT	RU_DL, RU_DT
T(u)-CONNECT-response	RU_TFS	RU_TBS	RU_DS
T(u)-CONNECT-confirm	OU_TFS	OU_TBS	OU_DS

NOTE – The parameters identified in Table D.2 have the following definitions:

<i>Parameter</i>	<i>Information</i>
OU_DL	Largest acceptable transit delay in both directions.
OU_DS	Selected transit delay in both directions.
OU_DT	Target transit delay in both directions.
OU_TBL	Lowest acceptable throughput in the direction from the peer entity to the local entity.
OU_TBS	Selected throughput in the direction from the peer entity to the local entity.
OU_TBT	Target throughput in the direction from the peer entity to the local entity.
OU_TFL	Lowest acceptable throughput in the direction from the local entity to the peer entity.
OU_TFS	Selected throughput in the direction from the local entity to the peer entity.
OU_TFT	Target throughput in the direction from the local entity to the peer entity.
RU_DL	Largest acceptable transit delay in both directions.
RU_DS	Selected transit delay in both directions.
RU_DT	Target transit delay in both directions.
RU_TBL	Lowest acceptable throughput in the direction from the peer entity to the local entity.
RU_TBS	Selected throughput in the direction from the peer entity to the local entity.
RU_TBT	Target throughput in the direction from the peer entity to the local entity.
RU_TFL	Lowest acceptable throughput in the direction from the local entity to the peer entity.
RU_TFS	Selected throughput in the direction from the local entity to the peer entity.
RU_TFT	Target throughput in the direction from the local entity to the peer entity.

D.2.2 Negotiation of QOS Parameters

The originating SSCF-COTS user conveys the necessary QOS information to the SSCF-COTS as modelled in the T(u)-CONNECT-request primitive.

Each SSCF-COTS entity uses the following local information to determine the acceptability of the requested QOS parameters:

<i>Parameter</i>	<i>Information</i>
OP_TFM	Maximum available throughput in the direction from the local entity to the peer entity.
OP_TBM	Maximum available throughput in the direction from the peer entity to the local entity.
OP_DM	Minimum available transit delay in both directions.

If any of the following relations is true, then the local SSCF-COTS entity aborts the connection establishment due to unacceptable QOS parameters, in accordance with the procedures of clause 11:

OP_TFM	<	OU_TFL; or
OP_TBM	<	OU_TBL; or
OP_DM	>	OU_DL

Otherwise, the SSCF-COTS entity constructs a CR PDU with the QOS parameters set to the following values:

Throughput 1	:=	min(OU_TFT, OP_TFM)
Throughput 2	:=	OU_TFL
Throughput 3	:=	min(OU_TBT, OP_TBM)
Throughput 4	:=	OU_TBL
Transit delay 1	:=	max(OU_DT, OP_DM)
Transit delay 2	:=	OU_DL
Transit delay 3	:=	max(OU_DT, OP_DM)
Transit delay 4	:=	OU_DL

If any of the following relations is true, then the receiving SSCF-COTS entity aborts the connection establishment due to unacceptable QOS parameters, in accordance with the procedures of clause 11:

OP_TFM	>	Throughput 4; or
OP_TBM	>	Throughput 2; or
OP_DM	<	Transit Delay 2

Otherwise, the SSCF-COTS conveys the QOS information to the SSCF-COTS user as modelled with the T(u)-CONNECT-indication primitive.

This information is derived as follows:

RU_TFT	:=	min(Throughput 3, OP_TFM)
RU_TFL	:=	Throughput 4
RU_TBT	:=	min(Throughput 1, OP_TBM)
RU_TBL	:=	Throughput 2
RU_DT	:=	max(Transit Delay 1, OP_DM)
RU_DL	:=	Transit Delay 2

If the recipient SSCF-COTS user finds the throughput and delay objectives acceptable, it sends a T(u)-CONNECT-response primitive to the SSCF-COTS. A correct throughput and delay selection requires that all the following relationships are true:

RU_TFT	≥	RU_TFS	≥	RU_TFL
RU_TBT	≥	RU_TBS	≥	RU_TBL
RU_DT	≤	RU_DS	≤	RU_DL

Upon receipt of a T(u)-CONNECT-response primitive, the SSCF-COTS entity constructs a CC PDU with QOS parameters containing the following values:

Throughput 1	:=	RU_TFS
Throughput 2	:=	RU_TFS
Throughput 3	:=	RU_TBS
Throughput 4	:=	RU_TBS
Transit delay 1	:=	RU_DS
Transit delay 2	:=	RU_DS
Transit delay 3	:=	RU_DS
Transit delay 4	:=	RU_DS

If the recipient SSCF-COTS user cannot accept the connection establishment, it aborts the connection establishment due to unacceptable QOS parameters, in accordance with the procedures of clause 11.

Upon receipt of a CC PDU or a CR PDU (in case of connection establishment collision), the originating SSCF-COTS entity examines the received QOS parameters.

If Throughput 1	<	OU_TBL; or
if Throughput 2	>	min(OU_TBT, OP_TBM); or
if Throughput 3	<	OU_TFL; or
if Throughput 4	>	min(OU_TFT, OP_TFM); or
if Transit Delay 1	>	OU_DL; or
if Transit Delay 2	<	max(OU_DT, OP_DM);

then the QOS selected is unacceptable and the SSCF-COTS entity shall abort the connection establishment, in accordance with the procedures of clause 11.

If the parameters are acceptable, the selected QOS parameters are communicated to the SSCF-COTS user via the T(u)-CONNECT-confirm primitive with the following values:

OU_TFS	:=	min(Throughput 3, OU_TFT, OP_TFM)
OU_TBS	:=	min(Throughput 1, OU_TBT, OP_TBM)
OU_DS	:=	max(Transit Delay 1, OU_DT, OP_DM)

Annex E

Supplementary specification for the SCF (Recommendation Q.923)

(This annex forms an integral part of this Recommendation)

This annex provides the supplementary definitions for the SCF as required to complete the SCF specification contained in Recommendation Q.923 [3]; the following areas are further defined:

- adaptation of the primitive names to the Transport Service;
- selection of predicates influencing the behaviour of the SCF; and
- definition of the mapping function of the C-plane Sub-N-Service to the Q.2951 call control procedures.

E.1 Adaptation of the primitive names to the Transport Service

E.1.1 Introduction

This annex specifies how a Synchronization and Coordination Function (SCF) for the OSI Connection Oriented Transport Service (COTS) defined in Recommendation X.214 [7] can be derived from the specification of the SCF for the OSI Connection-Oriented Network Service (CONS) as specified in Recommendation Q.923 [3].

E.1.2 Abbreviations

The following additional abbreviations are used in this annex:

TC Transport Connection

TS (OSI Connection-Oriented) Transport Service

E.1.3 Interpretation

Every occurrence of the terms as defined in the left-hand column of Table E.1 is to be replaced by the term in the right-hand column.

TABLE E.1/I.365

Interpretation of terms to derive the SCF for COTS from the main part of this Recommendation

Term in Recommendation Q.923	Replacement term
N-Service User	T-Service User
N-Service Provider	T-Service Provider
N-Primitives	T-Primitives
NS (Network Service)	TS (Transport Service)
U-plane Sub-N-Service	U-plane Sub-T-Service
N(u)S (Network Service in U-plane)	T(u)S (Transport Service in U-plane)
N(u)-Service User	T(u)-Service User
N(u)-Service Provider	T(u)-Service Provider
N(u)-Primitives	T(u)-Primitives
NC (Network Connection)	TC (Transport Connection)
N(u)C (Network Connection in U-plane)	T(u)C (Transport Connection in U-plane)

E.1.4 X.214 type of service

Subclause 6.3.1/Q.923 should be replaced by the following text:

The T(u)S primitives, their association with phases, services and their parameters are basically the TC primitives defined in Table 3/X.214 and the state transition diagram for sequences of primitives at the T(u)C endpoint is basically the state transition diagram for sequences of primitives at the TC endpoint defined in Figure 5/X.214. Instead of T-primitives, T(u)-primitives apply.

E.1.5 Summary of the Sub-N-Service primitives at the N(c)C endpoint

Table 1/Q.923 [3] is replaced by Table E.2.

TABLE E.2/I.365.3

**Summary of the Sub-N-Service primitives at the N(c)C endpoint
[N(c)S primitives] and their parameters**

Phase	Service	Primitive	Provision	Parameters
Transport Connection establishment	Establishment	N(c)-CONNECT-request	M M UO UO CO	called address calling address expedited data option QOS-parameter set TS-user-data
		N(c)-CONNECT-indication	M M UO UO CO	called address calling address expedited data option QOS-parameter set TS-user-data
		N(c)-CONNECT-response	M UO UO CO	responding address expedited data option QOS-parameter set TS-user-data
		N(c)-CONNECT-confirm	M UO UO CO	responding address expedited data option QOS-parameter set TS-user-data
Transport Connection release	Release	N(c)-DISCONNECT-request	CO	TS-user-data
		N(c)-DISCONNECT-indication	M CO	disconnect reason TS-user-data

E.1.6 Deletion of the Reset service

As there exists no reset service in COTS, all references to the primitives “Reset-request”, “Reset-indication”, “Reset-response”, and “Reset-confirm” have to be deleted. Consequently, in Figure 3/Q.923 [3], the states 5 and 6 (“NS user invoked reset pending” and “NS provider invoked reset pending”) must be deleted.

As a further consequence, the states 5.4.5.0 and 6.4.6.0 in Figures 4/Q.923 and 5/Q.923 [3] must be deleted.

The list of primitives which cause a state transition in 6.4.1/Q.923 [3] is as follows:

- a) T-CONNECT-request.
- b) T-CONNECT-response.
- c) T-DISCONNECT-request.
- d) N(c)-CONNECT-indication.
- e) N(c)-CONNECT-confirm.
- f) N(c)-DISCONNECT-indication.
- g) T(u)-CONNECT-indication.
- h) T(u)-CONNECT-confirm.
- i) T(u)-DISCONNECT-indication.

The list of primitives which cause a state transition in 6.4.2/Q.923 [3] is as follows:

- a) T-CONNECT-request.
- b) T-CONNECT-response.
- c) T-DISCONNECT-request.

- d) N(c)-CONNECT-indication.
- e) N(c)-CONNECT-confirm.
- f) N(c)-DISCONNECT-indication.
- g) T(u)-CONNECT-indication.
- h) T(u)-CONNECT-confirm.
- i) T(u)-DISCONNECT-indication.
- j) T(u)-DISCONNECT-confirm.

E.1.7 State transition table

In the state transition table (Table 2/Q.923 [3]), the events must be renamed as shown in Table E.3.

TABLE E 3/I.365.3
Replacement of events in Table 2/Q.923 [3]

Event in Table 2/Q.923	Replacement event
N-CONNECT-request	T-CONNECT-request
N-CONNECT-response	T-CONNECT-response
N-DISCONNECT-request	T-DISCONNECT-request
N-DATA-request	T-DATA-request
N(u)-CONNECT-indication	T(u)-CONNECT-indication
N(u)-CONNECT-confirm	T(u)-CONNECT-confirm
N(u)-DISCONNECT-indication	T(u)-DISCONNECT-indication
N(u)-DATA-indication	T(u)-DATA-indication
N(u)-DISCONNECT-confirm	T(u)-DISCONNECT-confirm

The rows with the events “N-RESET-request”, “N-RESET-response”, “N(u)-RESET-indication”, “N(u)-RESET-confirm” are to be removed.

The columns with the states 5.4.5.0 and 6.4.6.0 are to be removed.

NOTE – The C-plane Sub-N-Service is not modified; hence, the events (and the primitives) for this service remain as specified in the main part. In particular, the events “N(c)-CONNECT-indication”, “N(c)-CONNECT-confirm”, “N(c)-DISCONNECT-indication”, and “N(c)-RESET-indication” in the state transition table remain.

E.2 Selection of predicates

The predicates are set as follows:

- P1 TRUE TS user involved in call establishment within C-plane.
- P2 TRUE Confirmed release service within U-plane.
- P3 FALSE For application of switched ATM connections.
TRUE For application of permanent ATM connections.

E.3 Mapping of the C-plane Sub-N-Service

This subclause provides the specification of the mapping between messages and some of their information elements specified in Recommendation Q.2951 [9] and N(c)-primitives according to Recommendation Q.923 [3] at the upper boundary of the C-plane Sub-N-Service which is provided by the call control at the user’s side of the User Network interface. See Tables E.4 to E.6.

TABLE E.4/I.365.3

Mappings for ATM Connection Establishment Phase

N(c)-primitives according to Recommendation Q.923 [3] and their parameters	Messages according to Recommendation Q.2951 [9] CS1 and referenced supplementary service Recommendations
Primitives:	Messages:
N(c)-CONNECT-request N(c)-CONNECT-indication N(c)-CONNECT-response N(c)-CONNECT-confirm	SETUP(U→N) SETUP(N→U) CONNECT(U→N) CONNECT(N→U)
Parameters:	Information elements:
Called address Calling address Responding address Expedited data selection QOS parameter set: Throughput Transit delay TS-User-Data	Called party number Called party sub-address Calling party number Calling party sub-address according to Recommendation Q.2951 [9] Connected party number Connected party sub-address (Note 1) ATM Traffic Descriptor End-to-end transit delay (Note 1)
NOTES	
1 This parameter is carried in the user-to-user information element according to Recommendation Q.2957 [10] (see Table E.6).	
2 Each parameter might be transferred on both C-plane and U-plane.	

TABLE E.5/I.365.3

Mappings for ATM Connection Release Phase

N(c)-primitives according to Recommendation Q.923 [3] and their parameters	Messages according to Recommendation Q.2951 [9] CS1 and referenced supplementary service Recommendations
Primitives:	Messages:
N(c)-DISCONNECT-request N(c)-DISCONNECT-indication	RELEASE(U→N), RELEASE COMPLETE(U→N) RELEASE(N→U), RELEASE COMPLETE(N→U), RESTART(N→U)
Parameters:	Information elements:
Reason Responding address TS-User-Data	Cause Connected party number Connected party sub-address according to Recommendation Q.2957 [10] User-to-user information
NOTE – Each parameter might be transferred on both C-plane and U-plane.	

TABLE E.6/I.365.3

Coding of the user-to-user information element

Message	Coding of the user-to-user information element
SETUP(U→N) and SETUP(N→U)	Complete CR PDU (see 10.2)
CONNECT(U→N) and CONNECT(N→U)	Complete CC PDU (see 10.2)

Appendix I

T(u)-primitive sequences at the UNI for connection establishment and release within the U-plane and their relationship to AA-signals and SSCOP PDU sequences

(This appendix does not form an integral part of this Recommendation)

This appendix presents the most relevant sequences for an analysis of the procedures. The peer-to-peer sequences of SSCOP PDUs are related to AA-signals and T(u)-primitives.

Figures I.1 to I.4 illustrate various connection establishment cases including collisions and corruption (loss) of PDUs.

NOTE 1 – Connection establishment affects both transmission directions simultaneously.

Figure I.5 illustrates a case where a connection establishment request is rejected.

Figures I.6 and I.7 illustrate two connection rejection cases due to insufficient Quality of Service or an unreachable address.

Figures I.8 to I.11 illustrate various connection release cases including collisions and corruption (loss) of PDUs.

NOTE 2 – Connection release affects both transmission directions simultaneously.

Figure I.12 illustrates a case where an AA-RESYNC-indication signal is received. No SSCF-COTS procedures lead to such a signal. As the result leads to state 4.4 (“TS Provider Invoked Disconnection Pending”) is the same as after a recovery situation, the various cases including collisions and corruption (loss) of PDUs are shown in Figures I.16 to I.19.

Figures I.13 to I.16 illustrate various SSCOP error recovery cases including collisions and corruption (loss) of PDUs. The SSCOP error recovery procedure is signalled via the AA-RECOVER-indication signal.

NOTE 3 – SSCOP error recovery leads to a provider initiated connection release.

Figure I.17 illustrates a contention case where a new connection is being established before the peer has completed the previous connection release.

Figure I.18 illustrates a contention case where a TS provider disconnection and a TS user disconnection are invoked concurrently.

Figure I.19 illustrates a case where a connection control service is invoked before the previous one has been completed by both peers.

Figure I.20 illustrates another contention case where a TS provider disconnection and a TS user disconnection are invoked concurrently.

Figure I.21 illustrates a case where connection control services are invoked simultaneously.

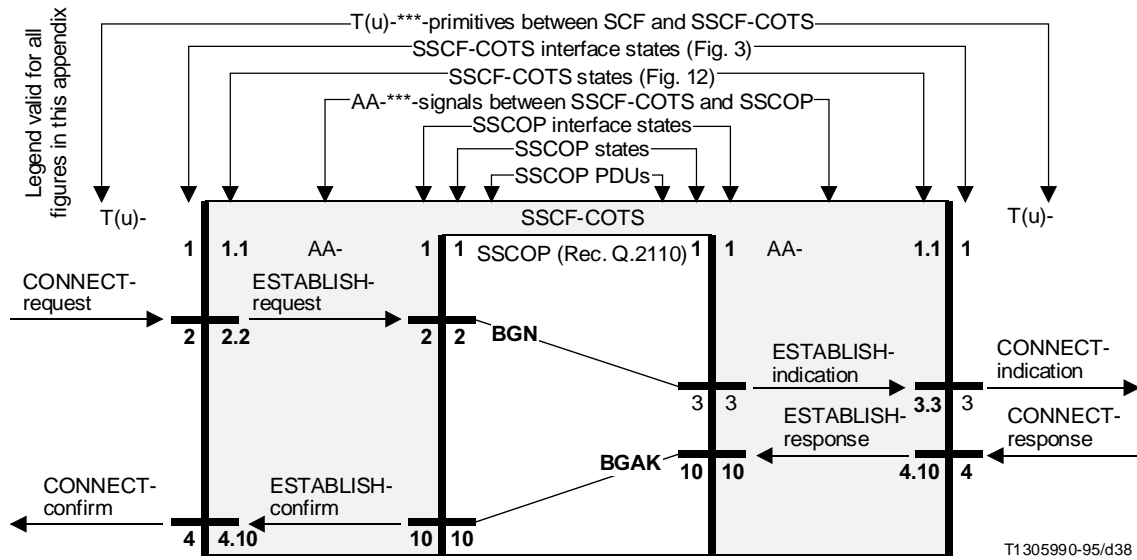

FIGURE I.1/I.365.3
 Sequences for establishing a T(u)-connection

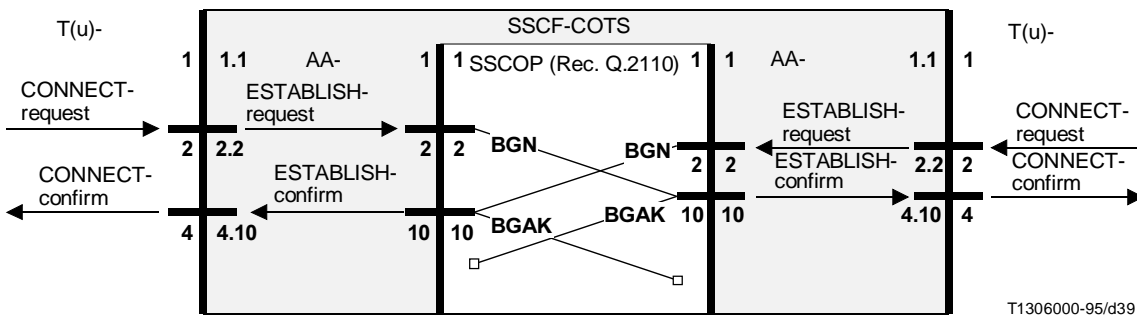

FIGURE I.2/I.365.3
 Sequences for establishing a T(u)-connection with collision

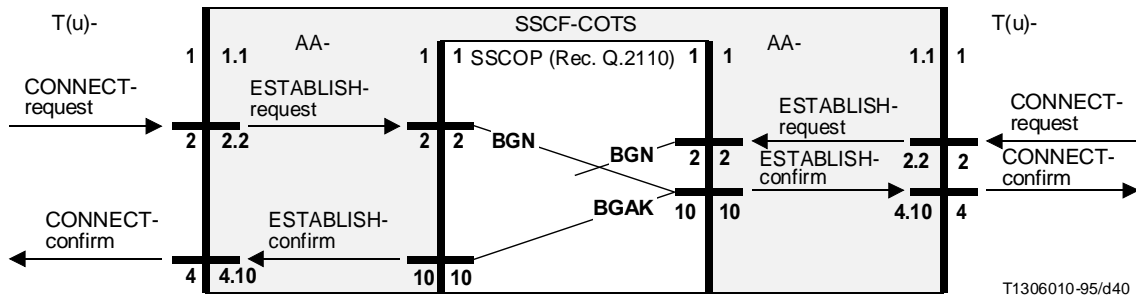

FIGURE I.3/I.365.3
Sequences for establishing a T(u)-connection and corruption

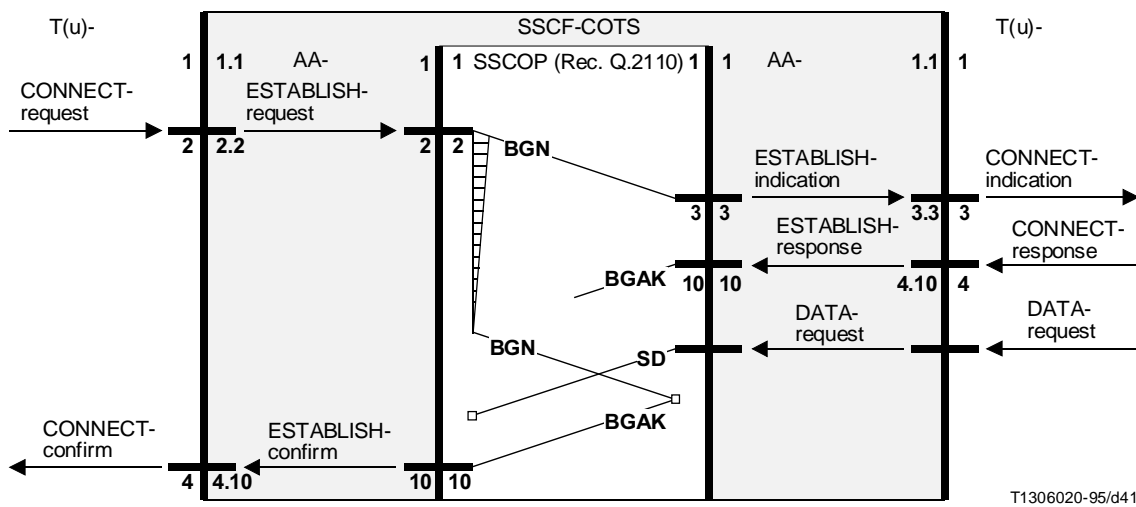

FIGURE I.4/I.365.3
Sequences for establishing a T(u)-connection with corruption and premature DATA-PDU

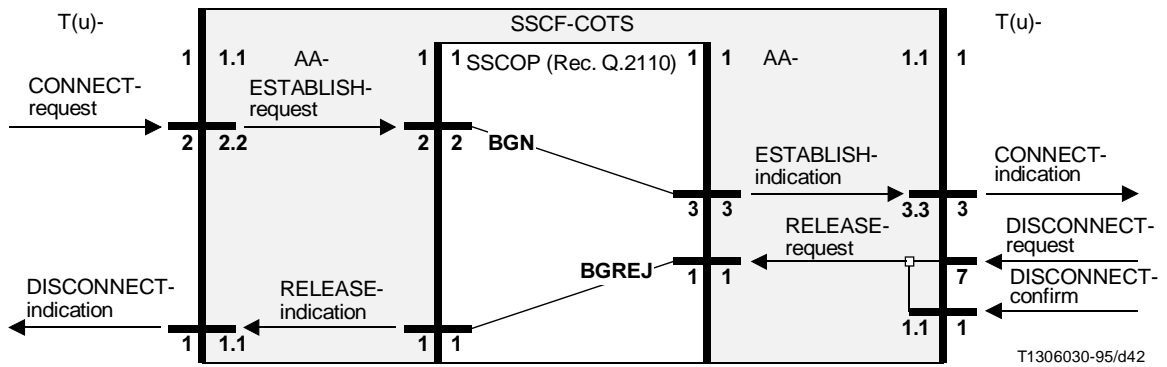

FIGURE I.5/I.365.3
Sequences for attempting to establish a T(u)-connection (rejection)

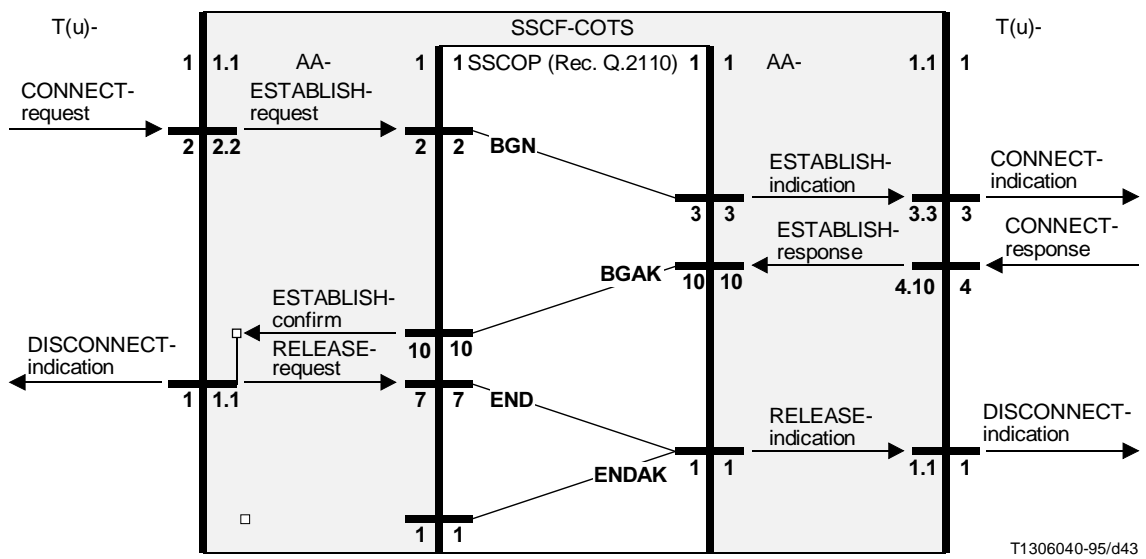

FIGURE I.6/I.365.3
Sequences for attempting to establish a T(u)-connection (rejection)

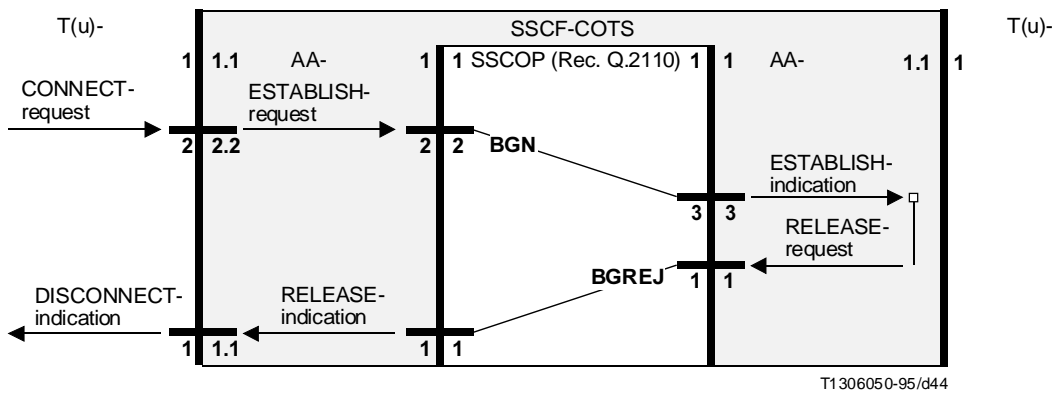

FIGURE I.7/I.365.3
Sequences for attempting to establish a T(u)-connection (rejection)

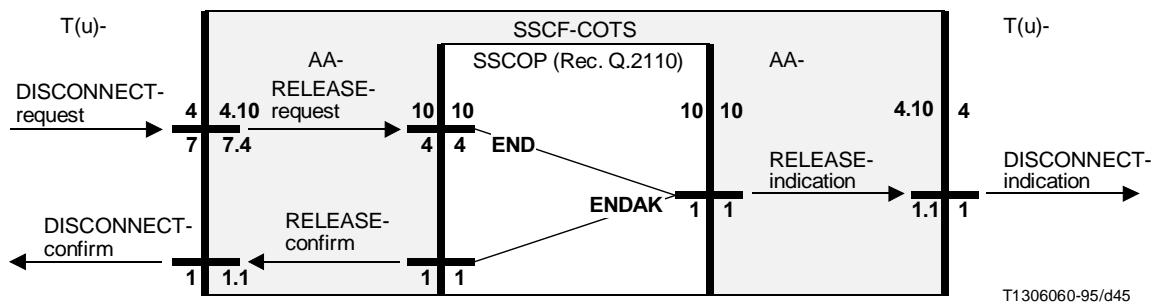

FIGURE I.8/I.365.3
Sequences for releasing an N(u)-connection

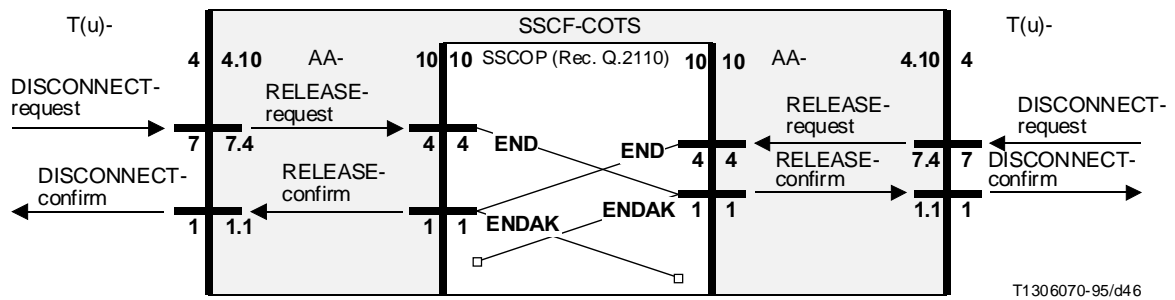

FIGURE I.9/I.365.3
Sequences for releasing a T(u)-connection with collision

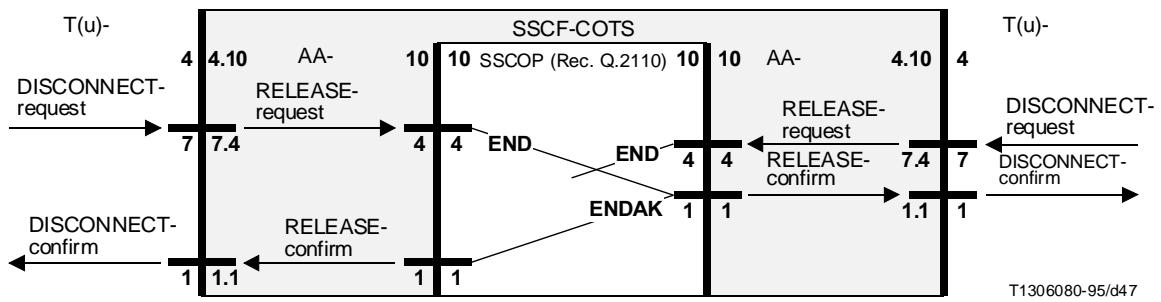

FIGURE I.10/I.365.3
Sequences for releasing a T(u)-connection with collision and corruption

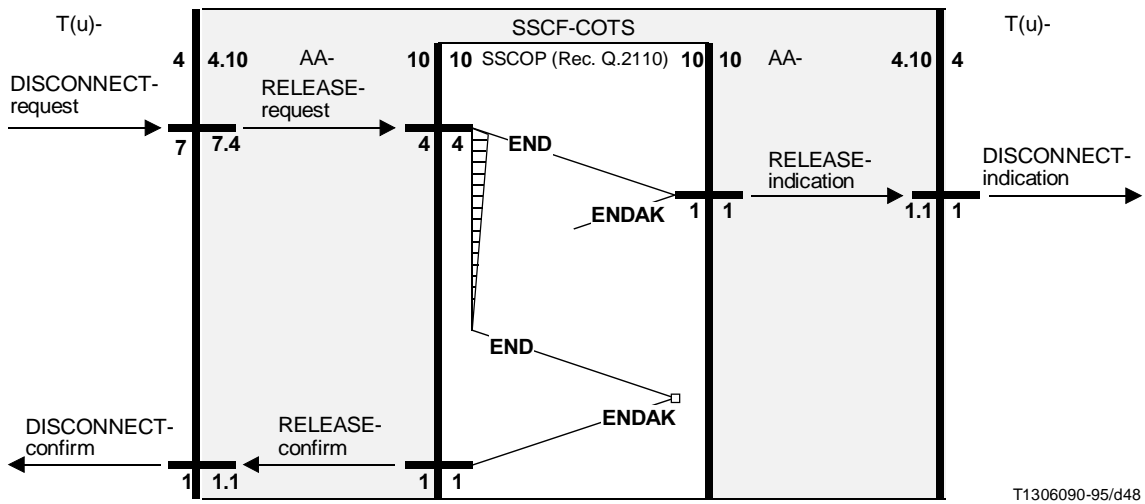
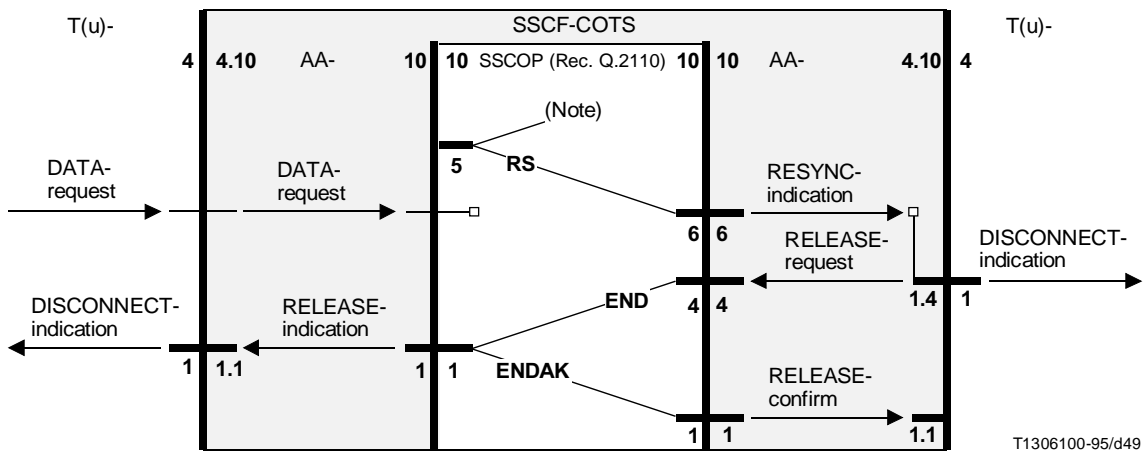

FIGURE I.11/I.365.3
Sequences for releasing a T(u)-connection with corruption



NOTE – No SSCF-COTS procedure leads to an AA-RESYNC-indication.

FIGURE I.12/I.365.3
Sequences for resetting an AA-RESYNC-indication

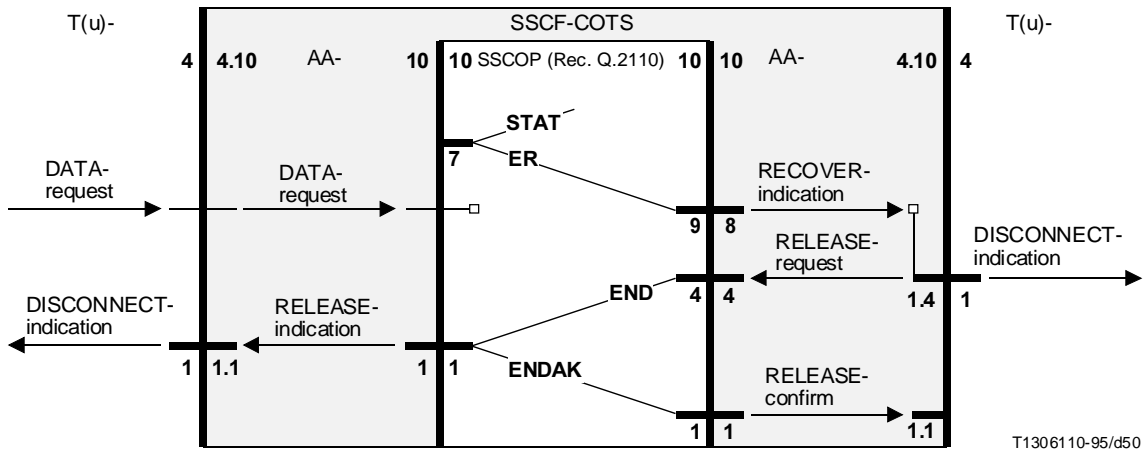

FIGURE I.13/I.365.3
Sequences for provider initiated release of a T(u)-connection

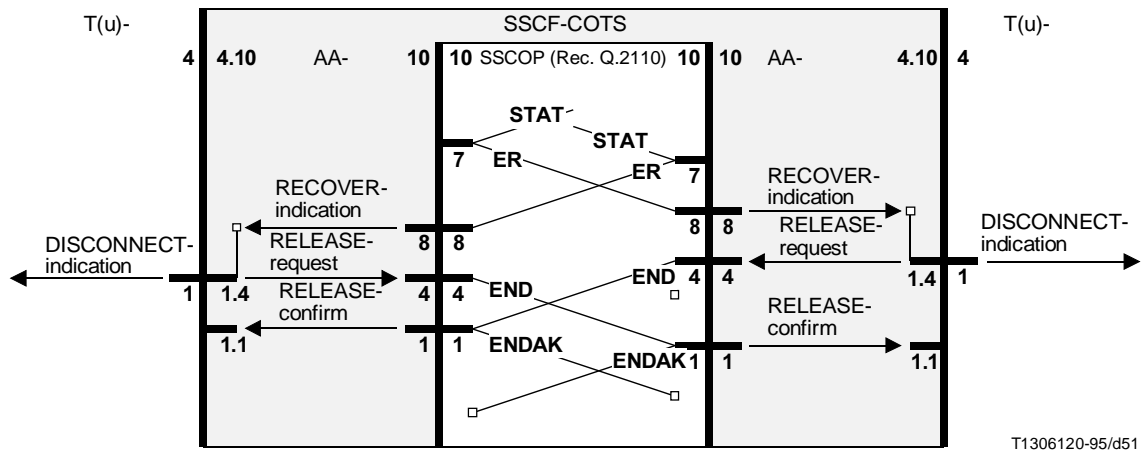
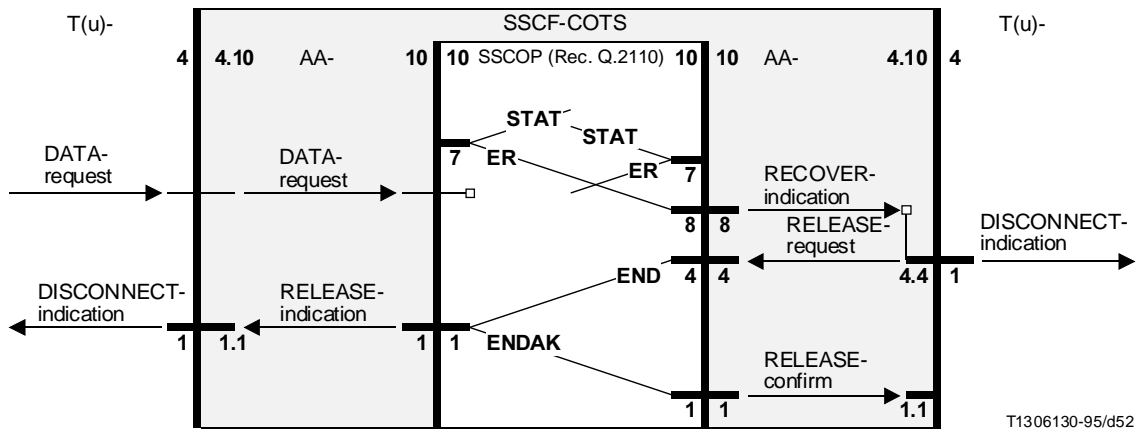

FIGURE I.14/I.365.3
Sequences for provider initiated release of a T(u)-connection with collision



T1306130-95/d52

FIGURE I.15/I.365.3

Sequences for provider initiated release of a T(u)-connection with collision and corruption

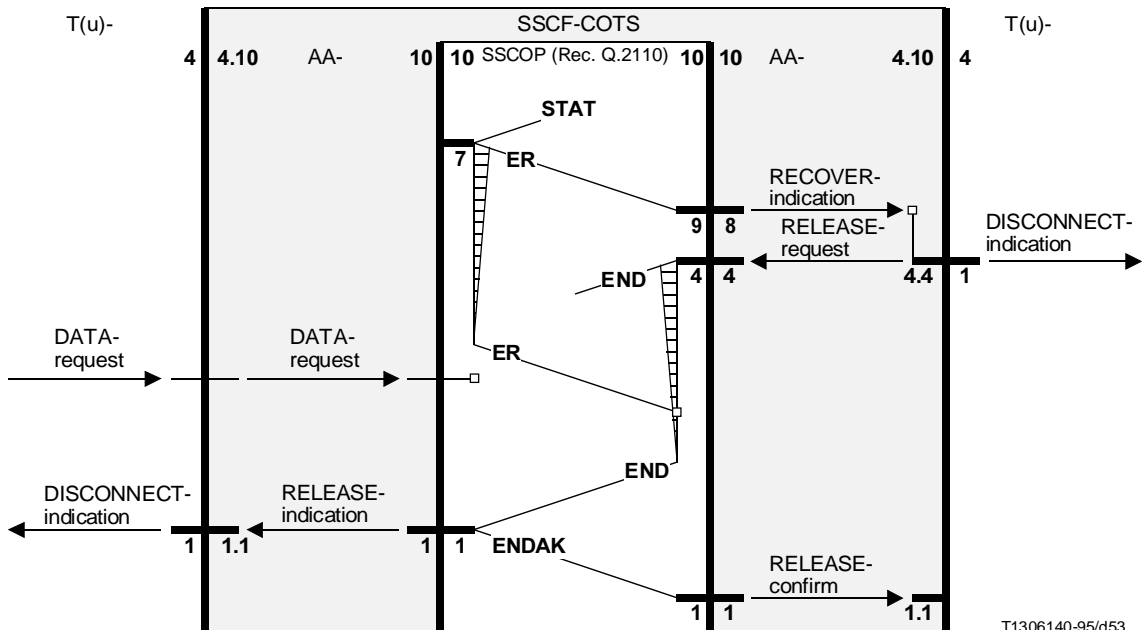

T1306140-95/d53

FIGURE I.16/I.365.3

Sequences for provider initiated reset of a T(u)-connection with corruption and premature DATA-PDU

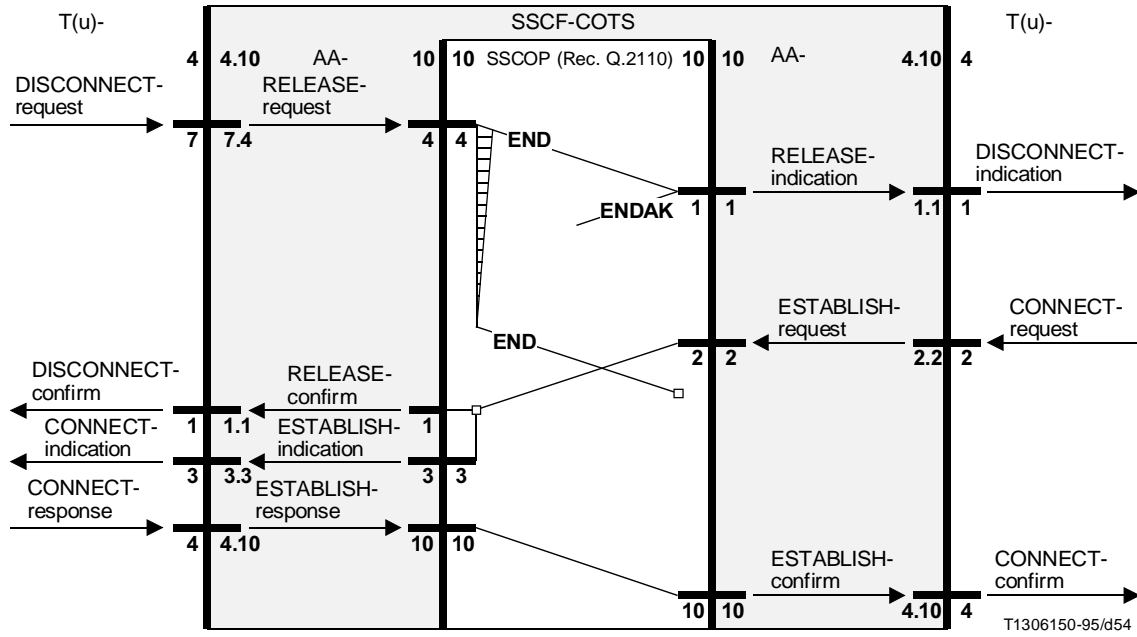

FIGURE I.17/I.365.3
Sequences for release of a T(u)-connection PDU corruption followed by a T(u)-connection establishment

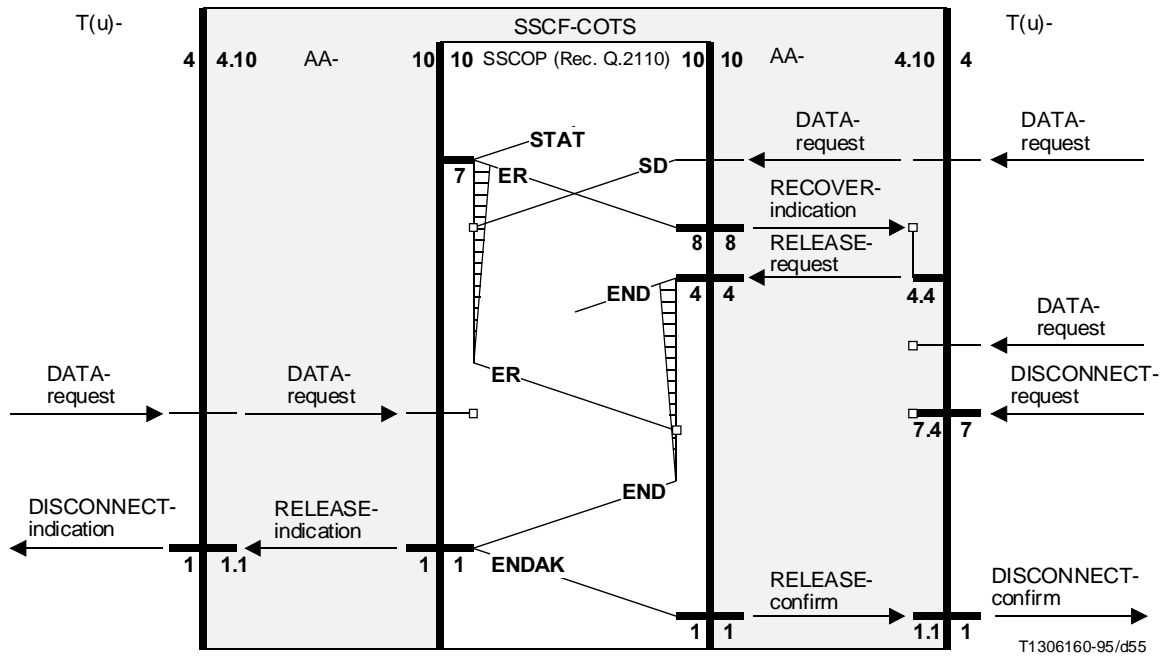

FIGURE I.18/I.365.3
Sequences for provider initiated release of a T(u)-connection with PDU followed by a connection release

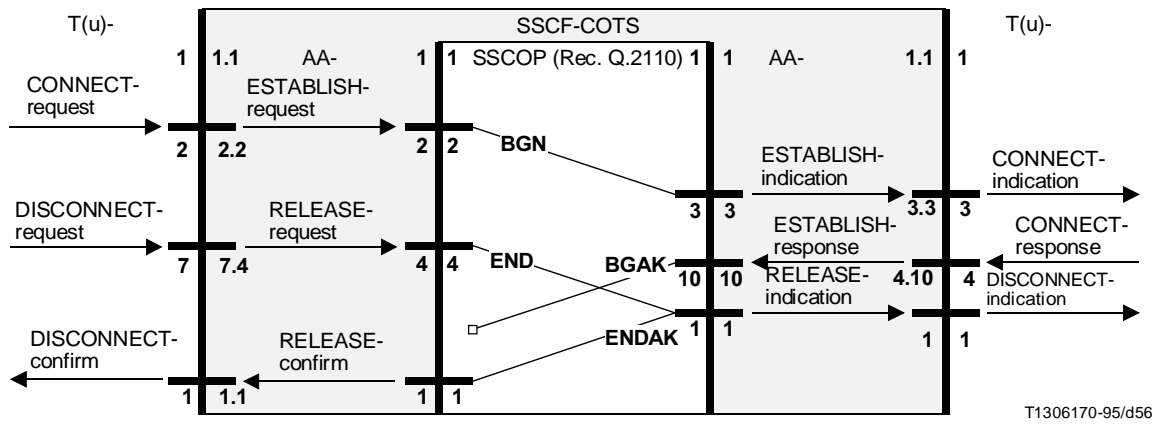

FIGURE I.19/I.365.3
Sequences for establishing a T(u)-connection followed immediately by a release

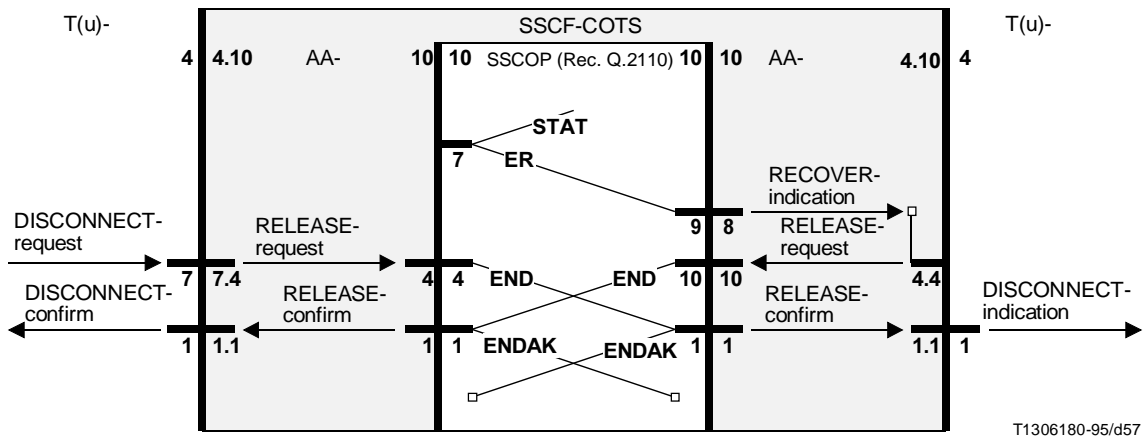

FIGURE I.20/I.365.3
Sequences for a provider initiated release of a T(u)-connection followed immediately by a user release

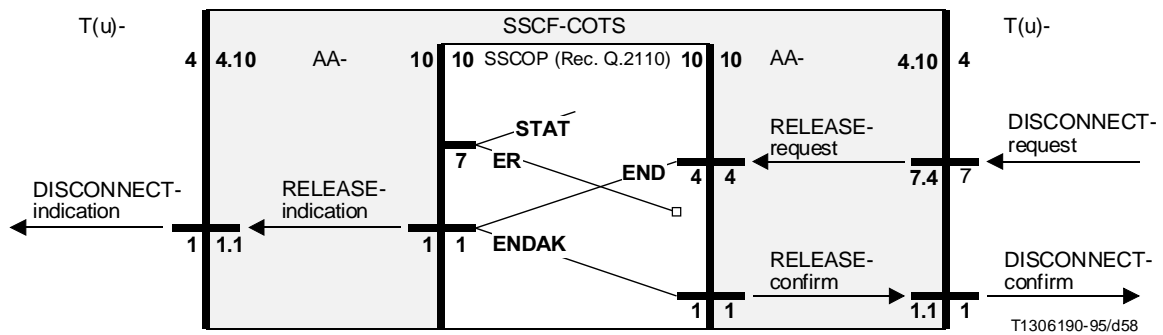

FIGURE I.21/I.365.3
Sequences for release of a T(u)-connection concurrently with a provider initiated release

Appendix II

Further considerations for the default values for the SSCOP parameters and timers

(This appendix does not form an integral part of this Recommendation)

This appendix presents a short discussion on the interdependence of some of SSCOP's parameters.

II.1 Definitions

Mark	Unit	Description	
r	bit/s	Transmission rate	
rtd	s	Round trip delay	
tr	bit	Bandwidth-delay-product	$r \cdot rtd$
z	octet/frame	Frame size	
Tr	frame	Bandwidth-delay-product	$\frac{r \cdot rtd}{8 \cdot z}$
e		Bit error ratio	
p		Frame error ratio	$1 - (1 - e)^{8 \cdot z}$
tp	s	Timer_POLL	
Tp	frame	Timer_POLL	$\frac{r \cdot tp}{8 \cdot z}$
W	frame	Window	
T	s/frame	Time slot	$\frac{8 \cdot z}{r}$
TR	frame	Bandwidth-delay-product	$\lceil (Tr) \rceil$
TP	frame	Timer_POLL	$\lceil (Tp) \rceil$

The transmission rate “r” is the negotiated maximum channel bit rate, e.g. allocated via a peak bit rate negotiation. For the sake of the analysis in this appendix, the time axis is considered to be quantized with the time required to transmit a full size frame. The direct bandwidth-delay-product “tr” is measured in “bit”; however, the entity “Tr” is more appropriate to the ensuing discussion if measured in “frame”; considering in addition the quantized time axis, “TR” is the bandwidth-delay-product rounded up to the next integer value.

Similar considerations hold for Timer_POLL “tp” that is normally expressed in “s” (seconds) and “Tp” that for our discussion is expressed in “frame”; the rounded value is indicated by “TP”.

II.2 Goal

For a given environment where SSCOP is utilized and that is characterized by the triplet (r, rtd, e) the relationship between the throughput, efficiency and the protocol parameter triplet (W, z, tp) is sought.

II.3 Frame size

Figure II.1 shows the relationship between bit error rate “e”, frame size “z”, and frame error rate “p”. For similar performances with varying bit error rates, the frame size needs to be adapted. In general, with better (i.e. smaller) bit error rate, the frames can be made larger and the per frame protocol overhead can be reduced.

NOTE – For this analysis, bit errors in cell headers are considered negligible.

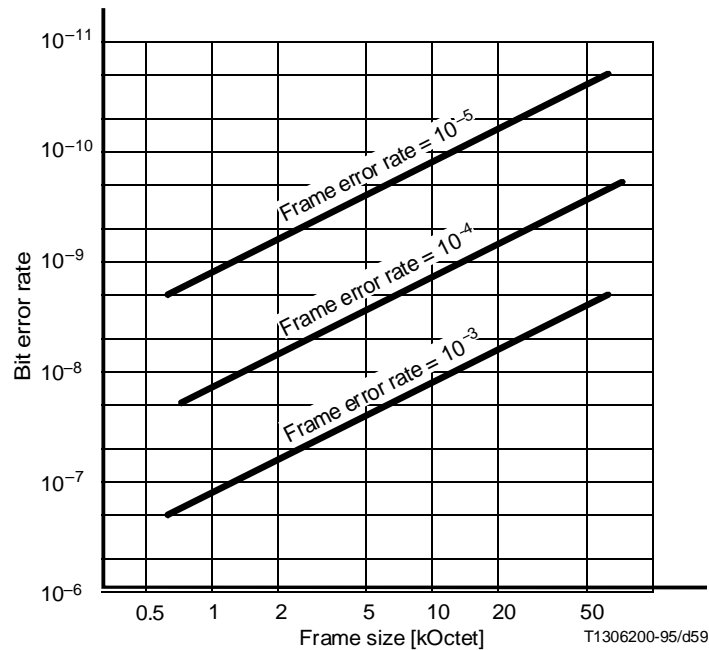

FIGURE II.1/I.365.3

Relationship between “bit error rate”, “frame size”, and “frame error rate”

II.4 Qualitative Analysis

II.4.1 Assumptions

For the qualitative analysis it is assumed that the transmission time of the SSCOP PDUs “POLL”, “STAT”, and “USTAT” does not influence the timing, i.e. their transmission time and bandwidth requirement are ignored.

It is also assumed that the transmitter has enough data to send such that no sending intermissions need to be considered for the time duration of the observations. This fact can be utilized to define a time slot “T” that is equivalent to the time required to send a frame. The round trip delay can also be expressed in number of frames “Tr” and rounded up to the next integer value of time slots “TR”. Similarly, the Timer_POLL “tp” expressed in frames “Tp” rounded up is identified by “TP”.

II.4.2 Timing in the absence of errors

Figure II.2 shows the timing when no frames are corrupted. The status of the frame transmitted immediately after a POLL PDU has been transmitted is requested with the next POLL PDU, i.e. after TP time slots. The associated STAT PDU is interpreted by the transmitter after another TR time slots. Therefore, the credit update at the transmitter will take place at time TR + TP.

Hence, in order to sustain the transmission of frames, the window “W” must be at least TR + TP. If the window size is smaller, the sender has not enough credits for continuous transmission of frames.

NOTE – In the absence of corrupted frames, there are no resequencing buffers required at the receiver.

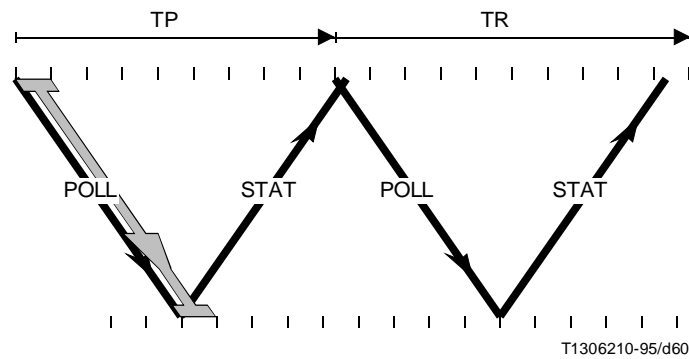

FIGURE II.2/I.365.3
Timing in the absence of errors

II.4.3 Timing for single corrupted data frame correction

Figure II.3 shows the timing when frames may be corrupted. The first frame at the left is fully transmitted at time “1” and is assumed to be corrupted and, therefore, lost. It should have been received at time $Tr/2 + 1$. However, the receiver will notice the loss only after receipt of the next frame at time $Tr/2 + 2$. The USTAT will be immediately sent back to the transmitter where it will arrive at $Tr + 2$ and will be interpreted at time $TR + 2$. The frame can be retransmitted immediately and has then left the transmitter again at time $TR + 3$ as indicated in the figure.

In general, Timer_POLL is not synchronized with the corruption of data. However, for the worst case analysis, it is assumed that a POLL PDU has been sent at time $TR + 2$ just before the retransmission was initiated. The next POLL PDU will not be sent before TP time slots; the return and interpretation of the STAT PDU acknowledging the retransmitted frame requires another TR time slots (see Figure II.3).

Therefore, the credit update at the transmitter will take place at time $2 \cdot TR + TP + 2$. If the window “W” is at least $2 \cdot TR + TP + 1$, the transmitter will never idle due to window closure.

NOTES

- 1 One time slot was used for retransmission of a frame, this does not consume a credit.
- 2 In Figure II.3, not all POLL and STAT PDUs are shown.

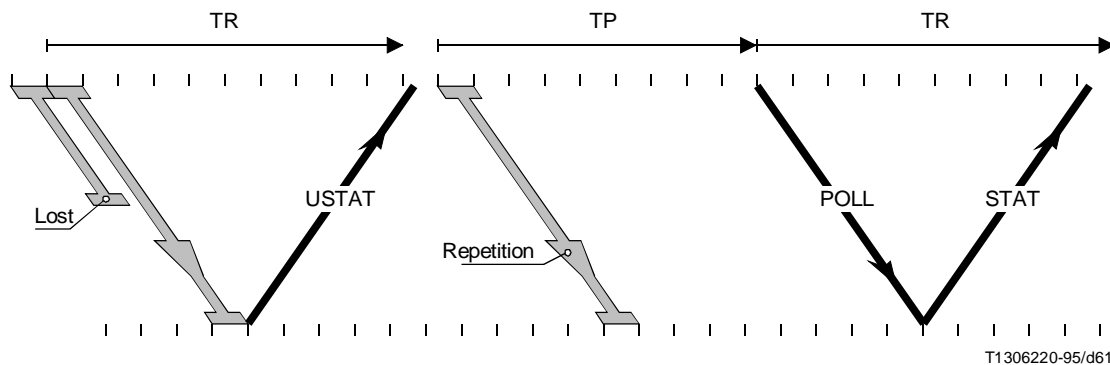
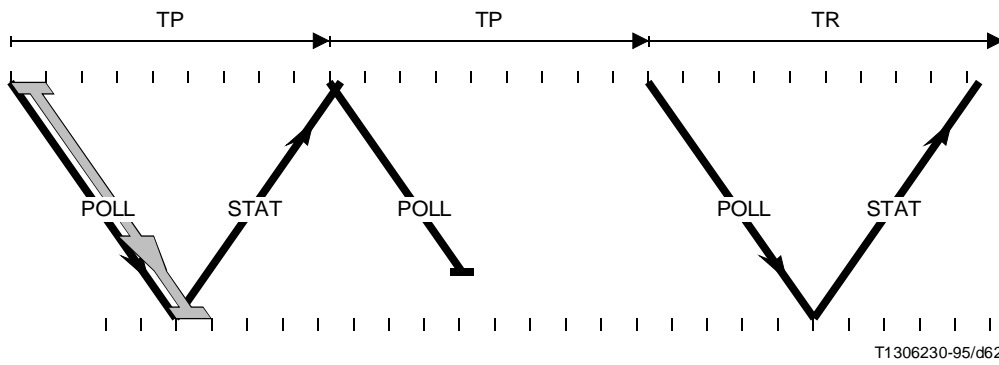

FIGURE II.3/I.365.3
Timing for single error correction (DATA PDU)



T1306230-95/d62

FIGURE II.4/I.365.3
Timing for single error correction (POLL PDU)

II.4.4 Timing for single corrupted POLL or STAT PDU

Figure II.4 shows the timing when a POLL or STAT PDU is corrupted. The worst case concerns the longest outstanding frame acknowledgement which in the figure is shown at the left. It can be seen that the window "W" must be at least $2 \cdot TP + TR$.

NOTE – For this situation, there are no resequencing buffers required at the receiver and no information is retransmitted.

II.4.5 Multiple errors

The analysis in the previous subclauses assumed that all retransmissions were successful. The probability of a frame being delivered in k or fewer attempts is $(1 - p^k)$ or $(1 - (1 - e)^8 \cdot z)^k$. In general, therefore, the assumption above is valid for frame error rates "p" better than 10^{-3} .

II.5 Conclusion

With the frame size adjusted to an acceptable frame error rate, it is suggested that the credit window "W" (in frames) offered by the receiver to the transmitter be the larger of either $2 \cdot TR + TP + 1$ or $2 \cdot TP + TR$, where "TP" and "TR" are defined in II.1. This will compensate for single PDU loss events while maintaining the potential for uninterrupted data transfer.