



INTERNATIONAL TELECOMMUNICATION UNION

ITU-T

TELECOMMUNICATION
STANDARDIZATION SECTOR
OF ITU

I.361

(02/99)

SERIES I: INTEGRATED SERVICES DIGITAL
NETWORK

Overall network aspects and functions – Protocol layer
requirements

B-ISDN ATM layer specification

ITU-T Recommendation I.361

(Previously CCITT Recommendation)

ITU-T I-SERIES RECOMMENDATIONS
INTEGRATED SERVICES DIGITAL NETWORK

GENERAL STRUCTURE	
Terminology	I.110–I.119
Description of ISDNs	I.120–I.129
General modelling methods	I.130–I.139
Telecommunication network and service attributes	I.140–I.149
General description of asynchronous transfer mode	I.150–I.199
SERVICE CAPABILITIES	
Scope	I.200–I.209
General aspects of services in ISDN	I.210–I.219
Common aspects of services in the ISDN	I.220–I.229
Bearer services supported by an ISDN	I.230–I.239
Teleservices supported by an ISDN	I.240–I.249
Supplementary services in ISDN	I.250–I.299
OVERALL NETWORK ASPECTS AND FUNCTIONS	
Network functional principles	I.310–I.319
Reference models	I.320–I.329
Numbering, addressing and routing	I.330–I.339
Connection types	I.340–I.349
Performance objectives	I.350–I.359
Protocol layer requirements	I.360–I.369
General network requirements and functions	I.370–I.399
ISDN USER-NETWORK INTERFACES	
Application of I-series Recommendations to ISDN user-network interfaces	I.420–I.429
Layer 1 Recommendations	I.430–I.439
Layer 2 Recommendations	I.440–I.449
Layer 3 Recommendations	I.450–I.459
Multiplexing, rate adaption and support of existing interfaces	I.460–I.469
Aspects of ISDN affecting terminal requirements	I.470–I.499
INTERNETWORK INTERFACES	I.500–I.599
MAINTENANCE PRINCIPLES	I.600–I.699
B-ISDN EQUIPMENT ASPECTS	
ATM equipment	I.730–I.739
Transport functions	I.740–I.749
Management of ATM equipment	I.750–I.799

For further details, please refer to ITU-T List of Recommendations.

ITU-T RECOMMENDATION I.361

B-ISDN ATM LAYER SPECIFICATION

Summary

This Recommendation specifies ATM header bit assignments including ATM cell structure and the associated coding for both NNI and UNI, defines service primitives to be exchanged with upper and lower layers and with the ATM management entity, and specifies ATM protocol procedures for GFC.

Source

ITU-T Recommendation I.361 was revised by ITU-T Study Group 13 (1997-2000) and was approved under the WTSC Resolution No. 1 procedure on the 26th of February 1999.

FOREWORD

ITU (International Telecommunication Union) is the United Nations Specialized Agency in the field of telecommunications. The ITU Telecommunication Standardization Sector (ITU-T) is a permanent organ of the ITU. The ITU-T is responsible for studying technical, operating and tariff questions and issuing Recommendations on them with a view to standardizing telecommunications on a worldwide basis.

The World Telecommunication Standardization Conference (WTSC), which meets every four years, establishes the topics for study by the ITU-T Study Groups which, in their turn, produce Recommendations on these topics.

The approval of Recommendations by the Members of the ITU-T is covered by the procedure laid down in WTSC Resolution No. 1.

In some areas of information technology which fall within ITU-T's purview, the necessary standards are prepared on a collaborative basis with ISO and IEC.

NOTE

In this Recommendation the term *recognized operating agency (ROA)* includes any individual, company, corporation or governmental organization that operates a public correspondence service. The terms *Administration*, *ROA* and *public correspondence* are defined in the *Constitution of the ITU (Geneva, 1992)*.

INTELLECTUAL PROPERTY RIGHTS

The ITU draws attention to the possibility that the practice or implementation of this Recommendation may involve the use of a claimed Intellectual Property Right. The ITU takes no position concerning the evidence, validity or applicability of claimed Intellectual Property Rights, whether asserted by ITU members or others outside of the Recommendation development process.

As of the date of approval of this Recommendation, the ITU had received notice of intellectual property, protected by patents, which may be required to implement this Recommendation. However, implementors are cautioned that this may not represent the latest information and are therefore strongly urged to consult the TSB patent database.

© ITU 1999

All rights reserved. No part of this publication may be reproduced or utilized in any form or by any means, electronic or mechanical, including photocopying and microfilm, without permission in writing from the ITU.

CONTENTS

	Page
1	Introduction 1
2	Cell structure coding 1
2.1	Cell structure 1
2.2	Cell header format and encoding at UNI..... 1
2.2.1	Pre-assigned values of the physical cell header 2
2.2.2	Generic Flow Control (GFC) field..... 2
2.2.3	Routing field (VPI/VCI)..... 3
2.2.4	Payload Type (PT) field..... 5
2.2.5	Cell Loss Priority (CLP) field 6
2.2.6	Header Error Control (HEC) field..... 6
2.3	Cell header format and encoding at NNI..... 6
2.3.1	Pre-assigned values of the cell header..... 7
2.3.2	Routing field (VPI/VCI)..... 7
2.3.3	Payload Type (PT) field 9
2.3.4	Cell Loss Priority (CLP) field 9
2.3.5	Header Error Control (HEC) field..... 10
2.4	Cell information field 10
2.4.1	Pre-assigned values 10
3	Service primitives..... 10
3.1	Primitives exchanged with the upper layer 10
3.1.1	Description of primitives 10
3.1.2	Descriptions of parameters..... 10
3.2	Primitives exchanged with the lower layer 11
3.2.1	Description of primitives 11
3.2.2	Description of parameter..... 11
3.3	Primitives exchanged with ATM Management (ATMM) -entity 12
3.3.1	Description of primitives 13
3.3.2	Description of parameters 13
4	ATM protocol procedures 15
4.1	GFC protocol procedures 15
4.1.1	GFC field assignment..... 15
4.1.2	GFC procedures 16
4.2	Layer management communication..... 19

	Page
4.3 Layer management	19
4.3.1 Fault management	19
4.3.2 Performance management	19
4.3.3 Configuration management	19
4.3.4 Resource management	20
Annex A – Alphabetical list of abbreviations used in this Recommendation	20
Annex B – SDL diagrams for GFC procedures	21
Appendix I – Pre-assigned values of physical cell headers	33

Recommendation I.361

B-ISDN ATM LAYER SPECIFICATION

(revised in 1999)

1 Introduction

This Recommendation specifically addresses:

- a) the cell structure and the ATM cell coding;
- b) the ATM protocol procedures.

2 Cell structure coding

Two different coding schemes have been adopted: the UNI format and the NNI format. They are described in 2.2 and 2.3.

2.1 Cell structure

The cell consists of a five-octet header and a 48-octet information field as shown in Figure 1.

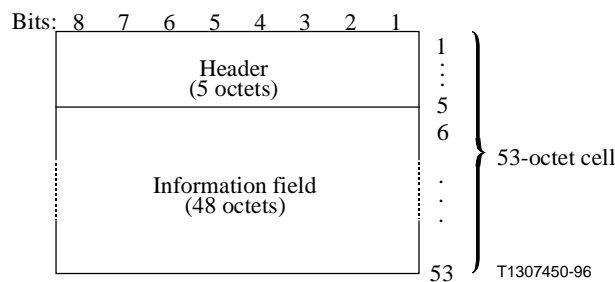

Figure 1/I.361 – Cell structure at the UNI/NNI

NOTE – The header will be sent first followed by the information field.

When a field within the header is contained within a single octet, the lowest bit number of the field represents the lowest order value.

When a field spans more than one octet, the order of bit values within each octet progressively decreases as the octet number increases; the lowest bit number associated with the field represents the lowest order value.

This leads to the following conventions:

- bits within an octet are sent in decreasing order, starting with bit 8;
- octets are sent in increasing order, starting with octet 1;
- for all fields, the first bit sent is the Most Significant Bit (MSB).

2.2 Cell header format and encoding at UNI

The structure of the header is shown in Figure 2. The fields contained in the header and their encoding are described in the following subclauses.

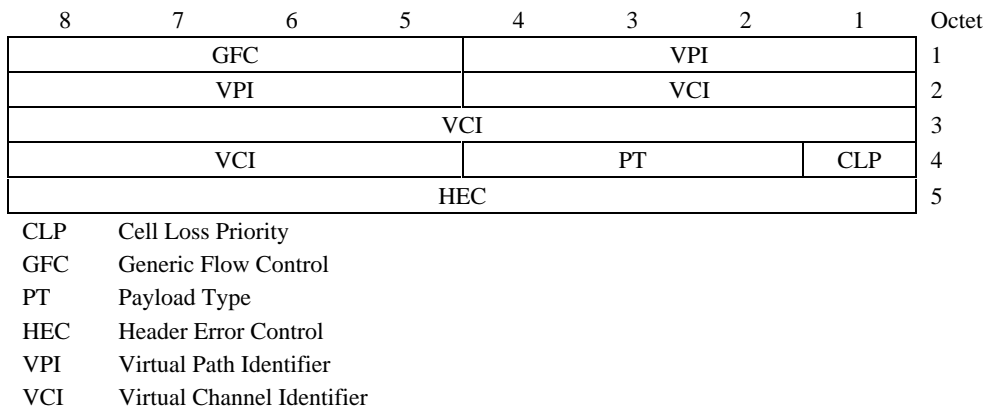

Figure 2/I.361 – Header structure at UNI

2.2.1 Pre-assigned values of the physical cell header

Physical cells are reserved for use by the Physical layer. These cells are not passed from the Physical layer to the ATM layer.

Pre-assigned values of the cell header (to differentiate cells for the use of the ATM layer from cells for the use of the Physical layer) are given in Table 1. In the case of Physical cells, the bit in the location of the CLP indication is not used for the CLP mechanism as specified in 3.4.2.3.2/I.150. All other values which are described in Tables 2 and 4 are for the use of the ATM layer.

Table 1/I.361 – Pre-assigned Physical cell header values (excluding the HEC field)

	Octet 1	Octet 2	Octet 3	Octet 4
Idle cell identification	00000000	00000000	00000000	00000001
Reserved for use of the Physical layer (Note)	PPPP0000	00000000	00000000	0000PPP1
P Indicates the bit is available for use by the Physical layer. Values assigned to these bits have no meaning with respect to the fields occupying the corresponding bit positions at the ATM layer. NOTE – Specific pre-assigned physical layer cell header values are given in Recommendation I.432-series and in other Recommendations related to Physical layer (see Appendix I).				

2.2.2 Generic Flow Control (GFC) field

The GFC field contains 4 bits.

The following provides an overview of the GFC functions for the valid codings of the GFC field (see 4.1.1).

Uncontrolled equipment will always set the GFC field to 0000. Coding of this field by controlling and controlled equipment is given in 4.1.1. The controlled equipment default mode provides for a single queue for controlled ATM connections and allows uncontrolled ATM connections. The two-queue model provides for two queues for controlled ATM connections and allows uncontrolled ATM connections. At any given instant of time, controlled equipment which may not have any controlled ATM connections active will continue to respond to the HALT command.

In the direction from the controlling equipment to the controlled equipment, the GFC field is defined as follows: (When the GFC function is not used, the value of this field is 0000.)

- The first bit indicates HALT (bit set to 1)/NO_HALT(0).

The HALT command stops the transmission towards the network of assigned ATM layer cells, including cells on uncontrolled ATM connections.

In the case of controlled ATM connections, the credit counter(s) is(are) not modified by the HALT command.

- The second bit indicates:
 - in the default mode (1-queue model) mode, SET(1)/NULL(0) for the controlled ATM connections;
 - in the 2-queue model, SET/NULL for the connections of Group A.

The SET/NULL command applies only to controlled ATM connections. It sets the credit counter to its GO_VALUE.

- The third bit is set to 0 in the default mode. In the 2-queue model, it indicates SET/NULL for the connections of Group B.
- The fourth bit is set to 0 at the S_B and T_B reference point. In the multiaccess UNI, it indicates the GFC signal of the ATM layer cell controls the emission from the B-TE* identified by its specific VPI value.

In the direction from controlled equipment to controlling equipment, the GFC field is defined as follows:

- The first bit is unused and set to 0.
- In the default mode, the second bit indicates to the controlling equipment if the cell belongs to the uncontrolled ATM connections (0), or to the controlled ATM connections (1). In the 2-queue model, it indicates if the cell belongs to the controlled ATM connections of Group A (1) or not (0).
- In the default mode, the third bit is unused and set to 0. In the 2-queue model, it indicates if the cell belongs to the controlled ATM connections of Group B (1) or not (0).
- The fourth bit indicates if the equipment is controlled (1) or uncontrolled (0).

2.2.3 Routing field (VPI/VCI)

Twenty-four bits are available for routing: 8 bits for Virtual Path Identifier (VPI) and 16 bits for Virtual Channel Identifier (VCI). Pre-assigned combinations of VPI and VCI values are shown in Table 2. Other pre-assigned values of VPI and VCI are for further study. The VCI value of zero is not available for user virtual channel identification.

The number of bits of the VPI and VCI fields used for routing are established by negotiation between the user and the network as described in 3.1.2.3/I.150. The bits within the VPI and VCI fields used for routing are allocated using the following rules:

- The allocated bits of the VPI field will be contiguous.
- The allocated bits of the VPI field will be the least significant bits of the VPI field (beginning at bit 5 of octet 2).
- The allocated bits of the VCI field will be contiguous.
- The allocated bits of the VCI field will be the least significant bits of the VCI field (beginning at bit 5 of octet 4).

Table 2/I.361 – Combinations of pre-assigned VPI, VCI, PTI and CLP values at UNI

Use	VPI	VCI (Note 8)	PTI	CLP
Unassigned cell	0	0	Any value	0
Invalid ----- Unassigned cell (Note 13)	Any VPI value other than 0	0	Any value	B ----- 0
Meta-signalling (See Recommendation I.311)				Any VPI value (Note 1)
General broadcast signalling (See Recommendation I.311)	Any VPI value (Note 1)	2 (Note 5)	0AA	C
Point-to-point signalling (See Recommendation I.311)	Any VPI value (Note 1)	5 (Note 5)	0AA	C
Segment OAM F4 flow cell (See Recommendation I.610)	Any VPI value	3 (Note 4)	0A0 (Note 11)	A
End-to-end OAM F4 flow cell (See Recommendation I.610)	Any VPI value	4 (Note 4)	0A0 (Note 11)	A
VP resource management cell (See Recommendation I.371)	Any VPI value	6	110 (Note 9)	A
Reserved for future VP functions (Note 6)	Any VPI value	7 (Note 10)	0AA (Note 11)	A
Reserved for future functions (Note 7)	Any VPI value	Any VCI value in the range 8 to 15 (Note 10)	0AA	A
Reserved for private network use (Note 12)	Any VPI value	Any VCI value in the range 16 to 21	0AA	A
Reserved for future functions (Note 7)	Any VPI value	Any VCI value in the range 22 to 31 (Note 10)	0AA	A
Segment OAM F5 flow cell (See Recommendation I.610)	Any VPI value	Any VCI value other than 0, 3, 4, 6 or 7	100	A
End-to-end OAM F5 flow cell (See Recommendation I.610)	Any VPI value	Any VCI value other than 0, 3, 4, 6 or 7	101	A
VC Resource management cell (See Recommendation I.371)	Any VPI value	Any VCI value other than 0, 3, 4, 6 or 7	110	A
Reserved for future VC functions	Any VPI value	Any VCI value other than 0, 3, 4, 6 or 7	111	A
The GFC field is available for use with all of these combinations.				
A Indicates that the bit may be 0 or 1 and is available for use by the appropriate ATM layer function.				
B Indicates the bit is a "don't care" bit.				
C Indicates the originating entity shall set the CLP bit to 0. The value may be changed by the network.				

Table 2/I.361 – Combinations of pre-assigned VPI, VCI, PTI and CLP values at UNI (*concluded*)

NOTE 1 – For VPI value equal to 0, the specific VCI value specified is reserved for user signalling with the local exchange. For VPI values other than 0, the specified VCI value is reserved for signalling with other signalling entities (e.g. other users or remote networks).

NOTE 2 – Intentionally left blank.

NOTE 3 – Intentionally left blank.

NOTE 4 – According to Recommendation I.610, transparency is not guaranteed for the OAM F4 flows in a user-to-user VP.

NOTE 5 – The VCI values are pre-assigned in every VPC at the UNI. The usage of these values depends on the actual signalling configurations. (See Recommendation I.311.)

NOTE 6 – This VCI value is reserved to provide function for VPs.

NOTE 7 – These VCI values are reserved for future standardization for specific functions.

NOTE 8 – According to Recommendation I.610, cells with VCI values 1, 2, 5, 16 through 31, and greater than 31 are monitored by the VP OAM function. Cells with other VCI values are not monitored by the VP OAM function. (See also Recommendation I.150.)

NOTE 9 – This specifies the allowed coding of the PTI field on transmission. This VCI value shall only be used for the stated functions regardless of the coding of the PTI field. It is an implementation option on how to process errored cells received with VCI = 6 and PTI not equal to 110. In particular, such cells may be processed as VP RM cells.

NOTE 10 – Transparency of the payload for these VCI values is not guaranteed, i.e. cells with these VCI values may be extracted or inserted at midpoints of a VP. The specific situations under this extraction/insertion may occur are for further study. In the absence of this further study, the payload for these VCI values shall be transparently transported in a VP.

NOTE 11 – This specifies the allowed coding of the PTI field on transmission. These VCI values shall only be used for the stated functions regardless of the coding of the PTI field. On reception, the PTI field is not used for the purpose of identifying the cell type. For example, a cell with VCI = 4 will be treated as an end-to-end F4 OAM cell regardless of the coding of the PTI field.

NOTE 12 – ITU will neither maintain nor assign this group of VCIs.

NOTE 13 – For the point-to-point UNI, it is an invalid cell. If received on a point-to-point UNI, the cell will be treated as an unassigned cell (i.e. discarded). For the multiaccess UNI using GFC protocol, it is an unassigned cell. In the multiaccess UNI GFC protocol, identification of the end terminal is done by VPI values. When there is no user cell, unassigned cells are sent to the right terminal using VPI field as a terminal address.

In addition, unallocated bits, i.e. bits not utilized by the user or the network, within the 24-bit routing field will be set to zero.

See 3.1.3/I.150 and 3.1.4/I.150 for VPI/VCI assignment information.

2.2.4 Payload Type (PT) field

Three bits are available for PT identification. The following table describes the payload type identifier (PTI) coding.

PTI coding

bits

4 3 2

0 0 0	User data cell, congestion not experienced. ATM user-to-ATM-user indication = 0
0 0 1	User data cell, congestion not experienced. ATM-user-to-ATM-user indication = 1
0 1 0	User data cell, congestion experienced. ATM-user-to-ATM-user indication = 0
0 1 1	User data cell, congestion experienced. ATM-user-to-ATM-user indication = 1
1 0 0	OAM F5 segment associated cell
1 0 1	OAM F5 end-to-end associated cell
1 1 0	Resource management cell
1 1 1	Reserved for future VC functions

Any congested network element, upon receiving a user data cell, may modify the PTI as follows. Cells received with PTI = 000 or PTI = 010 are transmitted with PTI = 010. Cells received with PTI = 001 or PTI = 011 are transmitted with PTI = 011. Non-congested network elements should not change the PTI. See Recommendation I.371.

The use of PTI = 110 is reserved for resource management use. See Recommendation I.371.

The use of PTI = 100 is discussed in Recommendation I.610.

The use of PTI = 101 is discussed in Recommendation I.610.

When the PTI value is set to 111 in a cell, the function of the ATM layer will be found in a field of the payload of that cell. The length of this field is for further study. The allocation of the extended values are under the control of ITU-T. The coding of the remaining part of the payload should be done by the group which has proposed the functions in consultation with ITU-T.

2.2.5 Cell Loss Priority (CLP) field

Depending on network conditions and for some ATM transfer capabilities (see Recommendation I.371), cells where the CLP is set (CLP value is 1) are subject to discard prior to cells where the CLP is not set (CLP value is 0). (See Recommendation I.371 for further details about the use of the CLP bit.)

2.2.6 Header Error Control (HEC) field

The HEC field consists of 8 bits. Use of this field is described in 4.3/I.432.

2.3 Cell header format and encoding at NNI

The structure of the header is shown in Figure 3. The fields contained in the header and their encoding are described in the following subclauses.

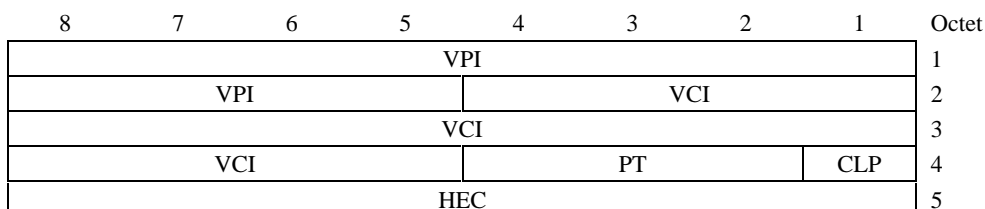

Figure 3/I.361 – Header structure at NNI

2.3.1 Pre-assigned values of the cell header

Pre-assigned values of the cell header (to differentiate cells for the use of the ATM layer from cells for the use of the Physical layer) are given in Table 3. All other values are for use of the ATM layer.

Table 3/I.361 – Pre-assigned Physical cell header (excluding the HEC field)

	Octet 1	Octet 2	Octet 3	Octet 4
Idle cell identification	00000000	00000000	00000000	00000001
Reserved for use of the Physical layer (Note)	00000000	00000000	00000000	0000PPP1
<p>P Indicates the bit is available for use by the Physical layer.</p> <p>Values assigned to these bits have no meaning with respect to the fields occupying the corresponding bit positions at the ATM layer.</p> <p>NOTE – Specific pre-assigned Physical layer cell header values are given in Recommendation I.432-series and in other Recommendations related to Physical layer (see Appendix I).</p>				

2.3.2 Routing field (VPI/VCI)

Twenty-eight bits are available for routing: 12 bits for VPI and 16 bits for VCI. Pre-assigned combinations of VPI and VCI values are shown in Table 2. Other pre-assigned values of VPI and VCI are for further study. The VCI value of zero is not available for user virtual channel identification. See Table 4.

Table 4/I.361 – Combinations of pre-assigned VPI, VCI, PTI and CLP values at NNI

Use	VPI	VCI (Note 6)	PTI	CLP
Unassigned cell	0	0	Any value	0
Invalid	Any VPI value other than 0	0	Any value	B
NNI-signalling (See Recommendation I.311) (Note 10)	Any VPI value	5	0AA	C
Segment OAM F4 flow cell (See Recommendation I.610)	Any VPI value	3 (Note 3)	0A0 (Note 11)	A
End-to-end OAM F4 flow cell (See Recommendation I.610)	Any VPI value	4 (Note 3)	0A0 (Note 11)	A
VP resource management cell (See Recommendation I.371)	Any VPI value	6	110 (Note 7)	A
Reserved for future VP functions (Note 4)	Any VPI value	7 (Note 8)	0AA (Note 11)	A
Reserved for future functions (Note 5)	Any VPI value	Any VCI value in the range 8 to 15 (Note 8)	0AA	A
Reserved for private network use (Note 9)	Any VPI value	Any VCI value in the range 16 to 21	0AA	A

Table 4/I.361 – Combinations of pre-assigned VPI, VCI, PTI and CLP values at NNI (concluded)

Use	VPI	VCI (Note 6)	PTI	CLP
Reserved for future functions (Note 5)	Any VPI value	Any VCI value in the range 22 to 31	0AA	A
Segment OAM F5 flow cell (See Recommendation I.610)	Any VPI value	Any VCI value other than 0, 3, 4, 6 or 7	100	A
End-to-end OAM F5 flow cell (See Recommendation I.610)	Any VPI value	Any VCI value other than 0, 3, 4, 6 or 7	101	A
VC Resource management cell (See Recommendation I.371)	Any VPI value	Any VCI value other than 0, 3, 4, 6 or 7	110	A
Reserved for future VC functions	Any VPI value	Any VCI value other than 0, 3, 4, 6 or 7	111	A

A Indicates that the bit may be 0 or 1 and is available for use by the appropriate ATM layer function.

B Indicates the bit is a "don't care" bit.

C Indicates the originating entity shall set the CLP bit to 0. The value may be changed by the network.

NOTE 1 – Intentionally left blank.

NOTE 2 – Intentionally left blank.

NOTE 3 – According to Recommendation I.610, transparency is not guaranteed for the OAM F4 flows in a user-to-user VP.

NOTE 4 – This VCI value is reserved to provide function for VPs.

NOTE 5 – These VCI values are reserved for future standardization for specific functions.

NOTE 6 – According to Recommendation I.610, cells with VCI values 1, 2, 5, 16 through 31 and greater than 31 are monitored by the VP OAM function. Cells with other VCI values are not monitored by the VP OAM function. (See also Recommendation I.150.)

NOTE 7 – This specifies the allowed coding of the PTI field on transmission. This VCI value shall only be used for the stated functions regardless of the coding of the PTI field. It is an implementation option on how to process errored cells received with VCI = 6 and PTI not equal to 110. In particular, such cells may be processed as VP RM cells.

NOTE 8 – Transparency of the payload for these VCI values is not guaranteed, i.e. cells with these VCI values may be extracted or inserted at midpoints of a VP. The specific situations under which this extraction/insertion may occur are for further study. In the absence of this further study the payload for these VCI values shall be transparently transported in a VP.

NOTE 9 – ITU will neither maintain nor assign this group of VCIs.

NOTE 10 – In a user-to-user VP connection (see Recommendation I.311), the VCI values used for the signalling at the UNI (1, 2 and 5) are the same along the connection. In a network-to-network VP connection, only VCI value 5 is used for the NNI signalling protocol.

NOTE 11 – This specifies the allowed coding of the PTI field on transmission. These VCI values shall only be used for the stated functions regardless of the coding of the PTI field. On reception, the PTI field is not used for the purpose of identifying the cell type, e.g. a cell with VCI = 4 will be treated as an end-to-end F4 OAM cell regardless of the coding of the PTI field.

The number of bits of the VPI and VCI fields used for routing are established by negotiation between the networks as described in 3.1.2.4/I.150. The bits within the VPI and VCI fields used for routing are allocated using the following rules:

- The allocated bits of the VPI field will be contiguous.
- The allocated bits of the VPI field will be the least significant bits of the VPI field (beginning at bit 5 of octet 2).
- The allocated bits of the VCI field will be contiguous.
- The allocated bits of the VCI field will be the least significant bits of the VCI field (beginning at bit 5 of octet 4).

In addition, unallocated bits, i.e. bits not utilized by the user or the network within the 28-bit routing field, will be set to zero.

See 3.1.3/I.150 and 3.1.4/I.150 for VPI/VCI assignment information.

2.3.3 Payload Type (PT) field

Three bits are available for PT identification. The following table describes the payload type identifier (PTI) coding.

PTI coding

bits

4 3 2

0 0 0	User data cell, congestion not experienced. ATM user-to-ATM-user indication = 0
0 0 1	User data cell, congestion not experienced. ATM-user-to-ATM-user indication = 1
0 1 0	User data cell, congestion experienced. ATM-user-to-ATM-user indication = 0
0 1 1	User data cell, congestion experienced. ATM-user-to-ATM-user indication = 1
1 0 0	OAM F5 segment associated cell
1 0 1	OAM F5 end-to-end associated cell
1 1 0	Resource management cell
1 1 1	Reserved for future VC functions

Any congested network element, upon receiving a user data cell, may modify the PTI as follows. Cells received with PTI = 000 or PTI = 010 are transmitted with PTI = 010. Cells received with PTI = 001 or PTI = 011 are transmitted with PTI = 011. Non-congested network elements should not change the PTI. See Recommendation I.371.

The use of PTI = 110 is reserved for resource management use. See Recommendation I.371.

The use of PTI = 100 is discussed in Recommendation I.610.

The use of PTI = 101 is discussed in Recommendation I.610.

When the PTI value is set to 111 in a cell, the function of the ATM layer will be found in a field of the payload of that cell. The length of this field is for further study. The allocation of the extended values are under the control of ITU-T. The coding of the remaining part of the payload should be done by the group which has proposed the functions in consultation with ITU-T.

2.3.4 Cell Loss Priority (CLP) field

Depending on network conditions and for some ATM transfer capabilities (see Recommendation I.371), cells where the CLP is set (CLP value is 1) are subject to discard prior to cells where the CLP is not set (CLP value is 0).

2.3.5 Header Error Control (HEC) field

The HEC field consists of 8 bits. The HEC mechanism of the NNI is identical to that at the UNI and is described in 4.3/I.432.

2.4 Cell information field

2.4.1 Pre-assigned values

The pre-assigned values of the information field of all unassigned cells are for further study.

3 Service primitives

Service primitives describe in an abstract manner the logical exchange of information and control through a Service Access Point (SAP). The primitives do not specify nor constrain the implementation of entities or interfaces.

3.1 Primitives exchanged with the upper layer

The information exchanged between the ATM layer and the upper layer (e.g. the AAL) across the ATM-SAP includes the following primitives:

- ATM-DATA request (ATM-SDU, Submitted Loss Priority, Congestion indication, ATM-user-to-ATM-user Indication);
- ATM-DATA indication (ATM-SDU, congestion indication, ATM-user-to-ATM-user indication, Receive Loss Priority).

Additional parameters require further study.

3.1.1 Description of primitives

- ATM-DATA request: This primitive is issued by an upper layer entity (e.g. AAL-entity) to request the transfer of an ATM-SDU to its corresponding entity (or entities) over an ATM connection. The submitted loss priority parameter and the ATM-user-to-ATM-user indication parameter are used to assign the proper CLP and PTI fields to the ATM-PDU generated at the ATM layer. The generated ATM-PDU is transferred over the PHY-CEs assigned to that ATM connection or the indicated group of PHY-CEs.
- ATM-DATA indication: This primitive is issued to an upper layer entity (e.g. AAL-entity) to indicate the arrival of an ATM-SDU from the indicated PHY-CE over an ATM connection, with congestion indication and received ATM-user-to-ATM-user indication. In the absence of error, the ATM-SDU is the same as the ATM-SDU sent by the corresponding upper layer entity in the ATM-DATA request primitive.

3.1.2 Descriptions of parameters

- ATM-SDU: This parameter contains 48 octets of ATM layer user data (e.g. the AAL SAR-PDU) to be transferred by the ATM layer between corresponding upper layer entities.
- Submitted Loss Priority: This parameter indicates the relative importance of the requested transport for the information carried in the ATM-SDU. It can take only two values, one for high priority and the other for low priority.
- Receive Loss Priority: This parameter indicates the relative importance of the transport given to the information carried in the ATM-SDU. It can take only two values, one for high priority and the other for low priority.

- Congestion indication: This parameter indicates that the received ATM-SDU has passed through a network node in congestion.
- ATM-user-to-ATM-user indication (AUU): This parameter is transported transparently by the ATM layer.

The use of the parameters is summarized in Table 5.

Table 5/I.361 – Parameters of ATM-DATA

Parameter	Type	Use	Comments
Received CLP	Indication	M	(Note 1)
ATM-SDU	Request	M	48 octets of ATM layer user data
	Indication	M	
Submitted CLP	Request	M	(Note 1)
AUU	Request	M	(Note 2)
	Indication	M	
Congestion indication	Request	O (Note 3)	Indication of congestion experienced
	Indication	M	
M Mandatory O Optional NOTE 1 – CLP = 0: CLP bit set to "0". CLP = 1: CLP bit set to "1". NOTE 2 – ATM-user-to-ATM-user = "0". ATM-user-to-ATM-user = "1". NOTE 3 – This parameter might be needed for interworking (e.g. with Frame Relay service).			

3.2 Primitives exchanged with the lower layer

The ATM layer expects the PHY to provide for the transport of ATM cells between corresponding ATM-entities. The information exchanged between the ATM layer and the PHY across the PHY-SAP includes the following primitives:

- PHY-DATA request (PHY-SDU);
- PHY-DATA indication (PHY-SDU).

3.2.1 Description of primitives

- PHY-DATA request: This primitive is issued by the ATM layer to request the transfer of an ATM cell from a local ATM-entity to the corresponding ATM-entity over an existing PHY connection. Each cell is exchanged between the ATM layer and the PHY across the PHY-SAP. The entire cell (except for the HEC field) is transported unmodified by the PHY via the existing PHY connection.
- PHY-DATA indication: This primitive is issued by the PHY to the ATM layer to indicate the arrival of a PHY-SDU from a corresponding PHY-entity over an existing PHY connection. In the absence of error, this PHY-SDU (except for the HEC field) is the same as the PHY-SDU sent by the corresponding ATM-entity in a PHY-DATA request primitive.

3.2.2 Description of parameter

- PHY-SDU: This parameter contains one ATM cell to be transferred between corresponding ATM-entities.

3.3 Primitives exchanged with ATM Management (ATMM) -entity

Figure 4 shows two types of interactions between the ATM-entity and the ATMM-entity. One interaction is for the exchange of local information between these two entities. The other interaction is for peer-to-peer communication between ATMM-entities, and has the following associations between the ATM-entity and the ATMM-entity: segment OAM F5 flow, end-to-end OAM F5 flow and resource management.

For peer-to-peer communication between ATMM-entities:

- ATMM-DATA request (ATM-SDU, Submitted Loss Priority, GFC_mode, GO_value, PHY-CEI);
- ATMM-DATA indication (ATM-SDU, Congestion indication, Received Loss Priority, GFC_mode, GO_value, PHY-CEI).

For local communications between the ATM-entity and ATMM-entity:

- ATMM_GFC.request (ATM_LI(s), GFC_mode, GO_value, PHY_CEI);
- ATMM_GFC.indication (ATM_LI(s), GFC_mode, GO_value, PHY_CEI).

NOTE – Figure 4 does not indicate GFC or Unassigned Cell Insertion (UCI) function. See Annex B for placement of these functions.

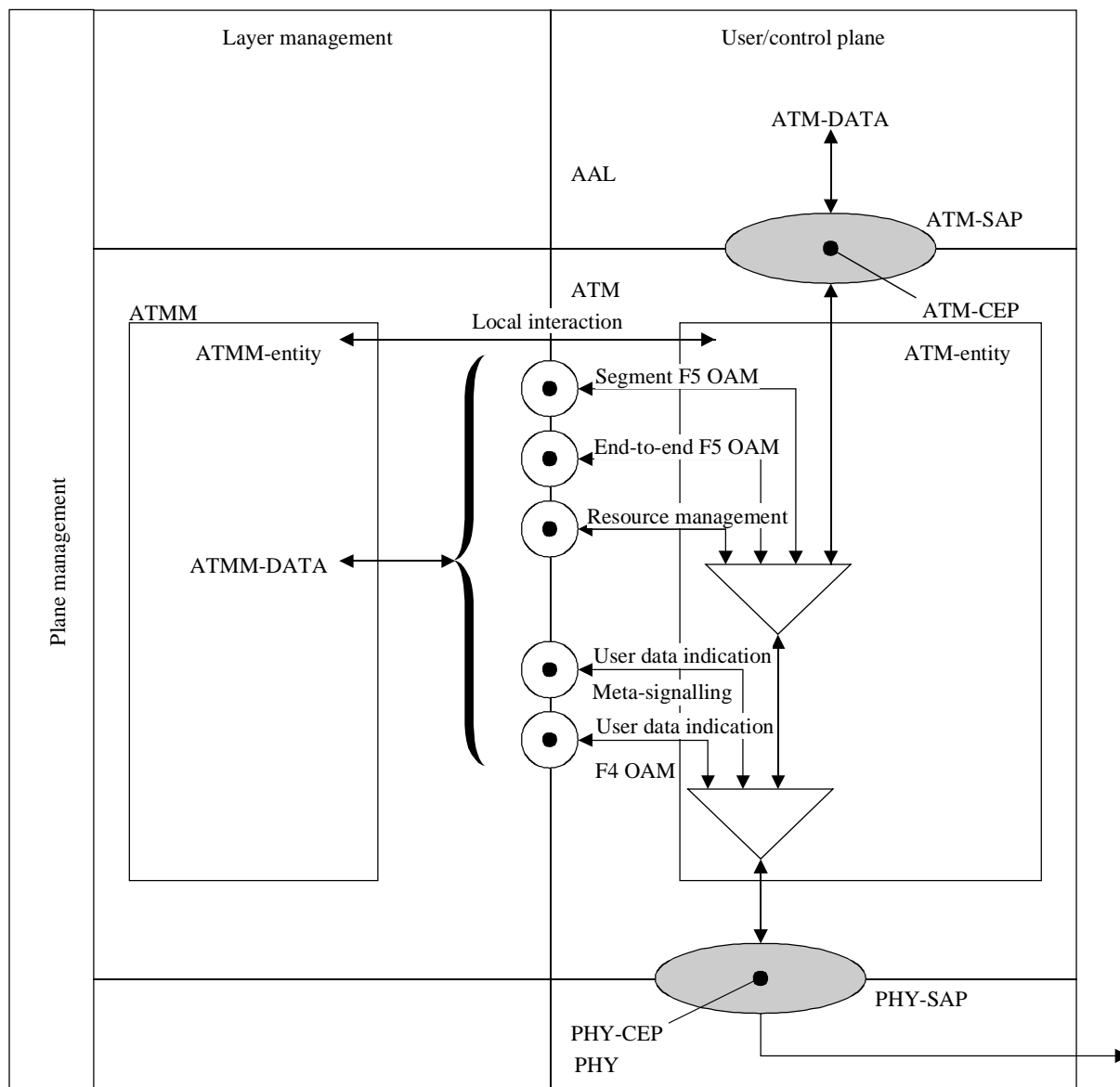

T1307460-96

Figure 4/I.361 – Interactions between ATM- and ATMM-entities

3.3.1 Description of primitives

- ATMM-DATA request: This primitive is issued by an ATMM-entity to request the transfer of a management ATM-SDU.
- ATMM-DATA indication: This primitive is issued to an ATMM-entity to indicate the arrival of an ATM-SDU.
- ATMM_GFC.request: This primitive is issued by the ATMM-entity to control the GFC operation mode; controlled/uncontrolled.
- ATMM_GFC.indication: This primitive is issued to the ATMM-entity to indicate the GFC operating mode.

3.3.2 Description of parameters

- Submitted Loss Priority: This parameter indicates the relative importance of the requested transport for the information carried in the ATM-SDU. It can take only two values, one for high priority and the other for low priority.

- Received Loss Priority: This parameter indicates the relative importance of the transport given to the information carried in the ATM-SDU. It can take only two values, one for high priority and the other for low priority.
- PHY-CEI: This parameter identifies the PHY-CE within the PHY-SAP. Certain characteristics are uniquely associated with this identifier, such as UNI or NNI cell format¹;
- ATM-SDU: This parameter contains 48 octets of ATM layer management data to be transparently transferred between corresponding ATMM-entities.
- Congestion indication: This parameter indicates that the received ATM-SDU has passed through a network node in congestion.
- Congestion: This parameter indicates the congestion status of the ATM-entity.
- ATM_LI: This parameter identifies an ATM connection within ATM-SAP.
- GFC_mode: This parameter indicates the GFC mode is controlled/uncontrolled.
- GO_value: This parameter indicates the credit value for the controlled GFC mode.

The use of the parameters is summarized in Tables 6 and 7.

Table 6/I.361 – Parameters of ATMM-DATA

Parameter	Type	Use	Comments
ATM-SDU	Request	M	48 octets of ATM layer management data
	Indication	M	
Submitted CLP	Request	M	(Note)
Received CLP	Indication	O	(Note)
Congestion indication	Indication	M	Indication of congestion experienced
GFC_mode	Request	O	Indication of GFC mode
	Indication	O	
GO_value	Request	O	Indication of credit value
	Indication	O	
PHY-CEI	Request	M	Identification of PHY-CE within PHY-SAP
	Indication	M	
M Mandatory O Optional NOTE – CLP = 0: CLP bit set to "0". CLP = 1: CLP bit set to "1".			

¹ In some cases, such as multipoint connections, multiple PHY-CEIs could be associated with the same ATM connection. Also, in nodes performing relaying functions, at least two PHY-CEIs are associated with the same ATM connection.

Table 7/I.361 – Parameters of ATMM_GFC

Parameter	Type	Use	Comments
ATM_LI	Request	M	ATM connection within ATM_SAP
GFC_mode	Request	O	Indication of GFC mode
	Indication	O	
GO_value	Request	O	Indication of credit value
	Indication	O	

4 ATM protocol procedures

This clause contains procedures that describe the operation of the ATM protocol (including the peer-to-peer and inter-layer information flows).

4.1 GFC protocol procedures

For uncontrolled equipment, the GFC function is not used. Therefore, no action is taken on the GFC field setting and the GFC field is always set to all zeros upon transmission. The procedures described below apply to controlled and controlling equipment as described in 3.4.4.1/I.150.

Controlled GFC procedures at the S_B and T_B reference points (see Figures 2/I.413 and 3/I.413), when implemented, provide the possibility for three functions:

- 1) an option is cyclic HALT of traffic on all ATM connections for limiting the ATM traffic to the network across the UNI to a fixed fraction of the interface;
- 2) access control to the network of traffic on controlled ATM connections; and
- 3) explicit indication by controlled equipment to controlling equipment that an offered cell is on a controlled ATM connection.

4.1.1 GFC field assignment

GFC uses ATM layer assigned and unassigned cells. In the direction of the controlling to the controlled device, whenever possible, the GFC signals will be superimposed on existing ATM layer cell flowing from the controlling to the controlled device. If no ATM layer cells exist to superimpose GFC signals on, then the GFC function will force unassigned ATM layer cell to carry the GFC signals to the controlled device.

The GFC at the S_B and T_B reference points has the following defined bit assignments:

In the direction towards the controlled equipment:

GFC coding (towards the controlled equipment)

```

bits
8 7 6 5
0 0 0 0 NO_HALT, NULL, Point-to-point UNI
1 0 0 0 HALT, NULL_A, NULL_B, Point-to-point UNI
0 1 0 0 NO_HALT, SET_A, NULL_B, Point-to-point UNI
1 1 0 0 HALT, SET_A, NULL_B, Point-to-point UNI
0 0 1 0 NO_HALT, NULL_A, SET_B, Point-to-point UNI
1 0 1 0 HALT, NULL_A, SET_B, Point-to-point UNI
0 1 1 0 NO_HALT, SET_A, SET_B, Point-to-point UNI
1 1 1 0 HALT, SET_A, SET_B, Point-to-point UNI

```

0 0 0 1	NO_HALT, NULL, Specific B-TE*
1 0 0 1	HALT, NULL_A, NULL_B, Specific B-TE*
0 1 0 1	NO_HALT, SET_A, NULL_B, Specific B-TE*
1 1 0 1	HALT, SET_A, NULL_B, Specific B-TE*
0 0 1 1	NO_HALT, NULL_A, SET_B, Specific B-TE*
1 0 1 1	HALT, NULL_A, SET_B, Specific B-TE*
0 1 1 1	NO_HALT, SET_A, SET_B, Specific B-TE*
1 1 1 1	HALT, SET_A, SET_B, Specific B-TE*

In the direction of the controlled device to the controlling device, a direct relationship exists between the setting of the GFC field and the VPI/VCI field of each cell. The determination of uncontrolled, queue A or queue B setting was made at call set-up time and will be identical for all cells with a given value of VPI/VCI from the controlled device to the controlling device.

In the direction towards the controlling equipment:

GFC coding (towards the controlled equipment)

bits

8 7 6 5

0 0 0 0	Terminal is uncontrolled. Cell is assigned or on an uncontrolled ATM connection.
0 0 0 1	Terminal is controlled. Cell is unassigned or on an uncontrolled ATM connection.
0 1 0 1	Terminal is controlled. Cell on a controlled ATM connection Group A.
0 0 1 1	Terminal is controlled. Cell on a controlled ATM connection Group B.

All other values ignored.

4.1.2 GFC procedures

The GFC procedures can be applied to the multiaccess UNI if each B-TE* can be identified by the specific VPI value.

The SDL diagrams for these procedures are given in Annex B.

Controlling equipment link initialization phase protocols

The use of GFC procedures on point-to-point links is determined at link initialization time and does not change while the link is active.

During link initialization, the controlling equipment uses the following protocol to determine whether or not to use controlled transmission procedures on this link. On power up, the controlling equipment will start as follows:

In case of PVC links, the use of the GFC "controlling equipment" procedures is determined by provisioning basis.

In case of SVC links, the use of GFC "controlled equipment" procedures is determined by configuration information in the controlled equipment and the selection of uncontrolled, queue A or queue B per VCI may be confirmed by signalling. Therefore, signalling protocol procedures may be needed to provide this verification. Such signalling procedures are for further study.

The controlling equipment uses the following procedure to dynamically invoke "controlling equipment" procedures.

The controlling equipment starts sending one of the following: HALT, SET_A, or SET_B signals to solicit the GFC capability for some period of time (T), or until the first connection set-up occurs. The default value for timer (T) is five seconds. On timer expiry, the controlling equipment will revert to uncontrolled mode. During this period, the controlling equipment will not prevent the controlled

equipment from sending any group of cells, except by cyclic HALT until it has received 0001, 0101, 0011 signals from the controlled equipment or terminates the link start up procedures. Accordingly, controlled equipment must respond with a cell with a valid non-zero GFC field within the period T.

Procedures for the one-queue default model and the optional two-queue model for controlled equipment are included in this subclause.

4.1.2.1 GFC procedures across the interface at S_B and T_B reference points (one-queue model, default)

- 1) On power up, the controlled equipment will start as follows (see 4.1.2 for the controlling equipment initialization procedures):
 - The TRANSMIT flag is initialized as set. The GO_CNTR is initialized as zero. The GO_VALUE is initialized as one. The GFC_ENABLE flag is reset. The GO_VALUE can be changed by the management procedure.
 - The controlled equipment will perform the uncontrolled GFC procedures until it has received HALT, SET_A, or SET_B signals from the controlling equipment. When the controlled equipment receives HALT, SET_A, or SET_B signals from the controlling equipment, the GFC_ENABLE flag is set and thereafter the controlling equipment performs the controlled GFC procedures.
- 2) The sending of the HALT codepoint is an option. When sent, the HALT command shall be cyclic. Cyclic HALT will be used to logically limit the effective ATM transport capacity. The HALT command will be issued by the controlling equipment to decrease the effective ATM transmission capacity of the link, e.g. on a 100 Mbit/s link, HALT would be in effect 50% of the time to reduce the logical ATM transmission capacity to 50 Mbit/s. This would be done on a cyclic (predictable) rate over the lifetime of the physical connection, e.g. from physical link ACTIVATION to DEACTIVATION. The cyclic use of HALT must not alter traffic that conforms to the traffic contract to produce traffic that no longer conforms to the traffic contract. On receiving any NO_HALT, the controlled equipment sets the TRANSMIT flag. On receiving any HALT, the controlled equipment nulls the TRANSMIT flag.
- 3) If the TRANSMIT flag is set, the controlled equipment is free to send to the network an assigned cell on any uncontrolled ATM connection, provided that the sending of the cell at that time is permitted by the terms of the traffic contract in force on the given connection. When sending a cell on an uncontrolled ATM connection, the controlled equipment marks the GFC of that cell as cell is on an uncontrolled connection.
- 4) If the TRANSMIT flag is null, the controlled equipment is not permitted to send any assigned ATM layer cell to the network on any connection.
- 5) On receiving any SET_A, the controlled equipment sets the credit counter to a specified integer value (GO_VALUE).
- 6) Any NULL has no action on the GO_CNTR.
- 7) If the TRANSMIT flag is set and there is no cell to transmit on any uncontrolled ATM connections, then the following procedures apply:
 - If the GO_CNTR is greater than zero, the controlled equipment is permitted to send to the network an assigned cell on any controlled ATM connection. When sending a cell on a controlled ATM connection, the controlled equipment marks the GFC of that cell as cell is on a controlled ATM connection and decrements the GO_CNTR by one.
 - Otherwise, the controlled equipment is not permitted to send any assigned ATM layer cell to the network on any controlled ATM connection.

4.1.2.2 GFC procedures across interface at S_B and T_B reference points (two-queue model)

- 1) On power up, the controlled equipment will start as follows (see 4.1.2 for the controlling equipment initialization procedures):
 - The TRANSMIT and GROUP_SELECT flags are initialized as set. The GO_CNTR_A and GO_CNTR_B are initialized as zero. The GO_VALUE_A and GO_VALUE_B are initialized as one. The GFC_ENABLE flag is reset. The GO_VALUE_A and GO_VALUE_B can be changed by the management procedure.
 - The controlled equipment will perform the uncontrolled GFC procedures until it has received HALT, SET_A, or SET_B signals from the controlling equipment. When the controlled equipment receives HALT, SET_A, or SET_B signals from the controlling equipment, the GFC_ENABLE flag is set and thereafter the controlling equipment performs the controlled GFC procedures.
- 2) The sending of the HALT codepoint is an option. When sent, the HALT command shall be cyclic. Cyclic HALT will be used to logically limit the effective ATM transport capacity. The HALT command will be issued by the controlling equipment to decrease the effective ATM transmission capacity of the link, e.g. on a 100 Mbit/s link, HALT would be in effect 50% of the time to reduce the logical ATM transmission capacity to 50 Mbit/s. This would be done on a cyclic (predictable) rate over the lifetime of the physical connection, e.g. from physical link ACTIVATION to DEACTIVATION. The cyclic use of HALT must not alter traffic that conforms to the traffic contract to produce traffic that no longer conforms to the traffic contract. On receiving any NO_HALT, the controlled equipment sets the TRANSMIT flag. On receiving any HALT, the controlled equipment nulls the TRANSMIT flag.
- 3) If the TRANSMIT flag is set, the controlled equipment is free to send to the network an assigned cell on any uncontrolled ATM connection, provided that the sending of the cell at that time is permitted by the terms of the traffic contract in force on the given connection. When sending a cell on an uncontrolled ATM connection, the controlled equipment marks the GFC of that cell as cell is on an uncontrolled connection.
- 4) If the TRANSMIT flag is null, the controlled equipment is not permitted to send any assigned ATM layer cell to the network on any connection.
- 5) On receiving any SET_A, the controlled equipment resets the credit counter of the Group A (GO_CNTR_A) to a specified integer value (GO_VALUE_A).
- 6) Any NULL_A has no action on the GO_CNTR_A.
- 7) On receiving any SET_B, the controlled equipment sets the credit counter of the Group B (GO_CNTR_B) to a specified integer value (GO_VALUE_B).
- 8) Any NULL_B has no action on the GO_CNTR_B.
- 9) If the TRANSMIT flag is set and no uncontrolled cells are available to transmit; then:
 - a) If the GROUP_SELECT flag is set, then the following procedures apply:
 - i) If the GO_CNTR_A is greater than zero, the controlled equipment is permitted to send to the network an assigned cell on any controlled ATM connection in the Group A. When sending a cell on a controlled ATM connection in the Group A, the controlled equipment marks the GFC of that cell as cell is on a controlled ATM connection in the Group A and decrements the GO_CNTR_A by one. The GROUP_SELECT flag is reset.
 - Otherwise, the controlled equipment is not permitted to send any assigned ATM layer cell to the network on any controlled ATM connection in the Group A. The GROUP_SELECT flag is kept as set.

- ii) If the GO_CNTR_A is equal to zero or there is no cell waiting, then the further procedures are as follows:
 - If the GO_CNTR_B is greater than zero, the controlled equipment is permitted to send to the network an assigned cell on any controlled ATM connection in the Group B. When sending a cell on a controlled ATM connection in the Group B, the controlled equipment marks the GFC of that cell as cell is on a controlled ATM connection in the Group B and decrements the GO_CNTR_B by one. The GROUP_SELECT flag is kept as set.
 - Otherwise, the controlled equipment is not permitted to send any assigned ATM layer cell to the network on any controlled ATM connection in the Group B. The GROUP_SELECT flag is kept as set.
- b) If the GROUP_SELECT flag is not set, the following procedures apply:
 - i) If the GO_CNTR_B is greater than zero, the controlled equipment is permitted to send to the network an assigned cell on any controlled ATM connection in the Group B. When sending a cell on a controlled ATM connection in the Group B, the controlled equipment marks the GFC of that cell as cell is on a controlled ATM connection in the Group B and decrements the GO_CNTR_B by one. The GROUP_SELECT flag is set.
 - Otherwise, the controlled equipment is not permitted to send any assigned ATM layer cell to the network on any controlled ATM connection in the Group B. The GROUP_SELECT flag is kept reset.
 - ii) If the GO_CNTR_B is equal to zero or there is no cell waiting, then the further procedures are as follows:
 - If the GO_CNTR_A is greater than zero, the controlled equipment is permitted to send to the network an assigned cell on any controlled ATM connection in the Group A. When sending a cell on a controlled ATM connection in the Group A, the controlled equipment marks the GFC of that cell as being on a controlled ATM connection in the Group A and decrements the GO_CNTR_A by one. The GROUP_SELECT flag is reset.
 - Otherwise, the controlled equipment is not permitted to send any assigned ATM layer cell to the network on any controlled ATM connections in the Group A. The GROUP_SELECT flag is kept reset.

4.2 Layer management communication

For further study.

4.3 Layer management

See Recommendation Q.2120.

4.3.1 Fault management

See Recommendation I.610.

4.3.2 Performance management

See Recommendation I.610.

4.3.3 Configuration management

See Recommendation I.610.

4.3.4 Resource management

See Recommendation I.371.

ANNEX A

Alphabetical list of abbreviations used in this Recommendation

This Recommendation uses the following abbreviations:

ATM	Asynchronous Transfer Mode
CLP	Cell Loss Priority
GFC	Generic Flow Control
HEC	Header Error Control
MSB	Most Significant Bit
NNI	Network-Node Interface
OAM	Operation And Maintenance
PT	Payload Type
PTI	Payload Type Identifier
UCI	Unassigned Cell Insertion
UNI	User-Network Interface
VCI	Virtual Channel Identifier
VPI	Virtual Path Identifier

ANNEX B

SDL diagrams for GFC procedures

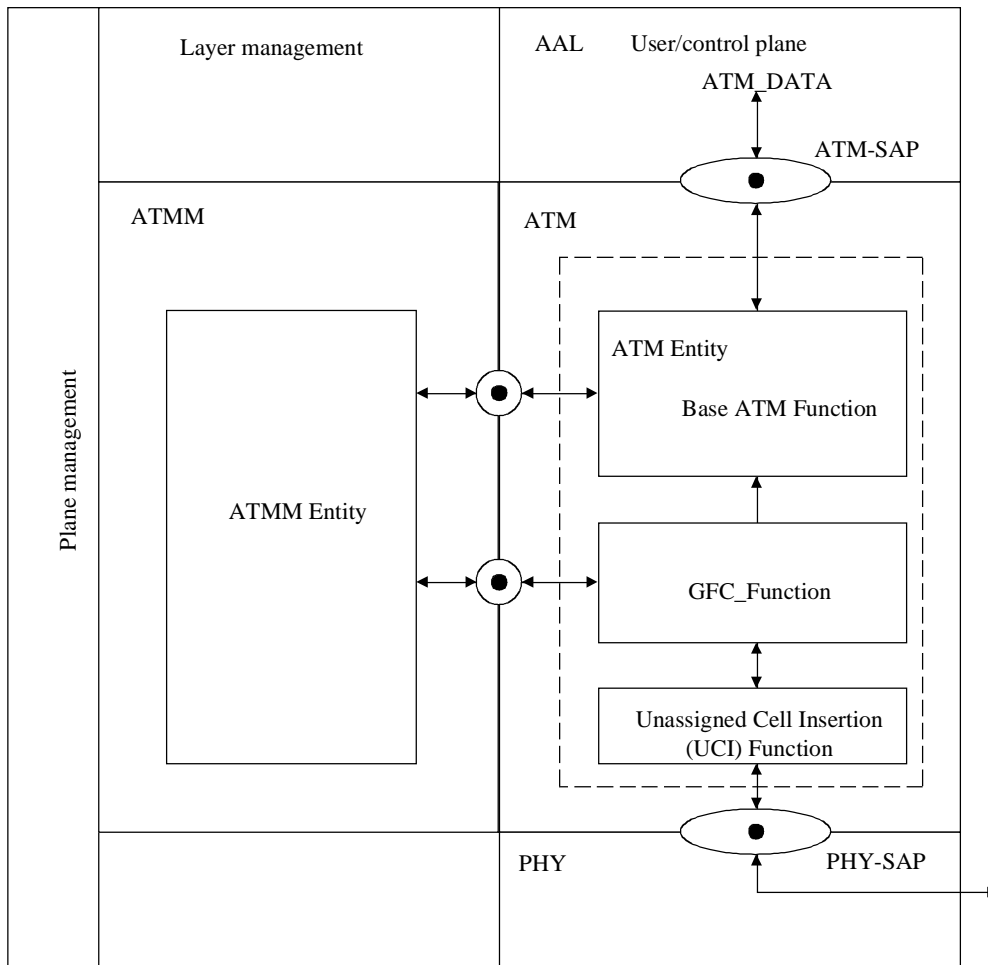

T1303550-95

Figure B.1/I.361 – Relationship of GFC Function to other functions in ATM Entity and to ATMM Entity

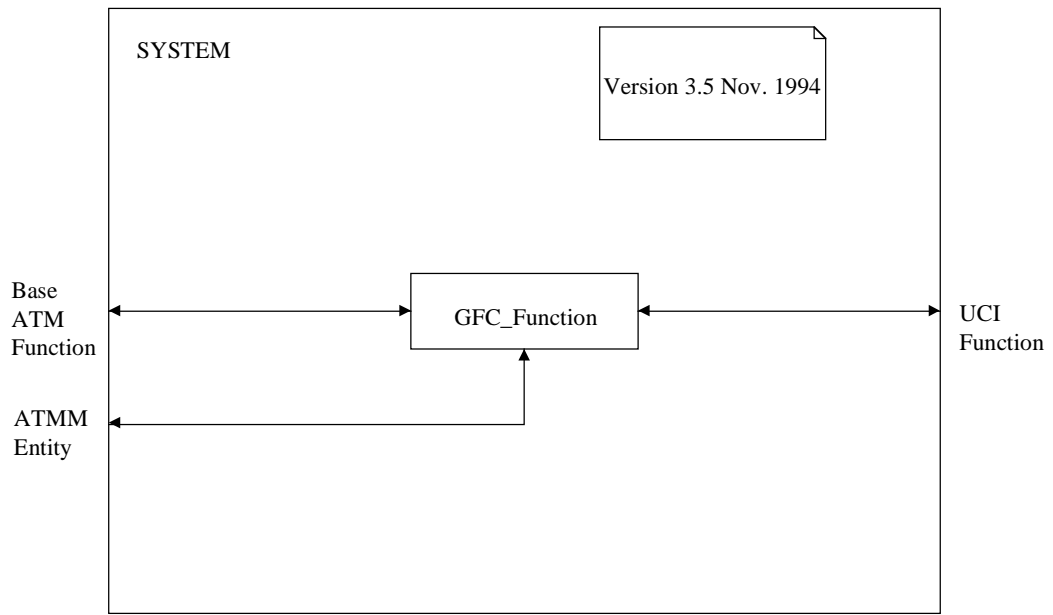

T1303560-95

Figure B.2/I.361 – The GFC_Function system

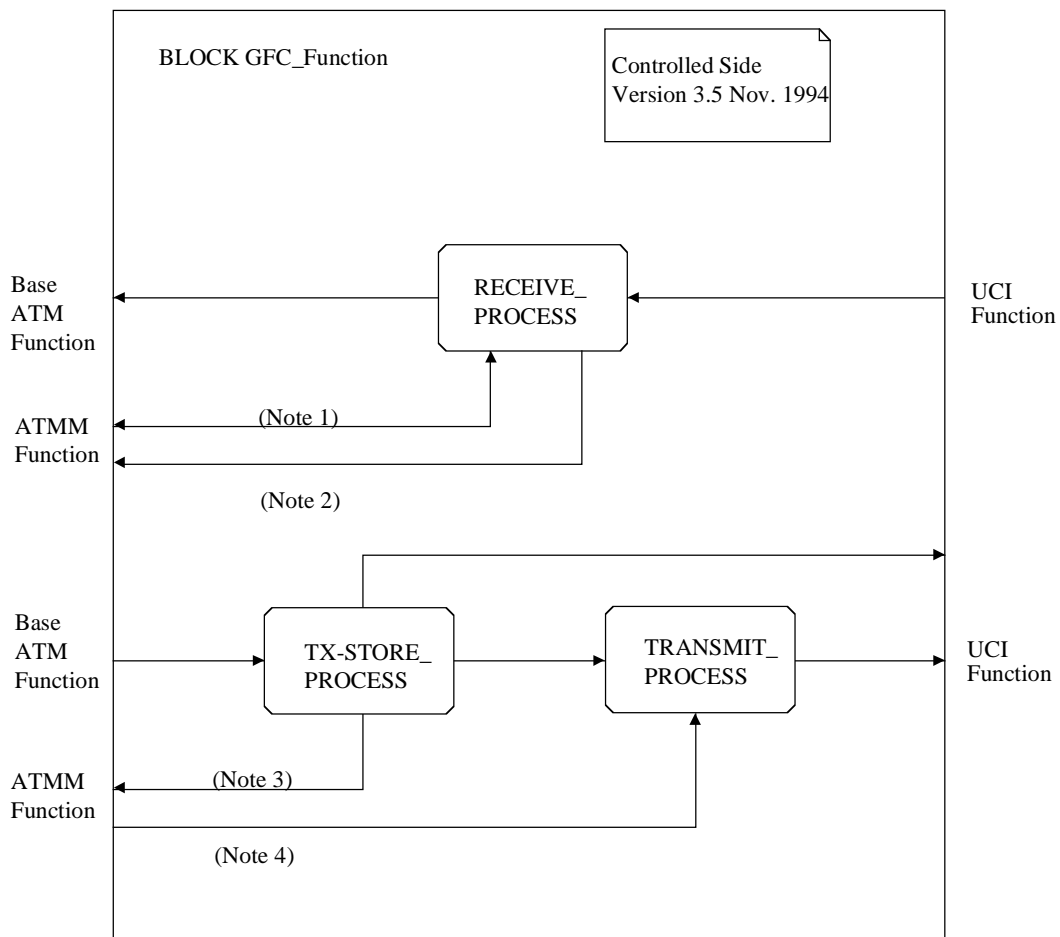

T1303570-95

- NOTE 1 – ATMM Entity sets GO_VALUE(s); default is 1.
 NOTE 2 – LM_Sig(GFC_ENABLE).
 NOTE 3 – LM_Sig(Invalid_CELL); LM_Sig(Invalid_Class).
 NOTE 4 – LM_Sig(C_Start).

Figure B.3/I.361 – Block diagram of GFC_Function system in controlled equipment

Controlled Side
Group A only supported
Version 3.5 Nov. 1994

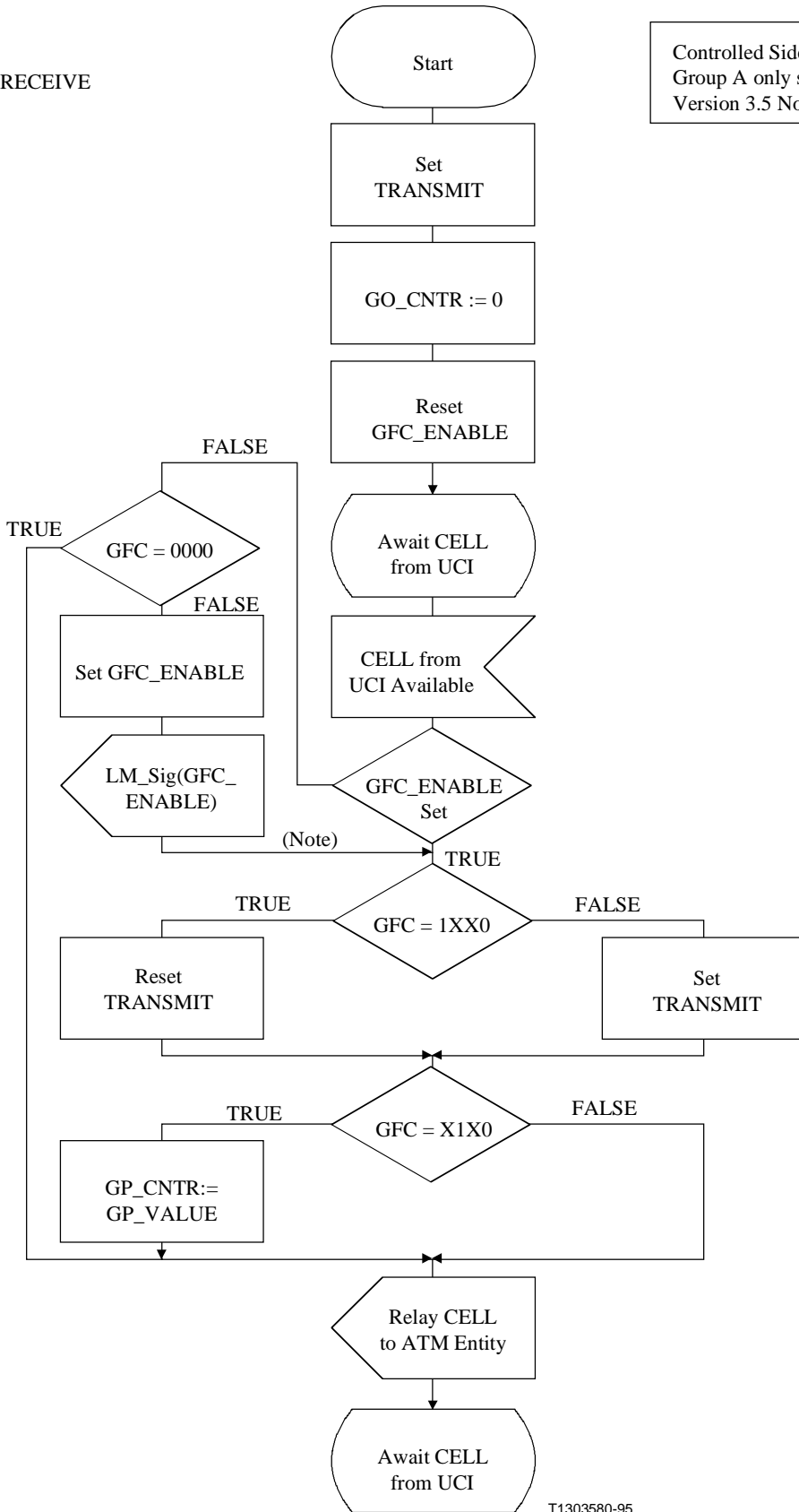

T1303580-95

NOTE – Signal sent to ATMM Entity that GFC_ENABLE is set.

Figure B.4/I.361 – Receive Process of GFC_Function – Only Group A supported

Controlled Side
Group A only supported
Version 3.5 Nov. 1994

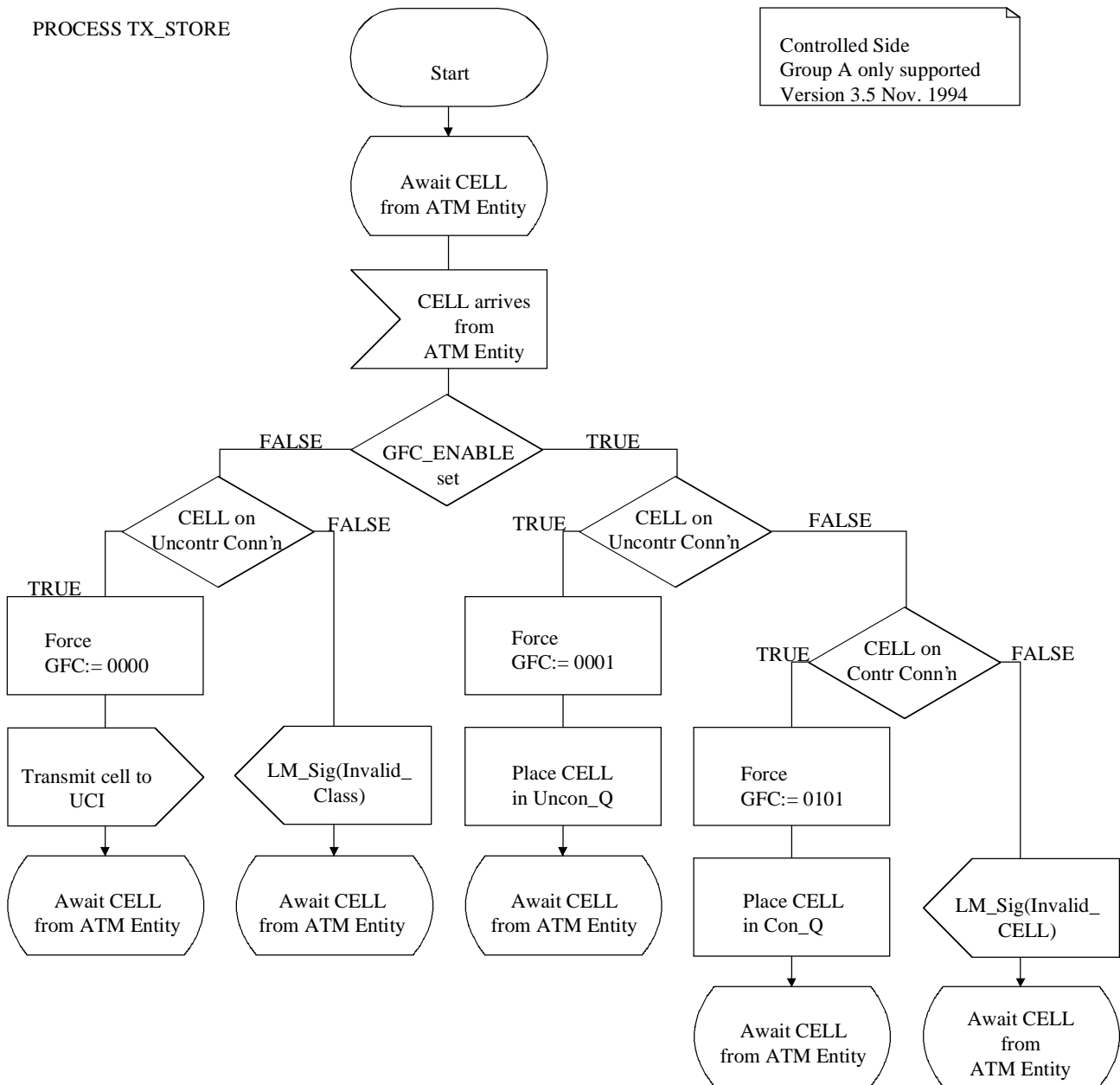

T1303590-95

Figure B.5/I.361 – TX_STORE process in GFC_Function – Only Group A supported

PROCESS TRANSMIT

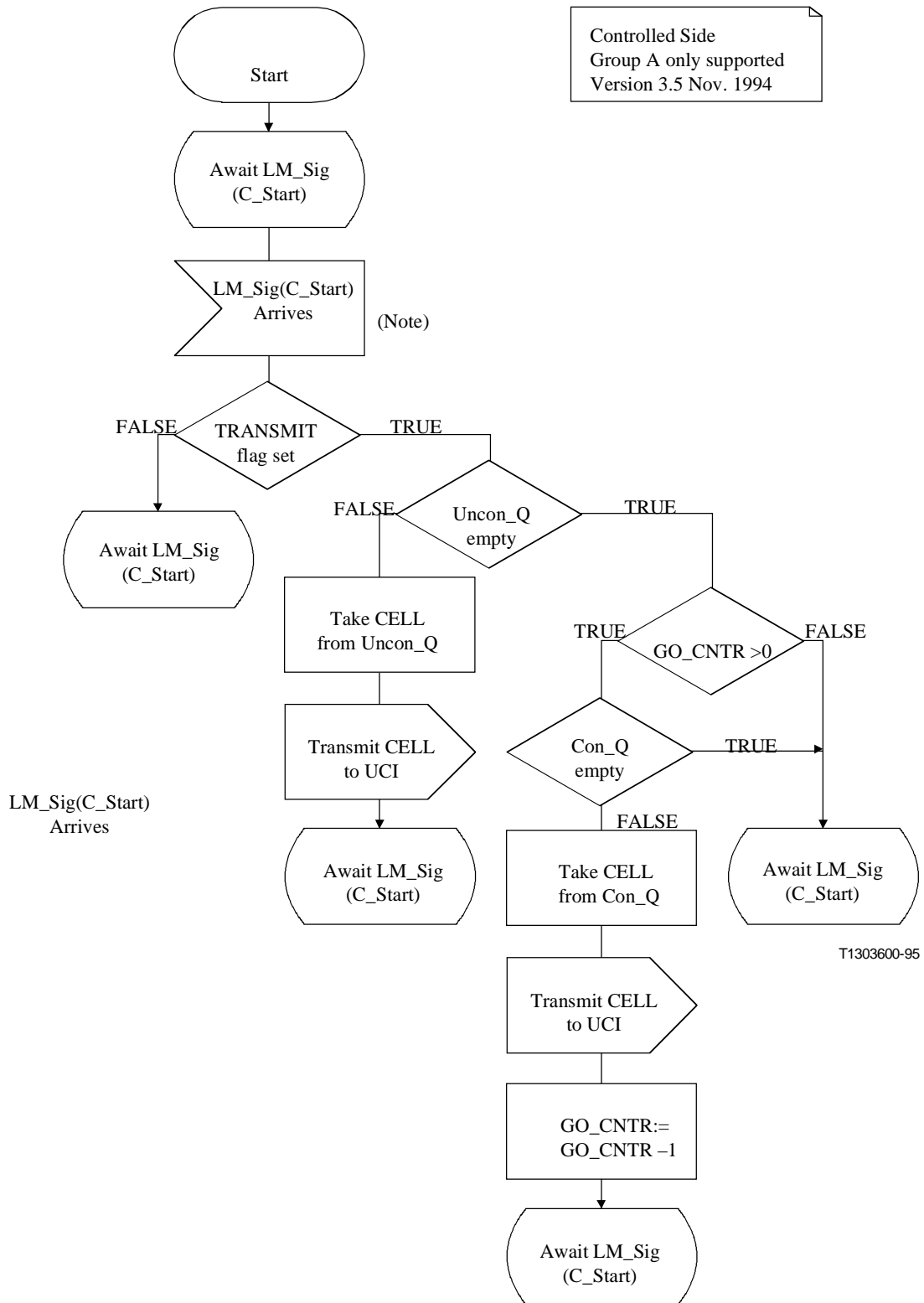

NOTE – LM_Sig(C_Start) indicates that PHY layer is ready for next cell.

Figure B.6/I.361 – TRANSMIT process in GFC_Function – Only Group A supported

PROCESS RECEIVE

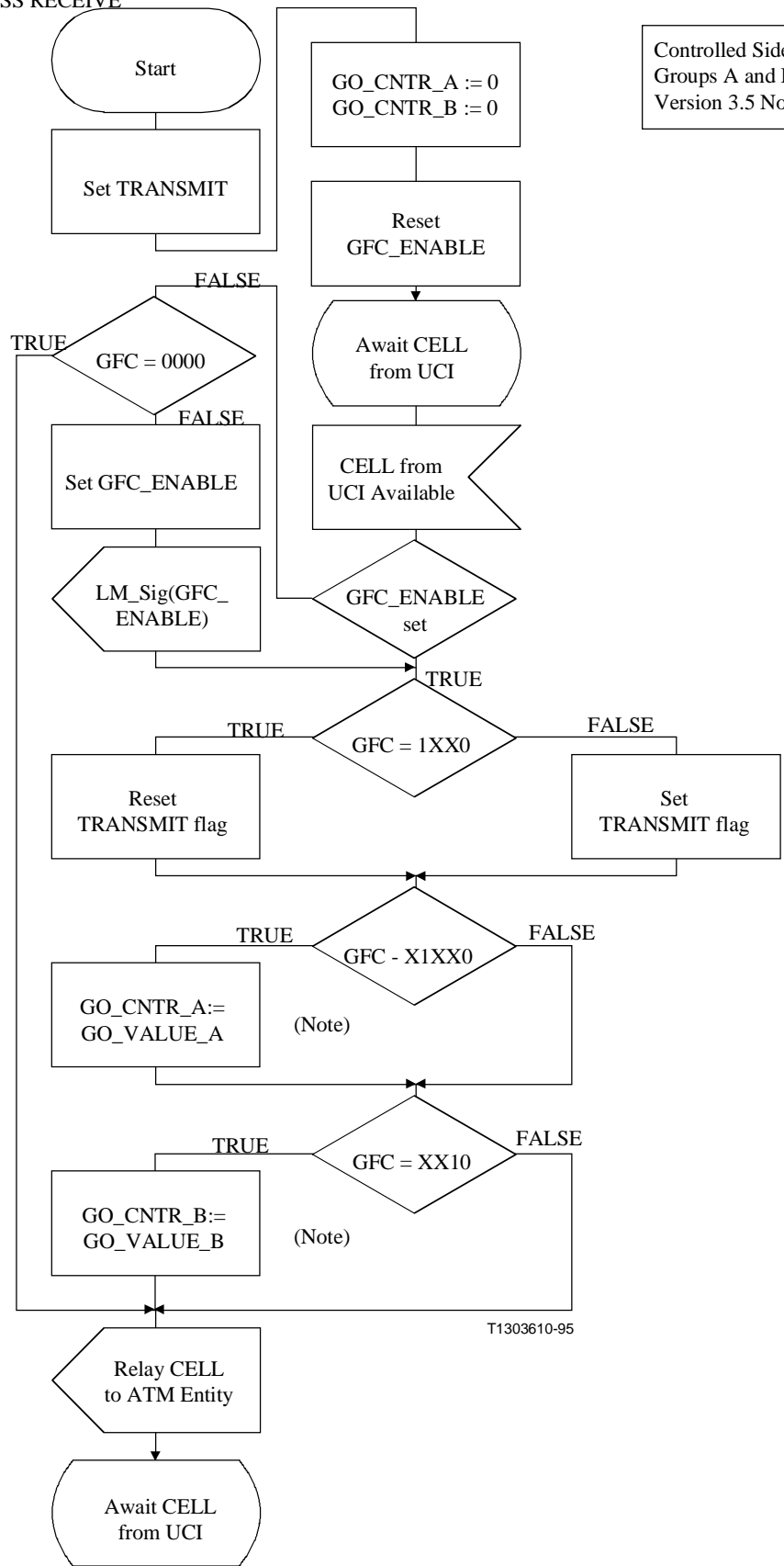

Controlled Side
Groups A and B supported
Version 3.5 Nov. 1994

T1303610-95

NOTE – GO_VALUE_A and GO_VALUE_B set by ATMM Entity.

Figure B.7/I.361 – Receive process of GFC_Function – Group A and Group B supported

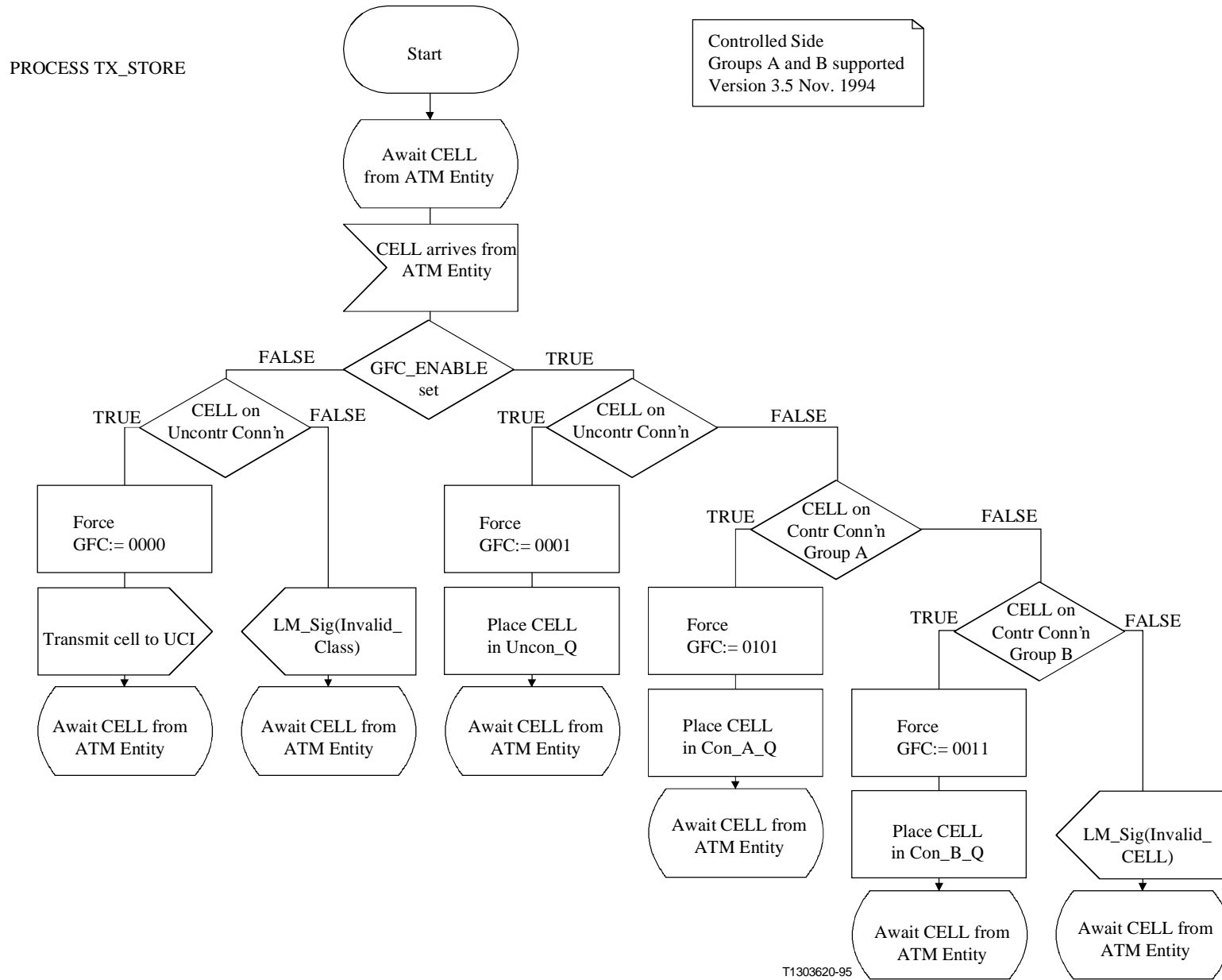
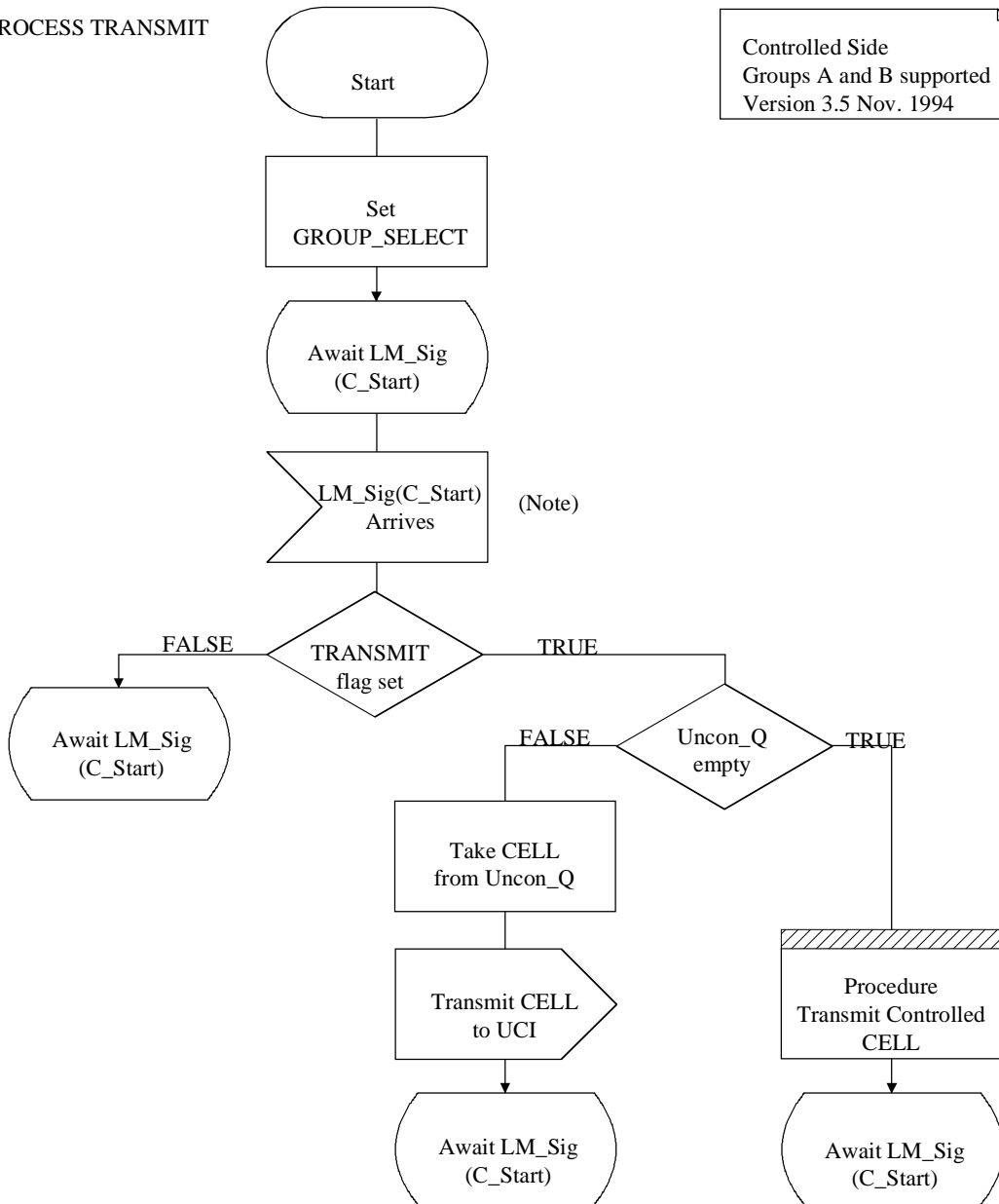

Figure B.8/I.361 – TX_STORE process in GFC_Function Group A and Group B supported

PROCESS TRANSMIT

Controlled Side
Groups A and B supported
Version 3.5 Nov. 1994



T1303630-95

NOTE – LM_Sig(C_Start) indicates that PHY layer is ready for next cell.

Figure B.9/I.361 – TRANSMIT process in GFC_Function – Group A and Group B supported

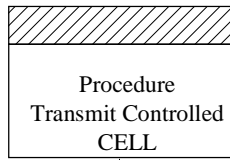

Controlled Side
Groups A and B
supported
Version 3.5 Nov. 1994

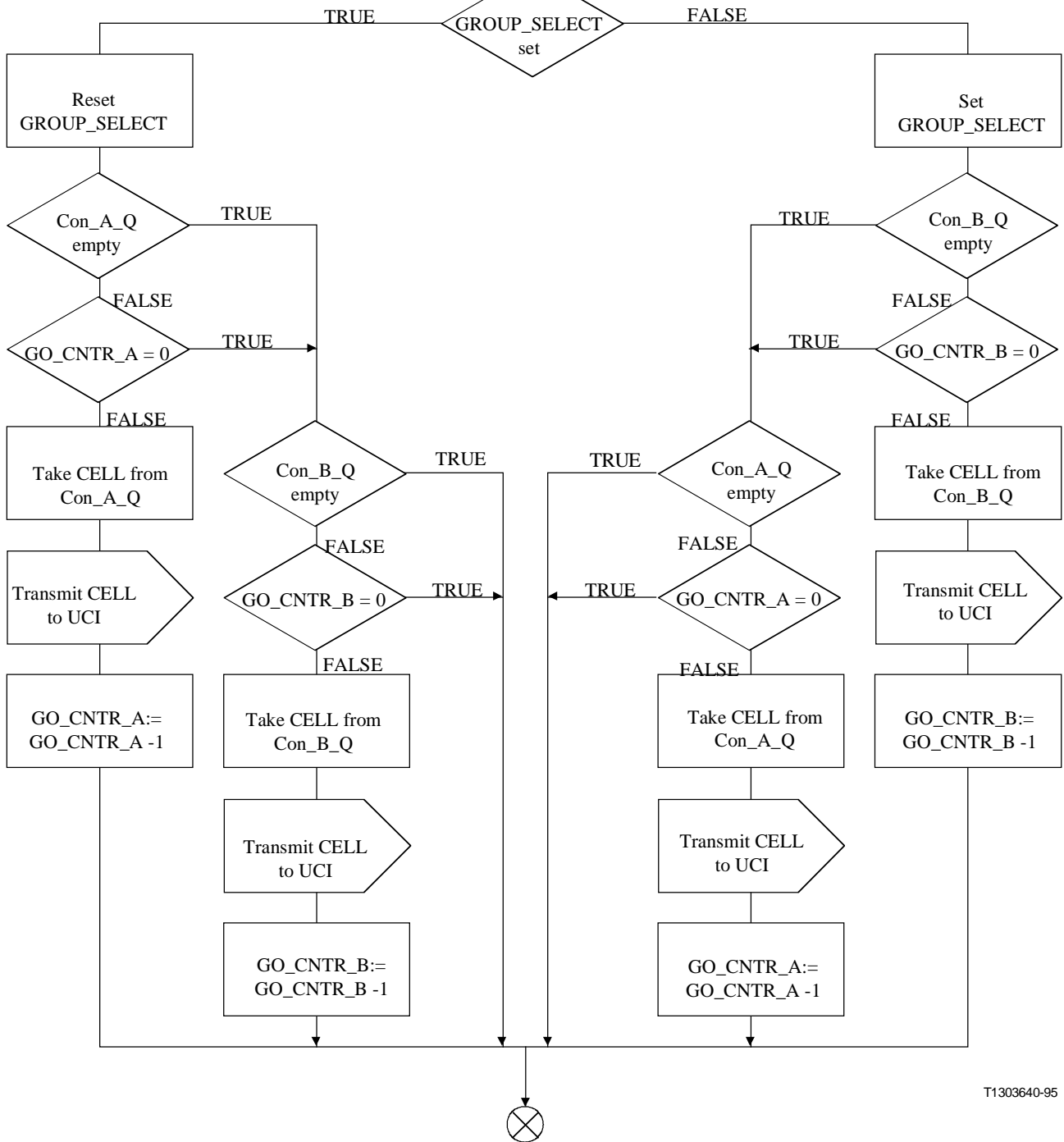

T1303640-95

Figure B.10/I.361 – TRANSMIT Controlled CELL procedure of TRANSMIT process in GFC_Function – Group A and Group B supported

PROCESS
RECEIVE

Controlled Side
Group A only supported
Version 3.3 Sept. 1997

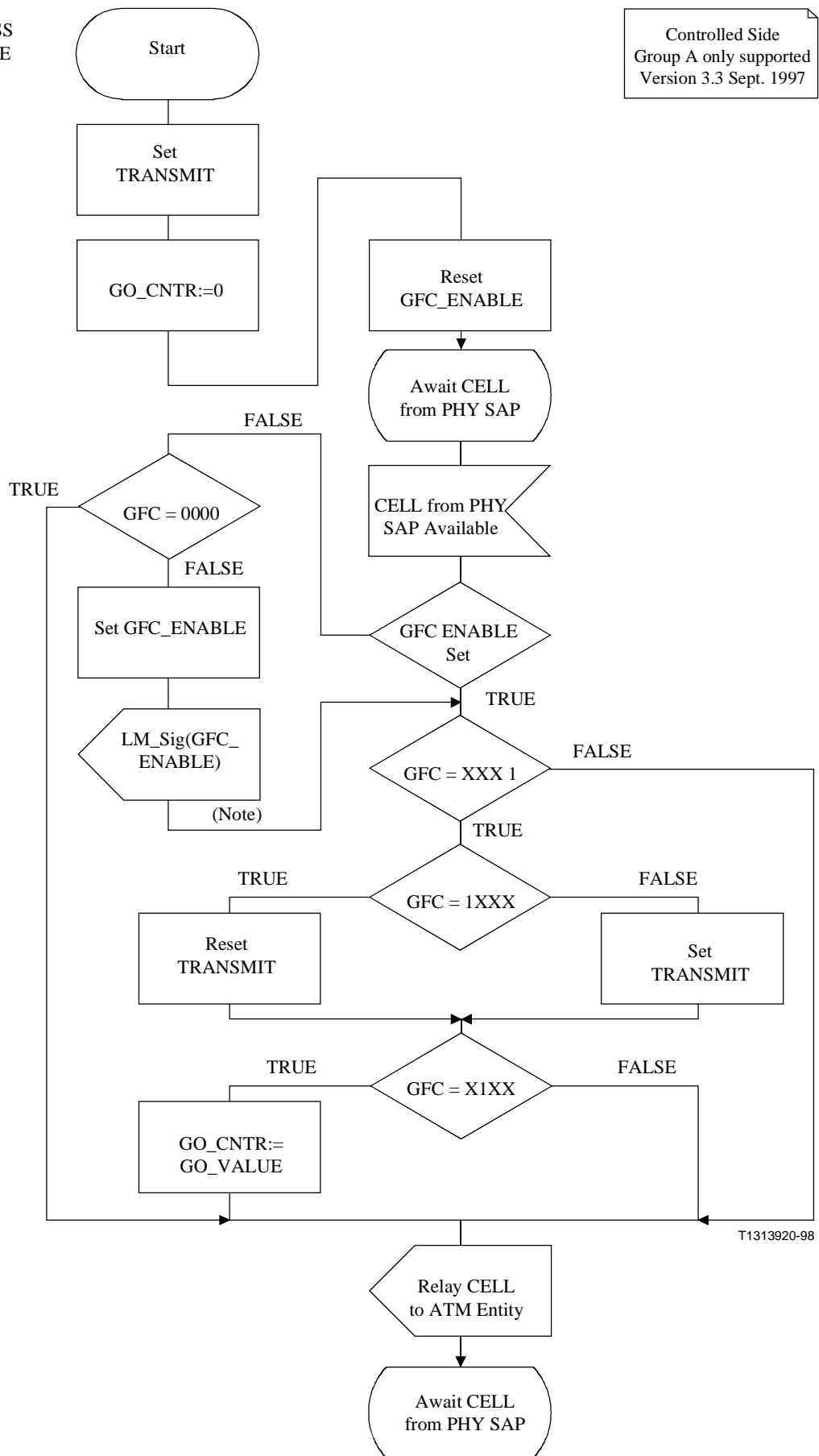

NOTE – Signal send to ATMM Entity that GFC_ENABLE is set.

Figure B.11/I.361 – SDL diagrams for GFC mechanism at the multiaccess UNI (Part 1 of 2)

PROCESS
RECEIVE

Controlled Side
Groups A and B supported
Version 3.3 Sept. 1997

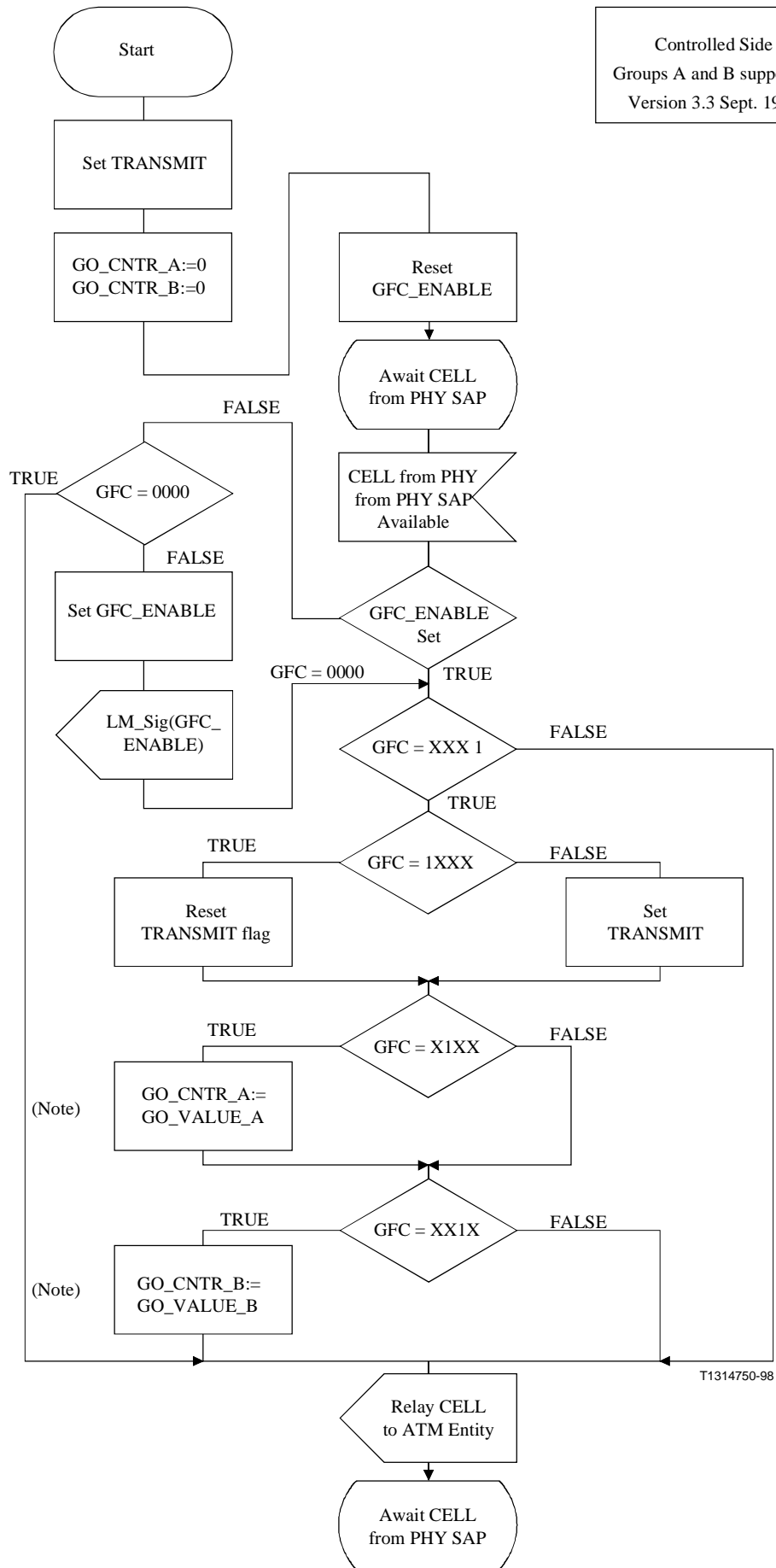

NOTE – GO_VALUE_A and GO_VALUE_B set by ATMM Entity.

Figure B.11/I.361 – SDL diagrams for GFC mechanism at the multiaccess UNI (Part 2 of 2)

APPENDIX I

Pre-assigned values of physical cell headers

This appendix gives the pre-assigned values of physical cell headers that are already recommended. Information on these pre-assigned values are given in the referred Recommendations.

	Octet 1	Octet 2	Octet 3	Octet 4	Reference
Physical layer OAM cell for F1 flow	00000000	00000000	00000000	00000011	Rec. I.432.2
Physical layer OAM cell for F3 flow	00000000	00000000	00000000	00001001	Rec. I.432.2
Physical layer OAM cell for inverse multiplexing	00000000	00000000	00000000	00001011	(to be determined)
Physical layer OAM cell for ATM PON	00000000	00000000	00000000	00001101	Rec. G.983

ITU-T RECOMMENDATIONS SERIES

- Series A Organization of the work of the ITU-T
- Series B Means of expression: definitions, symbols, classification
- Series C General telecommunication statistics
- Series D General tariff principles
- Series E Overall network operation, telephone service, service operation and human factors
- Series F Non-telephone telecommunication services
- Series G Transmission systems and media, digital systems and networks
- Series H Audiovisual and multimedia systems
- Series I Integrated services digital network**
- Series J Transmission of television, sound programme and other multimedia signals
- Series K Protection against interference
- Series L Construction, installation and protection of cables and other elements of outside plant
- Series M TMN and network maintenance: international transmission systems, telephone circuits, telegraphy, facsimile and leased circuits
- Series N Maintenance: international sound programme and television transmission circuits
- Series O Specifications of measuring equipment
- Series P Telephone transmission quality, telephone installations, local line networks
- Series Q Switching and signalling
- Series R Telegraph transmission
- Series S Telegraph services terminal equipment
- Series T Terminals for telematic services
- Series U Telegraph switching
- Series V Data communication over the telephone network
- Series X Data networks and open system communications
- Series Y Global information infrastructure and Internet protocol aspects
- Series Z Languages and general software aspects for telecommunication systems