



INTERNATIONAL TELECOMMUNICATION UNION

ITU-T

TELECOMMUNICATION
STANDARDIZATION SECTOR
OF ITU

I.333

(03/93)

**INTEGRATED SERVICES DIGITAL
NETWORK (ISDN)**

**OVERALL NETWORK ASPECTS
AND FUNCTIONS**

TERMINAL SELECTION IN ISDN

ITU-T Recommendation I.333

(Previously "CCITT Recommendation")

FOREWORD

The ITU Telecommunication Standardization Sector (ITU-T) is a permanent organ of the International Telecommunication Union. The ITU-T is responsible for studying technical, operating and tariff questions and issuing Recommendations on them with a view to standardizing telecommunications on a worldwide basis.

The World Telecommunication Standardization Conference (WTSC), which meets every four years, established the topics for study by the ITU-T Study Groups which, in their turn, produce Recommendations on these topics.

ITU-T Recommendation I.333 was revised by the ITU-T Study Group XVIII (1988-1993) and was approved by the WTSC (Helsinki, March 1-12, 1993).

NOTES

1 As a consequence of a reform process within the International Telecommunication Union (ITU), the CCITT ceased to exist as of 28 February 1993. In its place, the ITU Telecommunication Standardization Sector (ITU-T) was created as of 1 March 1993. Similarly, in this reform process, the CCIR and the IFRB have been replaced by the Radiocommunication Sector.

In order not to delay publication of this Recommendation, no change has been made in the text to references containing the acronyms "CCITT, CCIR or IFRB" or their associated entities such as Plenary Assembly, Secretariat, etc. Future editions of this Recommendation will contain the proper terminology related to the new ITU structure.

2 In this Recommendation, the expression "Administration" is used for conciseness to indicate both a telecommunication administration and a recognized operating agency.

© ITU 1993

All rights reserved. No part of this publication may be reproduced or utilized in any form or by any means, electronic or mechanical, including photocopying and microfilm, without permission in writing from the ITU.

CONTENTS

	<i>Page</i>
1 Introduction	1
2 Scope	1
3 General principles	2
3.1 Terminal selection requirements.....	2
3.2 General operations	3
3.3 Terminal selection responsibilities	7
4 Terminal selection functions	7
4.1 Information elements for the support of terminal selection functions	8
4.2 Procedures for the support of terminal selection functions	8
4.3 Procedures between terminating local exchange and called terminals	9
5 Terminal selection procedures.....	10
5.1 Calls within ISDN(S).....	10
5.2 Terminal selection for interworking	19
5.3 Terminal functionality for general purpose terminals.....	23
5.4 Terminal functionality for compatibility with the “sub-addressing” supplementary service.....	25
Appendix I – Examples of terminal selection in illustrative configurations	25
I.1 Limited functionality speech terminal	25
I.2 Multiple different terminals on a passive bus	26

TERMINAL SELECTION IN ISDN

(Melbourne, 1988; revised Helsinki, 1993)

1 Introduction

This Recommendation defines “terminal selection” as the procedures carried out between a terminating ISDN exchange and ISDN terminals situated behind an ISDN interface leading to customer premises whereby terminal response equivalent to answer or rejection is solicited. The procedures apply to both point-to-point and point-to-multipoint terminal operations.

The primary objective of this Recommendation is to provide overall principles on terminal selection in ISDN. This Recommendation therefore provides a framework within which network providers or users may choose appropriate terminal selection procedures, to suit their own operating environment and applications.

Appendix I contains illustrations of terminal selection techniques that are useful in appropriate circumstances.

Note that in the case of an existing terminal (TE2) connected via a terminal adaptor (TA) to an ISDN access, the combination of TA and TE2 provides the same functionality as a TE1. As there should be no modifications to the existing terminal, the functions described are provided by the terminal adaptor.

NOTE – In the context of this Recommendation “terminal” is a generic term and does not constrain the implementation of physical terminals which may consist of one or more logical terminals.

2 Scope

2.1 It is recognized that call setup is an end-to-end process requiring appropriate switching, signalling and terminal functionality at both ends. However, the frame of reference used in this Recommendation is mainly the terminating ISDN exchange and the terminal configuration(s) served by that exchange. The originating exchange and the terminal configuration(s) served by that exchange are covered only if a specific request for a terminal function at the calling side, supporting the terminal selection procedure at the called side, is identified.

2.2 It is also recognized that calls originating from existing non-ISDN networks (e.g. PSTN or PSPDN) with limited addressing and signalling capabilities will not be able to use the full range of terminal selection functions. This Recommendation therefore addresses the terminal selection for the following types of calls:

- calls within the ISDN:
 - i) based on non-initialization procedures and end-to-end capability. In this case, the network provides basic capabilities and has no knowledge of service profiles of terminals and related terminal identities (an illustrative example is provided in I.1.1);
 - ii) based on terminal initialization procedures. In this case, the terminating exchange provides additional capabilities and the network has knowledge of service profiles of terminals and related terminal identities and hence can assist in terminal selection (see 4.3);
- calls from public non-ISDN networks (e.g. PSTN or PSPDN) to ISDN.

NOTE – Calls from private networks to ISDN are not currently addressed in this Recommendation.

2.3 This Recommendation addresses terminal selection in ISDN for both basic and primary rate access, whereby selection takes place among the terminals belonging to one access.

2.4 Though selection of a specific terminal in a multipoint configuration in ISDN for maintenance and operation purposes may be a requirement, this Recommendation does not currently address this application.

2.5 This Recommendation is related to and/or is compatible with the following Recommendations:

- Recommendations of the I.200-Series on ISDN services;
- Recommendation I.330: ISDN numbering and addressing principles;
- Recommendation I.331 (E.164): Numbering plan for the ISDN era;
- Recommendations I.410, I.411, I.412: ISDN user – network interfaces;
- Recommendation I.441 (Q.921): ISDN user – network interfaces layer 2 specifications;
- Recommendation I.451 (Q.931): ISDN user – network interfaces layer 3 specifications;
- Recommendations of the I.500-Series defining interworking between various networks;
- Recommendation Q.932, Annex A: Generic procedures for the control of ISDN; supplementary services – User service profiles and terminal identification.
- Recommendation T.90: Characteristics and protocols for terminals for telematic services in ISDN.

3 General principles

3.1 Terminal selection requirements

An ISDN number identifies any one interface (physical or virtual) or multiple interfaces or all of the interfaces at reference point S (2.1/I.330), but does not provide the capability to identify services, which – in the ISDN user context – are assigned to individual terminals.

Requirements are imposed on terminal selection by the potential multiple terminal arrangements at called subscriber's premises and the ISDN support of multiple services, which implies the provision of information for unambiguously identifying the individual service.

Information in addition to the ISDN number (unique number assigned to an access) are needed since the ISDN number is insufficient to make needed distinctions among terminals. This Recommendation addresses the general principles to be applied in selecting

- 1) specific individual terminals or
- 2) groups of terminals among which, for the purpose of terminal selection, no further distinction is required by the terminating user's terminal configuration.

These terminals may slightly differ in their functionality but still be compatible and it is the user's decision which terminal is member of a particular group.

There may exist multiple physical terminals on a point-to-multipoint configuration (e.g. passive bus), whose interfaces are identified by an ISDN number, or the relevant part of it. Within each physical terminal there may exist one or more logical terminals (as shown in Figure 1). A logical terminal is considered to be the exchange's view of the physical terminal(s) on an interface.

Eight logical terminals (the inner boxes; labelled LT1 to LT8) are shown in a total of four physical terminals (the outer boxes; labelled PT1 to PT4). Each physical terminal corresponds to at least one individual TEI (see Note), while each logical terminal corresponds to one individual TEI. The arrangement shown in Figure 1 reflects a customer subscribing to the "multiple subscriber number" (MSN) supplementary service, otherwise SN values are equal and thus not relevant to the capability to discriminate between terminals.

NOTE – The terminal endpoint identifier (TEI) is part of the D-channel layer 2 address field (see Recommendation Q.921/I.441).

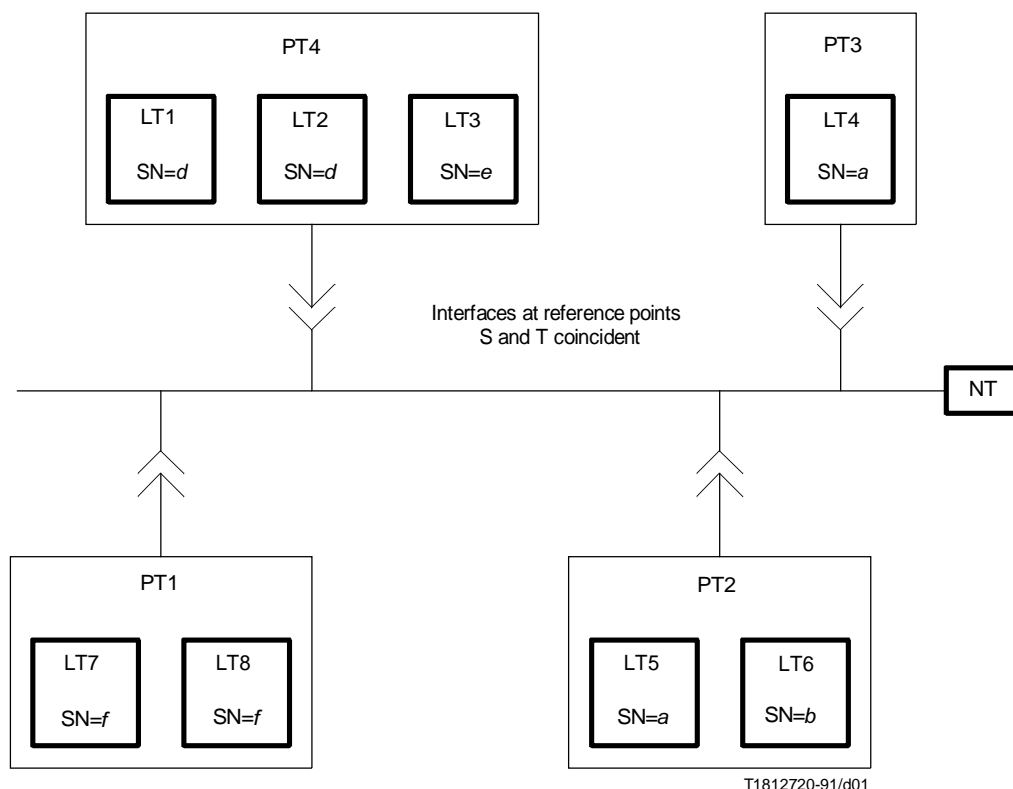

PT Physical terminal
 LT Logical terminal
 SN=a Subscriber number with value "a"
 NT Network termination

NOTE – The values "a", "d" and "f" are used as group numbers for logical terminals. The numbers do not need to be contiguous numbers.

FIGURE 1/I.333
Illustration of logical terminal arrangements

3.2 General operations

Terminal selection relies heavily on the call setup protocols according to Recommendation Q.931/I.451 and makes use of complementary elements involved in the call setup process, some of them referring to terminal identity while some others referring to compatibility. The elements referring to terminal identity include any type of number such as ISDN number and sub-address while the elements referring to compatibility include any type of compatibility information such as bearer capability, low layer compatibility and high layer compatibility. Terminal selection is therefore a combination of terminal identification (based on a number without any relationship to compatibility) and compatibility checking, whereby these two mechanisms are used in a complementary manner. Since the call setup procedures are making use of out-band signalling, the compatibility check applicable to terminal selection is out-band compatibility checking.

The characteristics of out-band compatibility checking and its relationship to in-band compatibility checking are as follows:

3.2.1 Out-band and in-band compatibility checking are complementary mechanisms rather than conflicting mechanisms.

3.2.2 Out-band compatibility checking is related to terminal selection. Out-band compatibility checking may continue after terminal selection to achieve compatibility at the communication level (e.g. user-to-user protocols and their parameters).

3.2.3 In-band compatibility checking starts when a terminal was selected (as seen by the network). It can include notification of compatibility information or negotiation of terminal characteristics. The actions to be taken if in-band compatibility checking fails require further study, however, it might be difficult to accommodate the calling/called user's terminal profile pending elements to identify, or being unable to match characteristics of the other party.

3.2.4 From the network's point of view in-band compatibility checking is not related to terminal selection, while from the user's point of view it may be related to terminal selection e.g. if an intelligent unit at called subscriber premises selects a terminal based on information made available by in-band procedures.

3.2.5 With respect to the network's responsibility for conveyance of compatibility information and delivery to the called user's terminal configuration according to the directory number defined by the calling user, there is in principle no difference between out-band and in-band information transfer.

Two distinct compatibilities are defined:

3.2.6 Compatibility between the calling and called terminal covering characteristics such as compatibility of bearer services, teleservices, end-to-end protocol, and parameters which affect transmission quality. This compatibility is dependent upon the particular application e.g. bearer service, teleservice, etc.

3.2.7 Mutual compatibility between terminals served on the same access. This compatibility is required in a terminal population in order to prevent some terminals from accepting calls which are inappropriate to them. This compatibility is dependent upon the particular access and associated terminals, as well as service issues. This compatibility ensures that incoming calls properly originated are accepted only by the appropriate terminal(s).

Figure 2 illustrates these two compatibilities. The mutual compatibility between terminals at the same access makes provision that the lower terminal, which is incompatible to the calling terminal, does not ask the network to connect the call when the SETUP message is received.

Figure 3 illustrates the impact of mutual compatibility between terminals at the same access on "ensured" or "not ensured" compatibility. Note that the indication in the Figure 3 "compatibility not ensured" is intended to mean that compatibility is not ensured though it may exist.

Figure 3 depicts three cases which may exist at called subscriber premises:

- a) All terminals support full ISDN terminal selection functionality (upper case in Figure 3);
- b) Some terminals support full ISDN terminal selection functionality while some others support limited ISDN terminal selection functionality (middle case in Figure 3);
- c) All terminals support limited ISDN terminal selection functionality (lower case in Figure 3).

In order to ensure compatibility according to Figure 3, two conditions have to be satisfied concurrently:

- 1) the information available for out-band compatibility checking has to ensure compatibility, and
- 2) the terminals at called subscriber premises have to be mutually compatible.

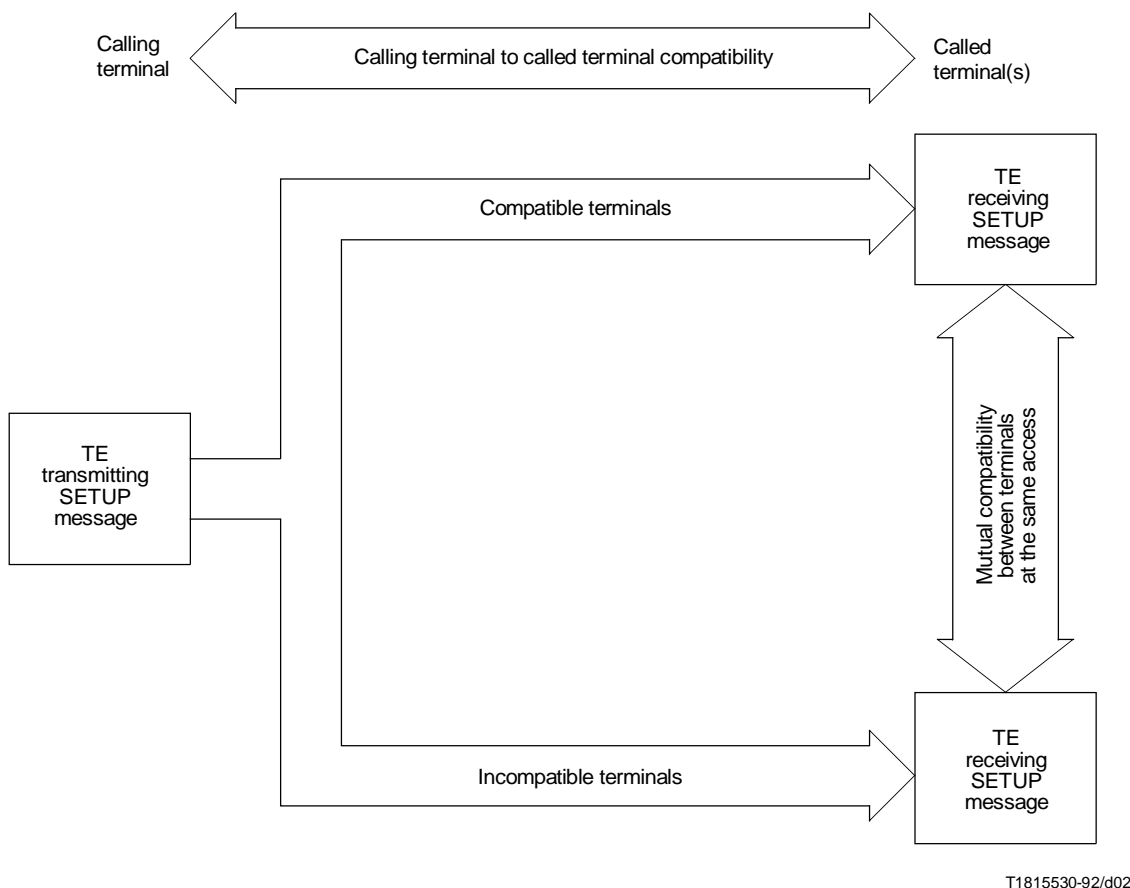

FIGURE 2/I.333
**Calling to called terminal compatibility and mutual compatibility
between terminals at the same access**

In situations where the terminals at called subscriber premises are mutually incompatible, compatibility is not ensured even if the information received for out-band compatibility checking would ensure compatibility. The same applies if terminals at called subscriber premises are mutually compatible, but the information received for out-band compatibility checking does not ensure compatibility.

Terminal identification provides the capability to identify terminals at the called subscriber premises which are compatible (see Note) with the calling terminal according to the out-band compatibility check as follows:

3.2.8 Identification of all the compatible terminals out of the entire population, if the entire terminal population is identified by means of a “global identity”.

3.2.9 Identification of a group of the compatible terminals out of the entire population, if the terminal group is identified by means of a “group identity”.

3.2.10 Identification of a specific compatible terminal out of the entire population, if an individual terminal is identified by means of an “individual identity”.

NOTE – The degree of efficiency of the compatibility check to be met for a particular connection (in the first instance) depends on the amount of out-band compatibility information provided by the calling terminal. It is recognized that non-ISDN originating or transiting exchanges/networks inherently degrade the value of the determined compatibility compared to calls within ISDN.

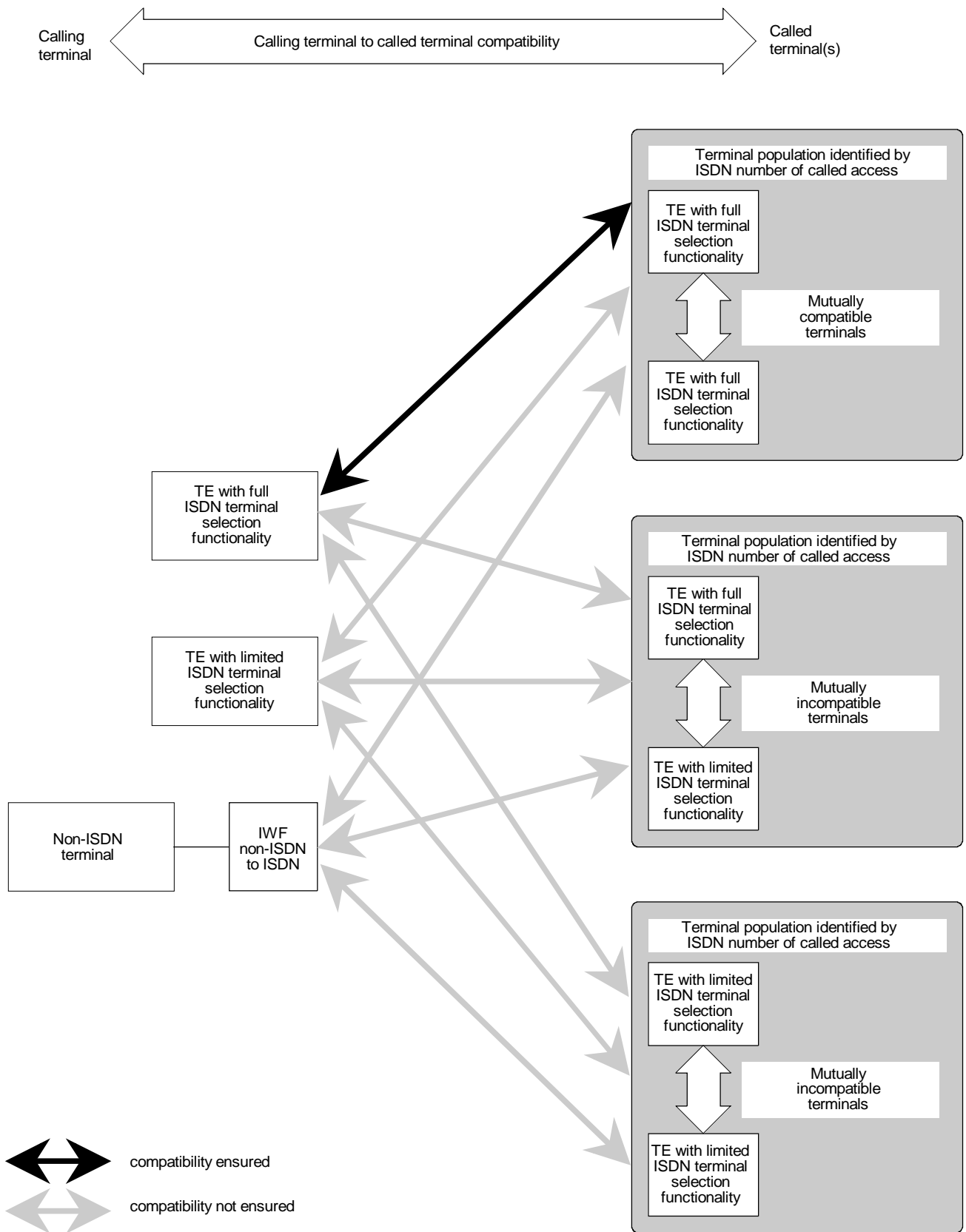

T1815540-92/d03

FIGURE 3/I.333

Out-band compatibility checking in support of terminal selection

The point-to-multipoint operation is emphasized in this Recommendation because it is more comprehensive with respect to terminal selection functions than point-to-point. Nevertheless, the treatment of both point-to-point and point-to-multipoint selection procedures are considered appropriate for this Recommendation. The out-band terminal selection stage is said to be completed when at least one of the terminals which match the identity information, if any, and compatibility information requests connection to the incoming call and is allocated the call. In the case of NT2, the call allocation need not come as a direct result of the point-to-point procedure but may come later embedded in the point-to-point procedures as a result of the procedures between NT2 and a terminal attached to the NT2.

The call establishment may involve information relating to other characteristics than compatibility, called terminal(s) identity and call source, such as "calling party number", "reverse charging indication". Although this additional information may help at the called user side decide if an incoming call is to be accepted or rejected, it has no impact on the selection process.

The details regarding the processing of this information by the terminating exchange and the sequence used in offering this information to the user-network interface may be a matter of formal agreement between the subscriber and the Administration at the time of service provisioning. The call setup and terminal selection procedures in ISDN require cooperation between the terminating exchange and the terminals.

3.3 Terminal selection responsibilities

3.3.1 It is the responsibility of the calling user to identify the characteristics of a call in terms of the capabilities of the calling terminal, the services requested from the network, and to provide the called number to identify the interface at which the call is offered.

3.3.2 Code points shall be defined by the various standard-setting organizations in such a way that it is the responsibility of the called terminal – being aware of its role as called entity – to be capable of performing the counterpart functions to the calling terminal.

3.3.3 In the context of this Recommendation, the prime responsibility of the network is to convey information provided by the calling user's terminal and to deliver it to the addressed user's terminal configuration according to the protocol. This includes the responsibility to deliver a call to the interface identified by the called number using connection types consistent with the service requested by the calling party. However, the network is not able to invoke any corrective action to recover from incorrect use of codepoints defined in relation to a particular service; if for example a 3.1 kHz telephony terminal claims to be a facsimile machine, the network is unable to resolve the resulting problems.

3.3.4 It is the responsibility of the called user to configure the terminals at the called subscriber premises by entering in each terminal the required information in such a way that incoming calls, properly originated, are accepted by compatible terminals.

3.3.5 The network may provide additional capabilities to assist the user to select the terminal with the best match to the request of the calling user. The terminating local exchange keeps track of service profiles of various terminals and relates compatibility information provided by the calling party to an endpoint identifier (EID) information element (see Annex A/Q.932) which identifies the terminal with the best match to the description of the incoming call. These additional capabilities are not required for basic calls. The procedures are described in 4.3.

4 Terminal selection functions

Terminal selection relies on end-to-end capabilities. As a network option, it may also involve terminating local exchange functionality.

4.1 Information elements for the support of terminal selection functions

Any information which categorizes attributes of an incoming call, or refers to a terminal identity, or specifies the call source which could be ISDN or non-ISDN may be used for the terminal selection process. The terminal selection process is a combination of out-band compatibility checking and terminal identification which are used in a complementary manner as part of the call setup protocol according to Recommendation Q.931. Procedures defined in Annex A/Q.932 and in Recommendations Q.921 may be used, based on bilateral agreement between user and network provider, to assist the terminal selection process. Administrations may choose to provide this additional capability.

With respect to out-band compatibility checking, the following elements are relevant (see Note 1). These elements have calling party to called party significance:

- a) bearer capability information element (BC) (see Note 2);
- b) low layer compatibility information element (LLC);
- c) high layer compatibility information element (HLC).

With respect to terminal identification, the following elements are relevant (see Note 1). These elements have calling party to called party significance:

- d) called party number information element;
- e) called party sub-address information element (see Note 3).

NOTES

1 Elements such as endpoint identifier (EID) information element (see 4.3 and Annex A/Q.932) or terminal endpoint identifier (TEI) (see 4.3 and 3.3.4/Q.921) may be added to the above elements as a network provider option. They are locally used and based on a mapping from elements with calling-party-to-called-party significance which takes place in the terminating local exchange.

2 In cases of interworking (e.g. μ /A-law conversion), the BC may be changed between calling and called party.

3 Two types of sub-address are defined, "NSAP" (network service access point) and "user specified".

With respect to the call source:

- f) the progress indicator information element.

The progress indicator information element indicates to the called side if the call source is ISDN (progress indicator information element not present) or non-ISDN (progress indicator information element present) (see Note).

NOTE – The progress indicator information element indicates to the called side if the call encountered an interworking situation or not. This means, when the progress indicator information element is present the interworking situation applies or when the progress indicator information element is not present the call is pure ISDN. In the context of out-band compatibility checking the progress indicator information element indicates whether the description of a call is based on the full ISDN capability or on a reduced set of information elements with limited contents.

Compatibility cannot be ensured by numbering information (ISDN number, sub-address) alone i.e. compatibility information and number are complementary elements.

The called party number information element and/or called party sub-address information element may substitute missing compatibility information, in particular in the case of a call from a non-ISDN network (e.g. PSTN or PSPDN) to the ISDN. However, compatibility is not ensured.

4.2 Procedures for the support of terminal selection functions

The procedures for the support of terminal selection functions rely on the elements identified in 4.1 and are specified in Recommendation Q.931.

In a point-to-multipoint configuration, call setup information from the terminating ISDN exchange to the user's terminal configuration is transferred via broadcast procedures on the access identified by the called ISDN number. All active terminals receive call setup information and determine whether or not to respond. The network will allocate the call to the first terminal which requests connection to the incoming call.

The terminal receiving a SETUP message with a progress indicator information element shall modify its compatibility checking. The terminal should regard the compatibility as successful if it is compatible with the included information, which as a minimum, will be the bearer capability information element reflecting in its obligatory contents the characteristics of the non-ISDN network. A terminal expecting information in addition to the bearer capability information element in a full ISDN environment need not reject the call if such information is absent but a progress indicator information element is included.

In the case of more than one terminal supporting the same service, the supplementary service multiple subscriber number (MSN) (Note 1) or Direct Dialling In (DDI) (Note 2) may be used to identify a specific terminal, or a group of terminals, as appropriate. A terminal which supports these supplementary services MSN (Note 1) or DDI (Note 2) shall be able to recognize its own identity, or identities, as appropriate. Identities are based typically on a number of digits, which consist of the whole, or a part of the subscriber number in the ISDN numbering plan. The required information for MSN or DDI is conveyed in the called party number information element.

This principle applies for both a homogeneous ISDN environment and for interworking cases with non-ISDN. In a homogeneous ISDN environment the sub-addressing function (Note 3) may be used alternatively. However, it cannot be used in all cases of interworking (e.g. PSTN).

NOTES

1 Based on the use of distinct ISDN numbers, the supplementary service "multiple subscriber number" enables specific terminal(s), connected to the basic access in a point-to-multipoint configuration, to be indicated by the called party number.

2 Based on the use of distinct ISDN numbers, the supplementary service "Direct Dialling In" enables a user to establish a connection to another user or an ISPBX, or other private system without attendant intervention.

3 Based on an extension of the addressing capability beyond the E.164/I.331 numbering plan, sub-addressing enables the calling user to select a specific terminal at the called user's termination and/or to invoke a specific process in the called terminal at the called user's termination.

Networks supporting services to identify a specific terminal, or a subset of terminals, within a population of terminals (e.g. supplementary service "multiple subscriber number") may also offer "global calls", based on a "global identity", see 3.2.8. An incoming call is global if there is no information contained in the call setup message to relate the call to a subset of the terminal population based on terminal identity (information on terminal identity is conveyed in the called party number information element). The term "global identity" is used to reflect the global relationship with respect to terminal identity and suitable coding methods are:

- to omit the called party number information element;
- to define a specific called party number as global number (see also Q.931).

If the terminating local exchange is aware that the access is a point-to-point configuration, e.g. in cases where an NT2 is connected to the access, the point-to-point procedures specified in Recommendation Q.931 may be used.

4.3 Procedures between terminating local exchange and called terminals

Between terminating local exchange and called terminals on an access, optional procedures are defined for the support of terminal selection. These procedures rely on service profiles maintained in the serving local exchange and the capability of the local exchange to establish an association between a specific service profile and a user service identifier (USID). In order to discriminate between terminals, if required, using a common service profile within one access, a terminal identifier (TID) is provided. The parameters USID and TID in combination with additional information to interpret them from the endpoint identifier (EID) parameter which is conveyed in the endpoint identifier information element (see Figure 8-1/Q.932). The details of these procedures can be found in Annex A/Q.932.

The procedures include the capability:

- a) to establish an association between service profile and a communication endpoint (identified by EID) where the service is supported;
- b) to include into a SETUP message an endpoint identifier information element containing the EID parameter;
- c) to assign a service profile to a data link connection.

Since the procedures are optional for both the user and the network side, they require that:

- d) both the user and the network side include a mechanism to abandon the initialization procedure if one or the other peer does not support these optional procedures;
- e) terminals not supporting these procedures, when receiving a SETUP message proceed according to "normal" call control procedures for "non-mandatory information element errors" (see 5.8.7/Q.931).

The establishment of an association between service profile and a communication endpoint (identified by EID) can be done by means of the following options which are not mutually exclusive:

- f) an automatic EID assignment procedure between user's terminals and serving local exchange; or
- g) a local procedure at the user side to enter the EID parameter followed by an initialization procedure.

Incoming calls are analysed by the local exchange (bearer capability information element, etc.) and related to the service profile which matches the compatibility information provided by the calling party. The call is then offered to the called user's terminal configuration by means of the "normal" call control procedures enhanced by the endpoint identifier information element. It is apparent that the USID, which uniquely identifies a service profile, is used to check compatibility while the TID is used to check an identity e.g. to uniquely identify a terminal within a population of terminals sharing a common service profile. Thus, the USID parameter is service related while the TID parameter is identity related.

5 Terminal selection procedures

5.1 Calls within ISDN(S)

5.1.1 Terminal selection within control (C) – plane

Terminal selection within control (C) – plane provides the generic procedures for terminal selection in various configurations. The sequences to establish an ISDN-connection to the requested, compatible terminal at called customer premises are shown in Figure 4. They are started by the message "SETUP" (top left hand corner of Figure 4) and are completed by the message "CONNECT" which confirms the calling terminal that a compatible terminal is connected. The terminal selection process is confined to the C-plane. The network will allocate the call to the first terminal which requests connection to the incoming call.

5.1.2 Terminal selection in the case of OSI-CONS (Open systems interconnection connection oriented network service) based on transparent B- or H-channels

5.1.2.1 Reference model for CONS over ISDN transparent channels

The reference model for terminal selection in the case of OSI-CONS over ISDN transparent channels is depicted in Figure 5. This model makes a clear distinction between C- and U-plane, which is important to identify the procedures involved in the terminal selection process. According to this model, each C- and U-plane may be seen as a sub-network providing a sub-network service (N(c) service and N(u) service, respectively). The synchronization and coordination function on top is providing the required coordination between the two sub-network services, in order to provide a single network service as defined in Recommendation X.213 (see Figure 5).

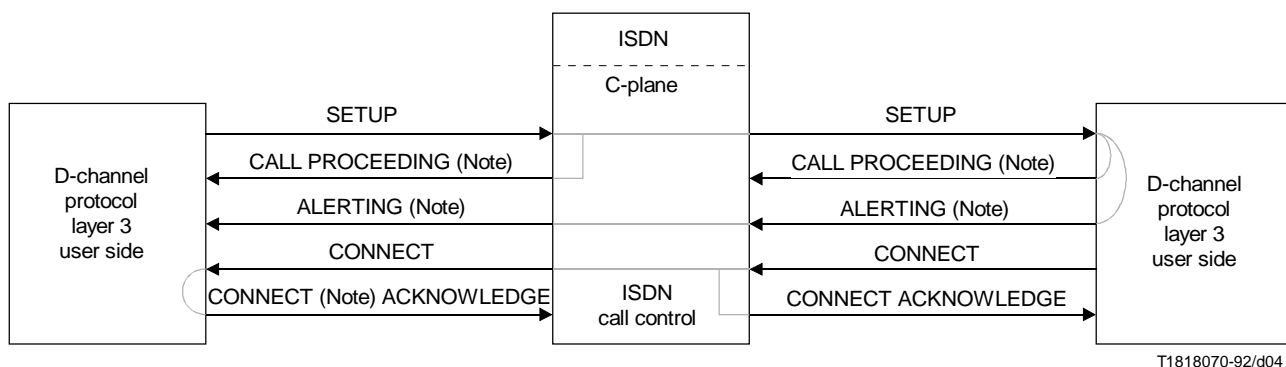

NOTE – These messages may not apply in certain cases.

FIGURE 4/I.333
Signalling sequences for terminal selection within control-plane

5.1.2.2 Terminal selection in support of CONS over ISDN transparent channels

The sequences to establish an N-connection are shown in Figure 6. They are started by the primitive “N-CONNECT request” (top left hand corner of Figure 6) and are completed by the primitive “N-CONNECT confirm”. The terminal selection process is confined to the C-plane, and in particular the N-service user is not involved. At the called side the functional entity “Synchronization and coordination function” requests connection to the incoming call by issuing the N(C)-CONNECT response primitive which causes the transmission of the CONNECT message. The network will allocate the call to the first endsystem which requests connection to the incoming call. Note that it could occur that a call accepted by C-plane layer 3 will be rejected later on within the service provider U-plane (e.g. DM in response to SABM), or at the level of the N-service user by means of an N-DISCONNECT request in response to an N-CONNECT indication. According to this scenario, the NSAP address is not involved in the terminal selection process, though conveyed by ISO 8208 (X.25 PLP) procedures. This may cause rejection of the connection, if there is a mismatch between the elements relevant for terminal selection and the requested NSAP.

NOTE – The packets “call request” and “call connected” reflect the point of view of the calling endsystem (left side) while as seen by the called endsystem the same codepoints (packet type identifier, octet 3) correspond to “incoming call” and “call accepted”, respectively.

5.1.3 Terminal selection in the case of OSI-CONS based on ISDN Frame Mode Bearer Service (FMBS)

5.1.3.1 Reference model for CONS based on ISDN FMBS

The reference model for terminal selection in the case of OSI-CONS based on ISDN FMBS is depicted in Figure 7. This model makes a clear distinction between C- and U-plane, which is important to identify the procedures involved in the terminal selection process. According to this model, each, C- and U-plane may be seen as a sub-network providing a sub-network service (N(c) service and N(u) service, respectively). The synchronization and coordination function on top (see Figure 7) provides the required coordination between the two sub-network services, resulting in a single network service as defined in Recommendation X.213.

The Q.922 core functions are supported by frame switching and frame relaying networks.

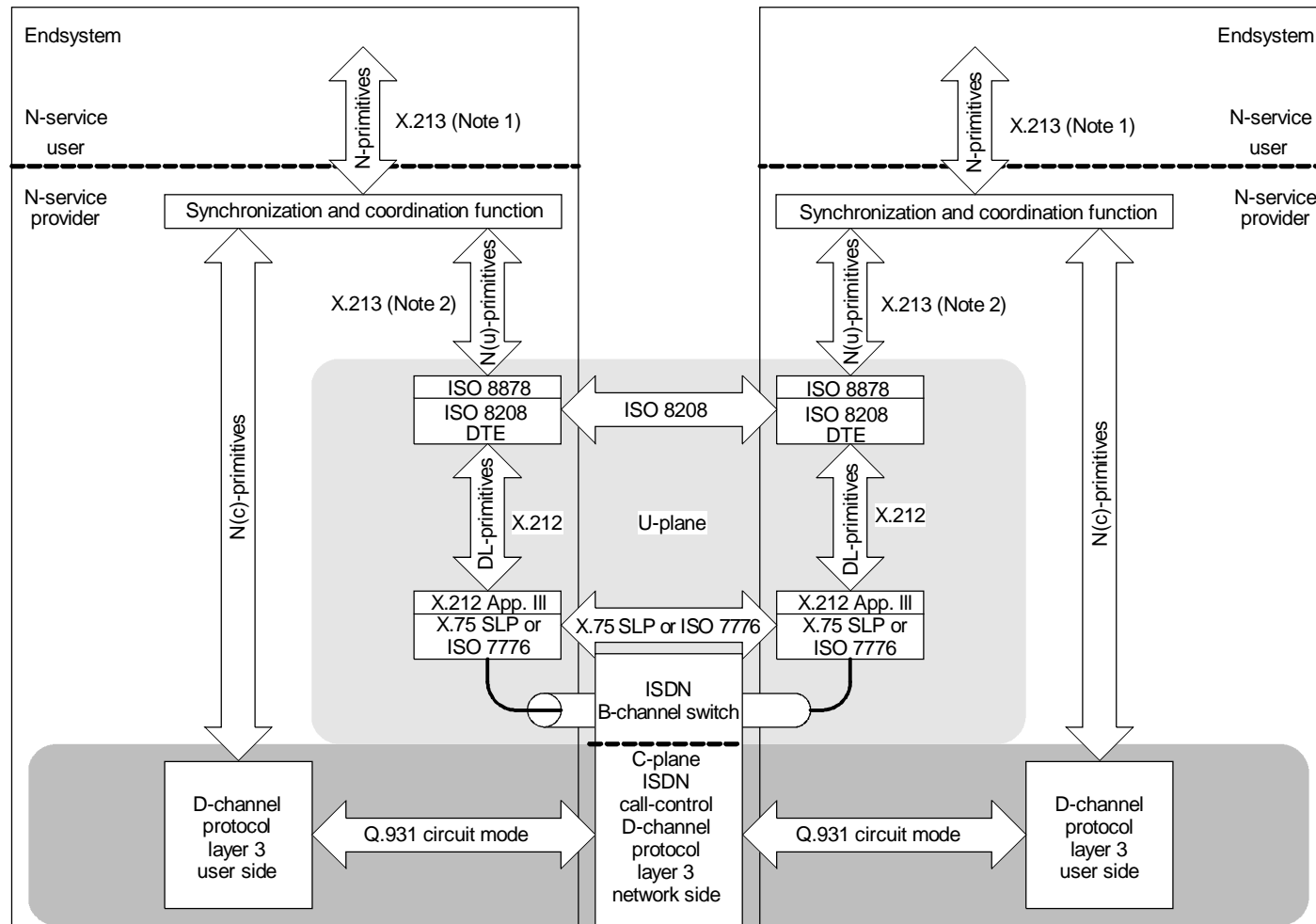

T1812730-91/d05

NOTES

- 1 The service according to X.213 is provided by the layer 3 to layer 4 at the layer 3 - layer 4 boundary. It is a network layer service.
- 2 The service according to X.213 is provided by the U-plane to the synchronization and coordination function. Although it is not a network layer service in a layered architecture using the concept of C- and U-plane, all the capabilities of a network layer service are provided. It is the service of the U-plane sub-network.

FIGURE 5/I.333

Reference model for CONS over ISDN transparent channels

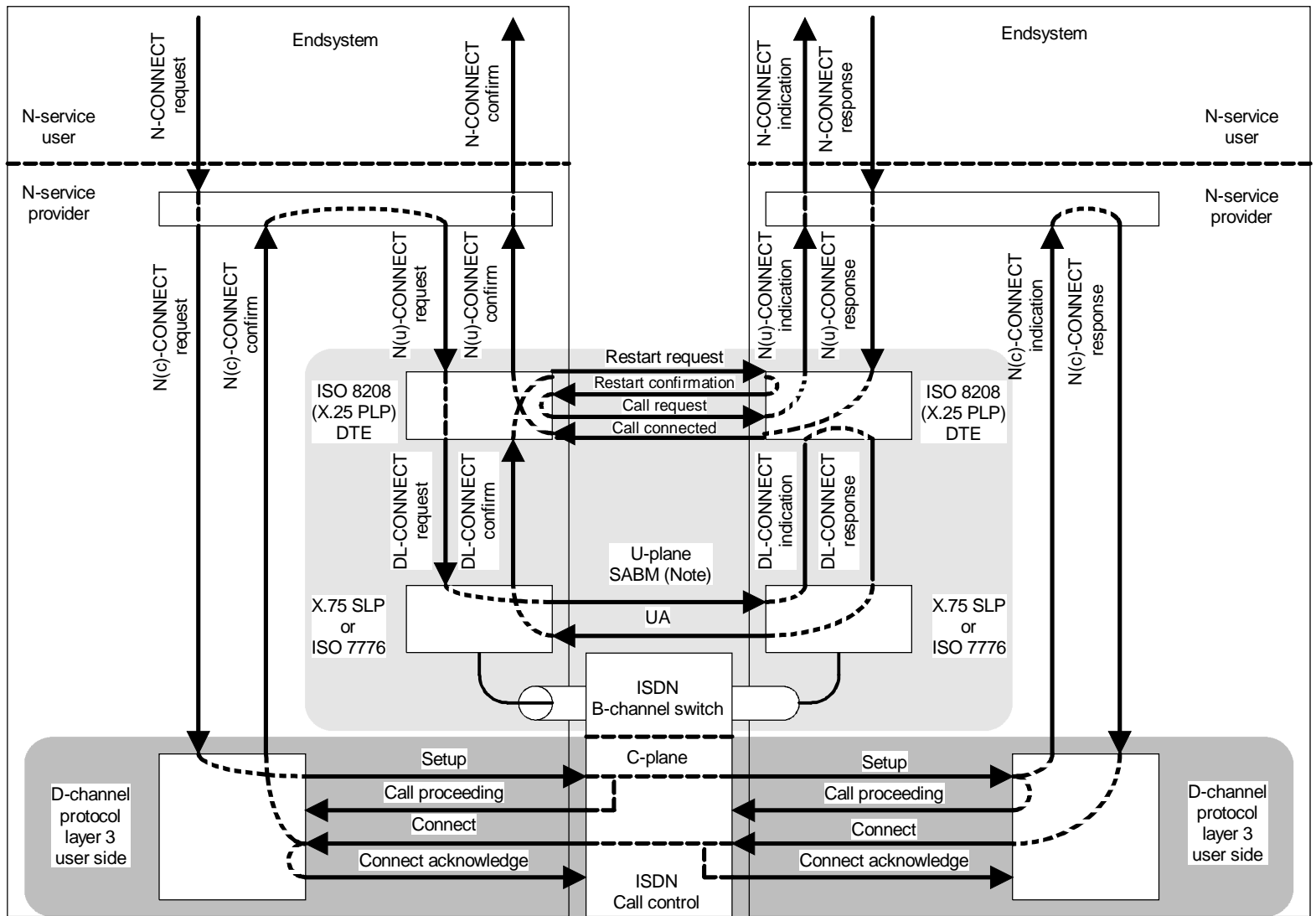

T1812740-91/d06

NOTE – In case of extended mode of operation (module 128 sequence numbering) an SABME is sent instead of SABM.

FIGURE 6/I.333

Terminal selection in support of N-connection establishment for CONS over ISDN transparent channels

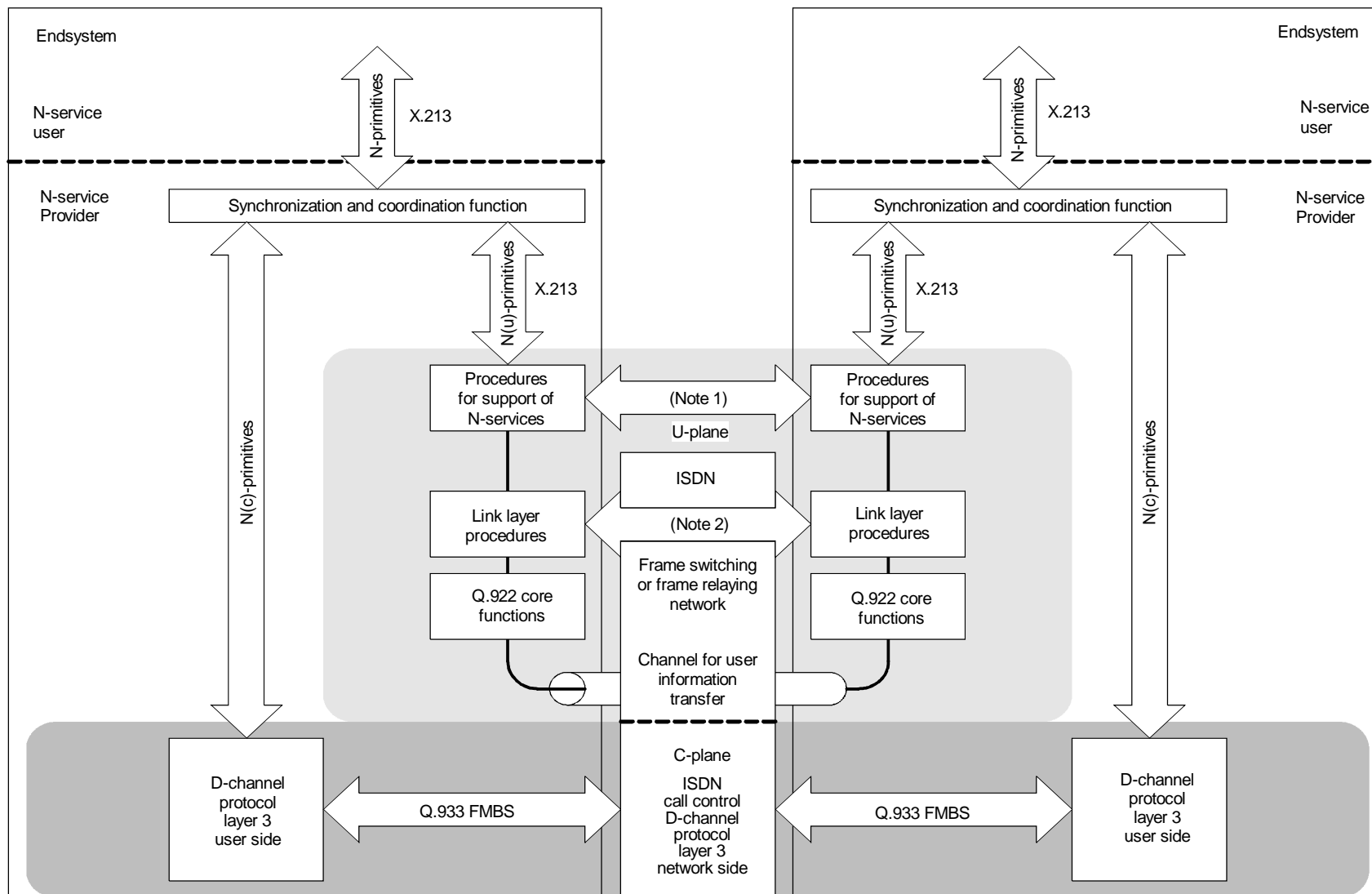

NOTES

- 1 The required functionality to provide a minimum N-service and the peer-to-peer procedures are currently under study.
- 2 In the case of frame switching, the link layer procedures are an application of the Q.922 protocol. In the case of frame relaying, the link layer procedures are "user specified".

T1812750-91/d07

FIGURE 7/I.333
Reference model for CONS based on ISDN FMBS

The link layer procedures have to be Q.922 procedures in the case of frame switching networks and the link layer protocol is terminated within each frame switching node. In the case of frame relaying networks, the link layer procedures are “user specified” i.e. are the responsibility of the endsystems.

The procedures for the support of N-services are transparent to the network.

5.1.3.2 Information elements to support terminal selection in the case of CONS based on ISDN FMBS (Frame Mode Bearer Service)

The following information elements have to be conveyed by the SETUP message at the called side user-network interface:

- a) bearer capability information element (BC);
- b) low layer compatibility information element (LLC);
- c) called party sub-address information element with type of sub-address “NSAP-address”.

5.1.3.3 Terminal selection in support of CONS based on ISDN FMBS

The sequences to establish an N-connection are shown in Figure 8. They are started by the primitive “N-CONNECT request” (top left hand corner of Figure 8) and are completed by the primitive “N-CONNECT confirm”. The terminal selection process is confined to the C-plane, and the N-service user is involved. The SETUP message conveys the NSAP-address in the sub-address information element. Since the endsystem, or a particular application supported by an endsystem, is identified by the NSAP-address, no other number is relevant to the terminal selection and would harm rather than help successful selection. At the called side the functional entity “synchronization and coordination function” checks the NSAP-address against its own and if there is a match, offers the incoming call to the N-service user by means of an N-CONNECT indication primitive. The N-service user requests connection to the incoming call by issuing the N-CONNECT response primitive, or rejects the call by means of the N-DISCONNECT request primitive (not shown in Figure 8). The functional entity “synchronization and coordination function” upon receipt of the N-CONNECT response primitive issues the N(c)-CONNECT response primitive which causes the transmission of the CONNECT message. The network will allocate the call to the single endsystem (identified by the NSAP-address) which requests connection to the incoming call.

Under non-failure conditions, the call accepted by the called N-service user based on C-plane procedures shall not subsequently be rejected within the service provider U-plane (e.g. DM in response to SABM). According to this scenario, the NSAP-address determines the terminal identity while the called party number identifies the whole access to which the endsystem is connected. Thus, no called party number information element is required in the SETUP message offering the incoming call at the called side.

5.1.4 Terminal selection in the case of OSI-CONS based on Packet Mode Bearer Service (PMBS)

5.1.4.1 Reference model for CONS based on PMBS

Reference models for terminal selection in the case of OSI-CONS, which are different for PMBS on a B-channel and for PMBS on a D-channel, are depicted in Figures 9 and 10, respectively.

According to the models, the network service defined in Recommendation X.213 is provided through the functional entity acting on Recommendation X.612. The functional entity performs the coordination between Q.931 protocol used for B-channel establishment and additional signalling (for incoming call notification) and X.25 call control.

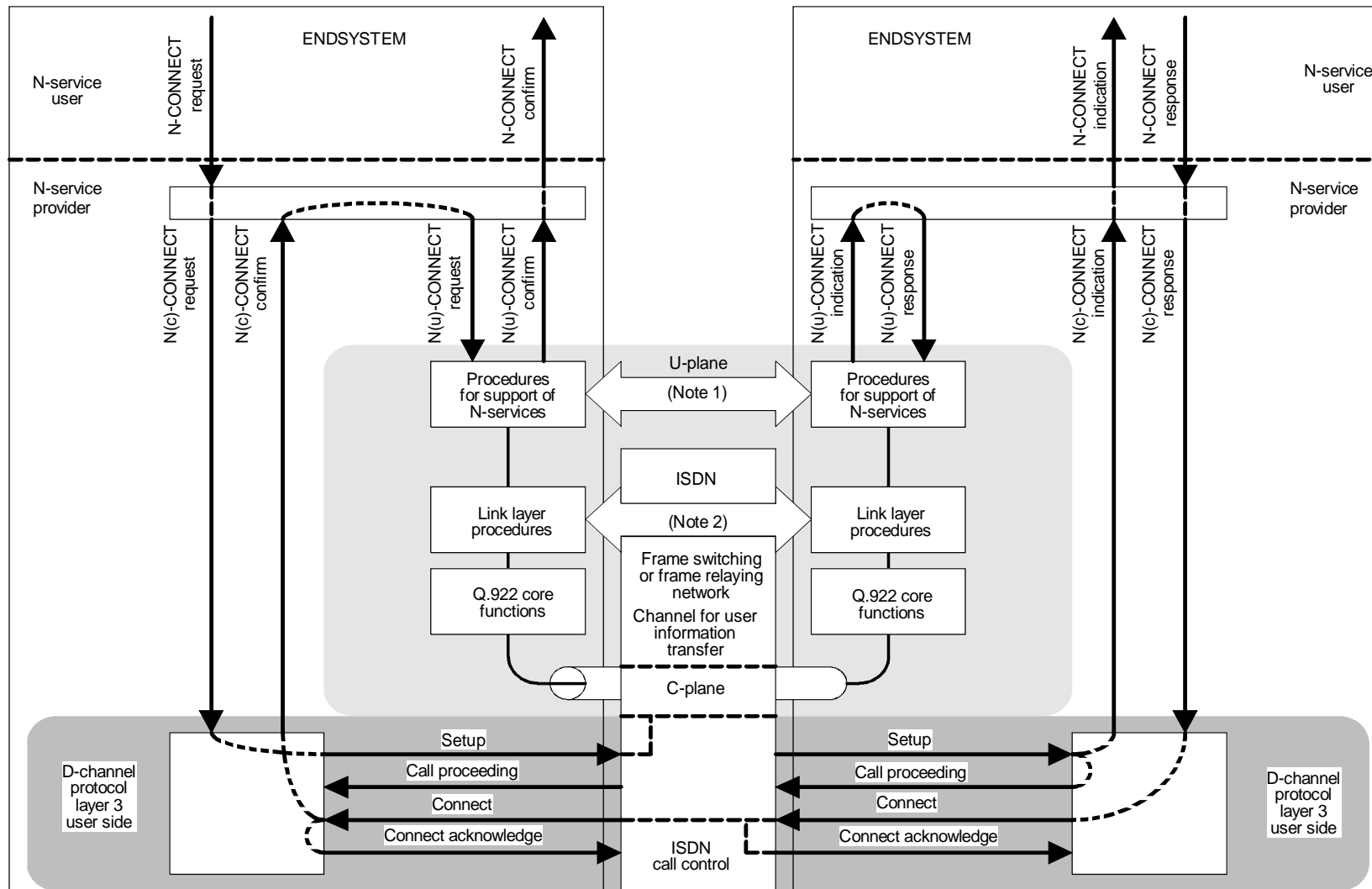

T1812760-91/d08

NOTES

- 1 The required functionality to provide a minimum N-service and the peer-to-peer procedures are currently under study.
- 2 In the case of frame switching, the link layer procedures are an application of the Q.922 protocol. In the case of frame relaying, the link layer procedures are "user specified".

FIGURE 8/I.333
**Terminal selection in support of N-connection establishment
 for CONS based on ISDN FMBS**

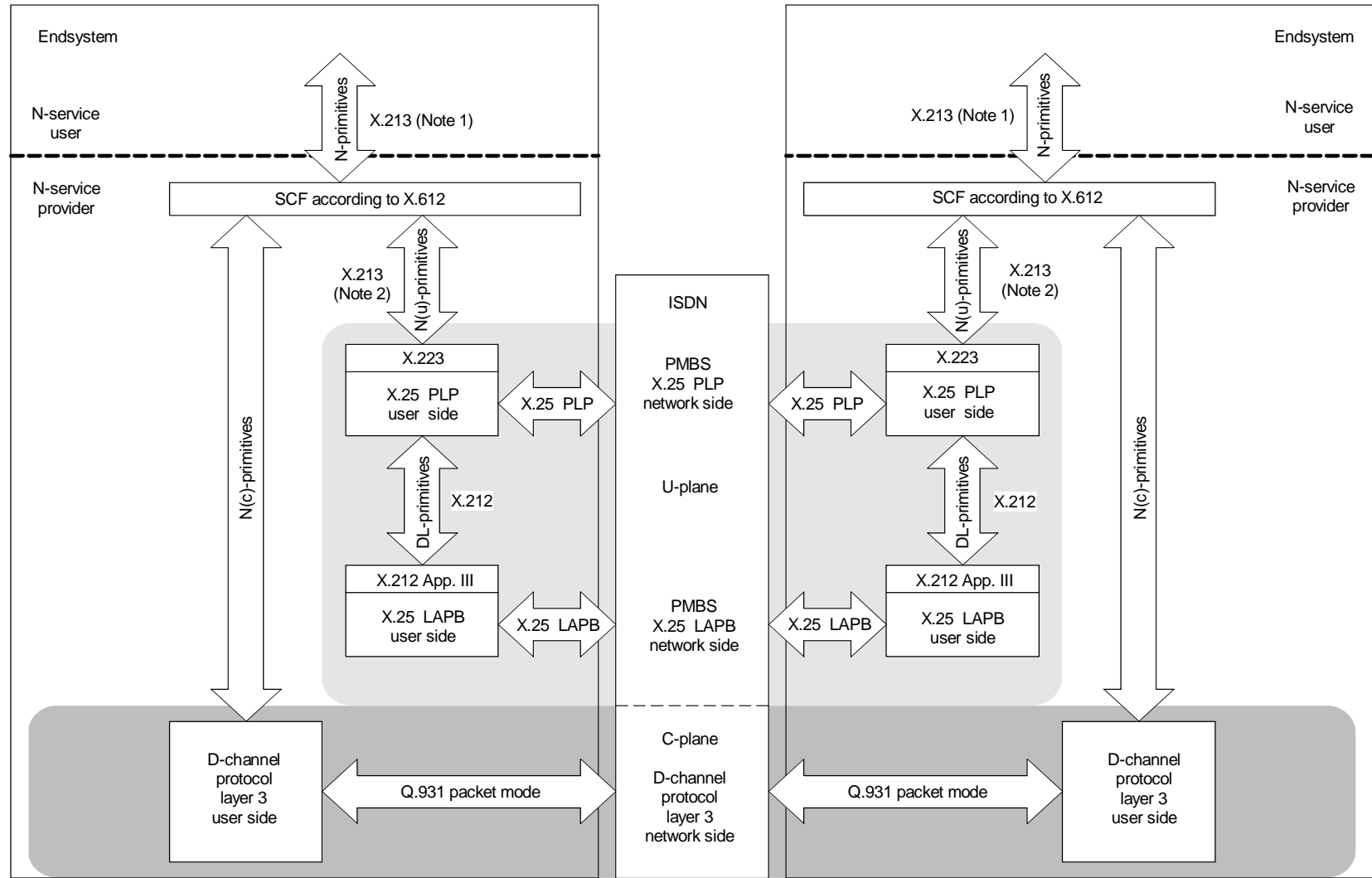

T1815550-92/d09

NOTES

- 1 The service according to X.213 is provided by the layer 3 to layer 4 at the layer 3 - layer 4 boundary. It is a network layer service.
- 2 The service according to X.213 is provided by the U-plane to the synchronization and coordination function. Although it is not a network layer service in a layered architecture using the concept of C- and U-plane, all the capabilities of a network layer service are provided. It is the service of the U-plane sub-network.

FIGURE 9/I.333

Reference model for CONS based on ISDN PMBS over B-channel

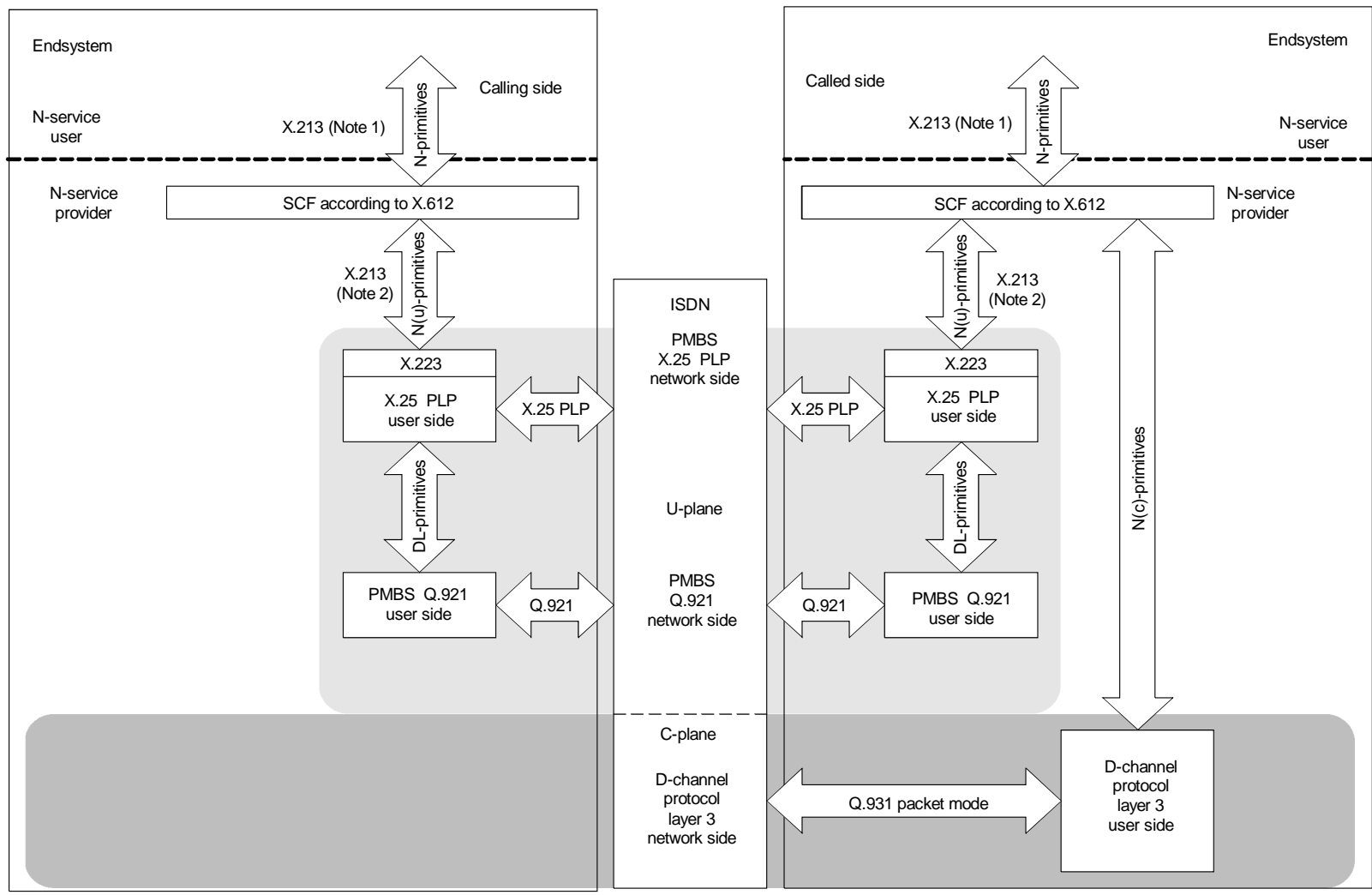

T1815560-92/d10

NOTES

- 1 The service according to X.213 is provided by the layer 3 to layer 4 at the layer 3 - layer 4 boundary. It is a network layer service.
- 2 The service according to X.213 is provided by the U-plane to the synchronization and coordination function. Although it is not a network layer service in a layered architecture using the concept of C- and U-plane, all the capabilities of a network layer service are provided. It is the service of the U-plane sub-network.

FIGURE 10/I.333
Reference model for CONS based on ISDN PMBS over D-channel

5.1.4.2 Information elements to support terminal selection in the case of CONS based on PMBS

The following information elements have to be conveyed by the SETUP message at the called side user-network interface:

- a) bearer capability information element (BC);
- b) low layer compatibility information element (LLC);
- c) called party sub-address information element with type of sub-address "NSAP-address".

5.1.4.3 Terminal selection in support of CONS based on PMBS

The sequences to establish an N-connection, which include differences between PMBS on a B-channel and PMBS on a D-channel, are shown in Figures 11 and 12, respectively. They are started by the primitive "N-CONNECT request" (top left hand corner of Figures 11 and 12) and are completed by the primitive "N-CONNECT confirm".

In the case of PMBS, the terminal selection process is confined to the Q.931 signalling phase; the N-service user is not involved. The network maps the NSAP address contained in the CALL REQUEST packet received from the calling terminal to the SETUP message at the called side. On the called side, the functional entity acting on Recommendation X.612 checks the NSAP address against its own and if there is a match, requests connection to the incoming call. On receipt of the request from the X.612 functional entity, the D-channel protocol layer 3 transmits the CONNECT message. The network will allocate the call to the first endsystem which requests connection to the incoming call. According to this scenario, the NSAP address is involved in the terminal selection process. Note that it could occur that a call accepted by D-channel protocol layer 3 may be rejected later on within either X.25 layer 2 and X.25 call control, or at the level of the N-service user by means of the N-DISCONNECT request in response to an N-CONNECT indication.

5.2 Terminal selection for interworking

5.2.1 General

Whenever a connection is not end-to-end ISDN an interworking function has to be involved to support a call. This interworking function is located at the ISDN interworking point which may be between the ISDN and non-ISDN network (e.g. PSTN or PSPDN), within the ISDN (e.g. in the case of a non-ISDN customer access supported by an ISDN exchange), or at the user's premises (e.g. within a TA function).

With respect to interworking, this Recommendation is confined to the protocol aspects which ensure establishment of calls. Furthermore, calls from the ISDN to a non-ISDN network (e.g. PSTN or PSPDN), a non-ISDN access (Note 1), or a non-ISDN interface (Note 2) have no relationship to terminal selection in the ISDN. The interworking function should include provision that only calls which can be handled by the network equipment beyond the ISDN interworking point are forwarded.

A call originated in a non-ISDN network (e.g. PSTN or PSPDN), or from a non-ISDN access (Note 1), or a non-ISDN interface (Note 2), is typically supported by conventional signalling prior to arrival at the ISDN interworking point. Such a call may belong to one of several indistinguishable call types. At the ISDN interworking point the appropriate compatibility information [bearer capability (BC) information element, low layer compatibility (LLC) information element, high layer compatibility (HLC) information element, as appropriate] will be assigned to achieve compatibility with these call types. The interworking function may be unable to provide all elements exactly specifying the service requested according to the rules for a call within the ISDN. This may imply that compatibility between calling and called terminal is not assured. A progress indicator information element shall be provided by the interworking function to mark a non-ISDN call source.

The presence/absence of a progress indicator information element (call originated within ISDN or outside ISDN) may be used as a criterion for distinct treatment of a call at called user's premises and/or at called users local exchange.

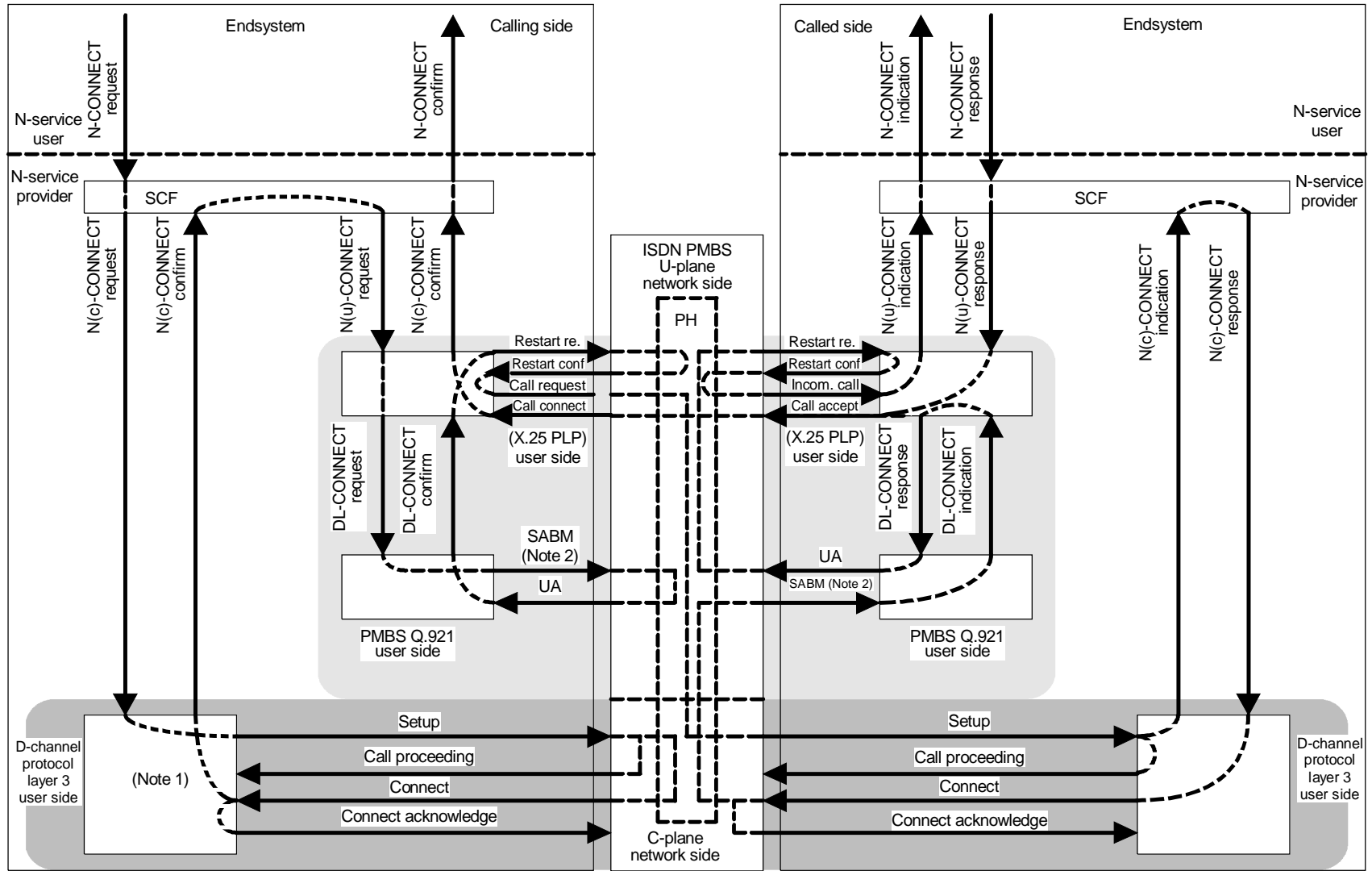

T1815570-92/d11

NOTES

- 1 This procedure applies if no B-channel is already established or if an additional B-channel is needed.
- 2 In case of extended mode of operation (module 128 sequence numbering) an SABME is sent instead of an SABM.

FIGURE 11/I.333

Terminal selection in support of N-connection establishment for CONS based on ISDN PMBS over B-channel

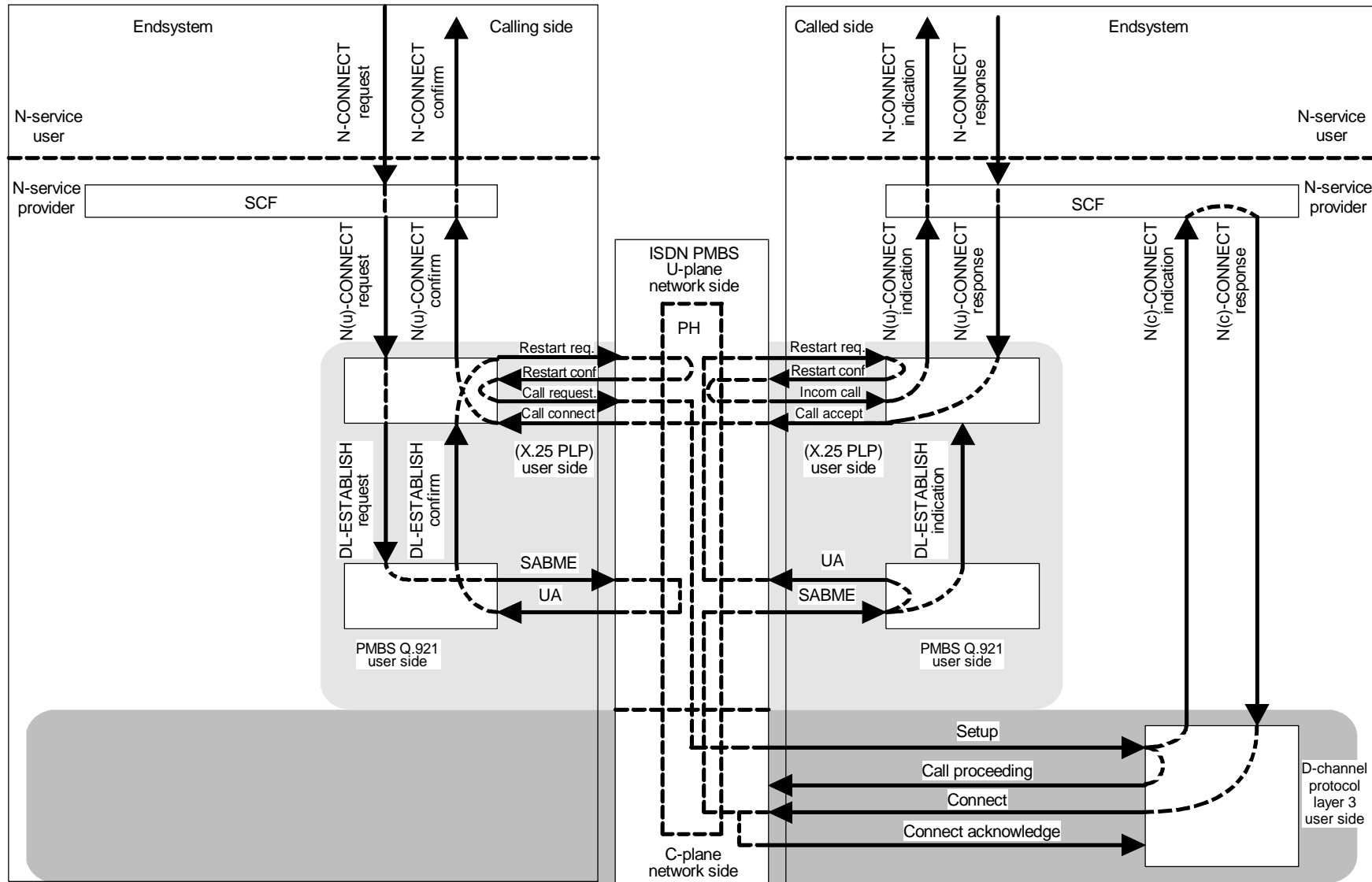

T1815580-92/d12

FIGURE 12/I.333

Terminal selection in support of N-connection establishment for CONS based on ISDN PMBS over D-channel

Owing to interworking some compatibility information contained in BC, LLC and HLC information elements may not be provided according to the expectations at the called side. In this case, the supplementary service “multiple subscriber number” (MSN) may be invoked. This implies that a calling subscriber connected to a non-ISDN network (e.g. PSTN) or using a non-ISDN user network interface should have the capability to define a terminal identity (i.e. a number which can be conveyed in the called party number information element) when establishing a call.

NOTES

1 In some Administrations, non-ISDN access on an exchange that supports ISDN access is considered part of another network e.g. PSTN.

2 A non-ISDN interface refers to access to non-ISDN terminals behind an ISDN interface (e.g. analogue telephone connected to a PABX which itself is connected to an ISDN access).

5.2.2 Calls from PSTN to ISDN – PSTN supporting a service corresponding to “3.1 kHz audio”

A call originated in the PSTN, supported by conventional signalling prior to arrival at the ISDN interworking point, will belong to one of two indistinguishable call types, i.e. telephony or voice-band data. At the interworking point the bearer capability “3.1 kHz audio” will be assigned to achieve compatibility with these call types.

This interworking case requires that telephone terminals accept incoming calls offered with the bearer capability information element “3.1 kHz audio” when accompanied with call progress information element indicating the interworking case. For calls within the ISDN the correct bearer capability information element is “speech”. A call originated in the PSTN may cause mutual compatibility problems between terminals at called subscriber premises (see 3.2.7) in customer installations if they contain data terminals using the bearer capability information element “3.1 kHz audio” within the ISDN as well as in the case of interworking. The supplementary service “multiple subscriber number” (MSN) may be the only solution to achieve mutual compatibility between terminals at called subscriber premises (see 3.2.7) when using the 3.1 kHz audio service.

5.2.3 Calls from PSPDN to ISDN

The configurations to interwork with a PSPDN and the procedures to offer calls from a PSPDN to terminals connected to an ISDN access are defined in Recommendations X.300 and X.31.

Depending on the configuration used i.e. X.31 case A or case B, a call originated in the PSPDN is seen by the ISDN as either a circuit or a packet call.

In the configuration identified as case A, according to Recommendation X.31, the interconnection with the PSPDN is performed by means of an access unit. The access unit offers a circuit switched call similar to a calling terminal containing a BC information element indicating unrestricted digital information. As seen by the ISDN, terminal selection is completed when the B-channel is connected. The called subscriber has to configure the terminals in such a way that the packet terminal would not interfere with other terminals, if any, using the circuit mode unrestricted digital information transfer. The supplementary service “multiple subscriber number” (MSN) may be the only solution to achieve mutual compatibility between terminals at called subscriber premises (see 3.2.7) when using the circuit mode unrestricted digital information transfer.

In the configuration identified as case B, according to Recommendation X.31, the interconnection with the PSPDN is performed by means of a packet handler. The packet handler offers a packet switched call with a BC information element indicating packet mode and the specific protocols to be used for packet communication at layers 2 and 3 of the B- or D-channel, respectively. This approach allows a unique description of a call up to layer 3 and does not cause compatibility problems such as described for case A.

5.2.4 Calls from CSPDN to ISDN

A call originated in the CSPDN will be offered to an ISDN terminal configuration indicating a circuit bearer capability and bit rate adaptation method used. If the CSPDN is used to offer a teleservice, the ISDN interworking point may not be able to provide this information. Therefore, a distinction between a circuit mode data call and a call associated with a teleservice may not be possible. The supplementary service “multiple subscriber number” (MSN) may be the only solution to achieve mutual compatibility between terminals at called subscriber premises (see 3.2.7) when supporting different services.

5.2.5 Calls from networks referred to as digital PSTNS, pre-ISDNs, pilot ISDNs or extended IDNs to ISDNs

Calls providing a 64 kbit/s transfer rate transparently from one of the above mentioned networks to an ISDN terminal configuration are not yet fully defined. The 64 kbit/s unrestricted bearer service will be used, but in any case there is an interworking taking place. A progress indicator information element is present, to indicate the non-ISDN call source. Specific high or low layer functionality information cannot, however, be guaranteed.

Some customers of these networks, however, will be served from exchanges with ISDN capability and calls will be supported by common channel signalling for the entire connection. This affords some added opportunities to make distinctions. The extent to which this should be recommended is for further study.

5.3 Terminal functionality for general purpose terminals

To reach full and correct terminal selection in the end-to-end ISDN environment, it is recommended that both, calling and called user's terminals make appropriate use of BC, LLC and HLC information elements in call set-up procedures. If not, correct terminal selection cannot be guaranteed in all cases. The use of addressing mechanisms may avoid this problem (e.g. MSN). However, it is recognized that some CCITT Recommendations do leave the freedom to the user to use or not use LLC and HLC information elements for compatibility checking purposes. In this subclause, it is assumed the use of the above recommended situation.

The requirements given in this subclause are not mandatory for all terminals and in all terminal configurations. They are guidelines to provide for terminal selection among general purpose terminals. A terminal not meeting these minimum requirements may cause an irregularity in the call handling in certain customer equipment arrangements.

NOTE – I.1.1 illustrates how “limited functionality speech terminals” can be used in certain configurations.

Terminals which support the full ISDN terminal selection functionality without constraining terminal portability and possible arrangements at customer premises shall meet the following requirements:

5.3.1 When initiating a call, the terminal has to specify the requested service and to provide the appropriate functionality (low layer functionality and high layer functionality, as appropriate).

If a bearer service is invoked, the bearer capability (BC) information element shall identify the requested service and, according to the rules for a particular call type, the low layer compatibility (LLC) information element or the bearer capability information element shall identify the low layer functionality.

If a teleservice (according to Recommendation I.212) is invoked, the bearer capability information element in combination with the high layer compatibility (HLC) information element shall identify the requested service and, according to the rules for a particular call type, the low layer compatibility information element or the bearer capability information element shall identify the low layer functionality. In addition, the HLC information element identifies the required high layer functionality.

5.3.2 A terminal shall be able to detect the presence/absence of a progress indicator information element in the incoming SETUP message and use this capability as a criterion for distinct treatment of calls originated within the ISDN or in a non-ISDN environment. A terminal receiving a call containing a progress indicator information element shall modify its compatibility checking in accordance with the description of the service contained in the relevant interworking Recommendation. This modification may also include the capability to use terminal identities dedicated to interworking cases. This means that the compatibility check is successful if the included information, which as a minimum, will be the bearer service information element having its obligatory contents reflecting the characteristics of the non-ISDN.

5.3.3 When receiving a call, the terminal supporting a bearer service shall be able to detect the presence/absence of the HLC information element in the SETUP message. The call shall proceed if the HLC information element is absent, otherwise the terminal shall either ignore or reject the offered call (Note 1), unless the BC and/(or) LLC information elements are sufficient for the treatment of the call. The latter may, as an example, apply to terminals implementing the “speech bearer service” which may proceed even if the HLC information element is present, in order to interwork with the “telephony teleservice”.

5.3.4 When receiving a call, the terminal shall be able to check the bearer capability information element.

In case of a terminal supporting a bearer service, this check verifies if it is able to support the bearer service.

In case of a terminal supporting a teleservice, this check verifies if it is able to support the bearer capability.

If the terminal profile matches the bearer capability the call shall proceed, otherwise the terminal shall either ignore or reject the offered call (Note 1).

5.3.5 When receiving a call, the terminal shall be able to check if the low layer compatibility information element, or if not present, the bearer capability information element, indicates a low layer functionality, which it is able to support. In case of a successful check the call shall proceed. If a mismatch with its own capabilities is detected, the terminal shall either ignore or reject the offered call (Note 1). Any conflicting duplication of information contained in the bearer capability information element and the low layer information element shall be resolved by ignoring the conflicting information contained in the low layer information element. If the bearer capability information element provides the complete definition of the low layer functionality in accordance with the specification of the specific service, the LLC may be of no significance and may be ignored.

5.3.6 When receiving a call, the terminal supporting a teleservice shall be able to check (in addition to the BC and possibly LLC information element) if the high layer compatibility information element, if present, indicates a high layer functionality, which it is able to support. In case of a successful check the call shall proceed. If the terminal detects a mismatch of its capabilities, or if the HLC information element is absent without a progress indicator information element, the terminal shall either ignore or reject the offered call (Note 1), unless the BC and/(or) LLC information elements are sufficient for the treatment of the call. The latter may, as an example, apply to terminals implementing the “telephony teleservice” which may proceed even if the HLC information element is absent, in order to interwork with the “speech bearer service”.

5.3.7 When receiving a call, the terminal shall be able to detect the presence/absence of the called party number field in the SETUP message. It shall proceed normally with the call if this field is absent i.e. treat an absent called party number field in the SETUP message like a present field which matches its own terminal identity.

A terminal not supporting (Note 2) the supplementary service “multiple subscriber number” shall ignore the call if the called party number field is present.

5.3.8 When receiving a call offered with addressing information, the terminal supporting the supplementary service “multiple subscriber number” shall be able to check the information contained in the called party number field of the SETUP message against its own identity (or identities, as appropriate). The terminal shall have the capability to recognize as many identities as different member groups it has to accommodate. In case of mismatch, the call shall be ignored, otherwise the terminal shall proceed with the call handling.

The digits contained in the called party number field may consist of the whole subscriber number or a part of it, but the entire subscriber number represents the maximum.

NOTE 1 – These actions are user options which are supported by the network. If another terminal is compatible to the offered call and indicates this to the network within a time equivalent to timer T303 (4s), then this indication overrides the reject.

5.4 Terminal functionality for compatibility with the “sub-addressing” supplementary service

The requirements given in this subclause are not mandatory for all terminals and in all terminal configurations. They are guidelines to provide for terminal selection among general purpose terminals. A terminal not meeting these minimum requirements may cause an irregularity in the call handling in certain customer equipment arrangements.

Terminals which are compatible with other terminals in the same access which support the “sub-addressing” supplementary service either:

- shall support this service, and thus must have their own identities (sub-addresses) assigned, or
- if not supporting this service, shall ignore an incoming call, when a sub-address is present.

These terminals may also support the full ISDN terminal selection functionality without constraining terminal portability and possible arrangements at customer premises, in accordance with 5.3. They have to meet the following requirements.

5.4.1 When receiving a call, the terminal should be able to detect the presence/absence of the sub-address field in the SETUP message. It shall proceed normally with the call if this field is absent i.e. treat an absent sub-address field in the SETUP message like a present field which matches its own terminal identity.

A terminal not supporting (Note 2) the “sub-addressing” supplementary service should ignore the call if the sub-address field is present.

5.4.2 When receiving a call offered with sub-addressing information, the terminal supporting the “sub-addressing” supplementary service shall be able to check the information contained in the sub-address field of the SETUP message against its own identity (or identities, as appropriate). The terminal shall have the capability to recognize as many identities as different member groups it has to accommodate. In the case of mismatch, the call shall be ignored, otherwise the terminal shall proceed with the call handling.

NOTE 2 – The term “not supporting” indicates that the terminal does not have the capability to examine the contents of the called party number information element. Such a terminal can still be compatible with other terminals supporting the “multiple subscriber number” or “sub-addressing” supplementary service, as appropriate, in the sense that it does not answer calls addressed to other terminals. This compatibility ensures that the proper use of the “multiple subscriber number” or “sub-addressing” supplementary service, as appropriate, is possible.

Appendix I

Examples of terminal selection in illustrative configurations

(This appendix does not form an integral part of this Recommendation)

I.1 Limited functionality speech terminal

I.1.1 Configuration

An example of a simple terminal configuration is illustrated in Figure I.1. The multiple terminal configuration example consists of up to eight voice terminals without terminal selection logic.

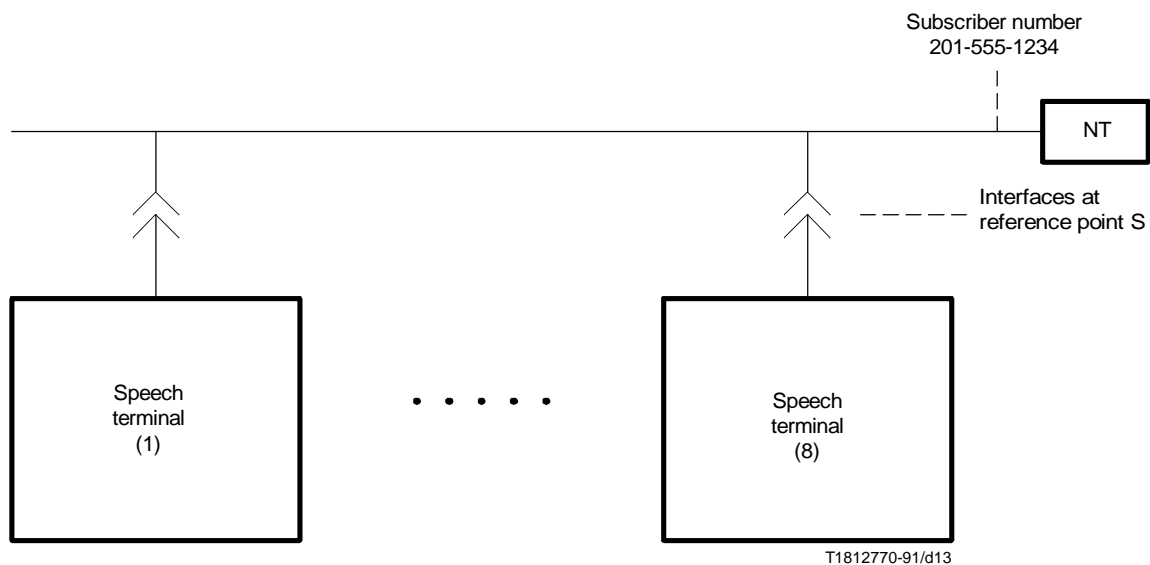

FIGURE I.1/I.333
Limited functionality speech terminals

I.1.2 Terminals and network capabilities

Calls are delivered to the interface on the basis of an ISDN subscriber number (ISDN-SN). The terminals respond to the call offered on the basis of presumed eligibility to complete the call.

I.1.3 Offered call treatment

A terminal will respond to a SETUP message regardless of other terminal selection information (e.g. LLC) present in the SETUP message. More than one terminal may answer the offered call, but the network allocates the call to the first terminal from which it receives an answer (connect) indication.

I.1.4 Application

This type of terminal is appropriate for subscribers who wish only to receive speech calls and who are not concerned with which terminal answers the call. Moreover, it should be noted that compatibility is not ensured. The use of this type of terminal on a point-to-multipoint configuration with terminals designed for anything other than speech calls will result in the mishandling of some calls.

I.2 Multiple different terminals on a passive bus

I.2.1 Configuration

This example considers a speech terminal, a terminal adaptor for analogue interface, and a terminal adaptor for digital interface connected on a passive bus. The interface has been assigned three numbers that can be used (by non-ISDN customers) to indicate the terminal they wish to access. The arrangement is shown in Figure I.2.

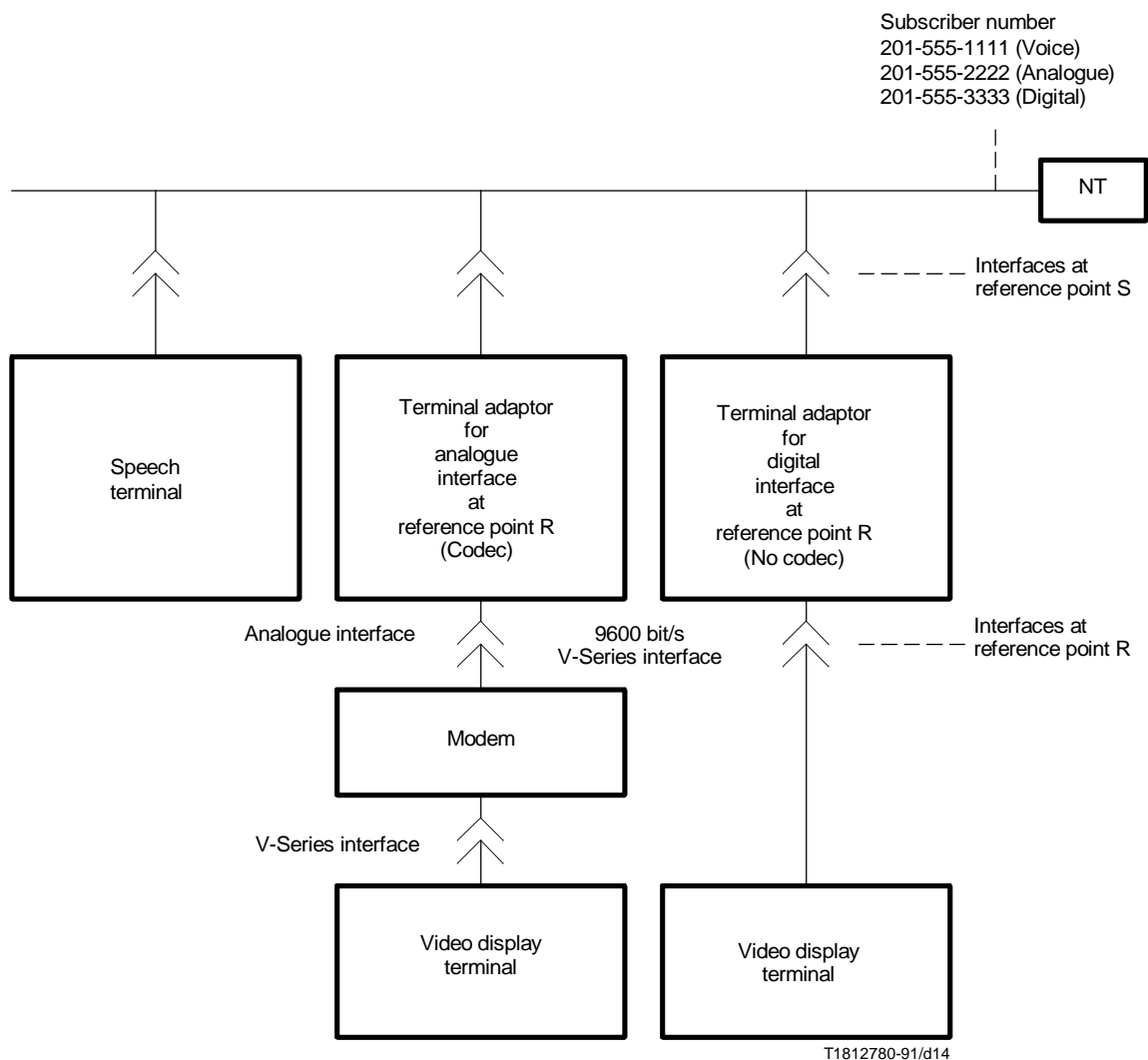

FIGURE I.2/I.333

Multiple different terminals on a passive bus

I.2.2 Terminals and network capabilities

In this example, the terminals are connected to an interface that has been assigned three numbers. Any of the three numbers may be used from another ISDN for any service supported by the subscribers terminals. For callers from networks that cannot indicate directly the service required (PSTNs, CSPDNs, and PSPDNs), the first number “201-555-1111” is intended for speech services. The second number, “201-555-2222” is intended for modem data services. The third number, “201-555-3333” is intended for access to the terminal adaptor for digital interface.

Terminal selection based on the ISDN subscriber number, bearer capability, and progress indicators is used to identify one (or none) of the three terminals that is appropriate to respond to an offered call.

I.2.3 Offered call treatment

I.2.3.1 Speech terminal

Figure I.3

Offered call bearer capability – “Speech”:

The terminal responds to the call.

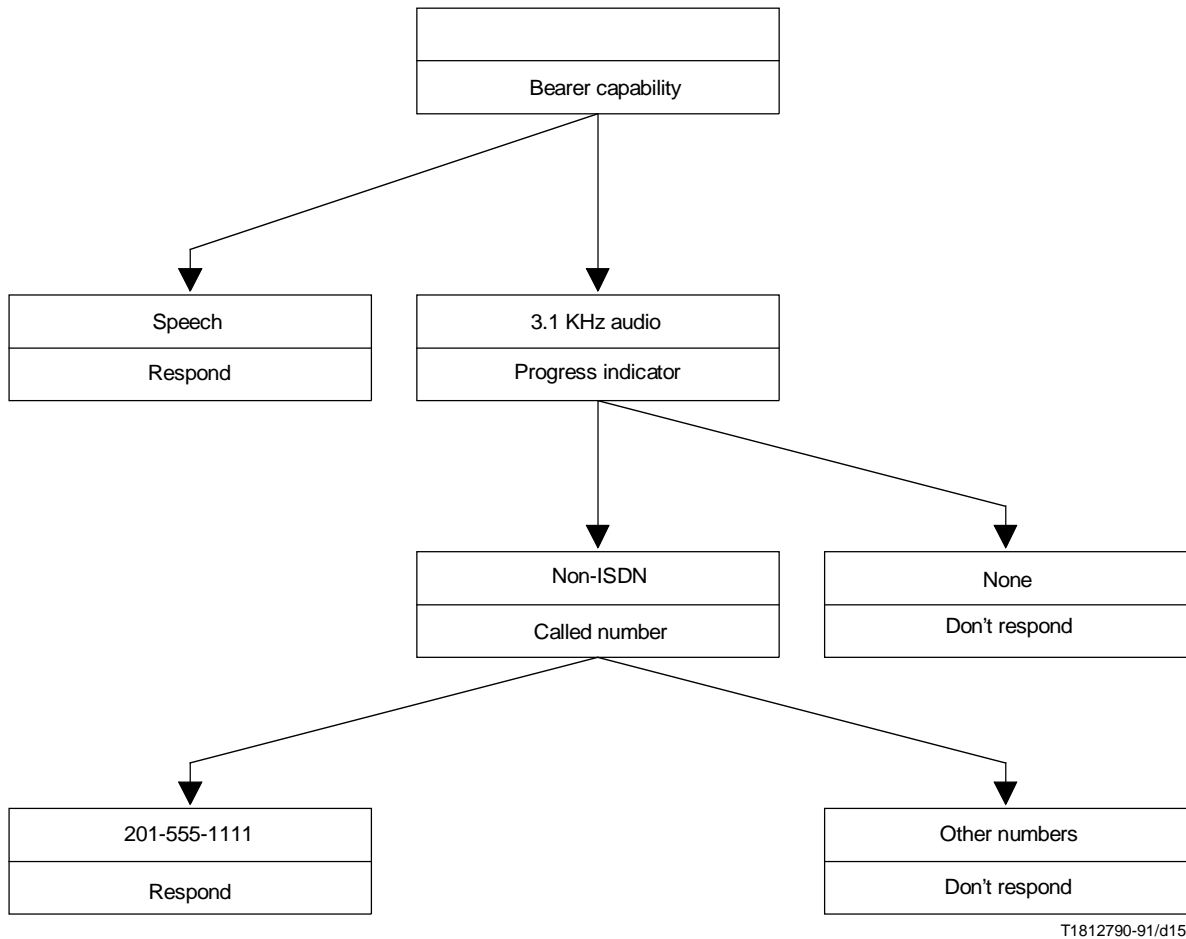

FIGURE I.3/I.333
Logic for speech terminal

Offered call bearer capability – “3.1 kHz audio”:

- 1) Progress indicator – non-ISDN:

Called number – 201-555-1111:

The terminal responds to the call.

Other called numbers:

The terminal does not respond.

- 2) No progress indicator – (ISDN origination and transit):

The terminal assumes that the call is a data call and does not respond.

Offered call with other bearer capabilities:

The terminal does not respond.

I.2.3.2 TA for analogue interface/video display terminal

The terminal adaptor contains a codec that produces an analogue signal that is connected to a modem; the modem has a V-Series interface to the video display terminal (VDT). The logic is shown in Figure I.4.

Offered call bearer capability – “3.1 kHz audio”:

- 1) Progress indicator – non-ISDN:

Called Number – 201-555-2222:

The terminal adaptor assumes that the call is a data call and responds. The call is connected to the video display terminal through a modem.

Other called number:

Terminal does not respond.

- 2) No progress indicator – (ISDN origination and transit):

The terminal adaptor responds. It assumes that, since the call originated at an ISDN terminal, the call is a data call regardless of the called number.

Offered call with other bearer capabilities:

The terminal adaptor does not respond.

I.2.3.3 TA for digital interface/video display terminal

The terminal adaptor adapts the V-Series interface to the interface at reference point S of ISDN.

The adaptation includes rate adapting the 9600 bit/s rate of the display terminal to the 64 kbit/s rate of a B-channel. The logic for the digital terminal adaptor is shown in Figure I.5.

For non-ISDN calls, it is assumed that the call is routed through an interworking function that establishes a bearer capability of 64 kbit/s for the call.

Offered call bearer capability – “64 kbit/s unrestricted”:

- 1) Progress indicator – non-ISDN:

Called number – 201-555-3333:

The switch routes the connection through an interworking function (e.g. a modem). The TA for digital interface/display terminal answers the call.

Other called numbers:

The terminal does not respond.

- 2) No Progress indicator – (ISDN origination and transit):

The terminal adaptor responds. It assumes that, since the call originated at an ISDN terminal, the call is a data call regardless of the called number.

I.2.4 Application

This example of multiple different terminals on a passive bus illustrates the terminal selection logic that allows the appropriate terminal, from among a speech terminal, a terminal adaptor for analogue interface, and a terminal adaptor for digital interface, to respond to an incoming call. Calls from a non-ISDN network are selected on the basis of the called ISDN number; calls from an ISDN subscriber are selected on the basis of the bearer capability. The addition to the interface of other terminals with different functionality but using the same bearer capability would result in incorrect terminal selection.

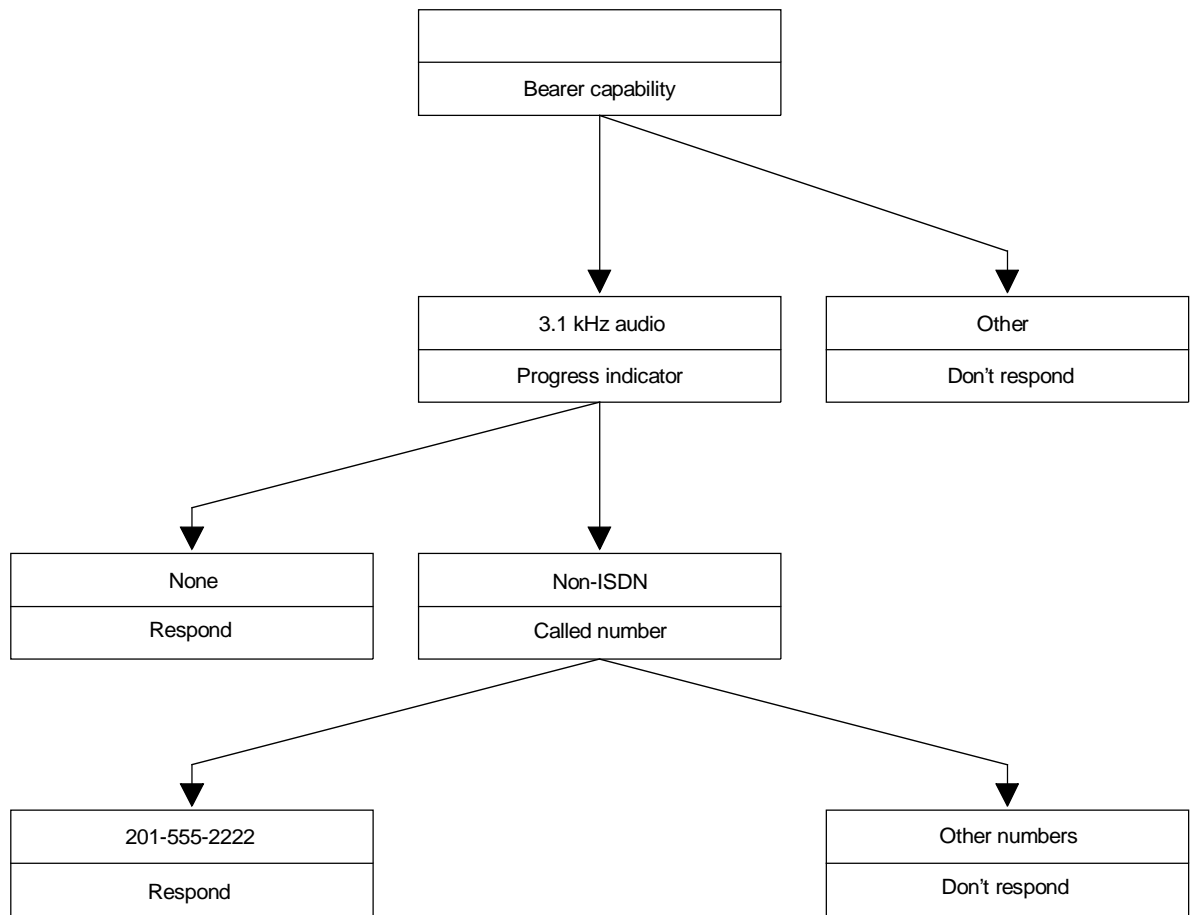

T1812800-91/d16

FIGURE I.4/I.333
 Logic for the terminal adaptor for analogue interface

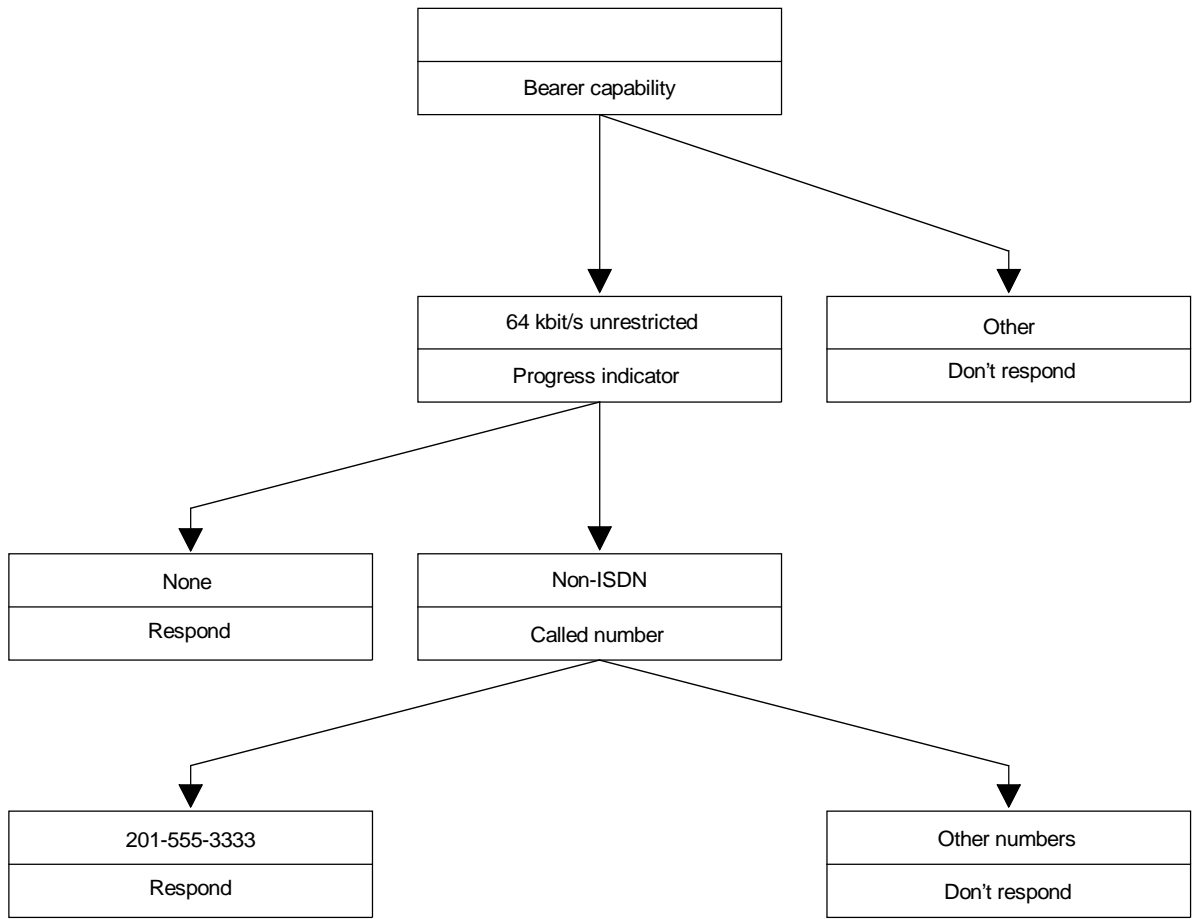

T1812810-91/d17

FIGURE I.5/I.333
Logic for the terminal adaptor for digital interface

I.2.5 Abbreviations and acronyms used in this Recommendation

For the purpose of this Recommendation the following abbreviations are used:

BC	Bearer capability
CONS	Connection-mode network service
CSPDN	Circuit switched public data network
DDI	Direct dialling in
DL-primitive	Communication between Layer 3 and data link layer
DM	Disconnected mode
DTE	Data terminating equipment
EID	Endpoint identifier
FMBS	Frame mode bearer service
HLC	High layer compatibility
ISDN	Integral services digital network
IWF	Interworking function
LAPB	Link access procedure – balanced
LAPD	Link access procedure on the D-channel
LLC	Low layer compatibility
MSN	Multiple subscriber number
N-	Network layer
N-primitive	Communication between transport layer and network layer
NT2	Network termination 2
NSAP	Network service access point
OSI	Open system interconnection
PLP	Packet layer protocol
PMBS	Packet mode bearer service
PSPDN	Packet switched public data network
PSTN	Public switched telephone network
SABM	Set asynchronous balanced mode
SABME	Set asynchronous balanced mode extended
SCF	Synchronization and coordination function
SLP	Single link procedure
TA	Terminal adaptor
TE	Terminal equipment
TEI	Terminal endpoint identifier
UA	Unnumbered acknowledgement