



INTERNATIONAL TELECOMMUNICATION UNION

**ITU-T**

TELECOMMUNICATION  
STANDARDIZATION SECTOR  
OF ITU

**H.450.5**

(05/99)

SERIES H: AUDIOVISUAL AND MULTIMEDIA SYSTEMS  
Supplementary services for multimedia

---

**Call park and call pickup supplementary  
services for H.323**

ITU-T Recommendation H.450.5

(Previously CCITT Recommendation)

---

ITU-T H-SERIES RECOMMENDATIONS  
**AUDIOVISUAL AND MULTIMEDIA SYSTEMS**

Characteristics of transmission channels used for other than telephone purposes	H.10–H.19
Use of telephone-type circuits for voice-frequency telegraphy	H.20–H.29
Telephone circuits or cables used for various types of telegraph transmission or simultaneous transmission	H.30–H.39
Telephone-type circuits used for facsimile telegraphy	H.40–H.49
Characteristics of data signals	H.50–H.99
CHARACTERISTICS OF VISUAL TELEPHONE SYSTEMS	H.100–H.199
INFRASTRUCTURE OF AUDIOVISUAL SERVICES	
General	H.200–H.219
Transmission multiplexing and synchronization	H.220–H.229
Systems aspects	H.230–H.239
Communication procedures	H.240–H.259
Coding of moving video	H.260–H.279
Related systems aspects	H.280–H.299
Systems and terminal equipment for audiovisual services	H.300–H.399
<b>Supplementary services for multimedia</b>	<b>H.450–H.499</b>

*For further details, please refer to ITU-T List of Recommendations.*

## **ITU-T RECOMMENDATION H.450.5**

### **CALL PARK AND CALL PICKUP SUPPLEMENTARY SERVICES FOR H.323**

#### **Summary**

This Recommendation describes the procedures and the signalling protocol scenarios for the Call Park and Call Pickup supplementary services in H.323.

Call Park (SS-PARK) is a supplementary service that enables the Parking User A to place an existing call with user B (Parked User) to a Parking Position. The call can later be picked-up by retrieving the parked party from the same terminal where the park took place or from another terminal.

Call Pickup (SS-PICKUP) is a supplementary service that enables the Picking-up User to either pick up a parked call or to pick up an alerting call. Upon successful invocation of SS-PICKUP, the Picking-up User is connected with the Parked User respectively with the calling User.

This Recommendation makes use of the "Generic functional protocol for the support of supplementary services in H.323" as defined in Recommendation H.450.1.

#### **Source**

ITU-T Recommendation H.450.5 was prepared by ITU-T Study Group 16 (1997-2000) and was approved under the WTSC Resolution No. 1 procedure on 27 May 1999.

## FOREWORD

ITU (International Telecommunication Union) is the United Nations Specialized Agency in the field of telecommunications. The ITU Telecommunication Standardization Sector (ITU-T) is a permanent organ of the ITU. The ITU-T is responsible for studying technical, operating and tariff questions and issuing Recommendations on them with a view to standardizing telecommunications on a worldwide basis.

The World Telecommunication Standardization Conference (WTSC), which meets every four years, establishes the topics for study by the ITU-T Study Groups which, in their turn, produce Recommendations on these topics.

The approval of Recommendations by the Members of the ITU-T is covered by the procedure laid down in WTSC Resolution No. 1.

In some areas of information technology which fall within ITU-T's purview, the necessary standards are prepared on a collaborative basis with ISO and IEC.

## NOTE

In this Recommendation the term *recognized operating agency (ROA)* includes any individual, company, corporation or governmental organization that operates a public correspondence service. The terms *Administration*, *ROA* and *public correspondence* are defined in the *Constitution of the ITU (Geneva, 1992)*.

## INTELLECTUAL PROPERTY RIGHTS

The ITU draws attention to the possibility that the practice or implementation of this Recommendation may involve the use of a claimed Intellectual Property Right. The ITU takes no position concerning the evidence, validity or applicability of claimed Intellectual Property Rights, whether asserted by ITU members or others outside of the Recommendation development process.

As of the date of approval of this Recommendation, the ITU had received notice of intellectual property, protected by patents, which may be required to implement this Recommendation. However, implementors are cautioned that this may not represent the latest information and are therefore strongly urged to consult the TSB patent database.

© ITU 2000

All rights reserved. No part of this publication may be reproduced or utilized in any form or by any means, electronic or mechanical, including photocopying and microfilm, without permission in writing from the ITU.

## CONTENTS

	<b>Page</b>
1	Scope ..... 1
2	References ..... 1
3	Terms and definitions ..... 1
4	Abbreviations and acronyms ..... 3
5	Description ..... 3
5.1	Call Park ..... 3
5.2	Call Pickup ..... 4
6	Messages and information elements ..... 5
7	Procedures ..... 5
7.1	Actions at the Parking Endpoint A ..... 5
7.2	Actions at the Parked Endpoint B ..... 6
7.3	Actions at the Parked-To Endpoint ..... 7
7.4	Actions at the Calling endpoint (SS-PICKUP of an alerting call) ..... 9
7.5	Actions at the Alerting endpoint (SS-PICKUP of an alerting call) ..... 9
7.6	Actions at the Served endpoint ..... 10
7.7	Actions at a Pickup Group member endpoint ..... 11
7.8	Actions at the Picking-up Endpoint ..... 12
7.9	Alternative procedures ..... 13
7.9.1	Local SS-PARK and pickup from local park ..... 13
8	Interworking ..... 13
8.1	Interworking with SCN ..... 13
8.2	Interworking with other supplementary services ..... 14
8.2.1	Call Diversion (H.450.3) ..... 14
8.2.2	Call Hold (H.450.4) ..... 14
8.2.3	Call Waiting (H.450.6) ..... 14
8.2.4	H.323 Conference ..... 14
8.2.5	Call Transfer (H.450.2) ..... 14
8.3	Interaction with H.225.0 parameters ..... 14
9	Gatekeeper actions ..... 15
9.1	Normal procedures ..... 15
9.2	Alternative GK procedures for SS-PICKUP of an Alerting call ..... 15
9.2.1	Alerting endpoint does not support SS-PICKUP ..... 15
9.2.2	Calling endpoint and Alerting endpoint do not support SS-PICKUP ..... 15
9.2.3	Group pickup of an alerting call at the gatekeeper ..... 16

	<b>Page</b>
9.3	Alternative GK procedures for SS-PARK and SS-PICKUP of a parked call ..... 16
10	Dynamic description..... 17
10.1	Operational model and signal flows..... 17
	10.1.1 SS-PARK ..... 17
	10.1.2 SS-PICKUP of a parked call, unpark..... 18
	10.1.3 SS-PICKUP of an alerting call..... 19
10.2	Communication between a Signalling entity and its Signalling entity user (Primitives and Parameters) ..... 21
	10.2.1 Parking endpoint ..... 21
	10.2.2 Parked endpoint ..... 23
	10.2.3 Parked-To endpoint..... 25
	10.2.4 Picking-up endpoint ..... 26
	10.2.5 Calling endpoint..... 26
	10.2.6 Alerting endpoint ..... 27
	10.2.7 Served endpoint ..... 27
	10.2.8 Group Member endpoint..... 28
10.3	Call States..... 29
	10.3.1 Parking Endpoint A..... 29
	10.3.2 Parked Endpoint B ..... 29
	10.3.3 Parked-To Endpoint (Parking Position)..... 29
	10.3.4 Calling endpoint..... 30
	10.3.5 Alerting endpoint ..... 30
	10.3.6 Served endpoint ..... 30
	10.3.7 Group member endpoint ..... 30
	10.3.8 Picking-up Endpoint ..... 30
10.4	Timers ..... 30
11	Operation in Support of SS-PARK and SS-PICKUP..... 31
12	Specification and Description Language (SDL) Diagrams ..... 35
12.1	SS-PARK SDLs ..... 36
12.2	SS-PICKUP SDLs..... 40
12.3	SS-PARK, SS-PICKUP Group notifications SDLs ..... 48

## Recommendation H.450.5

### CALL PARK AND CALL PICKUP SUPPLEMENTARY SERVICES FOR H.323

(Geneva, 1999)

#### 1 Scope

This Recommendation describes the Call Park (SS-PARK) and the Call Pickup (SS-PICKUP) supplementary services that are applicable to various basic services supported by H.323 endpoints.

#### 2 References

The following ITU-T Recommendations and other references contain provisions which, through reference in this text, constitute provisions of this Recommendation. At the time of publication, the editions indicated were valid. All Recommendations and other references are subject to revision; all users of this Recommendation are therefore encouraged to investigate the possibility of applying the most recent edition of the Recommendations and other references listed below. A list of the currently valid ITU-T Recommendations is regularly published.

- ITU-T Recommendation H.225.0 (1998), *Call signalling protocols and media stream packetization for packet-based multimedia communication systems.*
- ITU-T Recommendation H.245 (1998), *Control protocol for multimedia communication.*
- ITU-T Recommendation H.323 (1998), *Packet-based multimedia communications systems.*
- ITU-T Recommendation H.450.1 (1998), *Generic functional protocol for the support of supplementary services in H.323.*

#### 3 Terms and definitions

This Recommendation defines the following terms:

- 3.1 Alerting call:** A Basic H.323 call that is presented to the called user (alerting state) and has not yet been answered by the called user. During the alerting state, the call may be picked-up by any authorized Picking-up User.
- 3.2 Alerting endpoint/user:** The endpoint/user that is being alerted (alerting call), which is picked up by a Picking-up User.
- 3.3 Calling endpoint/user:** The endpoint/user who originated a call to the alerting endpoint/user that is picked-up by the Picking-up User.
- 3.4 Directed park:** Directed park enables the parking user to park a call at a parking position that is associated with a terminal endpoint. Typically, the parking user explicitly provides the parked-to number that is used to address the parking position.
- 3.5 Directed pickup:** Directed pickup enables a picking-up user to pickup a parked call or an alerting call by means of explicitly providing the number of a parking position (i.e. parked-to user) or of an Alerting User.
- 3.6 Group member endpoint/user:** The endpoint/user that is a member of a Pickup Group and receives a notification about a parked call/alerting call that can be picked up.

**3.7 Group park:** Group park enables the parking user to park a call at a parking position that is associated with a pickup-group and which may typically be located in a server endpoint. A preconfigured number may be used to address the parking position.

**3.8 Group pickup:** Group pickup enables a picking-up user to pickup a parked call or an alerting call that is associated with a group. Typically, a preconfigured number is used to address the parked-to position or the alerting endpoint.

**3.9 H.323 Call:** Refer to Recommendation H.323.

**3.10 Number:** A reference to the number of a user (e.g. "number of the Parked-to User" or "number of the Alerting User") is meant to indicate any type of H.225.0 alias address (an E.164 number, a URL address, an e-mail address, etc.).

**3.11 Parking endpoint/user; User A:** The User/Endpoint that invokes SS-PARK during the active state of a call with a user B that results in User B being connected to a Parking Position.

**3.12 Parked endpoint/user; User B:** The User/Endpoint that is connected to a Parking Position following the invocation of SS-PARK by a Parking User. Once User B is parked, the user/endpoint waits to be picked up by a Picking-up User.

**3.13 Parking Position (Parked-to endpoint/entity/user):** A place assigned to a parked-to endpoint where the parked endpoint is parked and subsequently from which it is picked-up. A parking position may also be located within a gatekeeper.

The Parking Position may allow one call to be parked or more than one call to be parked simultaneously. Depending on the implementation, a particular Parking Position within a parked-to endpoint may either be explicitly identified (park position), or queuing concepts may be used for allowing multiple calls to be parked and subsequently picked-up.

A particular call parked at the parked-to endpoint may explicitly be identified via either the park position or by means of a call identifier. If SS-PICKUP does not provide any explicit information that identifies the call to be picked-up, then any parked call at that parked-to endpoint (e.g. the call at the top of a queue) may be selected.

The Parking Position may be located either within an H.323 terminal endpoint or within an H.323 server endpoint.

The definition of parking position applies to both directed park and pickup as well as to group park and pickup.

The Parking Position may request that a user parking a call verify its respective access rights and that a user picking-up a call verify its respective access rights.

**3.14 Picking-up endpoint/user:** A User/Endpoint that picks-up a parked call or an alerting call.

**3.15 Pickup group:** A group of users that may be notified when one of the group members receives a call that can be picked up. Each group member is authorized to answer the call by using SS-PICKUP.

**3.16 Primary call:** Call between a Parking User and a Parked User.

**3.17 Parked call:** Call between a Parked User and a Park Position.

**3.18 Served endpoint:** A parked-to endpoint or an alerting endpoint that indicates to Pickup Group members that a parked call/alerting call is available to be picked up.

**3.19 Unparking endpoint/user:** When picking-up a parked call, the Picking-up User is also referred to as the unparking user.



## 4 Abbreviations and acronyms

This Recommendation uses the following abbreviations:

(A)PDU	(Application) Protocol Data Unit
ASN.1	Abstract Syntax Notation One
GK	Gatekeeper
NFE	Network Facility Extension
SCN	Switched Circuit Network
SDL	Specification and Description Language
SS	Supplementary Service
SS-PARK	Supplementary Service Call Park
SS-PICKUP	Supplementary Service Call Pickup

## 5 Description

Call Park (SS-PARK) is a supplementary service that enables a user A (Parking User) to place an existing call with user B (Parked User) to a Parking Position (parked-to endpoint).

Upon successful invocation of SS-PARK, the parking endpoint becomes idle (except in the case of a local SS-PARK) and is no longer involved in the call with user B. The Parking Position typically provides music/announcement and/or video/still image to the Parked User while that user is parked.

Call Pickup (SS-PICKUP) is a supplementary service that enables a user (Picking-up User) to either retrieve a parked call or to pick up an alerting call.

- a parked call may be picked-up (unparked) by retrieving the Parked User from the parking endpoint A, from the parked-to endpoint or from any other authorized endpoint;
- an alerting call may be picked-up by any authorized Picking-up User.

The architecture of SS-PARK and SS-PICKUP allows any authorized user of an H.323 network to participate in this supplementary service and not just users within a single gatekeeper zone.

Whether a user is allowed or not allowed to pick up a given call (a parked call or an alerting call) is an implementation matter and is out of the scope of this Recommendation.

Upon successful invocation of SS-PICKUP, the Picking-up User is connected to the Parked User (in the case of picking-up a parked call) or is connected to the Calling User (in the case of picking-up an alerting call).

SS-PARK and SS-PICKUP apply to the complete H.323 call for which the supplementary service is being invoked. Usage of SS-PARK or SS-PICKUP for a subset of the media streams, as well as parking or picking-up a T.120 call, is for further study.

### 5.1 Call Park

User A, who is subscribed to the SS-PARK supplementary service, may invoke SS-PARK during the active state of a call by using one of the following options:

#### Directed Park

The call is parked at a destination that is indicated by the Parking User. This destination is assigned to a Parked-to User.

If a Parking Position is available, the call is parked at the parked-to endpoint regardless of the state of the Parked-to User (busy, idle). The Parked-to User may be notified.

If the Parked-To User is a member of a Pickup Group, providing a notification to the other group members is optional. Once a call is parked, other members of the Pickup Group may pick up the parked call.

### **Group Park**

The call is parked at a preconfigured destination assigned not to a specific user, but to a Pickup Group. This destination may comprise one or more than one Parking Positions. All members of the Pickup Group may be provided a notification of the parked call.

After a successful call park, user A becomes idle and user B is parked to a Parking Position.

Media channels opened during the primary call may be opened for the parked call. That is, if the primary call was a call that contained audio and video streams, then the Parked User may be provided with both audio (music, announcement) and video (video clip, freeze frame, etc.) as well.

If the parked call is not picked-up within a configured period of time, the parked call may be recalled to the Parking User. If the call park invocation is unsuccessful (e.g. the maximum number of parked calls had already been reached), then user A shall be informed of the call park invocation failure.

## **5.2 Call Pickup**

### **Scenario A – SS-PICKUP of a parked call (directed pickup)**

The call has been parked at a Parking Position of the indicated Parked-to User. The Parked-to User is notified, other Pickup Group members may optionally be notified. The Picking-up User (which may also be the Parking User) identifies the number of the Parked-to User and requests to be connected with the Parked User. Typically the Picking-up User is the Parking User that picks up the call from another terminal. If no specific identification is provided that explicitly identifies a particular parked call to be picked-up at the parked-to endpoint (in the case of multiple parked calls at a Parking Position), then any parked call may be selected by the parked-to endpoint to be picked up (e.g. the parked call on the top of a queue may be selected). If no call is waiting for retrieval at the selected Parked-to User/Parking Position, then a pickup request will be rejected.

### **Scenario B – SS-PICKUP of a parked call (group pickup)**

The call has been parked at the Parked Position of a Pickup Group. Other group members may have been notified about the parked call. Members willing to pickup the call may request a Group Call Pickup, which will cause the establishment of a call to the Parking Position (which may be at a predefined address). The parked call will be connected to the first requesting user. If the parked-to endpoint supports multiple parked calls (e.g. if multiple Parking Positions are related to the Pickup Group or if queuing concepts are used), then a subsequent SS-PICKUP invocation to that destination will pick up (be connected to) the next parked call, if one is available. Otherwise, subsequent SS-PICKUP requests will be rejected. The Picking-up User may explicitly identify a particular call to be picked-up at the parked-to endpoint.

### **Scenario C – SS-PICKUP of an alerting call (directed pickup)**

A call is alerting a user. Another user that is aware of the alerting user and that is willing to retrieve the call, identifies the number of the Alerting User and initiates an action to connect to the Calling User. If multiple calls are alerting at the Alerting User, more than one alerting call may be subject to SS-PICKUP with or without being explicitly identified by the Picking-up User. If not explicitly identified, any alerting call may be selected for SS-PICKUP by the alerting endpoint.

### **Scenario D – SS-PICKUP of an alerting call (group pickup)**

A call is alerting a user belonging to a Pickup Group. All other group members should be notified about the alerting call. Group members willing to retrieve the call may request Group Call Pickup,

which will initiate the establishment of a call between the Picking-up User and a specific alerting call, when:

- the Picking-up User explicitly identifies the particular alerting call to be picked-up; or
- the picking-up endpoint identifies the particular alerting call to be picked-up (e.g. based on a previous group notification received).

Subsequent pickup requests referring to a formerly alerting call that has already been picked-up will be rejected.

If the Picking-up User/Endpoint does not explicitly identify a specific alerting call to connect to as part of the SS-PICKUP, then the Picking-up User will be connected to one of the group member's alerting call(s). A pickup request from another group member that does not identify the particular call to be picked-up will be connected to the next call that is alerting at one of the group members. If there are no calls alerting a group member, then the pickup request will be rejected.

After a successful SS-PICKUP, the Picking-up User will be able to communicate with the Parked/Calling User.

Media channels opened for the parked call may be opened for the picked-up call. That is, if the parked call was an audio and video call, then the picked-up call should establish (according to terminal capability exchange procedures) audio and video streams as well, if possible.

## 6 Messages and information elements

The operations of SS-PARK and SS-PICKUP are transported within the h4501SupplementaryService APDU (carried within User-to-User information elements) in call control and FACILITY messages as defined in Recommendation H.450.1. The particular SS-PARK and SS-PICKUP operations are defined in clause 11.

When conveying the Invoke APDU of the operations defined in clause 11, the destinationEntity data element of the NFE shall contain the value "endpoint".

When conveying the Invoke APDU of operation **cpSetup** or **pickExe**, the Interpretation APDU shall contain value "clearCallIfAnyInvokePduNotRecognized".

When conveying the Invoke APDU of operations **cpRequest**, **pickrequ**, **pickup**, **groupIndicationOn** or **groupIndicationOff**, the Interpretation APDU shall be omitted or shall contain value "rejectAnyUnrecognizedInvokePdu".

When conveying the Invoke APDU of the operations **cpNotify** or **cppickupNotify**, the Interpretation APDU shall contain the value "discardAnyUnrecognizedInvokePdu".

## 7 Procedures

### 7.1 Actions at the Parking Endpoint A

When receiving an SS-PARK request from the Parking User A while in H.225.0 call control state "active" (U10), the parking endpoint A shall send a FACILITY message containing a **cpRequest** Invoke APDU to the parked endpoint B, enter state CP-Requested and start timer T1. The **cpRequest** Invoke APDU shall contain the arguments: parkingNumber (user A), parkedNumber (user B), parkedToNumber (number of the parking location) and optionally a parkedToPosition (if the Parking User wants to park the call at a specific Parking Position).

Successful outcome of SS-PARK shall be indicated by receiving a **cpRequest** Return Result APDU within a RELEASE COMPLETE message from the parked endpoint. The **cpRequest** Return Result APDU shall contain the arguments parkedToNumber, the parkCondition (indicating whether the Parked-to User is idle or busy, whether the call was parked as part of group park or whether the

condition is unspecified), and an optional parkedToPosition. The parkedToPosition value may be different compared to the value optionally sent within the **cpRequest** Invoke APDU.

Upon receipt of a **cpRequest** Return Result APDU, the parking endpoint shall enter state CP-Idle and stop timer T1. The H.245 connection (if any) and the logical channels shall be terminated.

When receiving a local SS-PARK request from the Parking User A while in a H.225.0 call control state different from "active", the parking endpoint shall locally reject the supplementary service request.

In the case of an unsuccessful outcome of SS-PARK (at the parked or parked-to endpoint), a **cpRequest** Return Error APDU or a Reject APDU shall be received from parked endpoint B within a FACILITY message reporting the reason for the unsuccessful outcome. Timer T1 shall be stopped and state CP-Idle shall be entered. The call between user A and user B shall continue.

In the case of timer T1 expiry, the parking endpoint shall enter state CP-Idle and continue the call with user B.

An unsuccessful outcome of SS-PARK shall be reported to the Parking User.

## 7.2 Actions at the Parked Endpoint B

### SS-PARK

Upon receiving a **cpRequest** Invoke APDU on the primary call from parking endpoint A while in H.225.0 call control state "active", the parked endpoint B shall determine whether it can participate in the SS-PARK. If possible, it shall use the parkedToNumber received within the **cpRequest** Invoke APDU to establish the parked call to the parked-to endpoint.

The SETUP message sent towards the parked-to endpoint shall contain a **cpSetup** Invoke APDU containing the arguments parkingNumber (User A), parkedNumber (User B), parkedToNumber and a parkedToPosition (if received in the **cpRequest** Invoke APDU). State CP-SetupRequ shall be entered and optional Timer T2 may be started at parked endpoint B.

Upon receiving a PROGRESS message with a **cpSetup** Return Result APDU from the parked-to endpoint, parked endpoint B shall stop timer T2, (if running) send a RELEASE COMPLETE message containing **cpRequest** Return Result APDU to parking endpoint A and enter state CP-Idle.

H.245 connection and logical channel establishment between the parked and the parked-to endpoints shall follow standard H.323 procedures.

Media channels opened for the primary call with parking endpoint A may be opened for the parked call or other media channel usage may be automatically negotiated between the parked and the parked-to endpoints.

The Parked User shall be able to listen to the receive logical channels for possible announcements, music, video, etc. from the parked-to endpoint, as appropriate for this call.

On receipt of a **cpRequest** Invoke APDU from parking endpoint A, if the parked endpoint B cannot participate in the SS-PARK, a **cpRequest** Return Error APDU or a Reject APDU shall be returned within a FACILITY message from the parked endpoint B to parking endpoint A.

On expiry of timer T2 at parked endpoint B, or on receipt of a call clearing indication of the parked call while in state CP-SetupRequ, the parked endpoint shall send a **cpRequest** Return Error APDU to parking endpoint A in a FACILITY message, stop timer T2 if running and enter state CP-Idle.

If a **cpSetup** Return Error APDU or Reject APDU was received from the parked-to endpoint, the same error value shall be sent in the **cpRequest** Return Error APDU from the parked endpoint B to parking endpoint A.

If the primary call is cleared while in state CP-SetupRequ, the parked endpoint shall stop timer T2 if running, clear the parked call and enter state CP-Idle.

If the parked call is cleared while in state CP-Idle (i.e. after **cpSetup** Return Result APDU has been received), the parking endpoint may be recalled.

## SS-PICKUP

- **SS-PICKUP (by a Picking-up User local to the parked-to endpoint)**

A **pickup** Invoke APDU may be received within a CONNECT message from the parked-to endpoint. If supported and allowed, the calling endpoint shall return a **pickup** Return Result APDU within a FACILITY message.

The H.245 connection and logical channels may be retained if already available as part of the parked call. Otherwise, standard H.323 procedures shall be used for H.245 connection and logical channel establishment.

If the SS-PICKUP request cannot be accepted by the parked endpoint, a **pickup** Return Error APDU or a Reject APDU shall be returned to the parked-to endpoint within a RELEASE COMPLETE message.

- **SS-PICKUP (by a Picking-up User remote to the parked-to endpoint)**

A **pickup** Invoke APDU may be received within a FACILITY message, requesting to re-establish the call to the picking-up endpoint. If supported and allowed, the parked endpoint shall return a **pickup** Return Result APDU. Otherwise, a **pickup** Return Error APDU or a Reject APDU shall be returned to the parked-to endpoint.

If SS-PICKUP is allowed and possible for this call, the parked endpoint shall initiate call establishment (sending a SETUP message) to the picking-up endpoint containing a **pickExe** Invoke APDU. The elements callPickupId, picking-upNumber and partyToRetrieve shall be sent as received from the **pickup** Invoke APDU. Timer T10 shall be started and state CpickupSetupInit shall be entered.

If a **pickExe** Return Result APDU is received in a CONNECT message from the picking-up endpoint while in state CpickupSetupInit, timer T10 shall be stopped and state CP-Idle shall be entered. The parked call to the parked-to endpoint shall be released. Further call establishment (H.245 connection, logical channels) shall follow standards H.323 procedures.

If a **pickExe** Return Error APDU or a Reject APDU is received from the picking-up endpoint, the parked endpoint shall stop Timer T10, release the call to the picking-up endpoint (if not already released), and enter state CP-Idle.

## 7.3 Actions at the Parked-To Endpoint

### SS-PARK

On receipt of a SETUP message with a **cpSetup** Invoke APDU from the parked endpoint, the parked-to endpoint shall check the parkingNumber (User A), the parkedNumber (user B), the parkedToNumber and the optional parkedToPosition received and shall check whether SS-PARK is allowed for this particular call. If SS-PARK is allowed for this particular call, a **cpSetup** Return Result APDU shall be returned within a PROGRESS message to the parked endpoint that includes the parkedToNumber, parkedToPosition and the parkCondition (unspecified, parkedToUserIdle, parkedToUserBusy or parkedToGroup).

State CP-WaitforPickup shall be entered and timer T3 shall be started.

The proposed parkedToPosition optionally received within **cpSetup** Invoke APDU shall be honoured by the parked-to endpoint, if possible. If the proposed parkedToPosition is not available, the parked-to endpoint may choose an alternate parkedToPosition. The parkedToPosition chosen by the parked-to endpoint shall be returned within the **cpSetup** Return Result APDU. If the concept of

park positions is not supported at all, the parked-to endpoint shall ignore the parkedToPosition received in the **cpSetup** Invoke APDU and shall not include the argument parkedToPosition in the **cpSetup** Return Result APDU.

H.245 connection and logical channel establishment shall follow standard H.323 procedures. Media channels opened for the primary call may be opened for the parked call or may be automatically negotiated between the parked and the parked-to endpoints.

The parked-to endpoint may provide music, announcements, still image and/or video to the parked endpoint, as appropriate for this call.

If a **cpSetup** Invoke APDU is received and SS-PARK cannot be accepted for this call, a **cpSetup** Return Error APDU including the appropriate error value or a Reject APDU shall be returned to the parked endpoint.

If timer T3 expires, the parked call shall be released.

## SS-PICKUP

- **Picking-up User is local at the parked-to endpoint** (the parked-to endpoint is the picking-up endpoint)

Upon receiving a SS-PICKUP request by the Picking-up User, the picking-up endpoint shall check whether the Picking-up User is allowed to unpark a parked call. If allowed, a **pickup** Invoke APDU shall be sent to the parked endpoint within a CONNECT message using the call reference of the parked call, and the picking-up endpoint shall enter state CpickupRequested and start timer T6.

If the pickup is acceptable to the parked endpoint, a **pickup** Return Result APDU shall be received within a FACILITY message, causing the picking-up endpoint to enter state CpickupIdle and stop timer T6. In addition, timer T3 shall be stopped.

The H.245 connection and the logical channels may be retained from the parked call.

If in state CpickupRequested a **pickup** Return Error APDU or a Reject APDU is received within a RELEASE COMPLETE message, call clearing of the parked call shall be continued, T6 and T3 shall be stopped and state CpickupIdle shall be entered. If in state CpickupRequested a **pickup** Return Error or Reject APDU is received within a message other than RELEASE COMPLETE (e.g. FACILITY), the parked-to endpoint shall clear the parked call (i.e. send RELEASE COMPLETE) stop timers T6 and T3 and shall enter state CpickupIdle. If timer T6 expires, call clearing of the parked call shall be initiated by sending a RELEASE COMPLETE message to the parked endpoint, timer T3 shall be stopped and state CpickupIdle shall be entered.

- **Picking-up User is remote to the parked-to endpoint** (the parked-to endpoint and the picking-up endpoint are different)

If a **pickrequ** Invoke APDU is received from a picking-up endpoint while in state CP-WaitforPickup and SS-PICKUP is allowed for this call (locally checked), the parked-to endpoint shall send a **pickup** Invoke APDU to the parked endpoint within a FACILITY message using the call reference of the parked call, enter state CpickupRemoteRequested and start timer T9.

Upon receiving a **pickup** Return Result APDU from the parked endpoint, the parked-to endpoint shall send a **pickrequ** Return Result APDU to the picking-up endpoint, stop timer T9 and enter state CpickupIdle.

If RELEASE COMPLETE is received from the parked endpoint, call clearing shall be continued, timer T3 shall be stopped and state CP-Idle shall be entered.

Upon receiving a **pickup** Return Error or a Reject APDU from the parked endpoint, the parked-to endpoint shall send a **pickrequ** Return Error APDU to the picking-up endpoint, stop timer T9 and enter state CP-WaitforPickup.

#### 7.4 Actions at the Calling endpoint (SS-PICKUP of an alerting call)

- **SS-PICKUP (by a user local to the alerting endpoint)**

While in H.225.0 call control state call delivered (U4) – entered when an ALERTING message is received – the calling endpoint may receive a **pickup** Invoke APDU within a CONNECT message from the alerting endpoint. If supported and allowed, the calling endpoint shall return a **pickup** Return Result APDU within a FACILITY message to the alerting endpoint.

The H.245 connection and logical channels may be retained if already available as part of the alerting call. Otherwise, normal H.323 procedures shall be used for H.245 connection and logical channel establishment.

If the SS-PICKUP request cannot be accepted by the calling endpoint, then a **pickup** Return Error APDU or a Reject APDU shall be returned to the alerting endpoint within a RELEASE COMPLETE message.

- **SS-PICKUP (by a user remote to the alerting endpoint)**

While in H.225.0 call control state call delivered (U4) – entered when an ALERTING message is received – the calling endpoint may receive a **pickup** Invoke APDU within a FACILITY message from a picking-up endpoint, requesting to re-establish the call to the picking-up endpoint. If supported and allowed, the calling endpoint shall return a **pickup** Return Result APDU to the picking-up endpoint. Otherwise, a **pickup** Return Error APDU or a Reject APDU shall be returned to the picking-up endpoint.

If SS-PICKUP is allowed and possible for this call, the calling endpoint shall initiate call establishment (sending a SETUP message) to the picking-up endpoint, containing a **pickExe** Invoke APDU. The elements callPickupId, picking-upNumber and partyToRetrieve shall be taken from the **pickup** Invoke APDU received from the picking-up endpoint. Timer T10 shall be started and state CpickupSetupInit shall be entered.

If a **pickExe** Return Result APDU is received by the calling endpoint in a CONNECT message from the picking-up endpoint while in state CpickupSetupInit, then timer T10 shall be stopped and state CpickupIdle shall be entered by the calling endpoint. The alerting call to the alerting endpoint shall be released by the calling endpoint. Further call establishment (an H.245 connection, logical channels) shall follow standard H.323 procedures.

If a **pickExe** Return Error APDU or a Reject APDU is received from the picking-up endpoint, the calling endpoint shall stop Timer T10, release the connection to the picking-up endpoint (if not already released), and enter state CpickupIdle.

#### 7.5 Actions at the Alerting endpoint (SS-PICKUP of an alerting call)

If an incoming call is received that alerts the called user (an ALERTING message is sent back to the calling endpoint) and SS-PICKUP is possible for this call, then state WaitforPickup shall be entered at the alerting user.

- **Picking-up User is local at the alerting endpoint** (alerting endpoint equals picking-up endpoint)

Upon receiving a SS-PICKUP request by the Picking-up User while in state WaitforPickup, the picking-up endpoint shall check whether the Picking-up User is allowed to retrieve the alerting call. If allowed, the picking-up endpoint shall send a **pickup** Invoke APDU within a

CONNECT message using the call reference of the alerting call to the calling endpoint. The picking-up endpoint shall enter state CpickupRequested and start timer T6.

If the pickup is acceptable, the calling endpoint shall send a **pickup** Return Result APDU within a FACILITY message to the picking-up endpoint, causing the picking-up endpoint to enter state CpickupIdle and stop timer T6.

H.245 connection and logical channels establishment shall follow standard H.323 procedures, if not already established.

If in state CpickupRequested the picking-up endpoint receives a **pickup** Return Error APDU or a reject APDU within a RELEASE COMPLETE message is received from the calling endpoint, then timer T6 shall be stopped and state CpickupIdle shall be entered. If in state CpickupRequested a **pickup** Return Error or Reject APDU is received within a message other than RELEASE COMPLETE (e.g. FACILITY), the alerting endpoint shall clear the parked call (i.e. send RELEASE COMPLETE message to the calling endpoint) stop timer T6 and shall enter state CpickupIdle. If timer T6 expires, a RELEASE COMPLETE message shall be sent to the calling endpoint and the state shall return to CpickupIdle.

- **Picking-up User is remote to the alerting endpoint** (the alerting endpoint and the picking-up endpoint are different)

If an alerting endpoint receives a **pickrequ** Invoke APDU from a picking-up endpoint while in state WaitforPickup and SS-PICKUP is allowed for this call (locally checked), then the alerting endpoint shall send a **pickup** Invoke APDU to the calling endpoint within a FACILITY message using the call reference of the alerting call, enter state CpickupRemoteRequested and start timer T9.

Upon receiving a **pickup** Return Result APDU from the calling endpoint, the alerting endpoint shall send a **pickrequ** Return Result APDU to the picking-up endpoint, stop timer T9 and enter state CpickupIdle.

Upon receiving a **pickup** Return Error or a Reject APDU from the calling endpoint, the alerting endpoint shall send a **pickrequ** Return Error APDU to the picking-up endpoint, stop timer T9 and enter state WaitforPickup.

## 7.6 Actions at the Served endpoint

Group notifications may be sent from either a parked-to endpoint having entered state CP-WaitforPickup or from an Alerting endpoint, in order to inform Pickup Group members that a call is available to be picked up. As an option, a GK may send group notifications for SS-PICKUP on behalf of alerting calls (see Figure 10).

Upon having received an incoming call that is alerting (an ALERTING message has been sent back to the calling endpoint) or upon having successfully received a parked call (having entered state CP-WaitforPickup), a served endpoint may send a **groupIndicationOn** Invoke APDU in a SETUP message (for a new call) or a FACILITY message (for an existing call) to each Pickup Group member by either initiating a new call independent signalling connection or using a call independent signalling connection that is already established to that endpoint. If a new call independent signalling connection is initiated, it shall be established in accordance with the procedures specified in Recommendation H.450.1.

The **groupIndicationOn** Invoke APDU shall contain the elements:

- callPickupId (with its value taken from the H.225.0 CallIdentifier element of the parked/alerting call);
- retrieveCallType (call to be picked up is an alerting call or a parked call);
- partyToRetrieve (Parked or Calling User);
- retrieveAddress [address of the served (parked-to/alerting) endpoint];



- parkPosition (for SS-PICKUP of a parked call, if available).

Upon sending of the **groupIndicationOn** Invoke APDU, the served endpoint shall enter the GP-NotifyOnRequ state and start timer T4. On receipt of a **groupIndicationOn** Return Result, Return Error or Reject APDU, the served endpoint shall stop timer T4 and shall return to GP-Idle state.

NOTE – A **groupIndicationOn** Invoke APDU may be sent to several members of a Pickup Group. The served endpoint shall enter state GP-NotifyOnRequ and shall start timer T4 each time a **groupIndicationOn** Invoke APDU is sent (i.e. state GP-NotifyOnRequ and timer T4 are managed on a per call basis).

Expiry of timer T4 shall be treated the same as if a Reject APDU had been received.

The served endpoint is responsible for clearing the call independent signalling connection towards each Pickup group member endpoint (if not already cleared by the Pickup Group member endpoint). This may occur on receipt of the Return Result, Return Error, Reject APDU or on timer T4 expiry. Alternatively, the signalling connection may be retained (e.g. for later **groupIndicationOff** Invoke APDU signalling).

If the parked call/alerting call is picked-up successfully by a Picking-up User, then the served endpoint shall send a **groupIndicationOff** Invoke APDU in a SETUP message (for a new call) or a FACILITY message (for an existing call) to each of the Pickup Group member endpoints by either initiating a new call independent signalling connection or using a call independent signalling connection that is already established to an endpoint. If a new call independent signalling connection is initiated, it shall be established in accordance with the procedures specified in Recommendation H.450.1.

Upon sending of the **groupIndicationOff** Invoke APDU, the served endpoint shall enter the GP-NotifyOffRequ state and start timer T5. On receipt of a **groupIndicationOff** Return Result, Return Error or Reject APDU, the served endpoint shall stop timer T5 and shall return to GP-Idle state.

Expiry of timer T5 shall be treated the same as if a Reject APDU had been received.

The served endpoint is responsible for clearing the call independent signalling connection towards each Pickup Group member endpoint (if not already cleared by the Pickup Group member endpoint). This may occur on receipt of the Return Result, Return Error, Reject APDU or on timer T5 expiry. Alternatively, the signalling connection may be retained.

## 7.7 Actions at a Pickup Group member endpoint

On receipt of a **groupIndicationOn** Invoke APDU in a SETUP or FACILITY message of a call independent signalling connection, the Pickup Group member endpoint shall verify that group notification is supported and enabled for the group member user (checking element groupMemberUserNr).

If the group member notification request is acceptable, the Pickup Group member endpoint shall inform the group member user that there is a call that can be picked-up, answer the **groupIndicationOn** Invoke APDU with a **groupIndicationOn** Return Result APDU sent in a FACILITY, RELEASE COMPLETE or CONNECT message and store the received elements for possible subsequent usage with SS-PICKUP.

If the **groupIndicationOn** Invoke APDU is not acceptable, a **groupIndicationOn** Return Error APDU or a Reject APDU shall be returned in a FACILITY, RELEASE COMPLETE or CONNECT message.

On receipt of a **groupIndicationOff** Invoke APDU in a SETUP or FACILITY message of a call independent signalling connection, the Pickup Group member endpoint shall check the validity of the request.

If the **groupIndicationOff** request is valid, the Pickup Group member endpoint shall stop offering the call to be picked up to the group member user and shall return a **groupIndicationOff** Return Result APDU to the served endpoint in a FACILITY, RELEASE COMPLETE or CONNECT message.

If the **groupIndicationOff** Invoke APDU is not acceptable, a **groupIndicationOff** Return Error APDU or a Reject APDU shall be returned in a FACILITY, RELEASE COMPLETE or CONNECT message.

## 7.8 Actions at the Picking-up Endpoint

- **Picking-up User is local to the parked-to/alerting endpoint**

Refer to 7.3 Actions at the Parked-to endpoint, and to 7.5 Actions at the Alerting endpoint.

- **Picking-up User is remote to the parked-to/alerting endpoint**

Upon receiving a SS-PICKUP request from a Picking-up User, the picking-up endpoint shall check whether the Picking-up User is allowed to pickup the parked/alerting call. If SS-PICKUP is allowed for this call, the picking-up endpoint shall send a **pickrequ** Invoke APDU in a SETUP message (for a new call) or a FACILITY message (for an existing call) to the parked-to/alerting endpoint by either establishing a new call independent signalling connection or using a call independent signalling connection that is already established to the parked-to/alerting endpoint, enter state CpickupRemoteRequested and start timer T7.

If a new call independent signalling connection is initiated, it shall be established in accordance with the procedures specified in Recommendation H.450.1.

On receipt of a **pickrequ** Return Result APDU in a FACILITY message, the picking-up endpoint shall enter state CpickupWaitSetup, stop timer T7 and start timer T8.

On receipt of a **pickrequ** Return Error or a Reject APDU in a FACILITY message while in state CpickupRemoteRequested, the picking-up endpoint shall stop timer T7 and shall return to state CpickupIdle. Expiry of timer T7 shall be treated the same as if a Reject APDU had been received.

The picking-up endpoint is responsible for clearing the call independent signalling connection towards the parked-to/alerting endpoint. This may occur on receipt of the Return Result, Return Error, Reject APDU or on timer T7 expiry. Alternatively, the signalling connection may be retained.

While in state CpickupWaitSetup, a SETUP message received by a picking-up endpoint from the calling endpoint containing a **pickExe** Invoke APDU will be checked to see if it is valid and is associated to a pending SS-PICKUP request. This association shall be checked by means of matching the callPickupId values from the received **pickExe** Invoke APDU with the previously received **pickrequ** Return Result APDU associated with the same call.

If acceptable, a **pickExe** Return Result APDU shall be returned within a CONNECT message, timer T8 shall be stopped and state CpickupIdle shall be entered.

H.245 connection and logical channel establishment shall follow standard H.323 procedures. The media types opened for the parked/alerting call shall be opened for the picked-up call as far as possible.

If the **pickExe** Invoke APDU is not acceptable, a **pickExe** Return Error APDU with an appropriate cause value or a Reject APDU shall be returned within a RELEASE COMPLETE message. Timer T8 shall be stopped and state CpickupIdle shall be entered.

## 7.9 Alternative procedures

### 7.9.1 Local SS-PARK and pickup from local park

The procedures described for SS-PARK within the previous clauses are based on a re-routing approach, i.e. the parked endpoint establishes a new call (parked call) to the parked-to endpoint. These procedures may also be used when the parking endpoint is the parked-to endpoint. However, in order to simplify procedures, if the parking endpoint is the same as the parked-to endpoint (local park), the following procedure may apply:

When a SS-PARK request is received from the local Parking User while in H.225.0 call control state "active", the parking endpoint may send a **cpNotify** Invoke APDU within a FACILITY message to the parked endpoint, enter state CP-NotifiedWaitforPickup and start timer T3.

Music, announcements, a video clip or a still image may be provided to the Parked User, i.e. the parking endpoint acts as a parked-to endpoint for this call.

The parked endpoint may provide the information received within the **cpNotify** Invoke APDU to the Parked User and shall connect to the receive logical channels.

If Pickup Group members are to be informed about the parked call, the parking/parked-to endpoint may act as a served endpoint for group member notification (see 7.6).

#### SS-PICKUP from local park

While in state CP-NotifiedWaitforPickup, an authorized Picking-up User may pickup the parked call. The Picking-up User may be an authorized user either local (i.e. the Parking User) or remote to the parked-to endpoint.

When a local pickup request is received while in state CP-NotifiedWaitforPickup and if the SS-PICKUP is allowed, a **cpickupNotify** Invoke APDU shall be sent within a FACILITY message towards the parked endpoint.

When a **pickrequ** Invoke APDU is received within a SETUP message initiating a call independent signalling connection from a remote Picking-up User while being in state CP-NotifiedWaitforPickup, a parked-to endpoint shall check whether the Picking-up User is authorized to pickup the call. If the Picking-up User is authorized, the parked-to endpoint shall establish a call to the picking-up endpoint including a **pickExe** Invoke APDU within the SETUP message followed by receiving a **pickExe** Return Result APDU within CONNECT message, or a **pickExe** Return Error APDU or a Reject APDU within RELEASE COMPLETE message.

If **pickExe** Return Result APDU is received within CONNECT message from the Picking-up User, the parked-to endpoint shall send a **cpickupNotify** Invoke APDU within a FACILITY message to the Parked User.

The parked-to endpoint shall use the "third party initiated pause and re-routing" procedures according to 8.4.6/H.323 for closing the existing logical channels between the parked-to and the parked endpoints and for opening logical channels between the parked and the picking-up endpoints.

For an illustration of the scenario described within this subclause, refer also to Figure 12.

## 8 Interworking

### 8.1 Interworking with SCN

SS-PARK and SS-PICKUP may interwork with corresponding supplementary services for parking and picking up calls as defined by other standards by means of gateway interworking functions. The specification of detailed gateway interworking procedures is out of the scope of this Recommendation and will be specified within other Recommendations.

## 8.2 Interworking with other supplementary services

### 8.2.1 Call Diversion (H.450.3)

A diverted call may be subject to SS-PICKUP.

### 8.2.2 Call Hold (H.450.4)

If a held user or a holding (served) user requests SS-PARK on the held call, the SS-PARK request shall be rejected locally.

A held user may use SS-PICKUP to retrieve a call. SS-PICKUP cannot be used to retrieve a held call, it can only be used to answer an alerting call or retrieve a parked call.

### 8.2.3 Call Waiting (H.450.6)

A user may invoke SS-PARK in order to be able to accept a waiting call.

A waiting call may be subject to SS-PICKUP. If provided, the served endpoint as part of SS-Call Waiting may act according to the procedures as defined in 7.5, Actions at the alerting endpoint, and as defined in 7.6 Actions at the Served endpoint.

### 8.2.4 H.323 Conference

An MCU application may request SS-PARK for a member of a conference. A member of a centralized conference shall not be allowed to invoke SS-PARK to park the centralized conference.

A member of a decentralized H.323 conference that contains the active MC may invoke SS-PARK against a conference member.

A member of a decentralized H.323 conference that does not contain the active MC may not invoke SS-PARK against a conference member.

### 8.2.5 Call Transfer (H.450.2)

If while in state CP-WaitforPickup the parked-to endpoint receives a **callTransferComplete** Invoke APDU, the alias address contained within the argument redirectionNumber should be interpreted as the alias address of the new parked endpoint.

NOTE – This type of supplementary service interaction may, for example, apply in the case of interworking with other networks where the call park supplementary service may be implemented by means of endpoint A parking itself at a parked-to endpoint C (i.e. the parking endpoint is the same as the parked endpoint) followed by endpoint A transferring (joining) the call to endpoint B (e.g. the previously held call) with the call to the parked-to endpoint C.

## 8.3 Interaction with H.225.0 parameters

The H.225.0 **CallIdentifier** value within a parked call shall be set to the CallIdentifier value that was used in the primary call. For all other SETUP messages carrying SS-PARK or SS-PICKUP related APDUs as defined within this Recommendation, new CallIdentifier values shall be used. Note that the CallIdentifier value of the parked/alerting call is preserved during the SS-PARK/SS-PICKUP procedure within the H.450 APDUs.

H.225.0 **ConferenceIdentifier** values are not preserved during the SS-PARK and SS-PICKUP procedures, i.e. new values are assigned for new SETUP messages as part of the SS-PARK and SS-PICKUP procedures.

## 9 Gatekeeper actions

### 9.1 Normal procedures

In the case of a GK routed model, the GK should transparently transport the SS-PARK and SS-PICKUP operations defined in clause 11.

### 9.2 Alternative GK procedures for SS-PICKUP of an Alerting call

#### 9.2.1 Alerting endpoint does not support SS-PICKUP

In order to enable SS-PICKUP for an alerting call even if the alerting endpoint does not support the SS-PICKUP procedures, the following procedure may apply (only for a GK routed model).

For SS-PICKUP of an alerting call when the alerting endpoint does not support the procedures as defined within 7.5, Actions at the alerting endpoint, the GK may act on behalf of the alerting and the served endpoints. For this scenario, the GK may:

- perform the procedures as defined within 7.6 Actions at the Served endpoint, for Pickup Group member notification;
- perform the SS-PICKUP procedures as defined within 7.5 Actions at the alerting endpoint, including:
  - receiving of the **pickrequ** Invoke APDU in a SETUP message from a picking-up endpoint;
  - sending of the **pickup** Invoke APDU in a FACILITY message to the calling endpoint;
  - receiving of the response to the **pickup** Invoke APDU in a FACILITY message from the calling endpoint;
  - sending a response to the **pickrequ** Invoke APDU in a FACILITY message to the picking-up endpoint;
  - receiving the RELEASE COMPLETE message from the calling endpoint (in the case of successful SS-PICKUP); and
  - continuing the call clearing towards the alerting endpoint.

For an illustration of this alternative procedure, refer also to Figure10.

#### 9.2.2 Calling endpoint and Alerting endpoint do not support SS-PICKUP

In order to enable SS-PICKUP of an alerting call even when neither the calling endpoint nor the alerting endpoint support the SS-PICKUP procedures, the following procedure may apply to a GK (only in a GK routed model).

To support this scenario, the GK:

- may support the actions as defined for the "Served endpoint" for Pickup Group member notification (see 7.6);
- shall support the modified actions as defined for the Alerting endpoint (see 7.5), including:
  - reception of a **pickrequ** Invoke APDU in a SETUP message from a picking-up endpoint;
  - sending a response to the **pickrequ** Invoke APDU in a FACILITY message to the picking-up endpoint;
- shall support the modified actions as defined for the Calling endpoint (see 7.5), including:
  - sending a SETUP message with a **pickExe** Invoke APDU to the picking-up endpoint;
  - receiving a response to the **pickExe** Invoke APDU in a CONNECT or RELEASE COMPLETE message from the picking-up endpoint;

- performing "third party initiated pause and re-routing" procedures according to 8.4.6/H.323, including:
  - sending of "empty" terminalCapabilitySet messages, causing the calling endpoint A and the called endpoint B to close logical channels (if they are open);
  - perform terminal capability set exchange, master/slave determination and opening of logical channels between the calling endpoint A and the picking-up endpoint;
- shall send a CONNECT message with an optional **CpickupNotify** Invoke APDU to the calling endpoint;
- shall initiate call clearing to endpoint B (endSession command and RELEASE COMPLETE).

For an illustration of this alternative procedure, refer also to Figure 11.

### 9.2.3 Group pickup of an alerting call at the gatekeeper

Regardless of whether the alerting endpoint supports SS-PICKUP or not, a gatekeeper/proxy may decide to act as the Served endpoint (Served entity) for providing Pickup Group member notifications for this alerting call. In this case, the alerting endpoint should not provide the Pickup Group member notifications (e.g. as an administration matter).

The optional **groupIndicationOn** Invoke APDU with argument retrieveAddress sent from the gatekeeper/proxy will indicate to the Pickup Group members from where the alerting call should be picked-up (i.e. from the alerting endpoint or from the gatekeeper/proxy).

If the picking-up endpoint picks-up the alerting call from the gatekeeper/proxy, for example:

- by means of the retrieveAddress setting within **groupIndicationOn** Invoke APDU; or
- due to a group pickup implementation that does not support the optional group member notification procedures at all (in which case a SS-PICKUP request would be routed to a predefined gatekeeper/proxy address per default),

the procedures as defined within the 9.2.1 and 9.2.2 may apply.

### 9.3 Alternative GK procedures for SS-PARK and SS-PICKUP of a parked call

A gatekeeper may intercept messages as defined for SS-PARK and act on them on behalf of the endpoint the gatekeeper is serving.

A gatekeeper may intercept messages as defined for SS-PICKUP of a parked call and act on them on behalf of the endpoint the gatekeeper is serving.

Procedures for "third party initiated pause and re-routing" as defined in 8.4.6/H.323 may be used if closing and reopening of logical channels is required.

## 10 Dynamic description

### 10.1 Operational model and signal flows

#### 10.1.1 SS-PARK

See Figures 1 to 3.

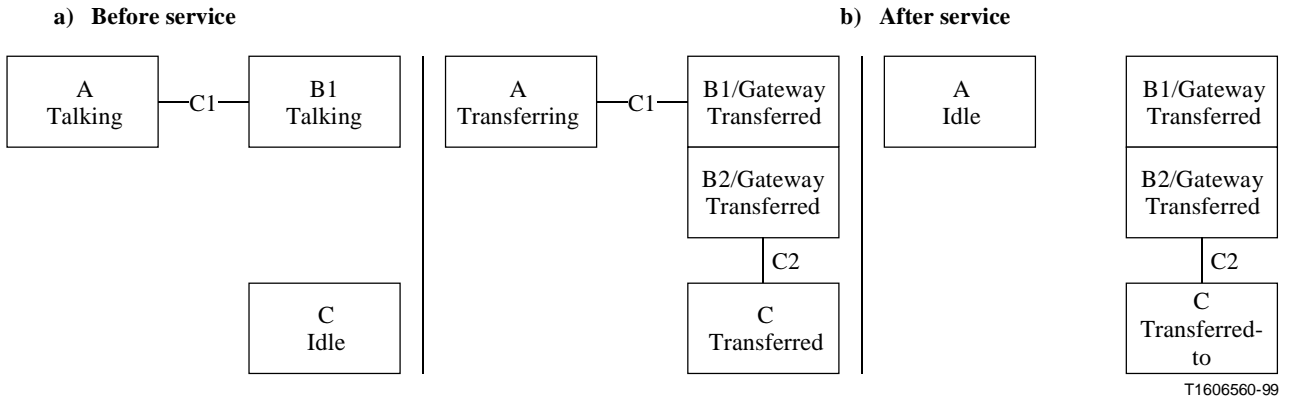


Figure 1/H.450.5 – Operational model for SS-PARK

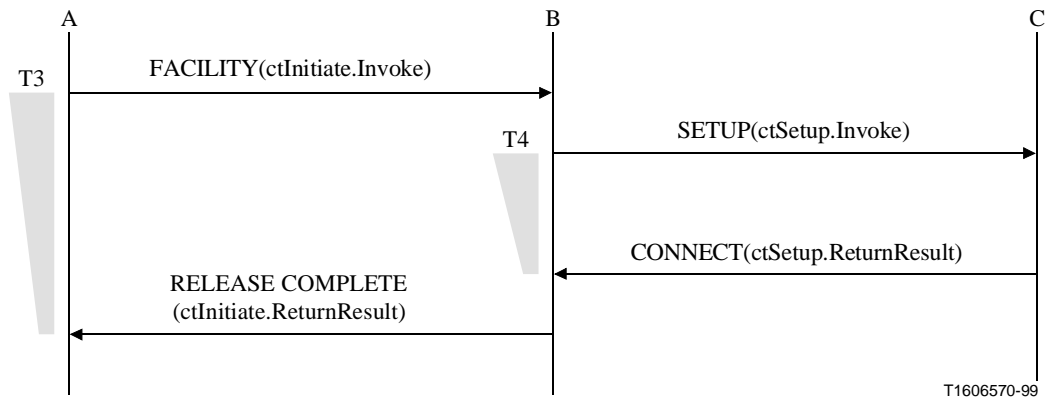


Figure 2/H.450.5 – Signalling flow for SS-PARK

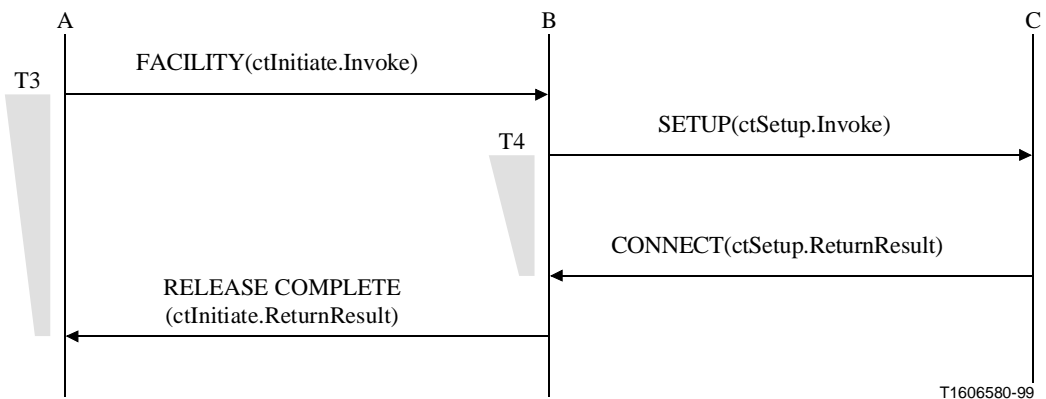


Figure 3/H.450.5 – Signalling flow for SS-PARK – Notification of group members

### 10.1.2 SS-PICKUP of a parked call, unpark

See Figure 4.

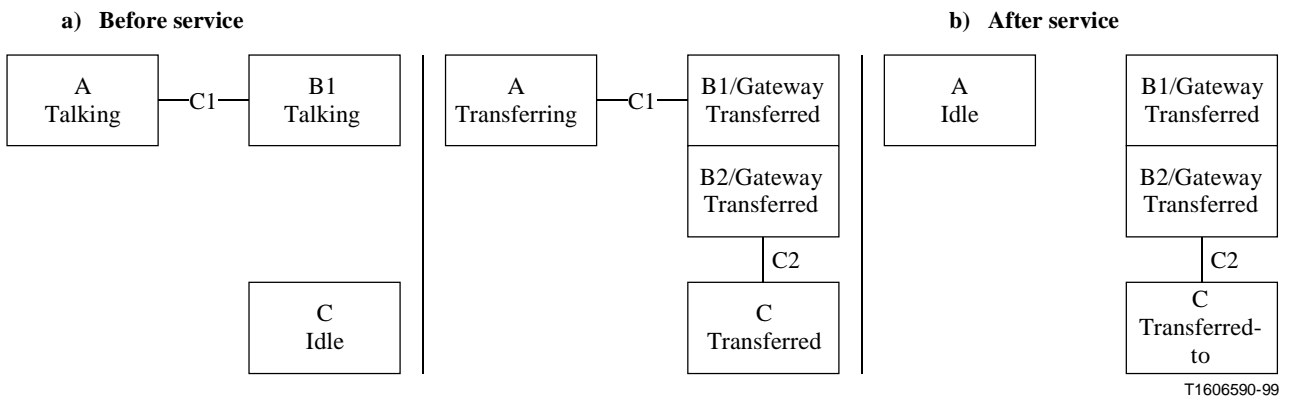


Figure 4/H.450.5 – Operational model for SS-PICKUP

#### a) Parked call unparked by Parked-to User C

See Figure 5.

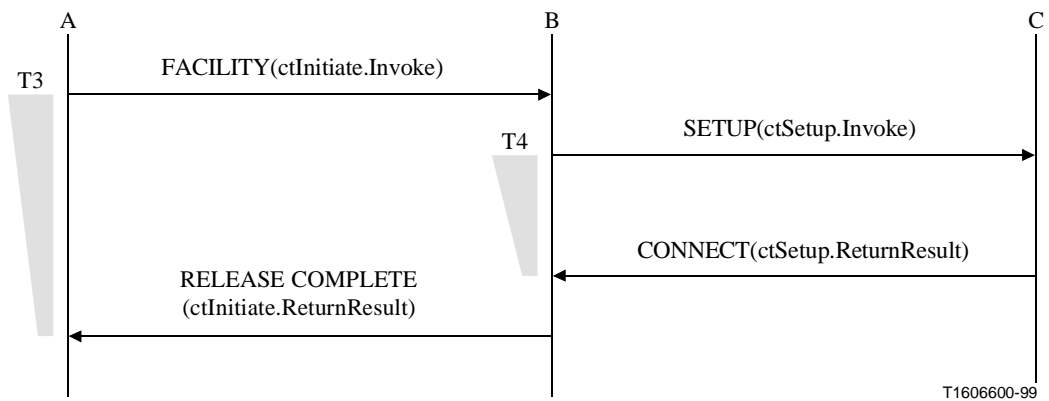
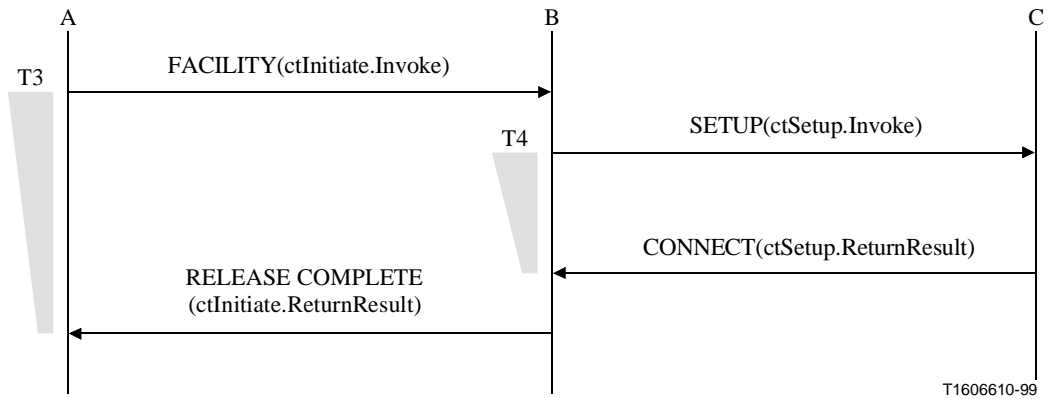


Figure 5/H.450.5 – Signalling flow for SS-PICKUP (Unpark by Parked-to User)



**b) Parked call unparked by User D (may also be the Parking User A)**

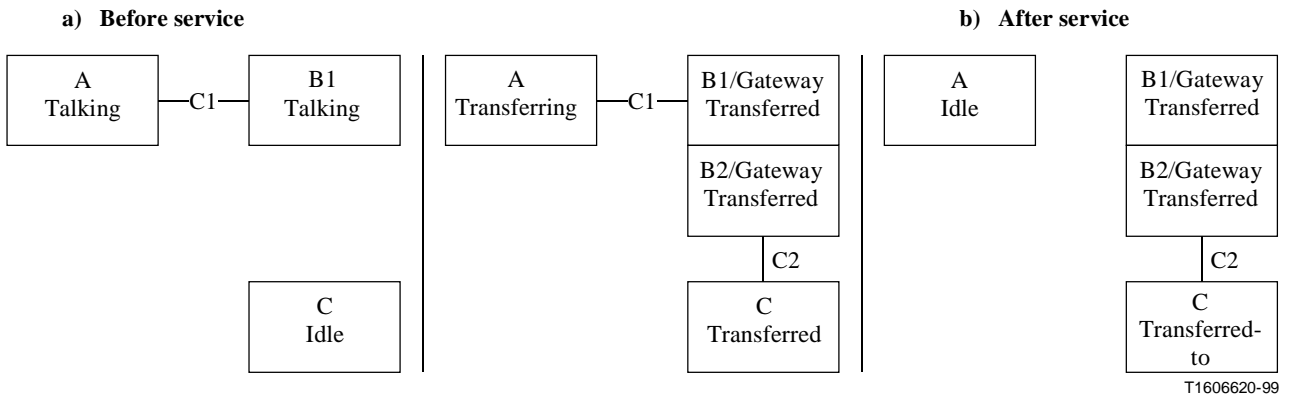
See Figure 6.



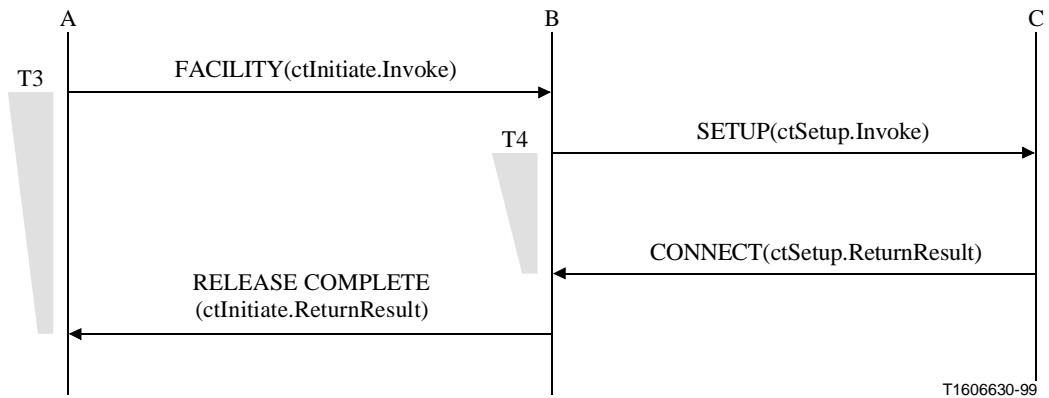
**Figure 6/H.450.5 – Signalling flow for SS-PICKUP (Unpark by any user)**

**10.1.3 SS-PICKUP of an alerting call**

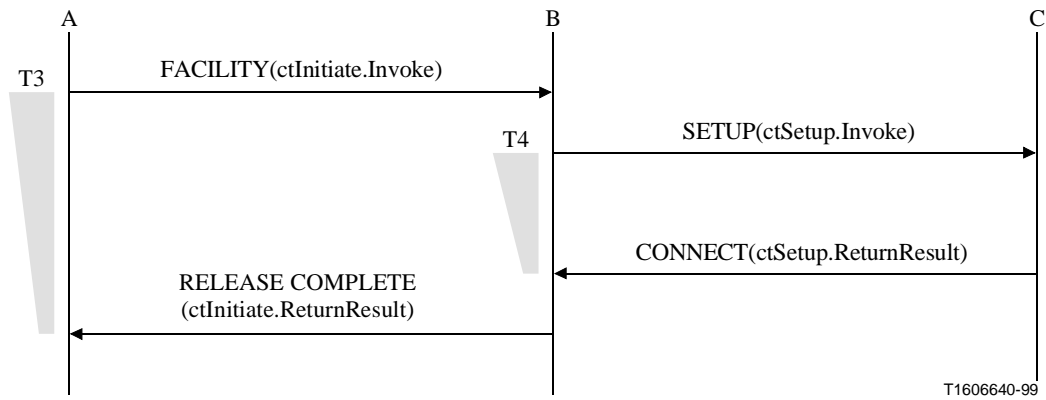
See Figures 7 to 12.



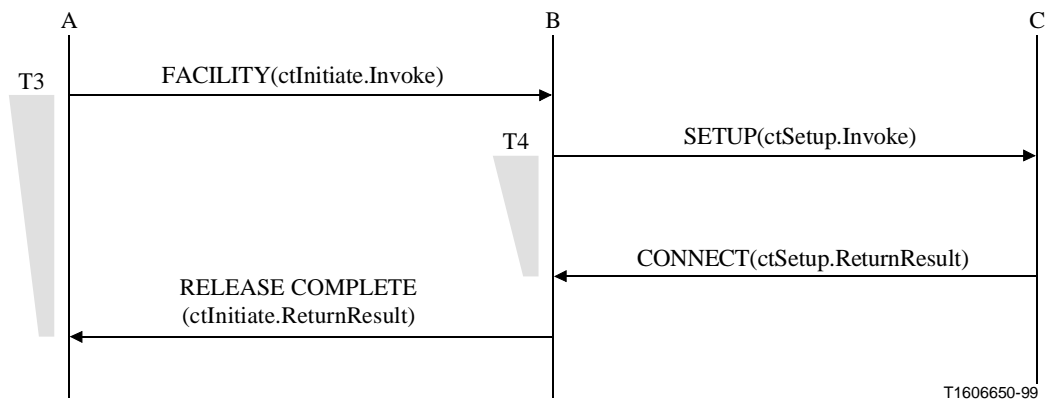
**Figure 7/H.450.5 – Principle of SS-PICKUP**



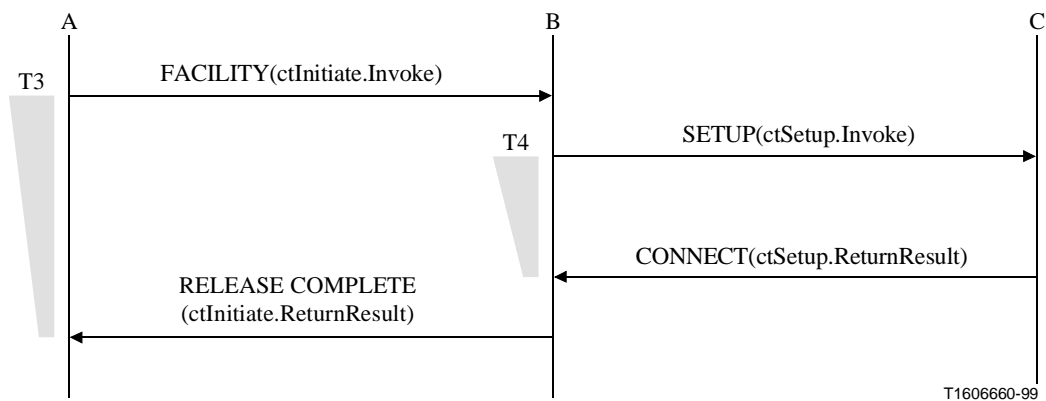
**Figure 8/H.450.5 – Signalling flow for an Alerting call causing Notification of group members for SS-PICKUP**



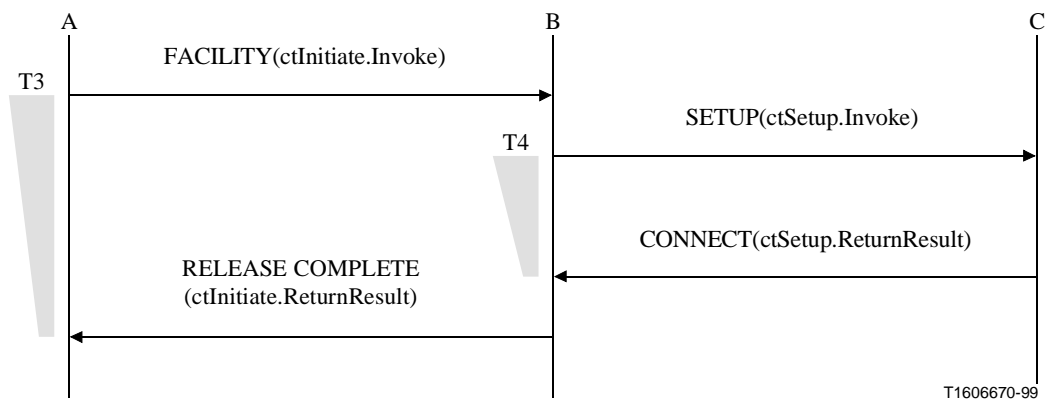
**Figure 9/H.450.5 – Signalling flow for SS-PICKUP (alerting call)**



**Figure 10/H.450.5 – Signalling flow for SS-PICKUP (the alerting endpoint does not support SS-PICKUP; call picked-up at the gatekeeper)**



**Figure 11/H.450.5 – Signalling flow for SS-PICKUP (the calling and alerting endpoints do not support SS-PICKUP; call pickup at the gatekeeper)**



**Figure 12/H.450.5 – Local SS-PARK and pickup from local park**

## 10.2 Communication between a Signalling entity and its Signalling entity user (Primitives and Parameters)

### 10.2.1 Parking endpoint

#### 10.2.1.1 Table of primitives

See Table 1.

**Table 1/H.450.5 – Primitives at the Parking endpoint**

Generic name	Type			
	Request (req)	Indication (ind)	Response (resp)	Confirm (conf)
cpRequest	PARAMETERS	Not defined	Not defined	PARAMETERS
cpNotify	PARAMETERS	Not defined	Not defined	Not defined
cpickupNotify	PARAMETERS	Not defined	Not defined	Not defined
pickrequ	Not defined	PARAMETERS	PARAMETERS	Not defined
pickExe	PARAMETERS	Not defined	Not defined	–

NOTE – “–” means no parameters (manufacturer specific parameters may apply).

#### 10.2.1.2 Primitive definition

The cpRequest.Request primitive is used to request invocation of SS-PARK.

The cpRequest.Confirm primitive is used to indicate successful or unsuccessful invocation of SS-PARK.

The cpNotify.Request primitive is used to initiate local SS-PARK.

The cpickupNotify.Request primitive is used to request retrieval from local SS-PARK.

The pickrequ.Indication primitive may be used to indicate remote SS-PICKUP request from a local SS-PARK (refer also to Figure 12).

The pickrequ.Response primitive may be used to respond to the remote SS-PICKUP request of a locally parked call.

The pickExe.Request primitive may be used in conjunction with remote SS-PICKUP from a local SS-PARK (see also Figure 12).

The pickExe.Confirm primitive may be used to indicate a successful or unsuccessful outcome of the remote SS-PICKUP from the local SS-PARK.

### 10.2.1.3 Parameter definition

cpRequest.Request parameters:

- parkingNumber: Alias of the Parking User;
- parkedNumber: Alias of the Parked User;
- parkedToNumber: Alias of the Parked-to User;
- parkedToPosition: Explicitly identifies the park position at the parked-to endpoint ;
- extensionArg: Placeholder for manufacturer specific information.

cpRequest.Confirm (ack and rej parameters):

- parkedToNumber: Alias of the parked-to endpoint;
- parkedToPosition: Indicates the park position where the call was parked;
- parkCondition: Indicates whether the Parked-to User is idle, busy or whether the call was parked against a group;
- extensionRes: Placeholder for manufacturer specific information;
- notAvailable (\_rej);
- invalidCallState (\_rej);
- resourceUnavailable (\_rej);
- supplementaryServiceInteractionNotAllowed (\_rej);
- undefined (\_rej).

cpNotify.Request parameters:

- parkingNumber: Alias of the parking number;
- extensionArg: Placeholder for manufacturer specific information.

cpickupNotify.Request parameters:

- picking-upNumber: Alias of the Picking-up User;
- extensionArg: Placeholder for manufacturer specific information.

pickrequ.Indication parameters: Refer to corresponding primitive in 10.2.3.

pickrequ.Response (ack and rej) parameters: Refer to corresponding primitive in 10.2.3.

pickExe.Request parameters: Refer to corresponding primitive in 10.2.2.

pickExe.Confirm (ack and rej) parameters: Refer to corresponding primitive in 10.2.2.

## 10.2.2 Parked endpoint

### 10.2.2.1 Table of primitives

See Table 2.

**Table 2/H.450.5 – Primitives at the Parked endpoint**

Generic name	Type			
	Request (req)	Indication (ind)	Response (resp)	Confirm (conf)
cpRequest	Not defined	PARAMETERS	PARAMETERS	Not defined
cpSetup	PARAMETERS	Not defined	Not defined	PARAMETERS
pickup	Not defined	PARAMETERS	–	Not defined
pickExe	PARAMETERS	Not defined	Not defined	–
cpNotify	Not defined	PARAMETERS	Not defined	Not defined
cpickupNotify	Not defined	PARAMETERS	Not defined	Not defined

NOTE – "–" means no parameters (manufacturer specific parameters may apply).

#### 10.2.2.2 Primitive definition

The cpRequest.Indication primitive is used to indicate SS-PARK request to the Parked User.

The cpRequest.Response primitive is used to request sending of **cpRequest** Return Result or **cpRequest** Return Error APDU to the parking endpoint.

The cpSetup.Request primitive is used to initiate parked call establishment.

The cpSetup.Confirm primitive is used to report a successful or unsuccessful outcome of the parked call establishment.

The pickup.Indication primitive is used to indicate that SS-PICKUP is being requested.

The pickup.Response (\_ack or \_rej) primitive acknowledges or rejects a SS-PICKUP request.

The pickExe.Request primitive is used to initiate new call establishment to the picking-up endpoint. This primitive is triggered by the pickup.Response\_ack primitive.

The pickExe.Confirm primitive is used to indicate a successful or unsuccessful outcome of the new call establishment as part of SS-PICKUP.

The cpNotify.Indication primitive is used to indicate that a local SS-PARK is being invoked.

The cpickupNotify.Indication primitive is used to indicate retrieval from a local SS-PARK.

#### 10.2.2.3 Parameter definition

cpRequest.Indication parameters: Refer to corresponding primitive in 10.2.1.

cpRequest.Response (ack and rej) parameters: Refer to corresponding primitive in 10.2.1.

cpSetup.Request parameters:

- parkingNumber;
- parkedNumber;
- parkedToNumber;
- parkedToPosition;
- extensionArg.

cpSetupConfirm (ack and rej) parameters:

- parkedToNumber;
- parkedToPosition;
- parkCondition;
- extensionRes;
- notAvailable (\_rej);
- invalidCallState (\_rej);
- resourceUnavailable (\_rej);
- supplementaryServiceInteractionNotAllowed (\_rej);
- undefined (\_rej).

pickup.Indication parameters:

- callPickupId;
- picking-upNumber;
- extensionArg.

pickup.Response (ack and rej) parameters:

- extensionRes: Placeholder for manufacturer specific information;
- undefined (\_rej);
- callAlreadyPickedUp (\_rej).

pickExe.Request parameters:

- callPickupId: Identifier of the call to be picked up (equals the value of the CallIdentifier as assigned for the parked/alerting call within the Setup-UUIE);
- picking-upNumber: Alias of the picking-up party;
- partyToRetrieve: Alias of the parked/calling party;
- extensionArg: Placeholder for manufacturer specific information.

pickExe.Confirm (ack and rej) parameters:

- extensionRes: Placeholder for manufacturer specific information;
- undefined (\_rej);
- callPickupIdInvalid (\_rej).

cpNotify.Indication: Refer to corresponding primitive in 10.2.1.

cpickupNotify.Indication: Refer to corresponding primitive in 10.2.1

## 10.2.3 Parked-To endpoint

### 10.2.3.1 Table of primitives

See Table 3.

**Table 3/H.450.5 – Primitives at the Parked-To endpoint**

Generic name	Type			
	Request (req)	Indication (ind)	Response (resp)	Confirm (conf)
cpSetup	Not defined	PARAMETERS	PARAMETERS	Not defined
pickrequ	Not defined	PARAMETERS	PARAMETERS	Not defined
pickup	PARAMETERS	Not defined	Not defined	–
NOTE – "-" means no parameters (manufacturer specific parameters may apply).				

### 10.2.3.2 Primitive definition

The cpSetup.Indication primitive is used to indicate parked call establishment to the Parked-to User.

The cpSetup.Response primitive is used to trigger either a **cpSetup** Return Result or **cpSetup** Return Error APDU being sent to the parked endpoint.

The pickrequ.Indication primitive is used to indicate a remote request for SS-PICKUP.

The pickup.Request primitive is used to request sending a pickup.inv APDU to the parked endpoint. This primitive may be triggered by a local user or by a pickrequ.inv APDU received by a remote picking-up endpoint.

The pickup.Confirm primitive is used to report the outcome of the pickup.inv procedure.

The pickrequ.Response primitive is used to request sending of a **pickrequ** Return Result or **pickrequ** Return Error APDU to the remote picking-up endpoint.

### 10.2.3.3 Parameter definition

cpSetup.Indication parameters: Refer to corresponding primitive in 10.2.2.

cpSetup.Response (ack and rej) parameters: Refer to corresponding primitive in 10.2.2.

pickrequ.Indication parameters:

- picking-upNumber: Alias of the Picking-up User;
- callPickupId: CallIdentifier value of the parked/alerting call to be picked up;
- partyToRetrieve: Parked/Calling User;
- retrieveAddress: parked-to/alerting entity address;
- parkPosition: explicit identifier of park position;
- extensionArg: Placeholder for manufacturer specific extensions.

pickup.Request parameters: Refer to 10.2.2.

pickup.Confirm (ack and rej) parameters: Refer to 10.2.2.

pickrequ.Response (ack and rej) parameters:

- callPickupId: CallIdentifier value of the parked/alerting call being picked up;
- extensionRes: Placeholder for manufacturer specific extensions;
- undefined (\_rej);
- callAlreadyPickedUp (\_rej).

## 10.2.4 Picking-up endpoint

### 10.2.4.1 Table of primitives

See Table 4.

**Table 4/H.450.5 – Primitives at Group member endpoint**

Generic name	Type			
	Request (req)	Indication (ind)	Response (resp)	Confirm (conf)
pickrequ	PARAMETERS	Not defined	Not defined	PARAMETERS
pickExe	Not defined	PARAMETERS	–	Not defined

NOTE – "-" means no parameters (manufacturer specific parameters may apply).

### 10.2.4.2 Primitive definition

The pickrequ.Request primitive is used to request SS-PICKUP.

The pickrequ.Confirm primitive is used to indicate the successful or unsuccessful outcome of SS-PICKUP.

The pickExe.Indication primitive is used to indicate call establishment as part of the SS-PICKUP procedures to the Picking-up User.

The pickExe.Response primitive is used to inform the Picking-up User about the successful/unsuccessful outcome of the SS-PICKUP and to trigger a **pickExe** Return Result or **pickExe** Return Error APDU being sent to the parked/calling endpoint.

### 10.2.4.3 Parameter definition

pickrequ.Request parameters: Refer to corresponding primitive in 10.2.3.

pickrequ.Confirm (ack and rej) parameters: Refer to corresponding primitive in 10.2.3.

pickExe.Indication parameters: Refer to corresponding primitive in 10.2.2.

pickExe.Response (ack and rej) parameters: Refer to corresponding primitive in 10.2.2.

## 10.2.5 Calling endpoint

### 10.2.5.1 Table of primitives

See Table 5.

**Table 5/H.450.5 – Primitives at the Calling endpoint**

Generic name	Type			
	Request (req)	Indication (ind)	Response (resp)	Confirm (conf)
pickup	Not defined	PARAMETERS	–	Not defined
pickExe	PARAMETERS	Not defined	Not defined	–

NOTE – "-" means no parameters (manufacturer specific parameters may apply).

### 10.2.5.2 Primitive definition

The pickup.Indication primitive is used to indicate SS-PICKUP being requested.

The pickup.Response (\_ack or \_rej) primitive acknowledges or rejects SS-PICKUP request.



The pickExe.Request primitive is used to initiate new call establishment to the picking-up endpoint. This primitive is triggered by the pickup.Response\_ack primitive.

The pickExe.Confirm primitive is used to indicate the successful or unsuccessful outcome of the new call establishment as part of SS-PICKUP.

### 10.2.5.3 Parameter definition

pickup.Indication parameters: Refer to corresponding primitive in 10.2.2.

pickup.Response (ack and rej) parameters: Refer to corresponding primitive in 10.2.2.

pickExe.Request parameters: Refer to corresponding primitive in 10.2.2.

pickExe.Confirm (ack and rej) parameters: Refer to corresponding primitive in 10.2.2.

## 10.2.6 Alerting endpoint

### 10.2.6.1 Table of primitives

See Table 6.

**Table 6/H.450.5 – Primitives at the Alerting endpoint**

Generic name	Type			
	Request (req)	Indication (ind)	Response (resp)	Confirm (conf)
pickrequ	Not defined	PARAMETERS	PARAMETERS	Not defined
pickup	PARAMETERS	Not defined	Not defined	–
NOTE – "-" means no parameters (manufacturer specific parameters may apply).				

### 10.2.6.2 Primitive definition

The pickrequ.Indication primitive is used to indicate a remote request for SS-PICKUP.

The pickup.Request primitive is used to request sending a pickup.inv APDU to the calling endpoint. This primitive may be triggered by a local user or by a pickrequ.inv APDU received by a remote picking-up endpoint.

The pickup.Confirm primitive is used to report the outcome of the pickup.inv procedure.

The pickrequ.Response primitive is used to request the sending of a **pickrequ** Return Result or **pickrequ** Return Error APDU to the remote picking-up endpoint.

### 10.2.6.3 Parameter definition

pickrequ.Indication parameters: Refer to corresponding primitive in 10.2.3.

pickup.Request parameters: Refer to corresponding primitive in 10.2.3.

pickup.Confirm (ack and rej) parameters: Refer to corresponding primitive in 10.2.3.

pickrequ.Response (ack and rej) parameters: Refer to corresponding primitive in 10.2.3.

## 10.2.7 Served endpoint

### 10.2.7.1 Table of primitives

See Table 7.

**Table 7/H.450.5 – Primitives at the Served endpoint**

Generic name	Type			
	Request (req)	Indication (ind)	Response (resp)	Confirm (conf)
groupIndicationOn	PARAMETERS	Not defined	Not defined	–
groupIndicationOff	PARAMETERS	Not defined	Not defined	–
NOTE – "-" means no parameters (manufacturer specific parameters may apply).				

### 10.2.7.2 Primitive definition

The groupIndicationOn.Request primitive is used to inform group members about a call to be picked-up (applies to group park as well as to SS-PICKUP of an alerting call).

The groupIndicationOn.Confirm (ack or rej) primitive is used to report the outcome of the group notification to the served endpoint.

The groupIndicationOff.Request primitive is used to inform the group members that a previously offered call has already been picked up.

The groupIndicationOff.Confirm primitive is used to indicate the outcome of the groupIndicationOff.inv procedure.

### 10.2.7.3 Parameter definition

groupIndicationOn.Request parameters:

- callPickupId: Identifier of the call to be retrieved (equals H.225.0 CallIdentifier value);
- groupMemberUserNr: Alias number of the group member user;
- retrieveCallType: parked or alerting call to be retrieved;
- partyToRetrieve: Alias of the Parked/Calling User;
- retrieveAddress: Alias of the Parked-to/Alerting User;
- parkPosition: Identifier of the park position;
- extensionArg: Placeholder for manufacturer specific extensions.

groupIndicationOn.Confirm (ack and rej) parameters:

- extensionRes: Placeholder for manufacturer specific extensions;
- undefined (\_rej).

groupIndicationOff.Request parameters:

- callPickupId: Identifier of the call that is no longer offered to be retrieved (equals H.225.0 CallIdentifier value);
- groupMemberUserNr: Alias of the group member;
- extensionArg: Placeholder for manufacturer specific extensions.

groupIndicationOff.Confirm (ack and rej) parameters:

- extensionArg: Placeholder for manufacturer specific extensions;
- invalidCallState (\_rej);
- undefined (\_rej).

## 10.2.8 Group Member endpoint

### 10.2.8.1 Table of primitives

See Table 8.

**Table 8/H.450.5 – Primitives at Group member endpoint**

Generic name	Type			
	Request (req)	Indication (ind)	Response (resp)	Confirm (conf)
groupIndicationOn	Not defined	PARAMETERS	–	Not defined
groupIndicationOff	Not defined	PARAMETERS	–	Not defined
NOTE – "-" means no parameters (manufacturer specific parameters may apply).				

### 10.2.8.2 Primitive definition

The groupIndicationOn.Indication primitive is used to inform group members about a call to be picked-up (applies to group park as well as to SS-PICKUP of an alerting call).

The groupIndicationOn.Response (ack or rej) primitive is used to report the outcome of the group notification to the served endpoint.

The groupIndicationOff.Indication primitive is used to inform the group members that a previously offered call has been picked up.

The groupIndicationOff.Response primitive is used to indicate the outcome of the groupIndicationOff.inv procedure.

### 10.2.8.3 Parameter definition

groupIndicationOn.Indication parameters: Refer to corresponding primitive in 10.2.7.

groupIndicationOn.Response (ack and rej) parameters: Refer to corresponding primitive in 10.2.7.

groupIndicationOff.Indication parameters: Refer to corresponding primitive in 10.2.7.

groupIndicationOff.Response (ack and rej) parameters: Refer to corresponding primitive in 10.2.7.

## 10.3 Call States

### 10.3.1 Parking Endpoint A

CP-Idle: SS-PARK is not invoked.

CP-Requested: SS-PARK has been requested; waiting for confirmation from the parked endpoint.

### 10.3.2 Parked Endpoint B

CP-Idle: SS-PARK is not invoked.

CP-SetupReq: SS-PARK has been requested; the parking endpoint is waiting for confirmation from the parked-to endpoint.

CpickupSetupInit: The parked endpoint has sent a new SETUP with a **pickExe** invoke APDU to the picking-up endpoint and is waiting for a result.

### 10.3.3 Parked-To Endpoint (Parking Position)

CP-Idle: Call Park is not in progress.

CP-WaitforPickup: A call is successfully parked. The parked call is waiting to be unparked (group member notifications may or may not have been sent).

CP-NotifiedWaitforPickup: A call has been parked locally. The parked call is waiting to be unparked (group member notifications may or may not have been sent).

CpickupIdle: Call Pickup of the parked call is not in progress.

CpickupRequested: SS-PICKUP has been requested by a local Picking-up User; waiting for a response from the parked endpoint.

CpickupRemoteRequested: SS-PICKUP has been requested by a remote Picking-up User; waiting for a response from the parked endpoint.

### 10.3.4 Calling endpoint

CpickupIdle: SS-PICKUP is not in progress.

CpickupSetupInit: The calling endpoint has sent a new SETUP with a **pickExe** invoke APDU to the picking-up endpoint and is waiting for a result.

### 10.3.5 Alerting endpoint

CpickupIdle

WaitforPickup: A call alerts the Alerting User, and is waiting to be picked-up.

CpickupRequested: SS-PICKUP has been requested (locally), waiting for a response from the calling endpoint.

CpickupRemoteRequested: SS-PICKUP of alerting call has been requested by a remote Picking-up User; waiting for response from the calling endpoint.

### 10.3.6 Served endpoint

GP-Idle

GP-NotifyOnRequ: The served endpoint is waiting for a confirmation to the **groupIndicationOn** Invoke APDU.

GP-NotifyOffRequ: The served endpoint is waiting for a confirmation to the **groupIndicationOff** Invoke APDU.

### 10.3.7 Group member endpoint

No specific call states applicable.

### 10.3.8 Picking-up Endpoint

CpickupIdle

CpickupRemoteRequested: The picking-up endpoint is waiting for response from the parked-to/alerting endpoint.

CpickupWaitSetup: The picking-up endpoint is waiting for the new call establishment from the parked/calling endpoint.

## 10.4 Timers

T1 – shall operate in the parking endpoint during state CP-Requested. Its purpose is to protect against failure to establish the new connection (parked call).

T2 – may operate in the parked endpoint during state CP-SetupRequ. Its purpose is to protect against failure during establishment of the parked call. T2 may replace (or influence the value) of the H.225.0 timer T303 running as part of the H.225.0 SETUP message being sent.

T3 – shall operate in the parked-to endpoint during states CP-WaitforPickup and CP-NotifiedWaitforPickup. Its purpose is to protect the parked call against not being picked up for a given period of time.

T4 – shall operate in the served endpoint during state GP-NotifyOnRequ. Its purpose is to protect against not receiving any response from a Pickup Group member endpoint.

T5 – shall operate in the served endpoint during state GP-NotifyOffRequ. Its purpose is to protect against not receiving any response from a Pickup Group member endpoint.

T6 – shall operate in the parked-to/alerting endpoint during state CpickupRequested. Its purpose is to protect against not receiving any response from the parked/calling endpoint.

T7 – shall operate in the picking-up endpoint (which is remote to the parked-to/alerting endpoint). Its purpose is to protect against not receiving any response from the Parked-to/Alerting User.

T8 – shall operate in the picking-up endpoint while in state CpickupWaitSetup. Its purpose is to protect against call establishment failure of the new call between the parked/calling endpoint and the picking-up endpoint.

T9 – shall operate in the parked-to endpoint while in state CpickupRemoteRequested. Its purpose is to protect against not receiving a response from the parked endpoint.

T10 – shall operate in the parked or calling endpoint while in state CpickupSetupInit. Its purpose is to protect against call failure during the new call establishment.

## 11 Operation in Support of SS-PARK and SS-PICKUP

### Call-Park-Pickup-Operations

{itu-t recommendation h 450 5 version1(0) call-park-pickup-operations(0)}

DEFINITIONS AUTOMATIC TAGS ::=

BEGIN

IMPORTS OPERATION, ERROR FROM Remote-Operations-Information-Objects

{joint-iso-itu-t remote-operations (4) informationObjects (5)  
version1(0) }

EXTENSION, Extension { } FROM Manufacturer-specific-service-extension-definition  
{ itu-t recommendation h 450 1 version1(0) msi-definition(18)}

notAvailable, invalidCallState, resourceUnavailable,

supplementaryServiceInteractionNotAllowed FROM H4501-General-Error-List

{ itu-t recommendation h 450 1 version1(0) general-error-list (1) }

EndpointAddress FROM Addressing-Data-Elements

{itu-t recommendation h 450 1 version1(0) addressing-data-elements(9)}

MixedExtension FROM Call-Hold-Operations

{itu-t recommendation h 450 4 version1(0) call-hold-operations(0)}

NonStandardParameter, CallIdentifier FROM H323-MESSAGES; -- see H.225.0

CallParkPickupOperations OPERATION ::=

{cpRequest | cpSetup | groupIndicationOn | groupIndicationOff | pickrequ | pickup | pickExe | cpNotify |  
cpickupNotify }

cpRequest OPERATION ::=

{ -- sent from parking endpoint to the parked endpoint to invoke SS-PARK

ARGUMENT CpRequestArg

RESULT CpRequestRes

ERRORS { notAvailable |

-- feature not available in combination with the basic service

invalidCallState | -- call park not possible in current call state

resourceUnavailable | -- maximum number of parked calls reached

supplementaryServiceInteractionNotAllowed |

-- other supplementary service prohibits call park invocation

undefined -- undefined reason

}

CODE local: 106 }

CpRequestArg ::= SEQUENCE

{parkingNumber EndpointAddress,

parkedNumber EndpointAddress,

parkedToNumber EndpointAddress,

```

    parkedToPosition      ParkedToPosition  OPTIONAL,
    extensionArg          SEQUENCE SIZE (0..255) OF MixedExtension OPTIONAL,
    ... }

CpRequestRes ::= SEQUENCE
{parkedToNumber          EndpointAddress,
 parkedToPosition      ParkedToPosition  OPTIONAL,
 parkCondition          ParkCondition,
 extensionRes          SEQUENCE SIZE (0..255) OF MixedExtension OPTIONAL,
 ...}

cpSetup          OPERATION      ::=
{ -- sent from parked endpoint to the parked-to endpoint
 ARGUMENT        CpSetupArg
 RESULT          CpSetupRes
 ERRORS {        notAvailable |
                -- feature not available in combination with the basic service
                invalidCallState | -- call park not possible in current call state
                resourceUnavailable | -- maximum number of parked calls reached
                supplementaryServiceInteractionNotAllowed |
                -- other supplementary service prohibits call park invocation
                undefined -- undefined reason
        }
}
CODE            local: 107 }

CpSetupArg ::= SEQUENCE
{parkingNumber          EndpointAddress,
 parkedNumber           EndpointAddress,
 parkedToNumber         EndpointAddress,
 parkedToPosition      ParkedToPosition  OPTIONAL,
 extensionArg          SEQUENCE SIZE (0..255) OF MixedExtension OPTIONAL,
 ... }

CpSetupRes ::= SEQUENCE
{parkedToNumber          EndpointAddress,
 parkedToPosition      ParkedToPosition  OPTIONAL,
 parkCondition          ParkCondition,
 extensionRes SEQUENCE SIZE (0..255) OF MixedExtension OPTIONAL,
 ...}

groupIndicationOn OPERATION      ::=
{ -- sent from the parked-to endpoint/alerting endpoint to the group members
 ARGUMENT        GroupIndicationOnArg
 RESULT          GroupIndicationOnRes
 ERRORS {undefined -- undefined reason
        }
}
CODE            local: 108 }

GroupIndicationOnArg ::= SEQUENCE {
 callPickupId CallIdentifier,
 -- identification of the call to be retrieved (parked or alerting call);
 -- its value equals the value of the CallIdentifier as assigned for the parked/
 -- alerting call within Setup-UUIE
 groupMemberUserNr  EndpointAddress,
 retrieveCallType    CallType,
 partyToRetrieve     EndpointAddress, -- Parked or Calling User
 retrieveAddress     EndpointAddress, -- parked-to or alerting entity address
 -- (may also be a GK, see 9.2)
 parkPosition       ParkedToPosition  OPTIONAL,
 extensionArg       SEQUENCE SIZE (0..255) OF MixedExtension OPTIONAL,
 ...}

```

```

GroupIndicationOnRes ::= SEQUENCE
  {extensionRes          SEQUENCE SIZE (0..255) OF MixedExtension OPTIONAL,
  ...}

groupIndicationOff OPERATION ::=
  { -- sent from the parked-to endpoint/alerting endpoint to the group members
  ARGUMENT      GroupIndicationOffArg
  RESULT        GroupIndicationOffRes
  ERRORS {
    invalidCallState | -- group indication is not on
    undefined        -- undefined reason
  }
  CODE          local: 109 }

GroupIndicationOffArg ::= SEQUENCE {
  callPickupId      CallIdentifier,
  -- identification of the call that has been picked up (parked or alerting call)
  groupMemberUserNr EndpointAddress,
  extensionArg      SEQUENCE SIZE (0..255) OF MixedExtension OPTIONAL,
  ...}

GroupIndicationOffRes ::= SEQUENCE
  {extensionRes          SEQUENCE SIZE (0..255) OF MixedExtension OPTIONAL,
  ...}

pickrequ OPERATION ::=
  { -- sent from the picking-up user to the parked-to/
  -- alerting endpoint as part of the SS-PICKUP invocation
  ARGUMENT      PickrequArg
  RESULT        PickrequRes
  ERRORS {
    undefined | -- undefined reason
    callAlreadyPickedUp -- call has already been picked up by another user
  }
  CODE          local: 110 }

PickrequArg ::= SEQUENCE
  {picking-upNumber      EndpointAddress,
  callPickupId          CallIdentifier OPTIONAL,
  -- identification of the call to be picked up (parked or alerting call), if known
  partyToRetrieve       EndpointAddress OPTIONAL, -- Parked or Calling User
  retrieveAddress       EndpointAddress, -- parked-to or alerting entity address
  parkPosition         ParkedToPosition OPTIONAL,
  extensionArg         SEQUENCE SIZE (0..255) OF MixedExtension OPTIONAL,
  ...}

PickrequRes ::= SEQUENCE
  {callPickupId          CallIdentifier,
  -- identification of the call that is being picked up (parked or alerting call),
  -- if not sent in pickrequ invoke, it is assigned at the parked-to/alerting
  -- endpoint and reflects the CallIdentification of the parked/alerting call for
  -- later association with the pickExe invoke APDU.
  extensionRes SEQUENCE SIZE (0..255) OF MixedExtension OPTIONAL,
  ...}

pickup OPERATION ::=
  { -- sent from the parked-to/alerting endpoint to the parked/calling endpoint
  -- after the picking-up user has invoked SS-PICKUP. The picking-up user may
  -- be local (i.e. parked-to/alerting endpoint equals picking-up
  -- endpoint) or may be remote (i.e. picking-up user is located at a
  -- remote picking-up endpoint having sent pickrequ invoke APDU to the
  -- parked-to/alerting endpoint).

```

```

ARGUMENT      PickupArg
RESULT        PickupRes
ERRORS {
    undefined | -- undefined reason
    callAlreadyPickedUp -- call has already been picked up by another user
}
CODE      local: 111 }

```

```

PickupArg ::= SEQUENCE
  {callPickupId      CallIdentifier,
  -- identification of this call to be picked up (parked or alerting call);
  -- equals the CallIdentifier value that was assigned to this call in Setup-UUIE
  picking-upNumber   EndpointAddress,
  extensionArg       SEQUENCE SIZE (0..255) OF MixedExtension OPTIONAL,
  ...}

```

```

PickupRes ::= SEQUENCE
  {extensionRes      SEQUENCE SIZE (0..255) OF MixedExtension OPTIONAL,
  ...}

```

```

pickExe      OPERATION ::=
  { -- sent from the parked/calling endpoint to the picking-up endpoint
ARGUMENT      PickExeArg
RESULT        PickExeRes
ERRORS {
    undefined | -- undefined reason
    callPickupIdInvalid
    -- value not matching with the previous SS-PICKUP request
}
CODE      local: 112 }

```

```

PickExeArg ::= SEQUENCE
  {callPickupId      CallIdentifier,
  -- identification of the parked/alerting call to be picked-up;
  -- required at picking-up endpoint to associate the SS-PICKUP invoked with this
  -- incoming setup message carrying the pickExe invoke APDU.
  picking-upNumber   EndpointAddress,
  partyToRetrieve    EndpointAddress, -- Parked or Calling User
  extensionArg       SEQUENCE SIZE (0..255) OF MixedExtension OPTIONAL,
  ...}

```

```

PickExeRes ::= SEQUENCE
  {extensionRes      SEQUENCE SIZE (0..255) OF MixedExtension OPTIONAL,
  ...}

```

```

cpNotify     OPERATION ::=
  { -- sent from the parking-to to parked endpoint in case of local park.
ARGUMENT      CpNotifyArg      OPTIONAL TRUE
RETURN RESULT      FALSE
ALWAYS RESPONDS    FALSE
CODE      local: 113 }

```

```

CpNotifyArg ::= SEQUENCE
  {parkingNumber     EndpointAddress      OPTIONAL,
  extensionArg       SEQUENCE SIZE (0..255) OF MixedExtension OPTIONAL,
  ...}

```

```

cpickupNotify OPERATION ::=
  { -- sent from parked-to to parked endpoint in case of SS-PICKUP from local park
ARGUMENT      CpickupNotifyArg  OPTIONAL TRUE
RETURN RESULT      FALSE
ALWAYS RESPONDS    FALSE
CODE      local: 114
}

```



```

CpickupNotifyArg ::= SEQUENCE
    {picking-upNumber      EndpointAddress      OPTIONAL,
     extensionArg          SEQUENCE SIZE (0..255) OF MixedExtension OPTIONAL,
     ... }

ParkedToPosition ::= INTEGER (0..65535)

ParkCondition ::= ENUMERATED {
    unspecified (0),
    parkedToUserIdle (1),
    parkedToUserBusy (2),
    parkedToGroup (3),
    ...}

CallType ::= ENUMERATED {
    parkedCall (0),
    alertingCall (1),
    ...}

callPickupIdInvalid      ERROR ::=
    { CODE                local: 2000}

callAlreadyPickedUp      ERROR ::=
    { CODE                local: 2001}

undefined ERROR ::=
    { PARAMETER          SEQUENCE SIZE (0..255) OF MixedExtension OPTIONAL TRUE
      CODE              local:2002 }

END -- of Call-Park-Pickup-Operations

```

## 12 Specification and Description Language (SDL) Diagrams

The procedures for SS-PARK and SS-PICKUP signalling entities are described in SDL form in Figures 14 to 28.

The SDLs only show SS-PARK and SS-PICKUP messages transported on an H.225.0 reliable connection. H.245 procedures (e.g. terminal capability exchange, master/slave determination, opening and closing of logical channels, etc.) are not shown.

ROSE APDUs sent via the network are indicated using bold letters with the following abbreviations:

- ( **.inv**)     Invoke APDU
- ( **.rr**)     Return Result APDU
- ( **.re**)     Return Error APDU
- ( **.rej**)    Reject APDU

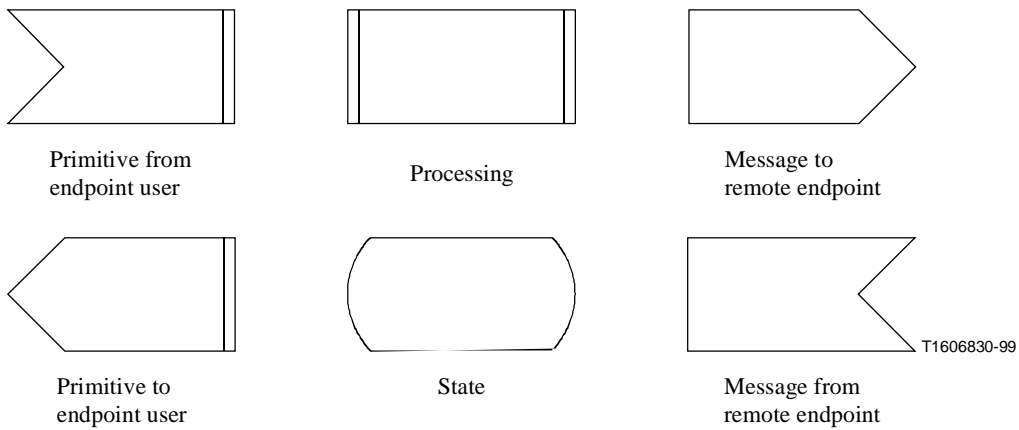
For primitives and their meaning refer to 10.2.

The SDLs describe the procedures as defined by subclauses 7.1 to 7.8. SDLs for alternative procedures as well as gatekeeper SDLs are not provided.

In case of a conflict between these SDLs and the text within the previous clauses, the text shall take precedence.

Since the procedures for SS-PICKUP of a parked call and the procedures for SS-PICKUP of an alerting call are almost identical, those SDLs have been combined. In many cases, only the name of the supplementary service call state differs between both applications – and is indicated by means of the following syntax within the SDL state symbol: "state applicable to SS-PICKUP of parked call/state applicable to SS-PICKUP of an alerting call".

The symbols used in the following SDLs are defined in Figure 13.



**Figure 13/H.450.5 – SDL symbols**

### **Overview of SDLs**

Figures 14-17: SS-PARK for Parking. Parked and Parked-To endpoints

Figures 18-19: SS-PICKUP for Picking-Up endpoint (applies to call pickup of a parked as well as to call pickup of an alerting call)

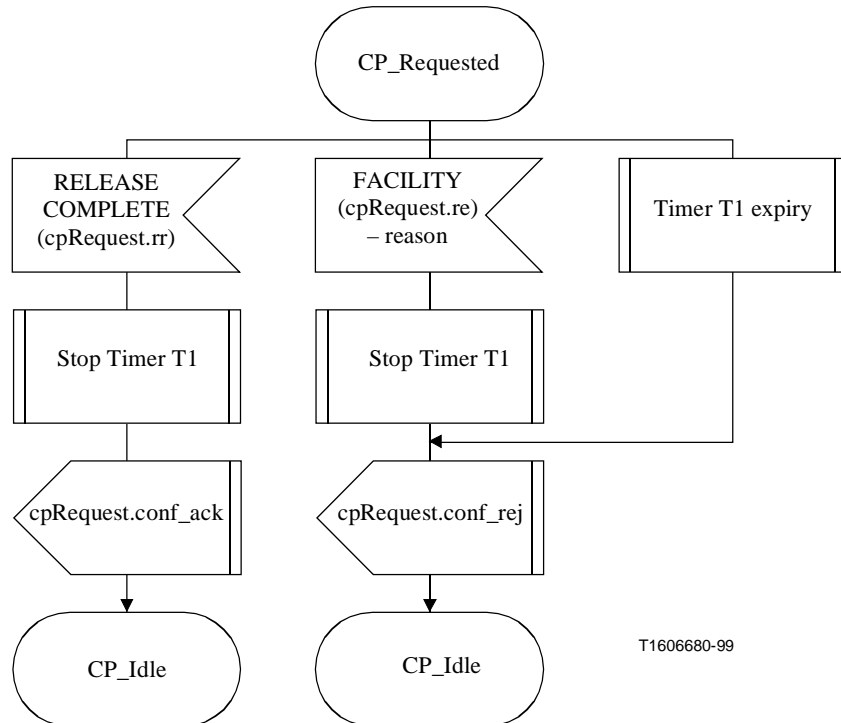
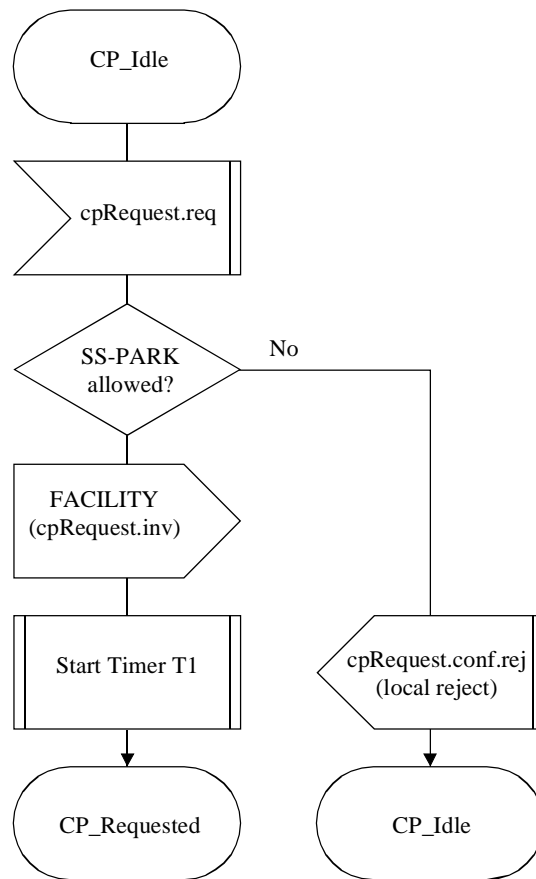
Figures 20-23: SS-PICKUP for Parked-To/Alerting endpoint.

Figures 24-25: SS-PICKUP for Parked/Calling endpoint.

Figures 26-28: Group member notification for Served and Group member endpoint (applies to call pickup of a parked call as well as to call pickup of an alerting call).

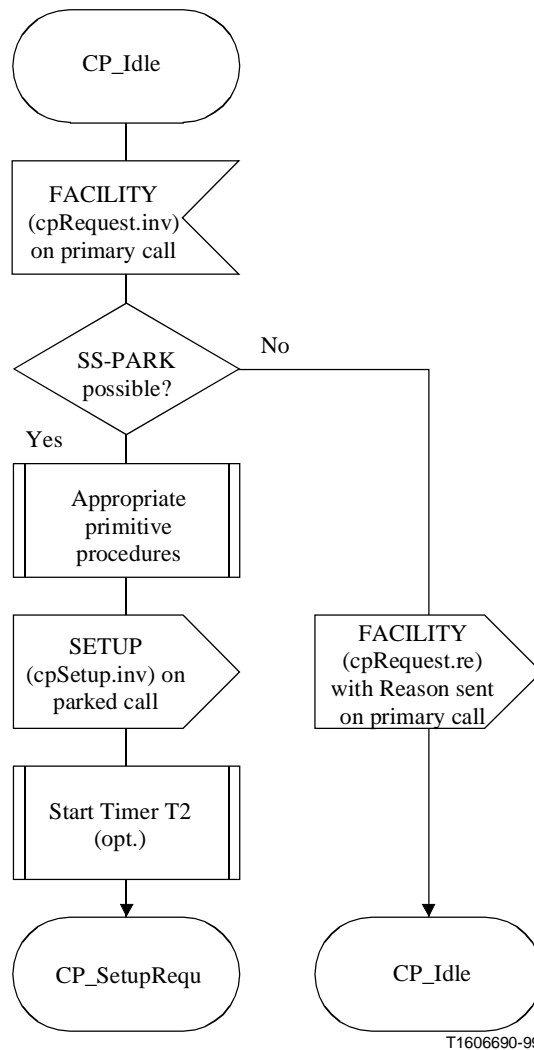
### **12.1 SS-PARK SDLs**

See Figures 14 to 17.



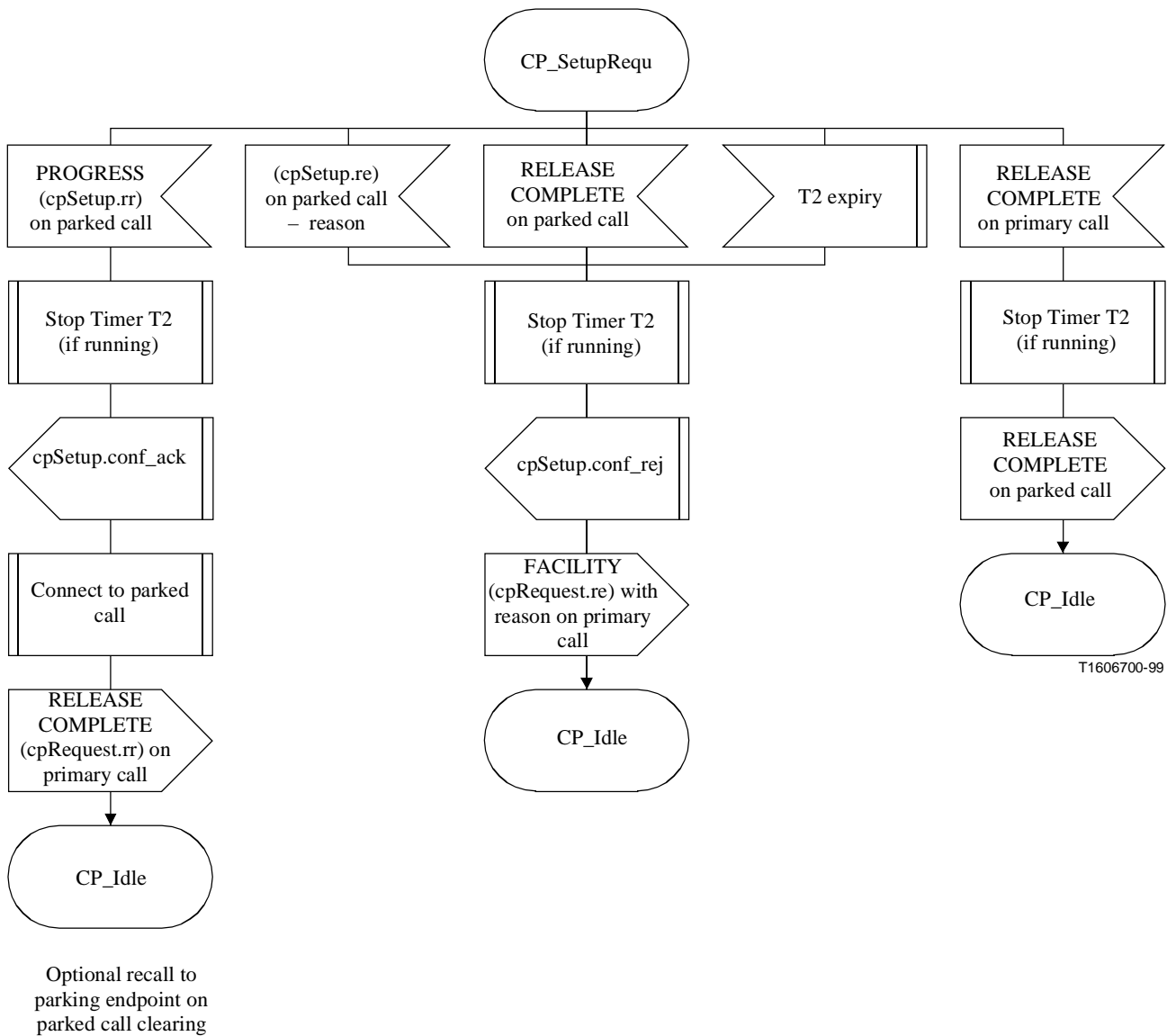
T1606680-99

**Figure 14/H.450.5 – SS-PARK – Parking endpoint SDLs**

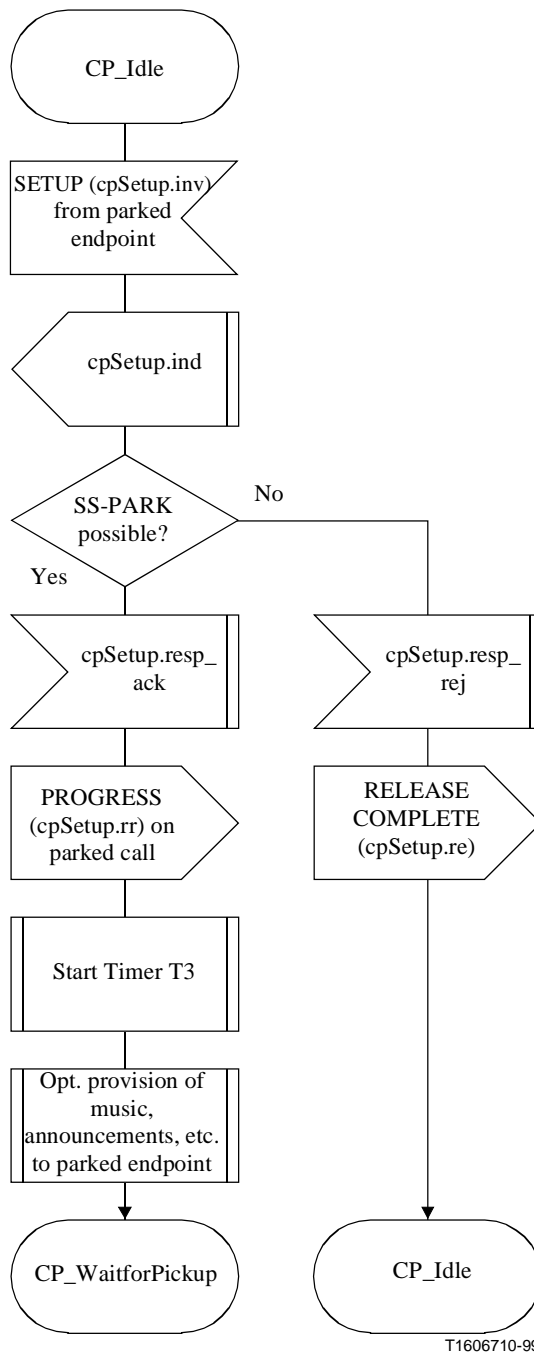


T1606690-99

Figure 15/H.450.5 – SS-PARK – Parked endpoint SDLs (sheet 1 of 2)



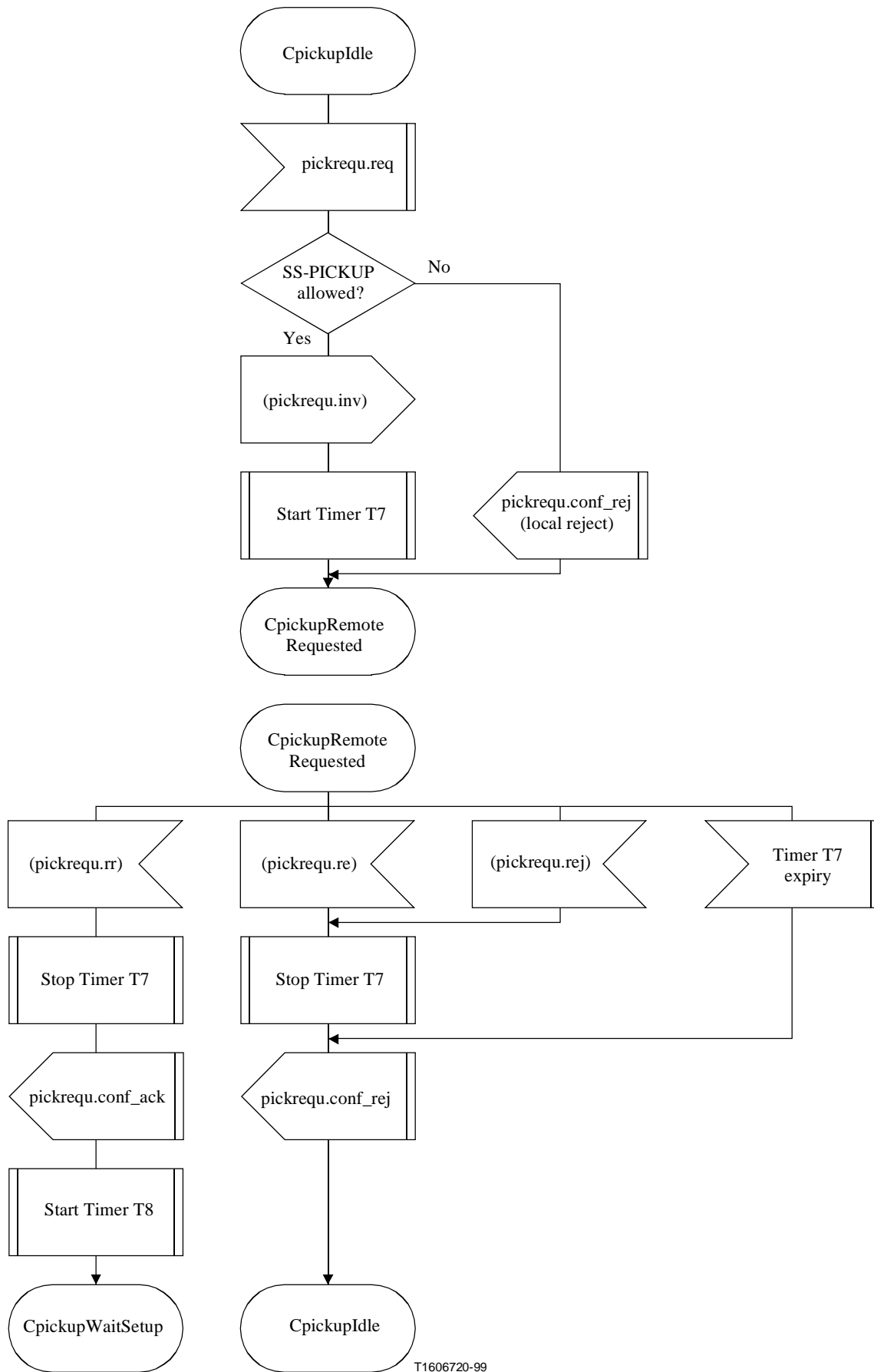
**Figure 16/H.450.5 – SS-PARK – Parked endpoint SDLs (sheet 2 of 2)**



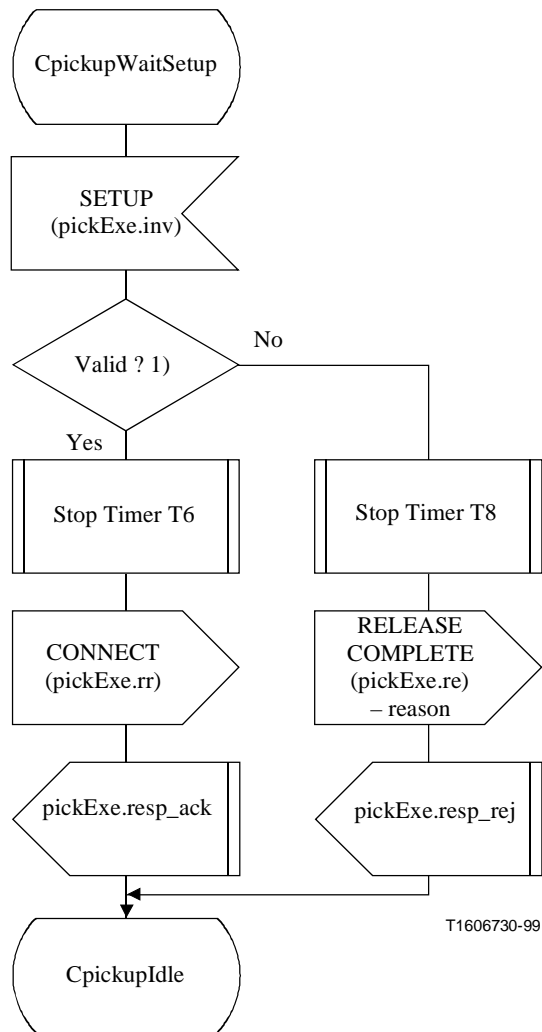
**Figure 17/H.450.5 – SS-PARK – Parked-To endpoint SDLs**

**12.2 SS-PICKUP SDLs**

See Figures 18 to 25.



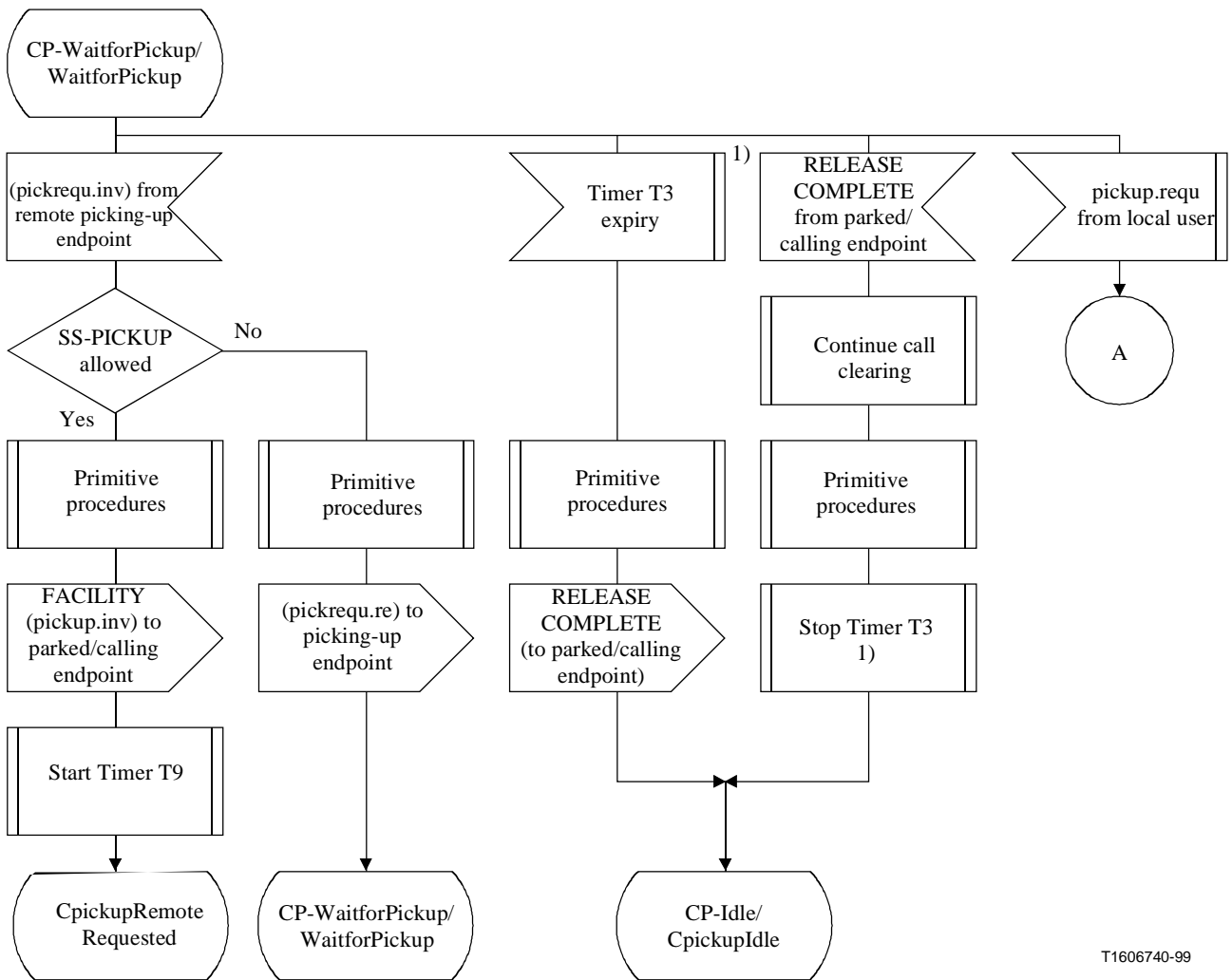
**Figure 18/H.450.5 – SS-PICKUP (of parked or alerting call) – Picking-up endpoint SDLs (sheet 1 of 2)**



NOTE 1 – Matching callPickupId values?

**Figure 19/H.450.5 – SS-PICKUP (of parked or alerting call) – Picking-up endpoint SDLs (sheet 2 of 2)**

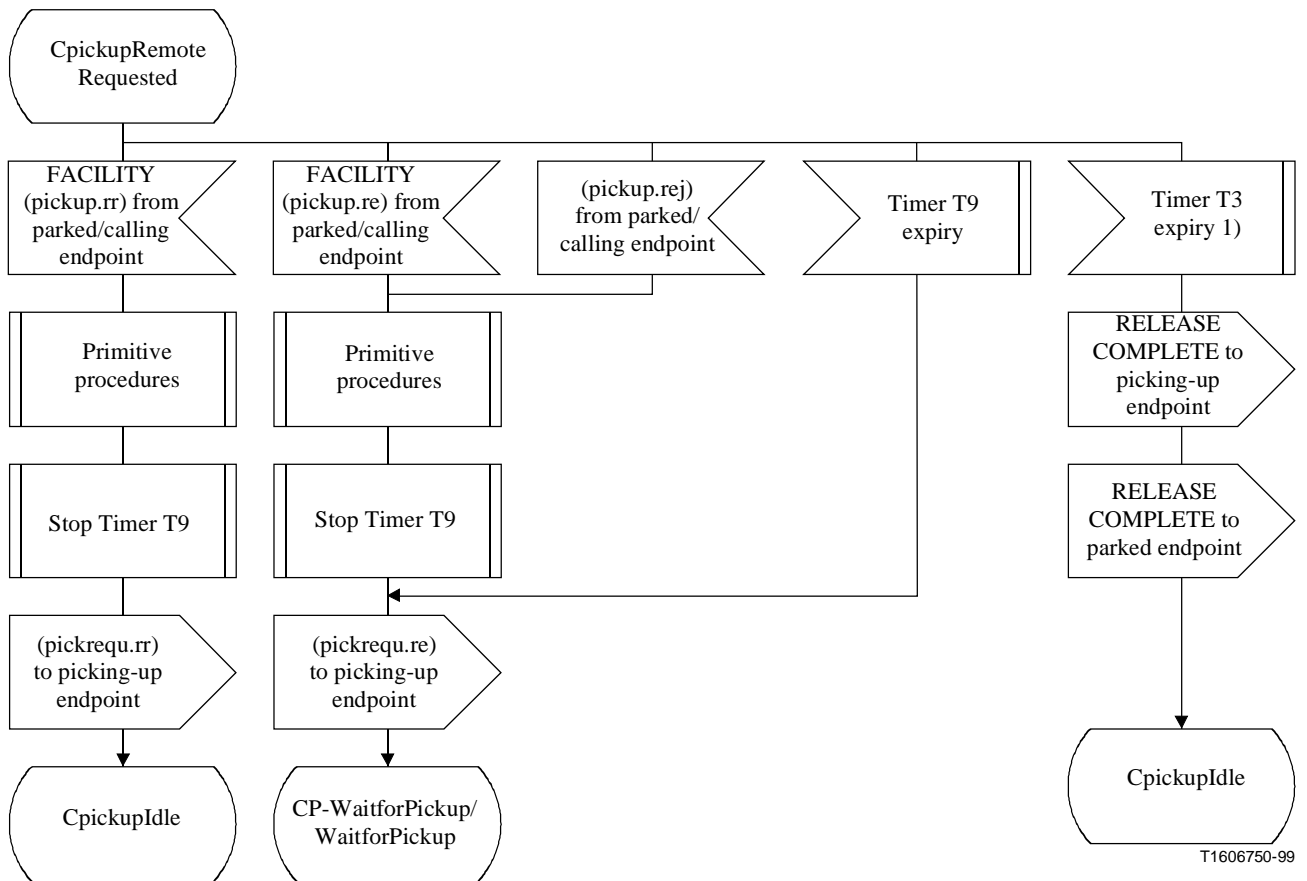




T1606740-99

NOTE 1 – Only applicable for SS-PICKUP of parked call.

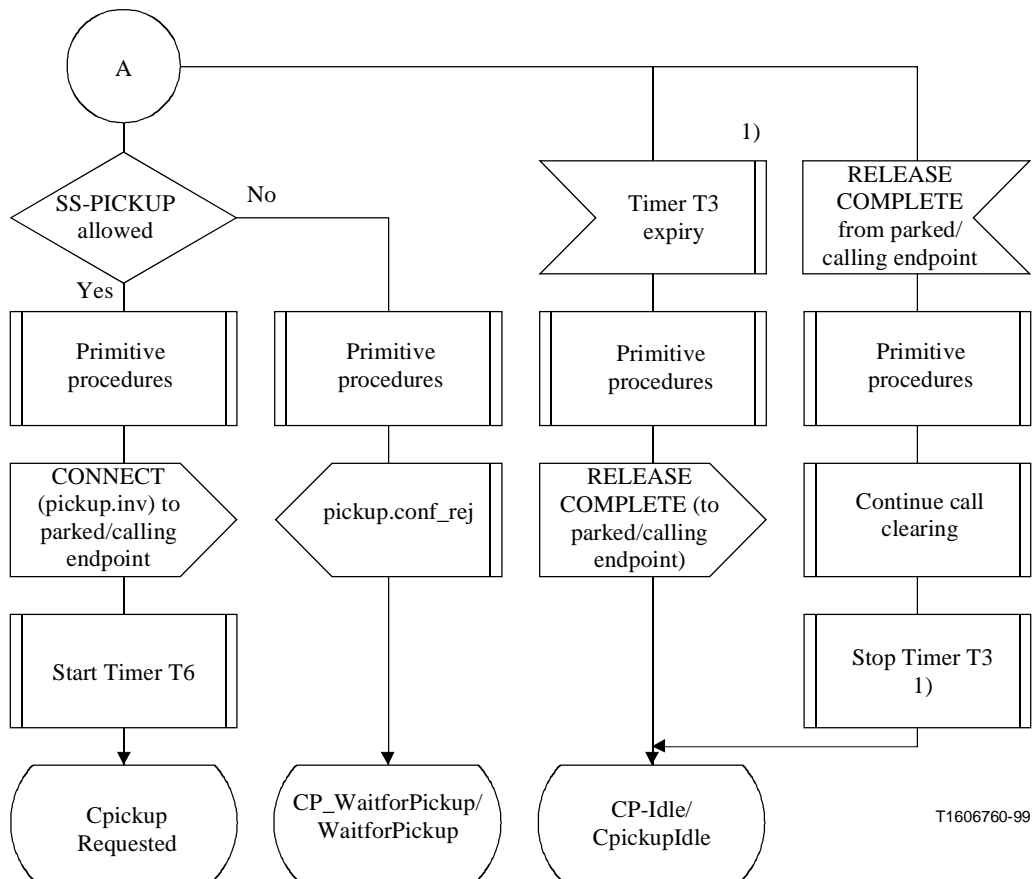
**Figure 20/H.450.5 – SS-PICKUP – Parked-To/Alerting endpoint SDLs (sheet 1 of 4)**



T1606750-99

NOTE 1 – Only applicable for SS-PICKUP of parked call.

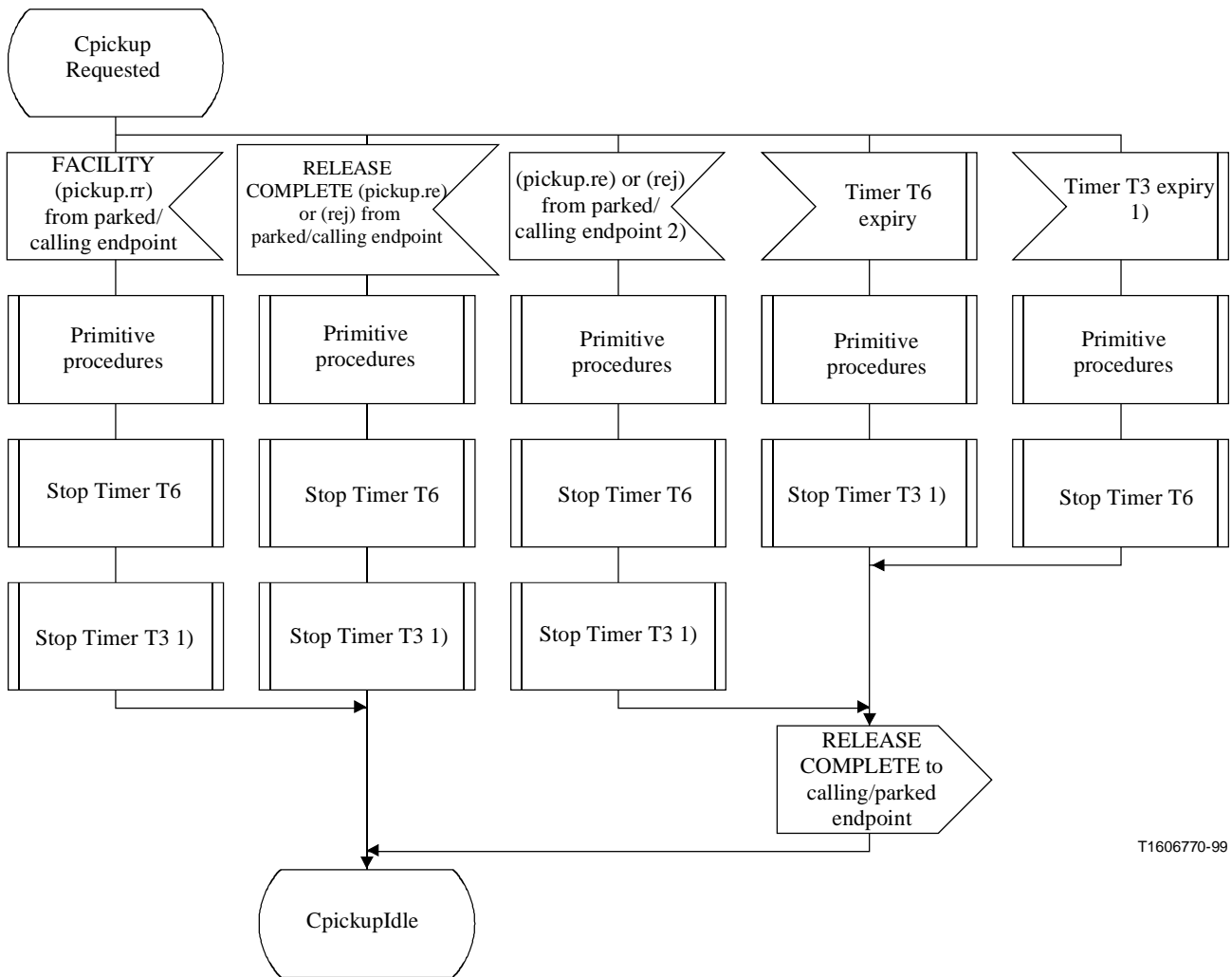
**Figure 21/H.450.5 – SS-PICKUP – Parked-To/Alerting endpoint SDLs (sheet 2 of 4)**



T1606760-99

NOTE 1 – Only applicable for SS-PICKUP of parked call.

Figure 22/H.450.5 – SS-PICKUP – Parked-To/Alerting endpoint SDLs (sheet 3 of 4)

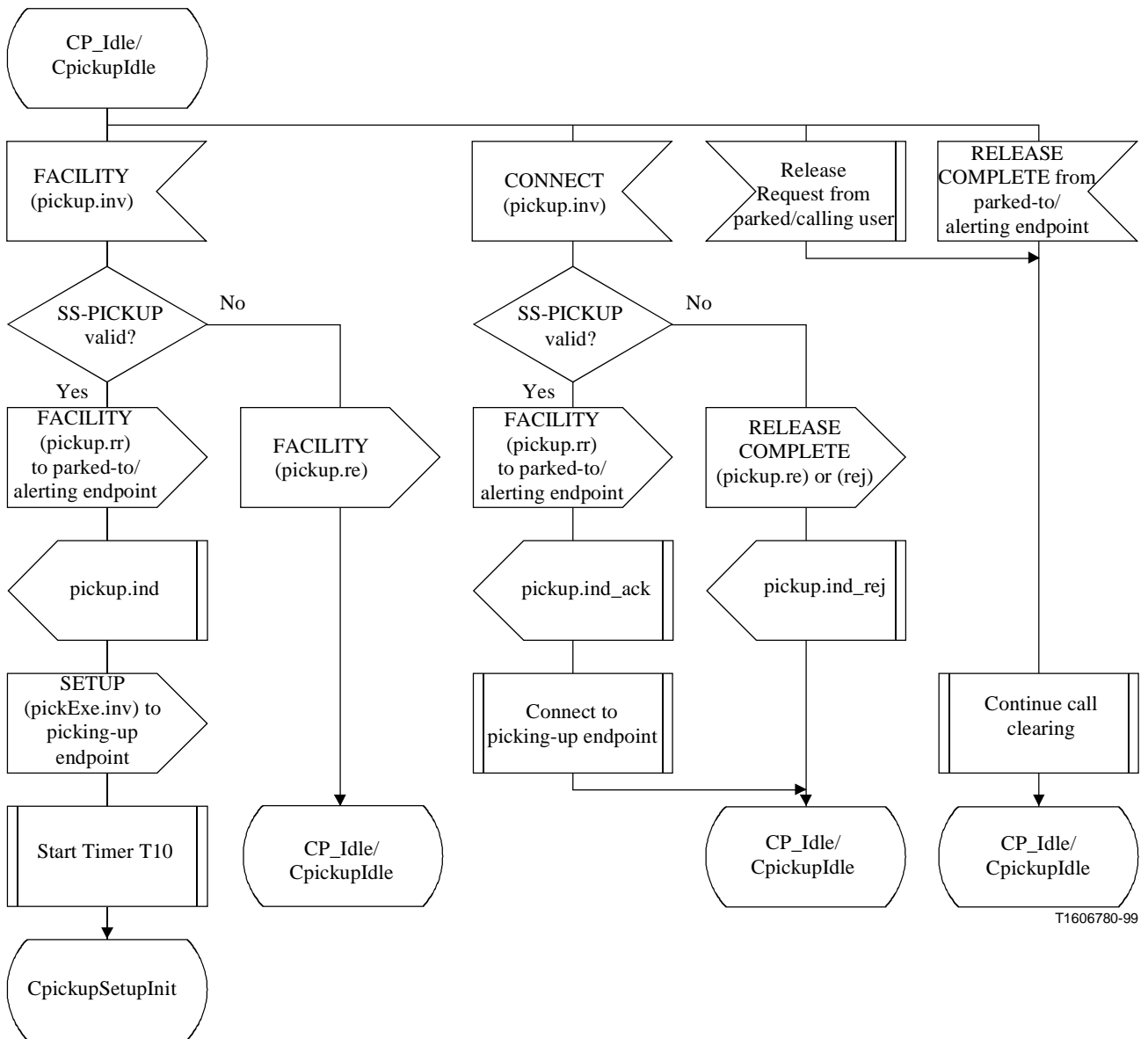


T1606770-99

NOTE 1 – Only applicable for SS-PICKUP of parked call.

NOTE 2 – In messages other than RELEASE COMPLETE (e.g. FACILITY).

**Figure 23/H.450.5 – SS-PICKUP – Parked-To/Alerting endpoint SDLs (sheet 4 of 4)**



T1606780-99

Figure 24/H.450.5 – SS-PICKUP – Parked/Calling endpoint SDLs (sheet 1 of 2)

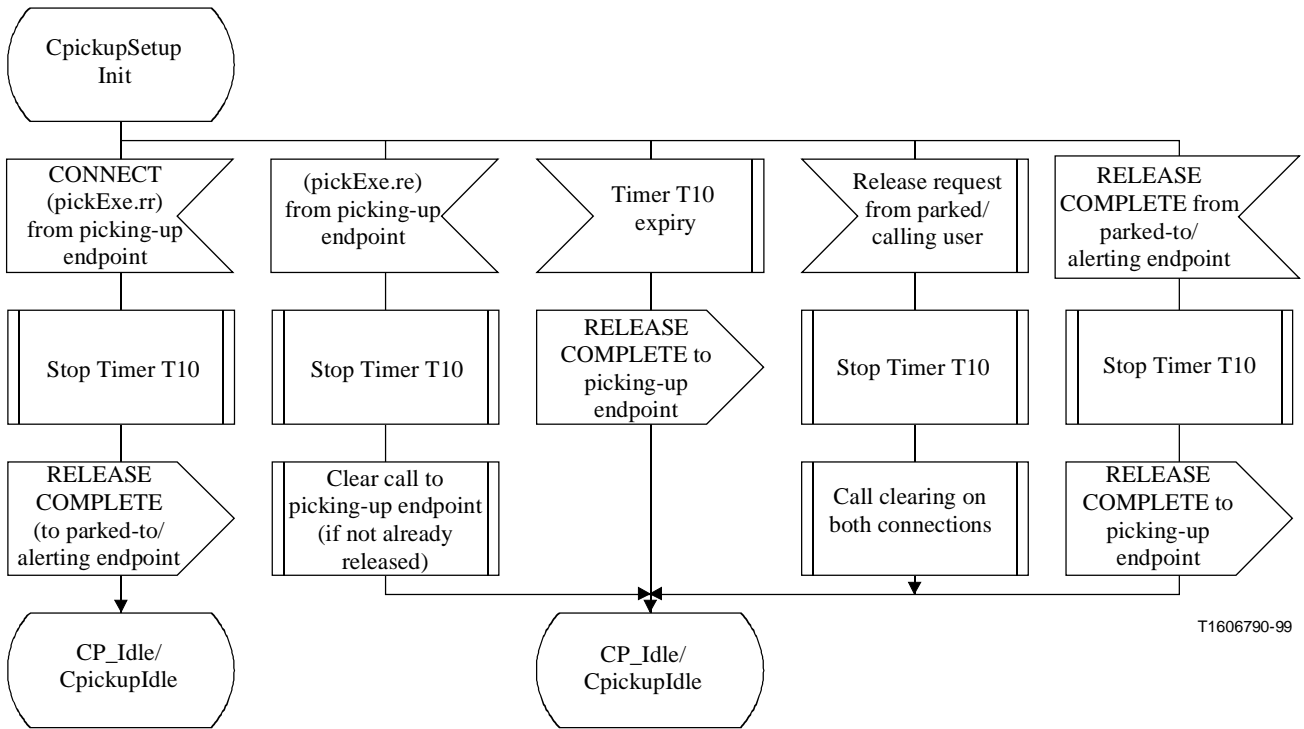
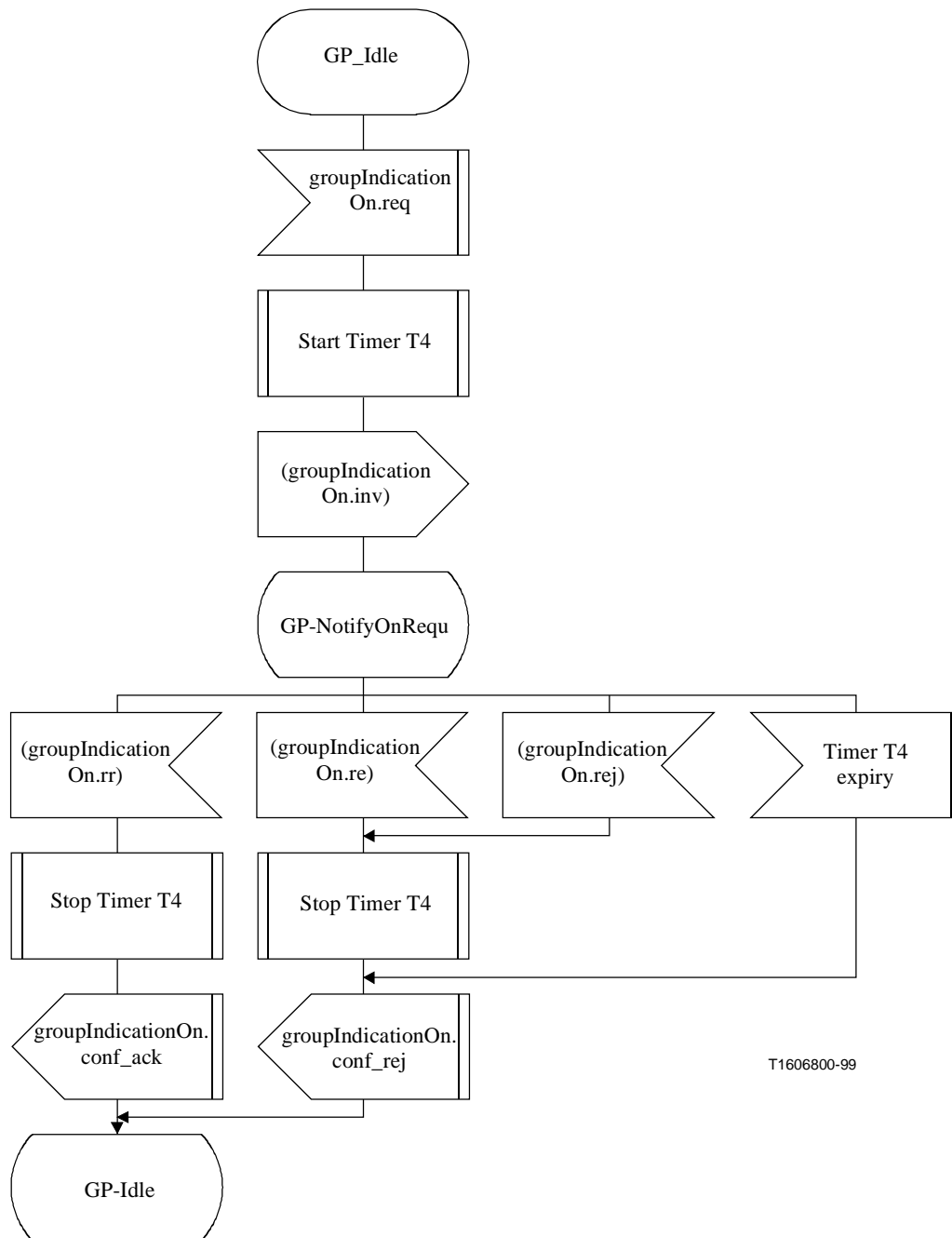


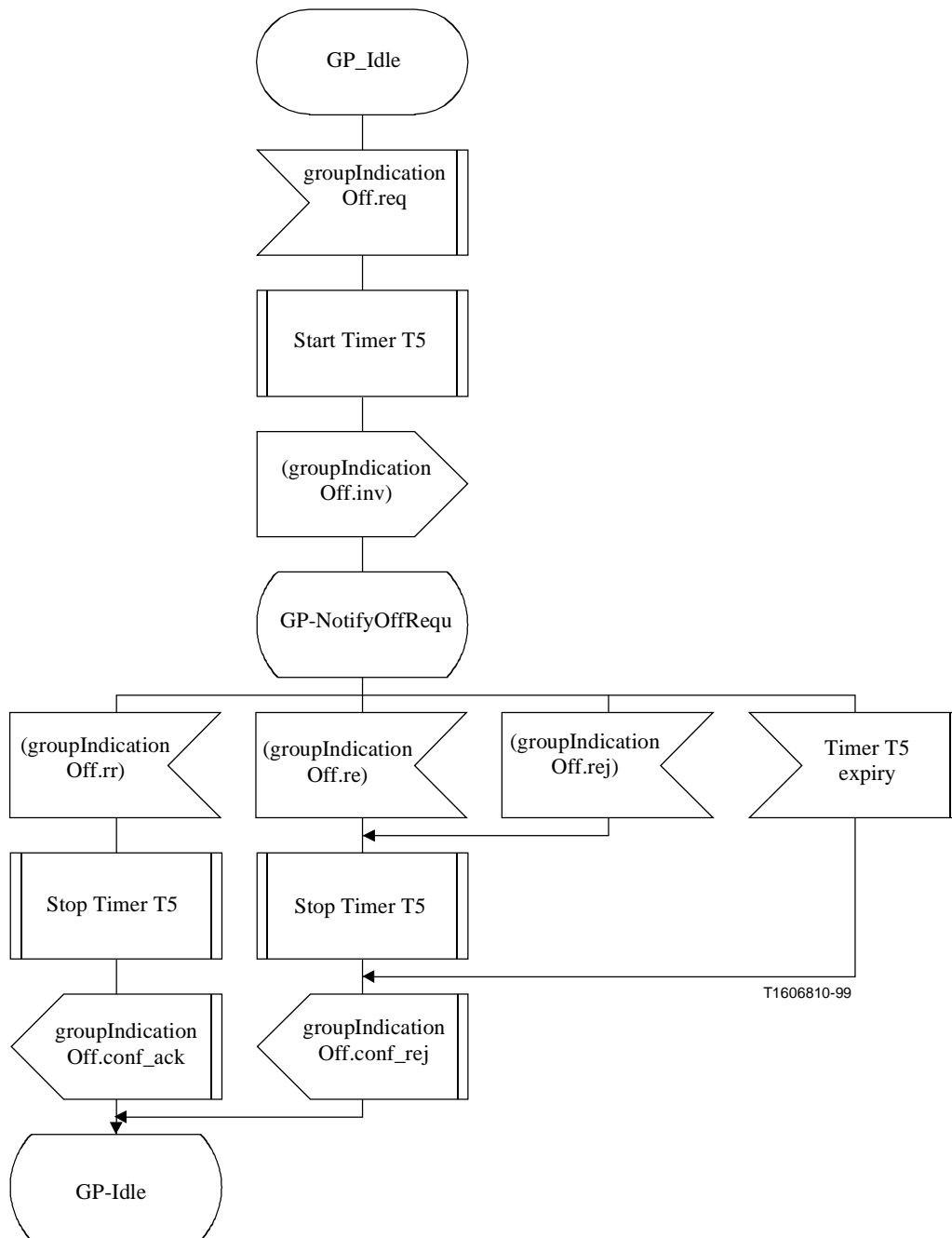
Figure 25/H.450.5 – SS-PICKUP – Parked/Calling endpoint SDLs (sheet 2 of 2)

### 12.3 SS-PARK, SS-PICKUP Group notifications SDLs

See Figures 26 to 28.

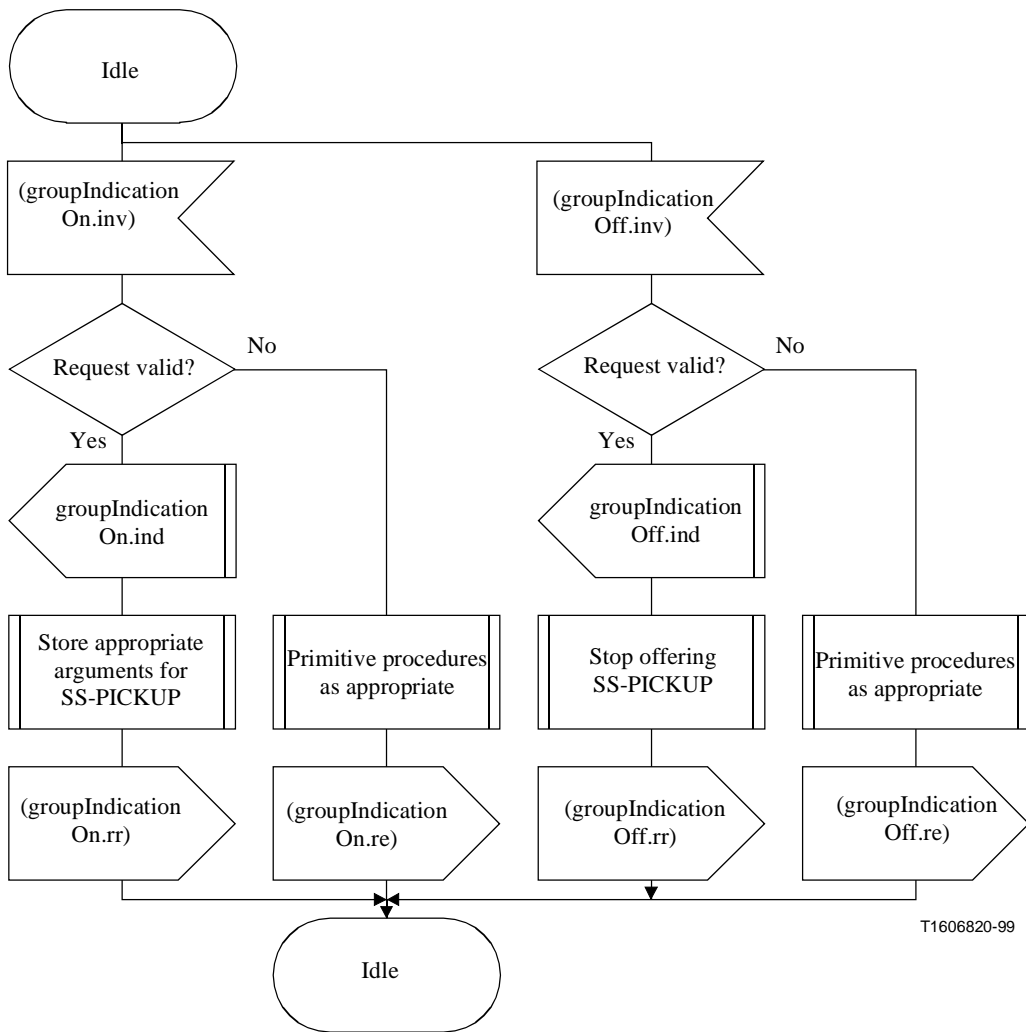


**Figure 26/H.450.5 – Group Notification-On SDIs (Served endpoint)**



**Figure 27/H.450.5 – Group Notification-Off SDLs (Served endpoint)**





**Figure 28/H.450.5 – Group Notification-On/Off SDLs (Group Member endpoint)**

## ITU-T RECOMMENDATIONS SERIES

- Series A Organization of the work of the ITU-T
- Series B Means of expression: definitions, symbols, classification
- Series C General telecommunication statistics
- Series D General tariff principles
- Series E Overall network operation, telephone service, service operation and human factors
- Series F Non-telephone telecommunication services
- Series G Transmission systems and media, digital systems and networks
- Series H Audiovisual and multimedia systems**
- Series I Integrated services digital network
- Series J Transmission of television, sound programme and other multimedia signals
- Series K Protection against interference
- Series L Construction, installation and protection of cables and other elements of outside plant
- Series M TMN and network maintenance: international transmission systems, telephone circuits, telegraphy, facsimile and leased circuits
- Series N Maintenance: international sound programme and television transmission circuits
- Series O Specifications of measuring equipment
- Series P Telephone transmission quality, telephone installations, local line networks
- Series Q Switching and signalling
- Series R Telegraph transmission
- Series S Telegraph services terminal equipment
- Series T Terminals for telematic services
- Series U Telegraph switching
- Series V Data communication over the telephone network
- Series X Data networks and open system communications
- Series Y Global information infrastructure and Internet protocol aspects
- Series Z Languages and general software aspects for telecommunication systems