



INTERNATIONAL TELECOMMUNICATION UNION

ITU-T

TELECOMMUNICATION
STANDARDIZATION SECTOR
OF ITU

H.310

(09/98)

SERIES H: AUDIOVISUAL AND MULTIMEDIA SYSTEMS

Infrastructure of audiovisual services – Systems and
terminal equipment for audiovisual services

**Broadband audiovisual communication systems
and terminals**

ITU-T Recommendation H.310

(Previously CCITT Recommendation)

ITU-T H-SERIES RECOMMENDATIONS
AUDIOVISUAL AND MULTIMEDIA SYSTEMS

Characteristics of transmission channels used for other than telephone purposes	H.10–H.19
Use of telephone-type circuits for voice-frequency telegraphy	H.20–H.29
Telephone circuits or cables used for various types of telegraph transmission or simultaneous transmission	H.30–H.39
Telephone-type circuits used for facsimile telegraphy	H.40–H.49
Characteristics of data signals	H.50–H.99
CHARACTERISTICS OF VISUAL TELEPHONE SYSTEMS	H.100–H.199
INFRASTRUCTURE OF AUDIOVISUAL SERVICES	
General	H.200–H.219
Transmission multiplexing and synchronization	H.220–H.229
Systems aspects	H.230–H.239
Communication procedures	H.240–H.259
Coding of moving video	H.260–H.279
Related systems aspects	H.280–H.299
Systems and terminal equipment for audiovisual services	H.300–H.399
Supplementary services for multimedia	H.450–H.499

For further details, please refer to ITU-T List of Recommendations.

ITU-T RECOMMENDATION H.310

BROADBAND AUDIOVISUAL COMMUNICATION SYSTEMS AND TERMINALS

Summary

This Recommendation covers the technical requirements for the systems and terminals of broadband audiovisual communication services defined in H.200/AV.100-series Recommendations. Both H.310 unidirectional and bidirectional broadband audiovisual terminals are defined. The classification of H.310 terminals into different terminal types is based on a set of audiovisual, network adaptation, and signalling capabilities. With these capabilities, H.310 terminals support a wide range of conversational and distributive applications and services. This revision enhances the interworking between different type of H.310 terminals.

Source

ITU-T Recommendation H.310 was revised by ITU-T Study Group 16 (1997-2000) and was approved under the WTSC Resolution No. 1 procedure on the 25th of September 1998.

FOREWORD

ITU (International Telecommunication Union) is the United Nations Specialized Agency in the field of telecommunications. The ITU Telecommunication Standardization Sector (ITU-T) is a permanent organ of the ITU. The ITU-T is responsible for studying technical, operating and tariff questions and issuing Recommendations on them with a view to standardizing telecommunications on a worldwide basis.

The World Telecommunication Standardization Conference (WTSC), which meets every four years, establishes the topics for study by the ITU-T Study Groups which, in their turn, produce Recommendations on these topics.

The approval of Recommendations by the Members of the ITU-T is covered by the procedure laid down in WTSC Resolution No. 1.

In some areas of information technology which fall within ITU-T's purview, the necessary standards are prepared on a collaborative basis with ISO and IEC.

NOTE

In this Recommendation, the expression "Administration" is used for conciseness to indicate both a telecommunication administration and a recognized operating agency.

INTELLECTUAL PROPERTY RIGHTS

The ITU draws attention to the possibility that the practice or implementation of this Recommendation may involve the use of a claimed Intellectual Property Right. The ITU takes no position concerning the evidence, validity or applicability of claimed Intellectual Property Rights, whether asserted by ITU members or others outside of the Recommendation development process.

As of the date of approval of this Recommendation, the ITU had not received notice of intellectual property, protected by patents, which may be required to implement this Recommendation. However, implementors are cautioned that this may not represent the latest information and are therefore strongly urged to consult the TSB patent database.

© ITU 1998

All rights reserved. No part of this publication may be reproduced or utilized in any form or by any means, electronic or mechanical, including photocopying and microfilm, without permission in writing from the ITU.

CONTENTS

	Page
1	Scope 1
2	References 3
3	Definitions 5
4	Abbreviations 6
5	Conventions 8
6	System description 8
6.1	System configuration 8
6.2	Terminal types 10
6.2.1	Unidirectional terminal types (ROT and SOT) 10
6.2.2	Bidirectional terminal types (RAST) 11
6.3	Terminal capabilities 12
6.3.1	Video capabilities 12
6.3.2	Audio capabilities 14
6.3.3	Data capabilities 15
6.3.4	Network Adaptation Capabilities (NAC) 15
6.3.5	Signalling capabilities 18
6.4	The use of the H.245 control channel 22
6.4.1	Master slave determination 23
6.4.2	Capabilities exchange 24
6.4.3	Logical channel signalling 25
6.4.4	Mode request 27
6.4.5	Round trip delay 27
6.4.6	Maintenance loop 28
6.4.7	Specific commands and indications 29
7	H.310 call phases 29
7.1	Native H.310 communication call procedures 29
7.1.1	Phase A (call setup) 32
7.1.2	Phase B (audiovisual communication) 33
7.1.3	Phase C (call release) 33
7.2	H.320/H.321 interoperation call procedures 34
8	Multipoint communication 34
8.1	Native H.310 communication modes 34
8.2	H.320/H.321 interoperation modes 34
8.3	Other aspects 34

	Page
9	Equipment requirements..... 34
10	Error resilience 35
10.1	Video layer 35
10.2	Multimedia multiplex layer..... 35
11	Maintenance loop 35
12	Intercommunications 36
12.1	Intercommunication between different terminal types..... 37
12.2	Intercommunication with N-ISDN terminals 38
12.3	Intercommunication with telephony..... 38
12.4	Intercommunication with audiovisual terminals connected to other networks..... 38
	Annex A – Protocol stack for control channel 38
A.1	General 38
A.2	X.214 39
A.3	X.224 39
A.4	LAPF (Q.922)..... 39
A.5	FR-SSCS (I.365.1) and H.222.1 40
	A.5.1 FR-SSCS (I.365.1) 40
	A.5.2 H.222.0 and H.222.1 40
	Annex B – Use of DSS 2 signalling by H.310 terminals..... 41
B.1	DSS 2 signalling information elements..... 41
B.2	ATM signalling required for the H.310 control VC..... 44
B.3	ATM Signalling Required for RAST-1 A/V VC 45
B.4	ATM Signalling Required for H.310 SOT/ROT-1 47
B.5	ATM Signalling Required for RAST-5 A/V VC 48
B.6	ATM Signalling Required for H.310 SOT-5..... 50
B.7	ATM Signalling Required for H.310 ROT-5 52
	Annex C – Procedures for intercommunication between RAST-1 and RAST-5 terminals 53
C.1	Introduction 53
C.2	Two RAST-5 terminals on CPN 54
C.3	RAST-5 Terminal on CPN with RAST-1 Terminal on Public B-ISDN 55
	C.3.1 RAST-5 Terminal on CPN calls RAST-1 Terminal on B-ISDN..... 55
	C.3.2 RAST-1 Terminal on B-ISDN calls RAST-5 Terminal on CPN..... 56
C.4	RAST-5 Terminal on CPN with RAST-1 Terminal on CPN..... 57

	Page
Appendix I – Bit and byte order	58
Appendix II – H.310 CorrelationID.....	58

Recommendation H.310

BROADBAND AUDIOVISUAL COMMUNICATION SYSTEMS AND TERMINALS

(revised in 1998)

1 Scope

This Recommendation covers the technical requirements for the systems and terminals of broadband audiovisual communication services defined in H.200/AV.100-series Recommendations.

This Recommendation defines both *unidirectional* and *bidirectional* broadband audiovisual terminals. The classification of H.310 terminals into different terminal types is based on audiovisual and ATM adaptation layer capabilities which are defined in 6.2. There are two classes of unidirectional terminals: Receive-Only Terminal (ROT) and Send-Only Terminal (SOT) classes.

In this Recommendation, bidirectional terminal types are referred to as Receive-and-Send Terminal (RAST) types. The definition of H.310 RAST terminals is based on the following interoperability principles:

- 1) Interworking between H.310 RAST terminal types and other N-ISDN/B-ISDN (H.320/H.321) audiovisual terminals is mandatory.
- 2) Interworking among the *different* H.310 RAST terminal types is also mandatory.

Three types of RAST terminals are defined: RAST-1, RAST-5, and RAST-1&5.

RAST-1 and RAST-1&5 terminals may be connected to public networks and customer premise networks (private networks), while RAST-5 terminals may only be connected to customer premise networks (private networks).

For interworking with H.320/H.321 terminals, all three RAST terminal types support common H.320 audiovisual modes. For interworking between RAST-5 terminals and RAST-1 and H.320/H.321 terminals, a gateway, that is not inside the public network but in the customer premises, between a B-ISDN and a customer-premises ATM network is needed to provide interoperability functions.

The video and audio coding and other technical aspects that are applicable to more than one distinct service are covered in H.200/AV.200-series Recommendations.

Figure 1 shows a generic broadband audiovisual communication system. It consists of terminal equipment, network, Multipoint Control Unit (MCU) and the constituent elements of the terminal equipment. The corresponding Recommendations are also identified.

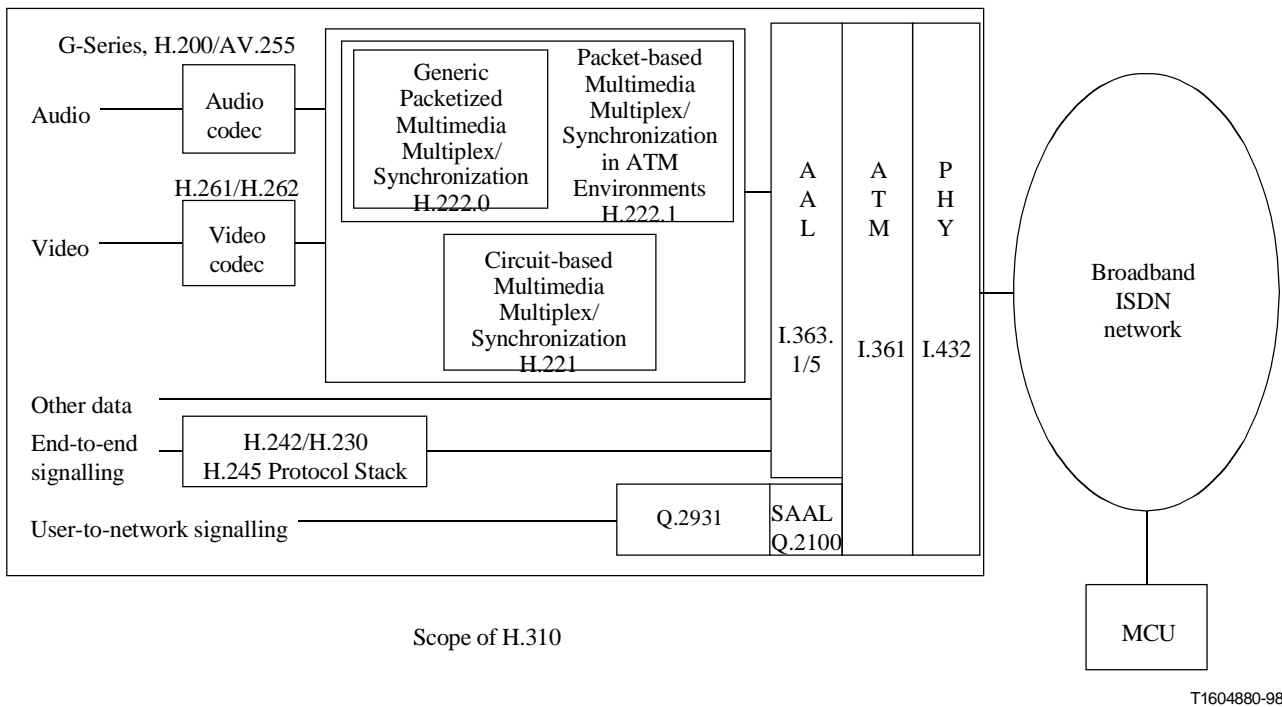

Figure 1/H.310 – Broadband audiovisual communication system and terminal configuration

All H.310 terminals are required to support H.245 as their communication control protocol so that they can support their intended services and interoperate among each other. Accordingly, H.310 terminals shall use the H.222.1 acknowledged procedures for the subchannel signalling.

It is important to note that the generic H.310 terminal shown in Figure 1 can represent any of the unidirectional or bidirectional terminal types defined in this Recommendation.

The definition of H.310 terminal types is intended for the support of the following applications:

- Conversational services (e.g. videoconferencing and videotelephony services).
- Retrieval services.
- Messaging services.
- Distribution services with individual presentation by the recipient (e.g. video-on-demand services).
- Distribution services without individual presentation by the recipient (e.g. broadcast TV services).
- Video transmission.
- Surveillance.

2 References

The following ITU-T Recommendations and other references contain provisions which, through reference in this text, constitute provisions of this Recommendation. At the time of publication, the editions indicated were valid. All Recommendations and other references are subject to revision; all users of this Recommendation are therefore encouraged to investigate the possibility of applying the most recent edition of the Recommendations and other references listed below. A list of the currently valid ITU-T Recommendations is regularly published.

- [1] CCITT Recommendation G.711 (1988), *Pulse Code Modulation (PCM) of voice frequencies*.
- [2] CCITT Recommendation G.722 (1988), *7 kHz audio-coding within 64 kbit/s*.
- [3] ITU-T Recommendation G.723.1 (1996), *Speech codecs: Dual rate speech coder for multimedia communications transmitting at 5.3 and 6.3 kbit/s*.
- [4] CCITT Recommendation G.728 (1992), *Coding of speech at 16 kbit/s using low-delay code excited linear prediction*.
- [5] ITU-T Recommendation G.729 (1996), *Coding of speech at 8 kbit/s using Conjugate Structure Algebraic-Code-Excited Linear-Prediction (CS-ACELP)*.
- [6] Annex A to G.729 (1996), *Reduced complexity 8 kbit/s CS-ACELP speech codec*.
- [7] CCITT Recommendation H.100 (1988), *Visual telephone systems*.
- [8] ITU-T Recommendation H.221 (1997), *Frame structure for a 64 to 1920 kbit/s channel in audiovisual teleservices*.
- [9] ITU-T Recommendation H.222.0 (1995) | ISO/IEC 13818-1:1996, *Information technology – Generic coding of moving pictures and associated audio information: Systems*.
- [10] ITU-T Recommendation H.222.1 (1996), *Multimedia multiplex and synchronization for audiovisual communication in ATM environments*.
- [11] ITU-T Recommendation H.224 (1994), *A real time control protocol for simplex applications using the H.221 LSD/HSD/MLP channels*.
- [12] ITU-T Recommendation H.230 (1997), *Frame-synchronous control and indication signals for audiovisual systems*.
- [13] ITU-T Recommendation H.233 (1995), *Confidentiality system for audiovisual services*.
- [14] ITU-T Recommendation H.234 (1994), *Encryption key management and authentication system for audiovisual services*.
- [15] ITU-T Recommendation H.242 (1997), *System for establishing communication between audiovisual terminals using digital channels up to 2 Mbit/s*.
- [16] ITU-T Recommendation H.245 (1998), *Control protocol for multimedia communication*.
- [17] ITU-T Recommendation H.261 (1993), *Video codec for audiovisual services at $p \times 64$ kbit/s*.
- [18] ITU-T Recommendation H.262 (1995) | ISO/IEC 13818-2:1995, *Information technology – Generic coding of moving pictures and associated audio information: Video*.
- [19] ITU-T Recommendation H.263 (1998), *Video coding for low bit rate communication*.
- [20] ITU-T Recommendation H.281 (1994), *A far end camera control protocol for videoconferences using H.224*.

- [21] ITU-T Recommendation H.320 (1997), *Narrow-band visual telephone systems and terminal equipment.*
- [22] ITU-T Recommendation H.321 (1998), *Adaptation of H.320 visual telephone terminals to B-ISDN environments.*
- [23] ITU-T Recommendation I.311 (1996), *B-ISDN general network aspects.*
- [24] ITU-T Recommendation I.361 (1995), *B-ISDN ATM layer specification.*
- [25] ITU-T Recommendation I.363.1 (1996), *B-ISDN ATM adaptation layer specification: Type 1 AAL.*
- [26] ITU-T Recommendation I.363.5 (1996), *B-ISDN ATM adaptation layer specification: Type 5 AAL.*
- [27] CCITT Recommendation Q.922 (1992), *ISDN data link layer specification for frame mode bearer services.*
- [28] ITU-T Recommendation Q.2010 (1995), *Broadband integrated services digital network overview – Signalling capability set 1, release 1.*
- [29] ITU-T Recommendation Q.2110 (1994), *B-ISDN ATM adaptation layer – Service Specific Connection Oriented Protocol (SSCOP).*
- [30] ITU-T Recommendation Q.2130 (1994), *B-ISDN signalling ATM adaptation layer – Service specific coordination function for support of signalling at the user-network interface (SSCF at UNI).*
- [31] ITU-T Recommendation Q.2931 (1995), *Digital subscriber Signalling System No. 2 – User-Network Interface (UNI) layer 3 specification for basic call/connection control.*
- [32] ITU-T Recommendation Q.2941.1 (1997), *Digital subscriber Signalling System No. 2: Generic identifiers transport.*
- [33] ITU-T Recommendation Q.2961.1 (1995), *Digital subscriber Signalling System No. 2 (DSS 2) – Additional traffic parameters: Additional signalling capabilities to support traffic parameters for the tagging option and the sustainable cell rate parameter set.*
- [34] ITU-T Recommendation Q.2961.2 (1997), *Digital subscriber Signalling System No. 2 – Additional traffic parameters: Support of ATM transfer capability in the broadband bearer capability information element.*
- [35] ITU-T Recommendation Q.2971 (1995), *Digital subscriber Signalling System No. 2 – User-network interface layer 3 specification for point-to-multipoint call/connection control.*
- [36] ITU-T Recommendation T.84 (1996) | ISO/IEC 10918-3:1996, *Information technology – Digital compression and coding of continuous-tone still images: Extensions.*
- [37] ITU-T Recommendation T.120 (1996), *Data protocols for multimedia conferencing.*
- [38] ITU-T Recommendation T.123 (1996), *Network specific data protocol stacks for multimedia conferencing.*
- [39] ITU-T Recommendation T.434 (1996), *Binary file transfer format for the telematic services.*
- [40] ITU-T Recommendation X.214 (1995) | ISO/IEC 8072:1996, *Information technology – Open Systems Interconnection – Transport service definition.*
- [41] ITU-T Recommendation X.224 (1995) | ISO/IEC 8073:1997, *Information technology – Open Systems Interconnection – Protocol for providing the connection-mode transport service.*

- [42] ITU-T Recommendation X.680 (1997) | ISO/IEC 8824-1:1998, *Information technology – Abstract Syntax Notation One (ASN.1): Specification of basic notation*.
- [43] ITU-T Recommendation X.691 (1997) | ISO/IEC 8825-2:1998, *Information technology – ASN.1 encoding rules – Specification of Packed Encoding Rules (PER)*.
- [44] ISO/IEC 11172-3:1993, *Information technology – Coding of moving pictures and associated audio for digital storage media at up to about 1.5 Mbit/s – Part 3: Audio*.
- [45] ISO/IEC 13818-3:1995, *Information technology – Generic coding of moving pictures and associated audio information – Part 3: Audio*.
- [46] ISO/IEC 13818-6:1998, *Information technology – Generic coding of moving pictures and associated audio information – Part 6: Extensions for DSM-CC*.

3 Definitions

This Recommendation defines the following terms.

- 3.1 audiovisual information:** Information including audio and/or video information.
- 3.2 bidirectional logical channel:** A bidirectional logical channel consists of a pair of associated transmission paths between two terminals, one in each direction of transmission.
- 3.3 bidirectional terminal:** A terminal which can send and receive audiovisual information.
- 3.4 capability:** A terminal has a particular capability if it is able to encode and transmit or receive and decode that particular signal.
- 3.5 channel:** A channel is a unidirectional link between two end points.
- 3.6 command:** A command is a message that requires action but no explicit response.
- 3.7 control and indication:** End-to-end signalling between terminals, consisting of control, which requires action but no explicit response in the receiver, and indication which contains information but does not require action or response in the receiver.
- 3.8 customer premises network:** An ATM network administered by the user.
- 3.9 elementary stream:** Elementary stream is a generic term for a coded video, coded audio or other coded bit stream.
- 3.10 entry:** The word entry is used to refer to elements in sets or tables, such as capability sets.
- 3.11 gateway:** A function that converts transmission formats and/or protocols between different network environments.
- 3.12 in-band:** In-band messages are those that are transported within the channel or logical channel to which they refer.
- 3.13 indication:** An indication is a message that contains information but does not require action or response.
- 3.14 logical channel:** A logical channel is a unidirectional path or bidirectional path for the transmission of information.
- 3.15 logical channel number:** A logical channel number is a number that identifies a single logical channel.
- 3.16 logical channel signalling:** Logical channel signalling is a set of procedures that are used to open and close logical channels.

- 3.17 master terminal:** A master terminal is the terminal that is determined as being the master terminal by the master-slave determination procedure used by this Recommendation.
- 3.18 medium type:** A medium type is a single form of information that is presented to a user or the data representing that information: video, audio and text are example medium types.
- 3.19 mode:** A mode is a set of elementary streams that a terminal is transmitting, intends to transmit, or would like to receive.
- 3.20 multimedia communication:** Multimedia communication refers to the transmission and/or reception of signals of two or more medium types simultaneously.
- 3.21 multipoint:** Multipoint refers to the simultaneous interconnection of three or more terminals to allow communication among several sites through the use of multipoint control units (bridges) that centrally direct the flow of information.
- 3.22 non-standard:** Not conforming to a national or international standard referenced in this Recommendation.
- 3.23 out-of-band:** Out-of-band messages are those that are not transported within the user-to-user information channel.
- 3.24 public network:** An ATM network administered by the network provider for public access.
- 3.25 request:** A request is a message that results in action by the remote terminal and requires an immediate response from it.
- 3.26 response:** A response is a message that is the response to a request.
- 3.27 session:** A session is a period of communication between two terminals which may be conversational or non-conversational (for example retrieval from a database).
- 3.28 slave terminal:** A slave terminal is the terminal that is determined as being the slave terminal by the master-slave determination procedure used by this Recommendation.
- 3.29 subchannel:** A channel in Recommendation H.222.1 formed from packets having a unique multiplex identifier field value. A subchannel carries one H.222.1 elementary stream. A subchannel is unidirectional. There may be many subchannels within one ATM virtual channel.
- 3.30 support:** The ability to operate in a given mode; however, a requirement to support a mode does not mean that the mode shall actually be used at all times: unless prohibited, other modes may be used by mutual negotiation.
- 3.31 terminal:** A terminal is any endpoint and may be a user's terminal or some other communication system such as an MCU or an information server.
- 3.32 unidirectional logical channel:** A unidirectional logical channel is a path for the transmission of a single elementary stream from one terminal to another.
- 3.33 unidirectional terminal:** A terminal which can only send or receive audiovisual information.

4 Abbreviations

This Recommendation uses the following abbreviations:

AAL	ATM Adaptation Layer
ASN.1	Abstract Syntax Notation One
ATM	Asynchronous Transfer Mode
B-BC	Broadband Bearer Capability

B-HLI	Broadband High-Layer Information
B-ISDN	Broadband ISDN
B-LCSE	Bidirectional Logical Channel Signalling Entity
C&I	Control and Indication
CBR	Constant Bit Rate
CESE	Capability Exchange Signalling Entity
CIF	Common Intermediate Format (of a video picture: refer to Recommendations H.261 and H.263)
CLCSE	Close Logical Channel Signalling Entity
CPCS	Common Part Convergence Sublayer (of ATM Adaptation Layer 5)
CPCS-UU	CPCS User-to-User
CPI	Common Part Indicator
CRC	Cyclic Redundancy Check
CS	Convergence Sublayer
DSM-CC	Digital Storage Media – Command and Control
DSS 2	Digital Subscriber Signalling System No. 2
FEC	Forward Error Correction
FR-SSCS	Frame Relay Service Specific Convergence Sublayer
GOB	Group Of Blocks (of a video picture: refer to Recommendations H.261 and H.263)
IE	Information Element
ISDN	Integrated Services Digital Network
LCSE	Logical Channel Signalling Entity
MCU	Multipoint Control Unit
MLSE	Maintenance Loop Signalling Entity
MSDSE	Master Slave Determination Signalling Entity
MRSE	Mode Request Signalling Entity
NAC	Network Adaptation Capabilities
N-BC	Narrow-band Bearer Capability
N-ISDN	Narrow-band ISDN
PDU	Protocol Data Unit
PES	Packetized Elementary Stream
PID	Packet Identifier (refer to ITU-T Rec. H.222.0 ISO/IEC 13818-1)
PS	Program Stream
PTS	Presentation Time Stamp
QCIF	Quarter CIF
QoS	Quality of Service
RAST	Receive-and-Send Terminal
RAST-1	Receive-and-Send Terminal with an AAL 1 interface
RAST-1&5	Receive-and-Send Terminal with AAL 1 and AAL 5 interfaces
RAST-5	Receive-and-Send Terminal with an AAL 5 interface
ROT	Receive-Only Terminal
ROT-1	Receive-Only Terminal with an AAL 1 interface

ROT-1&5	Receive-Only Terminal with AAL 1 and AAL 5 interfaces
ROT-5	Receive-Only Terminal with an AAL 5 interface
RTDSE	Round Trip Delay Signalling Entity
SAP	Service Access Point
SAR	Segmentation And Reassembly
SDT	Structured Data Transfer
SDU	Service Data Unit
SOT	Send-Only Terminal
SOT-1	Send-Only Terminal with an AAL 1 interface
SOT-1&5	Send-Only Terminal with AAL 1 and AAL 5 interfaces
SOT-5	Send-Only Terminal with an AAL 5 interface
SQCIF	Sub QCIF
SRTS	Synchronous Residual Time Stamp
SSCOP	Service Specific Connection-Oriented Protocol
SSCS	Service Specific Convergence Sublayer
TS	Transport Stream
UNI	User Network Interface
VBR	Variable Bit Rate
VC	ATM Virtual Channel
VFS	Video Frame Synchronous
VOD	Video On Demand

5 Conventions

The word "shall" is used in this Recommendation to specify a mandatory requirement.

The word "should" is used in this Recommendation to specify a suggested, but not required, course of action.

The word "may" is used in this Recommendation to specify an optional course of action, without expressing a preference.

The term "11172 audio" is used in this Recommendation to represent ISO/IEC 11172-3.

The term "13818 audio" is used in this Recommendation to represent ISO/IEC 13818-3.

6 System description

6.1 System configuration

The interaction among the H.310 terminal capabilities is based on the protocol reference model shown in Figure 2, which illustrates the protocol stacks for the audiovisual, data, call management (DSS 2 and H.245), and other control and indication signals that can be supported by the different terminal types of this Recommendation.

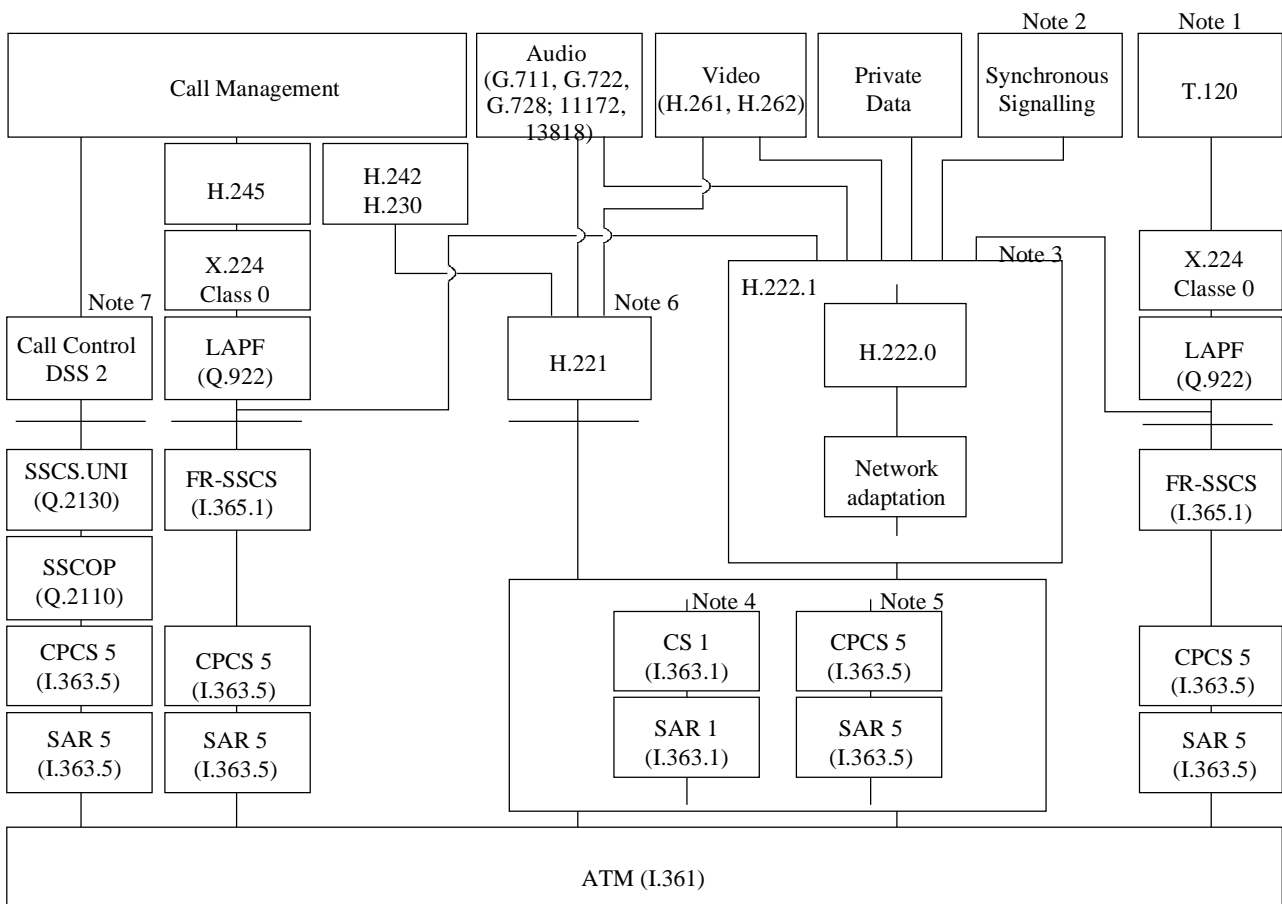

T1604890-98

NOTE 1 – T.120 may be carried within the H.222.1 multiplex or in a separate ATM virtual channel, as specified in Recommendation T.123.

NOTE 2 – Video frame synchronous signals are described in 6.3.5.3.

NOTE 3 – H.222.1/H.222.0 functions include multiplexing, timebase recovery, media synchronization, jitter removal, buffer management, security and access control, in-band signalling, and trick modes. Recommendation H.222.1 specifies elements and procedures from the generic H.222.0, for their use in ATM environments, and also specifies code points and procedures for ITU-T defined elementary streams.

NOTE 4 – AAL type 1 CS functions include transmission clock recovery, jitter removal, bit error correction, cell loss correction, and data structure preservation.

NOTE 5 – AAL type 5 (CPCS) functions include bit error detection, cell loss detection, and data structure preservation.

NOTE 6 – H.221 is required in the H.310 RAST-1, RAST-5 and RAST-1&5 terminals for interworking with H.320/H.321 terminals.

NOTE 7 – B-ISDN signalling is referred to as Digital Subscriber Signalling System No. 2 (DSS 2). DSS 2 is composed of the suite of protocols shown in Table 1. The protocol stack for the Q.2931 signalling messages is specified in Recommendation Q.2010.

Figure 2/H.310 – H.310 protocol reference model

Table 1/H.310 – Summary of DSS 2 protocols

Recommendation	Title
Q.2931	User network interface layer 3 specification for basic call/connection control
Q.2941.1	DSS 2 user generated identifiers
Q.2961	Support of additional traffic parameters
Q.2961.2	ATM transfer capability coding in the broadband bearer capability information element
Q.2962	Negotiation of traffic and QoS parameters (during call/connection establishment)
Q.2963	Renegotiation/modification of traffic and QoS parameters (for already established calls/connections)
Q.2964	B-ISDN look-ahead
Q.2971	Point-multipoint call/connection control
Q.298x	Multiconnection calls

6.2 Terminal types

This Recommendation defines both unidirectional and bidirectional broadband audiovisual terminals. The classification of H.310 terminals into different terminal types is based on audiovisual and AAL capabilities as summarized in Table 2.

Table 2/H.310 – Definition of H.310 terminal types

			AAL		
			AAL 1	AAL 5	AAL 1& 5
Audiovisual transport	Unidirectional	ROT	ROT-1	ROT-5	ROT-1&5
		SOT	SOT-1	SOT-5	SOT-1&5
	Bidirectional	RAST	RAST-1	RAST-5	RAST-1&5

6.2.1 Unidirectional terminal types (ROT and SOT)

Two classes of unidirectional terminals are defined: Send-Only Terminal (SOT) and Receive-Only Terminal (ROT).

Three types of H.310 unidirectional terminals are defined, based on their supported AALs, for each of the two classes. The H.310 defined unidirectional terminal types are:

- H.310 ROT-1 and SOT-1 which support AAL 1;
- H.310 ROT-5 and SOT-5 which support AAL 5;
- H.310 ROT-1&5 and SOT-1&5 is a composite terminal supporting both AAL 1 and AAL 5.

Each of these terminal types shall support the H.310 native communication mode. The native communication mode consists of H.222.1, with ISO/IEC 11172-3 Layer 2, H.262 and H.245 as the audio, video and control protocols.

Each of these terminals may be connected to public B-ISDN and customer premise networks (private networks).

NOTE – Some pairs of unidirectional terminal will not interwork with each other. This may be due to incompatible class, such as ROT-1 connecting with ROT-1&5, or due to incompatible type, such as ROT-1 connecting to SOT-5.

6.2.2 Bidirectional terminal types (RAST)

Three types of H.310 bidirectional receive and send terminals (RAST) are defined based on their communication modes and supported AALs. The H.310 defined terminal types are:

- H.310 RAST-1 which supports AAL 1;
- H.310 RAST-5 which supports AAL 5;
- H.310 RAST-1&5 is a composite terminal supporting both AAL 1 and AAL 5.

Each of these terminal types shall support an H.310 native communication mode as well as an H.320/H.321 interoperation mode. Figure 3 depicts the protocol stacks for these two modes for each of the terminal types.

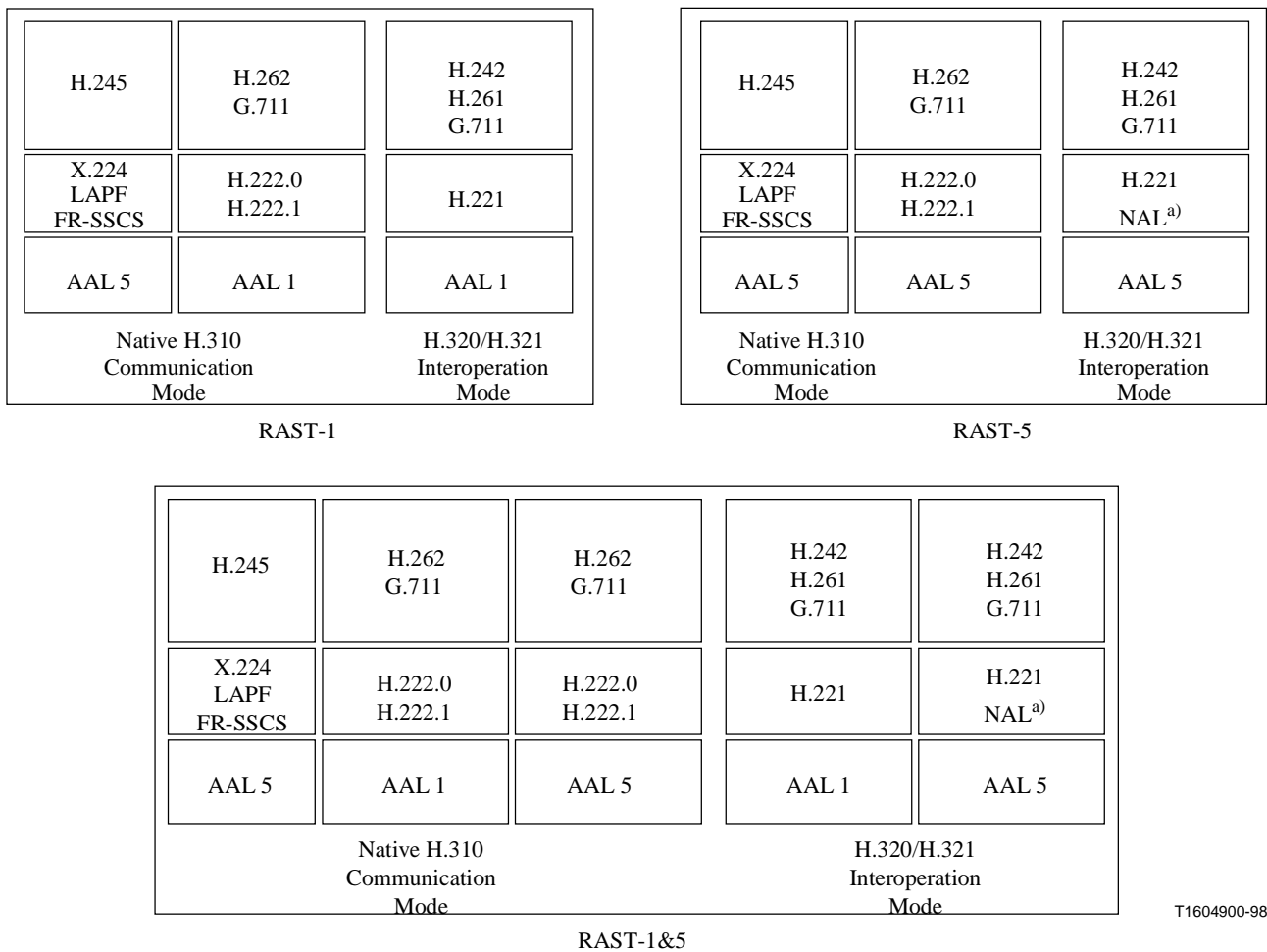

T1604900-98

^{a)} NAL Network Adaptation Layer (see Annex B/H.321).

Figure 3/H.310 – Protocol stacks for native H.310 and H.320/H.321 interoperation communication modes

NOTE – Figure 3 corresponds to the "separate VC" case in Annex A.

The H.310 RAST-1 terminal supports AAL 1. Its native H.310 communication mode consists of H.222.1, with G.711, H.262, and H.245 as the audio, video, and control protocols. Its H.320/H.321 interoperation mode supports the full H.321/Annex A protocol stack.

The H.310 RAST-5 terminal supports AAL 5. Its native H.310 communication mode consists of H.222.1 with G.711, H.262, and H.245 as the audio, video and control protocols. Its H.320/H.321 interoperation mode supports the full H.321/Annex B protocol stack.

The H.310 RAST-1&5 is a composite of the RAST-1 and RAST-5 terminal types and supports all four modes described above.

The RAST-1 and RAST-1&5 terminals connect to public B-ISDN and customer premise networks (private networks) and can interwork with H.320 via an I.580 interworking unit and directly with H.321/Annex A terminals. The RAST-5 terminal connects to customer premise networks (private networks), can directly interwork with H.321/Annex B terminals and requires a gateway to interwork with H.320, H.321/Annex A and H.310 RAST-1 terminals. See clause 12 for interworking scenarios.

6.3 Terminal capabilities

The definition and classification of H.310 terminal types and their communication modes are based on the following capabilities:

- Audiovisual and Data;
- Network Adaptation;
- signalling (both user-to-user and user-to-network).

A *communication mode* is defined as a combination of certain parameters of the above capabilities. Based on the different capabilities of H.310 terminals, two classes of communication modes are specified:

- H.320/H.321 interoperation modes;
- native H.310 communication modes.

Unidirectional H.310 terminals need only support native H.310 communication modes of operation, that is, unidirectional terminals may optionally support the H.320/H.321 interoperation modes.

At the start of the call, H.310 terminals shall identify the remote terminal type (H.320/H.321, H.310 bidirectional, etc.) via exchange of Q.2931 information elements, and shall use either H.245 or H.242 to perform capability exchange and other procedures.

This Recommendation mandates the support of particular functionalities by the different terminal types. However, this does not imply that a particular communication mode shall be used by that terminal type during a given communication session. For example, RAST terminals shall support H.261 video capabilities for interworking with H.320/H.321 terminals, but the use of H.261 in the native mode, that is, when H.222.1 is used, is optional.

The following subclauses describe mandatory and optional capabilities. Optional capabilities are included as guidelines for implementations and are in no way intended to be exhaustive lists of what may be implemented.

6.3.1 Video capabilities

All H.310 terminals shall support Recommendation H.262 at the Main Profile at Main Level (MP@ML) conformance point. Other H.262 profiles and levels may be optionally supported.

H.310 terminals shall adhere to the hierarchical relationship, as defined in clause 8/H.262, among the different H.262 profiles and levels. Therefore, it should be noted that H.262 Simple Profile at Main Level (SP@ML) and Main Profile at Low Level (MP@LL) shall be supported by all H.310 terminals.

When compliance with a H.262 conformance point, that is a given profile at a given level, is supported, H.310 terminals shall adhere to the video parameter constraints specified in clause 8/H.262 for that conformance point. However, terminals may indicate a capability for the functionality of a given profile with reduced level parameters using H.245, and such a communication mode may be established using the relevant procedures of H.245 when both terminals have the necessary capability.

The mandatory and optional video and audio capabilities are summarized in Table 3.

Table 3/H.310 – Audiovisual capabilities of H.310 terminals

Terminal type		Audiovisual capabilities			
		Video		Audio	
		Mandatory	Optional	Mandatory	Optional
ROT-1 SOT-1 ROT-5 SOT-5 ROT-1&5 SOT-1&5		H.262 MP@ML	H.262 MP@H14L H.262 MP@HL H.262 SNR@LL H.262 SNR@ML H.262 Spatial@H14L H.262 HP@ML H.262 HP@H14L H.262 HP@HL	11172-3 Layer 2	11172-3 Layer 3 13818-3 Layer 1 13818-3 Layer 2 13818-3 Layer 3 G.711 G.722 G.728 G.723.1 G.729 Annex A/G.729
RAST-1 RAST-5 RAST-1&5	Native mode	H.262 MP@ML	H.261 QCIF H.261 CIF H.262 MP@H14L H.262 MP@HL H.262 SNR@LL H.262 SNR@ML H.262 Spatial@H14L H.262 HP@ML H.262 HP@H14L H.262 HP@HL H.263 SQCIF H.263 QCIF H.263 CIF H.263 4CIF H.263 16CIF	G.711	11172-3 Layer 1 11172-3 Layer 2 11172-3 Layer 3 13818-3 Layer 1 13818-3 Layer 2 13818-3 Layer 3 G.722 G.728 G.723.1 G.729 Annex A/G.729

Table 3/H.310 – Audiovisual capabilities of H.310 terminals (concluded)

Terminal type		Audiovisual capabilities			
		Video		Audio	
		Mandatory	Optional	Mandatory	Optional
RAST-1 RAST-5 RAST-1&5	H.320/1 mode	H.261 QCIF H.261 CIF	H.262 MP@ML H.262 MP@H14L H.262 MP@HL H.262 SNR@LL H.262 SNR@ML H.262 Spatial@H14L H.262 HP@ML H.262 HP@H14L H.262 HP@HL H.263 SQCIF H.263 QCIF H.263 CIF H.263 4CIF H.263 16CIF	G.711	11172-3 Layer 1 11172-3 Layer 2 11172-3 Layer 3 13818-3 Layer 1 13818-3 Layer 2 13818-3 Layer 3 G.722 G.728 G.723.1 G.729 Annex A/G.729

6.3.1.1 Unidirectional video capabilities

Unidirectional H.310 terminals are not required to support any of the H.261 or H.263 video coding modes.

6.3.1.2 Bidirectional video capabilities

All H.310 bidirectional terminals shall support Recommendation H.261 with both the Common Intermediate Format (CIF) and Quarter CIF (QCIF) picture resolutions. This enables the interworking between H.310 and a wide range of existing and future H.320/H.321 terminals.

Bidirectional terminals have the option of supporting Recommendation H.263 with any of the picture formats and any of the optional modes.

6.3.2 Audio capabilities

The mandatory and optional video and audio capabilities are summarized in Table 3.

6.3.2.1 Unidirectional audio capabilities

Unidirectional H.310 terminals shall support ISO/IEC 11172-3 audio Layer 2.

The support of ISO/IEC 11172-3 Layer 3, ISO/IEC 13818-3, and ITU-T G-series audio Recommendations is optional.

6.3.2.2 Bidirectional audio capabilities

All bidirectional H.310 terminals shall support Recommendation G.711 (both A-law and μ -law). This enables existing and future H.320/H.321 terminals to interwork with H.310 terminals.

Bidirectional terminals may optionally support one or more of the following audio Recommendations: G.722 at 64 kbit/s, G.722 at 56 kbit/s, G.722 at 48 kbit/s, G.723.1 at either 5.3 or 6.3 kbit/s, G.728 (16 kbit/s), G.729 (8 kbit/s), and Annex A/G.729 (8 kbit/s).

The support of ISO/IEC 11172-3 and ISO/IEC 13818-3 audio standards is optional.

6.3.3 Data capabilities

The support of data protocols is optional in H.310 terminals. Data protocols may be multiplexed with other audiovisual information by using either the H.222.1 or ATM layer multiplexing functions.

T.120 is the default basis of data interoperability between an H.310 terminal and other H.310, H.320, H.321, H.322, H.323 or H.324 terminals. When any optional data application is implemented using one or more of the ITU-T Recommendations which can be negotiated via H.245, the equivalent T.120 applications shall be one of those provided (if such applications have been recommended by the ITU-T). A terminal that provides far-end camera control using H.281 and H.224 is not required to also support a T.120 far-end camera control protocol. Another exception is transparent user data.

6.3.4 Network Adaptation Capabilities (NAC)

The network adaptation capabilities of H.310 terminals include the multimedia multiplex and synchronization mechanism, ATM adaptation layer, transfer rate, and ATM VC capabilities.

The mandatory and optional network adaptation capabilities are summarized in Table 4.

Table 4/H.310 – Network adaptation capabilities of H.310 terminals

Terminal type		Network adaptation capabilities							
		Multimedia multiplex		AAL for audiovisual data		Number of ATM VCs		Transfer rate (kbit/s)	
		Mandatory	Optional	Mandatory	Optional	Mandatory	Optional	Mandatory	Optional
ROT-1 SOT-1		H.222.1 TS	H.222.1 PS	AAL 1	AAL 5	2	> 2	6144 9216	n*64
ROT-5 SOT-5		H.222.1 TS	H.222.1 PS	AAL 5	AAL 1	2	> 2	6144 9216	n*64
ROT-1&5 SOT-1&5		H.222.1 TS	H.222.1 PS	AAL 1 AAL 5	–	2	> 2	6144 9216	n*64
RAST-1	Native mode	H.222.1 TS	H.222.1 PS	AAL 1	AAL 5	2	> 2	6144 9216	n*64
	H.320/1 mode	H.221	–	AAL 1	–	2	> 2	B 2B H0	n × B n × H0 H ₁₁ H ₁₂
RAST-5	Native mode	H.222.1 TS	H.222.1 PS	AAL 5	AAL 1	2	> 2	6144 9216	n*64
	H.320/1 mode	H.221	–	AAL 5	–	2	> 2	B 2B H0	n × B n × H0 H ₁₁ H ₁₂
RAST-1&5	Native mode	H.222.1 TS	H.222.1 PS	AAL 1 AAL 5	–	2	> 2	6144 9216	n*64
	H.320/1 mode	H.221	–	AAL 1 AAL 5	–	2	> 2	B 2B H0	n × B n × H0 H ₁₁ H ₁₂

6.3.4.1 Multimedia multiplex and synchronization

Multiplexing of audio, video, data, and control signals in H.310 terminals is accomplished using the multimedia multiplex protocols and procedures defined in Recommendations H.221 and H.222.1. Recommendation H.222.1 specifies both H.222.0 and H.222.1 specific functions (e.g. error protection, jitter removal, ITU-T defined stream_id and descriptors, etc.).

H.310 terminals may support multiple instances of H.222.0/H.222.1. In this case ATM layer multiplexing is also used, since there is one instance of H.222.0/H.222.1 per ATM VC.

All H.310 terminals shall support Recommendations H.222.0/H.222.1 for the multiplexing and synchronization of video, audio, data, and control signals. The support of H.222.1 Transport Stream multiplexing is mandatory for all H.310 terminals. The support of H.222.1 Program Stream multiplexing is optional for H.310 terminals.

All bidirectional H.310 terminals shall support Recommendation H.221 for interworking with H.320 and H.321 terminals.

NOTE – Unidirectional H.310 terminals are not required to support the H.221 multiplexing capability.

6.3.4.2 ATM adaptation layer

The different types of signals supported by H.310 terminals require different ATM adaptation layer functions. The H.310 AAL capabilities for the multimedia multiplexed, in-band signalling, and out-of-band signalling data signals are specified.

AAL Segmentation And Reassembly (SAR) and Convergence Sublayer (CS) functions are supported by H.310 terminals. Both AAL types 1 and 5 are used for the transfer of the multiplexed constant bit rate signals over ATM networks.

NOTE 1 – The definition of AAL functions and capabilities for the adaptation of variable bit rate audiovisual signals is under study.

Data protocols may either be multiplexed with other audiovisual elementary streams using the H.222.1 multiplex layer or be multiplexed at the ATM layer.

H.245 messages may either be multiplexed with other audiovisual elementary streams using the H.222.1 multiplex layer or be multiplexed at the ATM layer. The protocol stacks for these two means of multiplexing are specified in Annex A, and are referred to as "single VC" and "separate VC" respectively.

H.310 terminals support the Q.2931 protocol stack for performing out-of-band call management and signalling functions. In addition to the Q.2130 (SSCS.UNI) and Q.2110 (SSCOP) layers, the AAL 5 CPCS and SAR sublayers represent an integrated part of the Q.2931 protocol stack.

The use of AAL type 1

RAST-1 and RAST-1&5 terminals shall support the adaptation of H.221 multiplexed audiovisual data using the AAL 1 SAR and CS functions which are defined in Recommendation I.363.1 and supported in H.321 Annex A terminals. This will enable the interworking between H.310 and H.321/Annex A terminals.

RAST-1 and RAST-1&5 terminals shall support the adaptation of H.222.1 multiplexed bit streams into ATM using AAL type 1. The mode of AAL 1 with no FEC and no interleaving shall be supported, and the mode with (128, 124) Reed-Solomon Forward Error Correction (FEC) code without interleaving may optionally be supported¹.

ROT-1, ROT-1&5, SOT-1, and SOT-1&5 terminals shall support the adaptation of H.222.1 multiplexed bit streams into ATM using AAL type 1. The mode of AAL 1 with no FEC and no interleaving shall be supported, and the mode with (128, 124) Reed-Solomon Forward Error Correction (FEC) code with interleaving may optionally be supported¹.

Neither the Structure Data Transfer (SDT) mode nor the Synchronous Residual Time Stamp (SRTS) of AAL type 1 is supported by H.310 terminals for the transfer of H.222.1 multiplexed data.

NOTE 2 – H.310 terminals that operate in the H.320/H.321 Annex A communication mode shall support the AAL type 1 SDT functions when doing so.

All bidirectional H.310 terminals shall be capable of interworking. For RAST-5 terminals, and RAST-1&5 terminals when working with AAL 5, a gateway in the customer premises network shall be used to provide the AAL 1 adaptation function.

The use of AAL type 5

RAST-5 and RAST-1&5 terminals shall support the adaptation of H.221 multiplexed audiovisual data into ATM using the AAL 5 SAR and CPCS functions which are defined in Recommendation I.363.5. This will enable the interworking between H.310 and H.321 terminals.

ROT-5, ROT-1&5, SOT-5, SOT-1&5, RAST-5, and RAST-1&5 terminals shall support the adaptation of H.222.1 multiplexed bit streams into ATM using AAL type 5.

The rules and protocols used for the mapping of H.222.1 Program Stream and Transport Stream packets into the AAL 5 Protocol Data Unit (PDU) is specified in Recommendation H.222.1. Only SAR and common part CS (CPCS) functions are supported as defined in Recommendation I.363.5. Therefore, Service Specific Convergence Sublayer (SSCS) functions are neither defined nor supported by H.310 AAL 5 unidirectional terminals.

When detecting an errored cell (using the CRC function of the AAL 5 CPCS sublayer), the AAL 5 PDU may be passed to the user (i.e. H.222.1) according to the corrupted-data delivery option specified in Recommendation I.363.5.

The usage of the AAL 5 CPCS User-To-User (CPCS-UU) indication field is not specified in this Recommendation. Moreover, in H.310 SOT terminals, the Common Part Indicator (CPI) field shall always be set to zero (i.e. only the 64-bit alignment function is used).

6.3.4.3 ATM virtual connections

All H.310 terminals shall support at least two ATM VCs. In the native H.310 communication mode, there shall be one VC for the transfer of H.245 messages and at least one VC for H.222.1 multiplexed audiovisual and data signals. In the H.320/H.321 interoperation mode, two VCs shall be supported for the transfer of two B-channel signals.

Additional VCs may optionally be used for transfer of audiovisual and/or data signals, such as T.120 data, or for other purposes.

¹ These specifications are in alignment with Recommendation J.82 "Transport of MPEG-2 constant bit rate television signals in B-ISDN". Note that Recommendation J.82 specifies the mandatory use of (128, 124) Reed-Solomon Forward Error Correction Code with interleaving.

6.3.4.4 Transfer rate

H.310 terminals are capable of supporting a wide range of possible transfer rates. The transfer rate capabilities of H.310 terminals are defined at the AAL-SAP.

Bidirectional H.310 terminals shall support the B, 2B, and H0 narrow-band ISDN transfer rates of H.320/H.321 terminals. Other H.320/H.321 rates (e.g. H₁₁ and H₁₂) are optional. This will enable the interworking of H.310 terminals with a wide range of H.320/H.321 terminals.

All H.310 terminals shall support constant bit rate transfer rates for native H.310 communication mode. The mandatory transfer rates are P = 6.144 Mbit/s (for MP@ML medium quality services) and Q = 9.216 Mbit/s (for MP@ML high quality services) where P/Q is 2/3. Other optional rates of $n \times 64$ kbit/s (n is an integer from 1 to 65 535) can be negotiated through H.245 capability messages and related procedures.

NOTE – Until an appropriate network environment is available everywhere, it would be desirable that all terminals support a rate of 90×64 kbit/s, compatible with a VC-2 (Virtual Container 2).

The specification of VBR transfer rates is under study.

6.3.5 Signalling capabilities

The mandatory and optional signalling capabilities are summarized in Table 5.

Table 5/H.310 – Signalling capabilities of H.310 terminals

Terminal type		Signalling capabilities			
		User-to-user signalling		User-to-network signalling	
		Mandatory (Rec.)	Optional	Mandatory (Rec.)	Optional
ROT-1 SOT-1 ROT-5 SOT-5 ROT-1&5 SOT-1&5		H.245	DSM-CC UU	Q.2931	DSM-CC UN
RAST-1	Native mode	H.245	DSM-CC UU	Q.2931	DSM-CC UN
	H.320/1 mode	H.242/H.230	–	Q.2931	–
RAST-5	Native mode	H.245	DSM-CC UU	Q.2931	DSM-CC UN
	H.320/1 mode	H.242/H.230	–	Q.2931	–
RAST-1&5	Native mode	H.245	DSM-CC UU	Q.2931	DSM-CC UN
	H.320/1 mode	H.242/H.230	–	Q.2931	–

6.3.5.1 User-to-network signalling

All H.310 terminals shall support Recommendation Q.2931 for user-to-network signalling.

6.3.5.2 User-to-user signalling

All H.310 terminals shall support H.245 messages and procedures for user-to-user signalling. The exact set of H.245 messages and procedures that are mandated in H.310 terminals, and their usage, are specified in 6.4. H.245 signalling is only supported in the native H.310 communication mode.

All bidirectional H.310 terminals shall support Recommendations H.242 and H.230 for interworking with H.320 and H.321 terminals.

6.3.5.3 Video Frame Synchronous (VFS) Control and Indication (C&I) signalling

VFS C&I signalling is accomplished using the syntax given in Table 6. All H.310 terminals shall support this syntax and shall react to all the signals classified as controls in the appropriate way specified below. Terminals are not required to react to any of the signals classified as indications, but may optionally do so. The set of indications which invoke an action is implementation dependent. The reaction, if any, to each indication signal is also implementation dependent.

Table 6/H.310 – Syntax for H.310 video frame synchronous control and indication signals

H310-TERMINAL-MANAGEMENT DEFINITIONS AUTOMATIC TAGS ::=	
BEGIN	
<i>-- Export all symbols</i>	
VideoFrameSynchronousCandIPDU	::= SEQUENCE
{	
elementaryStream	CHOICE
{	
ts-PID	INTEGER (1..8191),
ps-StreamID	SEQUENCE
{	
streamID	INTEGER (0..255),
streamIDExtension	INTEGER (0..255) OPTIONAL
},	
...	
},	
resourceID	INTEGER (0..65535) OPTIONAL,
videoFrameSynchronousCandI	CHOICE
{	
videoFrameSynchronousControl	VideoFrameSynchronousControl,
videoFrameSynchronousIndication	VideoFrameSynchronousIndication,
...	
},	
...	
}	
VideoFrameSynchronousControl	::= CHOICE
{	
nonStandard	NonStandardParameter,
videoFreezePictureReleaseControl	NULL, -- not used for Recommendation H.261
...	or H.263
}	

VideoFrameSynchronousIndication	::= CHOICE
{	
nonStandard	NonStandardParameter,
closedCaption	OCTET STRING,
splitScreenIndication	NULL, <i>-- not used for Recommendation H.261</i>
	<i>or H.263</i>
documentCameraIndication	NULL, <i>-- not used for Recommendation H.261</i>
	<i>or H.263</i>
...	
}	
NonStandardParameter	::= SEQUENCE
{	
nonStandardIdentifier	NonStandardIdentifier,
data	OCTET STRING
}	
NonStandardIdentifier	::= CHOICE
{	
object	OBJECT IDENTIFIER,
h221NonStandard	SEQUENCE
{	
t35CountryCode	INTEGER (0..255),
t35Extension	INTEGER (0..255),
manufacturerCode	INTEGER (0..65535)
}	
}	
END	

The following video frame synchronous control and indication signals shall be supported by all H.310 terminals:

- video freeze picture release control;
- split-screen indication;
- document camera indication;
- closed caption.

Syntax

The syntax for Video Frame Synchronous (VFS) Control and Indication (C&I) is specified using the notation defined in ASN.1 [38] and is shown in Table 6. Messages shall be encoded for transmission by applying the packed encoding rules specified in [39] using the basic aligned variant. The first bit in each octet which is transmitted is the most significant bit of the octet as is specified in Recommendation X.691.

This information is packed in PES packets, and Presentation Time Stamp (PTS) shall be used for timing the event. Multiple **VideoFrameSynchronousCandIPDUs** can exist in a single PES packet.

The PES packets including VFS C&I information shall be transmitted in the video synchronous subchannel of the ITU-T H.222.1 type C elementary stream as specified in Recommendation H.222.1. If the VFS C&I information is delivered in a Transport Stream (TS), the **stuffing_byte** field of the TS adaptation_field() defined in Recommendation H.222.0 shall be used for alignment with the TS packets.

Semantics

The elementary stream to which the VFS control or indication is applied, the target elementary stream, shall be specified using **ts-PID** if it is included in a Transport Stream. This field shall have the identical value with the **PID** field of the target elementary stream, which is specified in Table 2-3/H.222.0.

A target elementary stream included in a Program Stream shall be specified using **streamID**. If the target elementary stream is a Recommendation H.222.1 type A-E stream, **streamIDExtension** shall be used additionally. These fields shall have identical values with the **stream_id** and **stream_ID_extension** fields of the target elementary stream, which are specified in Tables 2-34/H.222.0 and 2/H.222.1.

resourceID shall be present only in the case when a VFS C&I is applied to an elementary stream included in a different Transport Stream or Program Stream.

Procedures

For the VFS C&I signals that can be signified at the video stream level, such as "video freeze picture release control", "split-screen indication", and "document camera indication" which are provided in Recommendations H.261 and H.263, the video synchronous subchannel shall not be used for transmission. The following are the procedures of H.310 VFS C&I signals:

a) *Freeze picture release control*

This control is signified by **videoFreezePictureReleaseControl** or the "video freeze picture release control" signal embedded in the video elementary stream (i.e. Recommendation H.261 or H.263). When a decoder receives **videoFreezePicture** specified in Recommendation H.245, it shall complete updating of the current video frame but subsequently display the frozen picture. The picture shall be frozen until **videoFreezePictureReleaseControl** is received or a timeout period of at least six seconds has expired (this specification is the same as in Recommendation H.230). If a terminal or a Multipoint Control Unit (MCU) wishes to continue the freezing of the picture at the remote end more than six seconds, it should send **videoFreezePicture**/H.245 repeatedly with an appropriate period.

NOTE – When H.262 streams are switched by an MCU, the switched stream shall start with an H.262 sequence_header().

b) *Closed caption*

This information is transmitted using the **closedCaption** field in the **OCTET STRING** format. The detailed usage of this indication is defined in the specification of each individual application.

c) *Split-screen indication*

This indication is signified by **splitScreenIndication** or the "split-screen indication" signal embedded in the video elementary stream (i.e. Recommendation H.261 or H.263). The indication can be transmitted when the transmitted picture is in the split-screen state defined in Recommendation H.100. An example of the response to this indication at the receiving terminal is presenting each segment of the picture on a separate monitor.

d) *Document camera indication*

This indication is signified by **documentCameraIndication** or the "document camera indication" signal embedded in the video elementary stream (i.e. Recommendation H.261 or H.263). The indication can be transmitted when the transmitted frame includes still picture information, for example documents. An example of the response to this indication at the receiving terminal is holding and presenting the still picture on a separate monitor.

6.4 The use of the H.245 control channel

All H.310 terminals shall support H.245 messages and procedures in the native H.310 communication mode. The exact set of H.245 messages and procedures that are mandated in H.310 terminals, and their usage, are specified in this subclause.

The H.245 control channel carries end-to-end control messages governing operation of the H.310 system, including capabilities exchange, opening and closing of logical channels, mode preference requests, round trip delay, maintenance loop and master slave determination.

There shall be exactly one control channel in each direction within H.310 systems, which shall use the messages and procedures of Recommendation H.245. The H.245 control channel shall be set up at the beginning of communication, before the transmission of audiovisual information.

Recommendation H.245 specifies a number of independent protocol entities which support terminal-to-terminal signalling. A protocol entity is specified by its syntax (messages), semantics, and a set of procedures which specify the exchange of messages and the interaction with the user. H.310 terminals shall support the syntax, semantics and procedures of the following protocol entities, as specified in the following subclauses:

- Master slave determination.
- Capabilities exchange.
- Logical channel signalling.
- Bidirectional logical channel signalling.
- Close logical channel signalling.
- Mode request.
- Round trip delay determination.
- Maintenance loop signalling.
- Specific commands and indications.

Figure 4 shows the interaction between the H.245 protocol entities and H.310.

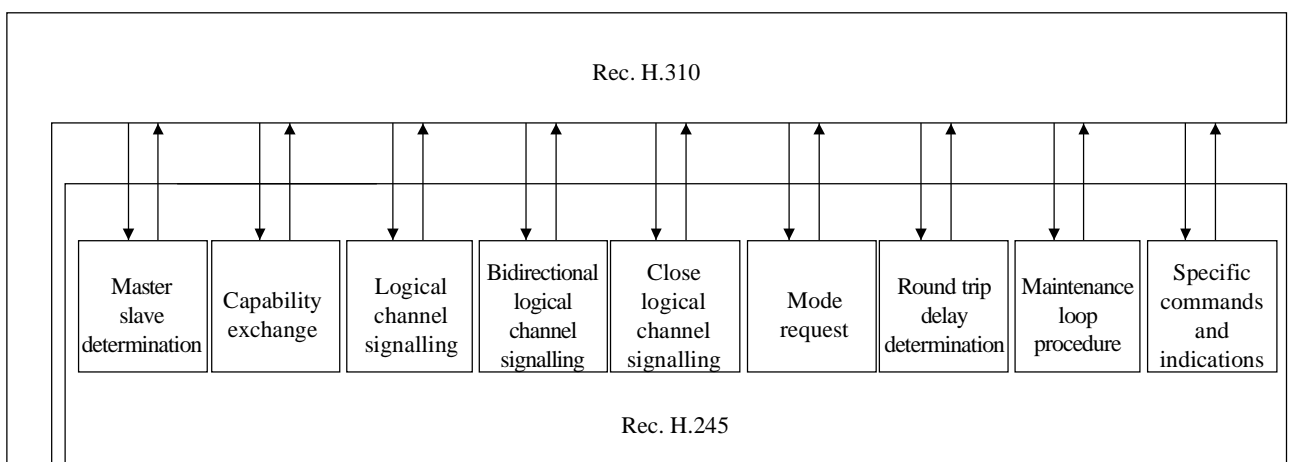

Figure 4/H.310 – Configuration of H.245 entities in H.310 terminal

All H.245 messages are conveyed by the underlying protocol stack, as specified in Annex A, which provides a reliable end-to-end transmission of H.245 messages using acknowledgement of correct receipt within each layer protocol.

H.310 terminals shall be capable of identifying all H.245 **MultimediaSystemControlPDU** messages, and shall respond to all messages needed to realize required H.310 functions. H.310 terminals shall send the **FunctionNotSupported** message in response to unrecognized request, response, command or the H.245 message which is not supported by the H.310 terminal.

Non-standard capabilities and control messages may be issued using the **NonStandardParameter** structure defined in Recommendation H.245. Note that while the meaning of non-standard messages is defined by individual organizations, equipment built by any manufacturer may signal any non-standard message, if the meaning is known.

All timers defined in Recommendation H.245 should have periods of at least the maximum data delivery time allowed by the layer carrying H.245, including any retransmissions.

The following subclauses outline the sequence of primitives exchanged between H.310 and the H.245 entities. Restrictions, which are applied to the direction from the H.310 entity to the H.245 entities, to the sequence of primitives defined in Recommendation H.245 are stated in the following subclauses.

6.4.1 Master slave determination

Master slave determination shall follow the procedures of Recommendation H.245, which provides the mechanism on an even basis to determine which is the master terminal and which is the slave terminal. The master terminal will be permitted to manage the resource limited to only one avoiding the simultaneous initiation of similar events by two or more terminals. The master terminal has precedence where conflict of requests occurs.

There shall be exactly one MSDSE in one H.310 terminal. The H.310 terminal can start the master slave determination procedure by issuing DETERMINE.request primitive to its MSDSE without parameter.

When the DETERMINE.confirm primitive is received from the MSDSE after DETERMINE.request was issued, the master slave determination has been successfully completed and confirmed by the peer terminal. The result of determination is indicated in the TYPE parameter of the DETERMINE.confirm primitive. If the REJECT.indication primitive is received instead, the determination procedure has failed. The H.310 terminal may reissue DETERMINE.request for retrying the master slave determination. When DETERMINE.indication is received, the peer terminal has also invoked the master slave determination procedure and H.310 shall follow the incoming side protocol described below. DETERMINE.request shall not be issued until DETERMINE.confirm or REJECT.indication primitive is received, after DETERMINE.request has been issued.

When the peer terminal invoked the master slave determination procedure, H.310 will receive DETERMINE.indication from the MSDSE. The TYPE parameter in DETERMINE.indication indicates the preliminary result of master slave determination. However, it is necessary to confirm the result between the local and remote terminals. Therefore, H.310 shall wait for the DETERMINE.confirm primitive. When the ERROR.indication primitive is received, mismatch of state between local MSDSE and remote MSDSE may have occurred. It should be noted that REJECT.indication will follow ERROR.indication in some error situations. In these cases, the previously received result indicated by the TYPE parameter in the DETERMINE.indication primitive shall be discarded and ignored. DETERMINE.request shall not be issued until DETERMINE.confirm or REJECT.indication primitive is received, after DETERMINE.indication has been received.

At the start of the communication, the H.310 terminal shall not have a preference that it is a master or a slave. H.245 procedures in which the master and slave distinction is necessary (see Table 7), shall not be initiated until the master/slave status has been determined.

Only one random number shall be chosen by the terminal for one call, except in the case of identical random numbers, as described in Recommendation H.245. It should be noted that identical means identical modulo 2^{23} .

Terminals may reinvoked the master slave determination if necessary, according to the procedures described above. The value of counter N100 is 3 for H.310 terminal.

Table 7/H.310 – Necessity of the master slave determination procedure

H.245 procedure	Master/slave result is required?
Master slave determination	Irrelevant
Capabilities exchange	No
Logical channel signalling	Yes
Bidirectional logical channel signalling	Yes
Close logical channel signalling	No
Mode request	Yes
Round trip delay determination	No
Maintenance loop signalling	Yes
Specific commands and indications	No

6.4.2 Capabilities exchange

Capabilities exchange shall follow the procedures of Recommendation H.245, which provides for separate receive and transmit capabilities.

Receive capabilities describe the terminals ability to receive and process incoming information streams. Transmitters shall limit the content of their transmitted information to that which the receiver has indicated it is capable of receiving. The absence of a receive capability indicates that the terminal cannot receive (is a transmitter only).

Transmit capabilities describe the terminals ability to transmit information streams. Transmit capabilities serve to offer receivers a choice of possible modes of operation, so that the receiver may request the mode which it prefers to receive.

There shall be exactly one outgoing CESE and one incoming CESE in one H.310 terminal. H.310 terminal can start the capability exchange procedure by issuing TRANSFER.request primitive to its outgoing CESE with proper parameters. The value of PROTOID parameter shall be "1" for terminals conforming to this Recommendation. MUXCAP and CAPDESCRIPTORS parameters with at least one capability set is mandatory for the H.310 terminal. Though the use of CAPTABLE parameter is optional, CAPTABLE parameter is required at the start of the communication, because the remote terminal does not have any knowledge about capability table entries which are referred to by the CAPDESCRIPTORS parameter. When H.310 terminal reinvokes the capability exchange procedure after the successful completion of a capability exchange, CAPTABLE can be omitted provided that CAPTABLEentries are not changed from those that have already been transmitted.

When the TRANSFER.response primitive is received from the outgoing CESE after TRANSFER.request has been issued, the capability message has been successfully transmitted to the peer terminal. If the REJECT.indication primitive is received instead, the previously sent capability message has not been accepted by the peer terminal (SOURCE=USER), or the timer has expired before receiving the response from the peer terminal (SOURCE=PROTOCOL). The H.310 terminal may reissue the TRANSFER.request primitive for retrying the capability message transmission in these cases. TRANSFER.request shall not be issued until TRANSFER.confirm or REJECT.indication primitive has been received, after TRANSFER.request has been issued.

H.310 shall respond to the TRANSFER.indication primitive received from the incoming CESE, by issuing the TRANSFER.response primitive if the capabilities can be accepted successfully, or by issuing the REJECT.request primitive if the capabilities are not acceptable. The H.310 terminal may receive REJECT.indication, before responding to TRANSFER.indication. In this case, H.310 shall discard and ignore the contents of the previously received TRANSFER.indication and shall not respond to that indication until a new TRANSFER.indication is received.

At the start of the communication, the H.310 terminal shall recognize that its own transmit capability declared to the remote terminal and the receive capability of remote terminal are null. Therefore, audiovisual communication cannot be started before the capability exchange procedure is carried out. The H.310 terminal can update its knowledge about its own declared and remote capabilities, only after the capability exchange procedure has been successfully completed.

Terminals may reinvoke the capability exchange procedure at any time, according to the procedures described above.

6.4.3 Logical channel signalling

Each logical channel carries information from a transmitter to a receiver, and is identified by a logical channel number unique for each direction of transmission.

Logical channels are opened and closed using the **OpenLogicalChannel** and **CloseLogicalChannel** messages and procedures of Recommendation H.245.

When a logical channel is opened, the **OpenLogicalChannel** message fully describes the content of the logical channel, including media type, algorithm in use and any options, and all other information needed for the receiver to interpret the contents of the logical channel. Logical channels may be closed when no longer needed.

Certain media types, including data protocols such as T.120, inherently require a bidirectional channel for their operation. In such cases a bidirectional logical channel, which is capable of information transmission in both directions, may be opened using the bidirectional channel opening procedures of Recommendation H.245.

NOTE 1 – A pair of unidirectional logical channels, each of which is opened by the open logical channel procedure, can be applied to a bidirectional operation of those media providing the transmission in each direction. However, the use of bidirectional logical channel is strongly recommended for bidirectional media in this Recommendation.

Bidirectional logical channels in H.310 may have asymmetrical characteristics, such that the medium type in each direction of transmission might be different.

H.310 supports multiple logical channels. There shall be one outgoing LCSE and one incoming LCSE for each logical channel. There shall also be one outgoing CLCSE and one incoming CLCSE managing the same logical channel as an incoming LCSE and an outgoing LCSE, respectively. H.310 terminal can start the open logical channel procedure by issuing the ESTABLISH.request primitive to its outgoing LCSE of the required logical channel with proper parameters.

FORWARD_PARAM parameter describes the content of the logical channel, which will be transferred by the **OpenLogicalChannel** message to the peer terminal.

When the ESTABLISH.response primitive is received from the outgoing LCSE after ESTABLISH.request was issued, the logical channel is successfully opened and H.310 terminal can start audiovisual information transmission through this logical channel. If the REJECT.indication primitive is received instead, either the open logical channel request has not been accepted by the peer terminal (SOURCE=USER), or the timer has expired before receiving a response from the peer terminal (SOURCE=LCSE). The H.310 terminal may reissue the ESTABLISH.request for retrying the open logical channel request in these cases.

H.310 may close a logical channel which has been successfully opened by issuing the RELEASE.request primitive at the outgoing LCSE. The RELEASE.confirm primitive is passed to H.310 when the logical channel has been successfully closed. If the ERROR.indication primitive precedes the RELEASE.confirm primitive, then the local timer has expired before a response was received from the peer terminal.

Before the ESTABLISH.confirm or the RELEASE.indication primitive is received in response to an earlier ESTABLISH.request, H.310 may close the logical channel using the RELEASE.indication primitive at the outgoing LCSE.

Before the RELEASE.confirm primitive is received in response to a previously sent RELEASE.request primitive, H.310 may establish the logical channel using the ESTABLISH.request primitive at the outgoing LCSE.

When the ERROR.indication primitive is received from the outgoing LCSE, a timer expiry or a mismatch of state has occurred and the logical channel has been closed. The ERROR.indication primitive is followed by either the RELEASE.indication or the RELEASE.confirm primitive.

The H.310 terminal shall respond to the ESTABLISH.indication primitive received from the incoming LCSE, by issuing ESTABLISH.response if the opening of the logical channel can be accepted, or by RELEASE.request if the logical channel cannot be opened.

H.310 may receive RELEASE.indication, before responding to ESTABLISH.indication. It is no longer necessary to respond to the previous ESTABLISH.request primitive and the logical channel shall be kept closed. Whenever RELEASE.indication is received, H.310 shall regard that the logical channel is now closed and unavailable. If RELEASE.indication is followed by ESTABLISH.indication, the logical channel immediately becomes unavailable and H.310 shall decide whether new logical channel with parameters conveyed by ESTABLISH.indication is acceptable.

Incoming side of the H.310 terminal can request to close a logical channel using the close logical channel procedure by issuing the CLOSE.request primitive to outgoing CLCSE. The logical channel is kept opened unless CLOSE.confirm is received. If REJECT.indication is received, H.310 may reinvoke the close logical channel procedure.

NOTE 2 – Receipt of CLOSE.confirm indicates that the remote H.310 terminal will close the logical channel. The channel is not closed until it does so.

If H.310 receives audiovisual information through a logical channel that is not open, the receiving H.310 terminal should request the closing of that logical channel by invoking close logical channel procedure to recover from the mismatch of state of local and remote LCSEs.

When contention occurs between the open logical channel procedure and the close logical channel procedure for the same channel, the close logical channel always has a higher priority than the open logical channel. Therefore, if H.310 wants to re-open the logical channel, the open logical channel

procedure can be invoked only after the close logical channel procedure has been successfully completed.

The open bidirectional logical channel procedure is very similar to the procedure for unidirectional logical channel. The only difference is that the incoming side H.310 shall wait for ESTABLISH.confirm from the incoming B-LCSE, after H.310 responds to ESTABLISH.indication by ESTABLISH.response. Though a unidirectional channel can become active by issuing ESTABLISH.response, bidirectional channel cannot become active until ESTABLISH.confirm is received.

6.4.4 Mode request

The H.310 terminal is able to request a remote terminal to change its transmit mode of operation by using the mode request procedure of Recommendation H.245.

The terminal shall select the requesting mode of operation from the valid transmission capabilities of the peer terminal previously received by successfully completed capability exchange procedure(s). If the peer terminal is receive only, and does not have any transmission capabilities, the mode request procedure shall not be invoked.

There shall be exactly one outgoing MRSE and incoming MRSE in one H.310 terminal. The H.310 terminal can start the mode request procedure by issuing the TRANSFER.request primitive to its outgoing MRSE with proper parameters. MODE-ELEMENT parameter describes the requesting mode of operation for a remote terminal.

When the TRANSFER.response primitive is received from the outgoing MRSE after TRANSFER.request was issued, the requested mode has been accepted by the peer terminal. The contents of logical channels in the receiving direction will soon be changed by the remote terminal according to the requested communication mode. If the REJECT.indication primitive is received instead, the requested mode has not been accepted by the peer terminal (SOURCE=USER), or the timer has expired before receiving a response from the peer terminal (SOURCE=PROTOCOL). The H.310 terminal may reissue TRANSFER.request for retrying the mode request procedure with the same parameters in the latter case, or with different parameters in the former case.

NOTE – It is recommended for the H.310 terminal that TRANSFER.request should not be issued until TRANSFER.confirm or REJECT.indication primitive has been received, after TRANSFER.request has been issued.

H.310 shall respond to TRANSFER.indication received from the incoming MRSE, by issuing the TRANSFER.response primitive if the requested mode can be accepted, or by REJECT.request if the requested mode is not acceptable. The H.310 terminal may receive REJECT.indication, before responding to TRANSFER.indication. In this case, H.310 shall discard and ignore the previously received TRANSFER.indication and shall not respond to that indication until a new TRANSFER.indication is received.

Terminals may invoke the mode request procedure at any time, according to the procedures described above.

6.4.5 Round trip delay

The round trip delay procedure of H.245 enables the H.310 terminal to measure the round trip delay of H.245 message transmission between a local terminal and a remote terminal. This delay includes all the processing delay of underlying protocol layers for H.245 message transmission and H.245 message processing time of H.245 entities as well as delay in physical transmission line. This round trip delay procedure can be used to determine if the peer H.245 entity is still alive (i.e. as a keep alive function).

There shall be exactly one RTDSE in one H.310 terminal. H.310 terminal can start the round trip delay procedure by issuing TRANSFER.request primitive to its RTDSE.

When the TRANSFER.confirm primitive is received from the RTDSE after TRANSFER.request was issued, H.310 can estimate the value of the measured round trip delay using DELAY parameter in TRANSFER.confirm primitive.

NOTE – The round trip delay procedure in Recommendation H.245 specifies that the DELAY parameter indicates the value of the timer T105 which cannot be directly interpreted as delay itself. Therefore, the actual delay value is: time out value of T105 – DELAY parameter.

If EXPIRY.indication primitive is received instead, the peer H.245 entity has not responded before the local timer has expired. In this case, the remote H.245 entity may not be alive and H.245 procedures may not be usable. The local H.310 terminal may take appropriate actions, such as release the call or indicate to the human user, in this error situation.

It is not necessary for H.310 to respond to any incoming messages concerning the round trip delay procedure, because the **RoundTripDelayResponse** message is automatically issued within RTDSE in response to the **RoundTripDelayRequest** message.

Terminals may invoke the round trip delay procedure at any time, according to the procedures described above.

6.4.6 Maintenance loop

The maintenance loop procedure of Recommendation H.245 provides a maintenance loop function for the H.310 terminal.

There shall be exactly one outgoing MLSE and incoming MLSE for each logical channel, and one of each for the system loop, in one H.310 terminal. The H.310 terminal can start the maintenance loop procedure by issuing LOOP.request primitive to an outgoing MLSE with proper parameters. LOOP_TYPE parameter indicates the type of loop operation to the remote terminal.

When the LOOP.confirm primitive is received from the outgoing MLSE after LOOP.request was issued, maintenance loop operation has been established by the peer terminal. Data received from logical channels will be that transmitted by the local terminal and then looped back. If the RELEASE.indication primitive is received instead, the maintenance loop is not accepted by the peer terminal. If ERROR.indication(B) primitive is received, the timer has expired before receiving a response from the peer terminal. LOOP.request shall not be issued until LOOP.confirm or RELEASE.indication primitive is received, after LOOP.request has been issued.

When the ERROR.indication primitive is received, mismatch of state between local MLSE and remote MLSE may have occurred. In these error cases, RELEASE.indication will follow ERROR.indication, the maintenance loop procedure has failed and the state of local outgoing MLSE shall be kept not looped.

The H.310 terminal shall respond to LOOP.indication received from the incoming MLSE, by LOOP.response if the requested maintenance loop operation can be accepted, or by RELEASE.request if the maintenance loop is not acceptable.

Whenever the H.310 terminal receives RELEASE.indication, H.310 shall regard that the loop operation is released and the state of incoming MLSE immediately becomes not looped.

The H.310 terminal which invoked the maintenance loop procedure shall be responsible for releasing the looped operation, when the maintenance loop becomes unnecessary. Terminals may invoke the maintenance loop procedure at any time, according to the procedures described above.

6.4.7 Specific commands and indications

H.310 shall support the following H.245 commands and indications:

SendTerminalCapabilitySet

EncryptionCommand

FlowControlCommand

EndSessionCommand

MiscellaneousCommand

FunctionNotSupported

MiscellaneousIndication

JitterIndication

NewATMVCIIndication

NewATMVCCCommand

UserInputIndication

7 H.310 call phases

The call and signalling procedures (between two H.310 terminals or between an H.310 terminal and an H.320/H.321 terminal) described in this clause are based on the following principles:

- 1) An H.310 terminal (initiating or receiving a call) is able to identify the remote terminal type (H.320/H.321, H.310 RAST, etc.) via Q.2931 signalling at the beginning of the call (i.e. prior to audiovisual communications).
- 2) When two H.310 terminals are communicating, a default H.245 (logical) channel is established over the initial ATM VC at the beginning of the call.
- 3) When two H.310 terminals communicate, each terminal indicates its capabilities (specified in 6.3) to the remote terminal using the capabilities exchange messages and procedures described in Recommendation H.245.
- 4) When an H.310 terminal communicates with an H.320/H.321 terminal, the two terminals use the H.242 and H.230 messages and procedures for capability exchanges and other in-band signalling needs as done in H.320/H.321 terminals.
- 5) For the different types of native H.310 communication modes, in-band signalling during the call is based on H.245 messages and procedures.

Depending on the type of the two communicating terminals, an H.310 terminal shall employ one of the following two call procedures: native H.310 communication call procedures or H.320/H.321 interoperation call procedures.

7.1 Native H.310 communication call procedures

The native H.310 communication call procedures shall be supported by all unidirectional and bidirectional H.310 terminals.

The H.310 correlationID is composed of a session identification field and the 2 octet H.245 "resourceID" as indicated in Table 8. The H.245 resourceID in the H222LogicalChannelParameters is used to indicate which ATM Virtual Channel the logical channel is associated with. The session identification field is currently undefined and is reserved for future use.

Table 8/H.310 – Definition of H.310 CorrelationID

H.310 CorrelationID	
Session ID (Reserved)	H.245 resourceID

In allocating H.245 resourceIDs, the side that sets up the initial H.245 VC chooses values starting from the lowest possible value and the other side (the called side), chooses values starting from the highest in the range.

The Generic Identifier Transport (GIT) Information Element shall be used for the transmission of the H.310 correlationID in the Q.2931 SETUP message. The GIT information element is specified in Recommendation Q.2941.1.

Since the resourceID is the only valid element in the correlation ID at this time, only the resourceID is sent in the Q.2931 SETUP. This is pictorially shown in Figure 5. When coding the GIT, the identifier related standard/application is coded as this Recommendation, the identifier type as Resource, and the identifier length as two octets.

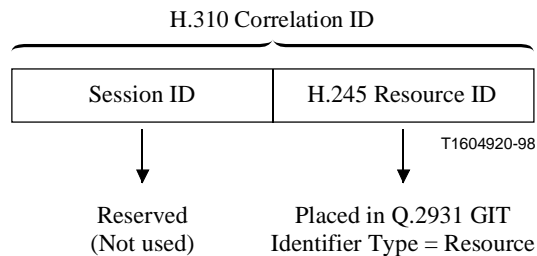
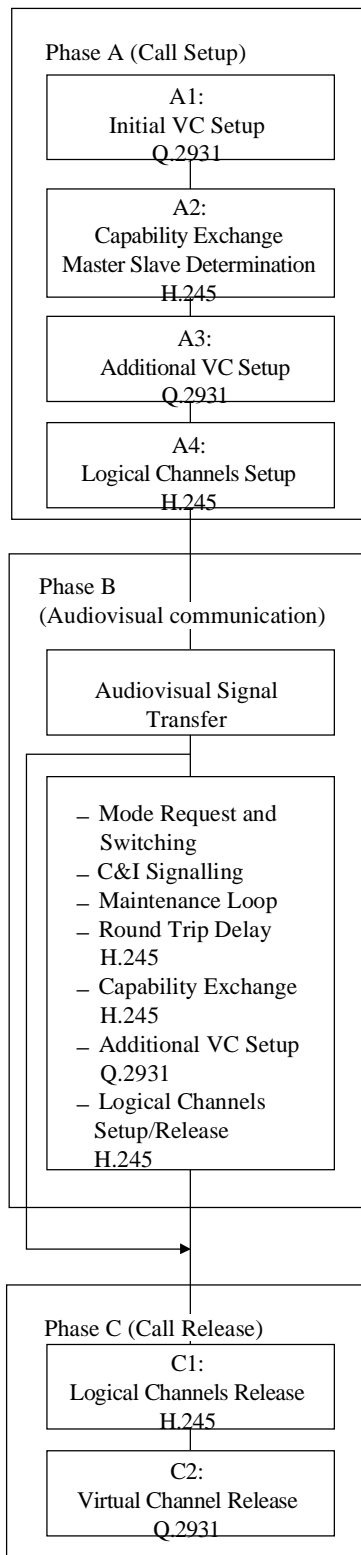

Figure 5/H.310 – Use of H.310 CorrelationID

Optionally, the H.310 correlationID may also be sent in the user-to-user information IE.

The native H.310 communication call procedures are divided into the following call phases as shown in Figure 6.



T1604930-98

Figure 6/H.310 – H.310 call phases for native H.310 communication

7.1.1 Phase A (call setup)

Phase A is a call-setup procedure phase which is divided into the following subphases.

NOTE 1 – The call procedures defined here are based on establishing two or more VCs: one for H.245 messages, and the others for the transfer of audiovisual and other data. A single-VC call procedure is under study.

Phase A1 (initial VC setup)

In this phase, the initial ATM Virtual Channel (VC) using a Q.2931 SETUP message is established. The exact parameters and DSS 2 Information Elements (IEs) used for this phase are described in Annex B.

One of the key features of this phase is that it enables an H.310 terminal (initiating or receiving a call) to either identify the type of remote H.310 terminal or infer that the remote terminal is not an H.310 terminal type. This is done by using the Broadband Bearer Capability (B-BC), Narrow-band Bearer Capability (N-BC) and other information elements of the Q.2931 SETUP message. An H.310 terminal shall set these information elements to the appropriate parameters which indicate the H.310 terminal type. If an H.310 terminal does not receive the N-BC information element from the remote terminal, then the H.310 terminal can assume that it is not communicating with an H.320/H.321 terminal.

The initial VC shall have a bit rate of 64 kbit/s at the AAL-SAP, for the transfer of H.245 messages using the separate VC stack described in Annex A.

NOTE 2 – Interaction between the arrival of the initial call and the human user is under study in the light of audio communication start up and charging aspects.

Phase A2 (capability exchange and master slave determination)

In this phase, it is assumed that each H.310 terminal has already identified that the remote terminal is an H.310 terminal type. Therefore, at this stage the two terminals shall exchange their capability information using the capability exchange signalling protocol defined in Recommendation H.245 as described in 6.4.2 over the initial VC that has been established in Phase A1. At the same time as this, the two terminals shall determine which is master and which is slave using the master slave determination signalling protocol defined in Recommendation H.245 as specified in 6.4.1. Based on the capabilities of the two terminals, an appropriate common mode of communication shall be determined.

H.310 terminals shall be capable of operating in both master and slave modes, and shall set **terminalType** to 128 and set **statusDeterminationNumber** to a random number in the range 0 to $2^{24}-1$. Only one random number shall be chosen by the terminal for each call, except in the case of identical random numbers, as described in Recommendation H.245.

Phase A3 (additional VC setup)

This paragraph applies to the case where MCU is not used in the session. In this phase, and based on the communication mode determined above, the calling terminal, that is, the one that initiated the first VC SETUP message, shall firstly indicate the characteristics of the additional VC(s) to the remote end using the H.245 **NewATMVCIndication** message, and then shall set up the additional VC(s) with the appropriate parameters, such as bit rate and AAL type, for the transfer of the audiovisual and other data between the two H.310 terminals.

NOTE 3 – This allows the remote end to receive the H.245 **NewATMVCIndication** message before responding to the VC-setup message.

This paragraph applies to the case where MCU is used in the session. If the terminal is talking to an MCU, that is, it has received the H.245 **multipointModeCommand** message, the terminal shall wait

for the H.245 **NewATMVCIndication** message or the H.245 **NewATMVCCCommand** message. In the former case, the additional VC(s) with the appropriate parameters, such as bit rate and AAL type, for the transfer of the audiovisual and other data shall be initiated by the MCU. In the latter case, the additional VC(s) with the appropriate parameters shall be initiated by the terminal.

Phase A4 (logical channels setup)

The choice of communication mode can be made by either the master or the slave. An H.310 terminal shall open the desired video, audio, data, and/or control logical channels using the logical channel signalling protocol and bidirectional logical channel signalling protocol defined in Recommendation H.245 as described in 6.4.3.

7.1.2 Phase B (audiovisual communication)

In addition to the transfer of audiovisual and other data during Phase B of the call, one or more of the following procedures may also take place.

Mode request and switching

H.310 terminals can request a new mode of audiovisual communication over the different logical channels (established over a given VC) using the mode request signalling protocol defined in Recommendation H.245 as described in 6.4.4, and can switch to a new mode using the logical channel signalling protocol and bidirectional logical channel signalling protocol, and aided by the close logical channel signalling protocol, defined in Recommendation H.245 as described in 6.4.3.

Control & Indication (C&I) signalling

H.310 terminals can use H.230-like C&I signals provided by Recommendation H.245, in addition to the video frame synchronous C&I signals defined in 6.3.5.3. Specific H.230-like C&I signals which the H.310 terminal shall support is given in 6.4.7.

Maintenance loops and round trip delay signalling

H.310 terminals can perform loops for maintenance purposes using the maintenance loop signalling protocol defined in Recommendation H.245 as described in 6.4.6. Further information is provided on maintenance loops in clause 11.

H.310 terminals can use the round trip delay signalling protocol defined in Recommendation H.245 as described in 6.4.5 to determine the round trip delay between the two terminals and also to determine if the far-end H.245 entity is "still alive".

During Phase B, depending on the capabilities of the terminals involved and the requests of users, the following procedures may also be invoked:

- capability exchange;
- additional VC setup;
- logical channels setup.

These procedures are identical to those for Phases A2, A3 and A4, respectively.

7.1.3 Phase C (call release)

Phase C is a call release procedure phase which is divided into the following subphases.

Phase C1 (logical channels release)

In this phase, all logical channels are closed and **EndSessionCommand** is transmitted, using the procedures described in Recommendation H.245.

Phase C2 (virtual channels release)

In this phase, all ATM VCs are released using the procedures described in Recommendation Q.2931.

7.2 H.320/H.321 interoperation call procedures

The H.320/H.321 interoperation call procedures shall be supported by all bidirectional H.310 RAST type terminals.

Interoperation between an H.310 RAST terminal and an H.320/H.321 terminal shall be through the use of circuit transport service which requires inclusion of both broadband and narrow-band information elements (B-BC, ATM Traffic Descriptor, AAL parameters, etc.; N-BC, N-LLC, N-HLC).

After determining that the remote terminal is an H.320/H.321 terminal type based on the Q.2931 SETUP message, an H.310 RAST terminal shall follow the call procedures described in Recommendations H.320 and H.321.

NOTE – See clause 7/H.321 for interactions between an H.310 RAST-5 terminal or a RAST-1&5 terminal when working with AAL 5, the gateway and an H.320 or H.321/Annex A terminal.

8 Multipoint communication

H.310 terminals may be used in multipoint configuration through MCUs which may be accommodated in B-ISDN, N-ISDN or other networks.

8.1 Native H.310 communication modes

When an H.310 terminal is involved in the multipoint communication, MCUs may force terminals into a particular common mode of transmission by sending to the terminal a receive capability set listing only the desired mode of transmission or by sending the **RequestMode** message. The H.310 terminal shall obey the **multipointModeCommand** message of Recommendation H.245. It shall also obey **videoFreezePicture** and **videoFastUpdatePicture** messages of Recommendation H.245 and **videoFreezePictureRelease** message of this Recommendation for the video display control.

Since each link in a multipoint configuration may be operating at different bit rates, MCUs may choose to send H.245 **FlowControlCommand** messages to limit the transmitted bit rates to those which can be sent to receivers.

8.2 H.320/H.321 interoperation modes

The requirements that apply to H.320 terminals also apply to H.310 terminals. See 4.5/H.320.

NOTE – The clock synchronization of terminals connected to different types of networks and communicating through MCU(s) is for further study.

8.3 Other aspects

Cascaded MCU operation, encryption and other aspects of multipoint communication are under study.

9 Equipment requirements

Audio level setting for G.711, G.722, G.728 is as specified in Recommendation H.320. Audio level setting for other audio coding including ISO/IEC 11172 audio, ISO/IEC 13818 audio is under study. Other aspects of equipment requirements are also under study.

10 Error resilience

10.1 Video layer

Several methods of error resilience at the video layer are provided as information in D.13/H.262.

10.2 Multimedia multiplex layer

An optional method of error resilience is defined in Recommendation H.222.1 which employs the use of two ATM virtual connections and the modified and restricted use of data partitioning specified in Recommendation H.262.

11 Maintenance loop

Some loopback functions are defined in Recommendation H.245 to allow verification of some functional aspects of the terminal, correct operation of the system and satisfactory quality of the service to the remote party. H.310 RAST terminals shall support the following loop back, as shown in Figure 6:

- a) Normal mode: no loop. Indicated in a) of Figure 7.
- b) System loop at the multiplex-AAL interface (toward the AAL interface). Upon receiving the **systemLoop** request as defined in Recommendation H.245, loopback toward the AAL side shall be made, as indicated in b) of Figure 7. The bit rate should not be changed in response to this request. Support for this loopback is mandatory for all terminals, but users may optionally disable response to it.
- c) Logical channel loopback in H.222.1 multiplex (toward the multiplex interface). Upon receiving the **logicalChannelLoop** request, each information stream for the specified logical channel should be looped back on the corresponding reverse logical channel, as indicated in c) of Figure 7. This loopback is optional, and should be used only on logical channels opened using the bidirectional channel procedures of Recommendation H.245.
- d) Media loop at analogue I/O interface (optional): Upon receiving the **mediaLoop** request as defined in Recommendation H.245, loopback of the content of the selected logical channel should be activated as close as possible to the analogue interface of the video/audio codec towards the video/audio codec, so that decoded and re-coded media content is looped, as indicated in d) of Figure 7. This loopback is optional, and should be used only on logical channels opened using the bidirectional channel procedures of Recommendation H.245.

The system loopback (**systemLoop**) request may also be used during actual conversations, for example to measure the network delay.

The message loopback off (**MaintenanceLoopOffCommand**) requires that all loopbacks currently in effect be turned off.

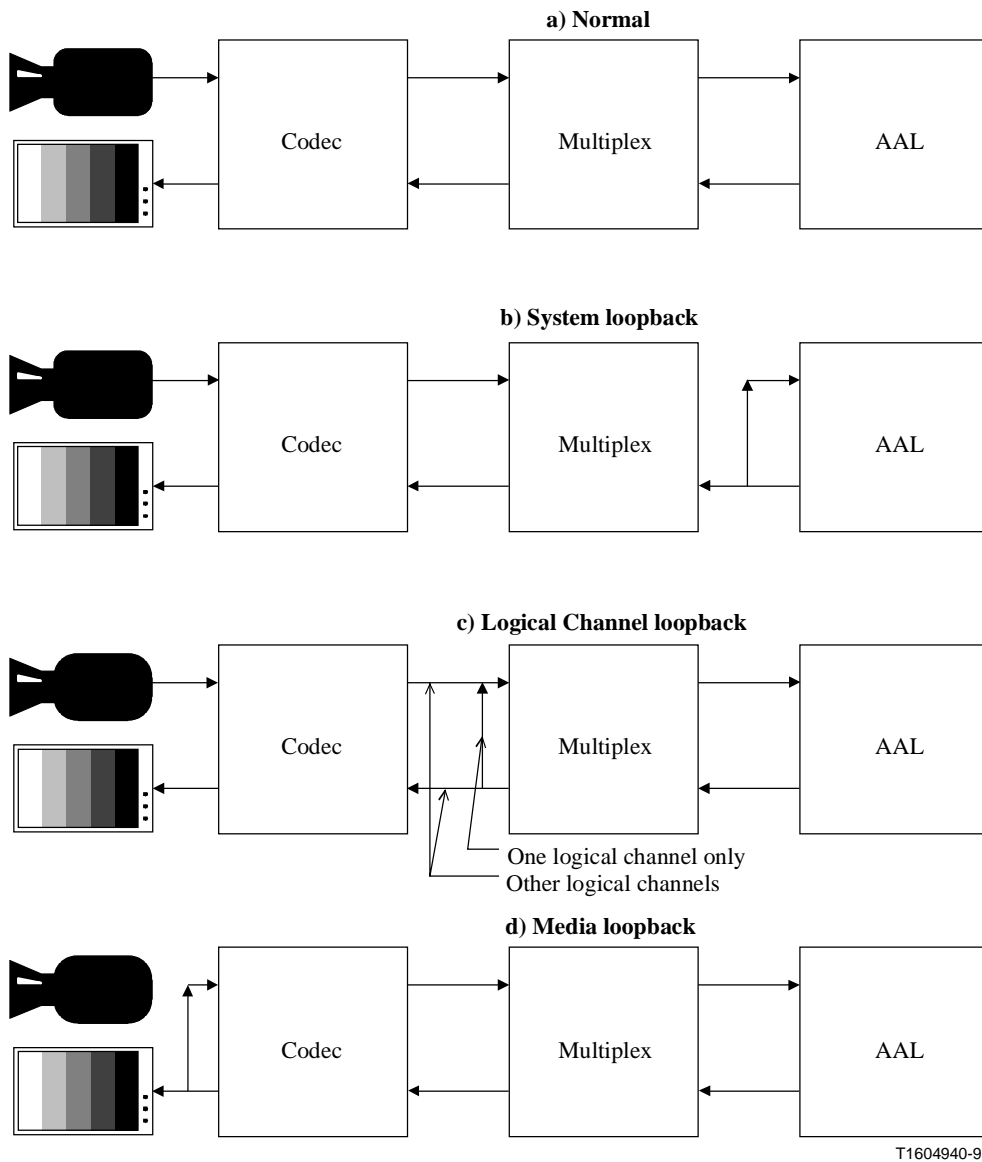

Figure 7/H.310 – Maintenance loops

12 Intercommunications

Interworking between bidirectional (RAST) H.310 terminals and H.320/H.321 is mandatory. In addition, interworking among the different types of bidirectional H.310 terminals is also mandatory. Figure 8 illustrates the interworking scenarios for H.310 terminals.

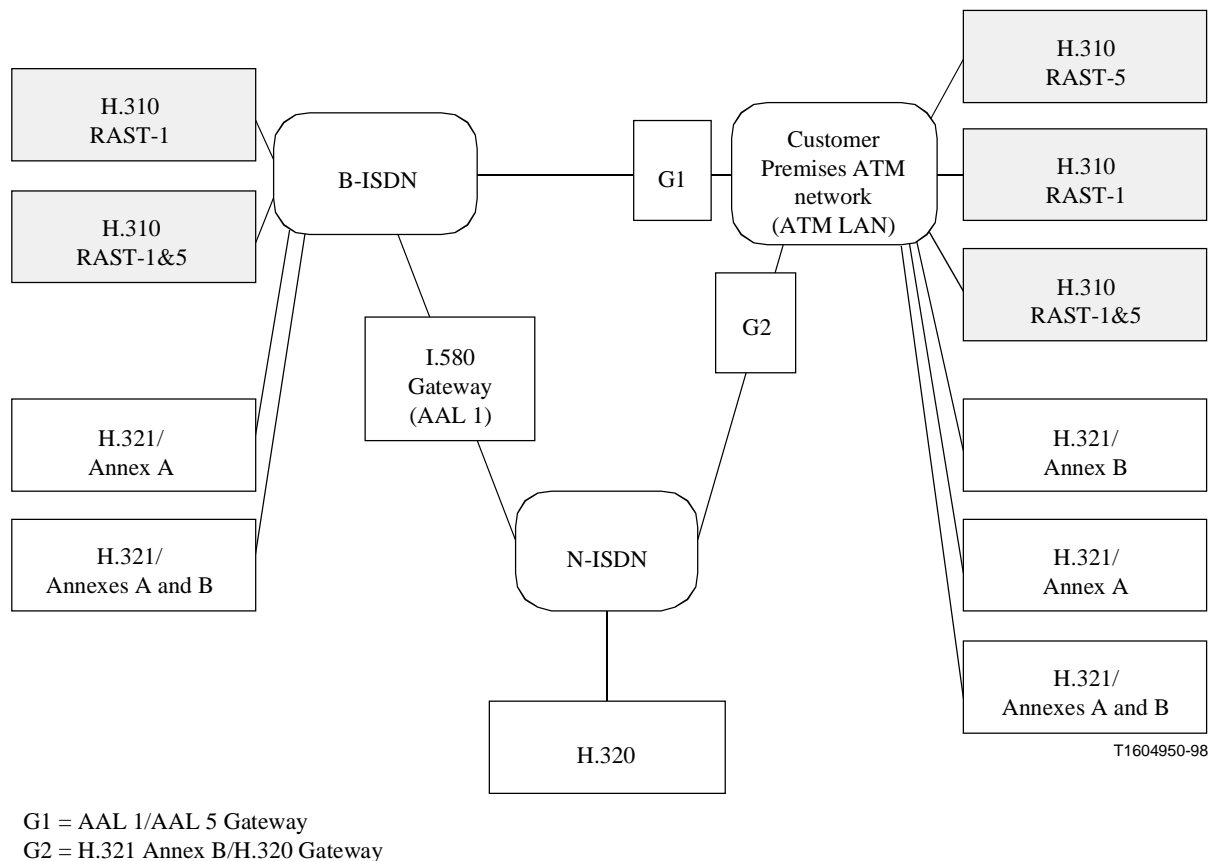

Figure 8/H.310 – Interworking of H.310 terminals

12.1 Intercommunication between different terminal types

Since the support of AAL type 1 (for the transfer of H.222.1 and H.221 audiovisual signals over B-ISDN) is mandatory for H.310 RAST-1 and RAST-1&5 terminals, these terminals can interwork with each other and with H.321 without a gateway function.

Similarly, since the support of AAL type 5 (for the transfer of H.222.1 and H.221 audiovisual signals over B-ISDN) is mandatory for H.310 RAST-5 and RAST-1&5 terminals, these terminals can interwork with each other and with H.321/Annex B without a gateway function.

RAST-5 terminals and RAST-1&5 terminals working in the AAL 5 mode shall interwork with RAST-1 terminals and RAST-1&5 terminals working in the AAL 1 mode and with H.321 with a gateway that is located in the customer premises ATM network. This gateway is needed to provide interworking functions between:

- RAST-5 and RAST-1;
- RAST-5 and RAST-1&5 working in AAL 1 mode; and
- RAST-5 or RAST-1&5 working in AAL 5 mode and H.321 terminals.

Communication procedures for the above cases a) and b) are given in Annex C, while those for case c) are given in clause 7/H.321.

Similarly, a gateway between an N-ISDN and a customer premises ATM network is needed to provide interworking functions between RAST-5 terminals and RAST-1&5 terminals working in the AAL 5 mode and H.320 terminals.

It is important to note that H.310 RAST-1 terminals and H.310 RAST-1&5 terminals can be deployed on (or interface with) both B-ISDN and customer premises ATM networks. However, H.310 RAST-5 terminals can only interface with customer premises networks.

12.2 Intercommunication with N-ISDN terminals

For interworking with H.320/H.321 terminals, all RAST terminal types shall support the following modes:

- a) H.261 CIF/QCIF.
- b) G.711.

Additionally, for interworking with H.320/H.321 terminals, all RAST terminal types shall support the following modes.

- c) H.221/H.242-H.230.
- d) 1B, 2B and H0 transfer modes.
- e) Two ATM VCs (for supporting the 2B communication mode with H.320).

NOTE – For the clock synchronization of terminals connected to different types of networks, refer to Annex C/H.321.

12.3 Intercommunication with telephony

For further study.

12.4 Intercommunication with audiovisual terminals connected to other networks

For further study.

ANNEX A

Protocol stack for control channel

This annex defines two protocol stacks for the control channel.

A.1 General

Figure A.1 shows two protocol stacks for the control channel. Two modes of operation are envisaged. Figure A.1 a) shows the protocol stack when the messages are transported in a separate ATM VC to that used for multimedia data. Figure A.1 b) shows the protocol stack when the messages are transported in the same ATM VC as that used for multimedia data.

The X.224 SDU shall contain a whole number of octets, not to exceed 2048 octets, representing one or more H.245 **MultimediaSystemControlPDU** messages.

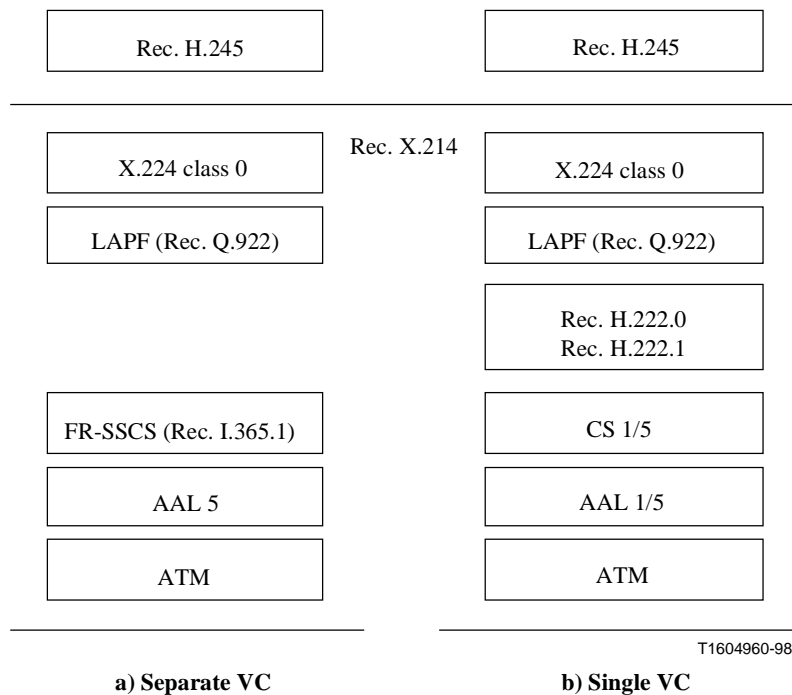

Figure A.1/H.310 – Protocol stack for control channel

A.2 X.214

A connection-mode service shall be used for the transport of MultimediaSystemControl messages as defined in Recommendation X.214.

A single Transport Connection (TC) shall be used for the transport of MultimediaSystemControl messages.

The encoded representation of individual MultimediaSystemControl messages shall be transported in single Transport Service Data Units (TSDUs). The bits produced by the ASN.1 encoding process shall be put into TSDU octets, with the first bit generated going into the Most Significant Bit (MSB) of the octet, and progressing down to the Least Significant Bit (LSB).

A.3 X.224

X.214 service shall be provided by X.224 class 0.

A.4 LAPF (Q.922)

Q.922 shall be used to provide a network connection of type A defined in 5.4.3/X.224, that is, a connection with acceptable residual error rate and acceptable rate of signalled errors. This shall be done by use of information (I) frames.

Frame types UI and XID shall not be transmitted. The address field format shall be two octets (10-bit DLCIs). The default values of Q.922 system parameters, k, N200, N201, T.200, T.203, are used for H.310. Values of k, N201 and T.200 can be negotiated in Q.922 data link connection setup. The values of N200 and T.203 need not be negotiated between terminals and may be set locally on each side.

A.5 FR-SSCS (I.365.1) and H.222.1

Both FR-SSCS (see Recommendation I.365.1) and H.222.1 provide octet transmission with structure. The transparency procedure specified in 2.6/Q.922 shall not be used, that is, no zero bits shall be inserted after any sequence of five consecutive 1 bits. No flags shall be present.

A.5.1 FR-SSCS (I.365.1)

FR-SSCS (see Recommendation I.365.1) emulates the Frame Relaying Bearer Service (FRBS) on top of the Common Part Convergence Sublayer (CPCS) of AAL type 5, providing the core service at the DL-CORE-SAP as defined in clause 2/I.365.1. FR-SSCS is used as the DL-CORE sublayer combined with DL-CONTROL sublayer described in clause 4/Q.922. The structure of FR-SSCS-PDUs is exactly the same as the Q.922 frame without flags, zero bit insertion, and FCS.

A.5.2 H.222.0 and H.222.1

Q.922 octets shall be transported in PES packets defined in Recommendation H.222.0 so that the first octet of a PES packet is the first octet of the address field and the last octet of the PES packet is the last octet of the FCS field, as defined in 2.2/Q.922.

ANNEX B

Use of DSS 2 signalling by H.310 terminals

B.1 DSS 2 signalling information elements

The following information elements are required in the SETUP message to establish the following types of connections for H.310 terminals.

Table B.1/H.310 – DSS 2 signalling information elements

Information element	H.310 Control VC	H.310 RAST A/V VC	H.310 ROT/SOT A/V VC
Protocol discriminator	M	M	M
Call Reference	M	M	M
Message type	M	M	M
Message length	M	M	M
AAL Parameters	M	M	M
ATM Traffic descriptor	M	M	M
Broadband bearer capability	M	M	M
Broadband repeat indicator	CM	O	O
Broadband low layer information	M	M	M
Generic Identifier Transport	M	M	M
Broadband High layer information	O	O	O
Notification Indicator	O	O	O
Called party number	M	M	M
Called party subaddress	C	C	C
Calling party number	M	M	M
Calling party subaddress	C	C	C
Connection identifier	O	O	O
Extended QoS parameters	O	O	O
End-to-end transit delay	O	O	O
QoS parameter	M	M	M
Broadband sending complete	C	C	C
Transit network selection	O	O	O
Endpoint reference	NA	NA	NA
NA Not Applicable O Optional CM Conditionally Mandatory M Required C Conditional (if appropriate for the network being used)			

The next subclauses summarize the use of the information elements that are unique to H.310 RAST/ROT/SOT. The elements that are not specifically described here are coded in accordance with the requirements of DSS 2 specification.

Table B.2/H.310 – DSS 2 signalling information elements specific to H.310 RAST-1 and ROT/SOT-1

Information element	H.310 Control VC	H.310 RAST-1 A/V VC	H.310 ROT/SOT-1 A/V VC
AAL Parameters	AAL Type = AAL 5 Forward CPCS SDU size Backward CPCS SDU size SSCS Type = Frame Relay	AAL Type = AAL 1 Subtype = Video signal transport CBR rate = $n \times 64$ Multiplier = As negotiated by H.245 Source Clock Frequency Recovery = As negotiated by H.245 Error Correction = As negotiated by H.245 SDT Block Size = Impl. specific	
ATM Traffic descriptor	Forward PCR and Backward PCR = 167 cells per second which corresponds to 64 kbit/s Sustainable Cell Rate = Impl. specific Maximum burst size = Impl. specific	Forward PCR = Implementation specific Backward PCR = Implementation specific (Note 1)	
Broadband bearer capability	Bearer Class = BCOB-X Broadband Transfer Capability = BTC10 User Plane Connection = PtP	Bearer Class = BCOB-A Broadband Transfer Capability = CBR Timing Requirements = end-to-end timing required User Plane Connection = PtP	
Broadband repeat indicator	Set when more than one B-LLI element is present		
Broadband low layer information	User Layer 3 = H.310 Terminal type = ROT/SOT/RAST Terminal capability = AAL 1 Forward Multiplexing = NO Backward Multiplexing = NO	User Layer 3 = H.310 Terminal type = RAST Terminal capability = AAL 1 Forward Multiplexing = TS Backward Multiplexing = TS	User Layer 3 = H.310 Terminal type = ROT/SOT Terminal capability = AAL 1 Forward Multiplexing = TS Backward Multiplexing = Null (Note 1)
Generic Identifier Transport		H.310 Correlation ID	
NOTE 1 – Forward and Backward are set according to which terminal sends the original SETUP message.			
NOTE 2 – Terminal type and Terminal capability in the B-LLI for the additional channels are encoded, but not used at the receiving end. This is applied to the following tables in this annex.			

Table B.3/H.310 – DSS 2 signalling information elements specific to H.310 RAST-5 and ROT/SOT-5

Information element	H.310 Control VC	H.310 RAST-5 A/V VC	H.310 ROT/SOT-5 A/V VC
AAL Parameters	AAL Type = AAL 5 Forward CPCS SDU size Backward CPCS SDU size SSCS Type = Frame Relay	AAL Type = AAL 5 Forward CPCS SDU size Backward CPCS SDU size SSCS Type = Null	
ATM Traffic descriptor	Forward PCR and Backward PCR = 167 cells per second which corresponds to 64 kbit/s Sustainable Cell Rate = Impl. specific Maximum burst size = Impl. specific	Forward PCR = Implementation specific Backward PCR = Implementation specific (Note 1)	
Broadband bearer capability	Bearer Class = BCOB-X Broadband Transfer Capability = BTC10 User Plane Connection = PtP	Bearer Class = BCOB-X Broadband Transfer Capability = CBR User Plane Connection = PtP	
Broadband repeat indicator	Set when more than one B-LLI element is present		
Broadband low layer information	User Layer 3 = H.310 Terminal type = ROT/SOT/RAST Terminal capability = AAL 5 Forward Multiplexing = NO Backward Multiplexing = NO	User Layer 3 = H.310 Terminal type = RAST Terminal capability = AAL 5 Forward Multiplexing = TS Backward Multiplexing = TS	User Layer 3 = H.310 Terminal type = ROT/SOT Terminal capability = AAL 5 Forward Multiplexing = TS Backward Multiplexing = Null (Note 1)
Generic Identifier Transport		H.310 Correlation ID	
NOTE 1 – Forward and Backward are set according to which terminal sends the original SETUP message. NOTE 2 – Terminal capability for RAST-5 terminal shall be set taking both terminal and gateway into account, if the terminal is supported by a gateway.			

B.2 ATM signalling required for the H.310 control VC

The following tables define the ATM signalling information elements for the H.310 control channel. The AAL, Traffic Descriptor and Broadband Bearer Capabilities IEs are defined similarly for other applications.

The control VC Protocol stack can be assumed based on Terminal identification exchanged in B-LLI. The Quality of Service (QoS) parameters shall be coded in accordance with the requirements of the network and are not specifically defined here.

Table B.4/H.310 – AAL parameters IE

IE parameter	Value	Notes
AAL type	AAL 5	
Forward Maximum AAL 5 CPCS SDU size		Value sufficient for transporting H.245 messages up to 2048 octets
Backward Maximum AAL 5 CPCS-SDU size		Value sufficient for transporting H.245 messages up to 2048 octets
SSCS Type	'00000100'	Frame Relay SSSC

Table B.5/H.310 – ATM Traffic Descriptor IE

IE parameter	Value	Notes
Forward Peak Cell Rate	Implementation and program selection specific	Set to the Peak Cell Rate value required for the control connection
Backward Peak Cell Rate	Implementation and program selection specific	Set to the Peak Cell Rate value required for the control connection

Table B.6/H.310 – Broadband Bearer Capabilities IE

IE parameter	Value	Notes
Bearer Class	BCOB-X	
Broadband Transfer Capability	BTC10 = '01010'	VBR with End-to-End Timing not required (Non-realtime VBR)
User Plane Connection configuration	Point-to-Point	

Table B.7/H.310 – Broadband Low Layer IE

IE parameter	Value	Notes
User Information Layer 3 Protocol Field	'01100'	Rec. H.310
Terminal Type	'0001' = H.310 ROT '0010' = H.310 SOT '0011' = H.310 RAST	Specify the appropriate terminal type for the expected mode of operation
Terminal capability	'001' = AAL 1 only '010' = AAL 5 only '010' = AAL 1 & 5	Specify the appropriate terminal capability regarding the supported AAL type
Forward Multiplexing Capability	'000'	No multiplex
Backward Multiplexing Capability	'000'	No multiplex

B.3 ATM Signalling Required for RAST-1 A/V VC

The following tables define the signalling elements required to establish a bidirectional (RAST) audiovisual virtual circuit from a terminal. The QoS parameters shall be coded in accordance with the requirements of the network.

Table B.8/H.310 – AAL parameters IE

IE parameter	Value	Notes
AAL type	AAL 1	
Subtype	Video signal transport	
CBR rate	$N \times 64$ kbit/s	
Multiplier	m	As negotiated by H.245
Source Clock Frequency Recovery		As negotiated by H.245
Error Correction Method		As negotiated by H.245

The Peak Cell Rate for the video service component is calculated using the MPEG-2 encoded rate plus AAL 1 overhead and specified as shown in Table B.9. The ATM Traffic Descriptor includes only the user plane information rate for the service components in that one VC.

The video service component PCR may be specified using Cell Loss Priority, CLP = 0 + 1 and CLP = 0 or CLP = 0 + 1.

Table B.9/H.310 – ATM Traffic Descriptor IE

IE parameter	Value	Notes
Forward Peak Cell Rate	Implementation and program selection specific	Set to the Peak Cell Rate value required for the video service component
Backward Peak Cell Rate	Implementation and program selection specific	Set to the Peak Cell Rate value required for the video service component

Table B.10/H.310 – Broadband Bearer Capabilities IE

IE parameter	Value	Notes
Bearer Class	BCOB-A	
Broadband Transfer Capability	Constant Bit Rate	
Timing Requirements	End-to-end timing required	
Susceptibility to clipping	Susceptible to clipping	
User Plane Connection configuration	Point-to-Point	

Table B.11/H.310 – Broadband Low Layer IE

IE parameter	Value	Notes
User Information Layer 3 Protocol Field	'01100'	Rec. H.310
Terminal Type	'0011' = H.310 RAST	Receive and Send Terminal
Terminal capability	'001' = AAL 1 only	
Forward Multiplexing Capability (Note)	'001'	Transport Stream
Backward Multiplexing Capability (Note)	'001'	Transport Stream
NOTE – Program Stream is also an option for Forward and Reverse Multiplexing Capability.		

The Generic Identifier Transport Information Element is a generic parameter that indicates the correspondence of the VC to a certain previously established request carried outside ATM signalling. Table B.12 identifies the parameters of the Generic Identifier Transport IE for use in an H.310 environment.

Table B.12/H.310 – Generic Identifier Transport IE

IE parameter	Value	Notes
Identifier Related Standard	'00000010'	Rec. H.310
Resource	Identifier for the virtual circuit	H.310 Correlation ID

B.4 ATM Signalling Required for H.310 SOT/ROT-1

The following tables define the signalling elements required to establish an audiovisual virtual circuit for a ROT or SOT terminal.

The QoS parameters shall be coded in accordance with the requirements of the network.

Table B.13/H.310 – AAL parameters IE

IE parameter	Value	Notes
AAL type	AAL 1	
Subtype	Video signal transport	
CBR rate	$N \times 64$ kbit/s	
Multiplier	m	As negotiated by H.245
Source Clock Frequency Recovery		As negotiated by H.245
Error Correction Method		As negotiated by H.245

The Peak Cell Rate for the video service component is calculated using the MPEG-2 encoded rate plus AAL 1 overhead and specified as shown in Table B.14. The ATM Traffic Descriptor includes only the user plane information rate for the service components in that one VC.

The video service component PCR may be specified using Cell Loss Priority, $CLP = 0 + 1$ and $CLP = 0$ or $CLP = 0 + 1$.

The Forward and Backward Peak Cell Rates are set according to which terminal sends the original SETUP message.

Table B.14/H.310 – ATM Traffic Descriptor IE

IE parameter	Value	Notes
Forward Peak Cell Rate	Implementation and program selection specific	Set to the Peak Cell Rate value required for the video service component
Backward Peak Cell Rate	Implementation and program selection specific	Set to the Peak Cell Rate value required for the video service component

Table B.15/H.310 – Broadband Bearer Capabilities IE

IE parameter	Value	Notes
Bearer Class	BCOB-A	
Broadband Transfer Capability	Constant Bit Rate	
Timing Requirements	End-to-end timing required	
Susceptibility to clipping	Susceptible to clipping	
User Plane Connection configuration	Point-to-Point	

The Forward and Backward Multiplexing Capability parameters are set according to which terminal sends the original SETUP message.

Table B.16/H.310 – Broadband Low Layer IE

IE parameter	Value	Notes
User Information Layer 3 Protocol Field	'01100'	Rec. H.310
Terminal Type	'0010' = H.310 ROT '0001' = H.310 SOT	
Terminal capability	'001' = AAL 1 only	
Forward Multiplexing Capability (Note)	If ROT then '000' = No multiplex If SOT then '001' = Transport Stream	
Backward Multiplexing Capability (Note)	If ROT then '001' = Transport Stream If SOT then '000' = No multiplex	
NOTE – Program Stream is also an option for Forward and Reverse Multiplexing Capability.		

The Generic Identifier Transport Information Element is a generic parameter that indicates the correspondence of the VC to a certain previously established request carried outside ATM signalling. Table B.17 identifies the parameters of the Generic Identifier Transport IE for use in an H.310 environment.

Table B.17/H.310 – Generic Identifier Transport IE

IE parameter	Value	Notes
Identifier Related Standard	'00000010'	Rec. H.310
Resource	Identifier for the virtual circuit	H.310 Correlation ID

B.5 ATM Signalling Required for RAST-5 A/V VC

The following tables define the signalling elements required to establish a bidirectional (RAST) audiovisual virtual circuit from a terminal. The QoS parameters shall be coded in accordance with the requirements of the network.

Table B.18/H.310 – AAL parameters IE

IE parameter	Value	Notes
AAL type	AAL 5	
Forward Maximum AAL 5 CPCS SDU size	N*188 bytes	Default value for the video service component in this specification is 376 bytes. N is an integer.
Backward Maximum AAL 5 CPCS-SDU size	N*188 bytes	Default value for the video service component in this specification is 376 bytes. N is an integer.
SSCS Type	Null	

The Peak Cell Rate for the video service component is calculated using the MPEG-2 encoded rate plus AAL 5 overhead and specified as shown in Table B.19. The ATM Traffic Descriptor includes only the user plane information rate for the service components in that one VC.

The video service component PCR may be specified using Cell Loss Priority, CLP = 0 + 1 and CLP = 0 or CLP = 0 + 1.

Table B.19/H.310 – ATM Traffic Descriptor IE

IE parameter	Value	Notes
Forward Peak Cell Rate	Implementation and program selection specific	Set to the Peak Cell Rate value required for the video service component.
Backward Peak Cell Rate	Implementation and program selection specific	Set to the Peak Cell Rate value required for the video service component.

Table B.20/H.310 – Broadband Bearer Capabilities IE

IE parameter	Value	Notes
Bearer Class	BCOB-X	
Broadband Transfer Capability	Constant Bit Rate	
User Plane Connection configuration	Point-to-Point	

Table B.21/H.310 – Broadband Low Layer IE

IE parameter	Value	Notes
User Information Layer 3 Protocol Field	'01100'	Rec. H.310
Terminal Type	'0011' = H.310 RAST	Receive and Send Terminal
Terminal capability	'010' = AAL 5 only	
Forward Multiplexing Capability (Note)	'001'	Transport Stream
Backward Multiplexing Capability (Note)	'001'	Transport Stream
NOTE – Program Stream is also an option for Forward and Reverse Multiplexing Capability.		

The Generic Identifier Transport Information Element is a generic parameter that indicates the correspondence of the VC to a certain previously established request carried outside ATM signalling. Table B.22 identifies the parameters of the Generic Identifier Transport IE for use in an H.310 environment.

Table B.22/H.310 – Generic Identifier Transport IE

IE parameter	Value	Notes
Identifier Related Standard	'00000010'	Rec. H.310
Resource	Identifier for the virtual circuit	H.310 Correlation ID

B.6 ATM Signalling Required for H.310 SOT-5

For an H.310 SOT terminal, the Forward and Backwards Maximum AAL 5 CPCS SDU sizes are set according to which terminal sends the original SETUP message. Table B.23 shows the settings if the SOT terminal sends the SETUP message.

Table B.23/H.310 – AAL type IE

IE parameter	Value	Notes
AAL type	AAL 5	
Forward Maximum AAL 5 CPCS SDU size	N*188 bytes	Default value for the video service component in this specification is 376 bytes. N is an integer.
Backward Maximum AAL 5 CPCS-SDU size	0 bytes if the video service component is unidirectional, otherwise implementation specific	
SSCS Type	'00000000'	Null

The Peak Cell Rate for the video service component is calculated using the MPEG-2 encoded rate plus the AAL 5 overhead. The ATM Traffic Descriptor includes only the user plane information rate for the service components in that one VC.

The video service component PCR may be specified using Cell Lost Priority $CLP = 0 + 1$ and $CLP = 0$ or $CLP = 0 + 1$.

The Forward and Backward Peak Cell Rates are set according to which terminal sends the original SETUP message. The following tables show the settings if the SOT terminal sends the SETUP message.

Table B.24/H.310 – ATM Traffic Descriptor

IE parameter	Value	Notes
Forward Peak Cell Rate	Implementation and program selection specific	Set to the Peak Cell Rate value required for the video service component
Backward Peak Cell Rate	0 cells/s if video service component is unidirectional, otherwise implementation specific	

Table B.25/H.310 – Broadband Bearer Capabilities IE

IE parameter	Value	Notes
Bearer Class	BCOB-X	
Broadband Transfer Capability	Constant Bit Rate	
User Plane Connection configuration	Point-to-Point	

Table B.26/H.310 – Broadband Low Layer IE

IE parameter	Value	Notes
User Information Layer 3 Protocol Field	'01100'	Rec. H.310
Terminal Type	'0010' = H.310 SOT	Send Only Terminal
Terminal capability	'010' = AAL 5 only	
Forward Multiplexing Capability (Note)	'001'	Transport Stream
Backward Multiplexing Capability (Note)	'000'	No multiplex
NOTE – Program Stream is also an option for Forward Multiplexing Capability.		

The QoS parameters shall be coded in accordance with the requirements of the network.

The Generic Identifier Transport Information Element is a generic parameter that indicates the correspondence of the VC to a certain previously established request carried outside ATM signalling. Table B.27 identifies the parameters of the Generic Identifier Transport IE for use in an H.310 environment.

Table B.27/H.310 – Generic Identifier Transport IE

IE parameter	Value	Notes
Identifier Related Standard	'00000010'	Rec. H.310
Resource	Identifier for the virtual circuit	H.310 Correlation ID

B.7 ATM Signalling Required for H.310 ROT-5

The Forward and Backward Maximum AAL 5 CPCS SDU sizes are set according to which terminal sends the original SETUP message. The following table shows the settings if the ROT terminal sends the SETUP message.

Table B.28/H.310 – AAL parameters IE

IE parameter	Value	Notes
AAL type	AAL 5	
Forward Maximum AAL 5 CPCS SDU size	0 bytes if video service component is unidirectional otherwise implementation specific	
Backward Maximum AAL 5 CPCS-SDU size	N*188 bytes	Default value for the video service component in this specification is 376 bytes. N is an integer.
SSCS Type	Null	

The Peak Cell Rate for the video service component is calculated using the MPEG-2 encoded rate plus the AAL 5 overhead. The ATM Traffic Descriptor includes only the user plane information rate for the service components in that one VC.

The video service component Peak Cell Rate may be specified using $CLP = 0 + 1$ and $CLP = 0$ or $CLP = 0 + 1$.

The Forward and Backward Peak Cell Rates are set according to which terminal sends the original SETUP message. The following tables show the settings if the ROT terminal sends the SETUP message.

Table B.29/H.310 – ATM Traffic Descriptor IE

IE parameter	Value	Notes
Forward Peak Cell Rate	0 cells/s if video service component is unidirectional, otherwise implementation specific	
Backward Peak Cell Rate	Implementation and program selection specific	Set to the Peak Cell Rate value required for the video service component

Table B.30/H.310 – Broadband Bearer Capabilities IE

IE parameter	Value	Notes
Bearer Class	BCOB-X	
Broadband Transfer Capability	Constant Bit Rate	
User Plane Connection configuration	Point-to-Point	

Table B.31/H.310 – Broadband Low Layer IE

IE parameter	Value	Notes
User Information Layer 3 Protocol Field	'01100'	Rec. H.310
Terminal Type	'0001' = H.310 ROT	Receive Only Terminal
Terminal capability	'010' = AAL 5 only	
Forward Multiplexing Capability (Note)	'000'	No multiplex
Backward Multiplexing Capability (Note)	'001'	Transport Stream
NOTE – Program Stream is also an option for Reverse Multiplexing Capability.		

These QoS parameters shall be coded in accordance with the requirements of the network.

The Generic Identifier Transport Information Element is a generic parameter that indicates the correspondence of the VC to a certain previously established request carried outside ATM signalling. Table B.32 identifies the parameters of the Generic Identifier Transport IE for use in an H.310 environment.

Table B.32/H.310 – Generic Transport Identifier IE

IE parameter	Value	Notes
Identifier Related Standard	'00000010'	Rec. H.310
Resource	Identifier for the virtual circuit	H.310 Correlation ID

ANNEX C

Procedures for intercommunication between RAST-1 and RAST-5 terminals

C.1 Introduction

The procedures are defined to meet the following requirements:

- Two terminals are connected directly as far as possible without use of the conversion gateway. If necessary, a minimum number of gateways are used for protocol conversion.
- To achieve this, H.245 message exchange is used to take advantage of the fact that H.245 is common to all H.310 terminals including its transport method.

- The extended communication procedures should be a superset of the one stipulated for simple direct communications.

For the description of this annex, CPN stands for customer premises ATM network while B-ISDN is the public network. Audiovisual connection is meant to cover audio, video and data.

It is important to note that the terminal connected to a CPN has the knowledge of its associated gateway capability, thus it shall indicate its terminal type in B-LLI according to the combined capability of its own and that of the associated gateway. A RAST-5 terminal, for example, shall indicate "AAL 1 and AAL 5" in B-LLI if it is supported by the AAL 1/AAL 5 conversion gateway. The mechanism for a terminal to obtain the associated gateway capability is not part of this specification; it may be manual, it may be automatic.

C.2 Two RAST-5 terminals on CPN

This is the case where two terminals both on CPN are connected through B-ISDN as shown in Figure C.1.

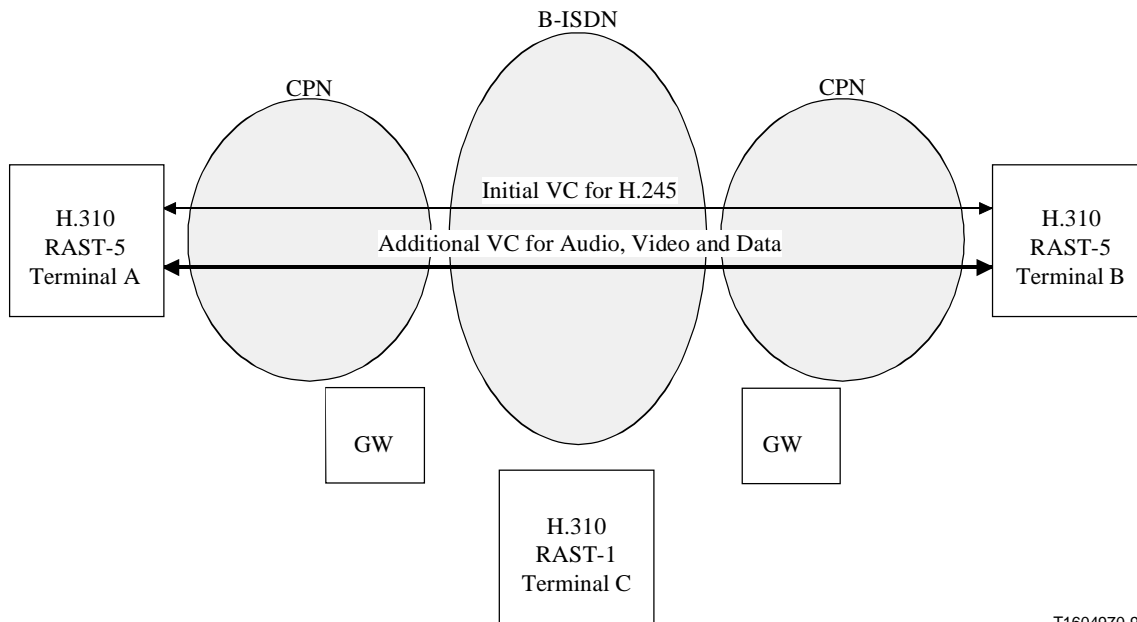

T1604970-98

Figure C.1/H.310 – Communication between two RAST-5 terminals

Communication is established as follows:

- 1) Terminal A calls Terminal B and sets up the H.245 control session by indicating its type as AAL 1 and AAL 5 in B-LLI because it is supported by the AAL 1/AAL 5 conversion gateway.
- 2) H.245 is used to exchange terminal capabilities, including terminal type and the gateway address(es) and facilities. Both terminals indicate that they have their local gateways.
- 3) According to the H.245 capability exchange, Terminal A infers that both terminals are of the same type (RAST-5), thus no gateway is required.
- 4) According to the communication mode determination, the calling Terminal A indicates parameters of the additional VC to the called Terminal B by sending NewATMVCIndication message.

- 5) Terminal A sets up the audiovisual connection directly to Terminal B with parameters set in the **NewATMVCIndication** message.

Table C.1/H.310 – GIT – Terminal A to Terminal B

IE parameter	Code	Semantics
Identifier related standard	00000010	Rec. H.310
Identifier type	00000010	Resource
Value (2 octets)	e.g. 00000000 00000000	H.245 resourceID (the lowest possible value)

C.3 RAST-5 Terminal on CPN with RAST-1 Terminal on Public B-ISDN

This is the case where a RAST-5 terminal on CPN communicates with a RAST-1 terminal on public B-ISDN as shown in Figure C.2. There are two subcases depending on which side calls.

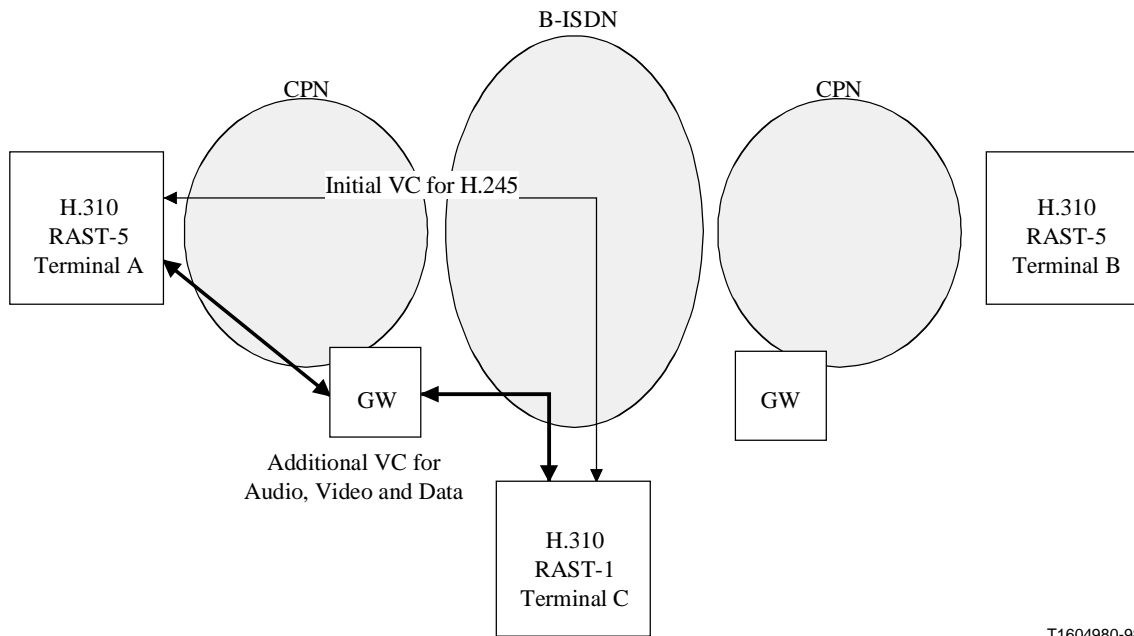

T1604980-98

Figure C.2/H.310 – Communication between RAST-5 on CPN and RAST-1 on B-ISDN

C.3.1 RAST-5 Terminal on CPN calls RAST-1 Terminal on B-ISDN

- 1) Terminal A calls Terminal C and sets up the H.245 control session.
- 2) The call is accepted by Terminal C because the remote terminal type indicates AAL 1 and AAL 5 in B-LLI.
- 3) H.245 is used to exchange terminal capabilities, including terminal type and the gateway address(es) and facilities. Terminal A will indicate that it has a local gateway. Terminal C will not indicate that it has a gateway. Audiovisual communication modes are determined by Terminal A based on its own capabilities and those of the gateway and Terminal C.
- 4) The calling Terminal A indicates parameters of the additional VC to the called Terminal C by sending **NewATMVCIndication** message.

- 5) Terminal A sets up a concatenated audiovisual connection through the gateway with parameters set in the **NewATMVCIndication** message.
- 6) The gateway sets up a connection to Terminal C using the next connection ATM address and H.310 Correlation_ID passed to it in the SETUP message from Terminal A.

Generic Identifier Transport IE shall be coded as in Tables C.2 and C.3.

Table C.2/H.310 – GIT – Terminal A to GW

IE parameter	Code	Semantics
Identifier related standard	00000010	Rec. H.310
Identifier type	00000010	Resource
Value (2 octets)	e.g. 00000000 00000000	H.245 resourceID (the lowest possible value)
Identifier type	00000011	End Station (to be defined by SG 11)
Value (up to 20 octets)	(to be specified)	ATM address of Terminal C

Table C.3/H.310 – GIT – GW to Terminal C

IE parameter	Code	Semantics
Identifier related standard	00000010	Rec. H.310
Identifier type	00000010	Resource
Value (2 octets)	e.g. 00000000 00000000	H.245 resourceID (the lowest possible value)

C.3.2 RAST-1 Terminal on B-ISDN calls RAST-5 Terminal on CPN

- 1) Terminal C calls Terminal A and sets up the H.245 control session.
- 2) The call is accepted by Terminal A based on the knowledge of its associated gateway even though the remote terminal type indicates AAL 1 in B-LLI.
- 3) H.245 is used to exchange terminal capabilities, including terminal type and the gateway address(es) and facilities. Terminal A will indicate that it has a local gateway. Terminal C will not indicate that it has a gateway.
- 4) Audiovisual communication modes are determined by Terminal C based on its own capabilities and those of the gateway and Terminal A.
- 5) The calling Terminal C indicates parameters of the additional VC to the called Terminal A by sending **NewATMVCIndication** message.
- 6) Terminal C sets up a concatenated audiovisual connection through the gateway identified by Terminal A with parameters set in the **NewATMVCIndication** message.
- 7) The gateway sets up a connection to Terminal A using the next connection ATM Address and H.310 Correlation_ID passed to it in the SETUP message from Terminal C.

Generic Identifier Transport IE shall be coded as in Tables C.4 and C.5.

Table C.4/H.310 – GIT – Terminal C to GW

IE parameter	Code	Semantics
Identifier related standard	00000010	Rec. H.310
Identifier type	00000010	Resource
Value (2 octets)	e.g. 00000000 00000000	H.245 resourceID (the lowest possible value)
Identifier type	00000011	End Station (to be defined by SG 11)
Value (up to 20 octets)	(to be specified)	ATM address of Terminal A

Table C.5/H.310 – GIT – GW to Terminal A

IE parameter	Code	Semantics
Identifier related standard	00000010	Rec. H.310
Identifier type	00000010	Resource
Value (2 octets)	e.g. 00000000 00000000	H.245 resourceID (the lowest possible value)

C.4 RAST-5 Terminal on CPN with RAST-1 Terminal on CPN

This is the case where a RAST-5 terminal on CPN communicates with a RAST-1 terminal on CPN through public B-ISDN as shown in Figure C.3. The procedures are identical to those defined in C.3 because RAST-1 terminals have no associated gateways.

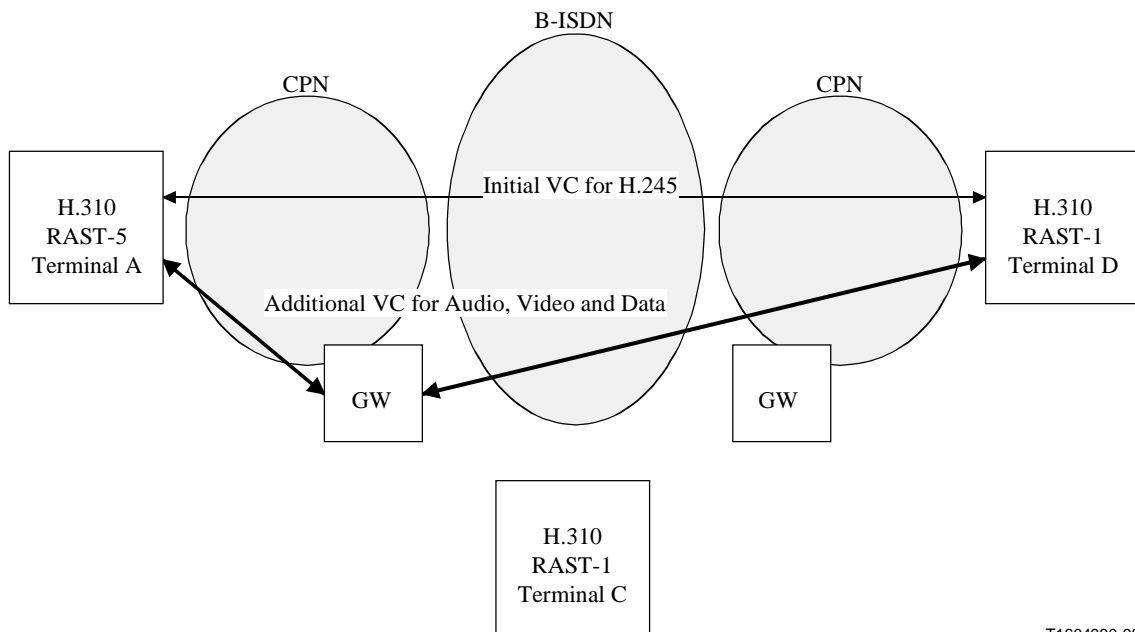

T1604990-98

Figure C.3/H.310 – Communication between RAST-5 on CPN and RAST-1 on CPN

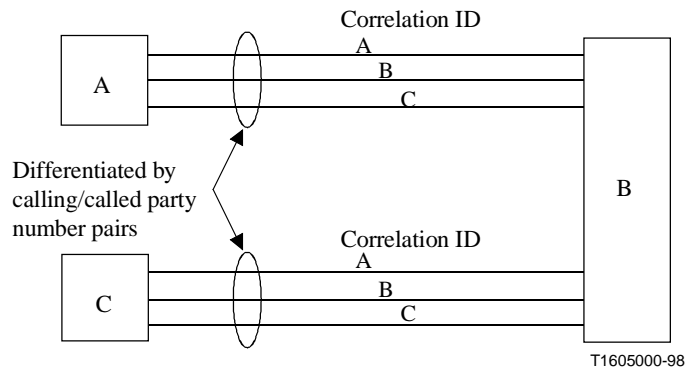

Figure II.1/H.310 – Identification of VCs in single session case

To prepare for the eventual possibility that multiple H.310 sessions will exist between two terminals, as shown in Figure II.2, the correlationID has been defined as follows:

correlationID = session ID ; Identification of a session
 + resource ID (2 bytes) ; Identification of a logical channel

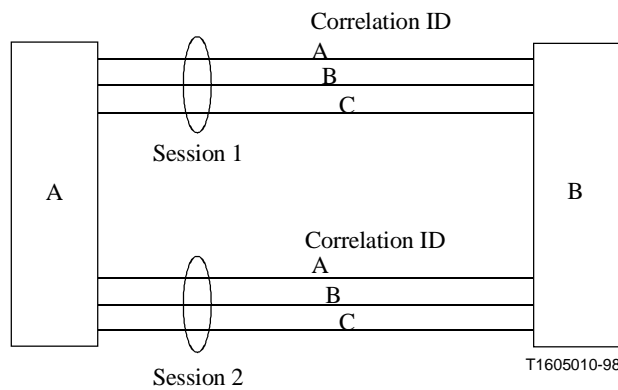

Figure II.2/H.310 – Identification of VCs in multi-session case

However, the current H.310 specification does not assume the multi-session case so the resourceID is the only valid element in the correlation ID for the moment.

ITU-T RECOMMENDATIONS SERIES

- Series A Organization of the work of the ITU-T
- Series B Means of expression: definitions, symbols, classification
- Series C General telecommunication statistics
- Series D General tariff principles
- Series E Overall network operation, telephone service, service operation and human factors
- Series F Non-telephone telecommunication services
- Series G Transmission systems and media, digital systems and networks
- Series H Audiovisual and multimedia systems**
- Series I Integrated services digital network
- Series J Transmission of television, sound programme and other multimedia signals
- Series K Protection against interference
- Series L Construction, installation and protection of cables and other elements of outside plant
- Series M TMN and network maintenance: international transmission systems, telephone circuits, telegraphy, facsimile and leased circuits
- Series N Maintenance: international sound programme and television transmission circuits
- Series O Specifications of measuring equipment
- Series P Telephone transmission quality, telephone installations, local line networks
- Series Q Switching and signalling
- Series R Telegraph transmission
- Series S Telegraph services terminal equipment
- Series T Terminals for telematic services
- Series U Telegraph switching
- Series V Data communication over the telephone network
- Series X Data networks and open system communications
- Series Y Global information infrastructure
- Series Z Programming languages