



INTERNATIONAL TELECOMMUNICATION UNION

ITU-T

TELECOMMUNICATION
STANDARDIZATION SECTOR
OF ITU

G.975

(11/96)

SERIES G: TRANSMISSION SYSTEMS AND MEDIA,
DIGITAL SYSTEMS AND NETWORKS

Digital transmission systems – Digital sections and digital
line system – Optical fibre submarine cable systems

Forward error correction for submarine systems

ITU-T Recommendation G.975

(Previously CCITT Recommendation)

ITU-T G-SERIES RECOMMENDATIONS
TRANSMISSION SYSTEMS AND MEDIA, DIGITAL SYSTEMS AND NETWORKS

INTERNATIONAL TELEPHONE CONNECTIONS AND CIRCUITS	G.100–G.199
<i>INTERNATIONAL ANALOGUE CARRIER SYSTEM</i>	
GENERAL CHARACTERISTICS COMMON TO ALL ANALOGUE CARRIER-TRANSMISSION SYSTEMS	G.200–G.299
INDIVIDUAL CHARACTERISTICS OF INTERNATIONAL CARRIER TELEPHONE SYSTEMS ON METALLIC LINES	G.300–G.399
GENERAL CHARACTERISTICS OF INTERNATIONAL CARRIER TELEPHONE SYSTEMS ON RADIO-RELAY OR SATELLITE LINKS AND INTERCONNECTION WITH METALLIC LINES	G.400–G.449
COORDINATION OF RADIOTELEPHONY AND LINE TELEPHONY	G.450–G.499
<i>TRANSMISSION MEDIA CHARACTERISTICS</i>	
<i>DIGITAL TRANSMISSION SYSTEMS</i>	
TERMINAL EQUIPMENTS	G.700–G.799
DIGITAL NETWORKS	G.800–G.899
DIGITAL SECTIONS AND DIGITAL LINE SYSTEM	G.900–G.999
General	G.900–G.909
Parameters for optical fibre cable systems	G.910–G.919
Digital sections at hierarchical bit rates based on a bit rate of 2048 kbit/s	G.920–G.929
Digital line transmission systems on cable at non-hierarchical bit rates	G.930–G.939
Digital line systems provided by FDM transmission bearers	G.940–G.949
Digital line systems	G.950–G.959
Digital section and digital transmission systems for customer access to ISDN	G.960–G.969
Optical fibre submarine cable systems	G.970–G.979
Optical line systems for local and access networks	G.980–G.999

For further details, please refer to ITU-T List of Recommendations.

ITU-T RECOMMENDATION G.975

FORWARD ERROR CORRECTION FOR SUBMARINE SYSTEMS

Summary

The present Recommendation is primarily concerned with the implementation of a Forward Error Correction (FEC) function in the multigigabit-per-second optical fibre submarine cable systems. The applications being addressed in in this Recommendation are both optically amplified repeatered systems and repeaterless optical systems (described in Recommendation G.973). The use of this FEC function in submarine terminal transmission equipment is not mandatory.

Source

ITU-T Recommendation G.975 was prepared by ITU-T Study Group 15 (1993-1996) and was approved under the WTSC Resolution No. 1 procedure on the 8th of November 1996.

FOREWORD

ITU (International Telecommunication Union) is the United Nations Specialized Agency in the field of telecommunications. The ITU Telecommunication Standardization Sector (ITU-T) is a permanent organ of the ITU. The ITU-T is responsible for studying technical, operating and tariff questions and issuing Recommendations on them with a view to standardizing telecommunications on a worldwide basis.

The World Telecommunication Standardization Conference (WTSC), which meets every four years, establishes the topics for study by the ITU-T Study Groups which, in their turn, produce Recommendations on these topics.

The approval of Recommendations by the Members of the ITU-T is covered by the procedure laid down in WTSC Resolution No. 1.

In some areas of information technology which fall within ITU-T's purview, the necessary standards are prepared on a collaborative basis with ISO and IEC.

NOTE

In this Recommendation, the expression "Administration" is used for conciseness to indicate both a telecommunication administration and a recognized operating agency.

INTELLECTUAL PROPERTY RIGHTS

The ITU draws attention to the possibility that the practice or implementation of this Recommendation may involve the use of a claimed Intellectual Property Right. The ITU takes no position concerning the evidence, validity or applicability of claimed Intellectual Property Rights, whether asserted by ITU members or others outside of the Recommendation development process.

As of the date of approval of this Recommendation, the ITU had/had not received notice of intellectual property, protected by patents, which may be required to implement this Recommendation. However, implementors are cautioned that this may not represent the latest information and are therefore strongly urged to consult the TSB patent database.

© ITU 1997

All rights reserved. No part of this publication may be reproduced or utilized in any form or by any means, electronic or mechanical, including photocopying and microfilm, without permission in writing from the ITU.

CONTENTS

	Page
1 Scope.....	1
2 References.....	1
3 Definitions, terms and abbreviations	2
3.1 Definitions	2
3.2 Abbreviations.....	2
4 FEC features.....	2
4.1 General principles of the FEC function	2
4.2 Error monitoring capability.....	3
4.3 Interest of the FEC function for submarine systems.....	4
4.4 Inter-terminal channels	4
5 Definition of the FEC function	4
5.1 Definitions	4
5.2 Forward Error Correction algorithm.....	4
5.3 Properties of the RS(255,239) code.....	5
5.4 FEC frame structure.....	5
5.4.1 FEC encoder and FEC decoder architectures	5
5.4.2 Framing structure.....	8
5.4.3 Scrambling.....	8
5.4.4 Redundancy ratio	8
6 FEC function performance.....	9
6.1 Theoretical FEC function performance.....	9
6.2 Coding gain.....	10

Recommendation G.975

FORWARD ERROR CORRECTION FOR SUBMARINE SYSTEMS

(Geneva, 1996)

1 Scope

The present Recommendation is primarily concerned with the implementation of a Forward Error Correction (FEC) function in the multigigabit-per-second optical fibre submarine cable systems. The applications being addressed in this Recommendation are both optically amplified repeatered systems and repeaterless optical systems (Recommendation G.973). The use of this FEC function in submarine terminal transmission equipments (TTEs) should not be considered as mandatory.

The transmission data rates under consideration in this Recommendation are 2.5 Gbit/s STM-16 (Recommendation G.707) and integer multiples of 2.5 Gbit/s (interleaved STM-16 tributaries).

Clause 4 presents the main features of the FEC function implemented in the submarine systems, and in particular the error monitoring facility.

Clause 5 provides the definition of the forward error correction algorithm to be used, which is a Reed-Solomon code, and gives guidelines for the implementation of this algorithm in the submarine Terminal Transmission Equipments (TTEs).

Clause 6 is dedicated to the measurement of the performance of this Reed-Solomon code and the expected gain on the optical transmission power budget.

2 References

The following ITU-T Recommendations and other references contain provisions which, through reference in this text, constitute provisions of this Recommendation. At the time of publication, the editions indicated were valid. All Recommendations and other references are subject to revision; all users of this Recommendation are therefore encouraged to investigate the possibility of applying the most recent edition of the Recommendations and other references listed below. A list of the currently valid ITU-T Recommendations is regularly published.

- ITU-T Recommendation G.707 (1996), *Network node interface for the Synchronous Digital Hierarchy (SDH)*.
- ITU-T Recommendation G.957 (1995), *Optical interfaces for equipments and systems relating to the synchronous digital hierarchy*.
- ITU-T Recommendation G.958 (1994), *Digital line systems based on the Synchronous Digital Hierarchy (SDH) for use on optical fibre cables*.
- ITU-T Recommendation G.971 (1996), *General features of optical fibre submarine cable systems*.
- ITU-T Recommendation G.972 (1997), *Definition of terms relevant to optical fibre submarine cable systems*.
- ITU-T Recommendation G.973 (1996), *Characteristics of repeaterless optical fibre submarine cable systems*.

3 Definitions, terms and abbreviations

3.1 Definitions

This Recommendation uses the following terms defined in other Recommendations:

- Synchronous Digital Hierarchy (SDH): See Recommendation G.707.
- Synchronous Transport Module (STM): See Recommendation G.707.
- Optical fibre submarine cable system: See Recommendation G.972.
- Terminal Transmission Equipment (TTE): See Recommendation G.972.
- Optical power budget: See Recommendation G.972.
- Service channel: See Recommendation G.972.
- Order wire channel: See Recommendation G.972.
- Line error ratio: See Recommendation G.972.
- Forward Error Correction (FEC): See Recommendation G.972.
- FEC frame: See Recommendation G.972.
- FEC encoder: See Recommendation G.972.
- FEC decoder: See Recommendation G.972.

3.2 Abbreviations

This Recommendation uses the following abbreviations:

BER	Bit Error Ratio
EDFA	Erbium-Doped Fibre Amplifier
FEC	Forward Error Correction
GF	Galois Field
RS	Reed-Solomon

4 FEC features

4.1 General principles of the FEC function

The FEC function defined in this Recommendation works on the STM-16 basis. When M (M integer different from 0) STM-16 signals are interleaved to achieve $M \times 2.5$ Gbit/s transmission data rates, the encoding is performed before the interleaving of the M STM-16 tributaries and the decoding is performed after the de-interleaving of the optical line signal.

The FEC function essentially comprises:

- a FEC encoder in the transmit Terminal Transmission Equipment (TTE) that accepts information bits and adds computed redundant symbols, producing encoded data at a higher bit rate;
- a FEC decoder in the receive Terminal Transmission Equipment (TTE) that performs the error correction while extracting the redundancy to regenerate the data that was encoded by the FEC encoder.

Figure 1 outlines the fact that the encoding and decoding procedures are performed at the Terminal Transmission Equipment (TTE) level only, on electrical signals, and benefit the overall optical fibre submarine cable system, which comprises the optical fibre and possibly optical modules such as optical amplifiers using EDFA technology.

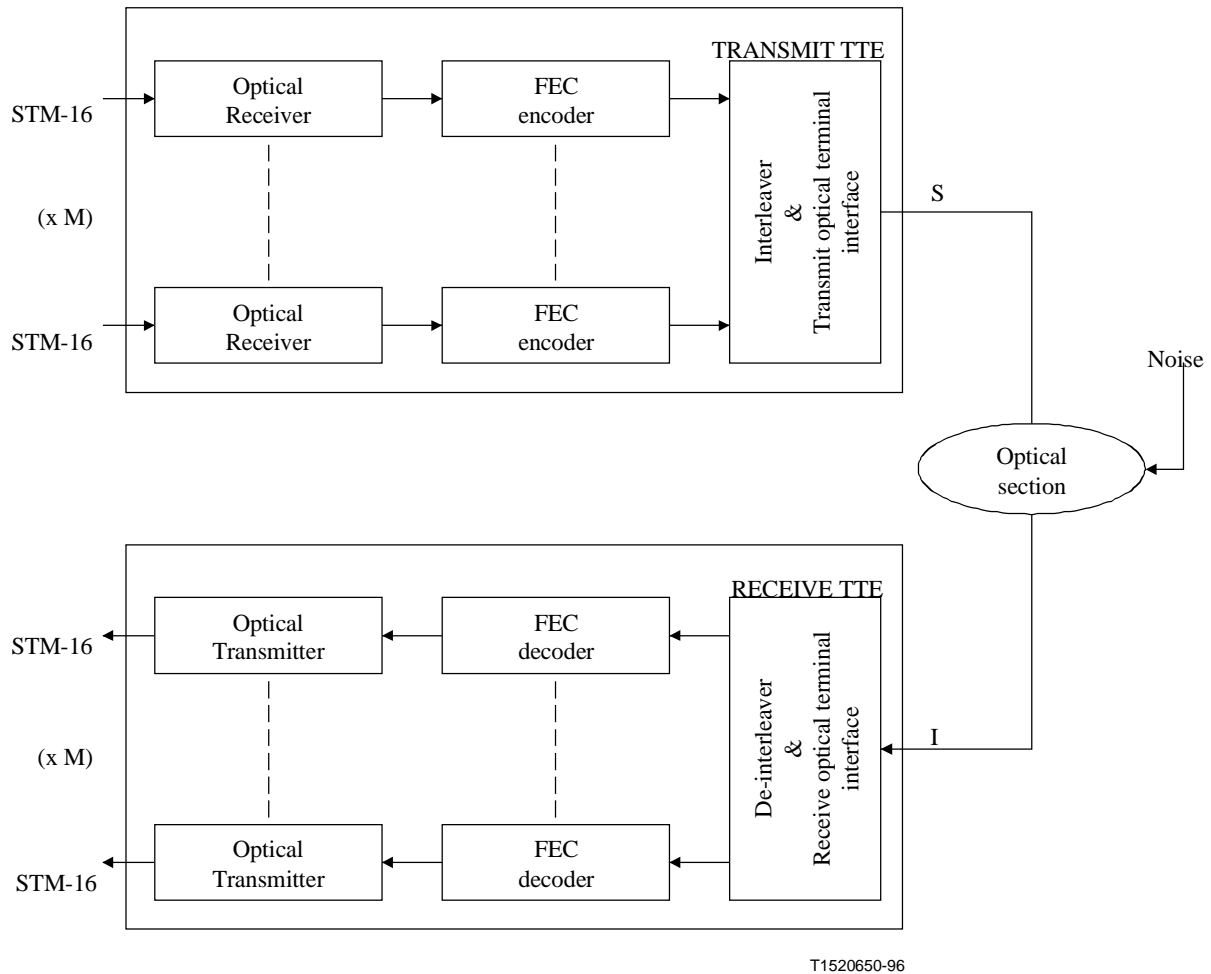

Figure 1/G.975 – Block diagram of a submarine system which uses a FEC function

4.2 Error monitoring capability

The implementation of a FEC function allows the in-line monitoring of the line Bit Error Ratio before correction (BER_{Input}) through the knowledge of the exact number of corrected bits (BER_C). The errors that remain uncorrected after forward error correction (BER_{Output}) (these errors remain when the number of line errors is beyond the decoder's ability to correct) can be considered negligible in the computation of BER_{Input} ($BER_{Input} = BER_C + BER_{Output} \approx BER_C$), for low error rates.

The conditions that could make the previous statement inaccurate ($BER_{Input} > 10^{-3}$) would lead the system into an intermittent loss of FEC frame alignment state (see 5.4 for the FEC frame definition). In fact, the 10^{-3} bit error rate represents the limit beyond which the FEC function becomes inefficient.

The forward error correction code reports the evolution of the line errors (the measurable values of the BER_{Input} are comprised of between 10^{-3} and 10^{-15}) while keeping the system faultless by correcting these errors. Consequently, the FEC function can dynamically provide an evaluation of

the system margins relative to the required level of performance. If a maintenance of the line appears to be necessary, it can then be planned before any effective degradation of the transmission.

4.3 Interest of the FEC function for submarine systems

The implementation of a Forward Error Correction (FEC) function in optical fibre submarine cable systems provides significant gains over the overall optical power budget of the link, and lowers at the same time the line BER floor of the system (see 6.2).

The resulting gain over the optical power budget obtained with the FEC technique can then be used to improve either:

- 1) the line parameters:

For repeaterless submarine applications, the FEC function will possibly be used to increase the maximum span length.

For optically amplified submarine applications, the FEC function will possibly be used to either increase the inter-repeater distances or relax optical component and line fibre specifications.

- 2) the overall quality of communication for protection against unwanted degraded operating conditions (component or cable failure, due to ageing for instance).

In counterpart, the use of the FEC function in the submarine Terminal Transmission Equipments (TTEs) introduces an increase of the line bit rate.

4.4 Inter-terminal channels

Provided that a framing structure is included in the FEC frame (see 5.4.2), it is possible to transmit tributary markers for systems carrying several interleaved STM-16 signals, or to transmit order wire channels or service channels through the unused bits of the framing structure.

5 Definition of the FEC function

5.1 Definitions

5.1.1 block code: Such codes are characterized by the fact that the encoder accepts K information symbols from the information source and appends a set of R redundant symbols derived from the information symbols, in accordance with the code algorithm.

5.1.2 cyclic code: A linear code is said to be cyclic when any cyclic shift of a codeword is also a codeword.

5.1.3 systematic code: With such codes, the information word is not disturbed in any way in the encoder and the redundant symbols are added separately to each block.

5.1.4 information word: The information word contains K information symbols.

5.1.5 codeword: The block of N symbols that carries the K information symbols and the R redundant symbols ($N = K + R$).

5.2 Forward Error Correction algorithm

The Forward Error Correction code used to protect the STM-16 information against in-line errors in the optical fibre submarine cable systems is a Reed-Solomon code, already specified in the CMTT Recommendation CCIR 723: the RS(255,239) code. The RS(255,239) code is a non-binary code (the

FEC algorithm operates on 8-bit symbols) and belongs to the family of systematic linear cyclic block codes.

The generator polynomial of the code is given by:

$$G(z) = \prod_{i=0}^{15} (z - \alpha^i)$$

where α is a root of the binary primitive polynomial $x^8 + x^4 + x^3 + x^2 + 1$. A data byte ($d_7, d_6, \dots, d_1, d_0$) is identified with the element $d_7 \cdot \alpha^7 + d_6 \cdot \alpha^6 + \dots + d_1 \cdot \alpha^1 + d_0$ in GF(256), the finite field with 256 elements.

5.3 Properties of the RS(255,239) code

With regard to the wide variety of forward error correction codes, the selection of a particular forward error correction code consists in part of matching the features of a coding technique with the system objectives being addressed.

The choice of the Reed-Solomon code for optical fibre submarine cable systems is essentially motivated by the following properties:

- 1) an important error correcting capacity with respect to the redundancy ratio applied to the information word: the RS(255,239) algorithm can correct up to 8 erroneous byte-symbols in a single codeword of length 255;
- 2) a low complexity of both the FEC encoder and the FEC decoder;
- 3) a coding structure compatible with binary transmissions, providing that a demultiplexing operation is performed;
- 4) an important correcting capacity of burst errors. This intrinsic property of the Reed-Solomon codes is even enhanced by the interleaving of elementary RS(255,239) codecs. This technique, implemented on the 2.5 Gbit/s optical fibre submarine cable systems, puts the error correcting capacity to bursts of 1024 bits maximal length, for 16 interleaved codecs.

In addition, the Reed-Solomon codes remain among the most efficient codes which can be implemented using the state-of-the-art hardware and software technology.

5.4 FEC frame structure

5.4.1 FEC encoder and FEC decoder architectures

In order to enhance the immunity of the optical fibre submarine cable system to burst errors, several RS(255,239) codes can be interleaved. In Figures 2 and 3, (n) denotes the interleaving order (n is a non-zero integer).

Given the interleaving to depth " n " of RS(255,239) codes, the architectures of both the FEC encoder and the FEC decoder are detailed in Figures 2 and 3 respectively.

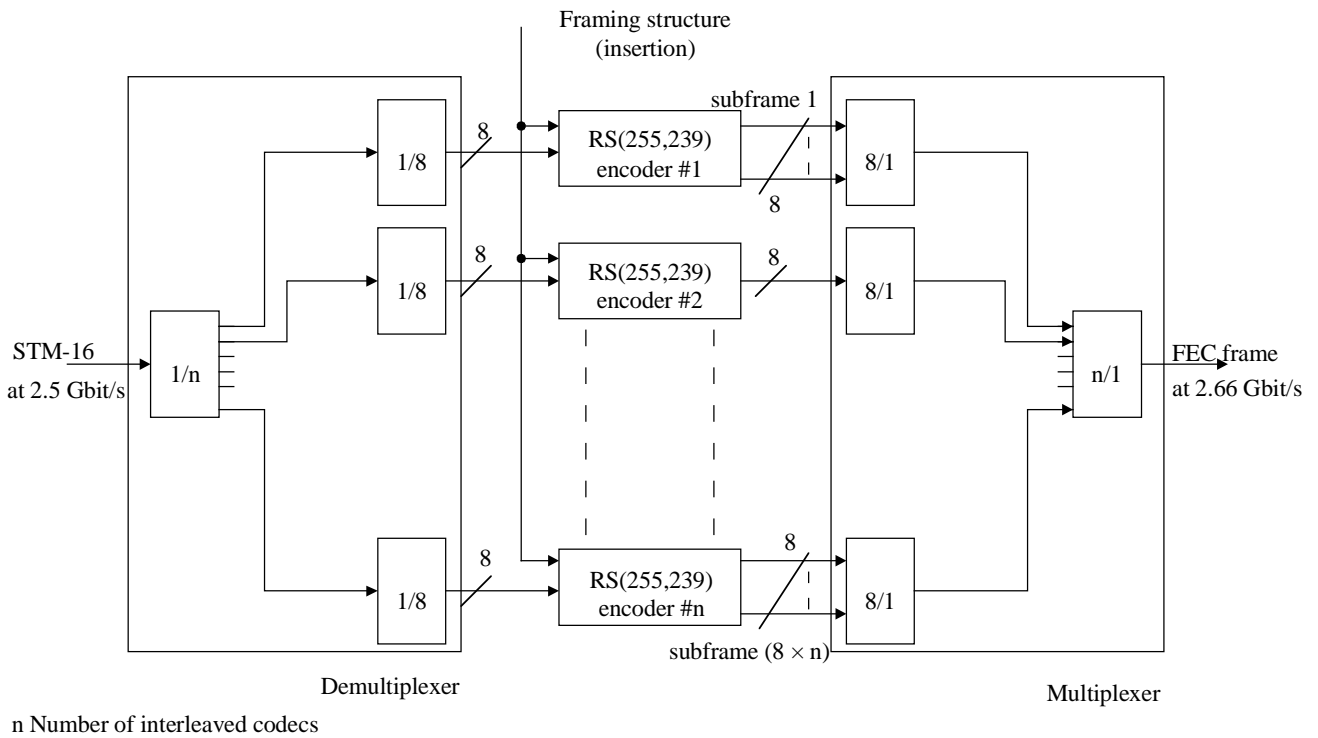

Figure 2/G.975 – FEC encoder architecture

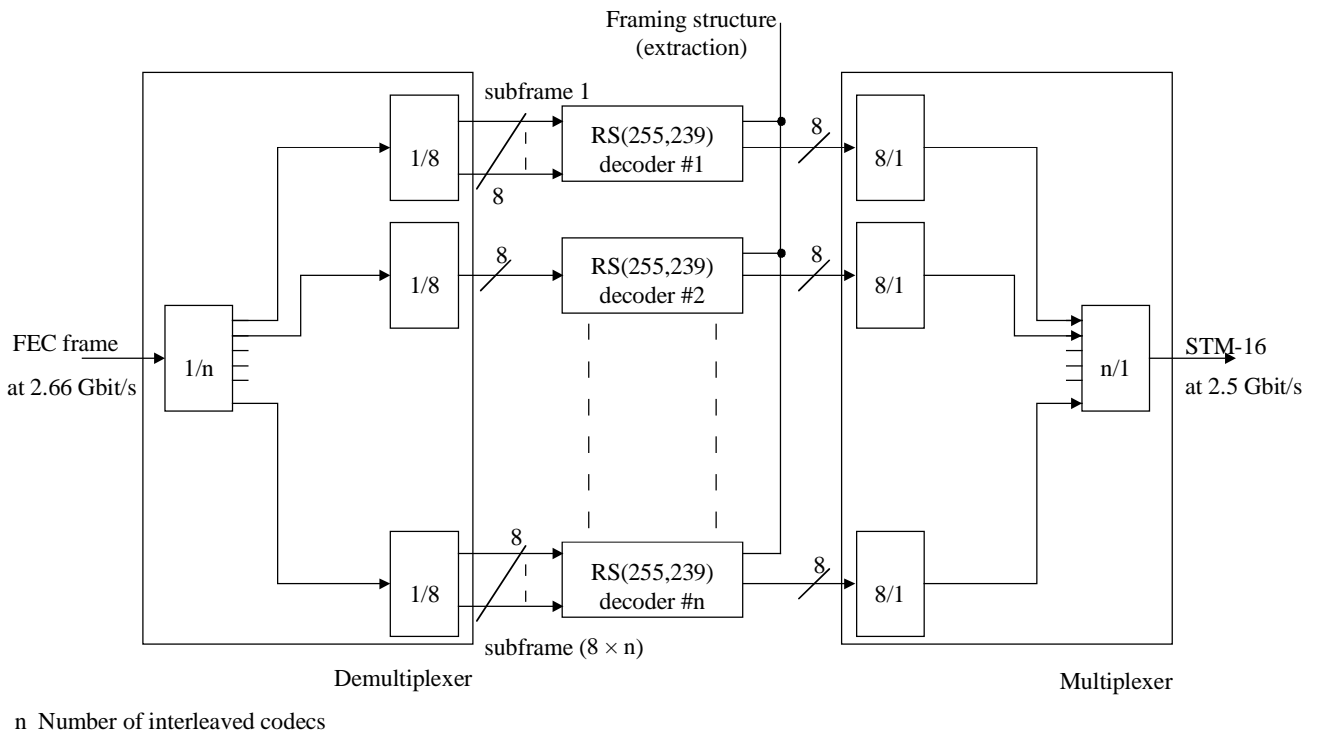

Figure 3/G.975 – FEC decoder architecture

For data integrity, the digital multiplexer and the digital demultiplexer represented in Figures 2 and 3 are strictly symmetrical. In addition, the same digital multiplexers and the same digital demultiplexers are used for both the FEC encoder and the FEC decoder.

Due to the fact that each elementary Reed-Solomon algorithm process byte information and therefore works on 8 parallel data stream, the demultiplexers deliver $(8 \times n)$ data stream to the (n) interleaved codecs while the multiplexers do the reverse operation.

Provided the FEC encoder and the FEC decoder architectures, the FEC frame construction is described in Figure 4.

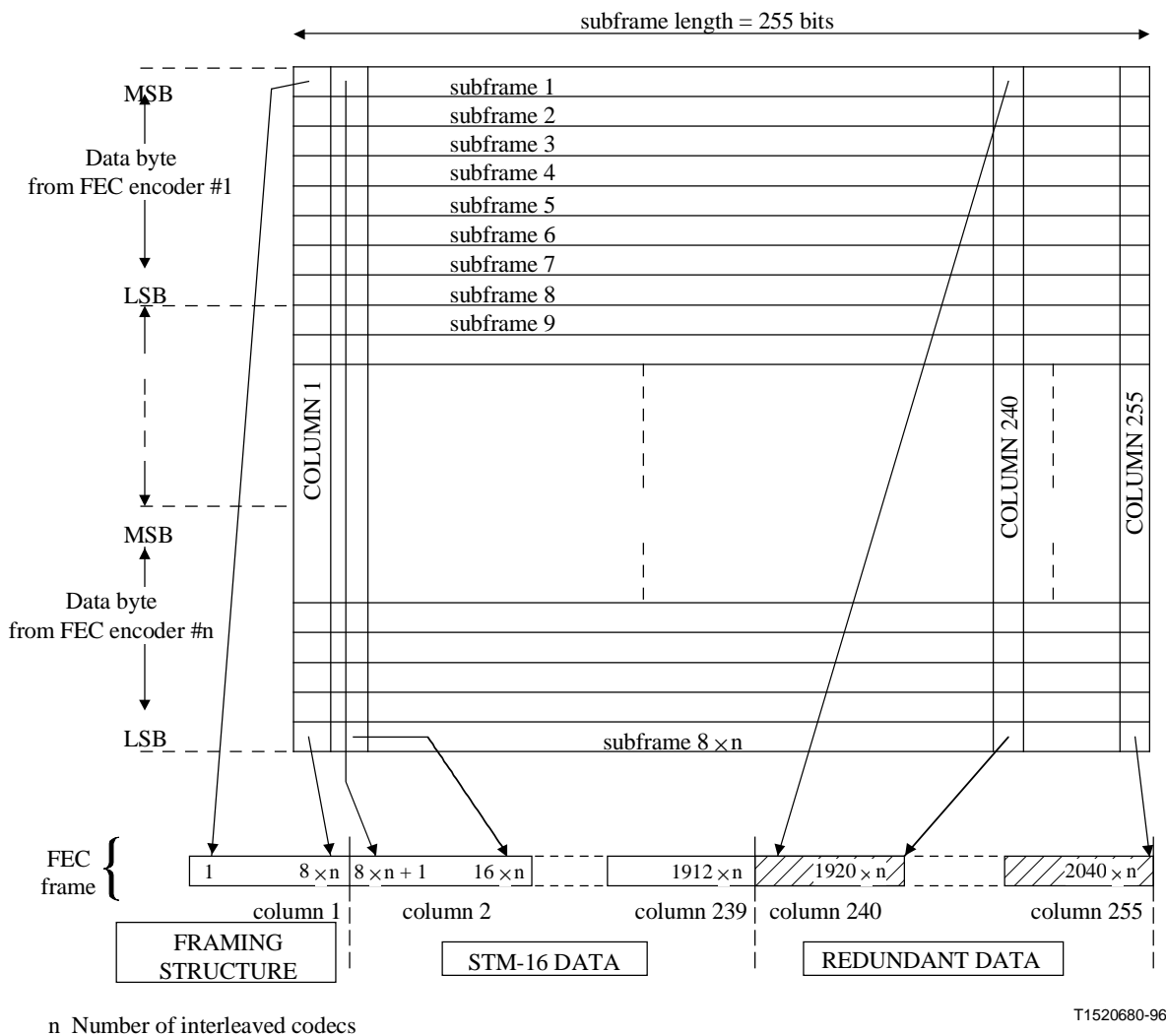

Figure 4/G.975 – FEC frame construction

Due to the interleaving of RS(255,239) codes to depth n , the FEC frame is $(2040 \times n)$ bits long and is made of $(8 \times n)$ bit interleaved subframes.

And, as a consequence of the symmetry of the digital demultiplexers and the digital multiplexers on each side of the Reed-Solomon algorithms, the sequence of STM-16 data bits within the FEC frame is identical to that within the STM-16 input signal.

5.4.2 Framing structure

A framing structure is added in the FEC frame to possibly insert a FEC frame alignment word, which is required to perform the synchronization of the FEC frame with the FEC decoder structure at the receive Terminal Transmission Equipment (TTE).

The remaining spare bits can be used for carrying tributary markers, order wire channels or service channels.

The FEC frame presented in 5.4.1 can be divided into $(8 \times n)$ 255 bits long subframe. Each subframe (see Figure 5) contains the following information:

- bit 1 of each subframe carries the framing structure (either the FEC Frame Alignment Word, the tributary markers for STM-16 data stream identification in systems carrying multiples of STM-16 (if required) or order wire channels or service channels for inter-terminal communication);
- bits 2 to 239 of each subframe carry the STM-16 information;
- bits 240 to 255 of each subframe carry the redundant bits, computed by the RS(255,239) algorithm.

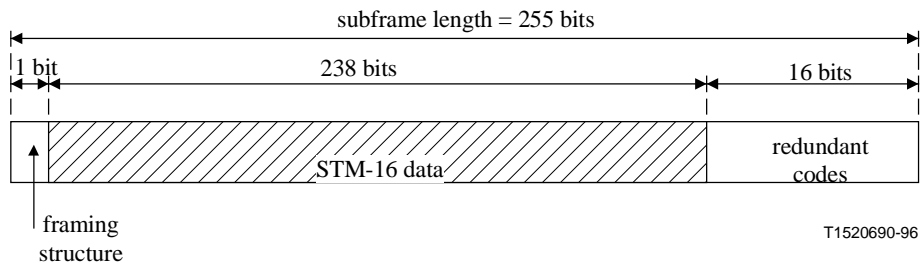

Figure 5/G.975 – Content of the subframes of the FEC frame

5.4.3 Scrambling

STM-16 data in the FEC frame are already scrambled as shown in Recommendation G.707. Hence, rescrambling of the FEC frame is not generally required.

However, when implemented in the submarine Terminal Transmission Equipment (TTE), the scrambling facility should possibly be inhibited.

The scrambling of the FEC frame may be carried out in the following procedure: the FEC frame is scrambled, with the exception of the framing structure bits of the FEC frame, by a $x^7 + x + 1$ polynomial initiated at each frame on the first bit which follows the framing structure in the FEC frame.

The first bits of the scrambler sequence are 1111111. Thereafter, the scrambler runs continuously throughout the complete FEC frame.

5.4.4 Redundancy ratio

The redundancy ratio of the FEC function defined in Recommendation G.975 is equal to 1/14. Consequently, the line bit rates of optical fibre submarine cable systems using the forward error correction feature are as follows:

- one STM-16 tributary carried: $2488.320 \times 15/14$ Gbit/s;
- two STM-16 tributaries carried: 2 multiplexed signals at $2488.320 \times 15/14$ Gbit/s;

- M STM-16 tributaries carried (M is a non-zero integer): M multiplexed signals at $2488.320 \times 15/14$ Gbit/s.

6 FEC function performance

6.1 Theoretical FEC function performance

A criterion for the evaluation of the intrinsic correcting performance of the RS(255,239) code is the theoretical relationship between the line BER after FEC function correction (BER_{Output}) and the line BER before FEC function correction (BER_{Input}).

For the RS codes, this criterion can be mathematically computed with the assumptions that errors occur independently from each other and that the decoder never fails (probability of incorrect decoding equal to zero):

$$\left\{ \begin{array}{l} P_{UE} = \sum_{i=9}^N \frac{i}{N} \cdot \binom{N}{i} \cdot P_{SE}^i \cdot (1 - P_{SE})^{N-i} \\ BER_{Input} = 1 - (1 - P_{SE})^{1/8} \\ BER_{Output} = 1 - (1 - P_{UE})^{1/8} \end{array} \right. \quad \text{with } N = 255$$

with:

- P_{UE} = Probability of an Uncorrectable Error
- P_{SE} = Probability of a Symbol (byte) Error
- N = Codeword length (255)

Figure 6 and Table 1 give an indication of the theoretical intrinsic performance of the RS(255,239) code.

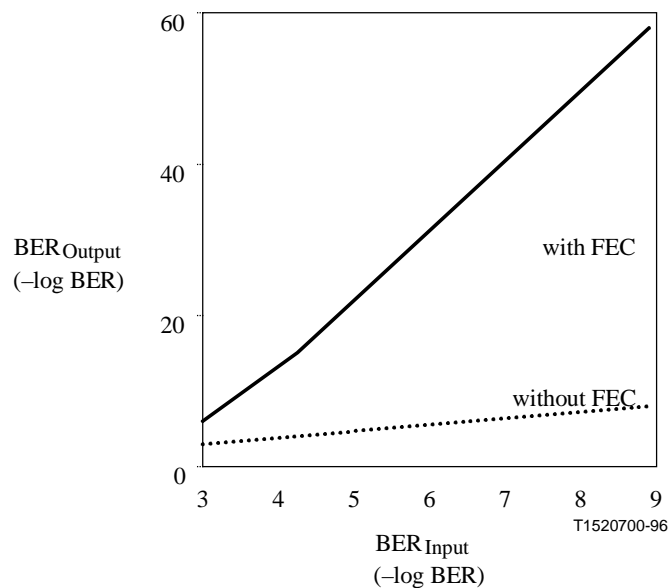

Figure 6/G.975 – Theoretical output versus input BER

Table 1/G.975 – Theoretical output versus input BER

BER_{Input}	BER_{Output}
10^{-4}	$5 \cdot 10^{-15}$
10^{-5}	$6.3 \cdot 10^{-24}$
10^{-6}	$6.4 \cdot 10^{-33}$

The statistical independence between consecutive errors is generally considered to be relevant with the Reed-Solomon interleaving technique: with this approach, a bursty channel is transformed into several independent error channels.

For BER_{Input} above 10^{-3} , the probability of incorrect decoding (an incorrect decoding occurs when the decoder attempts correction but acts incorrectly because the error pattern is beyond its ability to correct) becomes un-negligible and makes the previous calculation of BER_{Output} inaccurate. In such cases, the BER_{Output} versus BER_{Input} curves are even located below the "without FEC" curve in Figure 6.

This calculation remains identical whatever the optical fibre submarine cable system, but gives no indication on the degradation brought by the in-line bit rate increase over the optical transmission channel performances.

6.2 Coding gain

The FEC function performance can also be evaluated through the coding gain, that is, the difference in the input optical power of the receiver required for coded and uncoded operation to provide a specified level of communication performance (BER = 10^{-10} in Figure 7).

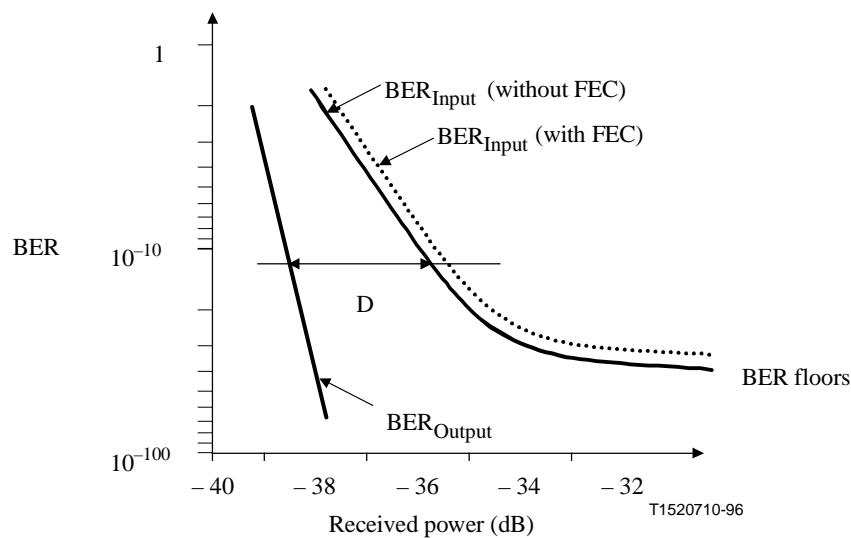

Figure 7/G.975 – Coding gain (D) evaluation scheme

While correcting the BER_{Input}, the FEC function brings a positive coding gain to the system. This coding gain is slightly attenuated by the effect of the signal bandwidth increase brought by the redundant symbols.

The coding gain value intrinsically depends on the overall structure of the optical fibre submarine cable system (inter-repeater distances, photodetection parameters and optical amplifier output power in particular).

When a line BER floor penalizes the optical fibre submarine cable system, one of the most valuable effects of the FEC function is to translate these line BER floors down to acceptable levels which the physical system could never achieve without FEC, regardless of the receiver input power.

The expected coding gain for optical fibre submarine cable systems is 4 to 5 dB per fibre span.

ITU-T RECOMMENDATIONS SERIES

- Series A Organization of the work of the ITU-T
- Series B Means of expression: definitions, symbols, classification
- Series C General telecommunication statistics
- Series D General tariff principles
- Series E Overall network operation, telephone service, service operation and human factors
- Series F Non-telephone telecommunication services
- Series G Transmission systems and media, digital systems and networks**
- Series H Audiovisual and multimedia systems
- Series I Integrated services digital network
- Series J Transmission of television, sound programme and other multimedia signals
- Series K Protection against interference
- Series L Construction, installation and protection of cables and other elements of outside plant
- Series M Maintenance: international transmission systems, telephone circuits, telegraphy, facsimile and leased circuits
- Series N Maintenance: international sound programme and television transmission circuits
- Series O Specifications of measuring equipment
- Series P Telephone transmission quality, telephone installations, local line networks
- Series Q Switching and signalling
- Series R Telegraph transmission
- Series S Telegraph services terminal equipment
- Series T Terminals for telematic services
- Series U Telegraph switching
- Series V Data communication over the telephone network
- Series X Data networks and open system communication
- Series Z Programming languages