



INTERNATIONAL TELECOMMUNICATION UNION

ITU-T

TELECOMMUNICATION
STANDARDIZATION SECTOR
OF ITU

G.767

(10/98)

SERIES G: TRANSMISSION SYSTEMS AND MEDIA,
DIGITAL SYSTEMS AND NETWORKS

Digital transmission systems – Terminal equipments –
Principal characteristics of transcoder and digital
multiplication equipment

**Digital circuit multiplication equipment using
16 kbit/s LD-CELP, digital speech interpolation
and facsimile demodulation/remodulation**

ITU-T Recommendation G.767

(Previously CCITT Recommendation)

ITU-T G-SERIES RECOMMENDATIONS
TRANSMISSION SYSTEMS AND MEDIA, DIGITAL SYSTEMS AND NETWORKS

INTERNATIONAL TELEPHONE CONNECTIONS AND CIRCUITS	G.100–G.199
INTERNATIONAL ANALOGUE CARRIER SYSTEM	
GENERAL CHARACTERISTICS COMMON TO ALL ANALOGUE CARRIER-TRANSMISSION SYSTEMS	G.200–G.299
INDIVIDUAL CHARACTERISTICS OF INTERNATIONAL CARRIER TELEPHONE SYSTEMS ON METALLIC LINES	G.300–G.399
GENERAL CHARACTERISTICS OF INTERNATIONAL CARRIER TELEPHONE SYSTEMS ON RADIO-RELAY OR SATELLITE LINKS AND INTERCONNECTION WITH METALLIC LINES	G.400–G.449
COORDINATION OF RADIOTELEPHONY AND LINE TELEPHONY	G.450–G.499
TESTING EQUIPMENTS	
TRANSMISSION MEDIA CHARACTERISTICS	
General	G.600–G.609
Symmetric cable pairs	G.610–G.619
Land coaxial cable pairs	G.620–G.629
Submarine cables	G.630–G.649
Optical fibre cables	G.650–G.659
Characteristics of optical components and sub-systems	G.660–G.699
DIGITAL TRANSMISSION SYSTEMS	
TERMINAL EQUIPMENTS	G.700–G.799
General	G.700–G.709
Coding of analogue signals by pulse code modulation	G.710–G.719
Coding of analogue signals by methods other than PCM	G.720–G.729
Principal characteristics of primary multiplex equipment	G.730–G.739
Principal characteristics of second order multiplex equipment	G.740–G.749
Principal characteristics of higher order multiplex equipment	G.750–G.759
Principal characteristics of transcoder and digital multiplication equipment	G.760–G.769
Operations, administration and maintenance features of transmission equipment	G.770–G.779
Principal characteristics of multiplexing equipment for the synchronous digital hierarchy	G.780–G.789
Other terminal equipment	G.790–G.799
DIGITAL NETWORKS	G.800–G.899
DIGITAL SECTIONS AND DIGITAL LINE SYSTEM	G.900–G.999

For further details, please refer to ITU-T List of Recommendations.

ITU-T RECOMMENDATION G.767

DIGITAL CIRCUIT MULTIPLICATION EQUIPMENT USING 16 kbit/s LD-CELP, DIGITAL SPEECH INTERPOLATION AND FACSIMILE DEMODULATION/REMODULATION

Summary

This Recommendation specifies the elements of DCME using 16 kbit/s LD-CELP, Digital Speech Interpolation (DSI) and Facsimile Demodulation/Remodulation in order to achieve interworking of such equipment. It specifies extensions and deviations for Recommendations G.763 and G.766 which specify a 32 kbit/s ADPCM DCME, and Facsimile Demodulation/Remodulation.

Source

ITU-T Recommendation G.767 was prepared by ITU-T Study Group 15 (1997-2000) and was approved under the WTSC Resolution No. 1 procedure on the 13th of October 1998.

FOREWORD

ITU (International Telecommunication Union) is the United Nations Specialized Agency in the field of telecommunications. The ITU Telecommunication Standardization Sector (ITU-T) is a permanent organ of the ITU. The ITU-T is responsible for studying technical, operating and tariff questions and issuing Recommendations on them with a view to standardizing telecommunications on a worldwide basis.

The World Telecommunication Standardization Conference (WTSC), which meets every four years, establishes the topics for study by the ITU-T Study Groups which, in their turn, produce Recommendations on these topics.

The approval of Recommendations by the Members of the ITU-T is covered by the procedure laid down in WTSC Resolution No. 1.

In some areas of information technology which fall within ITU-T's purview, the necessary standards are prepared on a collaborative basis with ISO and IEC.

NOTE

In this Recommendation, the expression "Administration" is used for conciseness to indicate both a telecommunication administration and a recognized operating agency.

INTELLECTUAL PROPERTY RIGHTS

The ITU draws attention to the possibility that the practice or implementation of this Recommendation may involve the use of a claimed Intellectual Property Right. The ITU takes no position concerning the evidence, validity or applicability of claimed Intellectual Property Rights, whether asserted by ITU members or others outside of the Recommendation development process.

As of the date of approval of this Recommendation, the ITU had received notice of intellectual property, protected by patents, which may be required to implement this Recommendation. However, implementors are cautioned that this may not represent the latest information and are therefore strongly urged to consult the TSB patent database.

© ITU 1999

All rights reserved. No part of this publication may be reproduced or utilized in any form or by any means, electronic or mechanical, including photocopying and microfilm, without permission in writing from the ITU.

CONTENTS

	Page
1	Scope 1
2	References 1
3	Definitions 1
4	Abbreviations 1
5	DCME frame structure 2
5.1	General 2
5.1.1	Supported services 2
5.1.2	PCM frame 2
5.1.3	DCME frame 2
5.1.4	DCME multiframe 2
5.1.5	16 kbit/s DCME frames 3
6	Bearer frame structure 3
6.1	Cliques, destinations and bearers 3
6.1.1	Number of cliques 3
6.1.2	Number of destinations 3
6.1.3	Multiple outgoing bearers 3
6.2	Assignment Messages (AM) 3
6.3	Bearer Channels (BC)..... 4
6.4	Control Channel (CC) 4
6.5	BC numbering and the use of the bearer frame..... 4
6.5.1	8-bit (64 kbit/s transparent calls) BCs..... 4
6.5.2	5-bit (VBD optimized 40 kbit/s LD-CELP) BCs..... 5
6.5.3	4-bit BCs (BB, FB) 5
6.5.4	Normal range 2-bit BCs (LD-CELP voice)..... 5
6.5.5	Overload BCs 5
6.5.6	Pre-assigned BCs 5
7	Control channel 5
7.1	General 5
7.2	Number of assignment messages..... 5
7.2.1	Single/double AM mode criterion..... 5
7.2.2	Total number of assignment messages..... 5
7.3	Control channel content..... 6
7.3.1	CC synchronization..... 6
7.3.2	Assignment messages..... 6

	Page
7.3.3 Asynchronous data word.....	8
7.3.4 Error correction	10
7.4 CC message transmission scheme.....	11
7.4.1 Control channel structure	11
7.4.2 CC bit mapping	11
8 Variable bit rate and overload channel creation.....	16
8.1 Principles.....	16
8.1.1 Creation of 16 kbit/s channels.....	16
8.1.2 Creation of 12.8 kbit/s channels.....	16
8.1.3 Creation of 9.6 kbit/s channels.....	16
8.2 Overload channel creation.....	16
8.2.1 Notations	16
8.2.2 Packaging schemes.....	16
8.3 Overload channel creation process – The VBR scheme.....	17
8.3.1 VBR lists	17
8.3.2 Notations	18
8.3.3 VBR not required.....	18
8.3.4 VBR required	18
9 ABPS calculations.....	20
10 Channel check procedure	20
11 Facsimile demodulation/remodulation.....	20
11.1 General	20
11.2 Facsimile blocks, facsimile transport channels and fax banks.....	20
11.3 Facsimile data channel	21
11.4 Facsimile control channel and forward error correction	22
11.5 FCC location on the bearer.....	23
12 System statistics measurement	23

Introduction

The introduction of the 16 kbit/s LD-CELP speech compression algorithm by ITU-T (Recommendation G.728), with its expansions to variable bit rates below and above 16 kbit/s, has enabled the enhancement of circuit multiplication equipment performance in both speech quality and multiplication gain. Third generation DCME follows the operation principles of the second generation DCME (DCME in accordance with Recommendations G.763 and G.766), with modifications dictated by the transition from ADPCM, which is a single sample based speech compression algorithm, to LD-CELP, which operates on a 5-sample vector. This Recommendation is, therefore, an extension to Recommendations G.763 (Digital Circuit Multiplication Equipment Using 32 kbit/s ADPCM and Digital Speech Interpolation) and G.766 (Facsimile Demodulation/Remodulation for DCME), as it specifies only the deviations of the third generation DCME from its predecessor.

Recommendation G.767

DIGITAL CIRCUIT MULTIPLICATION EQUIPMENT USING 16 kbit/s LD-CELP, DIGITAL SPEECH INTERPOLATION AND FACSIMILE DEMODULATION/REMODULATION

(Geneva, 1998)

1 Scope

This Recommendation specifies the elements of DCME using 16 kbit/s LD-CELP, Digital Speech Interpolation (DSI) and facsimile demodulation/remodulation (namely a 16 kbit/s DCME) in order to achieve interworking of such equipment. It is an extension to Recommendations G.763 (Digital Circuit Multiplication Equipment Using 32 kbit/s ADPCM and Digital Speech Interpolation) and G.766 (Facsimile Demodulation/Remodulation for DCME), as it specifies only the deviations of the 16 kbit/s DCME from the G.763 32 kbit/s DCME.

2 References

The following ITU-T Recommendations and other references contain provisions which, through reference in this text, constitute provisions of this Recommendation. At the time of publication, the editions indicated were valid. All Recommendations and other references are subject to revision; all users of this Recommendation are therefore encouraged to investigate the possibility of applying the most recent edition of the Recommendations and other references listed below. A list of the currently valid ITU-T Recommendations is regularly published.

- ITU-T Recommendation G.763 (1998), *Digital circuit multiplication equipment using ADPCM (Recommendation G.726) and digital speech interpolation.*
- ITU-T Recommendation G.766 (1996), *Facsimile demodulation/remodulation for digital circuit multiplication equipment.*

3 Definitions

The same definitions of Recommendations G.763 and G.766 are used in this Recommendation.

4 Abbreviations

The abbreviations used in the above-referenced Recommendations are also used in this Recommendation as well. This Recommendation uses also the following abbreviations.

ABPS	Averaged Bit Per Sample
AM	Assignment Message
BB	Bit Bank
BCH	Bose-Chaudhuri-Hocquenghem
FB	Fax Bank
FCC	Facsimile Control Channel
FDC	Facsimile Data Channel

FTC	Facsimile Transport Channel
Info	Information
LD-CELP	Low-Delay Code Excited Linear Prediction
PCM	Pulse Code Modulation
QB	Quarter Byte
Rx	Receive
Tx	Transmit
VBD	Voice-Band Data

5 DCME frame structure

5.1 General

5.1.1 Supported services

The 16 kbit/s DCME frame structure accommodates the following services:

- 8-bit channels to support 64 kbit/s transparent calls.
- 2-bit channels to support voice calls at LD-CELP 16 kbit/s, 12.8 kbit/s, 9.6 kbit/s according to Recommendation G.728 and its Annex H.
- 5-bit channels to support VBD calls at 40 kbit/s according to Recommendation G.728 and its draft Annex J.
- 4-bit channels to support fax banks carrying demodulated fax calls similar to Recommendations G.763 and G.766.
- 8-, 5-, 2-bit channels to support 64 kbit/s, 40 kbit/s, 16 kbit/s, 12.8 kbit/s and 9.6 kbit/s pre-assigned channels.

5.1.2 PCM frame

As in Recommendation G.763, the bearer structure of the 16 kbit/s DCME retains compatibility with Recommendation G.704, so it contains 32 consecutively numbered 8-bit time slots, from 0 to 31¹.

5.1.3 DCME frame

The low rate encoding algorithm used in the 16 kbit/s DCME is LD-CELP according to Recommendation G.728. The LD-CELP algorithm handles a speech vector of 5 consecutive PCM samples (at 64 kbit/s) and results in a vector of 10, 8 or 6 bits (at 16, 12.8 or 9.6 kbit/s respectively). The encoding rate can be altered once every 4 speech vectors, i.e. every 2.5 ms. A DCME frame of 2.5 ms, which contains 20 G.704 PCM frames, is used in the 16 kbit/s DCME.

5.1.4 DCME multiframe

The IT related circuit supervision/alarm condition field of the asynchronous word supports up to 360 ITs, carried over up to 12 primary rate interfaces. The G.767 DCME multiframe of 72 DCME frames is used to accommodate that.

¹ The case of T1 bearer interface is similar to E1 and handled as in Recommendation G.763.

5.1.5 16 kbit/s DCME frames

The 16 kbit/s DCME frame and multiframe structures are depicted in Figure 1.

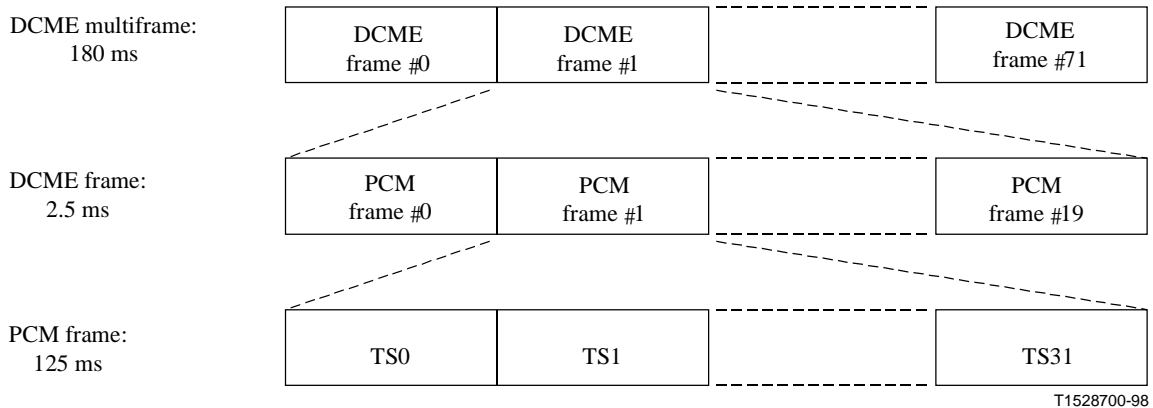

Figure 1/G.767 – 16 kbit/s frame and multiframe structures

6 Bearer frame structure

6.1 Cliques, destinations and bearers

6.1.1 Number of cliques

With LD-CELP, small cliques (compared to G.763 DCME) can support a fairly large amount of traffic. Therefore the maximum number of cliques (pools) carried on a single bearer in 16 kbit/s DCME is increased to 4. Each pool starts and ends on TS boundaries (and therefore occupies an integral number of time slots).

6.1.2 Number of destinations

The maximum number of destinations is 4 including the cases of mixed operation between multi-clique and multi-destination modes.

6.1.3 Multiple outgoing bearers

Optionally, a 16 kbit/s DCME will support up to 4 outgoing bearers. A single bearer will be able to carry up to 4 cliques. A clique shall not be split across bearers.

6.2 Assignment Messages (AM)

When using LD-CELP, the DCME gain increases significantly and the number of supported ITs is increased accordingly (compared to ADPCM). As a result, the number of activity events (and assignment messages) increases. Taking into account the fact that the DCME frame is extended (from 2 ms to 2.5 ms), the control channel can support up to two assignment messages (namely double AM) every DCME frame, so as to avoid long queues and freeze-out due to limited control channel capacity. The option of operating with a single Assignment Message (single AM), when smaller configurations are applied, is maintained.

6.3 Bearer Channels (BC)

16 kbit/s LD-CELP encoded voice calls use 2 bits every PCM frame. Therefore the 16 kbit/s DCME bearer channels occupy 2 bits each. These basic Bearer Channels (BCs) shall be referred to as Quarter Bytes (QBs) in this Recommendation. Each QB occupies 40 bits every DCME frame².

6.4 Control Channel (CC)

A single AM control channel of the 16 kbit/s DCME occupies 4 bits every PCM frame, i.e. 2 QBs. The single AM control channel holds the synchronization word, an assignment message (IT and BC numbers and synchronous data word), the asynchronous data word and some error correction bits. When an additional assignment message in the same DCME frame is required (double AM), one additional QB supports it.

6.5 BC numbering and the use of the bearer frame

Each time slot is subdivided into 4 QBs. The leftmost two or three QBs of each pool carries the control channel (single or double AM, respectively). The remaining QBs of the pool are the Bearer Channels (BCs) and are used to carry traffic.

The normal range BCs are consecutively numbered. When a single AM control channel is used, the BC that follows the control channel is BC number one. In the case of double AM the numbering starts with 2, i.e. BC number 1 is skipped. In the case of a single pool, the maximum number of normal BCs is 122 for single AM and 121 for double AM. The numbering scheme is shown in Figure 2.

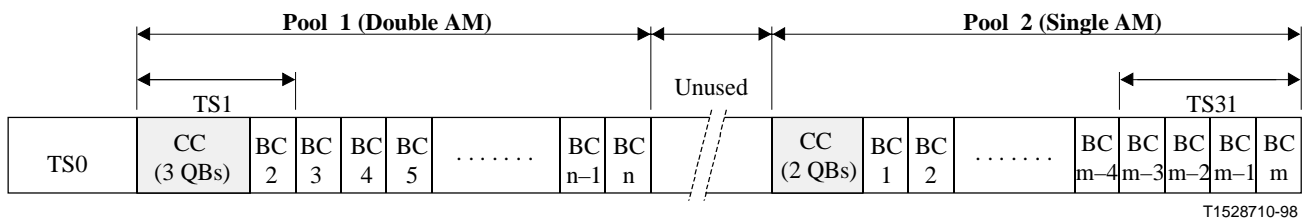

Figure 2/G.767 – 16 kbit/s DCME frame structure and BC numbering scheme for 2 pools

The BC numbers contained in the assignment messages can be either in the range 1 through 122 (normal range) or in the range 128 through 207 (overload range). The total number of normal bearer channels shall also not exceed 122 even in the case of multiple outgoing bearer usage. The criteria for associating the BCs contained in the assignment message to bits within the bearer structure are as follows:

6.5.1 8-bit (64 kbit/s transparent calls) BCs

The BC number in the assignment message indicates the BC which carries the first 2 bits of the 8-bit sample. The rest of the bits are carried by the next three higher BCs. The same restrictions of G.763 are maintained, so unrestricted 64 kbit/s ITs will occupy one G.704 time slot. This implies that the 4-modulus of the BC number in the assignment message is 3. 16 kbit/s DCME will maintain frame integrity of consecutive trunk time slots which are allocated for $N \times 64$ kbit/s calls.

² The term "QB" replaces the term "nibble" of Recommendation G.763.

6.5.2 5-bit (VBD optimized 40 kbit/s LD-CELP) BCs

The BC number in the assignment message indicates the BC which carries the first 2 bits (MSB, MSB – 1) of the 5-bit sample. The next higher BC carries the next 2 bits ((MSB – 2, MSB – 3) ≡ (LSB + 2, LSB + 1)). The 5th bit (LSB) is obtained from a different 4-bit bearer channel which is independently assigned as a bit bank. Similarly to Recommendation G.763, all 4-bit BCs (Data, FB or BB) occupy either the four MSBs or the four LSBs of a G.704 time slot. This implies that the BC number in the assignment message, for such BCs, is an odd number.

6.5.3 4-bit BCs (BB, FB)

16 kbit/s DCME fax banks and bit banks are used in the same manner as they are used in Recommendation G.763/G.766. The BC number in the assignment message indicates the BC which carries the first 2 bits of the 4-bit sample. The next higher BC carries 2 more bits.

6.5.4 Normal range 2-bit BCs (LD-CELP voice)

The BC number in the assignment message indicates the BC which carries the LD-CELP encoded IT bits. If high load conditions exist, overload channels will be created. The BC number of a 4-bit channel is an odd number.

6.5.5 Overload BCs

The BC number in the assignment message indicates an overload bearer channel which carries the IT bits.

6.5.6 Pre-assigned BCs

16 kbit/s DCME pre-assigned ITs are assigned in the same manner as they are in G.763 DCME. 64, 40, 16, 12.8 and 9.6 kbit/s ITs can be pre-assigned.

7 Control channel

7.1 General

The 16 kbit/s DCME control channel operates with two assignment messages (one assignment message for small cliques) in the 2.5 ms time-frame. The control channel contains a total of 80 or 120 bits of data in each 2.5 ms DCME frame, depending on whether one or two assignment messages (AMs) are used. These bits are transmitted at a rate of 4 or 6 bits every 125 μs PCM frame. The control channel, thus, occupies 2 Quarter Bytes (QBs) in the case of single AM mode and 3 QBs in the case of double AM mode.

Apart from assignment messages, the control channel also conveys the asynchronous data word.

7.2 Number of assignment messages

The single or double AM mode is determined for each clique, according to the following rules:

7.2.1 Single/double AM mode criterion

When the clique size is 11 time slots or lower, that clique's control channel operates in the single AM mode. When the clique size is 12 time slots or higher, that clique's control channel operates in the double AM mode.

7.2.2 Total number of assignment messages

The total number of assignment messages per Tx unit is 5.

7.3 Control channel content

The contents of the control channel are a synchronization pattern, one or two assignment messages, an asynchronous data word and error correction code.

7.3.1 CC synchronization

The frame synchronization pattern is a unique word of 20 bits, one bit every PCM frame of the DCME frame. The 20-bit unique word also provides a means of identifying the beginning of a 180 ms DCME multiframe (72 DCME frames) for use by the asynchronous data word.

7.3.1.1 Unique word pattern

The unique word transmitted with DCME frame #0 is:

00010001111100101101

The unique word transmitted with DCME frames #1 through #71 is:

11101110000011010010

7.3.1.2 Unique word detection

The unique word detection is based on the detection of a correlation match between the accumulated contents of the first bit of the CC and a locally stored unique word pattern. The resulting correlation matches is used to attain, maintain and regain the synchronization of the CC message.

In the steady state, a detection threshold of three is used to maintain synchronization, and a 3-bit window centred 20 bits after the previous detection of the correlation match is used to locate the start of the DCME frame for the proper decoding of the CC message. If the correlation match is not achieved, the CC message bits are discarded and a search procedure is initiated over a 20-bit window.

7.3.2 Assignment messages

Each assignment message consists of 23 bits that include:

- 9 bits IT identification word;
- 9 bits BC identification word (1 bit BC type + 8 bits BC number);
- 5 bits synchronous data word.

7.3.2.1 IT Identification word

The 9 bits of the IT identification word is used to identify the ITs. IT numbering is given in Table 1.

Table 1/G.767 – Numbers of ITs used in assignment messages

IT number	IT identification
0	Explicit disconnection of BC or during system start-up and map change.
1 through 360	IT used for traffic.
461 through 464	Voice order wire to destination number 1 to 4 respectively.
490	BC used as a bit bank.
491	BC used as a fax bank.
471 through 474	Channel check to clique number 1 to 4 respectively.
475 through 478	Local IT number to receive channel check from destination number 1 to 4 respectively.
511	Ineffective CC message when all traffic is pre-assigned.

7.3.2.2 BC identification word

The first (MSB) bit of the 9-bit BC identification word is used to indicate the BC type. For data, this bit will be 1 and for all other BC types it will be 0.

The 8 LSBs in binary code identify the BC number in accordance with the agreed numbering scheme. The normal BC numbering range is 1 through 122. The overload BC numbering range is 128 through 207.

For 4-bit services, the BC number identifies the first 2-bit BC of a pair adjacent 2-bit BCs, used to create a 4-bit BC and is an odd number.

For a 64 kbit/s transparent channel, the BC number identifies the first 2-bit BC of a group of 4 adjacent BCs that occupy exactly one G.704 time slot of the bearer and its 4-modulus is 3.

BC number 0 in binary code is used for CC messages transmitted during system start-up or during a DCME transmit unit map change.

BC number 511 in binary code is used to indicate an ineffective CC message if all traffic is pre-assigned.

7.3.2.3 Synchronous data word

The 5 bits synchronous data word supports the following messages:

- Background noise level (16 levels).
- Channel check procedure.
- Transparent request.
- Signalling information when optional USM is used.
- The ineffective code (transmitted when the IT number indicates a fax bank or a bit bank and when a disconnect message or an ineffective message is sent).

Table 2 shows the encoded messages to be transported by the synchronous data word.

Table 2/G.767 – Synchronous data word encoding

Code	Transmit side action: measure noise level	Receive side action: store noise level	Code	Transmit side action: measure noise level	Receive side action: store noise level
00000	Ineffective		10000	n/u	
00001	μ -law: $n < -72.0$ A-law: not applicable	μ -law: no noise	10001	$-54.0 \leq n < -51.0$	-52
00010	μ -law: $-72.0 \leq n < -67.0$ A-law: $n < -67.0$	μ -law: -68 A-law: no noise	10010	$-51.0 \leq n < -49.0$	-50
00011	$-67.0 \leq n < -65.5$	-66.5	10011	$-49.0 \leq n < -47.0$	-48
00100	$-65.5 \leq n < -64.0$	-65	10100	$-47.0 \leq n < -45.0$	-46
00101	$-64.0 \leq n < -61.0$	-62.5	10101	$-45.0 \leq n < -44.0$	-44.5
00110	$-61.0 \leq n < -59.0$	-60	10110	$-44.0 \leq n < -42.8$	-43
00111	$-59.0 \leq n < -56.0$	-57.5	10111	$-42.8 \leq n < -42.0$	-42.5
01000	$-56.0 \leq n < -54.0$	-55	11000	$-42.0 \leq n$	-42
01001	n/u		11001	n/u	
01010	n/u		11010	n/u	
01011	n/u		11011	n/u	
01100	n/u		11100	n/u	
01101	n/u		11101	Transparent	
01110	n/u		11110	n/u	
01111	n/u		11111	BC is under channel check procedure	

NOTE 1 – Noise levels in dBm0.

NOTE 2 – The transmit unit noise measurement should be broadband.

NOTE 3 – "n/u" means this code is not used – reserved for future use.

NOTE 4 – It is suggested that because the noise inserted at the receive unit is broadband, the transmit unit noise measurement should also be broadband.

NOTE 5 – The DCME transmit unit noise intervals are implementation specific, a tolerance of ± 2 dB is suggested.

NOTE 6 – When the background noise level is high (-46 dBm0 or greater), some Administrations have indicated there may be a subjective benefit in inserting lower values of noise at the receive unit than those measured at the transmit unit. The contrast is most apparent when the noise spectral density at the DCME transmit unit is substantially different from the noise inserted at the receive unit. Since the noise inserted at the receive unit does not affect DCME interoperability, the selection of the noise level is left as an option (-50 dBm0 is being considered).

7.3.3 Asynchronous data word

The asynchronous data word consists of 6 bits transmitted in a multiframe structure of 72 DCME frames (180 ms). This results in 432 bits per DCME multiframe for the asynchronous data message. The asynchronous data message holds a net number of 390 bits, including:

- 360 bits IT related circuit supervision/alarm indication.
- 4 bits DCME bearer backward alarm.
- 4 bits DLC support message.
- 5 bits report channel check results.

- 8 bits report BC related channel check results.
- 9 bits number of decoder under test.

These bits are transmitted in the asynchronous data word according to Table 3 where bit 1 is transmitted first and bit 6 is transmitted last.

Table 3/G.767 – Asynchronous data word bit allocation

DCME frame	Bit 1 (Note)	Bit 2	Bit 3	Bit 4	Bit 5	Bit 6	Message
0 1 ⋮ 58 59	1 7 ⋮ 349 355	2 8 ⋮ 350 356	3 9 ⋮ 351 357	4 10 ⋮ 352 358	5 11 ⋮ 353 359	6 12 ⋮ 354 360	<p>Type: IT-related circuit supervision/alarm condition.</p> <p>Designation: The number represents IT number.</p> <p>Content: 0 = normal condition. 1 = alarm condition.</p>
60	A	A	A	A	x	x	<p>Type: DCME bearer backward alarm.</p> <p>Designation: The data word bit number represents Rx bearer number.</p> <p>Content: 0 = normal condition. 1 = alarm condition.</p>
61	p	q	r	s	x	x	<p>Type: DLC support message.</p> <p>Designation: p: voice/voice-band data. q: unrestricted 64 kbit/s.</p> <p>Content: 0 = LL or UCA. 1 = HL or UCNA. r, s = 2-bit binary code to identify each receive destination.</p>
62	b1	b2	R	Y	T	x	<p>Type: Identification of Rx bearer to which channel check results apply, if channel check is progressing normally.</p> <p>Designation and content: b1, b2: Rx bearer number. <i>R:</i> 1 = channel check disregarded (high BER). 0 = progressing normally. <i>Y: channel check alarm.</i> 0 = normal (pass). 1 = alarm (fail). <i>T: transmit channel check inhibit.</i> 0 = channel check normal. 1 = channel check interrupted.</p>

Table 3/G.767 – Asynchronous data word bit allocation (concluded)

DCME frame	Bit 1 (Note)	Bit 2	Bit 3	Bit 4	Bit 5	Bit 6	Message
63	BC (MSB)	BC	BC	BC	x	x	Type: BC related channel check results, transmitted one BC per DCME multiframe. BC: 8-bit code represents the number of the BC for which the results apply.
64	BC	BC	BC	BC (LSB)	x	x	
65	D (MSB)	D	D	D	x	x	D: 9-bit code represents the number of the decoder for which the results apply.
66	D	D	D	D	D (LSB)	x	
67-71	x	x	x	x	x	x	Not used, reserved.

NOTE – x means unused, set to zero, reserved for future use.

7.3.4 Error correction

7.3.4.1 Bit count

Each assignment message contains 23 bits (9-bit BC, 9-bit IT and 5-bit synchronous data word). The 6-bit asynchronous data word appears once (regardless of AM mode) in the control channel. A spare of 12 bits is reserved for each DCME frame. It is therefore required to protect 41 bits in the single AM mode (23 + 6 + 12) and 64 bits (23 + 23 + 6 + 12) in the double AM mode.

7.3.4.2 Error correction code

The control channel error correction code to be used is BCH(63,45) which uses the polynomial division remainder of:

$$g(X) = X^{18} + X^{17} + X^{16} + X^{15} + X^9 + X^7 + X^6 + X^3 + X^2 + X^1 + 1$$

This is a triple error correcting code of minimum distance 7. The code is capable of protecting up to 45 bits by adding 18 check bits.

Since the code is capable of protecting 45 bits by adding 18 check bits, and here it is required to protect only 41 data bits in single AM and 23 data bits in double AM, it is assumed that the 4 unused most significant bits of data in single AM and 22 unused most significant bits of data in double AM are all zero at both Tx and Rx side, as shown in Figures 3 and 4 respectively.

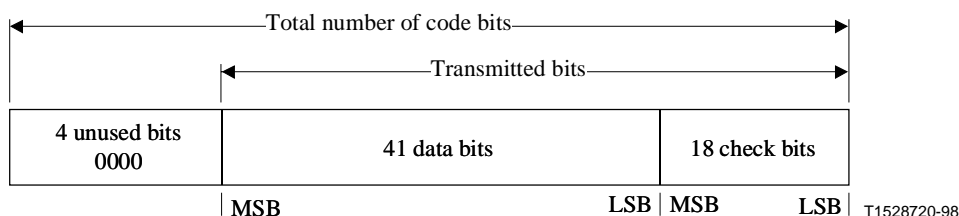

Figure 3/G.767 – Structure of BCH(63,45) code for single AM

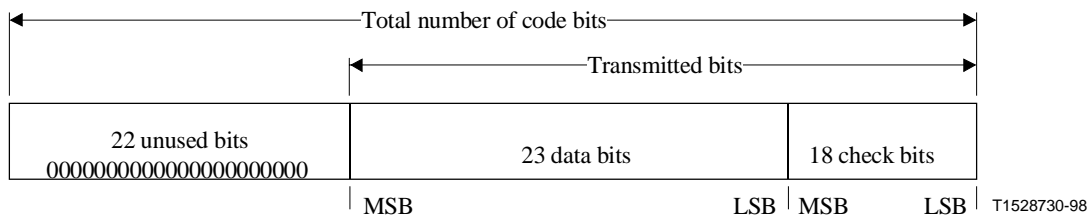

Figure 4/G.767 – Structure of BCH(63,45) code for double AM

7.4 CC message transmission scheme

7.4.1 Control channel structure

7.4.1.1 Single AM

- assignment message: 23 bits
- asynchronous data word: 6 bits
- spare: 12 bits
- error correction: 18 bits
- dummy: 1 bit
- synchronization pattern: 20 bits
- *Total* 80 bits

7.4.1.2 Double AM

- two assignment messages: 46 bits (23×2)
- asynchronous data word: 6 bits
- spare: 12 bits
- error correction: 36 bits (18×2)
- synchronization pattern: 20 bits
- *Total* 120 bits

7.4.2 CC bit mapping

Following are the control channel message transmission schemes for single AM and double AM modes and for USM. The schemes are given in Tables 4 through 7. Each row in the tables lists the bits to be transmitted in one PCM frame within the DCME frame. The leftmost bit of each row is transmitted first. For each field of the message (BC identification, IT identification, etc.) bit number 0 (e.g. it0, bc0) is the MSB, bit number 1 is MSB – 1 and so on.

7.4.2.1 Single IT USM

Optionally, USM will be used to carry signalling information of a single IT and its associated *abcd* bits. In this case, the a2 and b2 fields in Tables 6 and 7 will be used to carry the *c* and *d* bits (respectively) associated with it1, the a3 and b3 fields will carry the *c* and *d* bits of it3, and the it2 and it4 fields will not be used.

Table 4/G.767 – CC message transmission scheme of a single AM control channel

PCM frame #0	u0	bc0	it0	it1
PCM frame #1	u1	bc1	it2	it3
PCM frame #2	u2	bc2	it4	it5
PCM frame #3	u3	bc3	it6	it7
PCM frame #4	u4	bc4	it8	d0
PCM frame #5	u5	bc5	d1	d2
PCM frame #6	u6	bc6	d3	d4
PCM frame #7	u7	bc7	d5	d6
PCM frame #8	u8	bc8	d7	d8
PCM frame #9	u9	sw0	d9	d10
PCM frame #10	u10	sw1	d11	c0
PCM frame #11	u11	sw2	c1	c2
PCM frame #12	u12	sw3	c3	c4
PCM frame #13	u13	sw4	c5	c6
PCM frame #14	u14	aw0	c7	c8
PCM frame #15	u15	aw1	c9	c10
PCM frame #16	u16	aw2	c11	c12
PCM frame #17	u17	aw3	c13	c14
PCM frame #18	u18	aw4	c15	c16
PCM frame #19	u19	aw5	c17	o
u0-u19: Synchronization bits (unique word) (u0 = MSB) it0-it8: IT number (it0 = MSB) bc0: BC type bc1-bc8: BC number (bc1 = MSB) sw0-sw4: Synchronous data word of single assignment message (sw0 = MSB) aw0-aw5: Asynchronous data word (aw0 = MSB) d: spare o: dummy bit c0-c17: Check bits (c1 = MSB)				

Table 5/G.767 – CC message transmission scheme of a double AM control channel

PCM frame #0	u0	bc0	it0	it1	BC0	BC1
PCM frame #1	u1	bc1	it2	it3	BC2	BC3
PCM frame #2	u2	bc2	it4	it5	BC4	BC5
PCM frame #3	u3	bc3	it6	it7	BC6	BC7
PCM frame #4	u4	bc4	it8	d0	BC8	IT0
PCM frame #5	u5	bc5	d1	d2	IT1	IT2
PCM frame #6	u6	bc6	d3	d4	IT3	IT4
PCM frame #7	u7	bc7	d5	d6	IT5	IT6
PCM frame #8	u8	bc8	d7	d8	IT7	IT8
PCM frame #9	u9	sw0	d9	d10	SW0	SW1
PCM frame #10	u10	sw1	d11	c0	SW2	SW3
PCM frame #11	u11	sw2	c1	c2	SW4	C0
PCM frame #12	u12	sw3	c3	c4	C1	C2
PCM frame #13	u13	sw4	c5	c6	C3	C4
PCM frame #14	u14	aw0	c7	c8	C5	C6
PCM frame #15	u15	aw1	c9	c10	C7	C8
PCM frame #16	u16	aw2	c11	c12	C9	C10
PCM frame #17	u17	aw3	c13	c14	C11	C12
PCM frame #18	u18	aw4	c15	c16	C13	C14
PCM frame #19	u19	aw5	c17	c17	C15	C16
<p>u0-u19: Synchronization bits (unique word)</p> <p>it0-it8: IT number of first assignment message</p> <p>bc0-bc8: BC type and BC number of first assignment message</p> <p>sw0-sw4: Synchronous data word of first assignment message</p> <p>IT0-IT8: IT number of second assignment message</p> <p>BC0-BC8: BC type and BC number of second assignment message</p> <p>SW0-SW4: Synchronous data word of second assignment message</p> <p>aw0-aw5: Asynchronous data word</p> <p>d: spare</p> <p>c0-c17: Check bits of correction block #1</p> <p>C0-C17: Check bits of correction block #2 (C1 = MSB)</p> <p>Unshaded bits are in correction block #1</p> <p>Shaded bits are in correction block #2</p>						

Table 6/G.767 – CC USM message transmission scheme of a single AM control channel

PCM frame #0	u0	it1.0	it2.0	it2.1
PCM frame #1	u1	it1.1	it2.2	it2.3
PCM frame #2	u2	it1.2	it2.4	it2.5
PCM frame #3	u3	it1.3	it2.6	it2.7
PCM frame #4	u4	it1.4	it2.8	d0
PCM frame #5	u5	it1.5	d1	d2
PCM frame #6	u6	it1.6	d3	d4
PCM frame #7	u7	it1.7	d5	d6
PCM frame #8	u8	it1.8	d7	d8
PCM frame #9	u9	a1	d9	d10
PCM frame #10	u10	b1	d11	c0
PCM frame #11	u11	a2	c1	c2
PCM frame #12	u12	b2	c3	c4
PCM frame #13	u13	o	c5	c6
PCM frame #14	u14	aw0	c7	c8
PCM frame #15	u15	aw1	c9	c10
PCM frame #16	u16	aw2	c11	c12
PCM frame #17	u17	aw3	c13	c14
PCM frame #18	u18	aw4	c15	c16
PCM frame #19	u19	aw5	c17	o
<p>u0-u19: Synchronization bits (unique word) (u0 = MSB) it1.0-it1.8: First IT number (it1.0 = MSB) it2.0-it2.8: Second IT number (it2.0 = MSB) a1, b1: a and b signalling bits of 1st IT a2, b2: a and b signalling bits of 2nd IT or c and d bits of 1st IT aw0-aw5: Asynchronous data word (aw0 = MSB) d: spare o: dummy bit c0-c17: Check bits (c1 = MSB)</p>				

Table 7/G.767 – CC USM message transmission scheme of a double AM control channel

PCM frame #0	u0	it1.0	it2.0	it2.1	it3.0	it3.1
PCM frame #1	u1	it1.1	it2.2	it2.3	it3.2	it3.3
PCM frame #2	u2	it1.2	it2.4	it2.5	it3.4	it3.5
PCM frame #3	u3	it1.3	it2.6	it2.7	it3.6	it3.7
PCM frame #4	u4	it1.4	it2.8	d0	it3.8	it4.0
PCM frame #5	u5	it1.5	d1	d2	it4.1	it4.2
PCM frame #6	u6	it1.6	d3	d4	it4.3	it4.4
PCM frame #7	u7	it1.7	d5	d6	it4.5	it4.6
PCM frame #8	u8	it1.8	d7	d8	it4.7	it4.8
PCM frame #9	u9	a1	d9	d10	a3	b3
PCM frame #10	u10	b1	d11	c0	a4	b4
PCM frame #11	u11	a2	c1	c2	o	c0
PCM frame #12	u12	b2	c3	c4	c1	c2
PCM frame #13	u13	o	c5	c6	c3	c4
PCM frame #14	u14	aw0	c7	c8	c5	c6
PCM frame #15	u15	aw1	c9	c10	c7	c8
PCM frame #16	u16	aw2	c11	c12	c9	c10
PCM frame #17	u17	aw3	c13	c14	c11	c12
PCM frame #18	u18	aw4	c15	c16	c13	c14
PCM frame #19	u19	aw5	c17	c17	c15	c16
<p>u0-u19: Synchronization bits (unique word)</p> <p>it1.0-it1.8: First IT number (it1.0 = MSB)</p> <p>it2.0-it2.8: Second IT number (it2.0 = MSB)</p> <p>it3.0-it3.8: Third IT number (it1.0 = MSB)</p> <p>it4.0-it4.8: Fourth IT number (it2.0 = MSB)</p> <p>a1, b1: a and b signalling bits of 1st IT</p> <p>a2, b2: a and b signalling bits of 2nd IT or c and d bits of 1st IT</p> <p>a3, b3: a and b signalling bits of 3rd IT</p> <p>a4, b4: a and b signalling bits of 4th IT or c and d bits of 3rd IT</p> <p>o: dummy bit</p> <p>aw0-aw5: Asynchronous data word</p> <p>d: spare</p> <p>c0-c17: Check bits of correction block #1</p> <p>C0-C17: Check bits of correction block #2 (C1 = MSB)</p> <p>Unshaded bits are in correction block #1</p> <p>Shaded bits are in block #2</p>						

8 Variable bit rate and overload channel creation

8.1 Principles

The LD-CELP algorithm produces a 10-bit vector every 5 PCM frames (625 μ s) when operating in 16 kbit/s, an 8-bit vector in the same time-frame when operating in 12.8 kbit/s and a 6-bit vector in 9.6 kbit/s.

The change of rate can be done once every 2.5 ms (a 16 kbit/s DCME frame). The above-mentioned rates are achieved using two basic packaging schemes:

8.1.1 Creation of 16 kbit/s channels

To create a 16 kbit/s channel, a single Quarter Byte (QB) is used to carry one channel.

8.1.2 Creation of 12.8 kbit/s channels

To create 12.8 kbit/s channels, 4 QBs are used to carry 5 channels. From each QB, 2 bits are "stolen" every 5 PCM frames therefore leaving 8 bits in that QB to carry one normal range 12.8 kbit/s channel. The total amount of "stolen" bits within the algorithmic frame is 8 (4×2) bits serving one additional 12.8 kbit/s overload channel.

8.1.3 Creation of 9.6 kbit/s channels

To create 9.6 kbit/s channels, 3 QBs are used to carry 5 channels. From each QB, 4 bits are "stolen" every 5 PCM frames therefore leaving 6 bits in that QB to carry one normal range 9.6 kbit/s channel. The total amount of "stolen" bits within the algorithmic frame is 12 (3×4) bits serving two additional 9.6 kbit/s overload channels.

8.2 Overload channel creation

8.2.1 Notations

$\{i/j\}$ Bit number j of the LD-CELP vector of BC number i . The first bit is $j = 0$ and the last bit is $j = 9$ for 16 kbit/s, $j = 7$ for 12.8 kbit/s and $j = 5$ for 9.6 kbit/s.

C 5-modulus counter that counts PCM frames within the DCME frame.

8.2.2 Packaging schemes

Many packaging schemes can be designed to accommodate the principles defined above. The specific schemes used in this Recommendation comply also with the requirement that no more than 2 bits of the same LD-CELP vector will be injected every PCM frame.

8.2.2.1 16 kbit/s packaging

If a QB is assigned to carry traffic at 16 kbit/s from BC number N , then in $C = 0$ PCM frames (PCM frames #0, #5, #10 and #15 of the DCME frame) it carries $\{N/0\}$ as MSB and $\{N/1\}$ as LSB, in $C = 1$ PCM frames (PCM frames #1, #6, #11 and #16 of the DCME frame) it carries $\{N/2\}$ and $\{N/3\}$ and so on.

8.2.2.2 12.8 kbit/s packaging

QBs a, b, c and d are assigned to carry traffic from BCs I, J, K, L and M. This is done according to the scheme shown in Figure 5:

C	QBa		QBb		QBc		QBd	
0	{M/0}	{M/1}	{J/0}	{J/1}	{K/0}	{K/1}	{L/0}	{L/1}
1	{I/0}	{I/1}	{M/2}	{M/3}	{K/2}	{K/3}	{L/2}	{L/3}
2	{I/2}	{I/3}	{J/2}	{J/3}	{M/4}	{M/5}	{L/4}	{L/5}
3	{I/4}	{I/5}	{J/4}	{J/5}	{K/4}	{K/5}	{M/6}	{M/7}
4	{I/6}	{I/7}	{J/6}	{J/7}	{K/6}	{K/7}	{L/6}	{L/7}

T1528740-98

NOTE – BC #M uses the "stolen" bits.

Figure 5/G.767 –12.8 kbit/s packaging

8.2.2.3 9.6 kbit/s packaging

QBs a, b and c are assigned to carry traffic from BCs I, J, K, L and M. This is done according to the scheme shown in Figure 6:

C	QBa		QBb		QBc	
0	{I/0}	{I/1}	{J/0}	{J/1}	{L/0}	{L/1}
1	{I/2}	{I/3}	{J/2}	{J/3}	{M/0}	{M/1}
2	{I/4}	{I/5}	{J/4}	{J/5}	{K/0}	{K/1}
3	{L/2}	{L/3}	{M/2}	{M/3}	{K/2}	{K/3}
4	{L/4}	{L/5}	{M/4}	{M/5}	{K/4}	{K/5}

T1528750-98

NOTE – BCs #L and #M use the "stolen" bits.

Figure 6/G.767 – 9.6 kbit/s packaging

8.3 Overload channel creation process – The VBR scheme

8.3.1 VBR lists

The overload channel creation process maintains two lists:

Voice list – This list contains the numbers of BCs which state voice (normal and overload), voice-avail and disconnect (normal range only). At initialization, this list contains all normal BC numbers subject to DSI.

QB list – This list contains the numbers of QBs that can be used to carry voice traffic, including disconnected BCs. This list is actually a subset of the voice list and contains only the numbers of the normal range BCs.

Both lists are maintained in ascending order and can be changed once every DCME frame. When overload channel creation is required, the VBR procedure enables the creation of all three rates (16 kbit/s, 12.8 kbit/s and 9.6 kbit/s) simultaneously.

8.3.2 Notations

N_{QB}	Length of the QB list.
N_V	Length of the voice list.
N_{16}	Number of QBs that carry traffic at 16 kbit/s.
$N_{12.8}$	Number of QBs that carry traffic at 12.8 kbit/s.
$N_{9.6}$	Number of QBs that carry traffic at 9.6 kbit/s.
P_V	Pointer to the voice list.
I_1	Intermediate variable for the calculation of $N_{9.6}$.

8.3.3 VBR not required

When $N_V = N_{QB}$, all the BCs in the voice list are normal range BCs and no VBR is required. All BCs are carried at 16 kbit/s. Each QB of the QB list carries traffic from the BC which has the same ordering number as that QB.

8.3.4 VBR required

If N_V is greater than N_{QB} , VBR is required to create the additional overload channels³. In this case, there are more BCs than QBs and there is not always an association between BCs and QBs of the same number. The values of N_{16} , $N_{12.8}$ and $N_{9.6}$ are calculated to determine how many QBs of the QB list will be used to carry traffic at each rate. These values are determined according to the following criteria:

- Maximize instantaneous average bit rate of the traffic while using available bearer resources.
- Create enough channels for all BCs in the voice list.
- Minimize the number of 9.6 kbit/s channels.

The formal representation of these criteria is:

- $\max\left(16 \times N_{16} + 12.8 \times \frac{5}{4} N_{12.8} + 9.6 \times \frac{5}{3} N_{9.6}\right)$
- $N_{16} + \frac{5}{4} N_{12.8} + \frac{5}{3} N_{9.6} \geq N_V$
- $\min(N_{9.6})$

³ The maximum number of channels that can be created using N_{QB} QBs is $5 \times \text{int}\left(\frac{1}{3} N_{QB}\right) + N_{QB} \bmod 3$.

These criteria lead to the following rules used to uniquely determine the values of N_{16} , $N_{12.8}$ and $N_{9.6}$ (see derivations in Supplement 38 to G-series):

- a) If N_{QB} is a multiplier of 3 and also $N_V = \frac{5}{3}N_{QB} - 1$, then adjust N_V by adding 1 to its value and by that create an extra dummy BC that will be virtually inserted to the voice list as entry number $P_V - 1$ (following is the calculation of P_V) so it will be carried at 9.6 kbit/s.
- b) Set I_1 to $\frac{4}{5}N_V - N_{QB}$. If I_1 is smaller than zero, then set it to zero.
- c) If I_1 is not an integer, then add 1 to its value.
- d) Set $N_{9.6}$ to $3 \times \text{int}(I_1)$
- e) Set $N_{12.8}$ to $4 \left(N_V - N_{QB} - \frac{2}{3}N_{9.6} \right)$
- f) Set N_{16} to $N_{QB} - N_{12.8} - N_{9.6}$

These rules assure compliance with the above-mentioned criteria.

Next step is to assign BCs to QBs in a manner that will not discriminate BCs from a sampling rate point of view so that bit stealing will be uniformly randomly distributed in order to obtain similar average quality of all serviced ITs.

A pointer P_V shall be calculated as:

$$P_V = (BC' + IT) \bmod N_V$$

where BC' and IT are extracted from the last assignment message (when in double AM mode BC' and IT shall be extracted from the first assignment message of the two).

BC' is the number represented by the nine bits that constitute the BC type and BC number.

If USM is used and the frame is a signalling frame, then $IT1$ shall be used instead of BC' and $IT2$ shall be used instead of IT .

The first N_{16} QBs of the QB list shall carry traffic from BCs number P_V through $P_V + N_{16} - 1$ (inclusive) of the voice list at 16 kbit/s, so that each QB shall carry traffic from one BC. The next

$N_{12.8}$ QBs shall carry traffic from the next $\frac{5}{4}N_{12.8}$ BCs at 12.8 kbit/s, so that every 4 consecutive QBs of the QB list will carry traffic from 5 consecutive BCs of the voice list. The rest $N_{9.6}$ QBs shall

carry traffic from the rest $\frac{5}{3}N_{9.6}$ BCs at 9.6 kbit/s, so that every 3 consecutive QBs of the QB list will carry traffic from 5 consecutive BCs of the voice list. Reference to the lists shall be done in a cyclic way, e.g. entry number one of the voice list follows entry number N_V .

The VBR scheme is demonstrated in Figure 7.

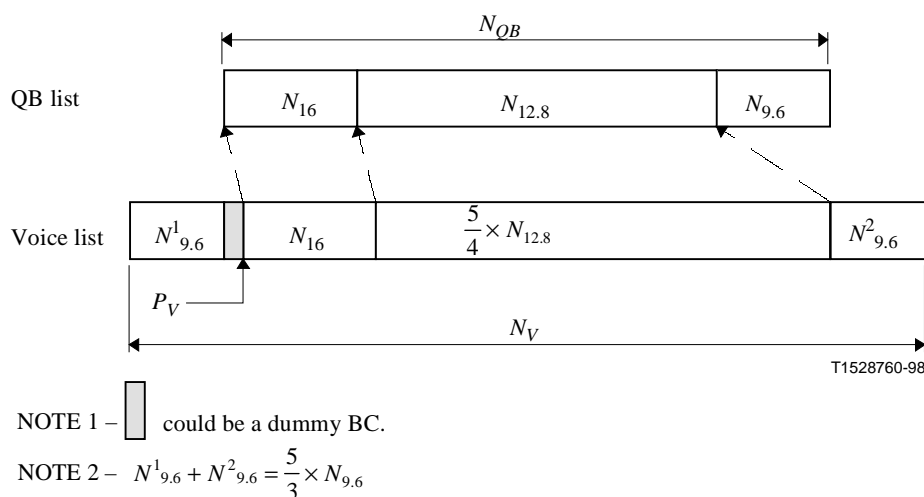

Figure 7/G.767 – VBR scheme

9 ABPS calculations

For the purpose of DLC calculations and thresholds and performance statistic, given an ADPCM bit per sample measure, its equivalent LD-CELP measure is:

$$B_L = 0.4 \times (B_A + 1)$$

where B_L is the LD-CELP bit per sample measure and B_A is the ADPCM bit per sample measure. For example, the LD-CELP equivalent of an ADPCM ABPS of 3.7 bits/sample is $0.4 \times (3.7 + 1) = 1.88$ bits/sample.

10 Channel check procedure

A means of verifying end-to-end continuity and correct assignment of channels similar to the procedure described in Recommendation G.763 shall be provided.

The use of the control channel for conveying channel check messages is the same as specified in Recommendation G.763.

Details of the test procedure are for further study.

11 Facsimile demodulation/remodulation

11.1 General

Fax demodulation in the 16 kbit/s DCME is performed as defined in Recommendation G.766 with the proper modifications resulting from the fact that the DCME frame is 2.5 ms, as described hereafter.

11.2 Facsimile blocks, facsimile transport channels and fax banks

One fax bank occupies two QBs, i.e. 80 bits per DCME frame (4 bits \times 20 PCM frames). Facsimile blocks and facsimile transport channels occupy 40 bits each. All G.766 schemes for bit mapping from FDCs to fax blocks to FTCs to fax banks remain unchanged except for the trivial transition from 64 and 32 bits to 80 and 40 respectively (see Figures 8 and 9).

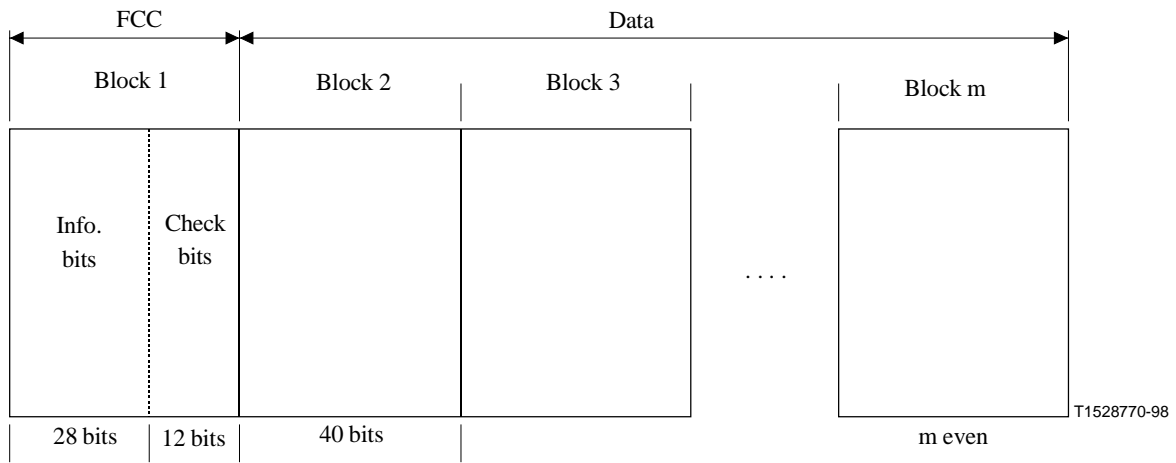

Figure 8/G.767 – Facsimile blocks

11.3 Facsimile data channel

The demodulated data obtained from each trunk channel carrying a facsimile call is accumulated for a period of one DCME frame. The same stuffing scheme as in Recommendation G.766 is maintained with new values for demodulated bits per DCME frame for each facsimile transmission rate and, resulting from that, a new FDC length per rate, as shown in Table 8.

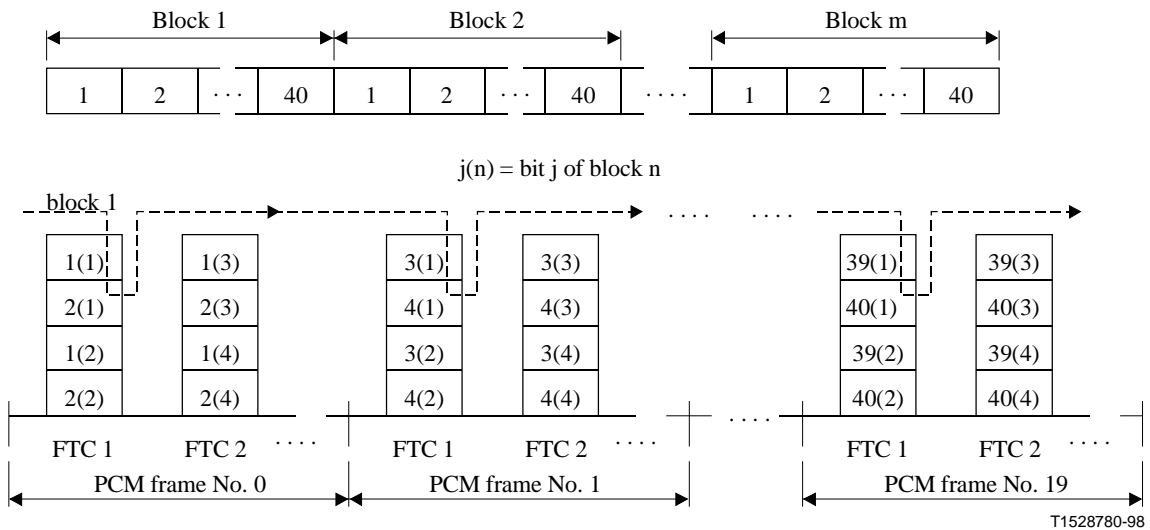

Figure 9/G.767 – Facsimile transport channels

Table 8/G.767 – Facsimile data channel length

Facsimile transmission rate (kbit/s)	Nominal No. of bits in DCME frame	FDC length (bits)
R (Note 1)	$I(2.5 \times R)$	$I(2.5 \times R) + 2$
33.6	84	86
31.2	78	80
28.8	72	74
26.4	66	68
24	60	62
21.6	54	56
19.2	48	50
16.8	42	44
14.4	36	38
12.0	30	32
9.6	24	26
7.2	18	20
4.8	12	14
2.4	6	8
0.3 (Note 2)	1	6

NOTE 1 – The same notations as in Recommendation G.766 are used.
 NOTE 2 – The same FDC structure for V.21 as in G.766 is used.

11.4 Facsimile control channel and forward error correction

Maintaining the same scheme used in Recommendation G.766, where the FCC occupies one facsimile block, the FCC of the 16 kbit/s DCME is 40 bits long holding 9 bits for IT field and 12 bits for message field plus 7 dummy bits and 12 check bits (see Figure 10). The same structure of the FCC is maintained, so only 12 (MSB) bits out of the 14 of the message field are used and the 2 remaining LSB bits are reserved for future provisions.

The error correction code is BCH(63,51) which maintains the properties of BCH(31,21) used in Recommendation G.766, i.e. a double error correcting code with a minimum distance of 5. When FEC is ON, the facsimile data channels are divided into blocks of 28 consecutive bits each and 12 check bits are applied to each block. Since the code is capable of protecting 51 bits by adding 12 check bits and here it is required to protect only 28 bits, it is assumed that the 23 unused most significant bits of data are all zero at both Tx and Rx side, as shown in Figure 11.

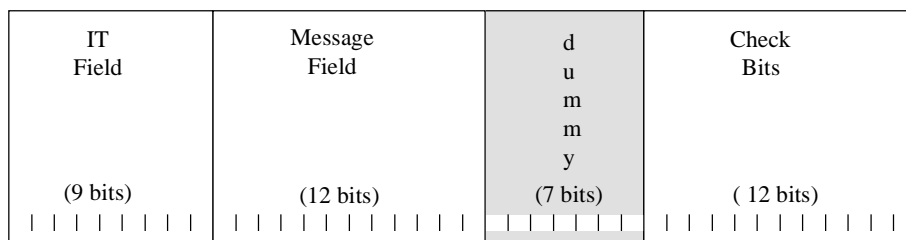

T1530490-99

Figure 10/G.767 – Facsimile control channel

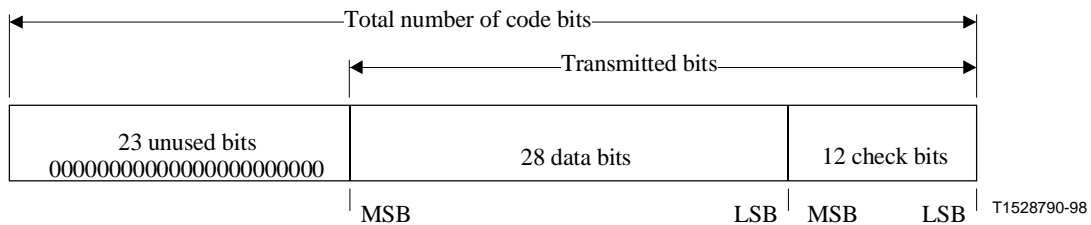

Figure 11/G.767 – Structure of BCH(63,51) code for 28 data bits

11.5 FCC location on the bearer

The FCC occupies QBs number 1 and 2 in single AM mode and QBs number 3 and 4 in double AM mode, as shown in Figures 12 and 13 respectively. In double AM mode, QB #2 can be used to carry voice.

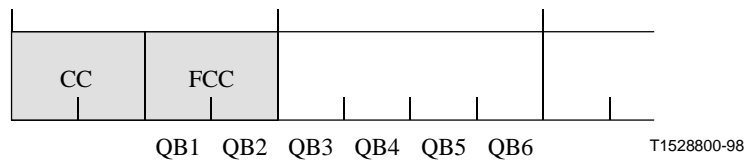

Figure 12/G.767 – FCC location in single AM mode

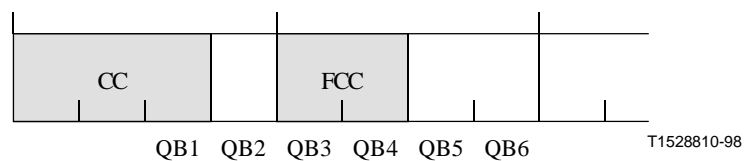

Figure 13/G.767 – FCC location in double AM mode

12 System statistics measurement

System statistics measurements in the 16 kbit/s DCME shall be performed in the same manner as defined in 15.2.3/G.763 (1998), with the modification that the Statistic Test Interval (STI) is in the range of 10 to 60 minutes (in 5 minutes steps).

ITU-T RECOMMENDATIONS SERIES

- Series A Organization of the work of the ITU-T
- Series B Means of expression: definitions, symbols, classification
- Series C General telecommunication statistics
- Series D General tariff principles
- Series E Overall network operation, telephone service, service operation and human factors
- Series F Non-telephone telecommunication services
- Series G Transmission systems and media, digital systems and networks**
- Series H Audiovisual and multimedia systems
- Series I Integrated services digital network
- Series J Transmission of television, sound programme and other multimedia signals
- Series K Protection against interference
- Series L Construction, installation and protection of cables and other elements of outside plant
- Series M TMN and network maintenance: international transmission systems, telephone circuits, telegraphy, facsimile and leased circuits
- Series N Maintenance: international sound programme and television transmission circuits
- Series O Specifications of measuring equipment
- Series P Telephone transmission quality, telephone installations, local line networks
- Series Q Switching and signalling
- Series R Telegraph transmission
- Series S Telegraph services terminal equipment
- Series T Terminals for telematic services
- Series U Telegraph switching
- Series V Data communication over the telephone network
- Series X Data networks and open system communications
- Series Y Global information infrastructure
- Series Z Programming languages