



INTERNATIONAL TELECOMMUNICATION UNION

ITU-T

TELECOMMUNICATION
STANDARDIZATION SECTOR
OF ITU

G.766

(11/96)

SERIES G: TRANSMISSION SYSTEMS AND MEDIA

Digital transmission systems – Terminal equipments –
Principal characteristics of transcoder and digital
multiplication equipment

**Facsimile demodulation/remodulation for
digital circuit multiplication equipment**

ITU-T Recommendation G.766

(Previously CCITT Recommendation)

ITU-T G-SERIES RECOMMENDATIONS
TRANSMISSION SYSTEMS AND MEDIA

INTERNATIONAL TELEPHONE CONNECTIONS AND CIRCUITS	G.100–G.199
INTERNATIONAL ANALOGUE CARRIER SYSTEM	
GENERAL CHARACTERISTICS COMMON TO ALL ANALOGUE CARRIER-TRANSMISSION SYSTEMS	G.200–G.299
INDIVIDUAL CHARACTERISTICS OF INTERNATIONAL CARRIER TELEPHONE SYSTEMS ON METALLIC LINES	G.300–G.399
GENERAL CHARACTERISTICS OF INTERNATIONAL CARRIER TELEPHONE SYSTEMS ON RADIO-RELAY OR SATELLITE LINKS AND INTERCONNECTION WITH METALLIC LINES	G.400–G.449
COORDINATION OF RADIOTELEPHONY AND LINE TELEPHONY	G.450–G.499
TRANSMISSION MEDIA CHARACTERISTICS	
DIGITAL TRANSMISSION SYSTEMS	
TERMINAL EQUIPMENTS	G.700–G.799
General	G.700–G.709
Coding of analogue signals by pulse code modulation	G.710–G.719
Coding of analogue signals by methods other than PCM	G.720–G.729
Principal characteristics of primary multiplex equipment	G.730–G.739
Principal characteristics of second order multiplex equipment	G.740–G.749
Principal characteristics of higher order multiplex equipment	G.750–G.759
Principal characteristics of transcoder and digital multiplication equipment	G.760–G.769
Operations, administration and maintenance features of transmission equipment	G.770–G.779
Principal characteristics of multiplexing equipment for the synchronous digital hierarchy	G.780–G.789
Other terminal equipment	G.790–G.799
DIGITAL NETWORKS	G.800–G.899
General aspects	G.800–G.809
Design objectives for digital networks	G.810–G.819
Quality and availability targets	G.820–G.829
Network capabilities and functions	G.830–G.839
SDH network characteristics	G.840–G.899
DIGITAL SECTIONS AND DIGITAL LINE SYSTEM	G.900–G.999
General	G.900–G.909
Parameters for optical fibre cable systems	G.910–G.919
Digital sections at hierarchical bit rates based on a bit rate of 2048 kbit/s	G.920–G.929
Digital line transmission systems on cable at non-hierarchical bit rates	G.930–G.939
Digital line systems provided by FDM transmission bearers	G.940–G.949
Digital line systems	G.950–G.959
Digital section and digital transmission systems for customer access to ISDN	G.960–G.969
Optical fibre submarine cable systems	G.970–G.979
Optical line systems for local and access networks	G.980–G.999

For further details, please refer to ITU-T List of Recommendations.

ITU-T RECOMMENDATION G.766

FACSIMILE DEMODULATION/REMODULATION FOR DIGITAL CIRCUIT MULTIPLICATION EQUIPMENT

Source

ITU-T Recommendation G.766 was revised by ITU-T Study Group 15 (1993-1996) and was approved under the WTSC Resolution No. 1 procedure on the 8th of November 1996.

FOREWORD

ITU (International Telecommunication Union) is the United Nations Specialized Agency in the field of telecommunications. The ITU Telecommunication Standardization Sector (ITU-T) is a permanent organ of the ITU. The ITU-T is responsible for studying technical, operating and tariff questions and issuing Recommendations on them with a view to standardizing telecommunications on a worldwide basis.

The World Telecommunication Standardization Conference (WTSC), which meets every four years, establishes the topics for study by the ITU-T Study Groups which, in their turn, produce Recommendations on these topics.

The approval of Recommendations by the Members of the ITU-T is covered by the procedure laid down in WTSC Resolution No. 1.

In some areas of information technology which fall within ITU-T's purview, the necessary standards are prepared on a collaborative basis with ISO and IEC.

NOTE

In this Recommendation, the expression "Administration" is used for conciseness to indicate both a telecommunication administration and a recognized operating agency.

INTELLECTUAL PROPERTY RIGHTS

The ITU draws attention to the possibility that the practice or implementation of this Recommendation may involve the use of a claimed Intellectual Property Right. The ITU takes no position concerning the evidence, validity or applicability of claimed Intellectual Property Rights, whether asserted by ITU members or others outside of the Recommendation development process.

As of the date of approval of this Recommendation, the ITU had/had not received notice of intellectual property, protected by patents, which may be required to implement this Recommendation. However, implementors are cautioned that this may not represent the latest information and are therefore strongly urged to consult the TSB patent database.

© ITU 1997

All rights reserved. No part of this publication may be reproduced or utilized in any form or by any means, electronic or mechanical, including photocopying and microfilm, without permission in writing from the ITU.

CONTENTS

	Page
1	General..... 1
1.1	Abbreviations..... 1
2	Definitions of facsimile demodulation/remodulation in DCME 3
3	Functions of the facsimile module..... 3
4	Facsimile module structure..... 5
5	Facsimile frame assembler/disassembler blocks 7
5.1	Facsimile data channel..... 7
5.2	Facsimile module frame..... 9
5.2.1	Facsimile control channel..... 10
5.3	Facsimile blocks 11
5.3.1	FEC encoding 11
5.4	Facsimile transport channels..... 11
6	Facsimile module controller 13
6.1	Common control function..... 13
6.1.1	Communication with the ADF 14
6.1.2	Other communication functions 14
6.1.3	Capacity management..... 14
6.1.4	FCH management..... 15
6.1.5	Demodulator/remodulator pool management..... 15
6.2	Facsimile Channel Handler (FCH)..... 15
6.2.1	FCH requirements..... 17
6.2.2	FCH protocol..... 17
7	Use of the facsimile control channel..... 24
7.1	Message field structure 24
7.2	Message transmission procedure 29
7.3	Service channel..... 30
8	Timing and delay requirements..... 30
8.1	Clock difference compensation..... 30
8.1.1	Demodulator side..... 30
8.1.2	Remodulator side..... 31
8.2	Critical time gaps of the T.30 signals 31
8.2.1	Demodulator side requirements..... 31
8.2.2	Remodulator side requirements..... 31

	Page
8.3 Front-End Delay (FED) buffer.....	32
9 Multi-clique and multi-destination operation	32
10 Facsimile module operation and maintenance.....	32
10.1 Facsimile module statistics	32
10.2 Facsimile module configuration data.....	34
10.3 Error count	34
10.4 FEC activation	34
11 Required DCME modifications	35
11.1 Facsimile data handling	35
11.2 Changes in the DCME processes.....	35
Annex A – Examples of FCH protocol exchanges	36
A.1 SF-T.30 cases with matched capabilities.....	36
A.2 NSF-T.30 proprietary cases with matched capabilities.....	55
A.3 SF-T.30 cases with unmatched capabilities.....	58
A.4 NSF-T.30 proprietary cases with unmatched capabilities.....	62
Annex B – Formal description of the facsimile module controller.....	64
B.1 Introduction.....	64
B.2 FMC interfaces.....	64
B.3 Internal structure of the FMC.....	70
B.4 Common control function (CCF).....	72
B.5 FCH.....	73
Supplement No. 1 – Dimensioning example for facsimile compression.....	100
S.1 Introduction.....	100
S.2 Assumptions.....	100
S.3 Method.....	100

Recommendation G.766

FACSIMILE DEMODULATION/REMODULATION FOR DIGITAL CIRCUIT MULTIPLICATION EQUIPMENT

(revised in 1996)

1 General

This Recommendation for a Digital Circuit Multiplication Equipment (DCME) facsimile module is intended to be as flexible as possible in an open-network environment, while providing manufacturers of equipment the license to invent, whilst maintaining equipment interoperability. Use of the facsimile module provides a solution to the DCME traffic loading problem created by the rapid growth of facsimile traffic, which is transmitted via DCME using 40 kbit/s Adaptive Differential Pulse Code Modulation (ADPCM) encoding, that rapidly depletes DCME bearer capacity resulting in reduced speech quality.

The facsimile module (see Figure 1) is a functional unit which permits adding the facsimile compression feature to the DCME. The basic function of the facsimile module is to detect facsimile calls, demodulate the facsimile signals and transmit the demodulated data to the remote facsimile module via the DCME. At the remote facsimile module, the voiceband signal is reconstructed to its original format for transmission to the local terminal equipment. Calls which cannot be demodulated are routed through the G.726 40 kbit/s ADPCM channels of the DCME.

It is recognized that Group 3 facsimile demodulation/remodulation is only the first feature of a series of voiceband data demodulation/remodulation capabilities which will in all likelihood be extended to the next generation of voiceband data modems operating at bit rates greater than 9600 bit/s. It is anticipated that the modulation schemes for high speed modems will also be incorporated into facsimile machines and such traffic, when presented to DCMEs, must be accommodated. The design of the DCME facsimile module has been structured to carry demodulated data at bit rates up to 24 kbit/s to permit future flexibility. The DCME facsimile module is fully compatible with all of the operating modes of Recommendation G.763 which includes, point-to-point, multi-clique and multi-destination operating modes.

Careful consideration has been given to error protection. The Forward Error Correction (FEC) provided in the DCME facsimile module is robust against randomly distributed single bit errors. It also fully protects against errors as long as the error event is less than one frame of the primary multiplex multiframe or provided that only one error burst event occurs within a single DCME frame (2 ms).

There have been two approaches integrated into the DCME facsimile module, a Protocol Analysis (PA) approach and a Waveform Analysis (WA) approach. In order to retain the interoperability objective, compromises were introduced which slightly increased the equipment complexity. If one were to consider only a PA approach or only a WA approach, some simplification would be possible. However, such simplification is not recommended as the open-network interoperability would then be lost.

1.1 Abbreviations

This Recommendation uses the following abbreviations:

ADF ADPCM/DSI Function
ADPCM Adaptive Differential Pulse Code Modulation

BC	Bearer Channel
CCF	Common Control Function
CRC	Cyclic Redundancy Check
DCME	Digital Circuit Multiplication Equipment
DCN	Disconnect
DCOA	Digital Channel Occupancy Analyser
DCS	Digital Command Signal
DIS	Digital Identification Signal
DSI	Digital Speech Interpolation
DTC	Digital Transmit Command
EOM	End of Message
EOP	End of Procedure
EPT	Echo Protection Tone
FA	Frame Assembler
FCC	Facsimile Control Channel
FCH	Facsimile Channel Handler
FCM	Facsimile Compression Module
FD	Frame Disassembler
FDC	Facsimile Data Channel
FEC	Forward Error Correction
FED	Front-End Delay
FMC	Facsimile Module Controller
FSTI	Facsimile Statistical Time Interval
FTC	Facsimile Transport Channel
HDLC	High level Data Link Control
HSC	Hangover control and Signal Classification
IT	Intermediate Trunk
LRE	Low Rate Encoding
NSF-T.30	Non-Standard Facility-T.30
NSS	Non-Standard Set-up
O&M	Operation and Maintenance
PA	Protocol Analysis
RAG	Resource management and Assignment Generation
Rx	Receive
RUD	Receive channel status Update and overload channel Decoding
SDL	Specification and Description Language
SF-T.30	Standard Facility-T.30
Tx	Transmit
WA	Waveform Analysis

2 Definitions of facsimile demodulation/remodulation in DCME

This Recommendation defines the following terms:

2.1 facsimile module: A functional unit performing the demodulation/remodulation of the facsimile signal and transmission/reception of control codes and demodulated image information via the associated ADPCM/DSI function of the DCME.

2.2 ADPCM/DSI function (ADF): The ADPCM/DSI Function (ADF) of the DCME encompasses all the traffic handling functions specified in Recommendation G.763.

2.3 facsimile control channel (FCC): An unidirectional 32-bit channel (21 information bits, 10 parity bits and 1 dummy bit) used between the transmit unit of one facsimile module to the receive unit of one or more associated facsimile modules which is dedicated primarily to carrying channel assignment messages and control messages.

2.4 facsimile data channel (FDC): A variable length data block containing bits of the demodulated image information or procedural signals, accumulated over a period of 2 ms from one intermediate trunk (IT) (see 2.10/G.763), and clock alignment overhead bits.

2.5 facsimile module frame: A bit sequence consisting of the FDCs ordered by ascending IT number. The sequence starts with the facsimile control channel.

2.6 facsimile block: This is a 32-bit block consisting of either 32 contiguous bits of the facsimile module frame or 21 contiguous bits of the frame FEC encoded with the addition of 10 parity bits and 1 dummy bit.

2.7 facsimile transport channel (FTC): A 32-kbit/s channel that carries a facsimile block from/to the facsimile module to/from the ADF where the facsimile block is placed into/removed (from) a 32-kbit/s bearer channel (see 2.8/G.763).

2.8 facsimile compression: The real time process of demodulating the facsimile signal to its basic digital rate for transparent transmission and subsequent remodulation at the remote end of the DCME link.

2.9 facsimile data interface: The functional interface which permits the transfer of FTC information between the facsimile module and the ADF.

3 Functions of the facsimile module

The facsimile module (see Figure 1) is a functional unit which permits adding the facsimile compression feature to the DCME. The basic function of the facsimile module is to detect facsimile calls, demodulate the facsimile signals and transmit demodulated data to the remote facsimile module via the DCME bearer. At the remote facsimile module, the voiceband signal is reconstructed to its original format for transmission to the local terminal equipment. Calls which cannot be demodulated are routed through the G.726 40 kbit/s ADPCM channels of the ADF specified in Recommendation G.763.

The requirements for the facsimile compression function are listed in Table 1.

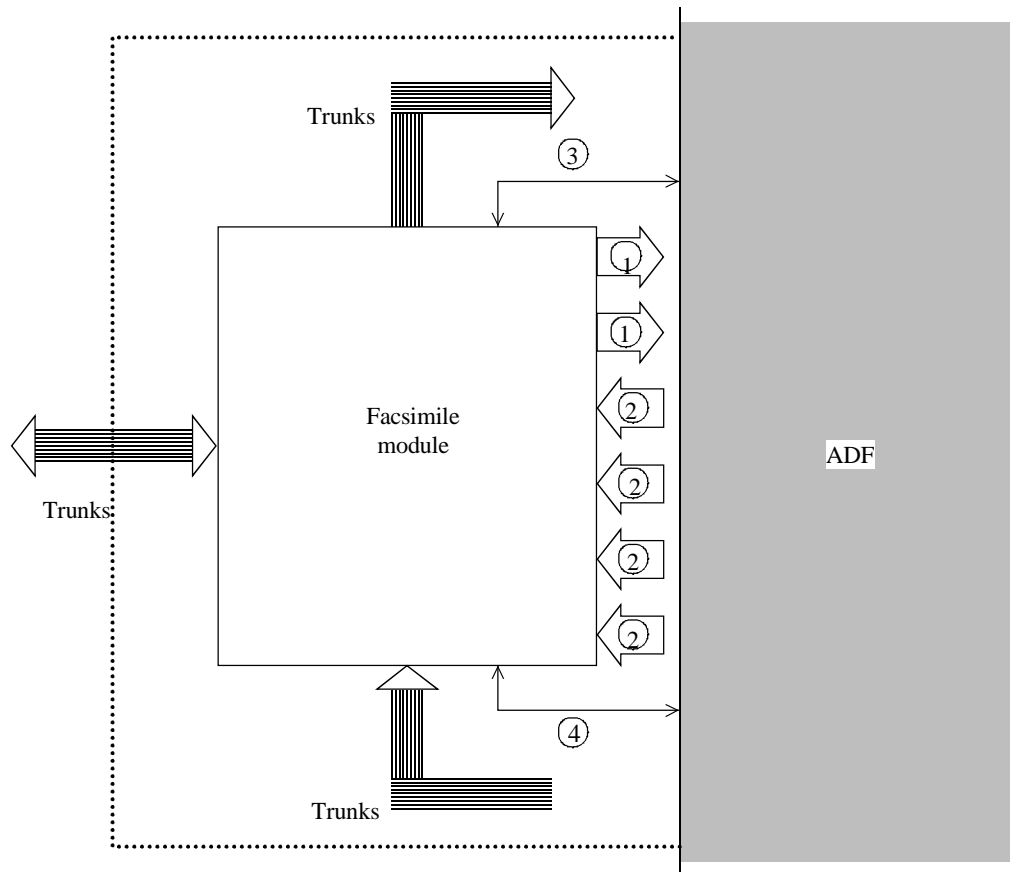

T1522170-96

ADF ADPCM/DSI Function

- ① Transmit fax data interface
- ② Receive fax data interface
- ③ Fax control interface
- ④ Fax O&M interface

Figure 1/G.766 – Facsimile module – System concept

Table 1/G.766 – Facsimile compression requirements

Facsimile calls compressed	CCITT G3 fax as per T.30 and T.4 standard facilities; optionally, T.30 non-standard facilities
Facsimile calls non-compressed (handled by 40 kbit/s ADPCM)	CCITT G1 and G2, some or all non-standard facilities T.30 schemes
Image data rate modulation schemes and rates (Note 1)	V.33 (14 400, 12 000, 9600, 7200 bit/s); V.17 (14 400, 12 000, 9600, 7200 bit/s); V.29 (9600, 7200 bit/s); V.27 <i>ter</i> (4800, 2400 bit/s)
Control signals demodulated (Note 1)	V.21 (300 bit/s)
Remodulated signal level (Note 2)	Demodulator input level processed via 16-level quantizer
Facsimile terminal type	Automatic and manual
Compression deactivation	Possible on selected circuits
DCME operation supported	Single destination, multi-clique and multi-destination operation
NOTE 1 – The support of other modulation schemes is for further study.	
NOTE 2 – See 7.1 for the quantizer levels.	

4 Facsimile module structure

The facsimile module may be external or internal to the DCME depending on the implementation. For purposes of illustration the functional representation of the system concept assumes the facsimile module is external to the DCME. However, an equivalent architecture can be based on an implementation with the facsimile module internal to the DCME. The facsimile module system concept is illustrated in Figure 1. The figure shows functional interfaces between the facsimile module and the ADF, namely the facsimile data interface, the facsimile control interface, and the facsimile Operation and Maintenance (O&M) interface.

The facsimile data interface is a communication channel which permits the transfer of facsimile image data and auxiliary information between the facsimile module and the DCME. There is one transmit and one receive data interface in single destination operation, two transmit and two receive interfaces in multi-clique operation and one transmit and up to four receive interfaces in multi-destination operation.

The facsimile control interface carries status and control data for the module interaction with the DCME. The O&M interface is used for the exchange of O&M data with the operation and maintenance subsystem of the DCME or DCME cluster.

Figure 2 shows the internal structure of the facsimile module. The representation in Figure 2 is only functional and could be replaced by equivalent architectures. The structure in Figure 2 is compatible with two different design approaches for the facsimile compression feature. The first approach, called the Protocol Analysis (PA) approach, is based on decoding and interpreting the procedural signals exchanged between the facsimile terminals. A minimum amount of signal analysis, such as activity detection and low/high speed discrimination, is also performed in this approach. The second approach, called the Waveform Analysis (WA) approach, is based on analysis and classification of

the modulated waveforms transmitted by the facsimile terminals. This subject is addressed in more detail in 6.2.

The structure in Figure 2 contains the following blocks:

- a) demodulator/analysis block;
- b) front-end delay buffer;
- c) facsimile frame assembler and disassembler blocks;
- d) remodulator block;
- e) facsimile module controller.

The demodulator/analysis block performs signal analysis (WA approach) and demodulates the image data and the low speed procedural signals of the facsimile call. The front-end delay buffer is used to provide sufficient time for signal validation (PA) or analysis (WA). In the PA approach, the contents of the procedural messages are provided to the facsimile module controller. Both the high speed and low speed demodulated data are provided to the facsimile Frame Assembler (FA) for transmission over the facsimile data interface to the ADF. The facsimile Frame Disassembler (FD) extracts the demodulated data from the facsimile frame received from the DCME and passes it to the remodulator block for transmission to the facsimile terminal.

The Facsimile Module Controller (FMC) is the process that oversees the operation of the entire facsimile module and its interaction with the DCME and the corresponding facsimile module(s).

The functions of the various blocks are specified in the following clauses.

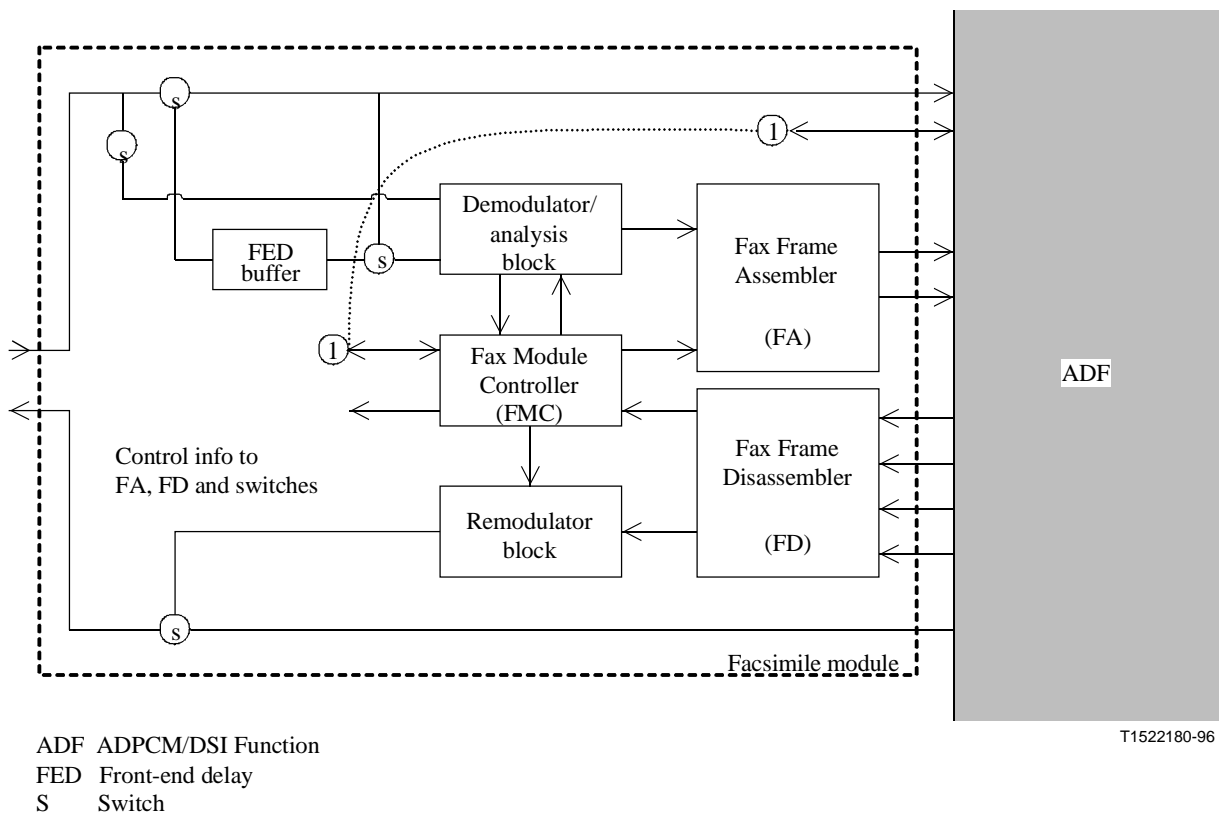

Figure 2/G.766 – Facsimile module structure

5 Facsimile frame assembler/disassembler blocks

The data formatted by the FA for transmission over the facsimile data interface can be represented as multiple 32-kbit/s channels. However, a number of building blocks must be defined. These are the Facsimile Data Channel (FDC), carrying the demodulated facsimile data of one intermediate trunk (IT) (see 2.10/G.763), the facsimile module frame, where the FDCs are grouped in ascending IT order, the facsimile block, consisting of a block of 32 contiguous bits of the facsimile module frame, and the Facsimile Transport Channel (FTC), a 32-kbit/s channel that provides the facsimile block information, suitably mapped, to the ADF for insertion into the DCME bearer frame.

An example is provided below in order to illustrate how the demodulated facsimile data is structured for transmission over the DCME bearer. Assume the case where two facsimile calls, both originating at the near end of the DCME link, are being handled by the facsimile module. For both calls, image data is being transmitted at 9.6 kbit/s.

The demodulated image data of each facsimile call is accumulated for 2 ms before transmission. This corresponds to 21 bits (see 5.1). If the FEC option is used, 10 parity bits and 1 dummy bit are added to the data bits, for a total of 32 bits. This is a facsimile block. At the end of a 2-ms period there will be two facsimile blocks plus one additional 32-bit block, used for control. The three blocks are arranged in an ordered structure (facsimile frame), where the control block is first, and the two image data blocks follow, ordered by ascending trunk number. A total of 96 bits need to be transmitted over the next 2-ms time interval. This is achieved by allocating two 4-bit slots (fax banks) in the 2048 kbit/s DCME bearer. Each 4-bit channel has a capacity of 32 kbit/s; therefore, 128 bits can be transported over a 2-ms period. Two bits of a fax bank are mapped to two bits of one block and the other two bits are mapped to 2 bits of the next block in the frame (see Figure 7). Dummy bits are inserted when there are no more facsimile frame bits to be transported. In this example, fax bank No. 1 will transport facsimile block No. 1 (the control block) and facsimile block No. 2. Fax bank No. 2 will transport facsimile block No. 3 and 32 dummy bits.

5.1 Facsimile data channel

The demodulated data obtained from each trunk carrying a facsimile call is accumulated for a period of 2 ms (coincident with the DCME frame). Depending on the data rate, the number of bits in 2 ms may be a non-integer number. In order to compensate for this and also for timing differences between the facsimile signal clock and the facsimile frame clock (slaved to the DCME clock), one or two stuffing bits and a control bit are used. Two stuffing bits are used, instead of one, for those rates where the nominal number of data bits accumulated in 2 ms would be an integer number. The stuffing bit(s) may or may not be used in any given frame. If used, the control bit is set to 1. If not used, the control bit is set to 0. When the stuffing bits are not used, their positions are occupied by data bits. Error protection is added to the V.21 (300 baud) demodulated bits by repeating the FDC bits (1 control bit and 1 data/stuffing bit) three times. Majority logic decision is used for decoding. If it is required to transmit stuffing bits after the last V.21 signal bit in the FDC, the maximum allowed number of stuffing bits to be sent shall be 30. The resulting bit structures referred to as a Facsimile Data Channel (FDC) for the three cases above are shown in Figure 3.

As an example, the case of the 9.6 kbit/s data rate is discussed. In this case, the number of bits accumulated in a 2-ms interval is slightly in excess of 19, so that sometimes 19 and sometimes 20 data bits will be transmitted. The 20th bit of the FDC will therefore be either a dummy bit or a data bit. The 21st bit of the FDC, the control bit, will indicate which of the two cases applies.

As an additional example, the case of the 12 kbit/s data rate is discussed. In this case, the number of bits accumulated in a 2-ms interval would be theoretically 24, but, in practice, it will be somewhat more or less. Sometimes 23 bits and sometimes 25 bits will be transmitted and, therefore, the 24th bit

and the 25th bit of the FDC will be either dummy bits or data bits, as indicated by the control bit (the 26th bit of the FDC).

The number of bits in the FDC depends on the transmission rate of the facsimile signal. Table 2 provides the total number of bits of an FDC, for the different bit rates listed in Table 1 and considering the error protection scheme for V.21 signals (300 bit/s).

Table 2/G.766 – Facsimile data channel length

Facsimile transmission rate (kbit/s)	Nominal number of bits in DCME frame	FDC length (bits)
R	$I(2 \times R)$	$I(2 \times R) + 2$
14.4	28	30
12.0	24	26
9.6	19	21
7.2	14	16
4.8	9	11
2.4	4	6
0.3 (Note)	1	6

R Rate in kbit/s (new modems) where the maximum limit is anticipated to be in the range of 24 kbit/s.
I () Integer part of a number.
NOTE – Facsimile transmission rate of 0.3 kbit/s is a special case for which the formula does not apply.

FDC with 1 bit stuffing

1 bit is either data or a dummy bit as indicated by the control bit value

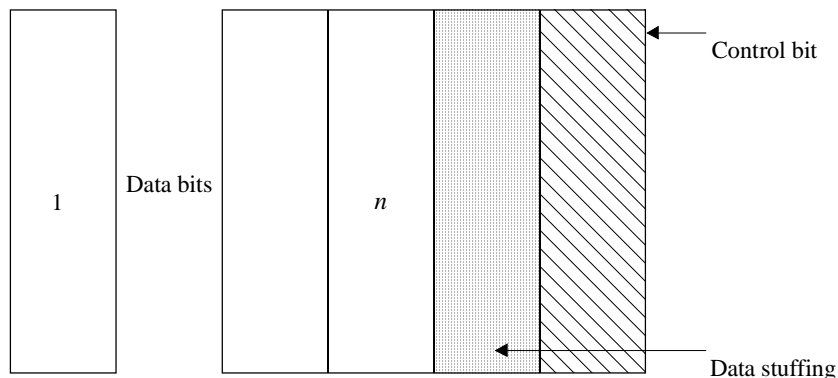

FDC with 2-bit stuffing

A pair of bits are either data or dummy bits as per the control bit value

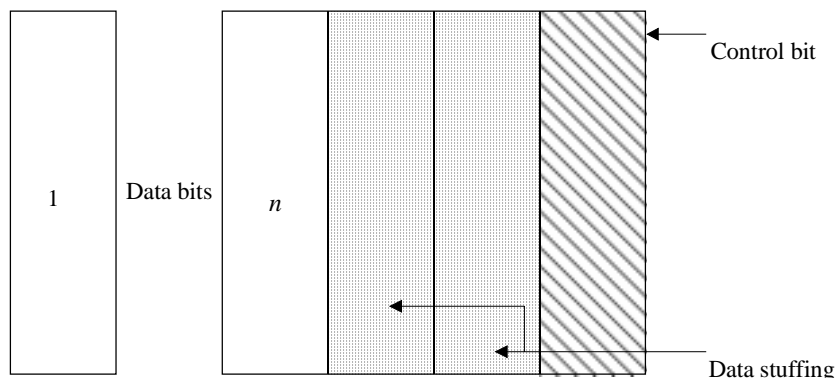

FDC for V.21 signals

1 data/dummy bit and 1 control bit are repeated 3 times for redundancy. Interleaving is provided at transmission (see 5.4).

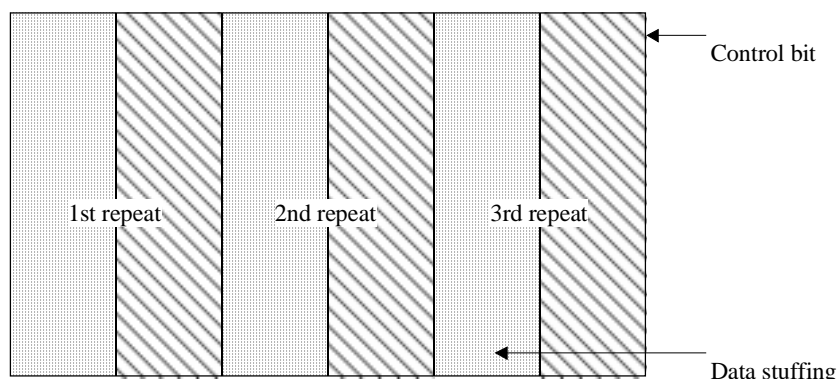

T1507170-92

Figure 3/G.766 – Facsimile data channel

5.2 Facsimile module frame

The FDCs of the various trunks are arranged in a contiguous sequence. Such a sequence, preceded by the Facsimile Control Channel (FCC), constitutes the facsimile module frame (see Figure 4). The FCC is a 21-bit block which, among other functions, describes the frame structure. The facsimile module frame is assembled every 2 ms, and its content may change from one 2-ms period to the next. The facsimile data associated with a specific IT can only be located in the frame by decoding the contents of the FCC.

FEC is always applied to the FCC. FEC may be optionally applied to the entire facsimile module frame in blocks of 21 consecutive bits. The application of FEC adds 11 additional bits to 21 data bits, changing a 21-bit block into a 32-bit block (see 5.1). The length of the facsimile module frame should be such that after the application of FEC (to the FCC only or to the entire frame depending on the option selected), an even integer number of 32 blocks is obtained. This may require that dummy bits be appended to the end of the frame, as shown in Figure 4. At most, 63 (31 + 32) dummy bits would be required to meet the above requirement. However, additional blocks of 32 dummy bits may be added to accommodate, without delay, a possible sudden traffic increase. The total number, m , of 32-bit blocks, determines the transmission capacity requirement (see 6.1.3).

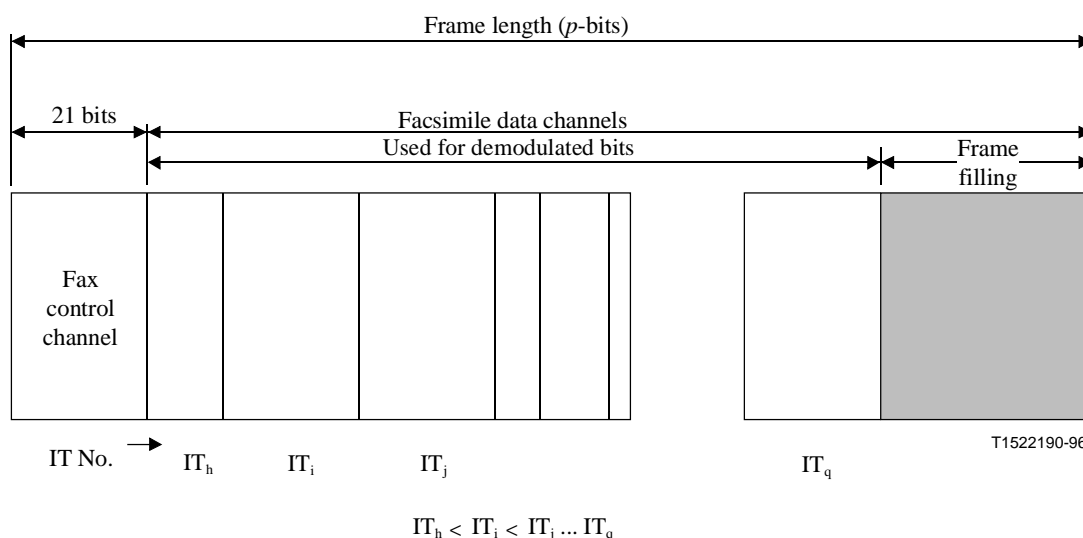
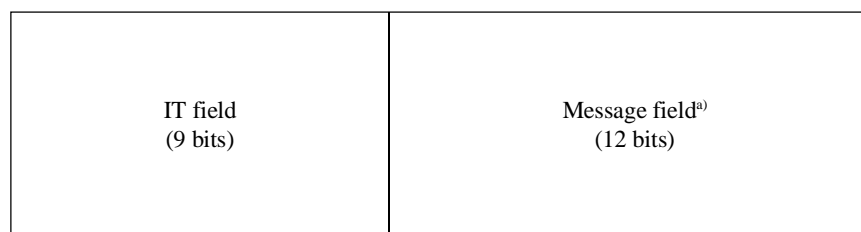

Figure 4/G.766 – Facsimile module frame

5.2.1 Facsimile control channel

The Facsimile Control Channel (FCC) is provided for the transmission of frame description messages, facsimile call control codes and auxiliary information. The structure of the FCC is shown in Figure 5. This 21-bit block is divided into two parts, namely the IT field (9 bits) and the message field (12 bits). The use of the FCC is addressed in clause 7.



^{a)} Message field structure specified in clause 7.

Figure 5/G.766 – Facsimile control channel

5.3 Facsimile blocks

A facsimile block is a 32-bit block, consisting of either:

- a) 21 contiguous bits of the facsimile module frame, with the addition of 10 FEC check bits and 1 dummy bit; or
- b) 32 contiguous bits of the facsimile module frame.

Cases a) or b), respectively apply when FEC is either used or not used. The first 21 bits of the facsimile module frame (i.e. the FCC) are always FEC encoded. The remaining part of the frame (i.e. the facsimile data) may be FEC encoded depending on the operator selection.

Regrouping the bits of the facsimile module frame in accordance with the definition of facsimile blocks, given above, results in the facsimile block structure illustrated in Figure 6. Note that, because of the considerations discussed in the previous clause, the number of facsimile blocks is m . The facsimile blocks are numbered, from 1 to m , with lower numbered blocks containing the facsimile data associated with the lower number ITs. The FCC is entirely contained in facsimile block 1.

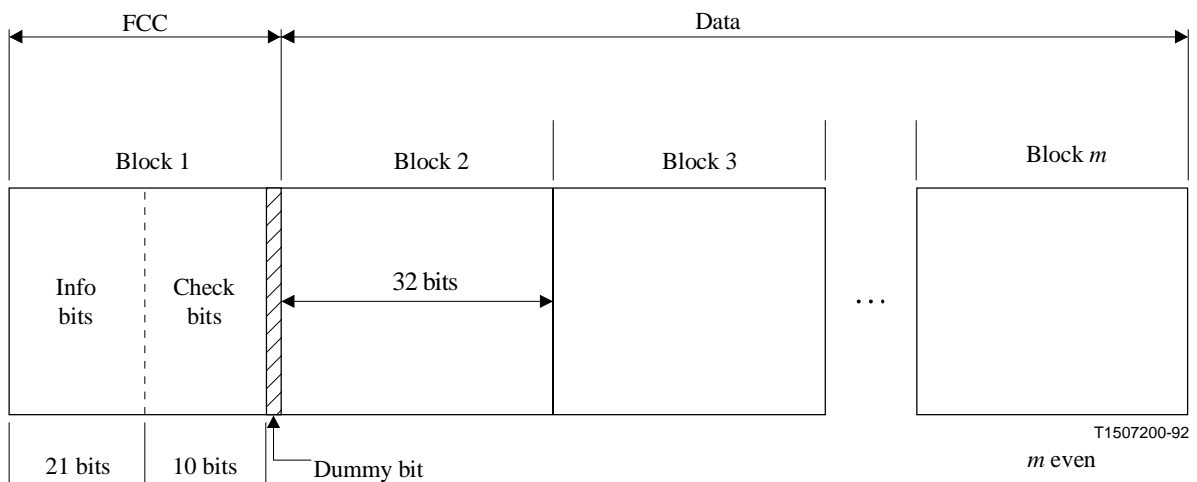

Figure 6/G.766 – Facsimile blocks

5.3.1 FEC encoding

The FEC encoding scheme uses a double error correcting BCH (Bose, Chaudhuri and Hocquengham) code of length 31, of minimum distance 5. The code is applicable to blocks of 21 information bits. The generator polynomial for this code is:

$$G(x) = 1 + x + x^2 + x^4 + x^5 + x^7 + x^{10}$$

5.4 Facsimile transport channels

To every DCME frame, the facsimile data interface delivers m facsimile blocks to the DCME. The facsimile blocks are transported by special 32-kbit/s channels defined as Facsimile Transport Channels (FTC). The procedure for mapping the facsimile blocks onto the FTCs is shown in Figure 7. The figure shows that the bits of a block are inserted in an FTC at the rate of 2 bits per PCM frame, so that, in 16 PCM frames (2 ms) all the bits of the block are transmitted. This interleaving of the two blocks on one FTC provides protection against burst error events which could affect all 4 bits of the FTC but only 2 bits in any one facsimile block.

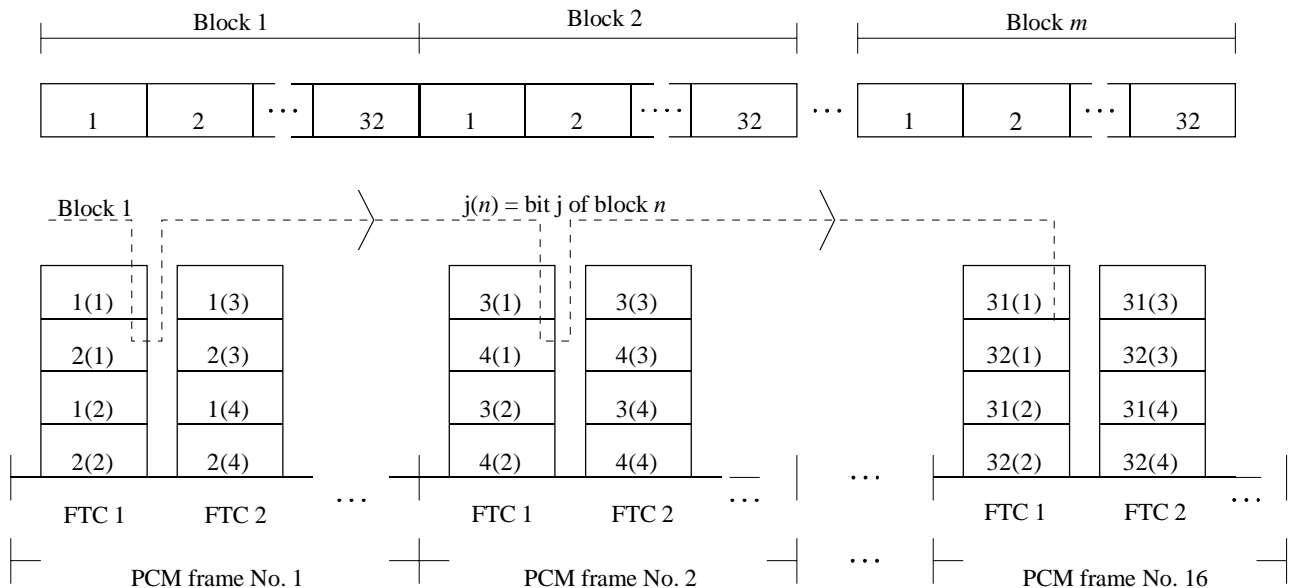

T1507210-92

Figure 7/G.766 – Facsimile transport channels

The FTC are numbered, FTC 1 transporting blocks 1 and 2, FTC 2 transporting block 3 and 4, etc. The number of FTCs required to transmit the m facsimile blocks is $m/2$, since each FTC can transport two blocks. Note that FTC 1 always carries the FCC. Note also that the FTCs are transported in the DCME bearer frame, by "fax banks" (see clause 11). FTC 1 is mapped to the first leftmost fax bank in the DCME bearer. FTC 2 is mapped to the second leftmost fax bank, etc. The last FTC is mapped to the rightmost fax bank (see Figure 8).

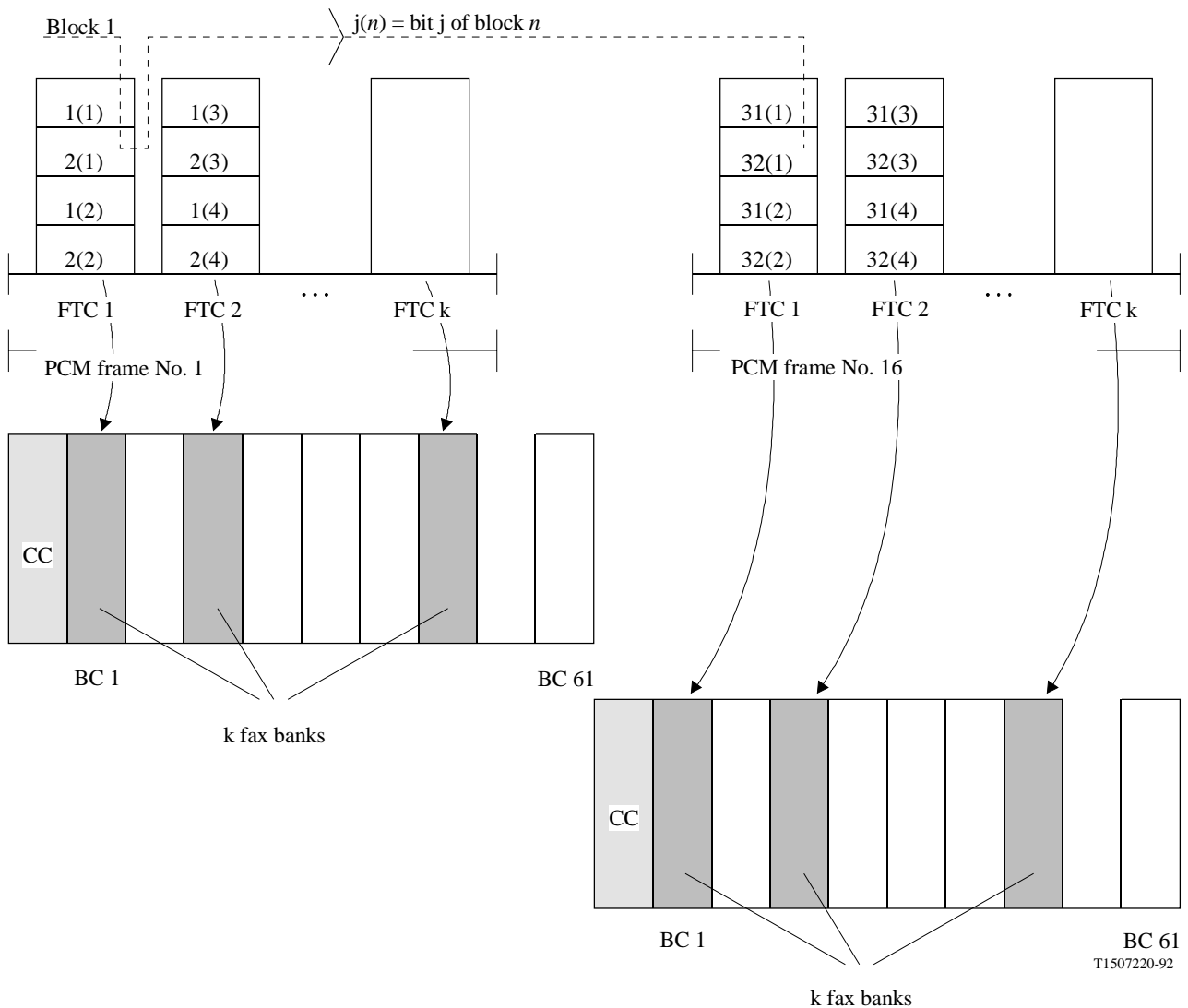

Figure 8/G.766 – Mapping of FTCs to fax banks

6 Facsimile module controller

The Facsimile Module Controller (FMC) performs a supervisory and control function for the entire module and acts as a gateway for all communication with the external environment. The FMC can be conceptually represented (see Figure 9), as the combination of a common outer process, called the Common Control Function (CCF), and an inner process, called the Facsimile Channel Handler (FCH). There are as many FCH processes as there are facsimile calls. A formal description of the FMC is provided in Annex B. There are as many CCF processes as there are cliques (see 2.27/G.763) handled by the DCME, i.e. one in single destination mode and two in multi-clique mode.

6.1 Common control function

The Common Control Function (CCF) performs a communication function and a resource management function. External communication is with the DCME, other facsimile module blocks, and with the remote facsimile module(s). The resources managed are module processes/hardware and capacity. A schematic representation of the CCF and the blocks it interacts with is shown in Figure 9. A complete definition of the signals exchanged among the blocks and the environment is provided in Annex B.

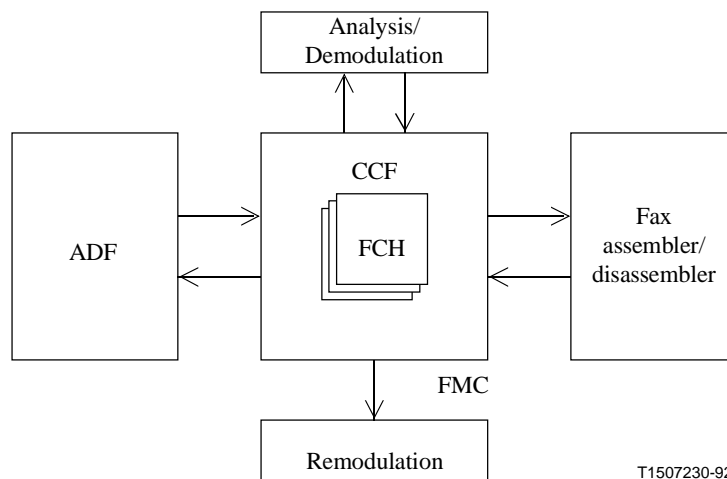

Figure 9/G.766 – FMC structure and interfaces

6.1.1 Communication with the ADF

The CCF exchanges information with the Hangover control and Signal Classification (HSC) and the Resource management and Assignment Generation (RAG) processes of the DCME via the facsimile control interface. The HSC messages processed by the CCF are Data(IT), for the classification of the call as a potential facsimile call, and DataInact(IT), Voice(IT), Rx_data(IT) or Transp(IT) for the detection of termination of the facsimile call. The CCF provides two messages to the HSC. The first message forces an "inactive" declaration for the IT (this disables DSI/ADPCM processing of the IT). The second message removes this condition.

The messages provided to the RAG place requests for the creation/deletion of a fax bank in the DCME bearer.

The CCF also communicates with the O&M system.

6.1.2 Other communication functions

The CCF relays messages between the FCH and the signal analyser (WA approach), the modulators, demodulators and the associated switches (see Figure 11). The CCF also relays messages between an FCH and its peer process in the remote facsimile module. The CCF provides HSC messages to the FCH indicating the termination of the facsimile call.

6.1.3 Capacity management

The task of requesting and releasing facsimile banks resides with the CCF. The number, n , of facsimile banks needed depends on the number m (see 5.2) of facsimile blocks in the facsimile frame, i.e. from the selected frame length. The relationship between n and m is the following:

$$n = m / 2$$

At the beginning of operation, m shall be set to 2, i.e. one facsimile bank shall be requested. This facsimile bank will carry the facsimile control channel and one additional facsimile block. More facsimile banks shall then be requested, one at a time, in order to accommodate the selected facsimile frame length.

The traffic content of the frame varies dynamically because the number of calls in progress changes and because each call transitions independently through different stages of the call procedure, often with different amounts of transmitted data. It is desirable that these short-term variations do not cause frequent requests for assignment and deletion of the facsimile banks. The margin built into the frame length should be large enough to accommodate without delay a sudden traffic increase and yet not cause an excessive reduction of the frame efficiency¹.

Reduction in the facsimile traffic will cause m to be reduced from its current value to a lower value, with the consequent release of facsimile banks (one at a time).

6.1.4 FCH management

Upon reception of a Data(IT) or a Rx_data(IT) message from the ADF, the CCF shall create an FCH for that IT and the IT shall be entered in the list of facsimile ITs. Upon reception of a CONNECT(IT) message from the corresponding FCH and the IT is not in the list of facsimile ITs, the CCF shall create an FCH for that IT and pass the CONNECT(IT) message to the FCH. The IT shall be entered in the list of facsimile ITs. If remodulator/demodulator resources are not available, the FCH shall not be created.

When the Terminate(IT) message is generated by an FCH, its associated IT shall be deleted from the list of facsimile ITs.

6.1.5 Demodulator/remodulator pool management

If a shared pool approach is implemented, the CCF will be responsible for the assignment of the demodulator/remodulator to each FCH, as needed. At creation of the FCH a "complete" set of demodulators/remodulators should be allocated to the FCH. When the FCH terminates, the associated demodulator/remodulator resources are released to the pool.

6.2 Facsimile Channel Handler (FCH)

The FCH is a process that monitors the facsimile call, determines the call parameters, and generates control information for demodulators, remodulators and associated devices. There is interactive communication between the two FCH processes handling the call at the two ends of the link. All FCH communications are via the CCF.

The FCH process for an IT is created by the CCF when the Data(IT) message or the Rx_data(IT) message is received from the HSC process. The FCH associated with either the called end or the calling end may be required to operate in a transmit (Tx) or receive (Rcv) mode (direction of page transmission or reception), depending on whether polling is used.

The Tx FCH must decide whether demodulation of the facsimile call can take place. The criterion for the decision is whether the Tx FCH has the capability and the resources (demodulators) to handle the call and whether the remote facsimile module has available the corresponding remodulators (this information is provided to the Tx FCH). If the facsimile call cannot be demodulated it will be routed via the 40 kbit/s ADPCM channel (the call continues to be monitored by the FCH until completion).

In clause 4, two different facsimile compression approaches were introduced, the Protocol Analysis (PA) approach and the Waveform Analysis (WA) approach. Correspondingly, there are two types of FCH, the PA FCH and the WA FCH. Both can be in either Tx or Rcv modes. The Tx and Rcv FCH can, in turn, be in either a normal mode (demodulation and remodulation is used) or in the ADPCM mode.

¹ An optimized procedure for the selection of the facsimile frame length and the request/release of the facsimile bank should be employed.

In a PA FCH, operating in the normal mode, there is the possibility for the FCH of being either in standard facilities T.30 mode (SF-T.30) or in a non-standard facilities T.30 mode (NSF-T.30).

Figure 10 shows the possible progression paths for the PA and WA FCH processes. To permit interworking, compatibility must be ensured for all paths. There are 14 basic interworking configurations, as shown in Table 3.

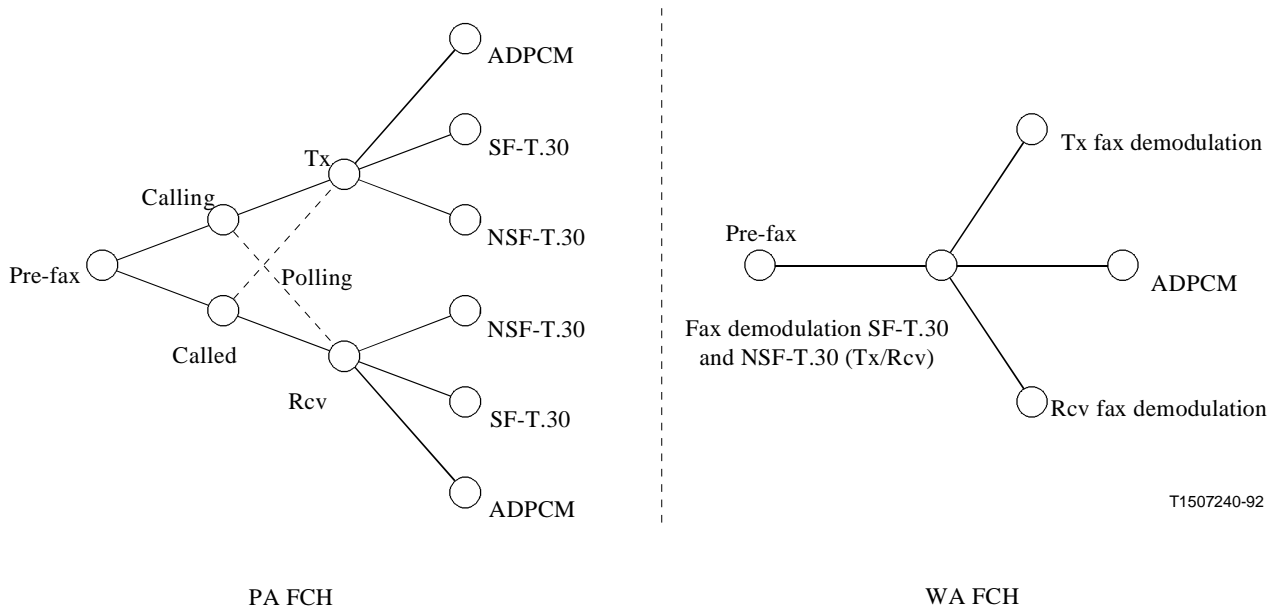

SF-T.30 Standard facilities T.30 protocol
 NSF-T.30 Non-standard facilities T.30 protocol

Figure 10/G.766 – Progression paths for the PA FCH and the WA FCH protocols

The general FCH protocol requirements are addressed below. The application of the protocol to a comprehensive set of interworking cases is analysed in Annex A.

Table 3/G.766 – Interworking FCH configurations

Call type	Calling → called FCH			
	PA → PA	PA → WA	WA → PA	WA → WA
SF-T.30 matched resources	1	2	3	4
NSF-T.30 matched resources	5	6	7	
SF-T.30 unmatched resources (ADPCM)	8	9	10	11
NSF-T.30 unmatched resources (ADPCM)	12	13	14	

6.2.1 FCH requirements

In both the PA and the WA approaches, control codes are sent to and received from the corresponding FCH to exchange information necessary for the demodulation/remodulation process. The information provided by the control codes is the following:

- 1) activation of the demodulated path;
- 2) allocated remodulator resources;
- 3) contents of the facsimile frame;
- 4) start/end and frequency of echo protection tones;
- 5) start of training sequence, type, modulation type and bit rate;
- 6) call transfer to the ADPCM channel;
- 7) acknowledgement of certain messages;
- 8) refreshment of previous messages;
- 9) termination of the call.

In addition to decoding the control codes, the PA FCH, when handling a T.30 call, reads and interprets the procedural messages exchanged between the communicating facsimile terminals. The messages transmitted by the local facsimile terminal are obtained by demodulating the low-speed voiceband signal. Those originated by the distant terminal are received in digital form in the facsimile frame.

Using the message information, the PA FCH keeps track of the state of the SF-T.30 call and obtains the necessary information to control the demodulators, remodulators and associated devices.

The FCH of the WA type does not read the procedural signals of the facsimile calls and, therefore, does not keep track of the progress of the call through its different states. On the transmit side, the method relies entirely on local signal analysis. The Rcv mode WA FCH, unlike the PA FCH, obtains information on the modulation type and rate from a control code [see 6.2.1, item 5) above]. In the WA approach there is no difference between an SF-T.30 and a NSF-T.30 call.

The NSF-T.30 mode of operation of the PA FCH is not specified. Its principle of operation is based on recognizing the NSF-T.30 protocol identification code, interpreting the information exchanged between the facsimile terminals and demodulating/remodulating the facsimile signals accordingly.

6.2.2 FCH protocol

The specification for the FCH protocol is provided below as a list of procedural steps. A notation placed next to each step number indicates a significant event which may occur in that step. The requirements associated with each step are provided separately for the two sides of the link. The requirements listed apply to both the PA and WA FCH, except where noted. The symbols {PA} and {WA}, at the beginning of a paragraph, indicate that the requirement applies only to the PA FCH or to the WA FCH, respectively. Message field structure and variables are defined in clause 7.

Step 1 (Initial state) – Called side

The called side FCH for an IT is started at the reception of the Data(IT) message from the HSC process or the RxData(IT) message from the Receive channel status Update and overload channel Decoding (RUD) process. The initial state, entered by the FCH at creation, is referred to as the pre-fax state. If the FCH remains in the pre-fax state for more than 15 seconds, the terminate(IT) message shall be sent to the CCF and the FCH shall terminate.

Step 1 (Initial state) – Calling side

The calling side FCH for an IT is started, in the pre-fax state, at the reception of the Data(IT) or RxData(IT) messages. If the FCH remains in the pre-fax state for more than 15 seconds, the terminate(IT) code shall be generated and the FCH shall terminate.

Step 2 (DIS) – Called side

The called side FCH monitors the IT in order to detect the High level Data Link Control (HDLC) flags of the V.21 signal (DIS) received from the local called side facsimile terminal (the transmission of the signal through the DCME is via the ADPCM path). Upon detection of eight flags, the called side FCH shall enter the called state and the CONNECT code shall be sent to the remote calling FCH process. Together with the CONNECT code, the "resource list" (allocated remodulators) shall be sent to the remote calling FCH. The response to the CONNECT code is the RESOURCE code (see step 2, calling side). Failure to receive this code within three seconds shall result in generation of the DISCONNECT code and termination of the FCH process.

{WA} The called side FCH shall assign a waveform analysis unit to the IT in order to detect and classify the facsimile signals (the unit could be time-shared among different ITs on an as needed basis).

Upon termination of the V.21 signal (DIS), a SWITCH_TO_DEMOD code shall be sent to the remote calling FCH. The FED buffer (see Figure 2) shall be inserted in front of the demodulated path and the IT shall be switched to the digital path (the demodulator/remodulator path).

Step 2 (DIS) – Calling side

Upon reception of the CONNECT code, the calling side FCH shall enter the calling state and shall transmit the RESOURCE code (containing the resource list). Upon reception of the SWITCH_TO_DEMOD code, the FED buffer shall be inserted in front of the demodulated path and the IT shall be switched to the digital path.

{WA} The calling side FCH shall assign a waveform analysis unit to the IT in order to detect and classify the facsimile signals (the unit could be time shared among different ITs on an as needed basis).

Step 3 (DCS) – Calling side

Upon reception of a V.21 signal from the local calling side facsimile terminal, the calling side FCH shall assign a V.21 demodulator to the IT, send the SIGNALLING code (indicating the presence of the new facsimile data channel in the facsimile frame), and insert the demodulated bits into the allocated data channel. This action will continue until termination of the V.21 signal, at which time the IDLE code shall be transmitted to indicate the removal of the facsimile data channel from the facsimile frame. (The function of the IDLE code may be combined with the path switching function and performed by the SWITCH_TO_ADPCM code. See below.)

V.21 signals are passed transparently even when errors are detected [e.g. cyclic redundancy check (CRC) failure]. HDLC zero stuffing is also passed transparently.

{PA} Upon termination of the V.21 signal, the calling side FCH shall decode the received V.21 message and take consequent action. Three possible cases, corresponding to the messages DTC, DCS and NSS, are addressed separately below.

DTC – This is the polling message, meaning that the called side will be the transmit side. In this case, the calling side FCH shall enter the Rcv mode and remove the FED buffer from the demodulated path.

- DCS – In this case, the calling side FCH shall enter the Tx mode (the FED buffer shall be kept). The calling side FCH shall decode the modulation and rate of the call from the DCS message and determine whether demodulation/remodulation is possible from knowledge of the available local demodulators, and remote remodulators exchanged in step 2. If demodulation/remodulation is not possible, the SWITCH_TO_ADPCM code shall replace the IDLE code at the termination of the demodulated DCS signal. The IT path, with the FED buffer inserted, shall be switched to ADPCM, and the calling side FCH will enter the ADPCM mode.
- NSS – This code indicates a non-standard protocol. If the calling side FCH recognizes the non-standard protocol as one it can handle, and if appropriate demodulator and remodulator resources are available, the calling side FCH shall enter the appropriate Tx NSF-T.30 mode. If any of the above conditions are not satisfied, the SWITCH_TO_ADPCM code shall replace the IDLE code at the termination of the demodulated NSS signal. The IT path, with the FED buffer inserted, shall be switched to ADPCM, and the calling side FCH will enter the ADPCM mode.

Step 3 (DCS) – Called side

The called side FCH shall select a V.21 remodulator and the V.21 data extracted from the facsimile data channel shall be transmitted to the local facsimile terminal. If the code received at termination of the V.21 data is SWITCH_TO_ADPCM, the IT path shall be switched back to ADPCM and the calling side FCH will enter the ADPCM mode.

V.21 signals are passed transparently even when errors are detected (e.g. CRC failure). HDLC zero stuffing is also passed transparently.

When the V.21 data is not received for three seconds, the called side FCH may transmit a flag sequence to the local facsimile terminal to prevent expiration of the link timer. This option may be used throughout the FCH procedure.

{PA} If the SWITCH_TO_ADPCM code is not received, the called side FCH shall decode the demodulated V.21 message (zero stuffing is removed) and take consequent action. Three possible cases, corresponding to the DTC, DCS and NSS messages are addressed separately below.

- DTC – This is the polling message, meaning that the called side will be the transmit side. In this case, the FCH shall enter the Tx mode and the FED buffer shall be inserted in front of the demodulated path.
- DCS – In this case, the called side FCH shall enter the Rcv mode. The FCH shall read the modulation and rate of the call from the DCS message for later use.
- NSS – When the called side FCH recognizes the NSS code, the call side FCH shall enter the Rcv NSF-T.30 mode.

Step 4 (EPT) – Transmit side

Upon detection of an Echo Protection Tone (EPT) and its frequency (f), the transmit side FCH shall generate the EPT(f) code for the remote receive side FCH. The tone frequency, f, and level shall be provided with the code as defined in Table 7. Upon termination of the tone, the transmit side FCH shall generate the EPT_END code.

Step 4 (EPT) – Receive side

Upon reception of the EPT(f) code from the remote transmit side FCH, the receive side FCH shall generate the echo protection tone of frequency f and level in accordance with Table 7. Upon reception of the EPT_END code, the receive side FCH shall cease transmission of the tone.

Step 5 (Training sequence) – Transmit side

Upon detection of a high speed signal, if no echo protection tone was received as part of this burst then the code LEVEL shall be transmitted prior to the code TRAINING.

{PA} Upon detection of a high speed signal (i.e. other than V.21). The transmit side FCH shall generate the code TRAINING (mode, rate, long). The parameters mode, rate and the Boolean variable "long" indicate the modulation type, the modulation rate, and whether the training sequence is long or short (note that for V.17 modulation, the training sequence is long before the training check and short before page data). The values of the parameters included in the TRAINING code are obtained from the DCS message (or from codes in the NSF-T.30 protocol).

{WA} Upon detection of a high speed signal, the FCH shall enter the transmit mode and the FED buffer shall be kept. Upon detection and classification of the training signal, the transmit side FCH shall generate the code TRAINING (mode, rate, long). The parameters mode and rate are determined by signal analysis. In some cases (long training sequence), rate information will not be available and, therefore, it will be set to "unavailable" in the message. The variable "long" shall always be set to FALSE. If the signal analysis later determines that a long training sequence is being received, the code LONG_TRAINING (rate), with appended rate information, shall be generated by the transmit side FCH.

The delayed version of the training sequence (delayed by the FED buffer) shall be used to train the selected high speed demodulator.

Step 5 (Training sequence) – Receive side

Upon reception of the code TRAINING (mode, rate, long), generation of a training sequence of the required modulation type, modulation rate, and length shall be started by the receive side FCH at a level consistent with Table 7 based on the level field of the EPT or LEVEL codes.

{PA} The parameters of the training sequence are obtained from the DCS code or from codes in the NSF-T.30 mode. If the code LONG TRAINING is received, it shall be ignored.

{WA} Upon reception of the code TRAINING, the FCH shall enter the receive mode. The FED buffer shall be removed from the demodulation path. The parameters (mode, rate, long) of the training sequence are obtained from the received TRAINING code. If the code LONG_TRAINING is received from the remote transmit side FCH while the training sequence (short) is being generated, the sequence shall be extended (i.e. changed to a long sequence) by the receive side FCH, using the rate indicated in the LONG_TRAINING (rate) code.

Step 6 (Training check/page data) – Transmit side

When data bits are output by the selected high speed demodulator, the FAX_DATA code shall be generated by the transmit side FCH to indicate the presence of the new facsimile data channel in the facsimile frame, and the data bits shall be inserted in the data channel. This will continue until termination of the data, at which time the IDLE code shall be transmitted to signal the removal of the facsimile data channel from the facsimile frame.

Page data shall be transmitted unscrambled. The fill bits for incomplete or empty facsimile channels shall be "1".

Step 6 (Training check/page data) – Receive side

When data bits for an IT are received in the facsimile frame, as signalled by the FAX_DATA code, the data extracted from the allocated facsimile data channel shall be provided to the selected high speed remodulator for transmission to the local receive facsimile terminal. The modulated data shall follow the regenerated training sequence without any gap. Transmission of the data will continue until reception of the IDLE code for the IT.

Step n (Disconnection) – Originating side²

When the signal Voice(IT) or Transp(IT) is received from the HSC process of the DCME, the disconnection process shall be started. When the signal DataInact(IT) is received in the transmit mode, the disconnection process shall also be started.

{PA} When the DISCONNECT (DCN) message generated either by the local or remote facsimile terminal, is detected, the disconnection process shall be started.

The disconnection process requires transmission of the DISCONNECT code to the remote FCH, switching of the IT path to ADPCM and termination of the FCH.

Step n (Disconnection) – Notified side²

When the DISCONNECT code is received, the IT path shall be switched to ADPCM and the FCH process shall terminate.

6.2.2.1 Examples of the FCH protocol

Figure 11 provides an example of an FCH functional decomposition. Table 4 is an example of FCH interworking using the functional decomposition of Figure 11 for the WA-PA configuration where PA is the calling side. The EPT and the high speed data transmission phases are not included in Table 4.

² The disconnection process may originate from either side of the connection.

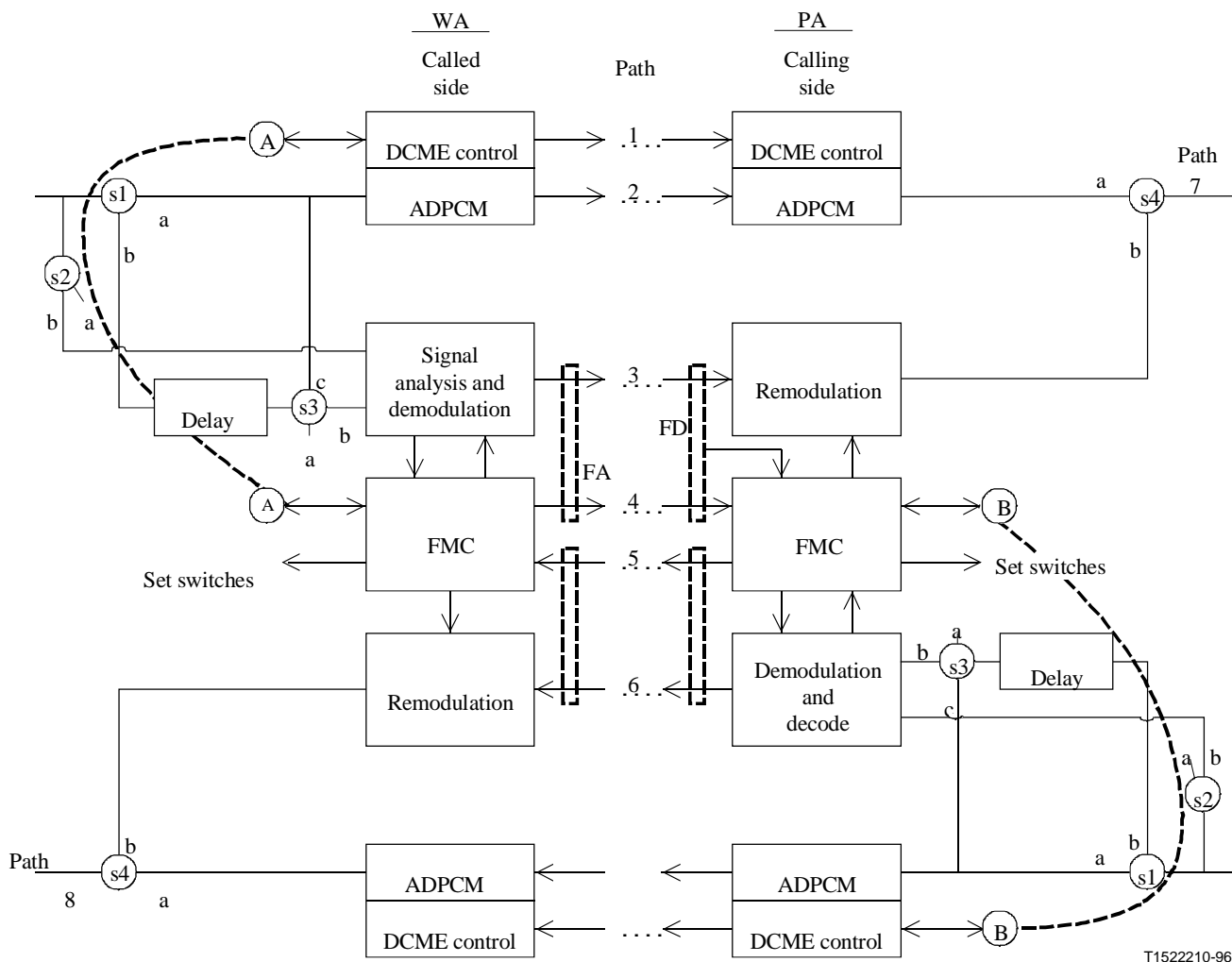

T1522210-96

- FA Fax frame assembler
- FD Fax frame disassembler (+V.21 decode in PA)
- s1, s2, s3, s4 Switches
- a, b, c Switch positions
- A, B Connection points

Figure 11/G.766 – An example of FCH functional decomposition

Table 4/G.766 – An FCH interworking example using the FCH functional decomposition of Figure 11

	(Called) WA					(Calling) PA					Path							
	s1	s2	s3	s4	ST	s1	s2	s3	s4	ST	1	2	3	4	5	6	7	8
2100 Hz tone (WA action)	a	b	a	a	P F X	a	a	a	a		d a t a	t o n e						t o n e
Start of DIS (WA action)	a	b	a	b	C L D	a	b	a	a	P F X	d a t a	D I S		C N C				D I S

**Table 4/G.766 – An FCH interworking example
using the FCH functional decomposition of Figure 11 (concluded)**

	(Called) WA					(Calling) PA					Path							
	s 1	s 2	s 3	s 4	S T	s 1	s 2	s 3	s 4	S T	1	2	3	4	5	6	7	8
Start of DIS (PA action)	a	b	a	b	C L D	a	b	a	a	C L G	d a t a	D I S			R S C		D I S	
End of DIS (WA action)	b	b	b	b	C L D	a	b	a	a	C L G	d a t a	D I S		S W D			D I S	
End of DIS (PA action)	b	b	b	b	C L D	b	b	b	b	C L G	d a t a	D I S					D I S	
DCS (PA action)	b	b	b	b	C L D	b	b	b	b	C L G					S I G	D C S		D C S
DCS (WA action)	b	b	b	b	C L D	b	b	b	b	T X					I D L			D C S
Training (PA action)	b	b	b	b	C L D	b	b	b	b	T X					T R N			
Training (WA action)	a	a	a	b	R C V	b	b	b	b	T X								T R N
Disconnect (PA action)	a	a	a	b	R C V	a	a	a	a	T X					D S C			
Disconnect (WA action)	a	a	a	a	R C V	a	a	a	a	T X				D S C				
Disconnect (WA and PA action)	a	a	a	a		a	a	a	a									

ST, PFX, CLD, CLG, TX, RCV State, Pre-Fax, Called, Calling, Transmit, Receive
CNC, RSC, SIG, IDL CONNECT, RESOURCE, SIGNALLING, IDLE
TRN, DSC, SWD TRAINING, DISCONNECT, SWITCH_TO_DEMOD
s1, s2, s3, s4, a, b See Figure 11.

6.2.2.2 SDL representation of the FCH protocol

The FCH protocol for the PA case can be modelled as a state machine and represented by means of Specification and Description Language (SDL) diagrams. The SDL representation of the PA standard facility T.30 protocol is given in Annex B and provides a more detailed description. The

SDL representation of WA FCH is not provided since this protocol is adequately described in a text only form.

7 Use of the facsimile control channel

The facsimile control channel (see 5.2.1) consists of a 9-bit IT field and a 12-bit message field. The 21-bit FCC is transmitted once per DCME frame (2 ms). The value of the IT field defines ITs numbered from 1 to 511. The numbering range from 1 to 216, the "normal" range, is used to designate traffic trunks. The "special range", from 500 to 511, is reserved for inter-module functions.

The value 0 in the IT field applies collectively to all facsimile ITs and it is used, together with its associated message field, to indicate whether the facsimile frame is FEC encoded.

7.1 Message field structure

When the IT is in the normal range, the 12-bit message field (see Figure 5) is structured into a 4-bit "message ID" part and an 8-bit "message content" part. The message ID defines either a single control code with appended parameters, such as TRAINING (long, mode, rate), or a group of codes without appended parameters.

The structure of the message content part depends on the message ID. The different structures are shown in Figures 12 and 13. Note the 4-bit signal level field, used to transmit the input signal level encoded through a 16-level quantizer (requirement in Table 1).

The specific bit patterns assigned to the various codes of the message content part of the FCC are provided in Tables 5 through 8.

When the IT number is 0, the message field consists of either 12 binary "1"s or 12 binary "0"s. The all "1"s message indicates that FEC is applied to the facsimile frame. The all "0" message indicates that the FEC is not used.

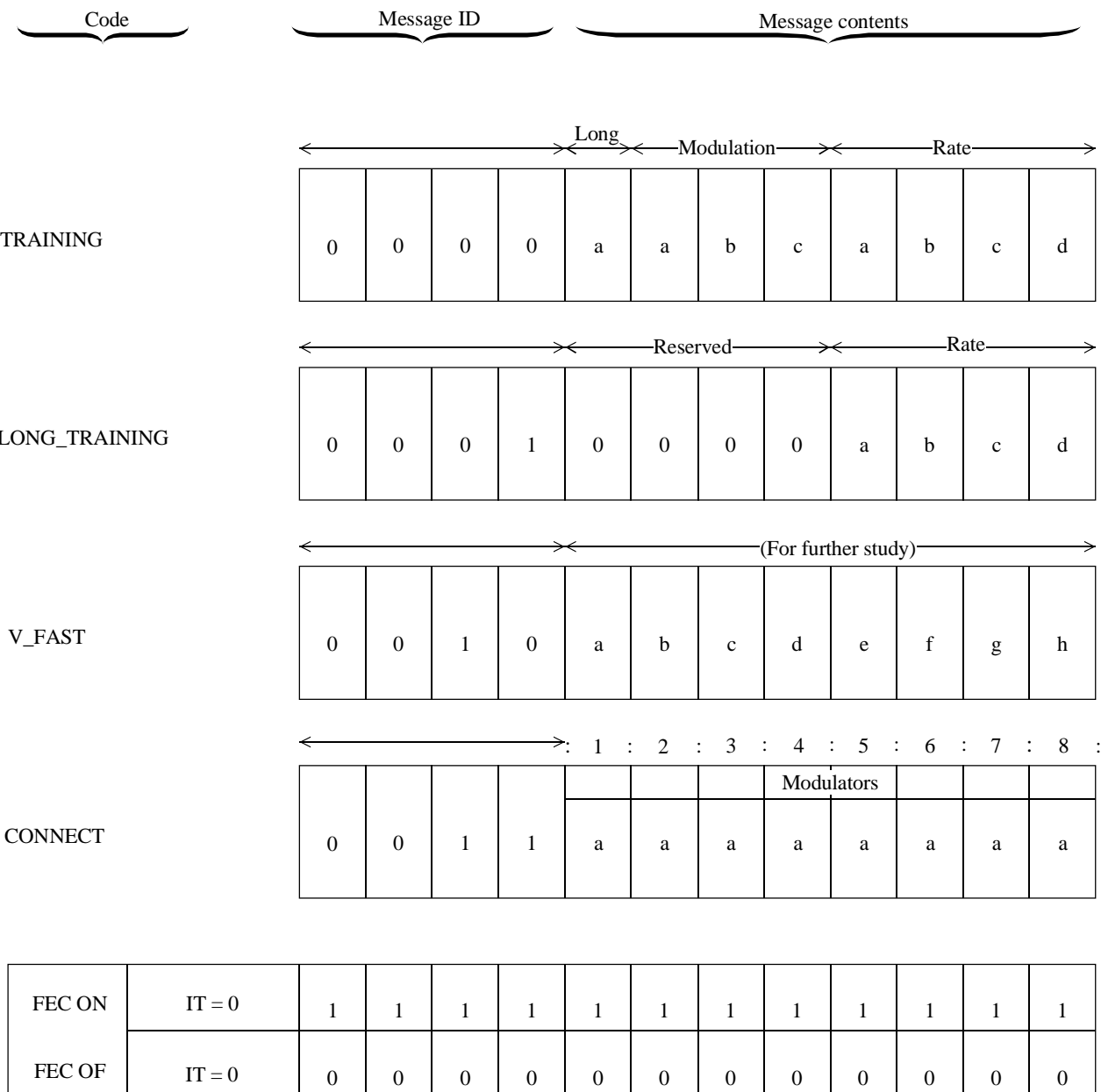

NOTE – The bit designations a, b, ... are defined for each field of the FCC message independently.

T1522220-96

Figure 12/G.766 – Structure of FCC messages – Part 1
(See Tables 5 to 8)

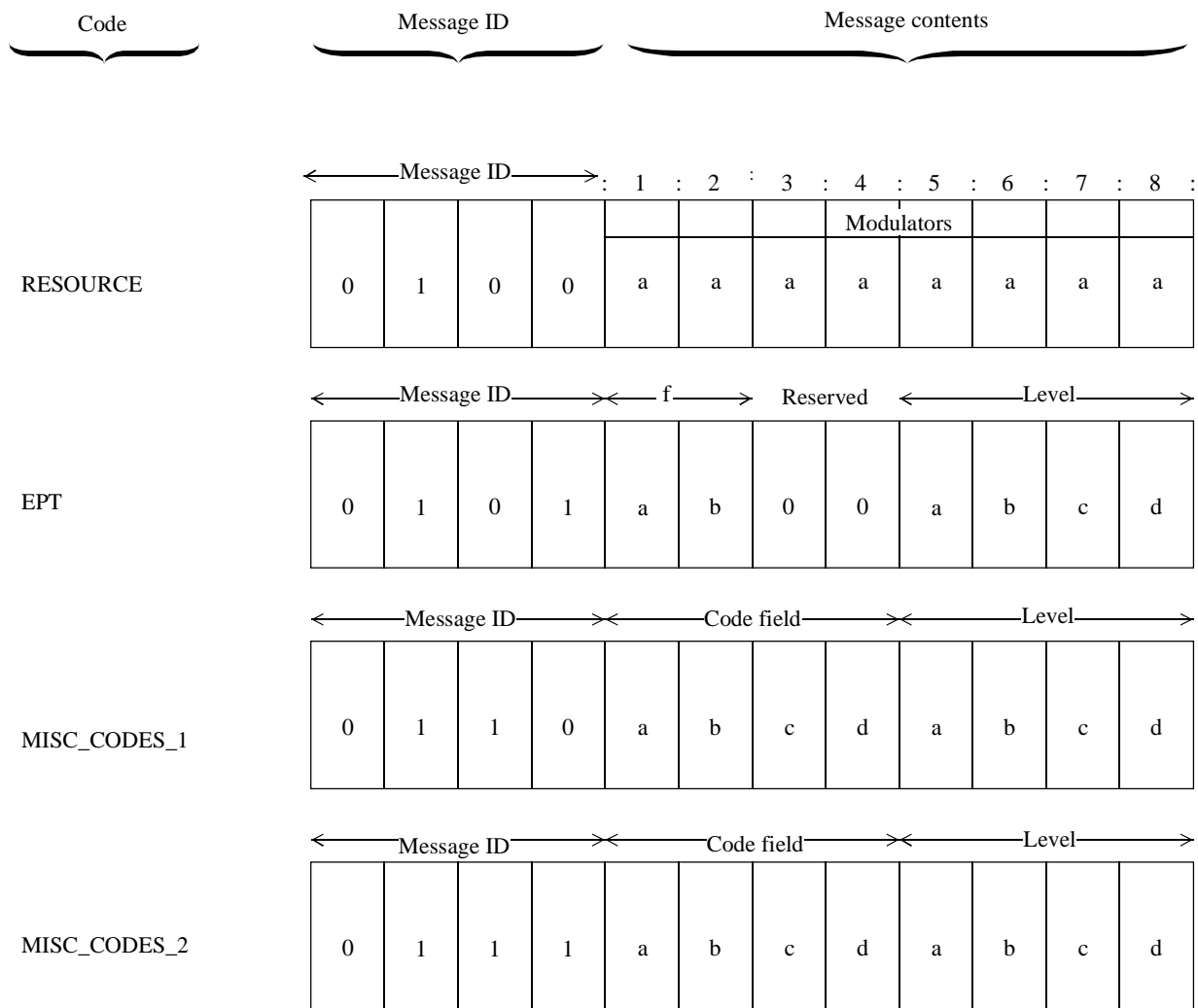

T1522230-96

NOTE – The bit designations a, b, ... are defined for each field of the FCC message independently.

Figure 13/G.766 – Structure of FCC messages – Part 2
(See Tables 5 to 8)

Table 5/G.766 – Training message: Code list
(See Figure 12)

"Long" field				
Bit a				Meaning
0				False
1				True
"Modulation" field				
Bit a	Bit b	Bit c	Meaning	
0	0	0	V.17	
0	0	1	V.21	
0	1	0	V.27 <i>ter</i>	
0	1	1	V.29	
1	0	0	V.33	
"Rate" field				
Bit a	Bit b	Bit c	Bit d	Meaning
0	0	0	0	"Unavailable"
0	0	0	1	300 bit/s
0	0	1	0	2 400 bit/s
0	0	1	1	4 800 bit/s
0	1	0	0	7 200 bit/s
0	1	0	1	9 600 bit/s
0	1	1	0	12 000 bit/s
0	1	1	1	14 400 bit/s

Table 6/G.766 – Connect/resource message: Code list
(See Figures 12 and 13)

"Modulator" field								
Mod. 1	Mod. 2	Mod. 3	Mod. 4	Mod. 5	Mod. 6	Mod. 7	Mod. 8	Meaning
V.21	V.27	V.29	V.17	V.33	<	Reserved	>	
Bit a	Bit a	Bit a	Bit a	Bit a	Bit a	Bit a	Bit a	
1	1	1	1	1	0	0	0	Available
0	0	0	0	0	0	0	0	Not available

Table 7/G.766 – EPT message: Code list
(See Figure 13)

"Frequency" field					
Bit a Bit b Meaning					
0 0 1 700 Hz					
0 1 1 800 Hz					
"Level" field					
Demodulator input p (dBm0)	Bit a	Bit b	Bit c	Bit d	Remodulator output p (dBm0)
$-13 \leq p$	0	0	0	0	
$-15 \leq p < -13$	0	0	0	1	
$-17 \leq p < -15$	0	0	1	0	
$-19 \leq p < -17$	0	0	1	1	
$-21 \leq p < -19$	0	1	0	0	To be determined by the operator
$-23 \leq p < -21$	0	1	0	1	
$-25 \leq p < -23$	0	1	1	0	
$-27 \leq p < -25$	0	1	1	1	Default level of -17 dBm0 suggested (Note 1)
$-29 \leq p < -27$	1	0	0	0	
$-31 \leq p < -29$	1	0	0	1	
$-33 \leq p < -31$	1	0	1	0	
$-35 \leq p < -33$	1	0	1	1	
$-37 \leq p < -35$	1	1	0	0	
$-39 \leq p < -37$	1	1	0	1	
$p < -39$	1	1	1	0	
Level not measured	1	1	1	1	

NOTE 1 – The receive demodulator input level may not be constant throughout the call; however, the selected level for the remodulated echo protection tone, training and data signals shall be equal and remain the same throughout the call.

NOTE 2 – Precautions shall be taken to ensure that the demodulator input is not sensitive to the echo received from its local end hybrid.

Table 8/G.766 – Miscellaneous codes message: Code list
(See Figure 13)

a) Miscellaneous Codes No. 1				
"Code" field				
Bit a	Bit b	Bit c	Bit d	Code
0	0	0	0	SWITCH_TO_ADPCM
0	0	0	1	END_EPT
0	0	1	0	SIGNALLING
0	0	1	1	IDLE
0	1	0	0	FAX_DATA
0	1	0	1	LEVEL
0	1	1	0	SWITCH_TO_DEMOD
"Level" field				
As for EPT message (see Table 7)				
b) Miscellaneous Codes No. 2				
"Code" field				
Bit a	Bit b	Bit c	Bit d	Code
0	1	0	1	DISCONNECT

7.2 Message transmission procedure

Since independently originated messages may compete for transmission over the FCC, queuing is necessary. A priority system shall be used, giving the highest priority to messages that affect the critical time gaps of the facsimile call (see 8.2). The priority list for the FCC codes is provided in Table 9.

Table 9/G.766 – Priority list for FCC codes

Priority 1	Priority 2	Priority 3
MISC_CODES_1	MISC_CODES_2	FEC_ON
TRAINING	Service channel message	FEC_OFF
V_FAST		
LONG_TRAINING		
CONNECT		
RESOURCE		
EPT		
LEVEL		

Transmitted messages shall be "refreshed" (e.g. repeated). The ITs logged in the list of "facsimile ITs" shall be refreshed, when permitted by the queuing system, from the low to the high numbers, in a cyclical fashion. The IT number 0 is always included in the facsimile list.

If a message indicates a change in the facsimile frame (i.e. the appearance or disappearance of a facsimile data channel), the change shall be implemented three frames after the frame in which the relevant control code is transmitted as shown in Figure 14.

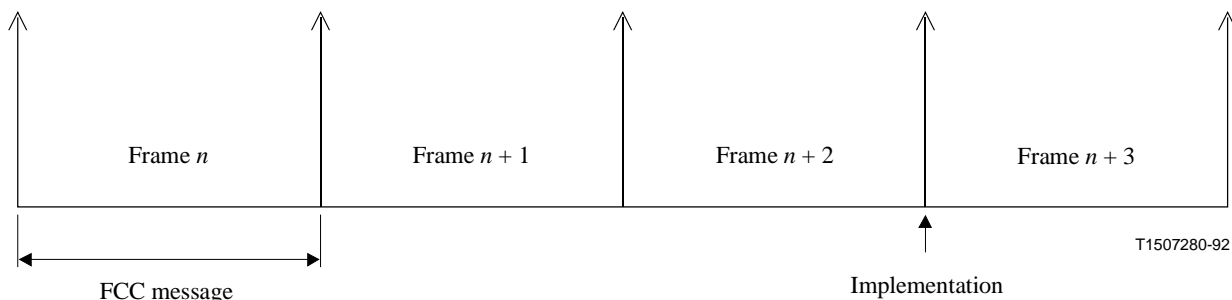

Figure 14/G.766 – FCC codes implementation timing

7.3 Service channel

The service channel is a channel established, on an as needed basis, for communication among the corresponding modules of a DCME link. The "special range" IT numbers (see clause 7) are used for this function.

When communication is needed, the message with the appropriate IT number, will be inserted in the queue for the FCC and transmitted as permitted by the status of the queue and the priority selected.

The service channel ITs shall not be refreshed.

The message field associated with a service channel IT is structured in a 4-bit message ID part and an 8-bit message content part. The information exchanged via the service channel is defined in Table 10.

Table 10/G.766 – Service channel messages

Message	IT No./ID	Message content
Error count	500/0000	Destination A error count
	500/0001	Destination B error count
	500/0002	Destination C error count
	500/0003	Destination D error count
NOTE 1 – Other service channel messages are for further study.		
NOTE 2 – See 10.3 for the error count definition.		

8 Timing and delay requirements

8.1 Clock difference compensation

8.1.1 Demodulator side

The timing of the incoming facsimile data is controlled by the transmitting facsimile terminal clock, which has an accuracy requirement of 1×10^{-4} . The timing of the demodulated data transmitted in the facsimile frame is controlled by the DCME clock (see 13.1.1/G.763). The mechanism for compensating the clock rate differences is the use of stuffing bits in the facsimile data channels (see 5.1).

8.1.2 Remodulator side

The timing of the facsimile data extracted from the facsimile frame, after bit destuffing, is controlled by the transmitting facsimile terminal clock. The timing of the remodulated data transmitted to the local facsimile terminal is controlled by the modulator clock. The modulator clock is either the DCME clock or a variable clock.

If the DCME clock is used, a slip buffer of at least 200 ms is required to absorb the cumulative effects of the clock differences over the time of a page transmission (for an assumed high density, normal length page, transmitted at 9.6 kbit/s with a 1×10^{-4} clock accuracy). The buffer will be started at its central point at the start of each transmission block.

If the variable modulator clock approach is selected, the clock rate shall be adjusted to keep the accumulated excess bits (or shortage of bits) within narrow limits at all times. This will permit the use of a small buffer and accommodate pages of any length.

8.2 Critical time gaps of the T.30 signals

In the T.30 protocol, there are time gaps between certain consecutive signals that are required to be kept within a specified tolerance. Specifically, there is a requirement of a gap of $75 \text{ ms} \pm 20 \text{ ms}$ between the end of certain low speed signals (e.g. DCS) and the start of the following high speed signal (EPT or training). There is the same requirement between the end of certain high speed signals (e.g. page data) and the start of the following low speed signal [e.g. End-of-Procedure (EOP)].

The constraint placed on the facsimile compression function is that the combined action of the demodulator side module and the modulator side module should not shorten the critical gaps but could extend them by additional interval of up to 40 ms.

Another requirement of the facsimile transmission protocol is that there should be no gap between the end of the training sequence and the beginning of the data. The gap between the EPT and the training sequence is 20 to 25 ms. The task of ensuring that these requirements are met is assigned to the remodulator side module.

8.2.1 Demodulator side requirements

For the demodulator side module, the following requirements apply:

- 1) The gap between DCS and EPT/training shall not be shortened and, if extended, it shall not be increased by more than 20 ms. This requirement applies whether path switching to ADPCM occurs or does not occur during the time gap.
- 2) The gap between image data and EOP shall not be shortened and, if extended, it shall not be increased by more than 20 ms.
- 3) The delay in the demodulator shall not exceed 220 ms.

8.2.2 Remodulator side requirements

- 1) The gap between DCS and EPT/training shall not be shortened and, if extended, it shall not be increased by more than 20 ms. This requirement applies whether path switching to ADPCM occurs or does not occur during the time gap.
- 2) The gap between image data and EOP shall not be shortened and, if extended, it shall not be increased by more than 20 ms. For the remodulator side module, the following requirements apply:

Note that, to meet the gap requirement between the data signal and EOP, if a slip delay buffer is used (see 8.1.2), a delay buffer must also be used in the EOP path. This buffer must be set to a delay value equal to the delay the slip buffer introduced in the high speed path at termination of the image signal.

The nominal delay on the remodulator side shall not exceed 120 ms. If a slip buffer is used, the average delay value must be assumed in the determination of the nominal delay.

The remodulator side module shall introduce no gap between the end of the training sequence and the beginning of the data. The gap between the EPT and the training sequence shall be 20 to 25 ms.

8.3 Front-End Delay (FED) buffer

The FED buffer is a PCM delay buffer inserted, when needed, in front of the demodulator, to provide sufficient time for signal validation (PA) or signal analysis (WA).

In the PA method, although the type of input signal expected can be predicted from the status of the protocol, there are fault conditions that could cause the local facsimile terminal to transmit a low speed signal instead of a high speed signal. The FED buffer provides sufficient time to detect the presence of the low speed signal.

In the WA approach, a signal analysis unit is applied to the input signal for signal classification, while the delayed version of the input is propagating through the delay buffer.

The delay value of the FED buffer may be different for the two approaches. This value is not explicitly specified; however, the total delay for the facsimile module is specified.

9 Multi-clique and multi-destination operation

The facsimile module shall permit multi-clique and multi-destination operation of the DCME. In multi-clique operation, the facsimile module shall process up to four received facsimile frames. The ITs directed to the module shall be sorted out by processing the FCCs of the received frames and by means of the IT allocation map (IT allocation to DCME links), down-loaded at configuration set-up.

In multi-destination mode, if one or more corresponding DCMEs are not equipped with a facsimile module, an operational problem will occur unless the unit without the facsimile module is specially modified to recognize fax banks to permit their exclusion from voice-list, so that overload channels are properly recovered.

10 Facsimile module operation and maintenance

The O&M and configuration data should be transported over the O&M interface with the DCME. The data should be accessed by means of the same operator facility (e.g. PC/workstation) used for the DCME.

10.1 Facsimile module statistics

Relevant parameters of the facsimile module operations shall be monitored and displayed. Parameters shall be measured over a predetermined time period called the Facsimile Statistical Time Interval (FSTI). The FSTI shall be selectable in the range from 10 minutes to 60 minutes (in 10-minute steps). The summary statistics calculated at the end of the FSTI shall be kept in a statistic data file on a secured storage medium (e.g. non-volatile RAM, hard disk, etc.) (see Note 1). The parameters to be monitored include:

a) *Number of facsimile calls* (required)

Defined as the number of calls (see Note 3) classified as facsimile calls during the FSTI period.

- b) *Percent of time FEC activated* (required)
 Defined as the ratio of FEC ON time over FSTI. This statistic shall be calculated once every 1-minute interval with the accumulated data from every sampled DCME frame (each 100th frame).

The percentage should be calculated to one decimal place.

$$\frac{\text{Sum of FEC active time}}{\text{FSTI}} \times 100$$

- c) *Peak number of facsimile banks allocated* (required)
 Defined as the highest number of allocated facsimile banks during FSTI. Intermediate statistic shall be calculated once every 1-minute interval with the accumulated data from every sampled DCME frame (each 100th frame). At the end of FSTI, the biggest number among intermediate statistic is picked as the peak number of facsimile banks.

- d) *Mean number of facsimile banks allocated* (required)
 Every 100 DCME frames, the number of allocated facsimile bank is recorded. Every minute, the average number of allocated facsimile banks is calculated using the recorded data for that minute. These one-minute average values are again averaged over FSTI. The number should be calculated to one decimal point.

- e) *Facsimile bank shortage due to bearer congestion* (required)
 Defined as the ratio of DCME frames in which the information contents of the facsimile frame can not be entirely accommodated by the capacity provided by the facsimile banks. The ratio should be expressed as a percentage.

$$\frac{\text{No. of DCME frames with faxbank shortage}}{\text{No. of DCME frames in FSTI}} \times 100$$

- f) *Local and remote error count* (as defined in 10.3) (required)

Local error count

Defined as the average number of error count (see 10.3) over a FSTI period. The number shall be calculated to two decimal points. Any non-zero error count value shall be stored with a time-stamp in a non-volatile storage medium.

$$\frac{\text{Sum of errorblock count in a FSTI period}}{\text{Number of measurement intervals in a FSTI period}}$$

Remote error count

Defined as the average number of received error count from a destination over a FSTI period. The number shall be calculated to two decimal points. Any non-zero error count value shall be stored with a time-stamp in a non-volatile storage medium.

$$\frac{\text{Sum of received error count in the local FSTI period}}{\text{Number of error count reception in the local FSTI period}}$$

- g) *Number of calls set up using standard facilities* (optional) (see Note 2)
 Defined as an accumulated number of facsimile calls (see Note 3) which are classified as standard T.30 calls during the FSTI period.

- h) *numbers of calls set up using non-standard facilities* (optional)
 Defined as an accumulated number of facsimile calls (see Note 3) which are classified as non-standard T.30 calls during the FSTI period.

- i) *Number of image blocks sent through the facsimile module at each bit rate* (optional)

Defined as the accumulated count of image blocks (pages, excluding TCF) belonging to the demodulated facsimile calls during the FSTI period. The count of image blocks shall be performed for each bit rate.

j) *Number of fallbacks to ADPCM* (optional)

Defined as an accumulated number of facsimile calls which are switched to ADPCM path during the FSTI period (i.e. "SWITCH_TO_ADPCM" code is generated).

k) *Number of fallbacks to ADPCM due to failure or inability to handle a call involving NSF* (optional)

Defined as an accumulated count of facsimile calls which are switched to ADPCM path due to non-standard T.30 facility during the FSTI period. This is a subset of the calls counted in item j).

l) *Average number of image blocks per demodulated call* (optional)

Defined as the ratio of accumulated count of image blocks (pages, excluding TCF) to the number of demodulated and completed facsimile calls during the FSTI period. The number shall be calculated to the first decimal point.

$$\frac{\text{Accumulated number of image blocks for demodulated signal}}{\text{Number of calls as per item a) – number of calls as per item j)}}$$

NOTE 1 – Facsimile module statistics listed as items a) and f) through l) should be provided on a per destination basis. Items b) through e) should be provided on a per pool basis.

NOTE 2 – If the optional parameters are implemented, they should be done as specified.

NOTE 3 – The number of calls can be counted either by call start or by call termination at the manufacturer's option. The manufacturer may also divide the calls into transmit calls and receive calls.

10.2 Facsimile module configuration data

An example of a facsimile module configuration is provided below:

- 1) FEC activation used or not;
- 2) maximum number of facsimile demodulation/remodulation units;
- 3) option of remodulation output level setting through OMC;
- 4) level of remodulation output. If level option is not selected, the remodulation output level for high and low speed signals shall be set as the first received high and low speed signal levels from the corresponding DCME, respectively.

10.3 Error count

The facsimile module error monitor shall accumulate, over a 30-second interval, the count of the number of facsimile control channel blocks (32 bits per block) in which the syndrome of the FEC code indicates that bits within the block required correction. If 255 or more of such blocks are accumulated, the count indication will remain at 255 until reset for the next measurement interval. The error count shall be transmitted over the service channel (see 7.3) after every measurement interval.

10.4 FEC activation

FEC activation shall be under operator control. The optional feature of automatic FEC activation based on remote error measurements and local load conditions is for further study.

11 Required DCME modifications

The major impact of integrating the facsimile module described in this Recommendation with equipment conforming to Recommendation G.763 is summarized below.

11.1 Facsimile data handling

The facsimile data provided to the DCME via the facsimile data interface is inserted by the DCME into its bearer frame. The FTCs are transmitted by means of special 4-bit channels (32 kbit/s) called "fax banks". Fax banks are created and deleted in response to requests from the facsimile module, so that there are always as many fax banks in the bearer frame as there are FTCs in the facsimile data interface.

Assignment messages are generated by the DCME for the creation of the fax banks. These can symbolically be represented as follows:

(BC, 251)

where BC is the BC number (normal range) to which the fax bank is assigned, and 251 is the IT number used to identify the BC number as a fax bank. The synchronous data word will contain ineffective message code "0000".

The deletion of a fax bank is associated with the generation of an explicit disconnection message of the type:

(BC, 0)

where BC is the number to be disconnected and the synchronous data word will contain the ineffective message code "0000".

In order to handle assignments of 64 kbit/s unrestricted calls, reassignment of a fax bank may be required. The reassignment shall be made in two steps. First, a new fax bank is assigned to the bearer channel number to which the old fax bank will be reassigned. Second, the old fax bank shall be disconnected through an explicit disconnection message.

11.2 Changes in the DCME processes

The HSC process of the DCME must provide five messages to the CCF, Data(IT), Data Inact(IT), Voice(IT), Transp(IT) and RxData(IT).

The CCF provides two messages to the HSC. The first message forces an "inactive" declaration for the IT. The second message removes this condition.

The CCF sends messages to the RAG process for the creation and release of fax banks. Two new queues need to be added to the input pre-processing task. One queue is for the creation of a fax bank. The priority should be immediately below the current priority 3 (64 kbit/s unrestricted request as per A.1.1.2.1.1/G.763). The second queue is for the release of a fax bank. Its priority should be immediately below the current priority 1 (unrestricted 64 kbit/s release).

ANNEX A

Examples of FCH protocol exchanges

Example cases of possible protocol exchanges were analysed and are described in this annex. The polling of 18 cases were analysed (from 0 to 4 cases per configuration). Table A.1 shows which configurations were addressed by the different example cases. In cases 1 to 18, the SDL states for the PA approach are included within parentheses. Corresponding states for the WA approach are omitted because the SDL for WA is not provided.

Table A.1/G.766 – Cases analysed in Annex A

Call type	Calling FCH → Called FCH			
	PA → PA	PA → PA	WA → PA	WA → WA
SF-T.30 Matched resources	1, 2	3, 4	5, 6, 7, 8	9, 10
NSF-T.30 Matched resources	11	12	13	
SF-T.30 Unmatched resources (ADPCM)	14	15	16	18
NSF-T.30 Unmatched resources (ADPCM)	17			
NOTE – Case numbers applicable to each configuration are shown in the table.				

A.1 SF-T.30 cases with matched capabilities

Case 1: Protocol analysis (PA)-PA, no polling

PA (Receive, Called)

PA (Transmit, Calling)

1. Call start

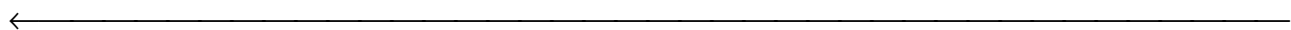

(Pre_FAX)

(Pre_FAX)

Start DIS timer

Start DIS timer

2. BEGINNING OF DIS (ADPCM)

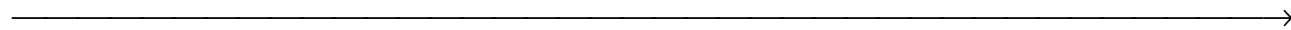

3.



CONNECT (list)

Start resource timer

Allocate resource

(Called_FAX)

4.



RESOURCE (list)

Allocate resource

(Calling_FAX)

5. END OF DIS (ADPCM)

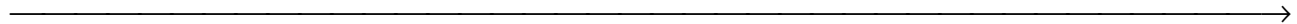

6.



Start DCS timer
Start demodulation path

Start DCS timer
Start demodulation path
Insert fixed delay

7.



SIGNALLING
Demodulated DCS

8.



IDLE

Compatibility is verified for both
DCMEs with received DCS

(Receive_Fax)

(Transmit_FAX)

9.



EPT(f)
Code only

(Remote_EPT)

(Local_EPT)

10.



END_EPT

(Remote__Training)

(Local_Training)

11.

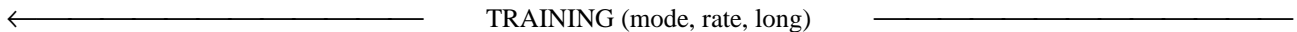

TRAINING (mode, rate, long)
Code only

12.



FAX_DATA
Demodulated TCF

(Remodulate_Data)

(Demodulate_Data)

13.



IDLE

The differentiation between data and
TCF is handled by receive side of
PA_FCH

(Rx_Local_Signal)

(Tx_Remote_Signal)

14.



SIGNALLING
Demodulated CFR

15.



IDLE

(Receive_FAX)

(Transmit_FAX)

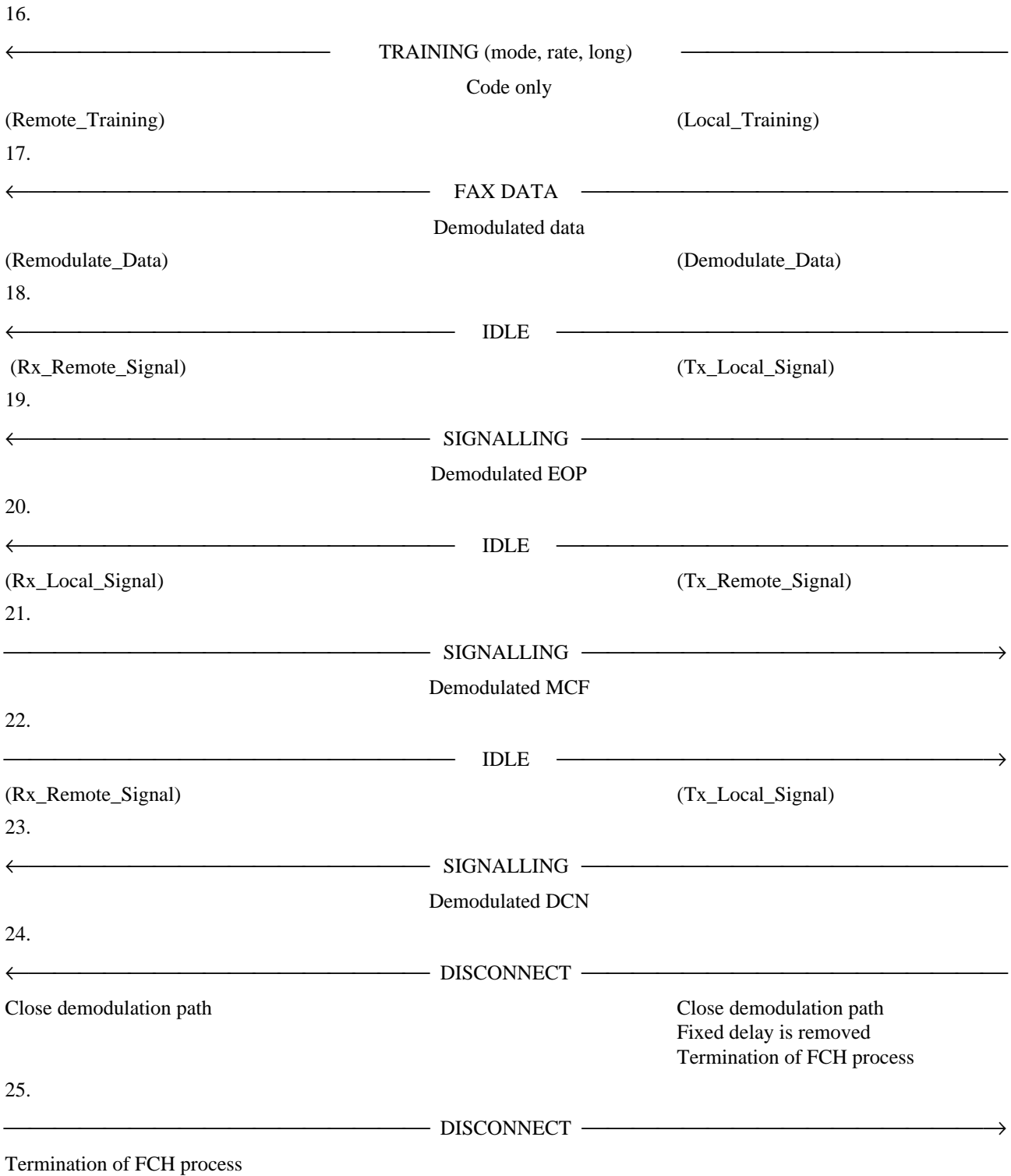

Case 2: PA-PA, polling

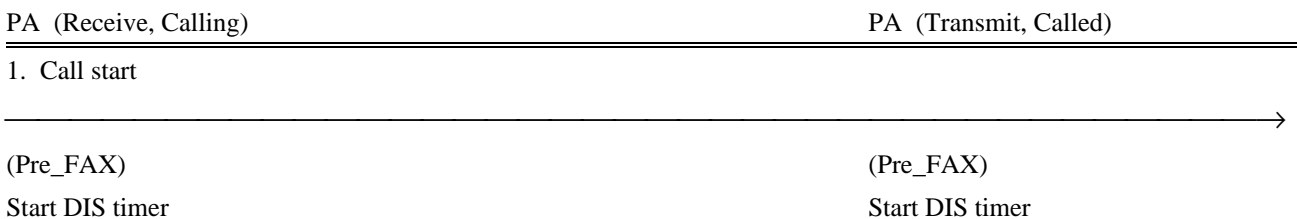

2. BEGINNING OF DIS (ADPCM)

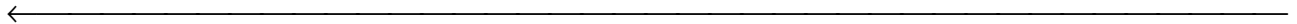

3.



CONNECT (list)

Start RESOURCE timer

Allocate resource

(Called_FAX)

4.



RESOURCE (list)

Allocate resource

(Calling_FAX)

5. END OF DIS (ADPCM)

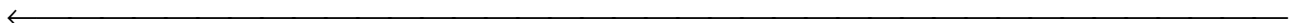

6.



SWITCH_TO_DEMOD

Start DCS timer
Start demodulation path
Insert fixed delay

Start demodulation path
Start DCS timer

7.



SIGNALLING

Demodulated DTC

8.



IDLE

Delete fixed delay

Insert fixed delay

9.



SIGNALLING

Demodulated DCS

10.



IDLE

(Receive_FAX)

Compatibility is verified for both
DCMEs with received DCS

(Transmit_FAX)

NOTE – From now on, procedure is same as case 1, line 9.

Case 3: PA calling – WA called, no polling

WA (Receive, Called)

PA (Transmit, Calling)

1. Call start



(Pre_FAX)

Start DIS timer

Start DIS timer

2. BEGINNING OF DIS (ADPCM)



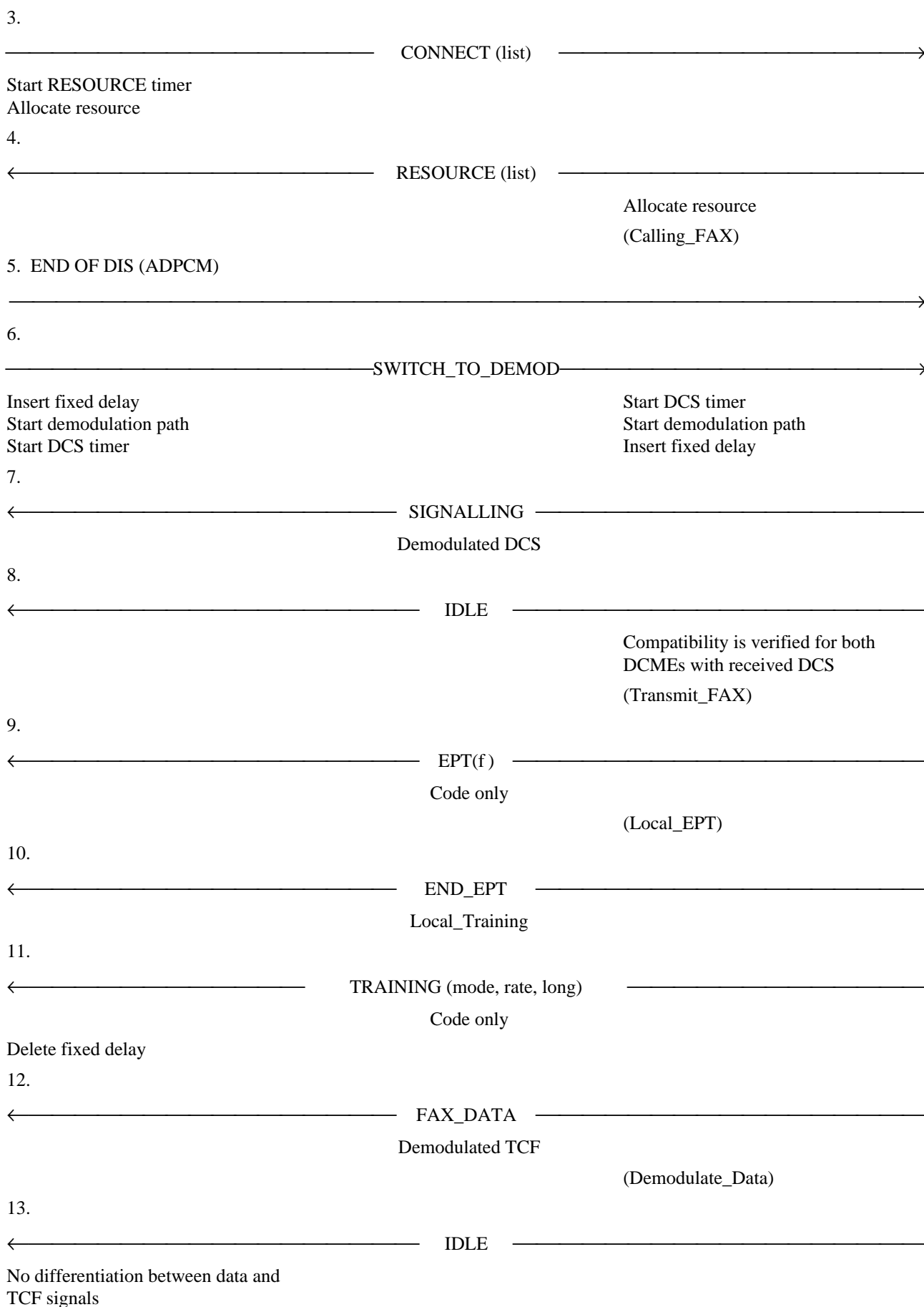

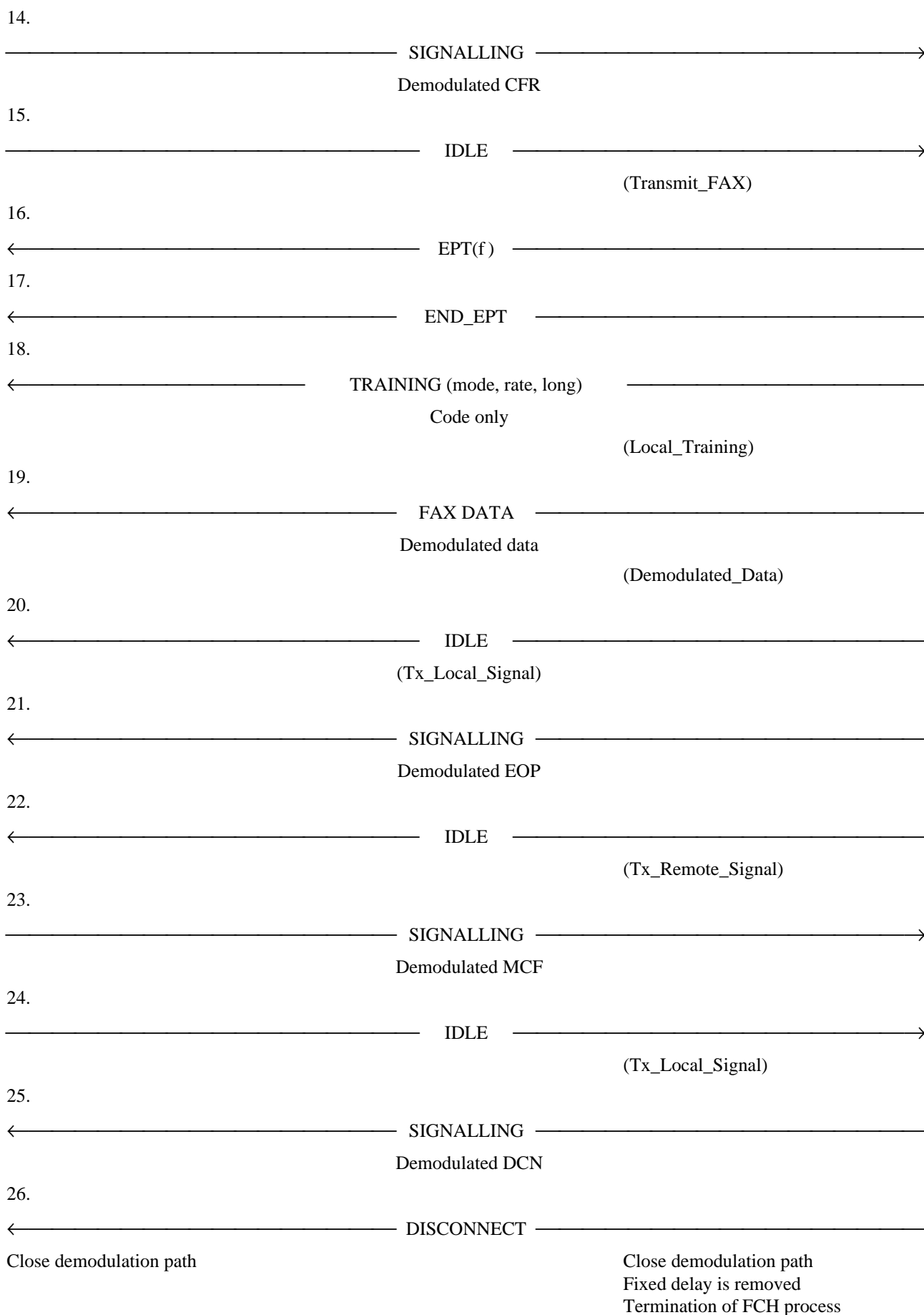

27.

DISCONNECT

Termination of FCH process

Case 4: PA calling – WA called, polling

Waveform analysis DCME communicates with protocol analysis DCME. Protocol analysis DCME initiates a call, but receives facsimile pages.

WA (Transmit, Called)

PA (Receive, Calling)

1. Call start

←

(Pre_FAX)

Start DIS timer

Start DIS timer

2. BEGINNING OF DIS (ADPCM)

→

3.

CONNECT (list) →

Start RESOURCE timer

Allocate resource

4.

← RESOURCE (list)

Allocate resource

(Calling_FAX)

5. END OF DIS (ADPCM)

→

6.

SWITCH_TO_DEMOD →

Insert fixed delay

Start demodulation path

Start DCS timer

Insert fixed delay

Start demodulation path

7.

← SIGNALLING

Demodulated DTC

8.

← IDLE

Delete fixed delay

9.

← SIGNALLING

Demodulated DCS

10.

← IDLE

(Receive_FAX)

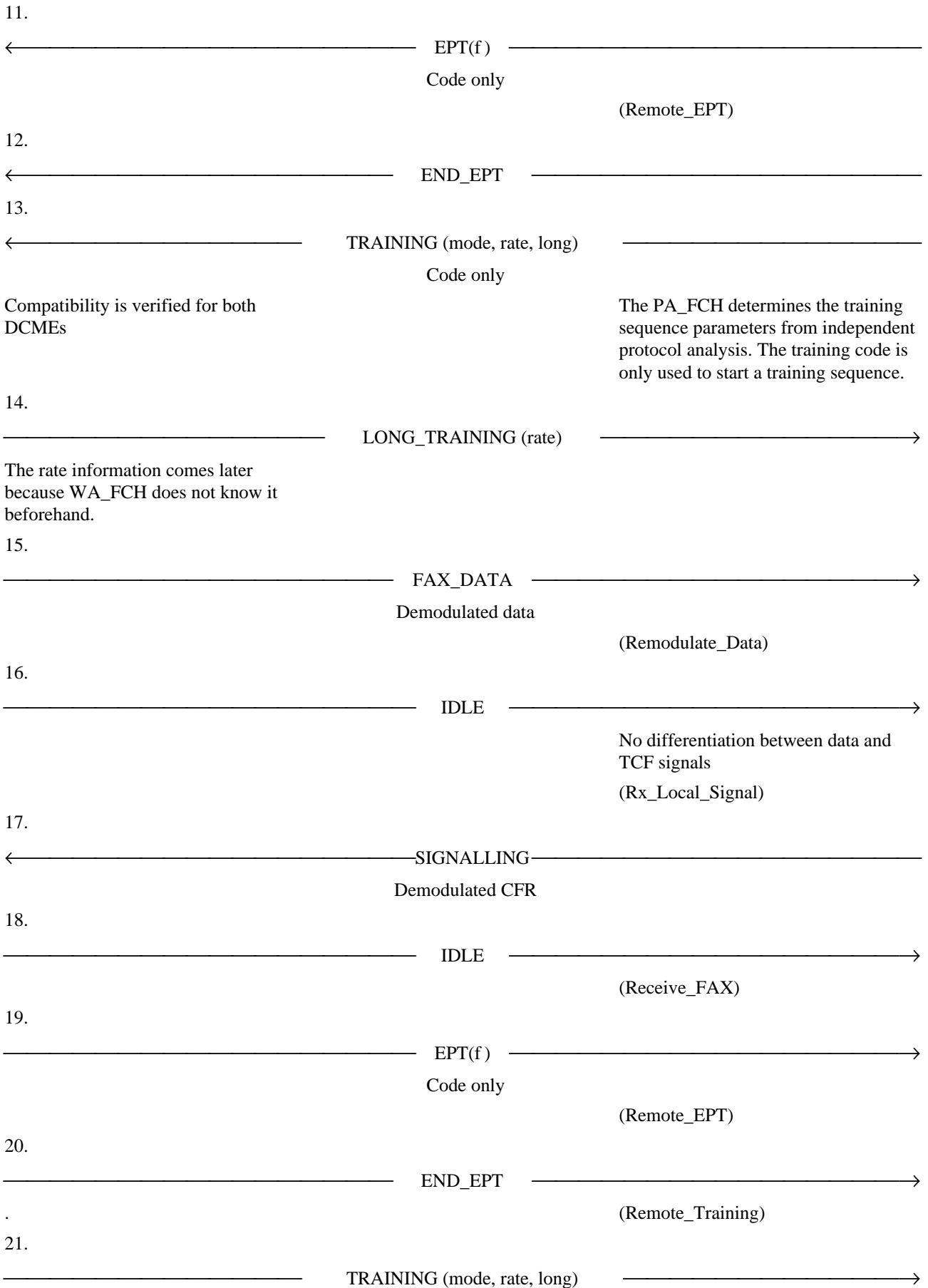

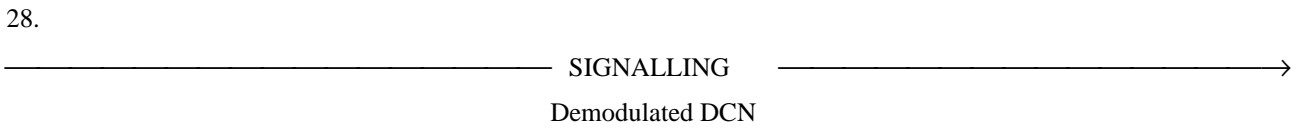
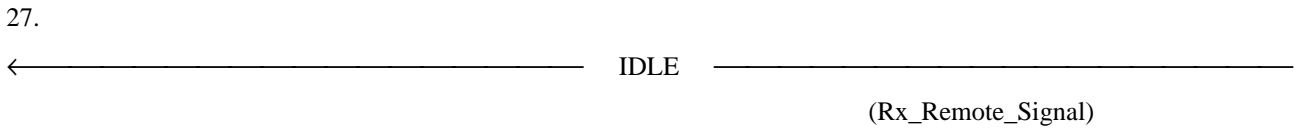
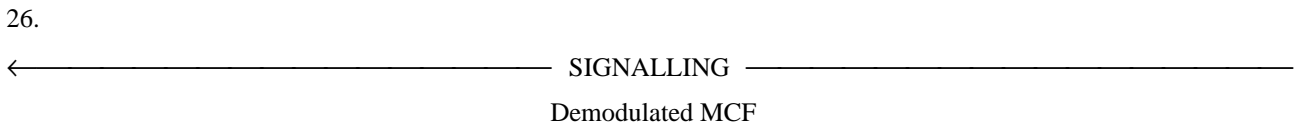
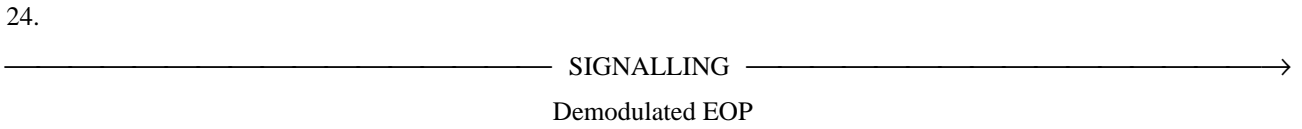
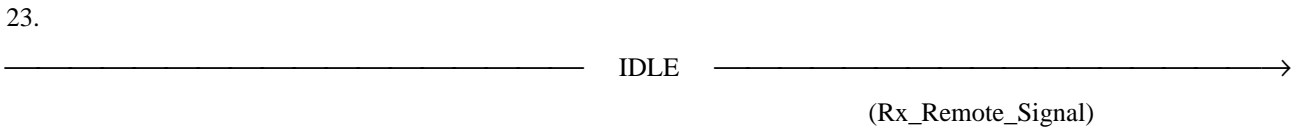

Since DCN signal is not decoded, the end of call is known when:

- 1) data hangover timer (G.763) expires; or
- 2) voice is detected.



Case 5: Waveform analysis (WA) calling – PA called, no polling

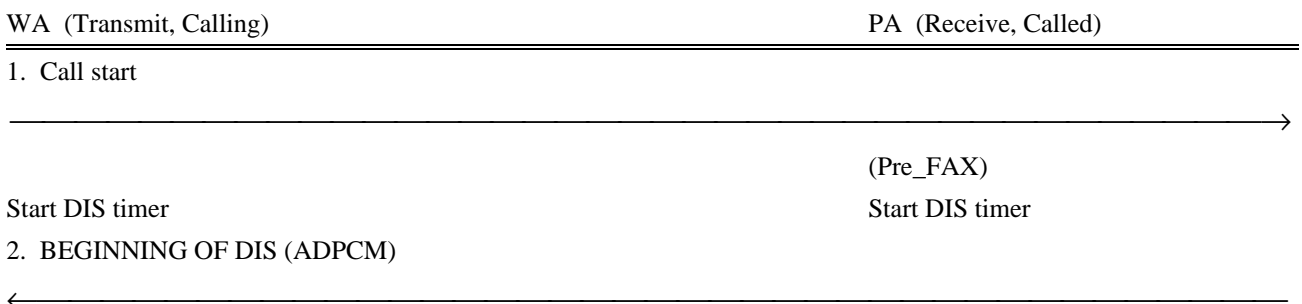

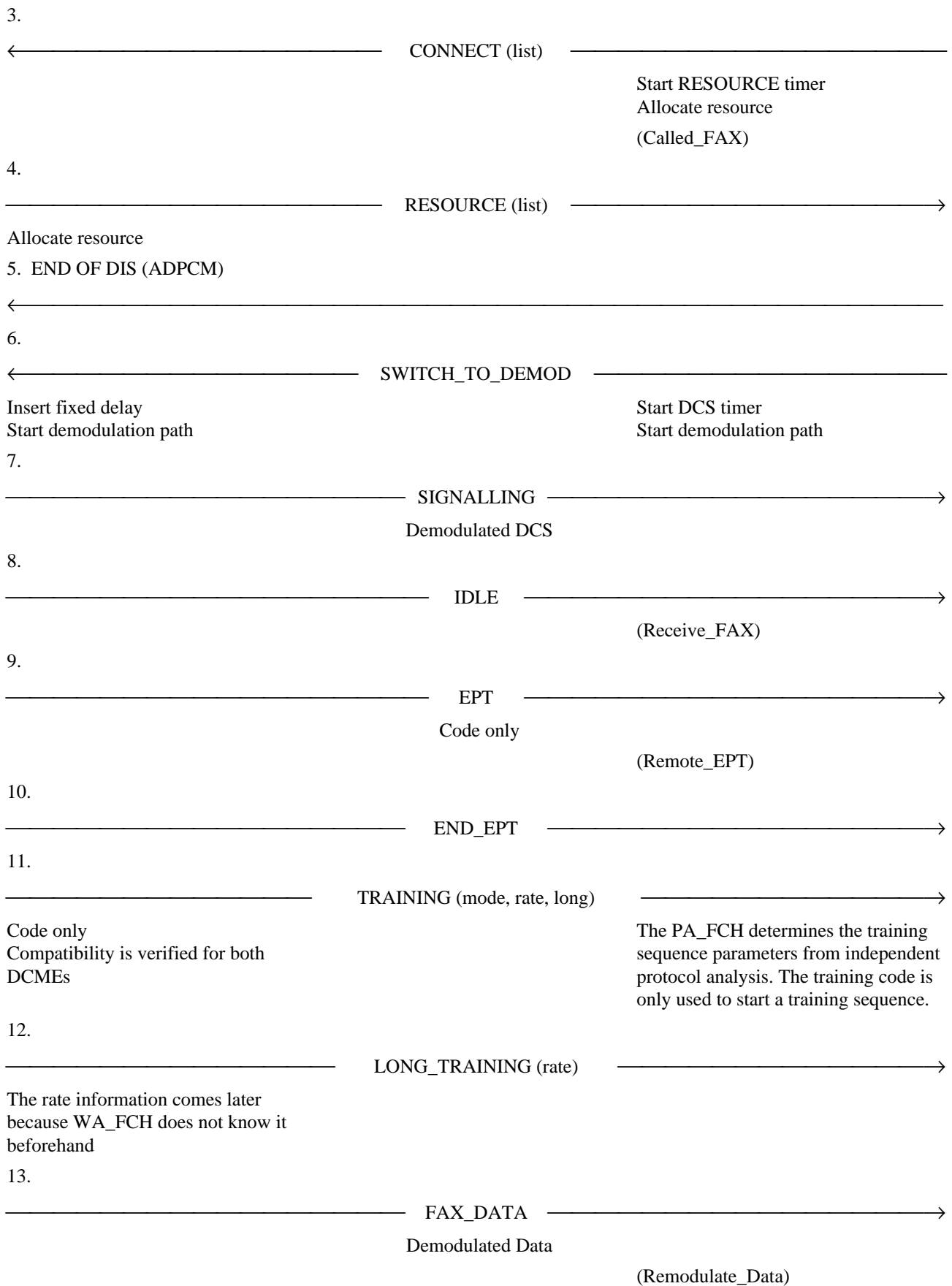

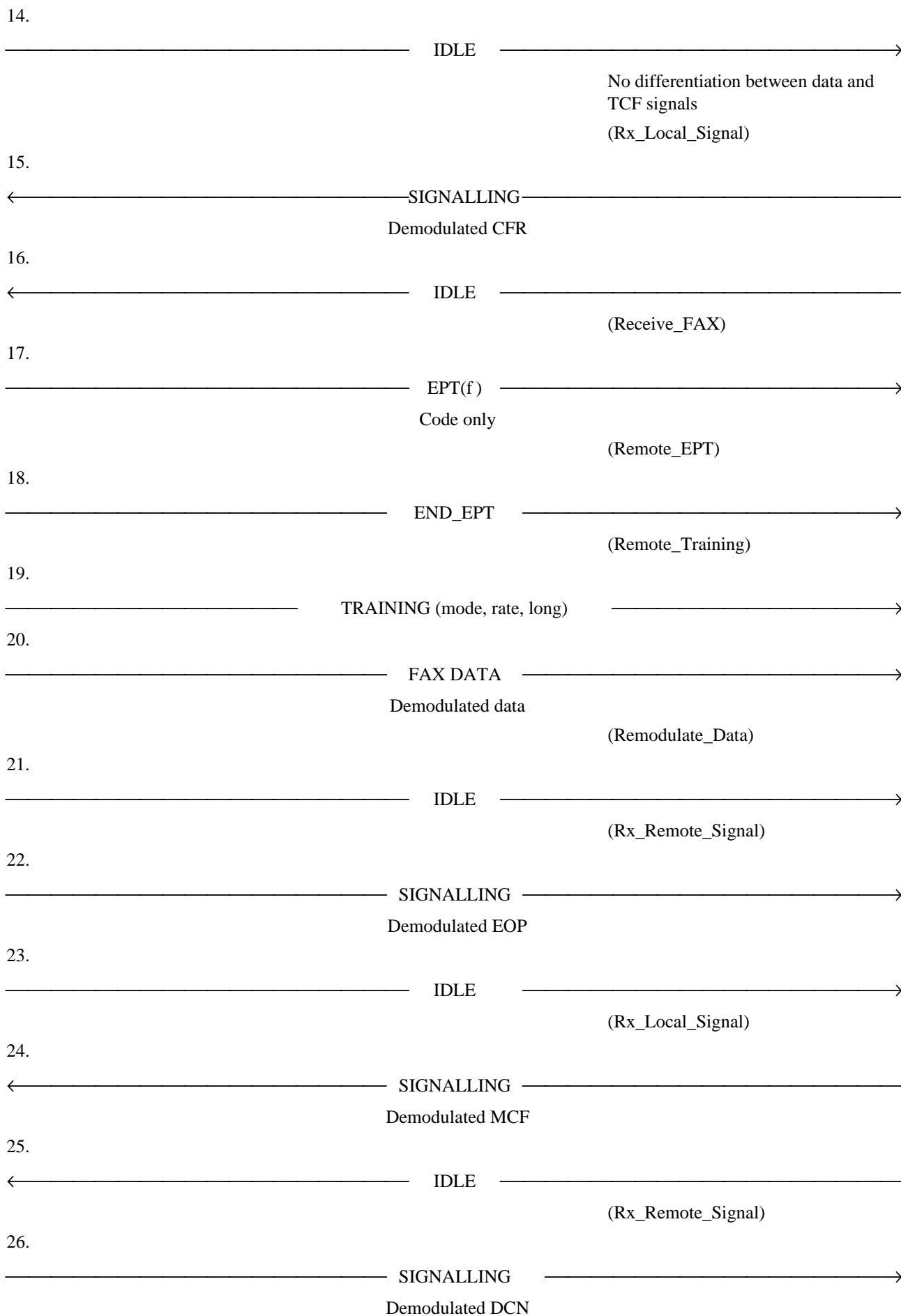

27.



Since DCN signal is not decoded, the end of call is known when:

- 1) data hangover timer (G.763) expires; or
- 2) voice is detected.

28.



Delete fixed delay
Close demonstration path

Close demodulation path
Termination of FCH process

29.



Termination of FCH process

Case 6: WA calling – PA called, polling

WA (Receive, Calling)

PA (Transmit, Called)

1. Call start

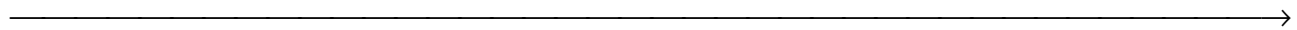

Start DIS timer

(Pre_FAX)

Start DIS timer

2. BEGINNING OF DIS (ADPCM)

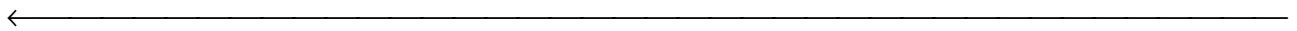

3.



Start RESOURCE timer

Allocate resource

(Called_FAX)

4.



Allocate resource

5. END OF DIS (ADPCM)

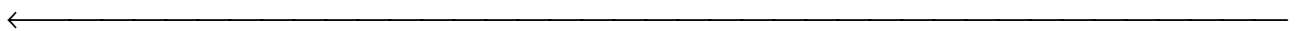

6.



Start demodulation path
Insert fixed delay

Start DCS timer

Start demodulation path

7.



Demodulated DTC

8.



Insert fixed delay

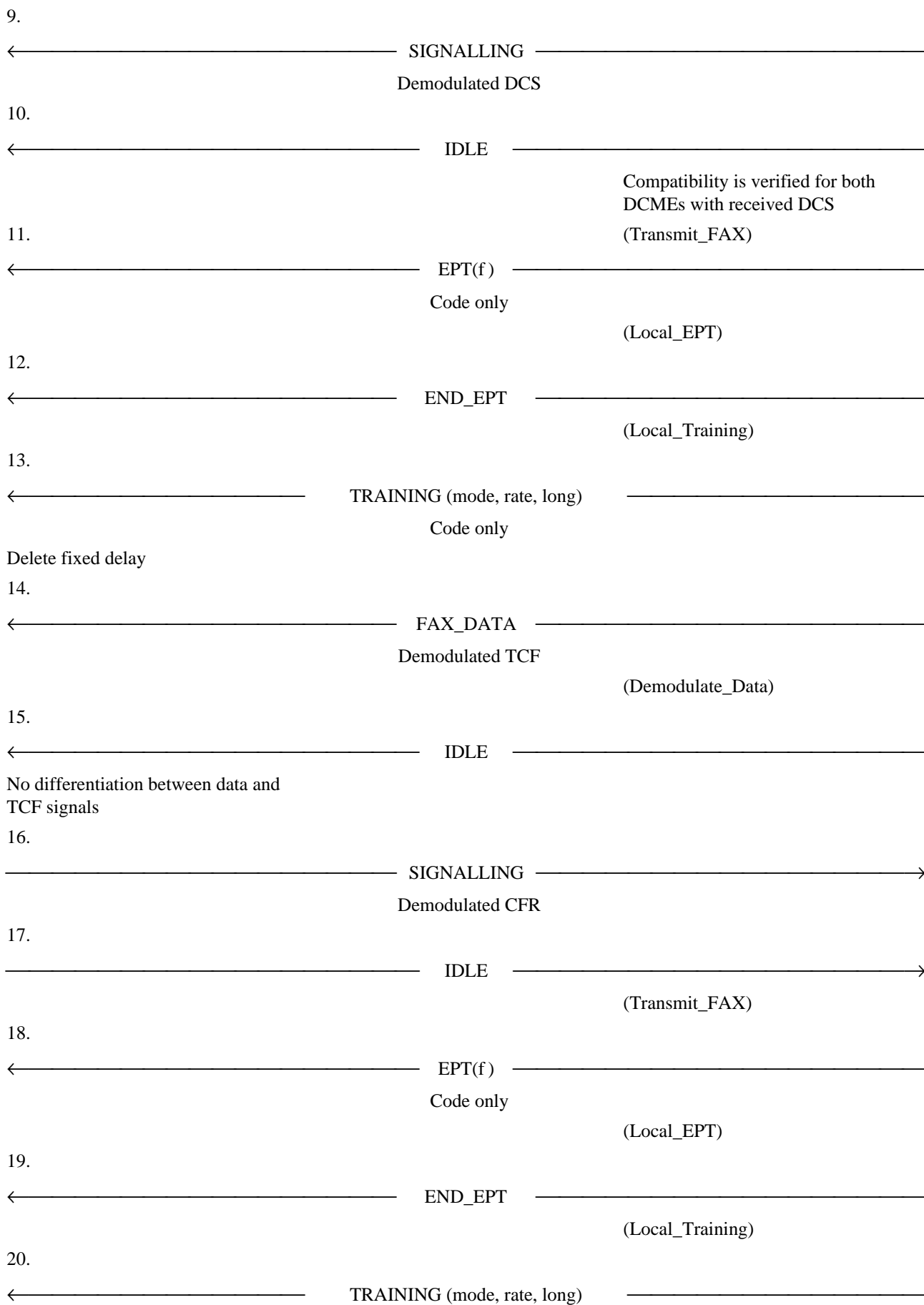

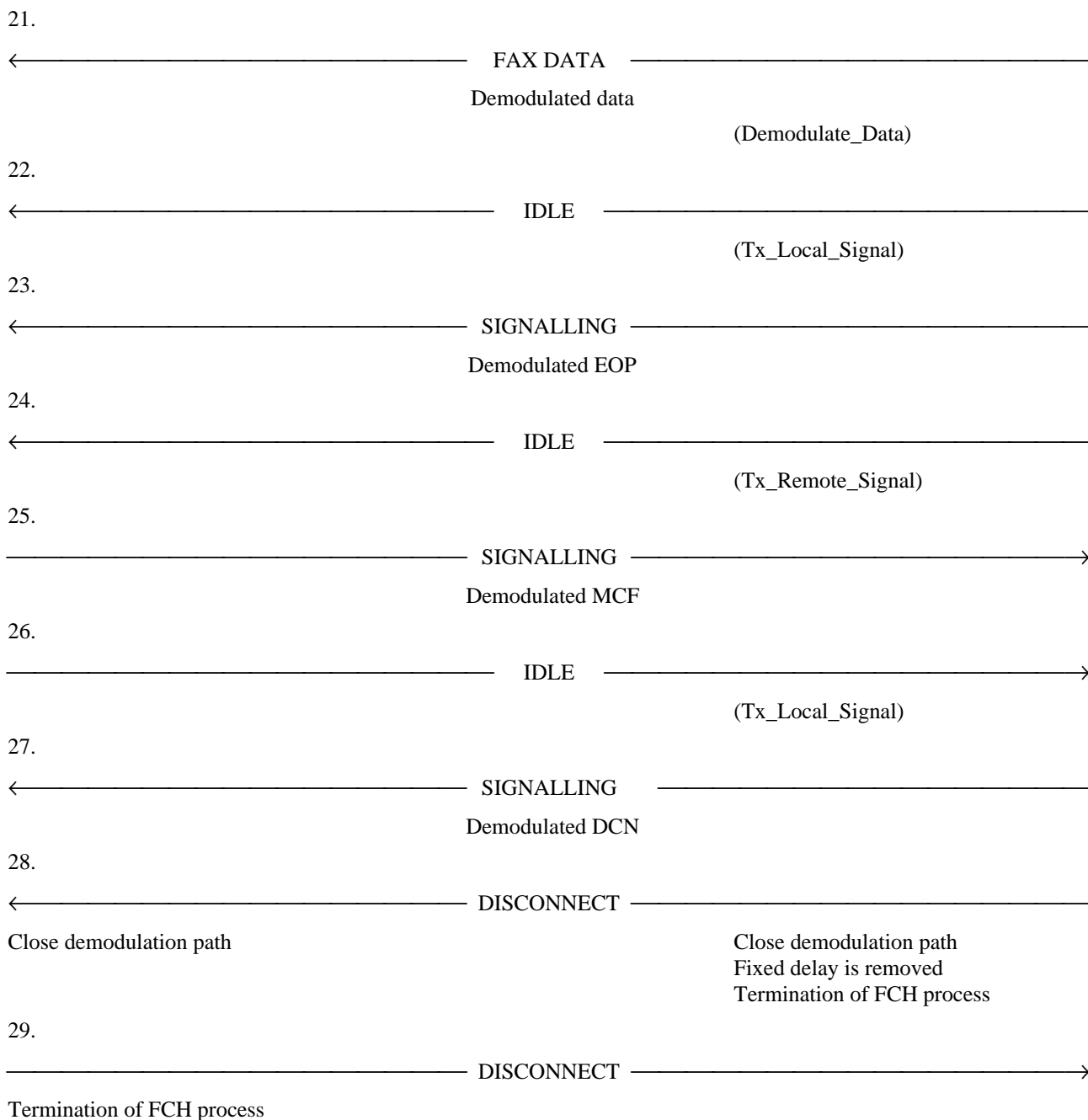

Case 7: WA calling – PA called, no polling, error (voice detection)

WA (Transmit, Calling)

PA (Receive, Called)

1. Call start

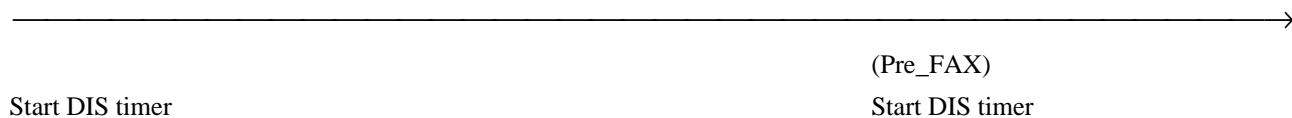

2. BEGINNING OF DIS (ADPCM)

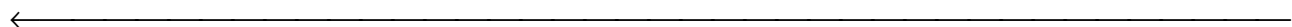

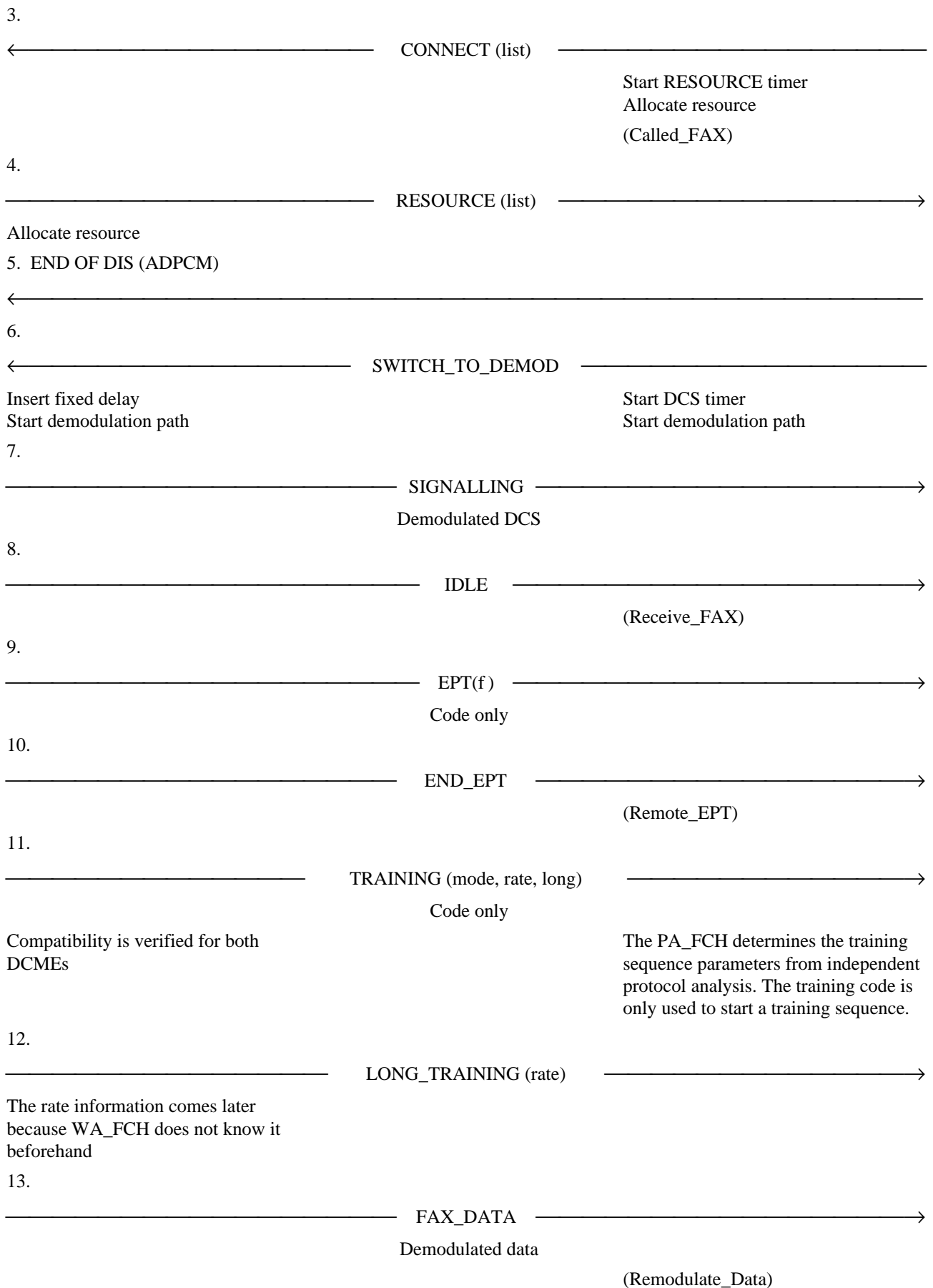

14.



No differentiation between data and TCF signals
 (Rx_Local_Signal)
 Voice is detected

15.



Delete fixed delay
 Close demodulation path

Close demodulation path
 Termination of FCH process

16.



Termination of FCH process

Case 8: WA calling – PA called, no polling, error (wrong rate)

WA (Transmit, Calling)

PA (Receive, Called)

1. Call start

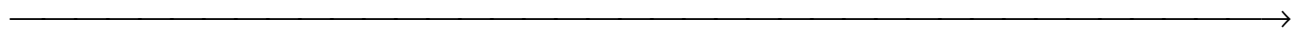

Start DIS timer

(Pre_FAX)

Start DIS timer

2. BEGINNING OF DIS (ADPCM)

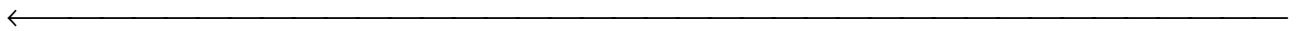

3.



Start RESOURCE timer
 Allocate resource
 (Called_FAX)

4.



Allocate resource

5. END OF DIS (ADPCM)

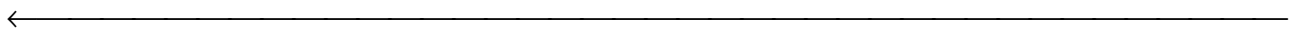

6.



Insert fixed delay
 Start demodulation path

Start DCS timer
 Start demodulation path

7.



Demodulated DCS

8.



(Receive_FAX)

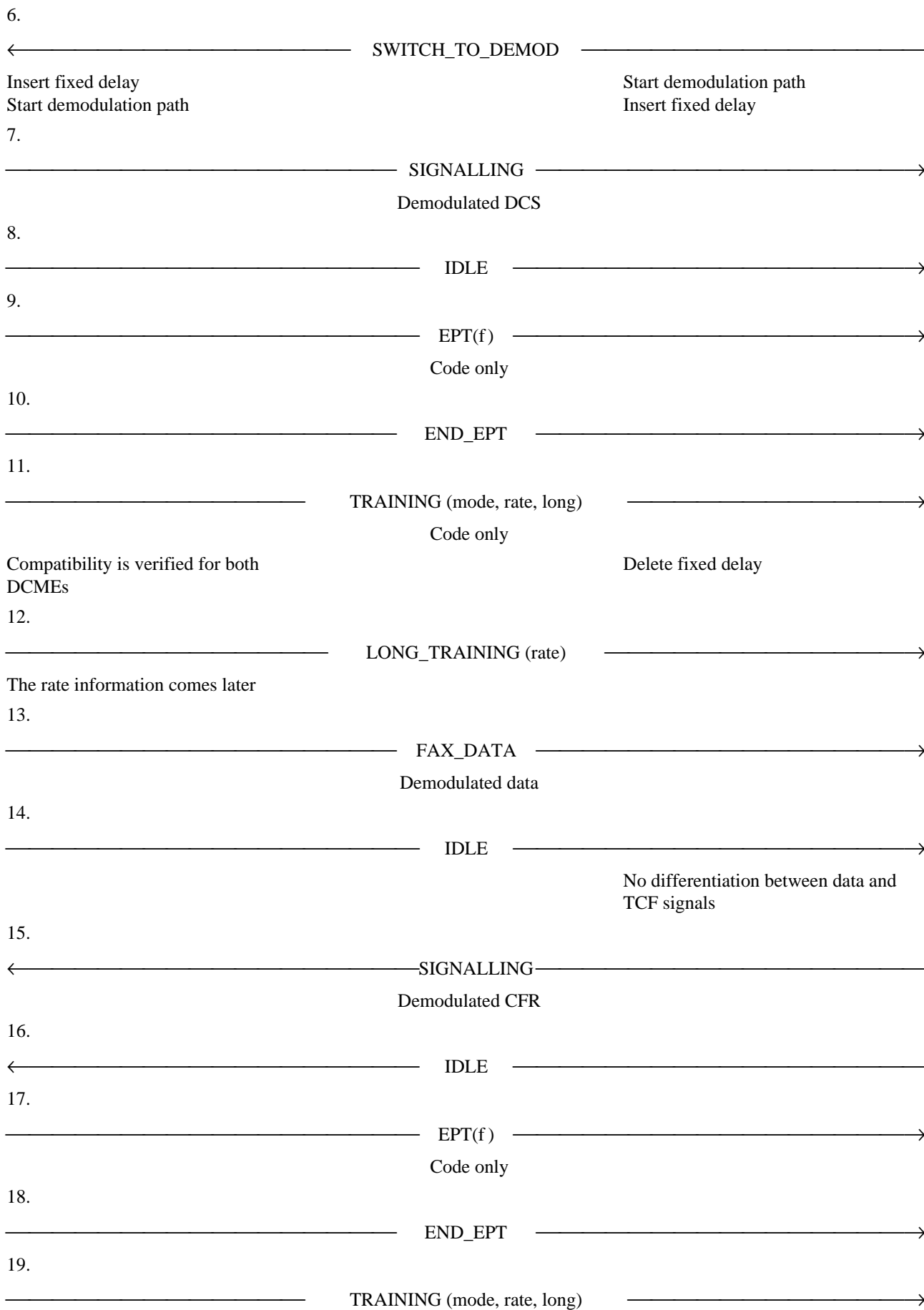

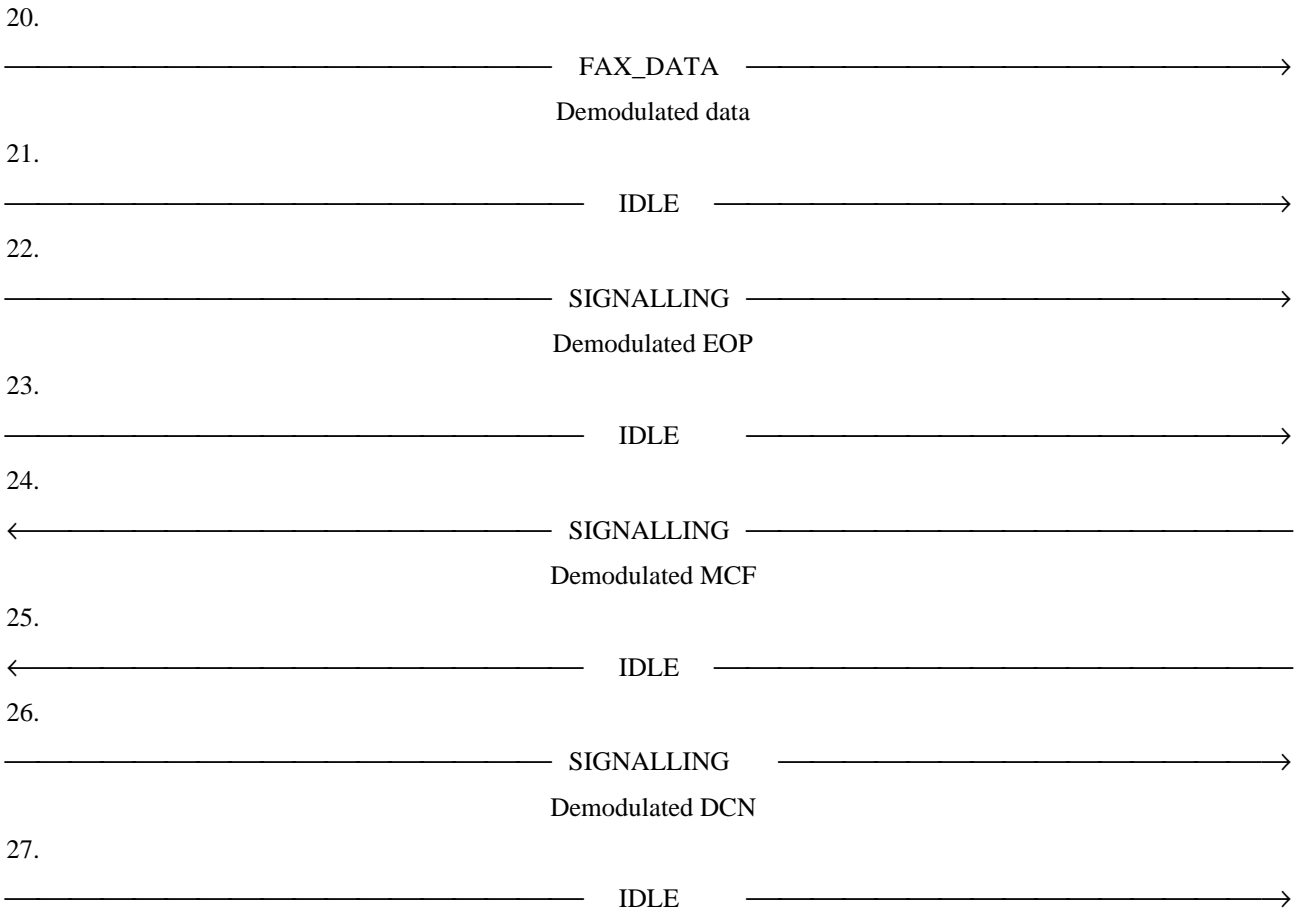

Since DCN signal is not decoded, the end of a call is known when:

- 1) data hangover timer (G.763) is expired; or
- 2) voice is detected.

The end of a call is known when:

- 1) data hangover timer (G.763) is expired; or
- 2) voice is detected; or
- 3) transparent request is received.

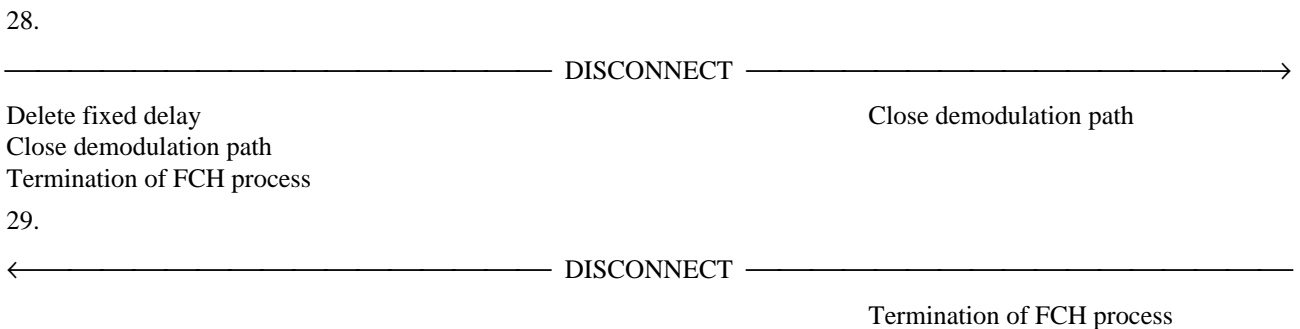

Case 10: WA-WA, polling

WA (Transmit, Called)

WA (Receive, Calling)

1. Call start

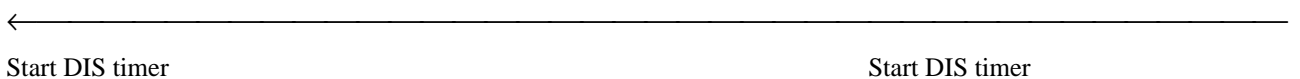

2. BEGINNING OF DIS (ADPCM)

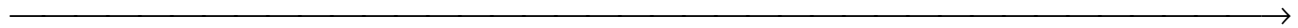

3.



Start RESOURCE timer
Allocate resource

4.



Allocate resource

5. END OF DIS (ADPCM)

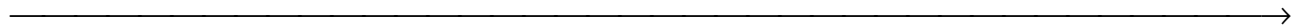

6.



Start demodulation path
Insert fixed delay

Start demodulation path
Insert fixed delay

7.



Demodulated DTC

8.



9.



Demodulated DCS

10.



NOTE – From now on, procedure is same as case 9, line 9.

A.2 NSF-T.30 proprietary cases with matched capabilities

Case 11: PA Calling – PA Called, no polling

PA (Receive, Called)

PA (Transmit, Calling)

1. Call start

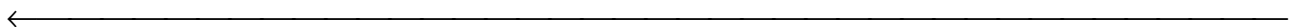

(Pre_FAX)

(Pre_FAX)

Start DIS timer

Start DIS timer

2. BEGINNING OF DIS (ADPCM)

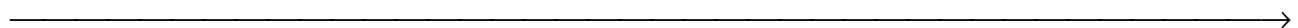

3.



Start resource timer
Allocate resource

(Called_FAX)

(Calling_FAX)

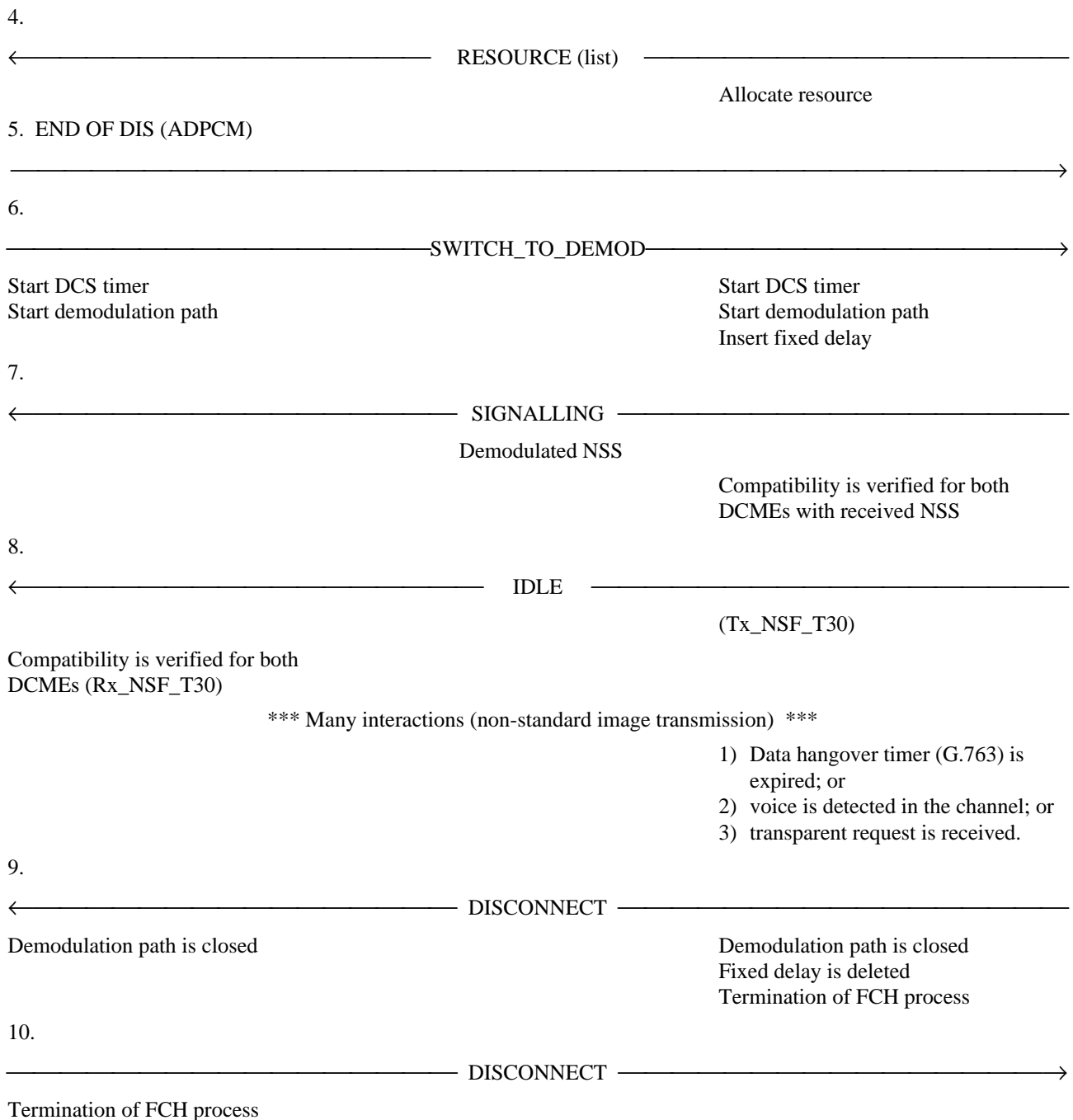

Case 12: PA Calling – WA Called, no polling

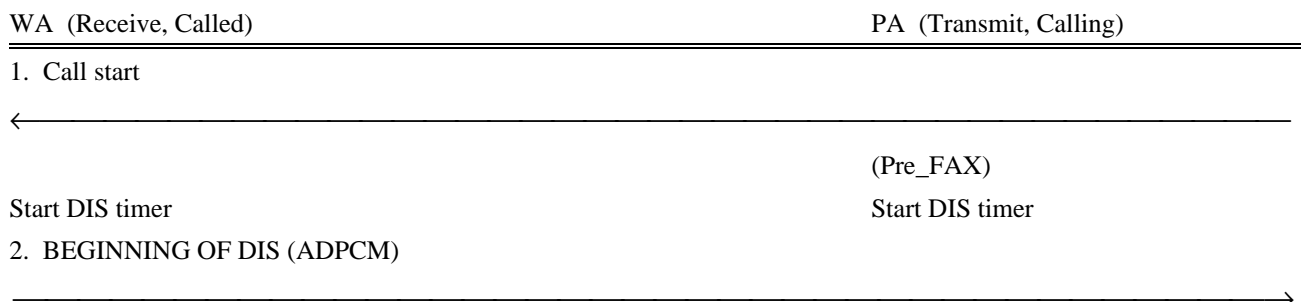

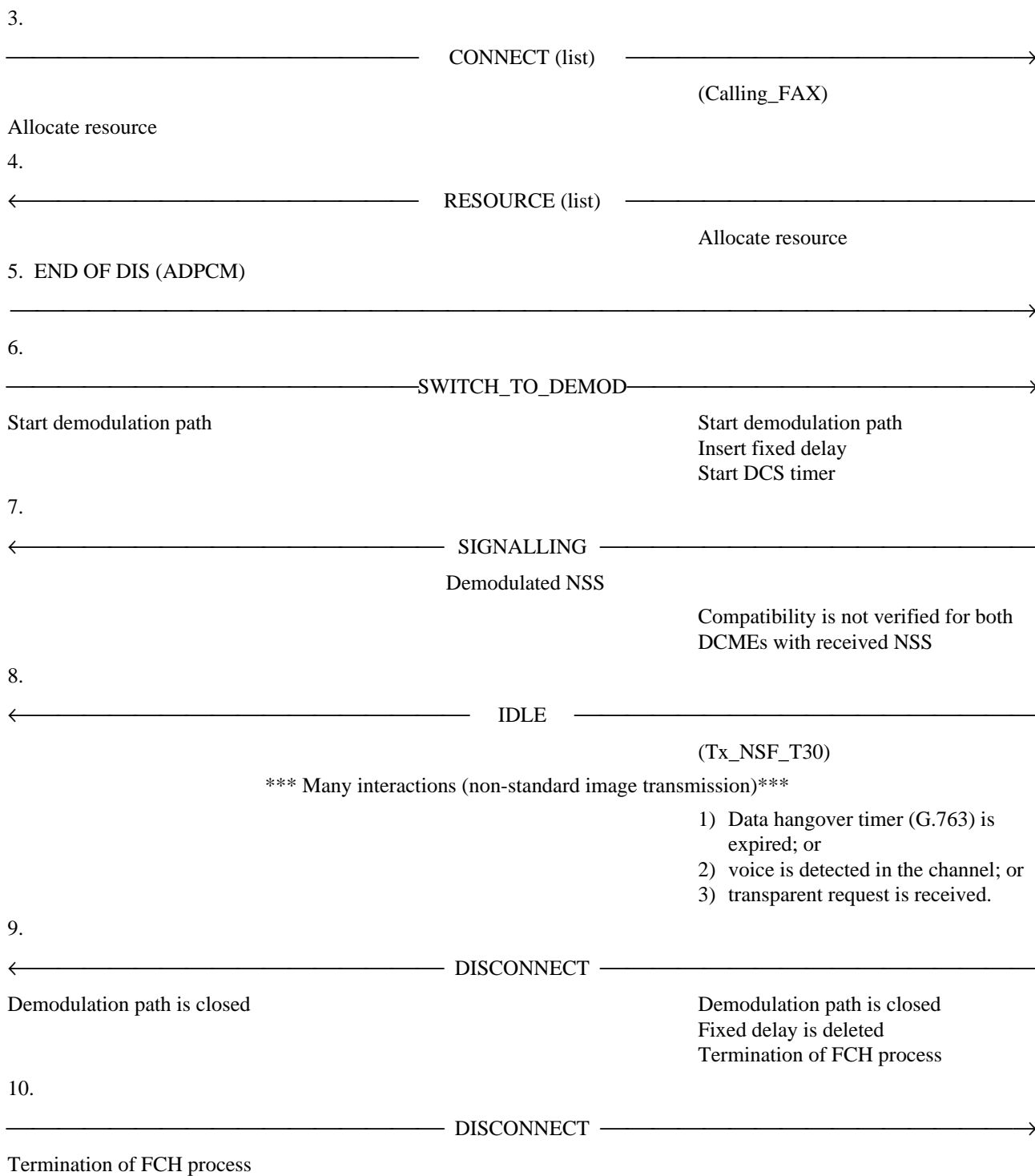

Case 13: WA Calling – PA Called, no polling

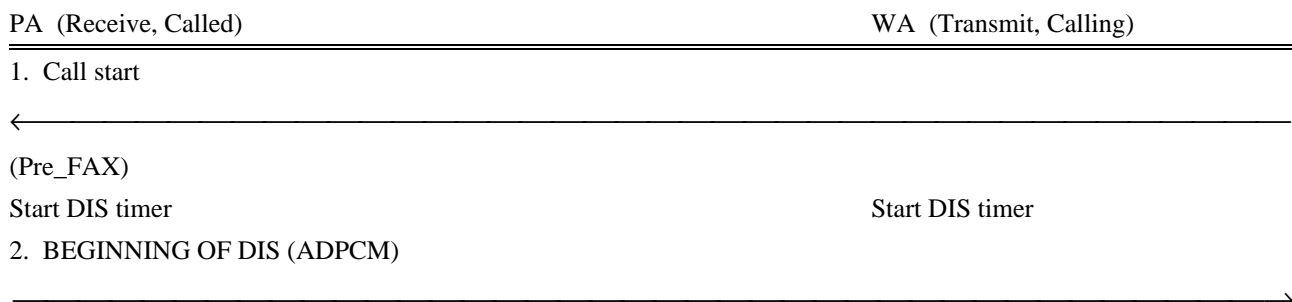

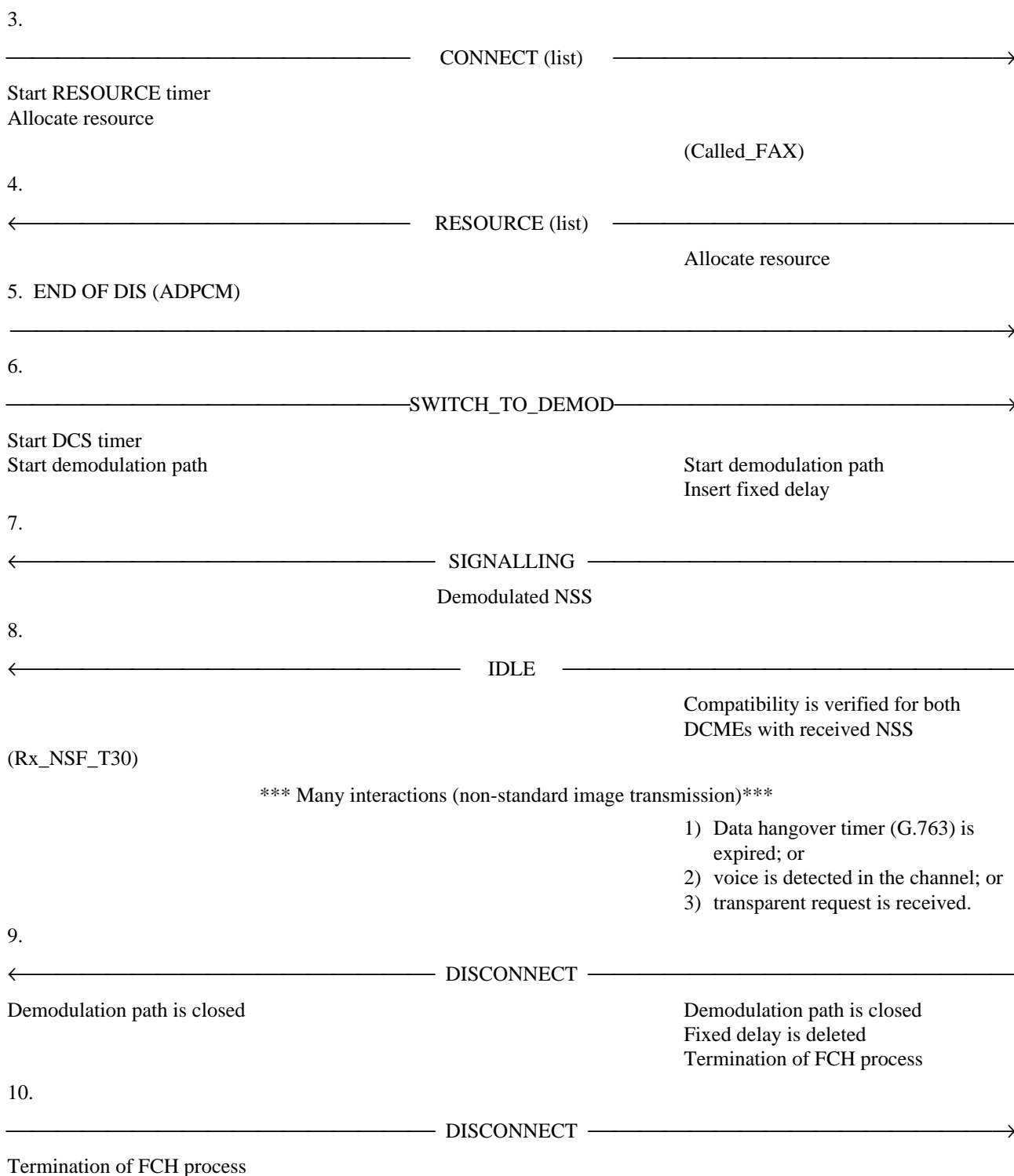

A.3 SF-T.30 cases with unmatched capabilities

Case 14: PA Calling – PA Called, no polling

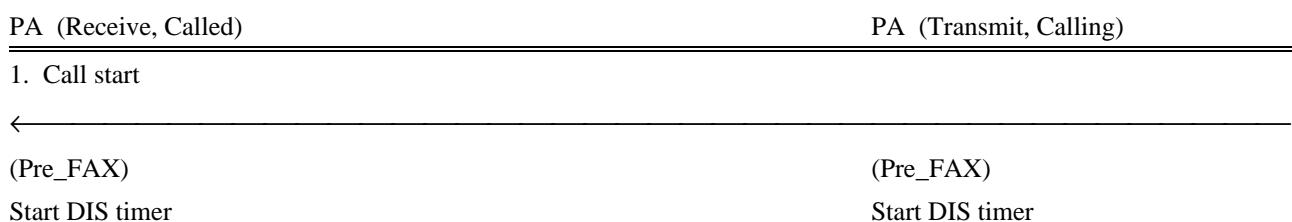

2. BEGINNING OF DIS (ADPCM)

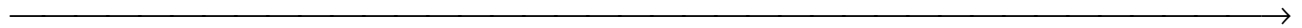

3.



CONNECT (list)

Start RESOURCE timer
Allocate resource
(Called_FAX)

4.



RESOURCE (list)

Allocate resource
(Calling_FAX)

5. END OF DIS (ADPCM)

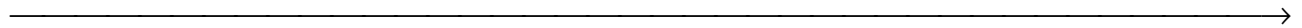

6.



SWITCH_TO_DEMOD

Start DCS timer
Start demodulation path

Start DCS timer
Start demodulation path
Insert fixed delay

7.



SIGNALLING

Demodulated DCS

Compatibility is not verified for both
DCMEs with received DCS

8.



SWITCH_TO_ADPCM

Switch to 40 kbit/s channel
Release resource
(Rx_ADPCM_FAX)

Switch to 40 kbit/s channel with fixed
delay
Release resource
(Tx_ADPCM_FAX)

*** Many interactions (call continues via ADPCM) ***

- 1) Data hangover timer (G.763) is expired; or
- 2) voice is detected in the channel; or
- 3) transparent request is received.

9.



DISCONNECT

The fixed delay is deleted
Termination of FCH process

10.



DISCONNECT

Termination of FCH process

Case 15: PA Calling – WA Called, no polling

WA (Receive, Called)

PA (Transmit, Calling)

1. Call start

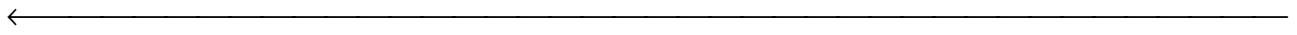

Start DIS timer

(Pre_FAX)

Start DIS timer

2. BEGINNING OF DIS (ADPCM)

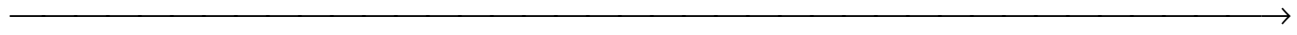

3.



CONNECT (list)

Start RESOURCE timer

Allocate resource

4.



RESOURCE (list)

Allocate resource

(Calling_FAX)

5. END OF DIS (ADPCM)

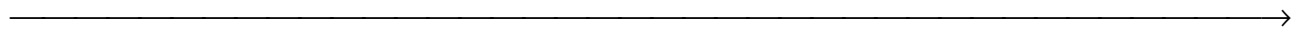

6.



SWITCH_TO_DEMOD

Insert fixed delay

Start demodulation path

Start DCS timer

Start demodulation path

Insert fixed delay

7.



SIGNALLING

Demodulated DCS

Compatibility is not verified for both DCMEs with received DCS

8.



SWITCH_TO_ADPCM

Switch to 40 kbit/s channel

Release resource

Delete delay

Switch to 40 kbit/s channel with fixed delay

Release resource

(Tx_ADPCM_FAX)

*** Many interactions (call continues using ADPCM) ***

1) Data hangover timer (G.763) is expired; or

2) voice is detected in the channel; or

3) transparent request is received.

9.



DISCONNECT

The fixed delay is deleted

Termination of FCH process

10.



Case 16: WA Calling – PA Called, no polling

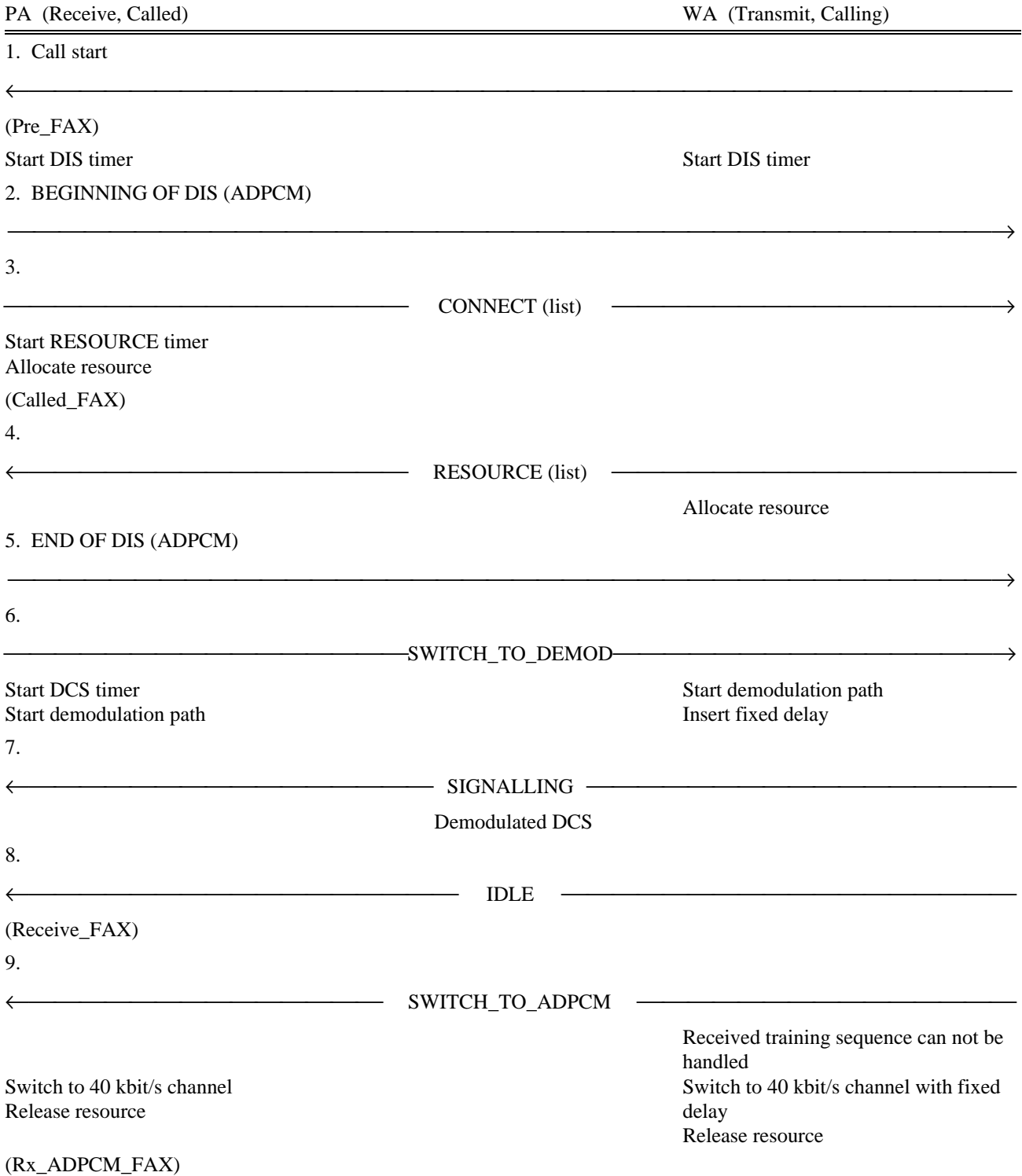

*** Many interactions (call continues via ADPCM) ***

- 1) Data hangover timer (G.763) is expired; or
- 2) voice is detected in the channel; or
- 3) transparent request is received.

10.



11.



A.4 NSF-T.30 proprietary cases with unmatched capabilities

Case 17: PA Calling – PA Called, no polling

PA (Receive, Called)

PA (Transmit, Calling)

1. Call start

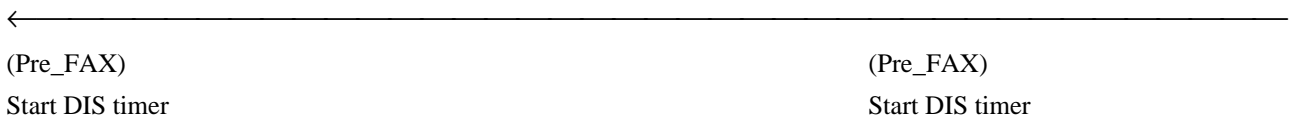

2. BEGINNING OF DIS (ADPCM)

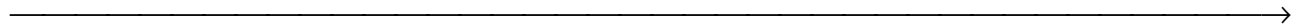

3.



Start RESOURCE timer
Allocate resource

(Called_FAX)

4.



Allocate resource
(Calling_FAX)

5. END OF DIS (ADPCM)

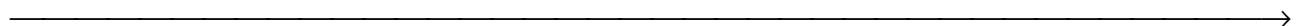

6.



Start DCS timer
Start demodulation path

Start DCS timer
Start demodulation path
Insert fixed delay

7.



Demodulated NSS

Compatibility is not verified for both
DCMEs with received NSS

8.

← SWITCH_TO_ADPCM →

Switch to 40 kbit/s channel
Release resource

Switch to 40 kbit/s channel with fixed delay
Release resource

(Rx_ADPCM_FAX)

(Tx_ADPCM_FAX)

*** Many interactions (call continues via ADPCM) ***

- 1) Data hangover timer (G.763) is expired; or
- 2) voice is detected in the channel; or
- 3) transparent request is received.

9.

← DISCONNECT →

Fixed delay is deleted
Termination of FCH process

10.

DISCONNECT →

Termination of FCH process

Case 18: WA Calling – WA Called, no polling

WA (Receive, Called)

WA (Transmit, Calling)

1. Call start

←

Start DIS timer

Start DIS timer

2. BEGINNING OF DIS (ADPCM)

→

3.

CONNECT (list) →

Start RESOURCE timer
Allocate resource

4.

← RESOURCE (list)

Allocate resource

5. END OF DIS (ADPCM)

→

6.

SWITCH_TO_DEMOD →

Start demodulation path
Insert fixed delay

Start demodulation path
Insert fixed delay

7.

← SIGNALLING

Demodulated NSS

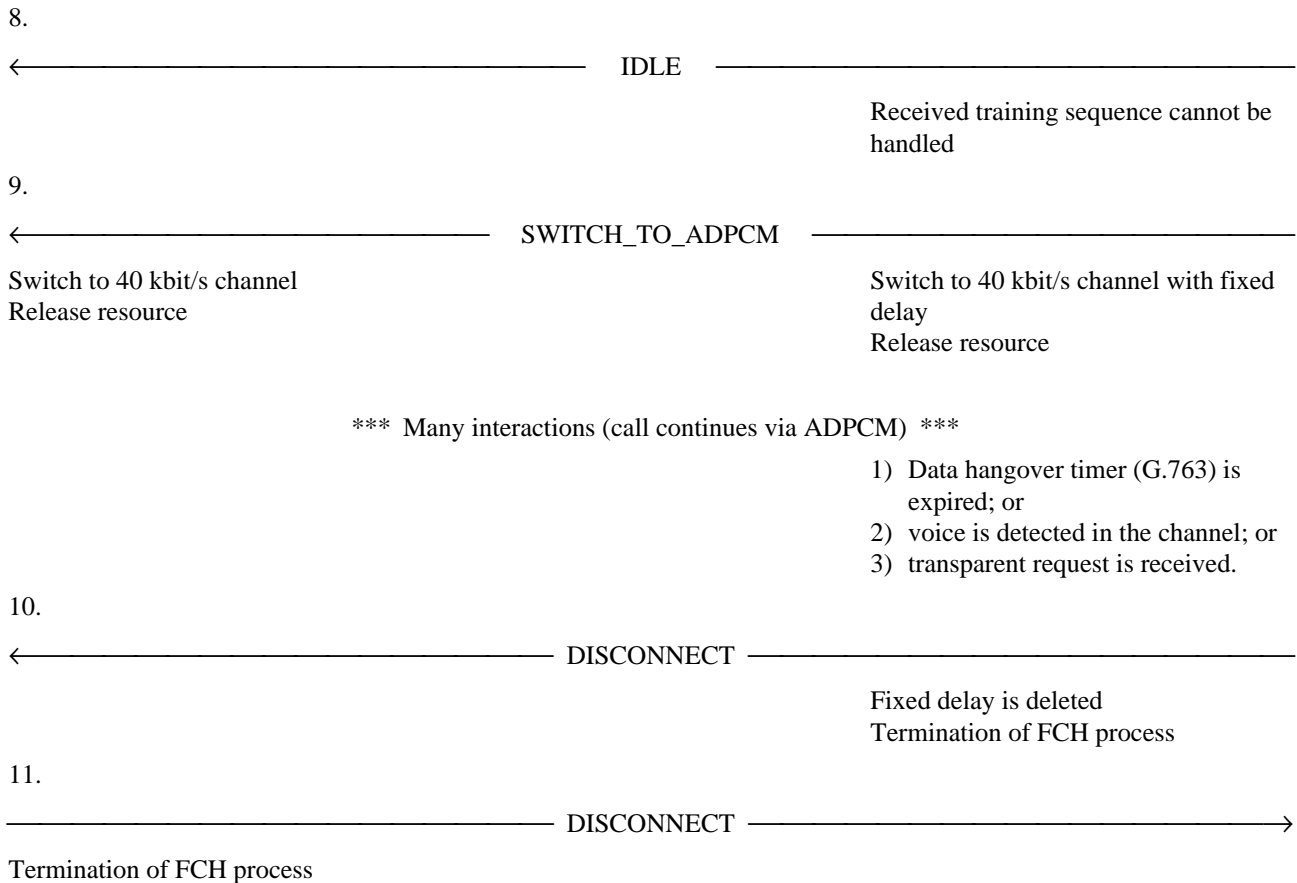

ANNEX B

Formal description of the facsimile module controller

B.1 Introduction

This annex provides a formal description, based on the use of the SDL language, of the interfaces and certain functions of the facsimile module controller FMC.

B.2 FMC interfaces

Figure B.1 shows the FMC and its interfaces with other DCME functions (ADF) and other facsimile module blocks. Signal lists L1 through L7 are defined, with the following origins/destinations (see Figure 9):

- L1: from ADF;
- L2: to ADF;
- L3: to analysis/demodulation block;
- L4: from analysis/demodulation block;
- L5: to fax assembler/disassembler;
- L6: from fax assembler/disassembler;
- L7: to remodulation block.

The message carried by the different signals are listed in Tables B.1 through B.11.

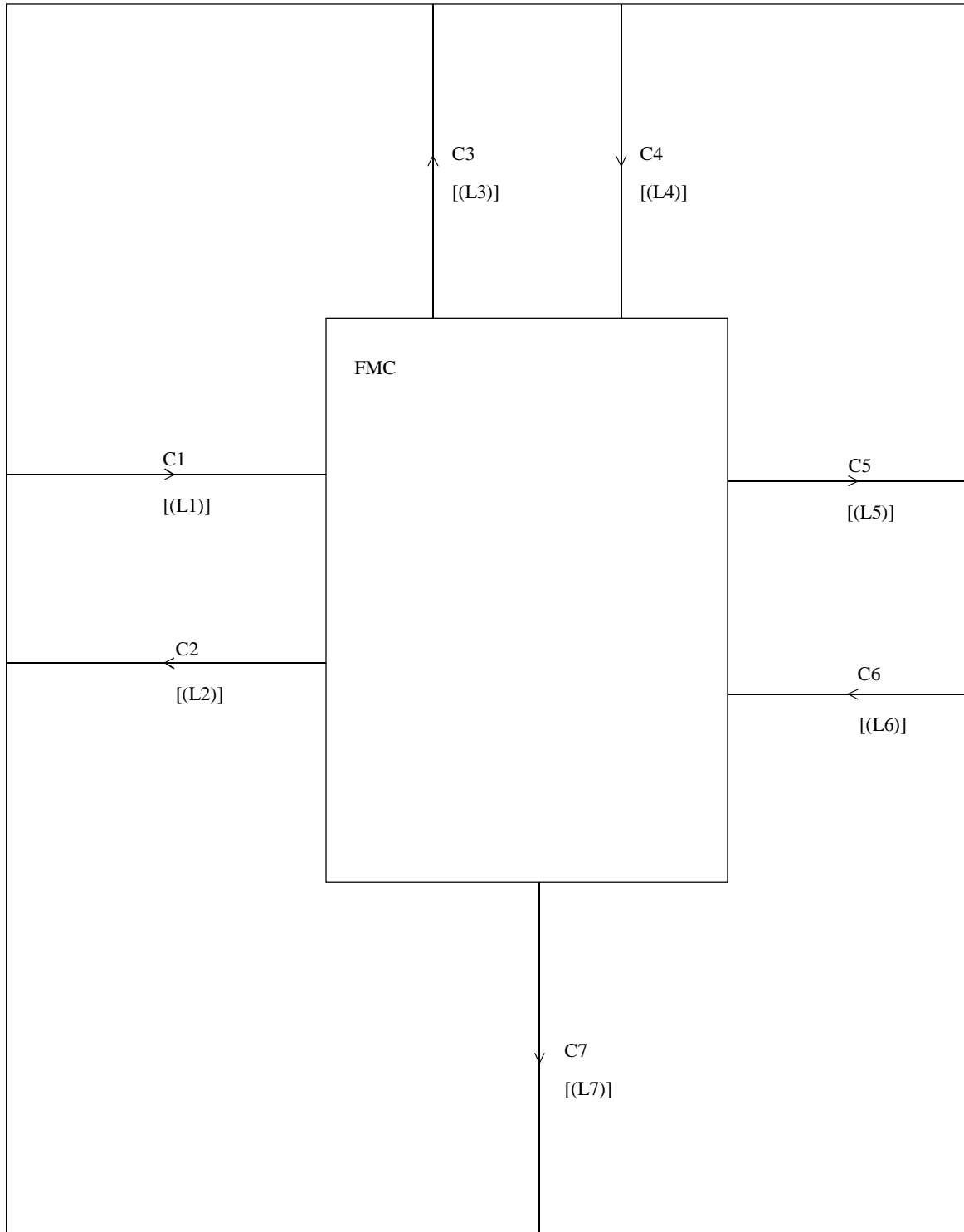

T1507290-92

Figure B.1/G.766 – FMC system diagram

Table B.1/G.766 – Signals received from the HSC process (L1)

Signals	Description
Data (ch)	Data call is detected in IT numbered as "ch".
DataInact (ch)	Data hangover timer is expired in IT numbered as "ch".
Voice (ch)	Voice call is detected in IT numbered as "ch".
Transp (ch)	Transparent call request is detected in IT numbered as "ch".
Rx_data (ch)	Data call is detected at receive side channel corresponding to IT numbered as "ch".

Table B.2/G.766 – Signals sent to the RAG process (L2)

Signals	Description
Faxbank_req	Request an additional fax bank to be created.
Faxbank_rel	Request to delete a fax bank.

Table B.3/G.766 – Signals sent to the HSC process (L2)

Signals	Description
Fax (ch)	Inform the HSC that the IT numbered as "ch" is now handled by the fax module (DSI processing is not needed).
Non_fax (ch)	Inform the HSC that the IT numbered as "ch" is now out of the fax module control (DSI processing is needed).
Switch_to_ADPCM (ch)	Inform the HSC that the IT numbered as "ch" could not be handled by the facsimile module and a 40 kbit/s ADPCM channel is needed.

Table B.4/G.766 – Signals sent to the O&M facility (L2)

Signal	Description
Alarm (ch)	Response from corresponding FCH did not arrive within the specified time.

Table B.5/G.766 – Signals sent to the demodulator switches (L3)
(Switch positions a, b, c as per Figure 11)

Signals	Switch number			Description
	1	2	3	
Demod_SW_1 (ch)	OFF a	OFF a	OFF (N/A) b	The signal goes through ADPCM path and no signal is diverted to demodulator.
Demod_SW_2 (ch)	OFF a	ON b	OFF (N/A) b	The signal still goes through ADPCM path but the same signal is also sent to demodulator to detect V.21 flag sequence.
Demod_SW_3 (ch)	ON b	ON b	OPEN a	The signal only goes through demodulator without the fixed delay.
Demod_SW_4 (ch)	ON b	ON b	OFF b	The signal only goes through demodulator with the fixed delay.
Demod_SW_5 (ch)	ON b	OFF a	ON c	The signal only goes through ADPCM path with the fixed delay.

Table B.6/G.766 – Signals sent to the remodulator switch (L3)
(Switch positions a, b as per Figure 11)

Signals	Switch number 4	Description
Remod_SW_1 (ch)	OFF a	The signal goes through ADPCM path.
Remod_SW_2 (ch)	b b	Flag_detect CONNECT

Table B.7/G.766 – Signals sent to the demodulator/decoder (L3)

Signals	Description
Start_demod (ch, demod, mode, rate)	Start sending the output of the demodulator number "demod" connected to IT number "ch" and modulation scheme of "mode" and speed of "rate" to frame assembler.
Stop_demod (ch, demod, mode, rate)	Stop sending the output of demodulator number "demod" to frame assembler.

Table B.8/G.766 – Signals received from demodulator/decoder (L4)

Signals	Description
Inact (ch, code, mode, rate)	When the end of signalling data is detected at the demodulator for an IT, demodulator decodes the signal and inserts IT number in "ch" name of code in "code", modulation scheme in "mode" and bit rate in "rate" variables of Inact signal. If only code is given, mode and rate variables contain "BLANK".
Low_speed (ch)	When low speed data is detected, demodulator generates this signal.
Fax_ept (ch, f)	When echo protection tone is detected, this signal is generated.
End_of_ept (ch)	When the end of echo protection tone is detected, this signal is generated.
Fax_Training (ch)	When training code is detected, this signal is generated.
End_of_Training (ch)	When the end of training is detected, this signal is generated.
Inact_Data (ch)	When the end of facsimile page data is detected, this signal is generated.
Flag_detect (ch)	When V.21 flag sequence is detected, this signal is generated.
End_of_DIS (ch)	When the end of DIS signal is detected, this signal is generated.

Table B.9/G.766 – Signals received from the FCH and relayed to the remote FCH (L5)

Signals	Description
CONNECT (ch, list)	When FCH detects DIS signal in the incoming signal from IT number "ch", this code is generated. It informs the corresponding FCH that a facsimile call is detected. The variable "list" contains the list of allocated remodulator set.
RESOURCE (ch, list)	This code is generated by FCH in response to CONNECT code. The list of allocated remodulator set is given in the "list" variable.
DISCONNECT (ch)	This code is generated when FCH detects the end of facsimile call.
SWITCH_TO_ADPCM (ch)	When FCH determines that a call can not be handled by itself, this code is generated. The signal path is changed from demodulation path to ADPCM path.
EPT (ch, f)	This signal requests the corresponding FCH to generate EPT tone with "f" frequency.
END_EPT (ch)	This signal indicates the end of EPT tone.
SIGNALLING (ch)	This signal indicates that demodulated supervisory data is started in fax data channel for IT number "ch".
IDLE (ch)	This signal indicates that demodulated page or supervisory data is ended in fax data channel for IT number "ch".
TRAINING (ch, mode, rate, long)	This signal requests the corresponding FCH to generate training sequence for IT number "ch" with modulation scheme of "mode" and speed of "rate". If logical variable "long" is "true", long training sequence shall be generated, otherwise short training sequence shall be generated. Receiving WA_FCH uses this information. The receiving PA_FCH does not use this information for the T.30 protocol. If long training sequence is given, "rate" variable is not available from WA_FCH.

Table B.9/G.766 – Signals received from the FCH and relayed to the remote FCH (L5) (concluded)

Signals	Description
FAX_DATA (ch)	When the end of training is detected, this code is generated. This code also indicates that the demodulated data is in fax data channel. The number of bits for this call is known by the corresponding FCH.
LONG_TRAINING (ch, rate)	This code contains rate information for the training sequence and is generated only by WA_FCH. The receiving PA_FCH ignores this code.
V_FAST (to be determined)	To be determined.
SWITCH_TO_DEMOD (ch)	This signal is generated at the end of non-demodulated DIS signal and indicates that a path change from ADPCM to Facsimile demod/remod shall occur for IT number "ch".

Table B.10/G.766 – Signals received from the fax frame disassembler (L6)

The list is the same as the codes exchanged between corresponding FCHs via their CCFs. In addition, when the reception of a supervisory message is completed, as signalled by the IDLE code, the frame disassembler decodes its content and passes it to the CCF.

Signal	Description
Fax_Idle (ch, code, mode, rate)	Variables "code", "mode" and "rate" are given by the decoder in the frame disassembler.

Table B.11/G.766 – Signals sent to the remodulator (L7)

Signals	Description
Start_remmod (ch, remod, mode, rate)	When CCF receives Start_remmod signal from FCH, CCF passes the signal to remodulator. The remodulator number is not specified in the FCH signal but it is given in CCF signal. This signal initiates remodulation of data sent from Frame reassembler to the remodulator "remod".
Stop_remmod (ch, remod, mode, rate)	When CCF receives Stop_remmod signal from FCH, CCF passes the signal to Remodulator. This signal stops remodulation of data at the remodulator "remod".
Start_EPT (ch, f)	This signal initiates the generation of EPT signal with frequency "f" for the IT number "ch".
Stop_EPT (ch)	This signal stops the generation of EPT signal for the IT number "ch".
Generate_Short_Training (ch, mode, rate)	This signal initiates the generation of short training sequence for IT number "ch" with modulation scheme of "mode" and speed of "rate".
Generate_Long_Training (ch, mode, rate)	This signal initiates the generation of long training sequence for IT number "ch" with modulation scheme of "mode" and speed of "rate".

B.3 Internal structure of the FMC

The FMC consists of the CCF and the FCH processes, as shown in Figure B.2. Signals L8 and L9 define the interfaces between these two processes. The messages carried by the two signals are listed in Tables B.12 through B.14.

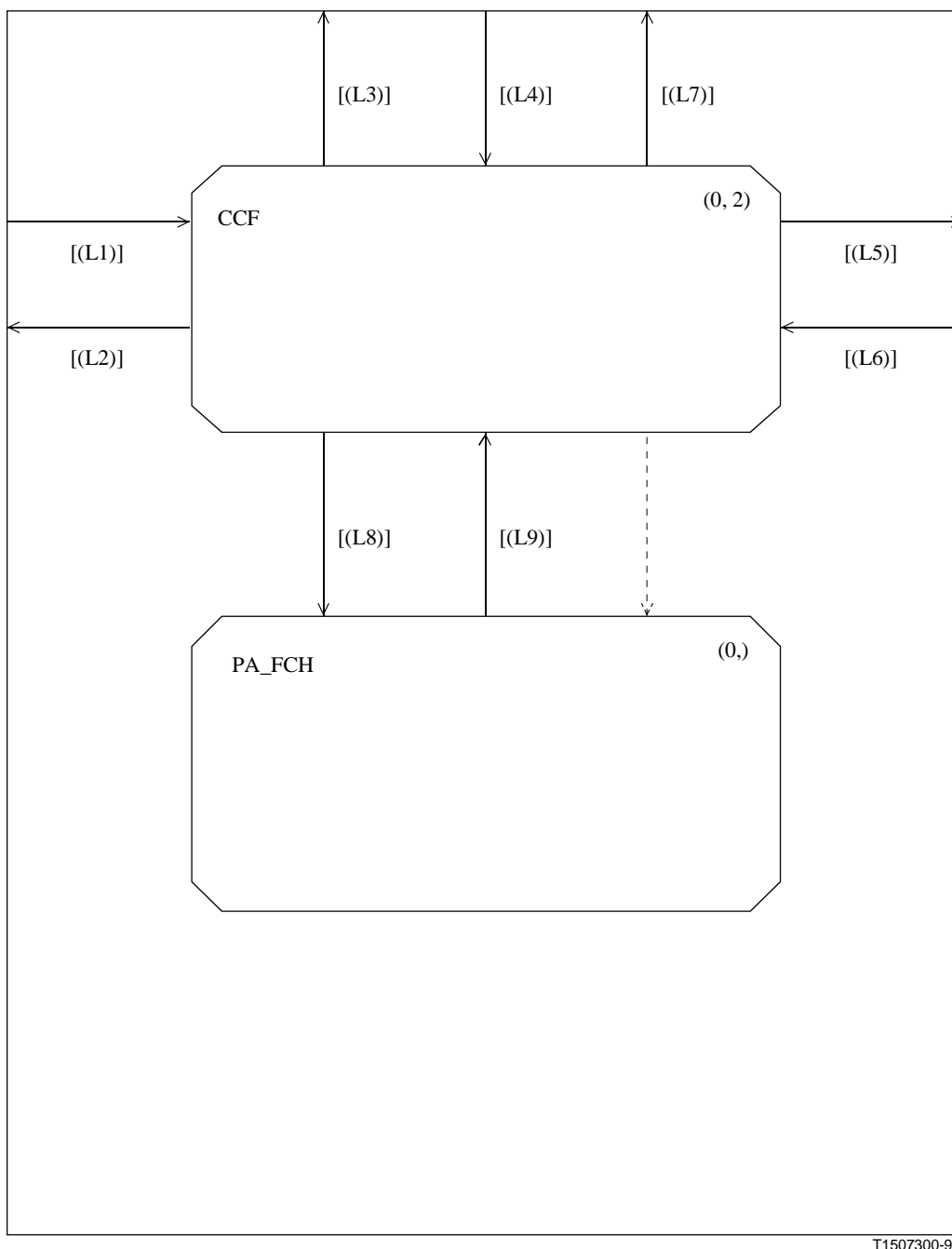

Figure B.2/G.766 – FMC block diagram

Table B.12/G.766 – Signals provided to the FCH (L8)

Signals	Table
(Signals are previously defined)	
DataInact (ch)	B.1
Voice (ch)	B.1
Transp (ch)	B.1
Inact (ch, code, mode, rate)	B.8
Low_speed (ch)	B.8
Fax_ept (ch, f)	B.8
End_of_Training (ch)	B.8
Inact_Data (ch)	B.8
Flag_detect (ch)	B.8
End_of_DIS (ch)	B.8
Fax_Idle (ch, code, mode, rate)	B.10
CONNECT (ch, list)	B.9
RESOURCE (ch, list)	B.9
DISCONNECT (ch)	B.9
SWITCH_TO_ADPCM (ch)	B.9
EPT (ch, f)	B.9
End_EPT (ch)	B.9
SIGNALLING (ch)	B.9
IDLE (ch)	B.9
TRAINING (ch, mode, rate, long)	B.9
FAX_DATA (ch)	B.9
LONG_TRAINING (ch, rate)	B.9
V_FAST	B.9
SWITCH_TO_DEMOD (ch)	B.9

Table B.13/G.766 – PA FCH control signals (L9)

Signals	Table
(Signals are previously defined)	
Fax (ch)	B.3
Non_fax (ch)	B.3
Switch_to_ADPCM (ch)	B.3
Demod_SW_1 (ch)	B.5
Demod_SW_2 (ch)	B.5
Demod_SW_3 (ch)	B.5
Demod_SW_4 (ch)	B.5

Table B.13/G.766 – PA FCH control signals (L9)
(concluded)

Signals	Table
Demod_SW_5 (ch)	B.5
Remod_SW_1 (ch)	B.6
Remod_SW_2 (ch)	B.6
Start_demod (ch, mode, rate)	B.7
Stop_demod (ch, mode, rate)	B.7
Start_remod (ch, mode, rate)	B.11
Stop_remod (ch, mode, rate)	B.11
Start_EPT (ch, f)	B.11
Stop_EPT (ch)	B.11
Generate_Short_Training (ch, mode, rate)	B.11
Generate_Long_Training (ch, mode, rate)	B.11
CONNECT (ch, list)	B.9
RESOURCE (ch, list)	B.9
DISCONNECT (ch)	B.9
SWITCH_TO_ADPCM (ch)	B.9
EPT (ch, f)	B.9
End_EPT (ch)	B.9
SIGNALLING (ch)	B.9
IDLE (ch)	B.9
TRAINING (ch, mode, rate, long)	B.9
FAX_DATA (ch)	B.9
LONG_TRAINING (ch, rate)	B.9
V_FAST	B.9
Alarm (ch)	B.4
SWITCH_TO_DEMOD (ch)	B.9

Table B.14/G.766 – Status signals received from FCH (L9)

Signals	Description
Calling (ch)	FCH informs CCF that it is a calling party.
Called (ch)	FCH informs CCF that it is a called party.
Transmit (ch)	FCH informs CCF that it is a facsimile page transmitting party.
Receive (ch)	FCH informs CCF that it is a facsimile page receiving party.
Terminate (ch)	FCH informs CCF that the process is terminating.

B.4 Common control function (CCF)

The functions of the CCF are defined in 6.1.

B.5 FCH

The FCH requirements are specified in 6.2. The SDL representation of the PA FCH is provided here. Figure B.3 shows an overall state transition diagram for the PA FCH. Tables B.15 and B.16 define

the protocol variables and the procedures, respectively. The SDL connector is given in Table B.17. The SDL representation of the PA FCH is provided by 25 SDL diagrams.

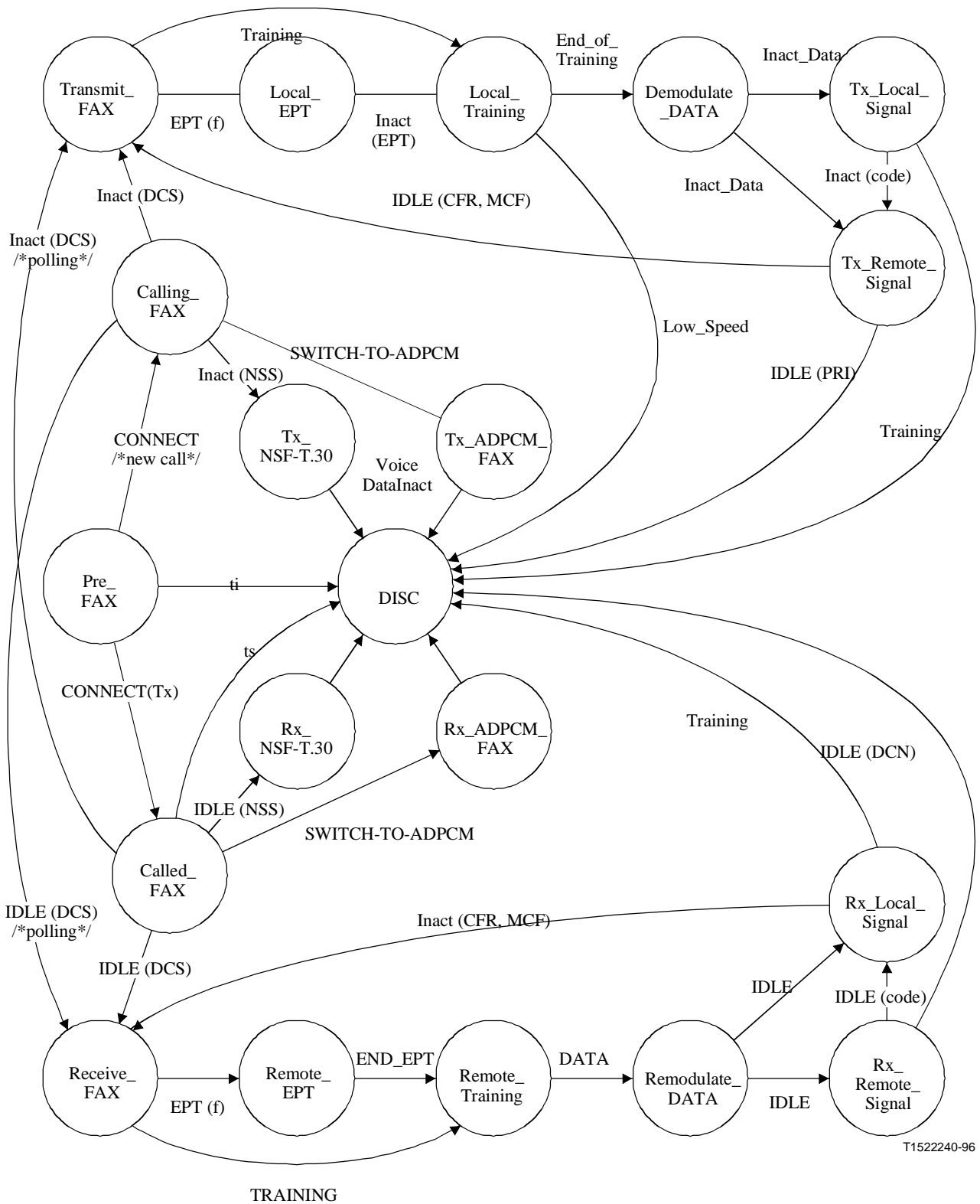

Figure B.3/G.766 – FCH for the PA approach

Table B.15/G.766 – Definition of the PA FCH variables and timers

Variables and timers	Definitions
t_DIS	DIS timer value (15 s).
ti	DIS timer variable.
t_DCS	DCS timer value (15 s).
td	DCS timer variable.
t_RES	RESOURCE code reception timer value (3 s).
ts	RESOURCE code reception timer variable.
t_EPT	EPT length value (1 s).
te	EPT timer variable.
code	A variable to hold current supervisory code.
sig_mode	Supervisory signal modulation scheme.
sig_rate	Supervisory signal rate.
prev	The variable holding previous signalling code.
PPR_count	PPR command counter.
long	The logical variable for training. It is "true" for the long training sequence and "false" for the short training sequence.
data_training	A logical variable. If "true" the expected signal is a facsimile page data, else TCF sequence is expected.

Table B.16/G.766 – Definition of the PA FCH procedures

Procedures	Definitions
Allocate_Resource (list)	This procedure allocates remodulators and puts the names of remodulators in the "list".
Release_Resource (list)	This procedure releases all allocated remodulators and demodulators. The names of remodulators are given in the "list".
Save_List (list)	This procedure stores the received remodulator list from remote PA_FCH process.
Capability_Check (Proceed)	When NSF-T.30 protocol is detected, PA_FCH process checks its capability. if this call can be handled, the variable "proceed" is set to "true", else "false".
Check_Resource (Proceed)	When DCS is detected, it examines its demodulation and remodulation capability with the remote remodulator list and determines if a facsimile call can be handled or not. If PA_FCH can handle a call, the variable "Proceed" is set "true", else "false". If the DCS includes 2400 bit/s handshaking, a variable "proceed" shall be set to "false".
Tx_NSF_T30_Handling	When NSF-T.30 protocol is accepted, this procedure handles the protocol. There is no restriction how to handle the call as long as the output signals are restricted to the defined codes as specified in Table B.10.
Rx_NSF_T30_Handling	When NSF-T.30 protocol is accepted, this procedure handles the protocol. It accepts all signals and acts upon without decoding the code. When TRAINING code is received, "long" variable is taken as is.
Store (list)	When RESOURCE code is received, the list of remote remodulator is stored by this procedure.

Table B.17/G.766 – SDL connector

rdx	From SDL-(n)	To SDL-(n)
1	14, 22	3
2	4, 23	13
3	16, 18, 20	23
4	18, 23	20
5	12	10
6	6, 10	12
7	10	11
8	20	21
9	6	8
10	16	18
11	21	22

DCL
send_DISC boolean,
Data_training boolean,
long boolean,
ch, list integer,
pre, level boolean,
code, precede boolean;

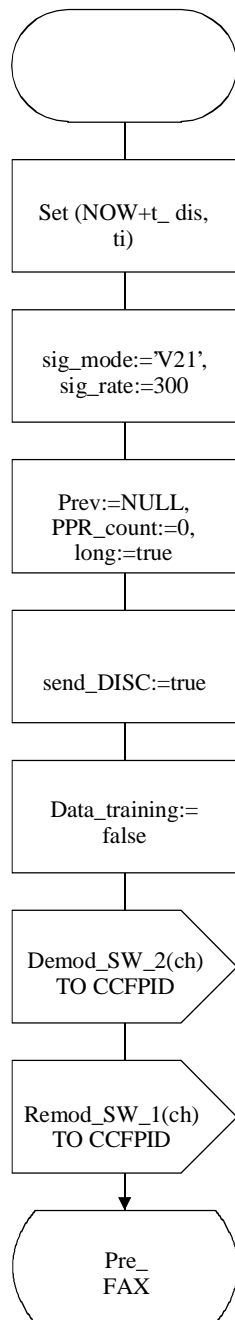

T1522250-96

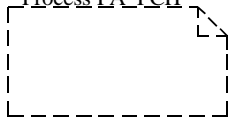

/* DIS timer expiration */

Pre_FAX

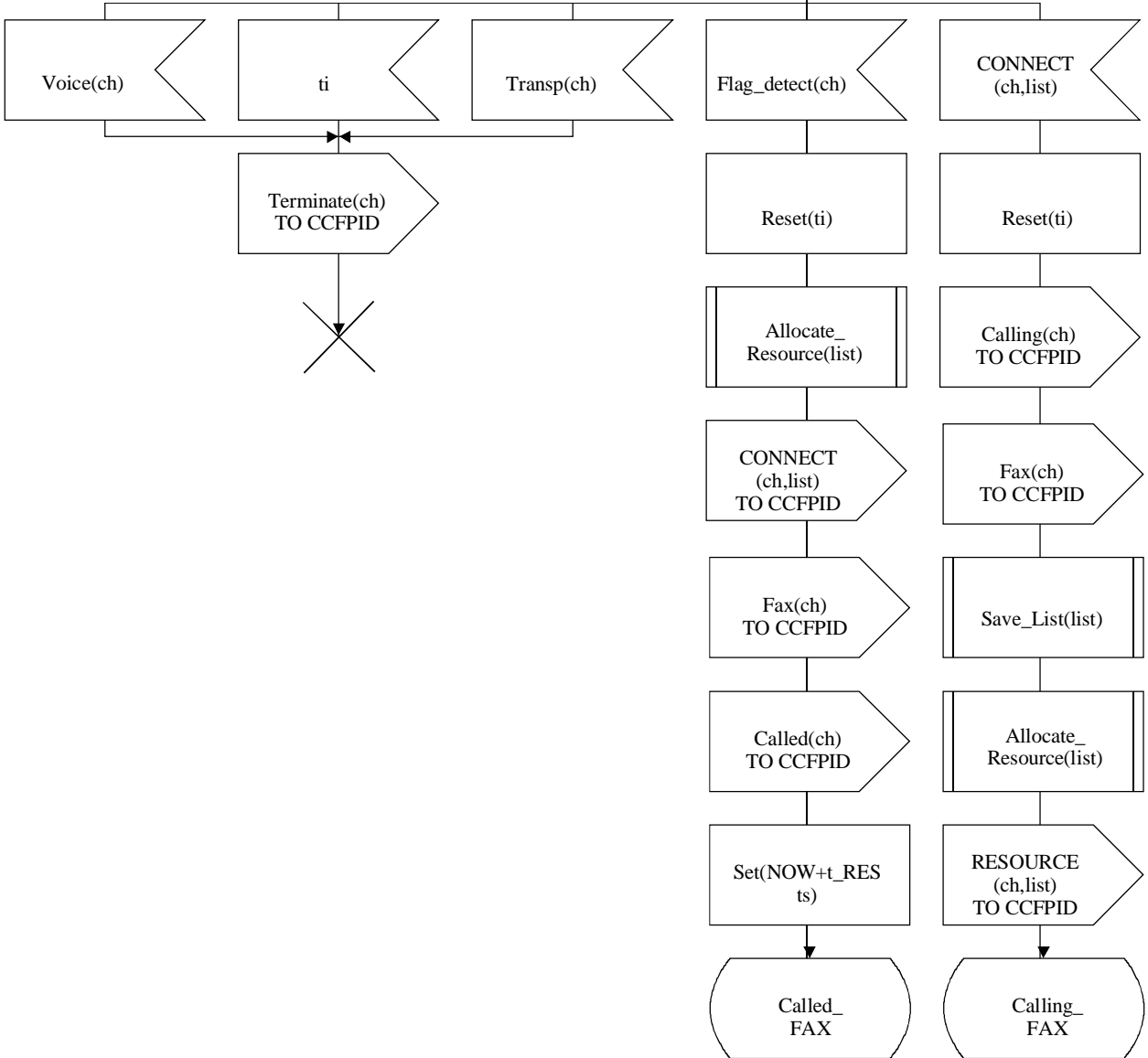

T1522260-96

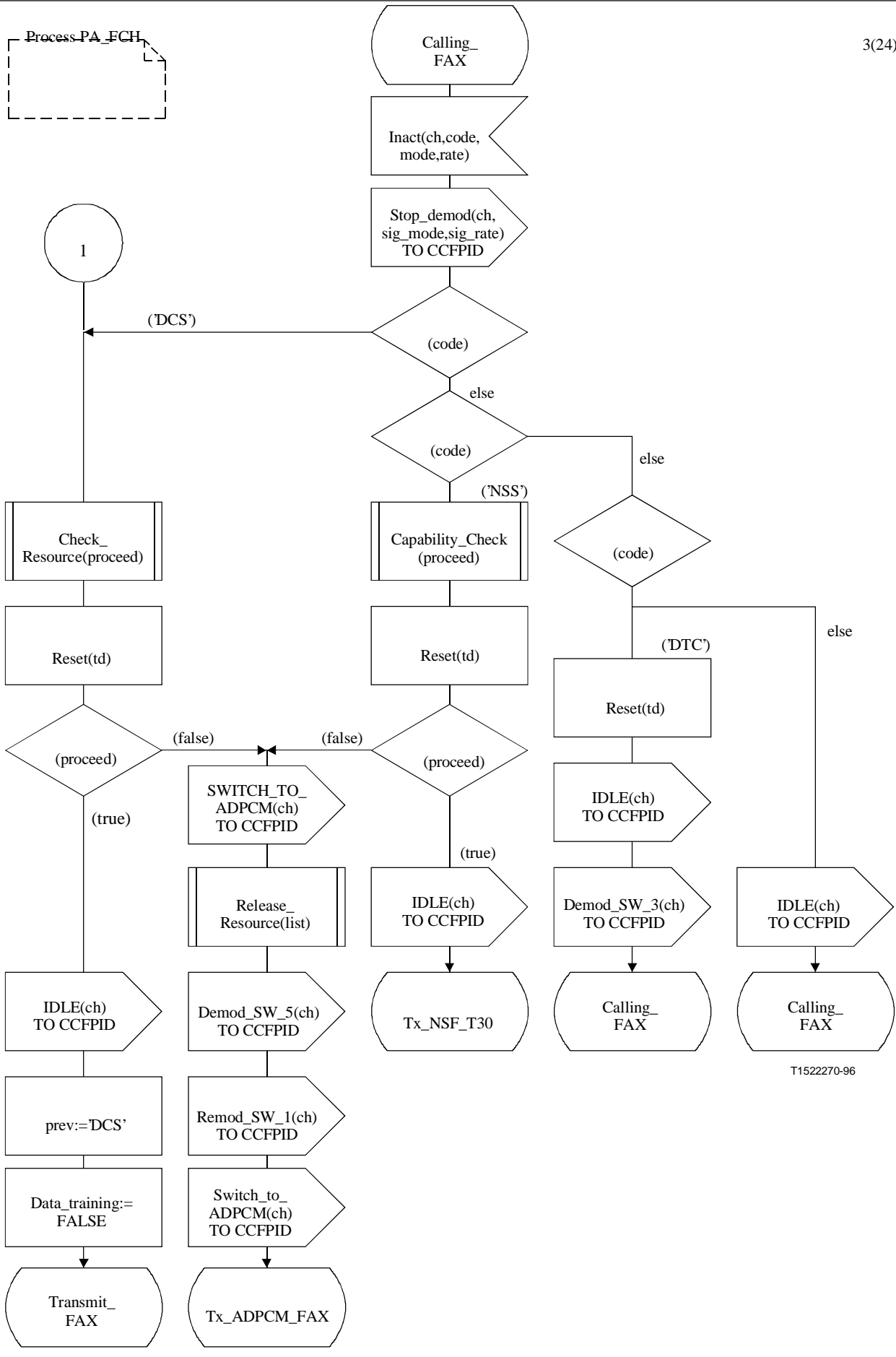

T1522270-96

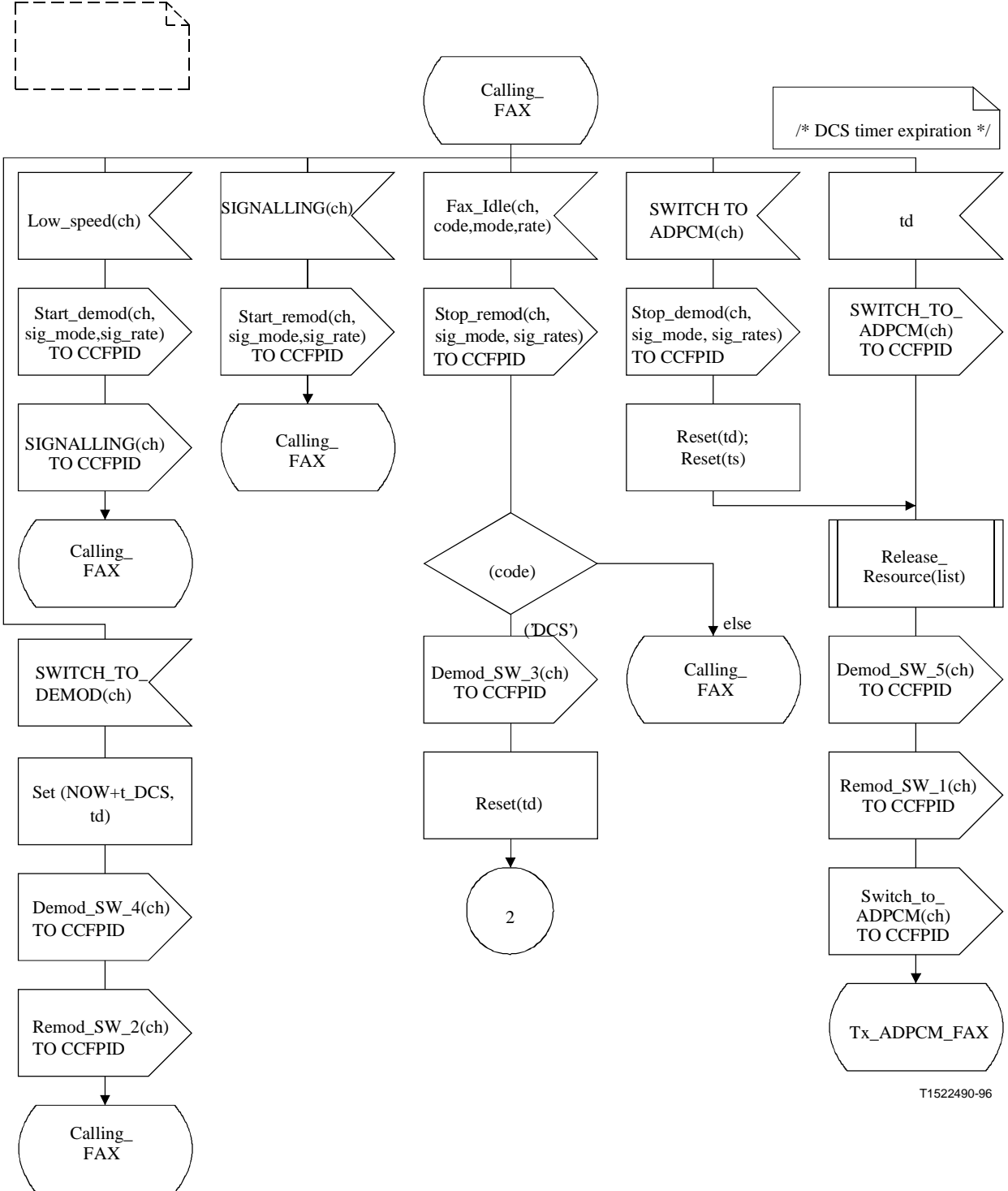

T1522490-96

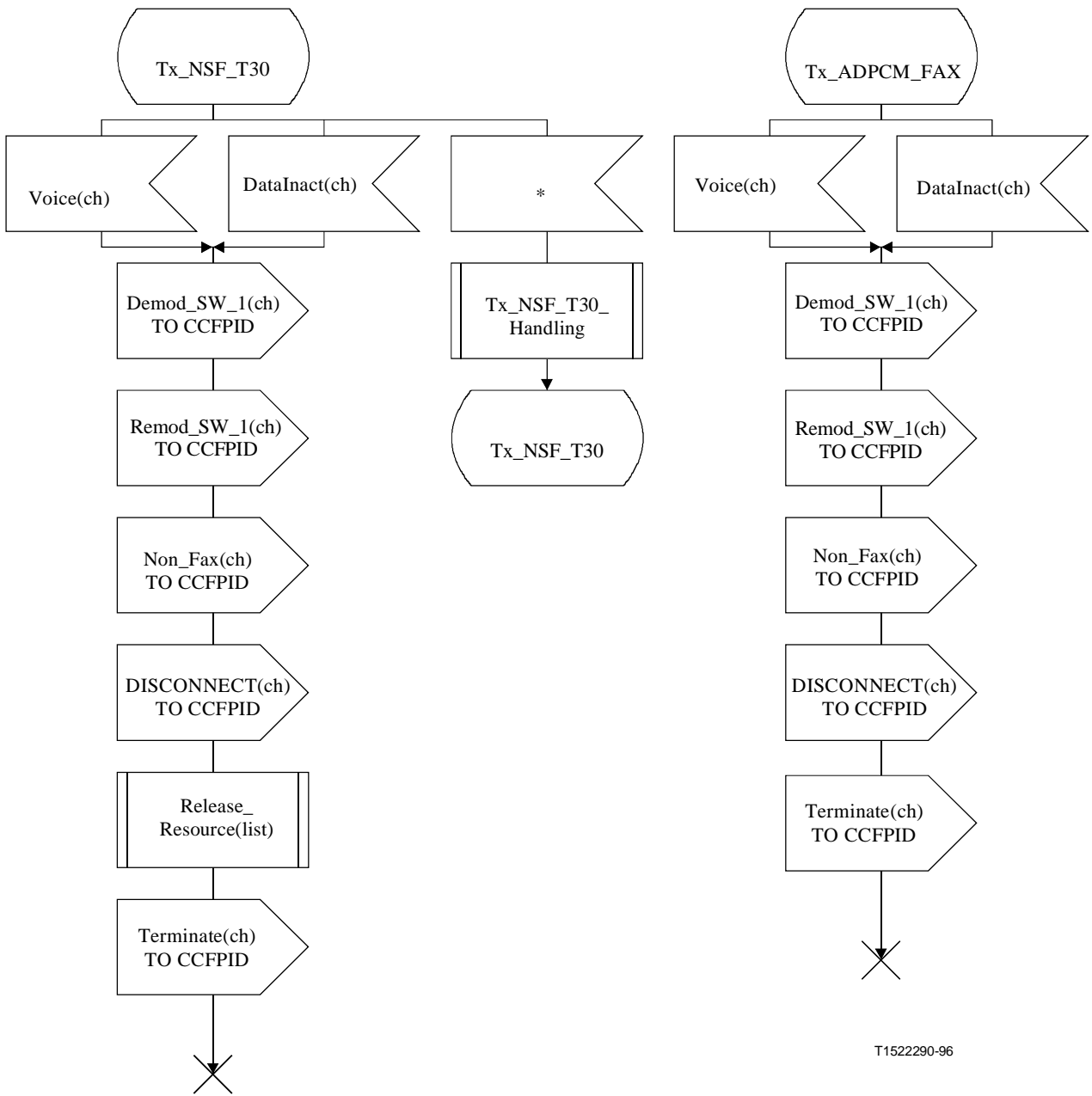

T1522290-96

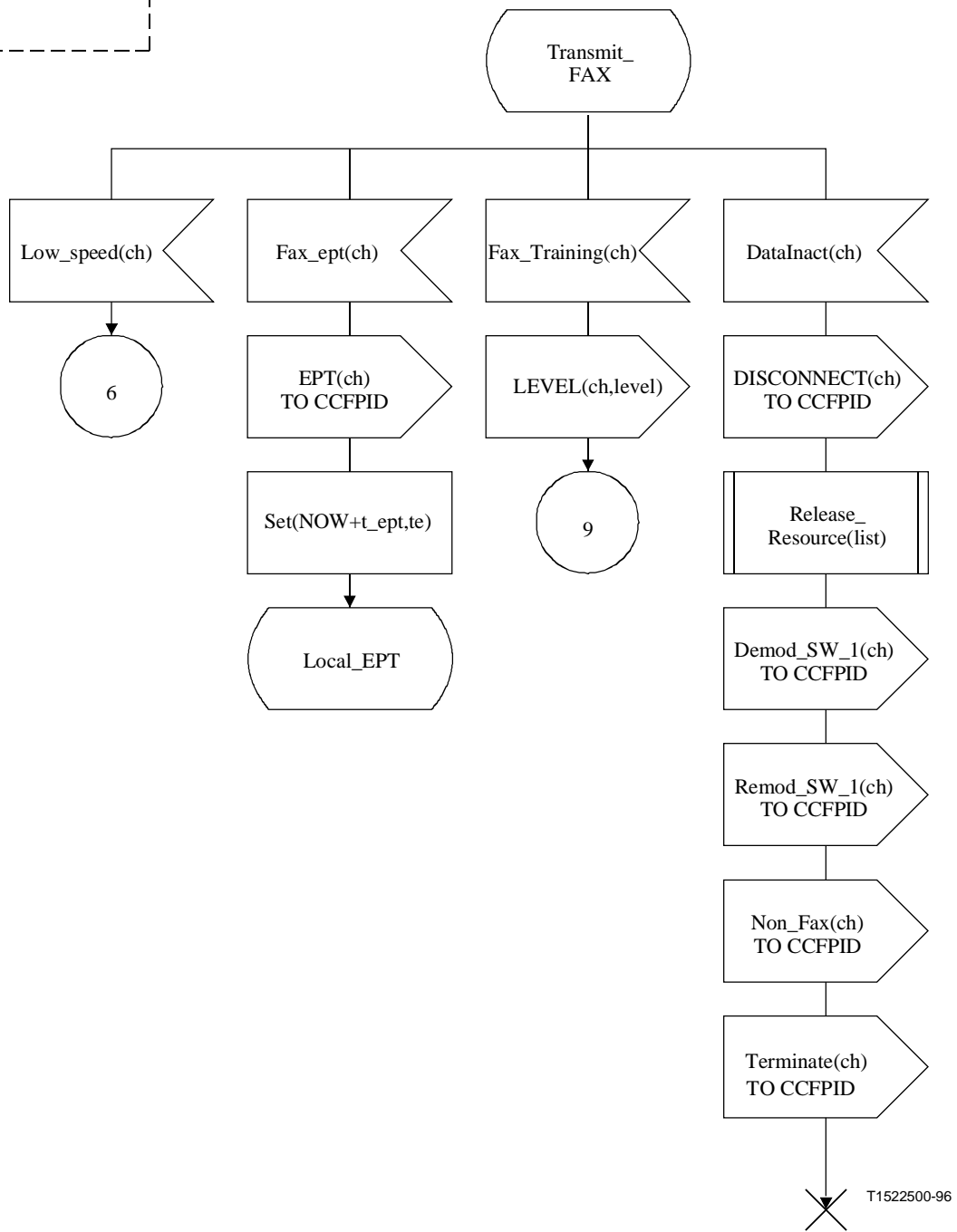



/* EPT timer expiration */

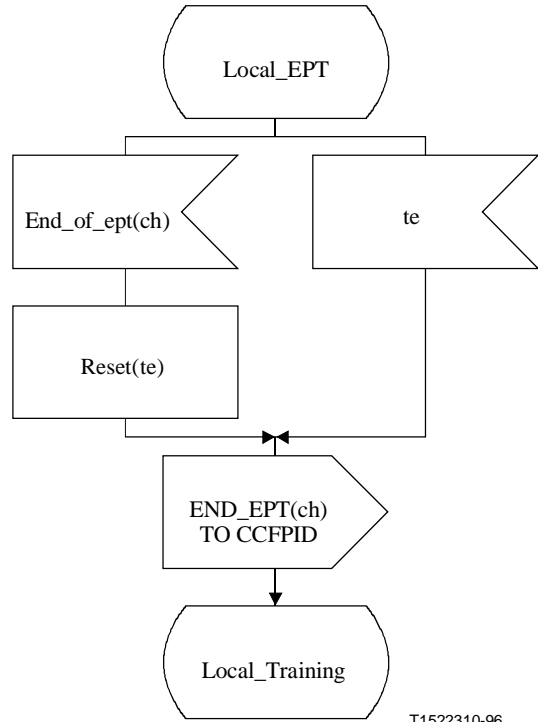

T1522310-96

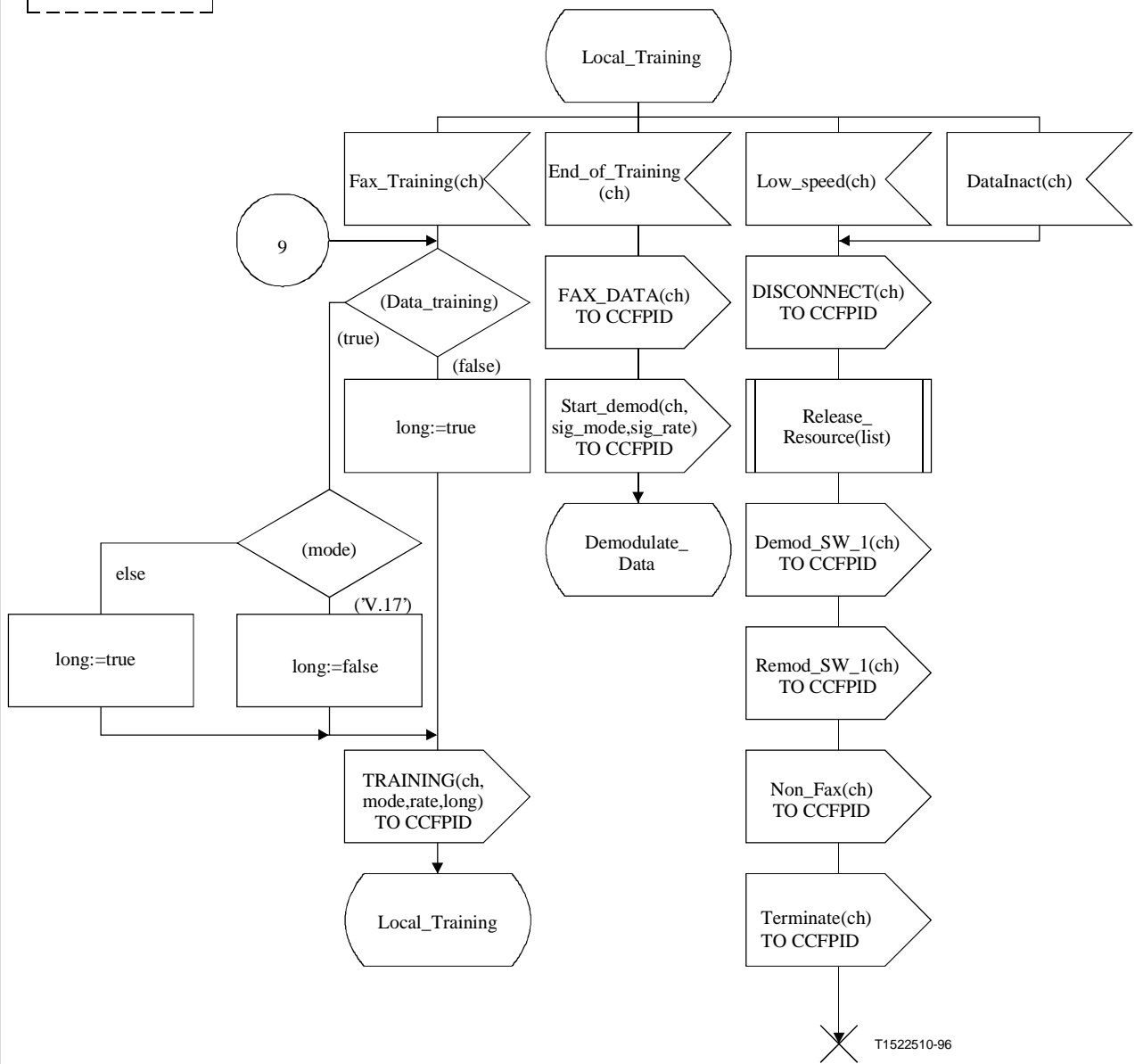

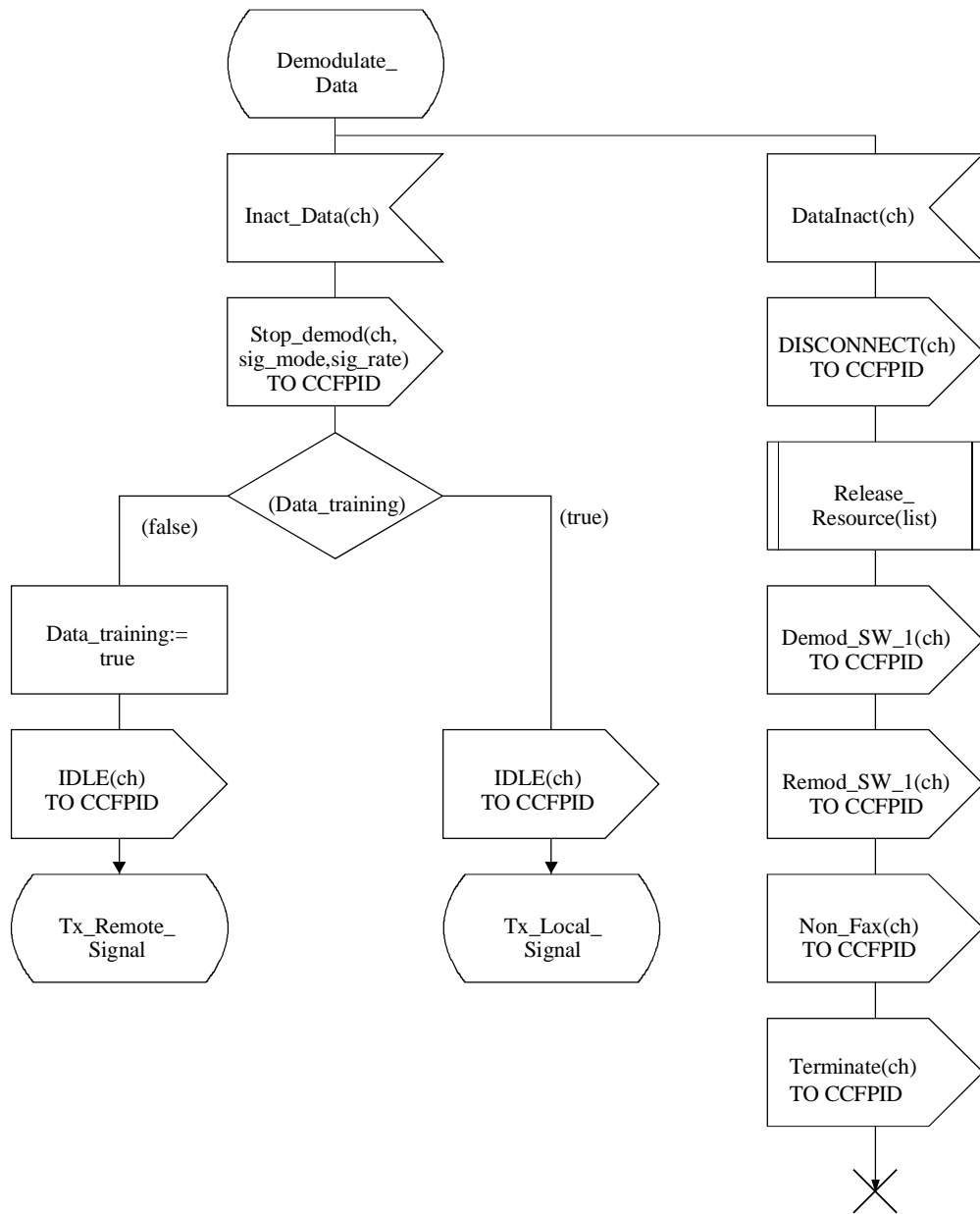
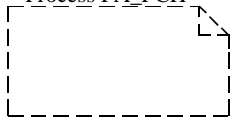

T1522330-96

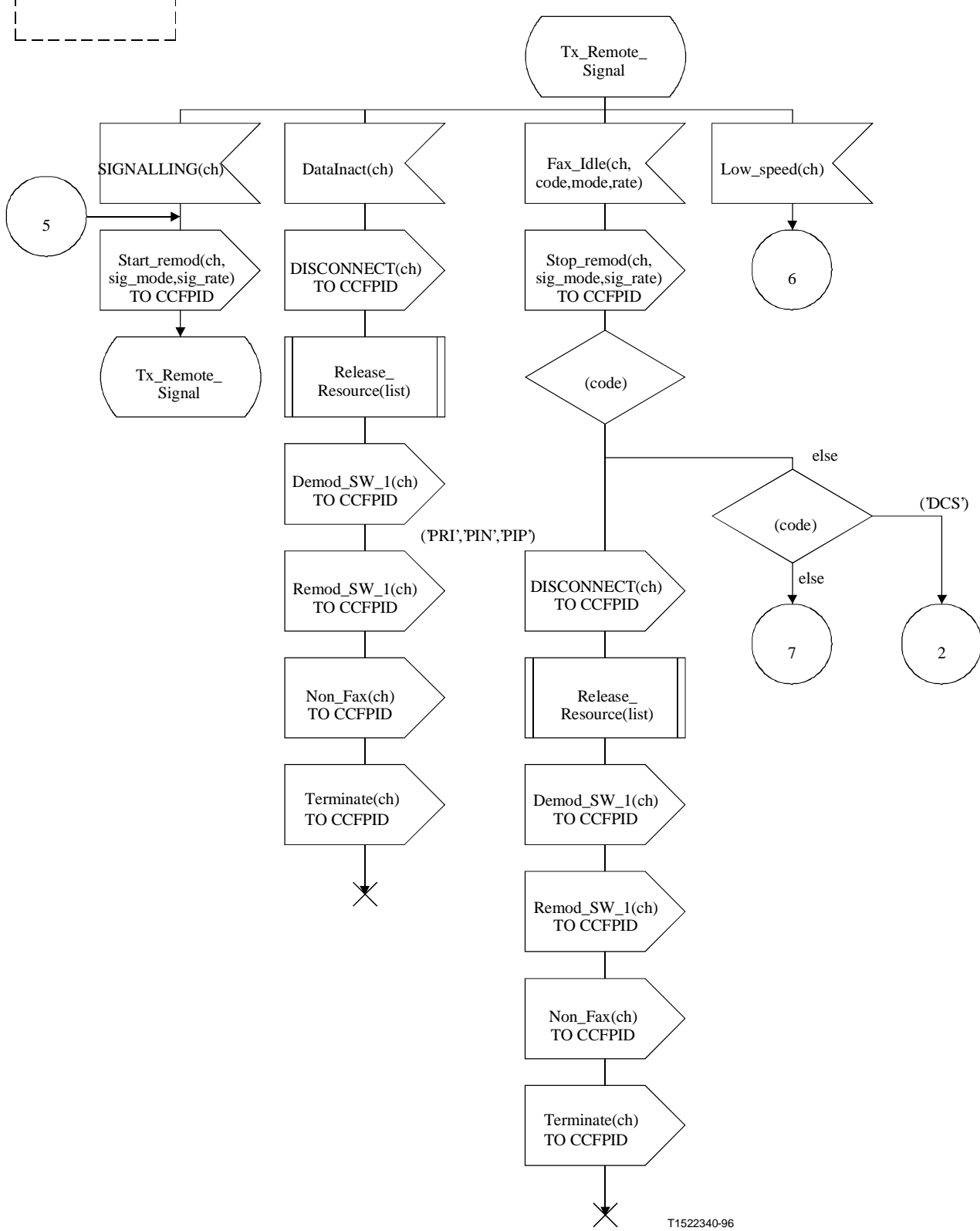

T1522340-96

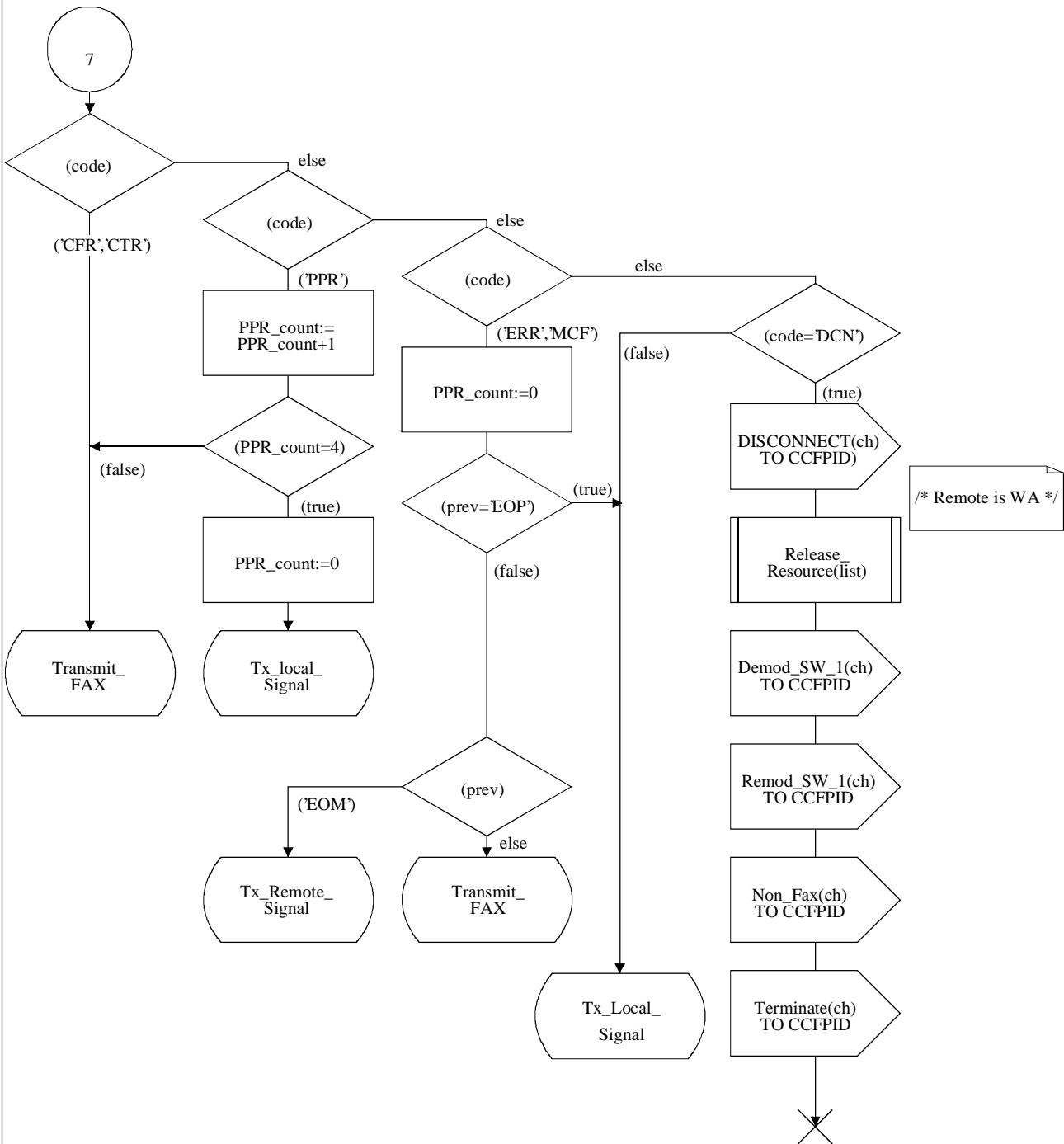

T1522350-96

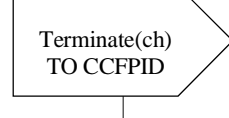
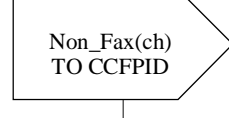
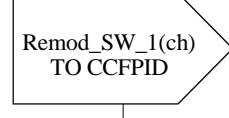
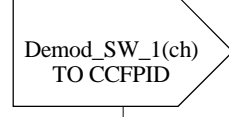
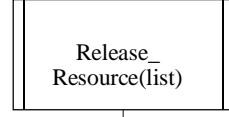
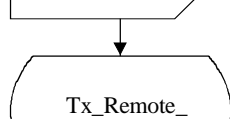
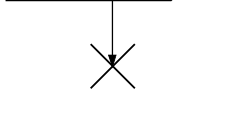
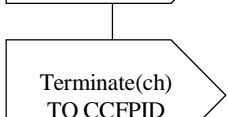
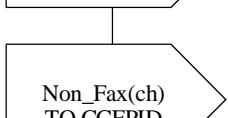
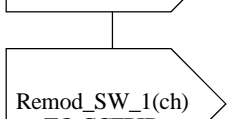
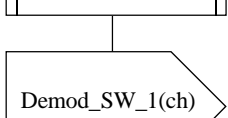
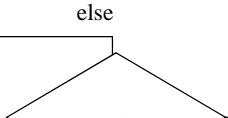
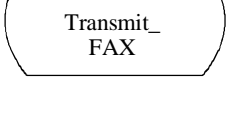
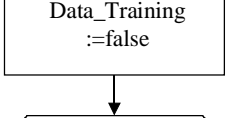
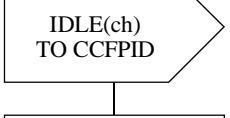
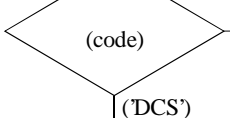
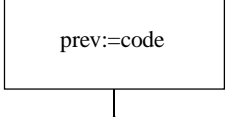
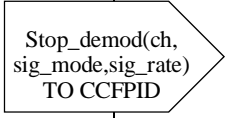
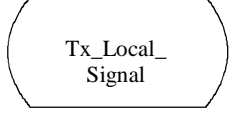
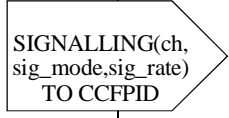
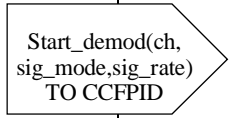
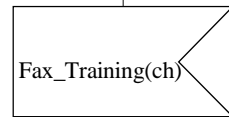
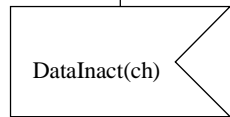
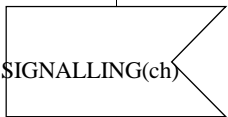
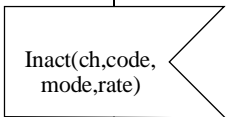
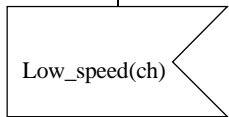
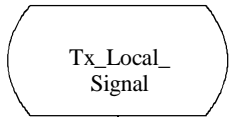

T1522360-96

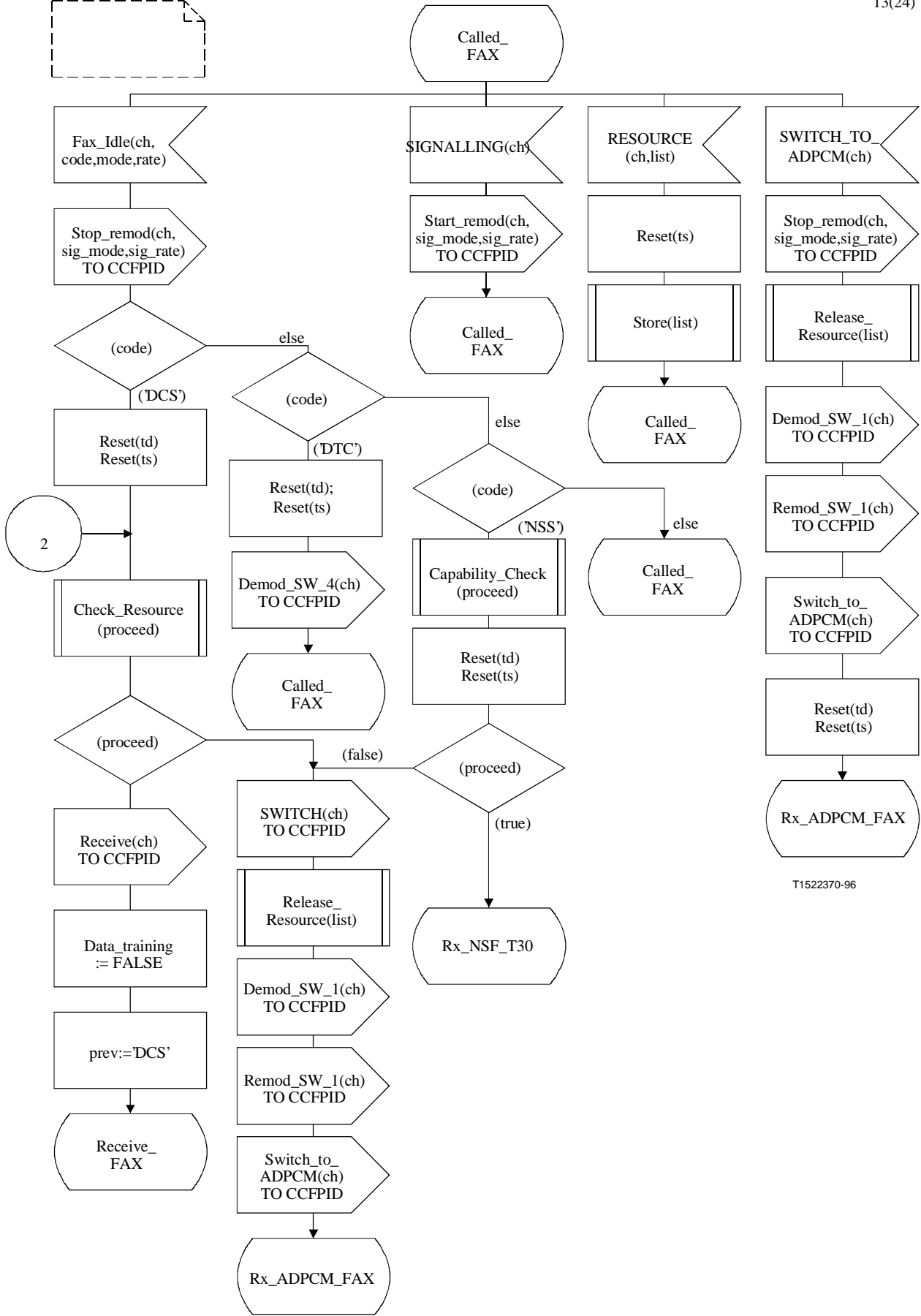

T1522370-96

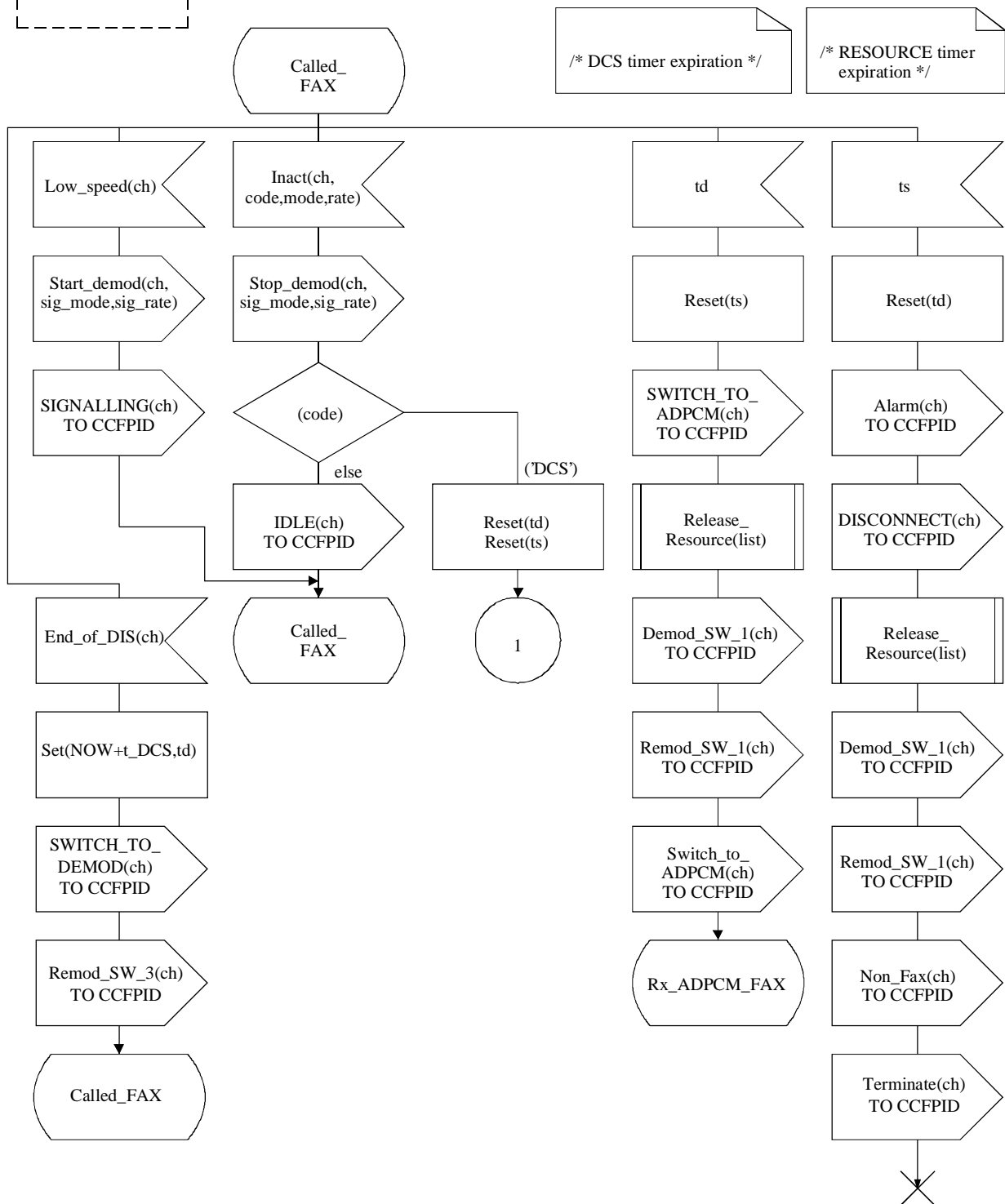

T1522520-96

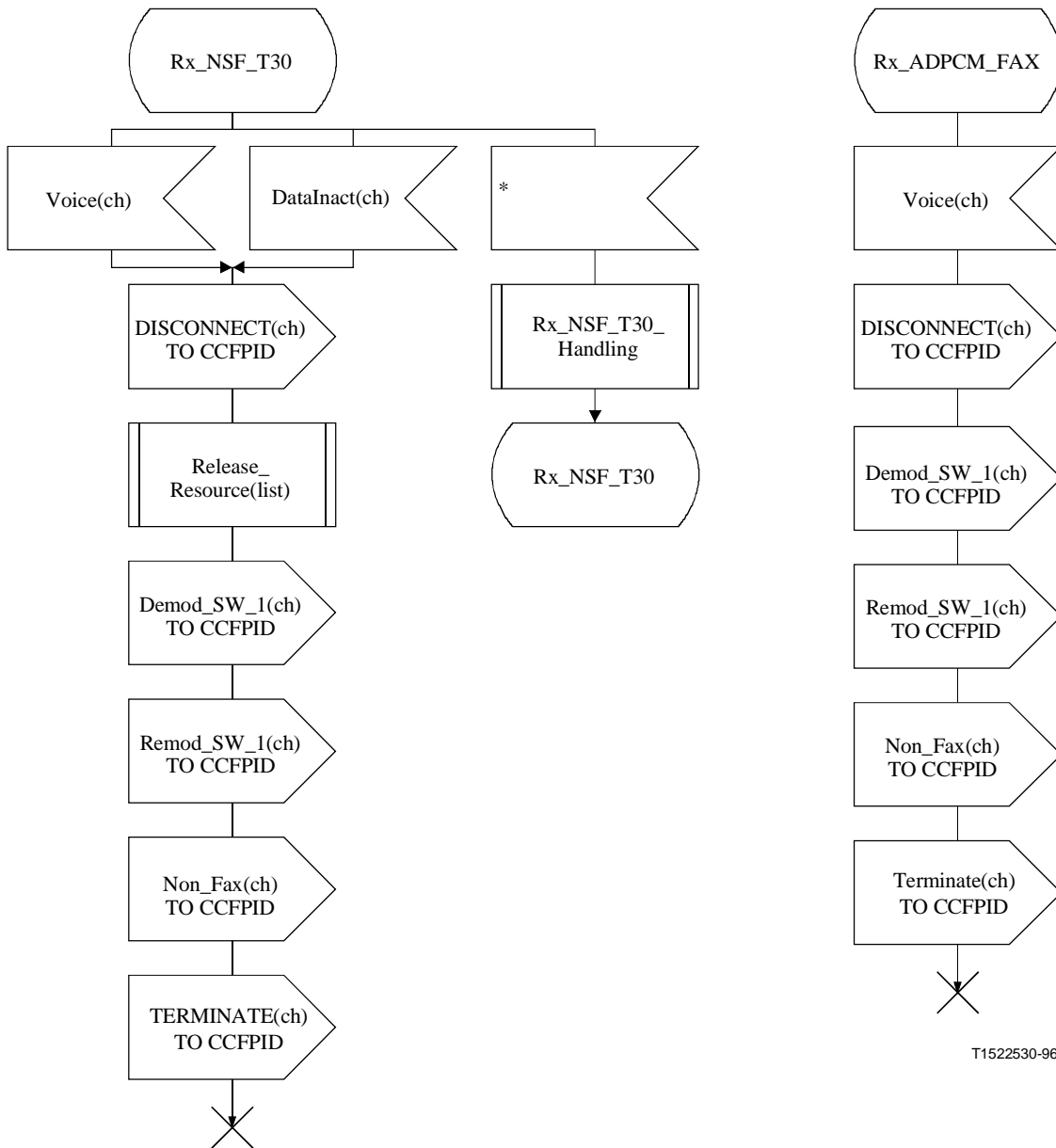

T1522530-96

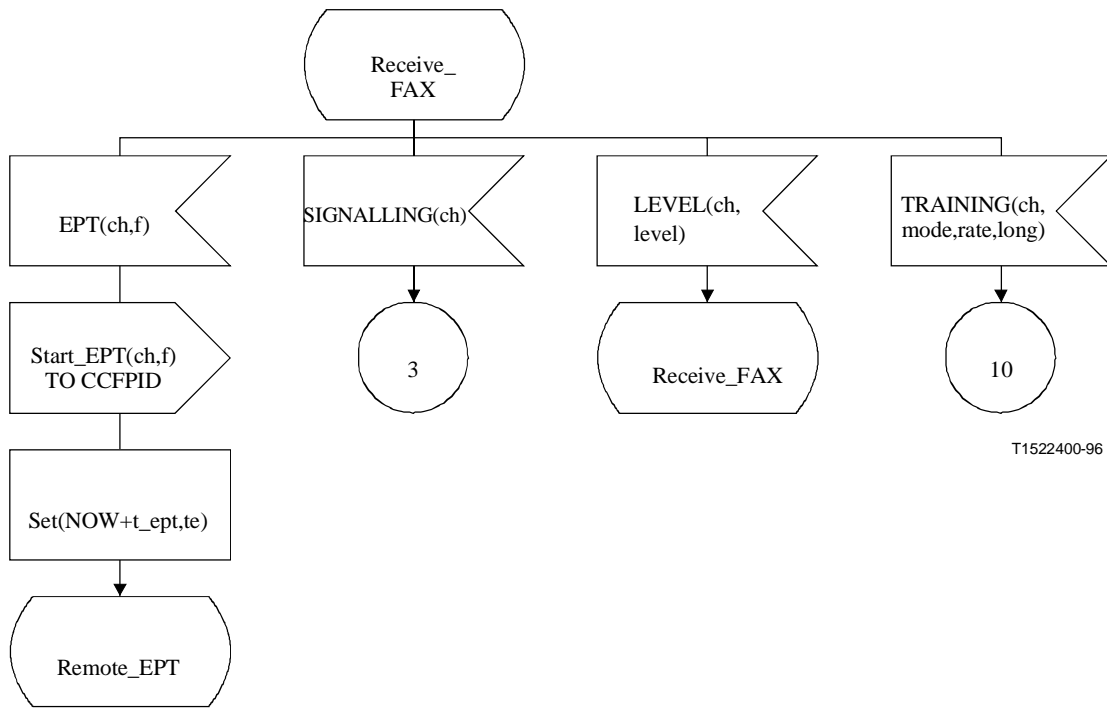

T1522400-96

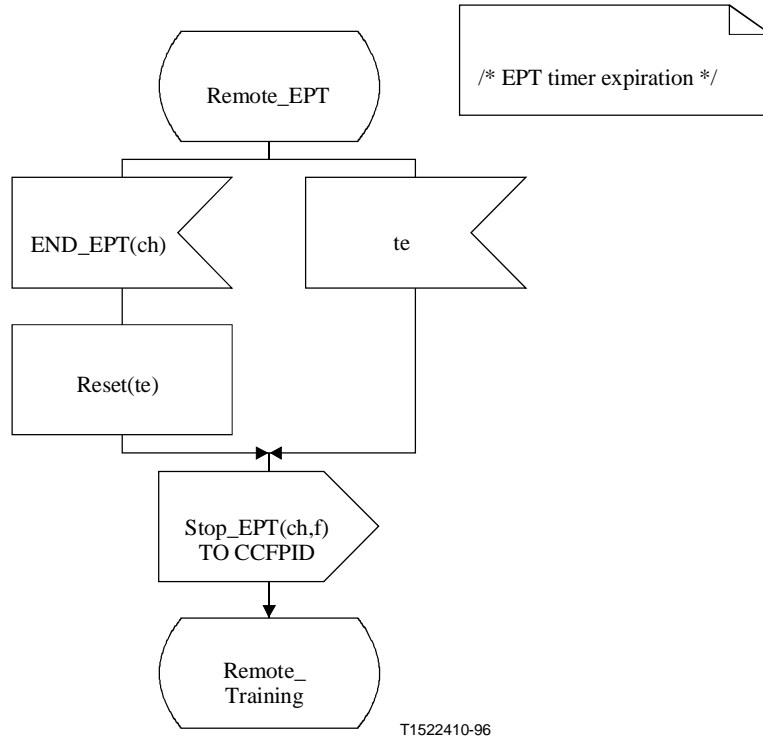

T1522410-96

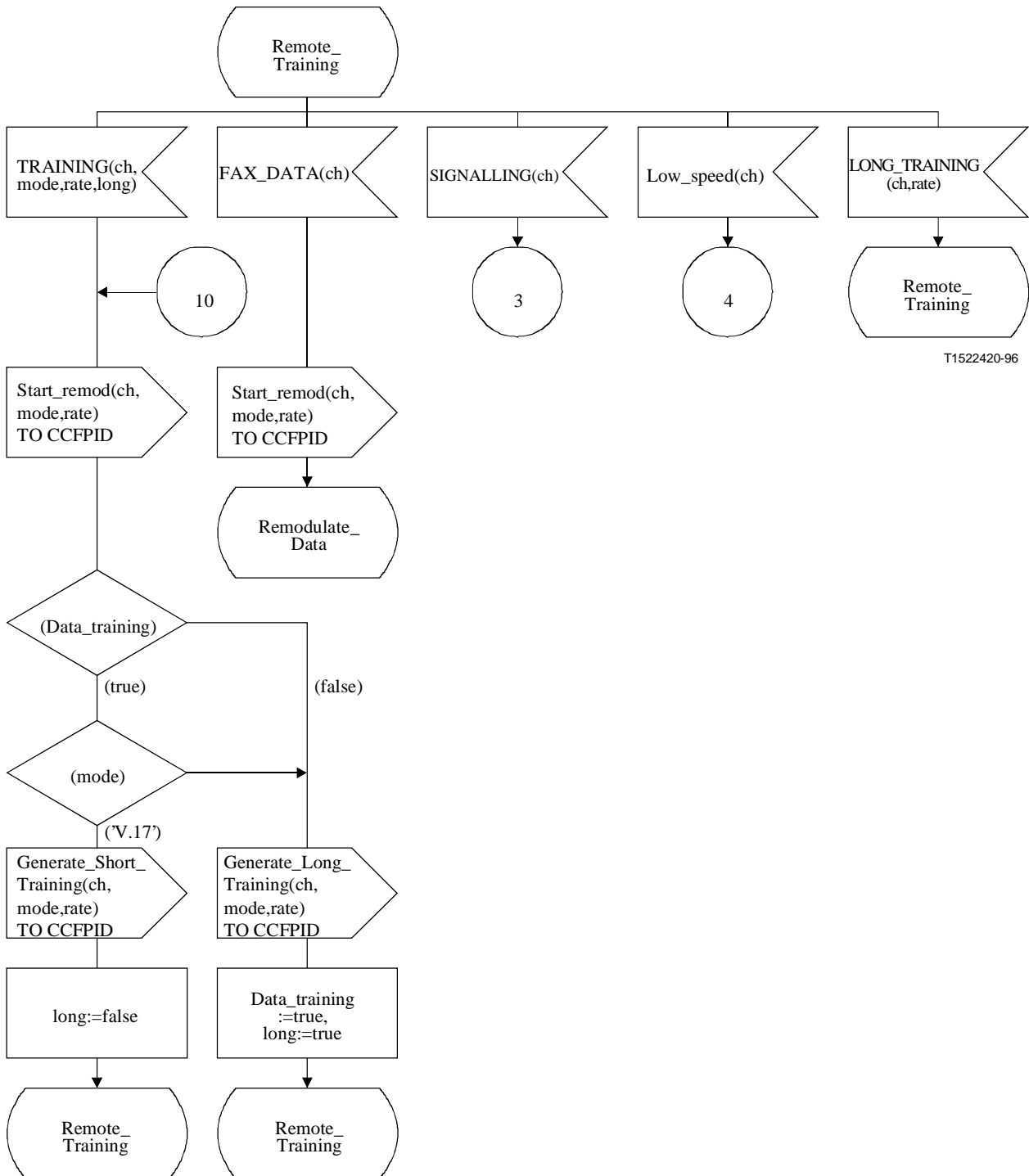

T1522420-96

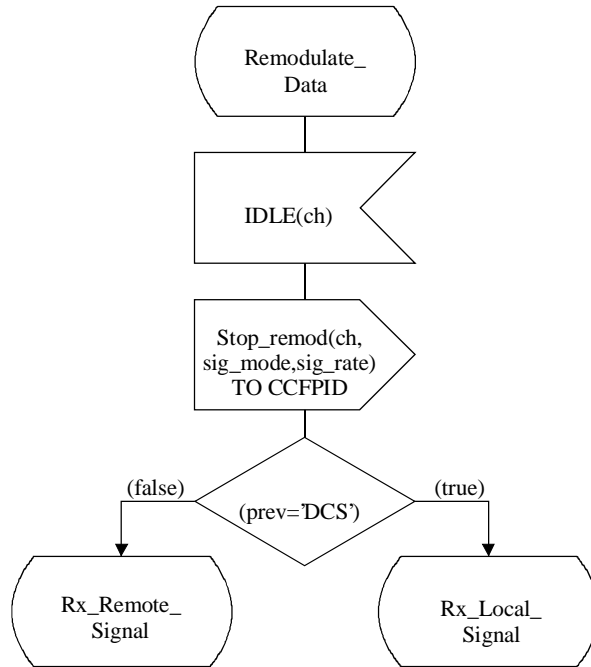

T1522430-96

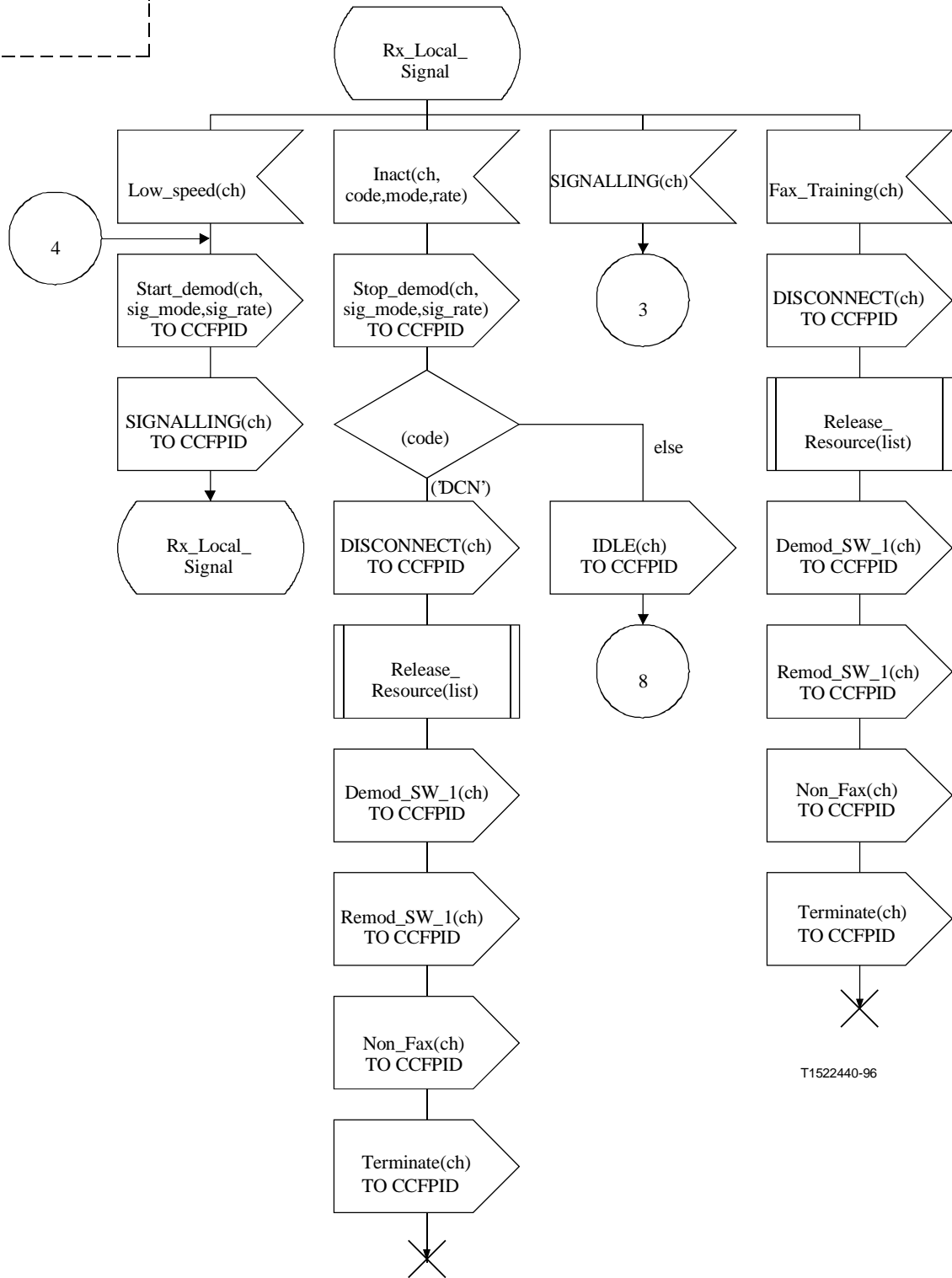

T1522440-96

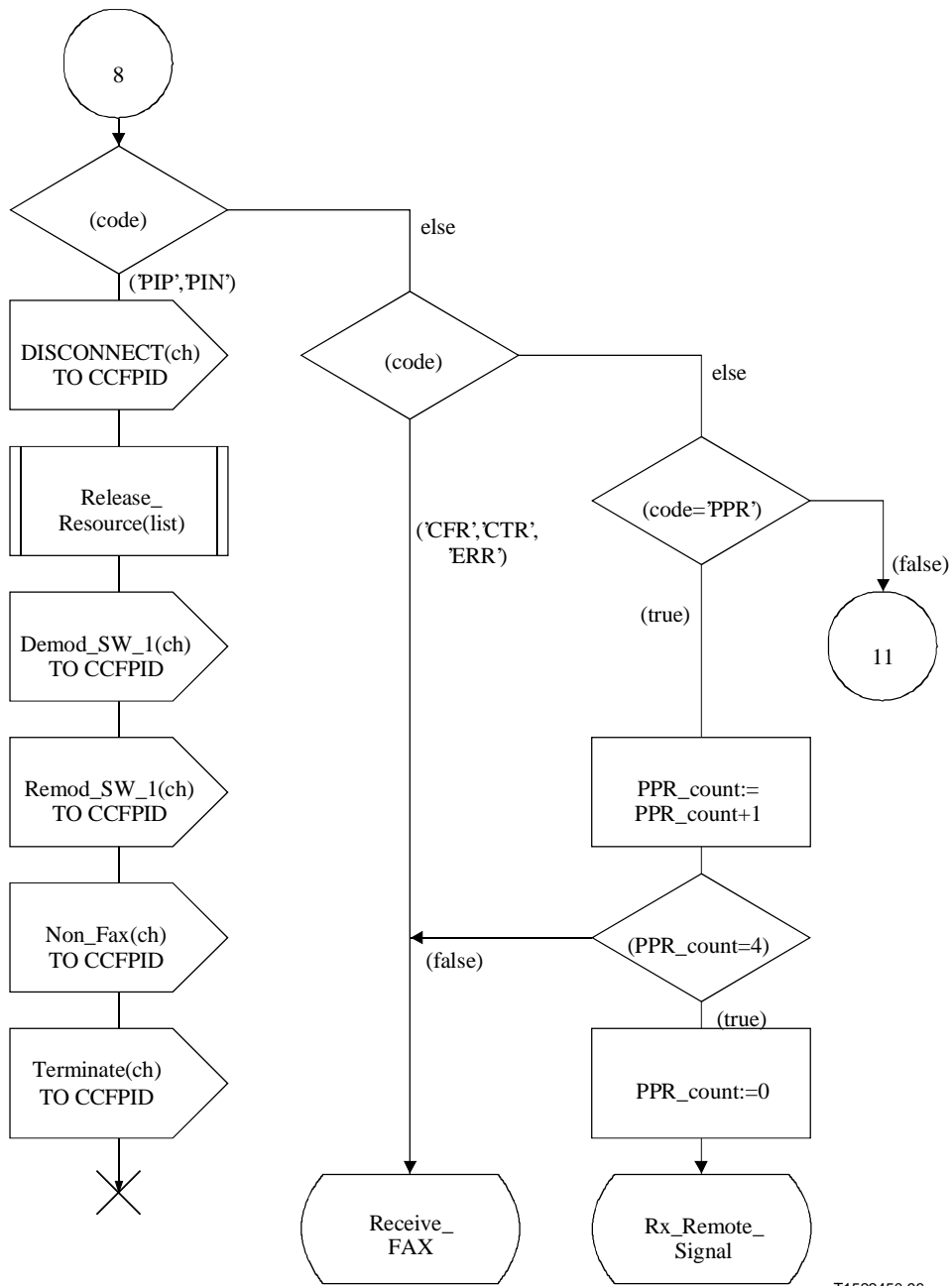

T1522450-96

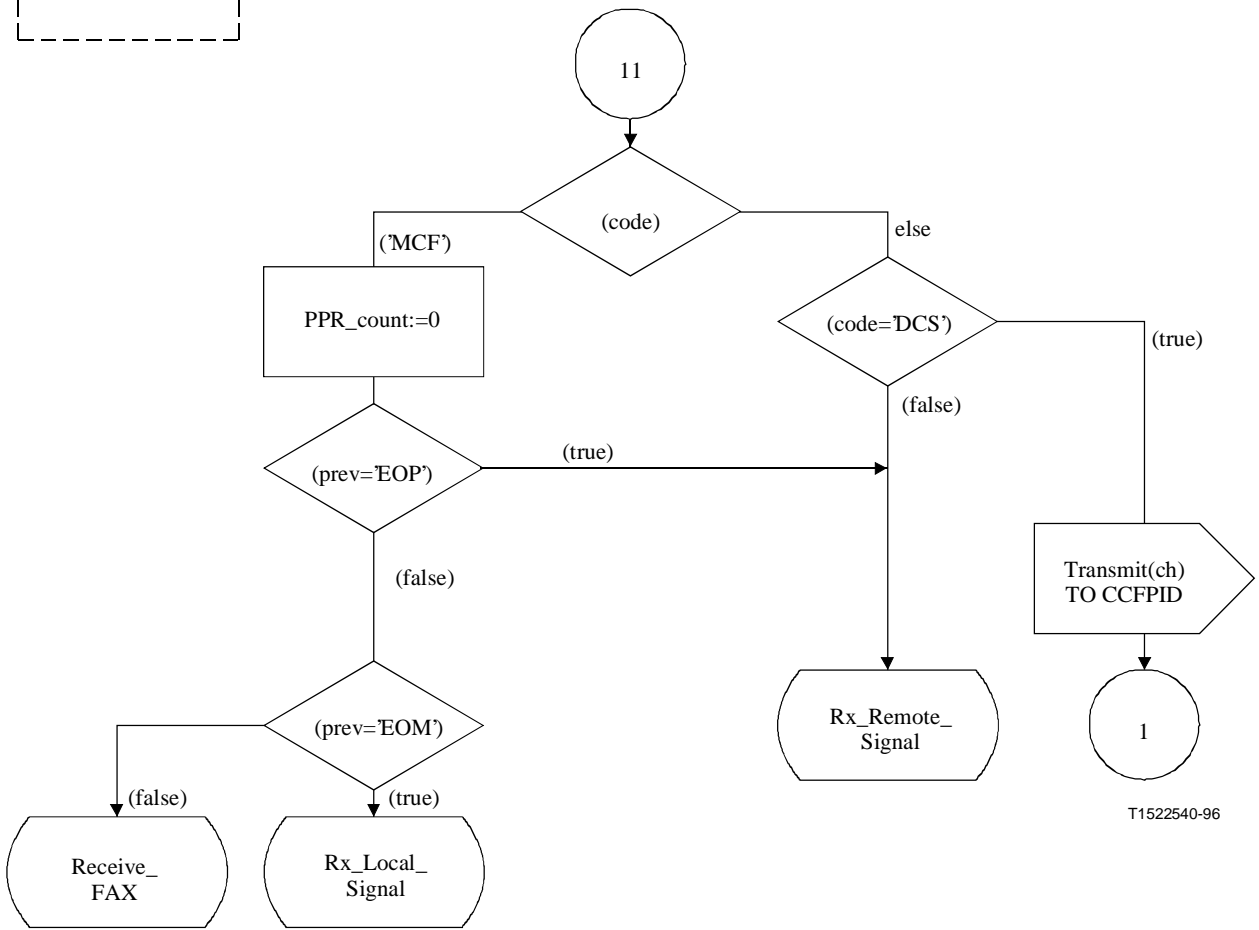

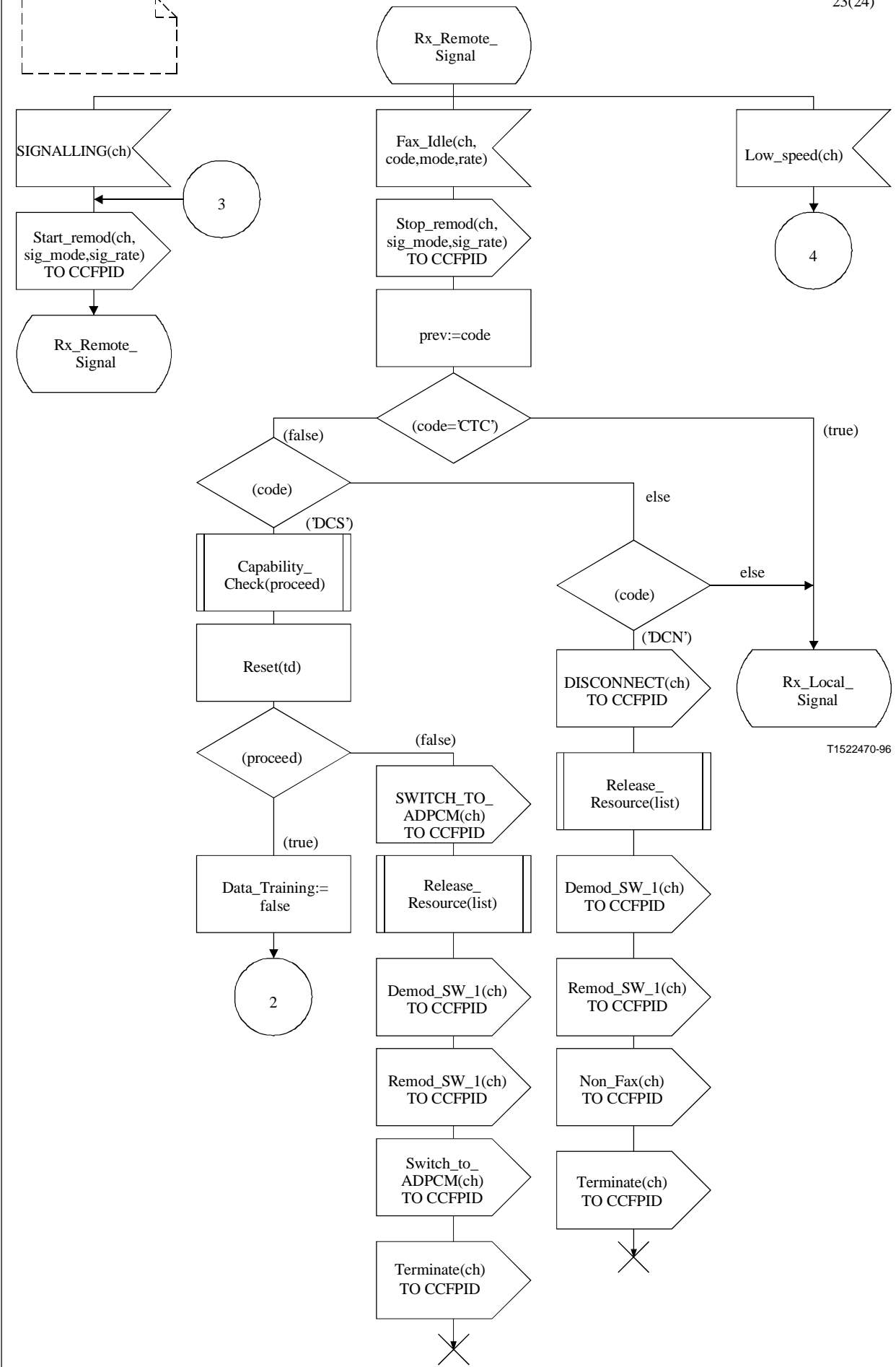

T1522470-96

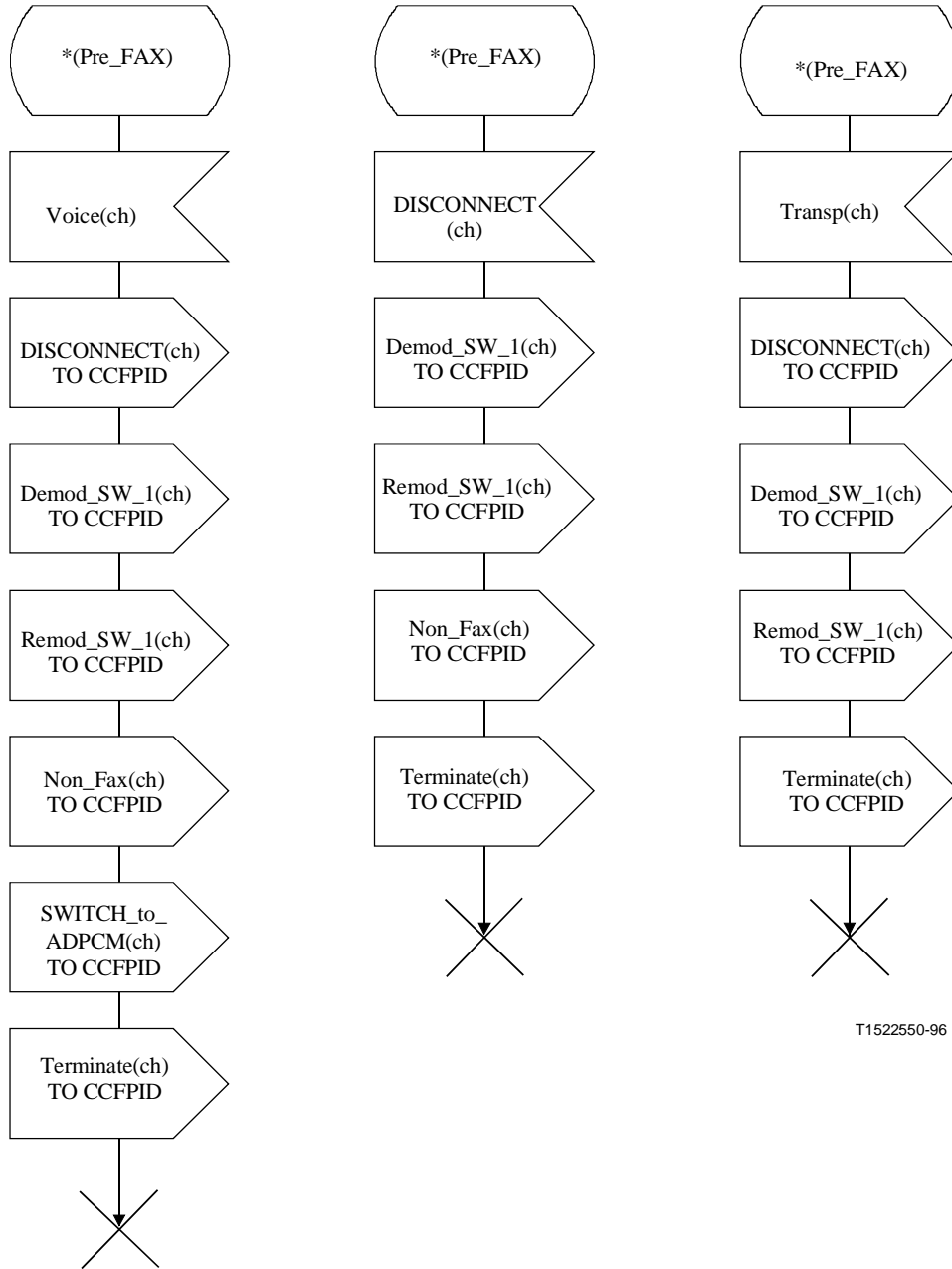

T1522550-96

Dimensioning example for facsimile compression

S.1 Introduction

This example is intended to be used in conjunction with the DCME dimensioning method outlined in Supplement No. 2 to Recommendation G.763, "DCME dimensioning for different route characteristics".

S.2 Assumptions

It is assumed that:

- most facsimile calls are carried out at 9.6 kbit/s;
- approximately 20% of facsimile calls are between machines which have a compatible set of non-standard facilities, which they therefore use, and which cannot be compressed;
- non-facsimile voiceband data is approximately 10% of the total;
- forward error correction is switched on, on the FCMs;
- most facsimile calls are of two pages in length;
- typical page transmission time is 30 s.

S.3 Method

Determination of the peak data loading period must follow the procedure of Supplement No. 2 to Recommendation G.763, taking due cognizance of the caveats of 4.3/G.763, "Two pitfalls for the unwary". That done, taking the example given in 4.2.1 of Supplement No. 2 to Recommendation G.763, "DCME dimensioning using the profile of a route without silence elimination", the example may be reworked as follows to include facsimile compression:

Assumption:

Number of trunk channels at service date = 240

NOTE – For facsimile compression, the gain for the voiceband data element of the Digital Channel Occupancy Analyser (DCOA) profile is increased. Therefore, for moderate voiceband data percentages and rates of 14.4 kbit/s and below, the channel occupancy profile of the bearer is quite similar to that of the trunk side. Furthermore, actual values of gain on facsimile traffic are likely to be numerically similar to the gain for voice traffic. These facts suggest that with facsimile compression, two DCMEs may be sufficient to carry the traffic.

From Figure 6 of Supplement No. 2 to Recommendation G.763 there are two peaks to be considered: one is dominated by the amount of data (data peak) and the other is dominated by the amount of voice (voice peak).

Data Peak:

59% of data:

$$\begin{aligned}\text{Number of fax trunks} &= 240 \times 0.59 \times 0.9 \\ &= 128\end{aligned}$$

$$\begin{aligned}\text{of which} & 128 \times 0.8 \\ &= 102 \text{ have standard facilities} \\ & 128 \times 0.2 \\ &= 26 \text{ have non-standard facilities}\end{aligned}$$

$$\begin{aligned}\text{Number of non-fax data trunks} &= 240 \times 0.59 \times 0.1 \\ &= 14\end{aligned}$$

$$\begin{aligned}\text{Therefore, number of data trunks which must be carried through ADPCM} & \\ &= 14 + 26 \\ &= 40\end{aligned}$$

$$\begin{aligned}\text{Number of ADPCM data trunks per DCME} & \\ &= \frac{40}{2}\end{aligned}$$

DSI gain = 1 (Silence elimination advantage cannot generally be assumed for non-facsimile and non-standard facilities facsimile data)

$$\text{LRE gain} = \frac{8}{5}$$

On a single channel, the low-speed signals which are carried through for compression are:

- DCS (1.46 s)
- CFR (1.36 s)
- MPS (1.36 s)
- MCF (1.36 s)
- EOP (1.36 s)
- MCF (1.36 s)
- DCN (1.36 s)

Total time duration of low-speed signals = 9.62 s (worst case) both directions included.

Since fax is half-duplex, in each direction the average duration (worst case) is:

$$\frac{9.62}{2} = 4.81 \text{ s}$$

These are 300 bit/s signals with 100% stuffing control overhead, 60% FDC fill, and triple redundancy. Therefore, the bearer channel rate is:

$$6 \text{ bits/2 ms} = 3 \text{ kbit/s}$$

Image data is sent at 9.6 kbit/s using a 21-bit FDC, which therefore gives a bearer channel rate of:

$$21 \text{ bits/2 ms} = 10.5 \text{ kbit/s}$$

The mean bit rate for single call is therefore:

$$\frac{3 \times 4.81 + 10.5 \times 30}{34.81} = 9.46 \text{ kbit/s}$$

and fax compression gain is $\frac{64}{9.46} = 6.77$

However, since we have assumed that FEC is ON in each terminal, the actual bearer channel rate will be:

$$\frac{9.46 \times 32}{21} = 14.42 \text{ kbit/s}$$

and the fax compression gain is $64/14.42 = 4.44$

Since 102 trunk channels are compressible, the bearer capacity allocated to the facsimile compression is:

$$\frac{102}{4.44} = 23 \text{ (fax bearer 64 kbit/s channels)}$$

For 17% voice:

$$\begin{aligned} \text{number of voice trunks} &= 240 \times 0.17 \\ &= 41 \text{ trunks totals} \end{aligned}$$

$$\begin{aligned} \text{number of voice trunks} \\ \text{per DCME} &= 20 \end{aligned}$$

$$\text{DSI gain (for 20 trunks)} = 1.43 \text{ (from tables)}$$

$$\text{LRE gain} = \frac{8}{3.6}$$

Hence, the 64 kbit/s bearer channel requirement is:

$$\frac{20 \times 5}{8} + \frac{20 \times 3.6}{1.43 \times 8} + \frac{23}{2}$$

$$= 12.5 \text{ (data)} + 6.29 \text{ (voice)} + 11.5 \text{ (fax)}$$

$$= 30.29 \text{ bearer channels per DCME}$$

NOTE – This is marginal, in view of the fact that a half-bearer channel must be allocated for the control channel, and a quarter-bearer channel for the FCC (when present). Nevertheless, the calculation illustrates the method which may be used in dimensioning DCMEs with a facsimile compression facility. The same method may be applied to the remainder of the example calculations in Supplement No. 2 to Recommendation G.763.

ITU-T RECOMMENDATIONS SERIES

Series A	Organization of the work of the ITU-T
Series B	Means of expression
Series C	General telecommunication statistics
Series D	General tariff principles
Series E	Telephone network and ISDN
Series F	Non-telephone telecommunication services
Series G	Transmission systems and media
Series H	Transmission of non-telephone signals
Series I	Integrated services digital network
Series J	Transmission of sound-programme and television signals
Series K	Protection against interference
Series L	Construction, installation and protection of cables and other elements of outside plant
Series M	Maintenance: international transmission systems, telephone circuits, telegraphy, facsimile and leased circuits
Series N	Maintenance: international sound-programme and television transmission circuits
Series O	Specifications of measuring equipment
Series P	Telephone transmission quality
Series Q	Switching and signalling
Series R	Telegraph transmission
Series S	Telegraph services terminal equipment
Series T	Terminal equipments and protocols for telematic services
Series U	Telegraph switching
Series V	Data communication over the telephone network
Series X	Data networks and open system communication
Series Z	Programming languages