



INTERNATIONAL TELECOMMUNICATION UNION

ITU-T

TELECOMMUNICATION
STANDARDIZATION SECTOR
OF ITU

G.692

(10/98)

SERIES G: TRANSMISSION SYSTEMS AND MEDIA,
DIGITAL SYSTEMS AND NETWORKS

Transmission media characteristics – Characteristics of
optical components and sub-systems

**Optical interfaces for multichannel systems
with optical amplifiers**

ITU-T Recommendation G.692

(Previously CCITT Recommendation)

ITU-T G-SERIES RECOMMENDATIONS
TRANSMISSION SYSTEMS AND MEDIA, DIGITAL SYSTEMS AND NETWORKS

INTERNATIONAL TELEPHONE CONNECTIONS AND CIRCUITS	G.100–G.199
INTERNATIONAL ANALOGUE CARRIER SYSTEM	
GENERAL CHARACTERISTICS COMMON TO ALL ANALOGUE CARRIER-TRANSMISSION SYSTEMS	G.200–G.299
INDIVIDUAL CHARACTERISTICS OF INTERNATIONAL CARRIER TELEPHONE SYSTEMS ON METALLIC LINES	G.300–G.399
GENERAL CHARACTERISTICS OF INTERNATIONAL CARRIER TELEPHONE SYSTEMS ON RADIO-RELAY OR SATELLITE LINKS AND INTERCONNECTION WITH METALLIC LINES	G.400–G.449
COORDINATION OF RADIOTELEPHONY AND LINE TELEPHONY	G.450–G.499
TESTING EQUIPMENTS	
TRANSMISSION MEDIA CHARACTERISTICS	
General	G.600–G.609
Symmetric cable pairs	G.610–G.619
Land coaxial cable pairs	G.620–G.629
Submarine cables	G.630–G.649
Optical fibre cables	G.650–G.659
Characteristics of optical components and sub-systems	G.660–G.699
DIGITAL TRANSMISSION SYSTEMS	
TERMINAL EQUIPMENTS	G.700–G.799
DIGITAL NETWORKS	G.800–G.899
DIGITAL SECTIONS AND DIGITAL LINE SYSTEM	G.900–G.999

For further details, please refer to ITU-T List of Recommendations.

ITU-T RECOMMENDATION G.692

OPTICAL INTERFACES FOR MULTICHANNEL SYSTEMS WITH OPTICAL AMPLIFIERS

Summary

This Recommendation specifies multichannel optical line system interfaces for the purpose of providing future transverse compatibility among such systems.

This Recommendation defines interface parameters for systems of four, eight and sixteen channels operating at bit rates of up to STM-16 on fibres, as described in Recommendations G.652, G.653 and G.655 with nominal span lengths of 80 km, 120 km and 160 km and target distances between regenerators of up to 640 km. A frequency grid anchored at 193.1 THz with interchannel spacings at integer multiples of 50 GHz and 100 GHz is specified as the basis for selecting channel central frequencies.

Source

ITU-T Recommendation G.692 was prepared by ITU-T Study Group 15 (1997-2000) and was approved under the WTSC Resolution No. 1 procedure on the 23rd of October 1998.

FOREWORD

ITU (International Telecommunication Union) is the United Nations Specialized Agency in the field of telecommunications. The ITU Telecommunication Standardization Sector (ITU-T) is a permanent organ of the ITU. The ITU-T is responsible for studying technical, operating and tariff questions and issuing Recommendations on them with a view to standardizing telecommunications on a worldwide basis.

The World Telecommunication Standardization Conference (WTSC), which meets every four years, establishes the topics for study by the ITU-T Study Groups which, in their turn, produce Recommendations on these topics.

The approval of Recommendations by the Members of the ITU-T is covered by the procedure laid down in WTSC Resolution No. 1.

In some areas of information technology which fall within ITU-T's purview, the necessary standards are prepared on a collaborative basis with ISO and IEC.

NOTE

In this Recommendation, the expression "Administration" is used for conciseness to indicate both a telecommunication administration and a recognized operating agency.

INTELLECTUAL PROPERTY RIGHTS

The ITU draws attention to the possibility that the practice or implementation of this Recommendation may involve the use of a claimed Intellectual Property Right. The ITU takes no position concerning the evidence, validity or applicability of claimed Intellectual Property Rights, whether asserted by ITU members or others outside of the Recommendation development process.

As of the date of approval of this Recommendation, the ITU had received notice of intellectual property, protected by patents, which may be required to implement this Recommendation. However, implementors are cautioned that this may not represent the latest information and are therefore strongly urged to consult the TSB patent database.

© ITU 1999

All rights reserved. No part of this publication may be reproduced or utilized in any form or by any means, electronic or mechanical, including photocopying and microfilm, without permission in writing from the ITU.

CONTENTS

	Page
1	Scope 1
2	References 2
3	Terminology 2
4	Abbreviations 3
5	Classification of optical interfaces 3
5.1	Applications 3
5.1.1	Application codes for systems without line amplifiers 4
5.1.2	Application codes for systems with line amplifiers 4
5.2	Implementation..... 5
5.2.1	Reference configurations..... 5
5.2.2	Optical supervisory channel implementations 6
6	Parameter definitions..... 7
6.1	Individual transmitter outputs 7
6.1.1	Spectral characteristics..... 7
6.1.2	Mean launched power 7
6.1.3	Extinction ratio..... 7
6.1.4	Eye pattern mask 7
6.1.5	Central frequency 7
6.1.6	Channel spacing 8
6.1.7	Central frequency deviation 8
6.2	Individual channel input ports 8
6.3	Optical interface at points MPI-S and S' 8
6.3.1	Optical transmit-side crosstalk..... 8
6.3.2	Channel output power 8
6.3.3	Total launched power..... 8
6.3.4	Channel optical signal-to-noise ratio 8
6.3.5	Maximum channel power difference at point MPI-S or point S' 9
6.4	Optical path 9
6.4.1	Attenuation..... 9
6.4.2	Dispersion 9
6.4.3	Reflections 10
6.5	Optical line amplifier parameters 10
6.5.1	Multichannel gain variation 10
6.5.2	Multichannel gain tilt 10
6.5.3	Multichannel gain-change difference..... 10

	Page
6.5.4	Total received power..... 10
6.5.5	Total launched power..... 10
6.5.6	Signal spontaneous noise figure..... 10
6.6	Optical interface at points MPI-R and R' 10
6.6.1	Mean channel input power 10
6.6.2	Mean total input power 10
6.6.3	Channel optical signal-to-noise ratio 10
6.6.4	Optical crosstalk at points MPI-R and R' 11
6.6.5	Maximum channel power difference at point MPI-R or at point R'..... 11
6.7	Individual channel output ports 11
6.7.1	Optical crosstalk at individual channel output ports 11
6.8	Individual receiver inputs 11
6.8.1	Receiver sensitivity 11
6.8.2	Receiver overload..... 11
6.8.3	Optical path penalty 11
6.8.4	Receiver reflectance 11
6.8.5	Optical signal-to-noise ratio 11
6.8.6	Receiver wavelength range 12
6.9	Optical supervisory channel parameters..... 12
6.9.1	Optical supervisory channel wavelength..... 12
7	Optical interface parameter values 12
	Annex A – Nominal central frequencies 14
	Annex B – Alternative optical supervisory channel approaches..... 16
B.1	OSC at 1480 nm 16
B.2	OSC in 1310 nm band 16
B.3	OSC within EDFA gain bandwidth..... 16
	Appendix I – Methodology for derivation of optical power levels 17
I.1	Channel power..... 17
I.1.1	Minimum channel power 17
I.1.2	Maximum channel power..... 18
I.1.3	Maximum range for channel power 18
I.2	Maximum total power 19
	Appendix II – Selection of the minimum channel spacing and grid reference frequency for the WDM plan..... 19
II.1	50 GHz/100 GHz spacing and 193.10 THz reference..... 19

	Page
II.2 Absolute frequency reference (AFR).....	19
II.2.1 AFR accuracy.....	20
II.2.2 AFR stability	20
Appendix III – Suggested channel frequency allocations for applications on G.652/G.655 fibres.....	20
Appendix IV – Suggested channel frequency allocations for applications on G.653 fibres...	21
Appendix V – A channel-allocation methodology for applications on G.653 fibre based on unequal channel spacing.....	23
V.1 How to determine unequally-spaced channel frequencies.....	24
V.1.1 Basic design conditions.....	24
V.1.2 Determination of frequency slot.....	25
V.1.3 Required optical bandwidth for unequally spaced frequency allocation.....	26
V.2 Unequally spaced channel frequency allocation with 25 GHz frequency slot.....	27
V.3 Unequally spaced channel frequency allocation with 50 GHz frequency slot	27
V.4 Unequal channel frequency allocation with 100 GHz frequency slot.....	28
V.5 Impacts of unequal spacing on other parameters.....	28
V.5.1 Frequency deviation for unequal spacing with frequency offset.....	28
V.5.2 Power Levels.....	28
V.6 Bibliography.....	28
Appendix VI – Use of pre-equalisation at MPI-S.....	29
Appendix VII – Extension of G.692 to include bidirectional WDM transmission	29
Appendix VIII – Extension of G.692 to include 16- and 32- or more channel transmission..	30
Appendix IX – Extension of G.692 to include STM-64 bit-rate	31

Recommendation G.692

OPTICAL INTERFACES FOR MULTICHANNEL SYSTEMS WITH OPTICAL AMPLIFIERS

(Geneva, 1998)

1 Scope

This Recommendation applies to optical interfaces for multichannel optical line systems with optical amplifiers for terrestrial long-haul applications. This Recommendation defines and provides values for optical interface parameters of interoffice and long-haul systems with target lengths up to 160 km without line amplifiers and with target lengths up to 640 km with optical line amplifiers. Descriptions of system reference configurations and their constituent functional blocks are contained in Recommendation G.681.

The purpose of this Recommendation is to provide optical amplifier specifications for SDH and optical amplifier equipment towards future realisation of transverse compatible multichannel systems. Not all specifications required to obtain full transverse compatible systems could be finalised at the present stage of development. However, because of industry interest and emerging implementations, this initial version is issued. A complete specification is left to future versions of this Recommendation.

This Recommendation applies principally to point-to-point multichannel systems. Specific issues of optical add-drop are not considered.

This Recommendation is envisioned to describe optical line systems that include the following features:

- maximum number of channels: 4, 8, 16, 32 or more;
- signal channel types: STM-4, STM-16, or STM-64;
- transmission over a single fibre: unidirectional or bidirectional.

Given evolving technologies and markets, some aspects of the features described above are not fully characterised at this time, and are marked for further study. Some aspects of 16 and 32 channel systems, STM-64 and possibly bidirectional transmission are for further study. Some system aspects regarding bidirectional transmission (Appendix VII), regarding 16- and 32-channel transmission (Appendix VIII) and regarding STM-64 transmission (Appendix IX) are contained in the indicated appendices.

This Recommendation has been prepared from the experience with Erbium-Doped (silica-based) Fibre Amplifiers (EDFA), operating in the 1550 nm wavelength region. Other optical amplifiers operating at different wavelength regions, including the 1310 nm region, are not intended to be excluded from this Recommendation.

2 References

The following ITU-T Recommendations and other references contain provisions which, through reference in this text, constitute provisions of this Recommendation. At the time of publication, the editions indicated were valid. All Recommendations and other references are subject to revision; all users of this Recommendation are therefore encouraged to investigate the possibility of applying the most recent edition of the Recommendations and other references listed below. A list of the currently valid ITU-T Recommendations is regularly published.

- ITU-T Recommendation G.652 (1997), *Characteristics of a single-mode optical fibre cable.*
- ITU-T Recommendation G.653 (1997), *Characteristics of a dispersion-shifted single-mode optical fibre cable.*
- ITU-T Recommendation G.655 (1996), *Characterisation of a non-zero dispersion shifted single-mode optical fibre cable.*
- ITU-T Recommendation G.661 (1998), *Definition and test methods for the relevant generic parameters of optical amplifier devices and subsystems.*
- ITU-T Recommendation G.662 (1998), *Generic characteristics of optical amplifier devices and subsystems.*
- ITU-T Recommendation G.663 (1996), *Application related aspects of optical fibre amplifier devices and sub-systems.*
- ITU-T Recommendation G.671 (1996), *Transmission characteristics of passive optical components.*
- ITU-T Recommendation G.681 (1996), *Functional characteristics of interoffice and long-haul line systems using optical amplifiers, including optical multiplexing.*
- ITU-T Recommendation G.707 (1996), *Network node interface for the Synchronous Digital Hierarchy (SDH).*
- ITU-T Recommendation G.783 (1997), *Characteristics of Synchronous Digital Hierarchy (SDH) equipment functional blocks.*
- ITU-T Recommendation G.955 (1996), *Digital line systems based on the 1544 kbit/s and the 2048 kbit/s hierarchy on optical fibre cables.*
- ITU-T Recommendation G.957 (1995), *Optical interfaces for equipments and systems relating to the synchronous digital hierarchy.*
- IEC Publication 60825-1 (1993), *Safety of laser products – Part 1: Equipment classification, requirements and user's guide.*
- IEC Publication 61291-4 Ed.1.0 (working progress), *Performance specification template on optical amplifiers – Part 4: Optical fibre amplifiers for multichannel applications.*

3 Terminology

This Recommendation defines the following terms:

3.1 Optical Supervisory Channel (OSC): A channel that is accessed at each optical line amplifier site that is used for maintenance purposes including (but not limited to) remote site alarm reporting, communication necessary for fault location, and orderwire. The Optical Supervisory Channel is not used to carry payload traffic.

3.2 main (optical) path: The fibre plant between the MPI-S point of the transmitter equipment and the MPI-R point of the receiver equipment. The main path does not include any auxiliary paths.

3.3 main path interfaces: The interfaces to the fibre plant specified in this Recommendation.

4 Abbreviations

This Recommendation uses the following abbreviations:

AFR	Absolute Frequency Reference
ASE	Amplified Spontaneous Emission
BER	Bit-Error Ratio
EDFA	Erbium-Doped Fibre Amplifier
FWM	Four-Wave Mixing
MPI	Multiple Path Interference
MPI-R	Main Path Interface at the Receiver
MPI-S	Main Path Interface at the Transmitter
NF	Noise Figure
OA	Optical Amplifier
OD	Optical Demultiplexer
OEO	Optical-Electrical-Optical Converter
OM	Optical Multiplexer
OSC	Optical Supervisory Channel
OSNR	Optical Signal-to-Noise Ratio
PMD	Polarisation Mode Dispersion
RX	Optical Receiver
SBS	Stimulated Brillouin Scattering
SDH	Synchronous Digital Hierarchy
SNR	Signal-to-Noise Ratio
SPM	Self Phase Modulation
STM-N	Synchronous Transport Module Level N
TX	Optical Transmitter
WDM	Wavelength Division Multiplexing
XPM	Cross-Phase Modulation

5 Classification of optical interfaces

5.1 Applications

This Recommendation addresses multichannel systems for terrestrial long-haul applications with total target distance and discrete amplifier spacing as described below.

5.1.1 Application codes for systems without line amplifiers

These applications consist of 4, 8 or 16 optical channels that are optically multiplexed together. Each channel may be STM-4 or STM-16, including a simultaneous mixture of different rate channels. The target distances for these systems are nominally 80 km, 120 km, and 160 km on G.652, G.653 and G.655 fibres. The application codes with G.653 fibre are for further study. The application codes for systems without line amplifiers are summarised in Table 1.

The application codes in Table 1 are constructed in the following way:

- nW_x-y.z

where, for each application code:

- n is the maximum number of wavelengths.
- W is a letter indicating span distance, such as:
 - L indicating long-haul;
 - V indicating very long-haul;
 - U indicating ultra long-haul.
- x is the maximum number of spans allowed within the application code (x = 1 for systems without line amplifiers. In this case it is not shown).
- y is the maximum bit-rate (STM level) of the wavelength signals.
- z is the fibre type, as follows:
 - 2 indicating G.652 fibre.
 - 3 indicating G.653 fibre.
 - 5 indicating G.655 fibre.

A bidirectional system is indicated by the addition of the letter B at the front of the Application code:

- B-nW_x-y.z

Table 1/G.692 – Application codes for multichannel systems without line amplifiers

Application	Long-haul (target distance 80 km)	Very long-haul (target distance 120 km)	Ultra long-haul (target distance 160 km)
4-channel systems	4L-y.z	4V-y.z	4U-y.z
8-channel systems	8L-y.z	8V-y.z	8U-y.z
16-channel systems	16L-y.z	16V-y.z	16U-y.z ^{d)}
a)	The target distances are to be used for classification only and not for specification.		
b)	y = 4 or 16.		
c)	z = 2, 3 or 5.		
d)	The feasibility of this application is for further study.		

5.1.2 Application codes for systems with line amplifiers

These applications also consist of 4, 8 or 16 optical channels that are optically multiplexed together. The target spacings between line optical amplifiers are nominally 80 km and 120 km with total target distances before requiring regeneration of nominally 360 km to 640 km on G.652, G.653, and G.655 fibres. In order to limit the possible combinations of these distances, they are reduced to the applications shown in Table 2.

The application codes for systems with line amplifiers are summarised in Table 2.

Table 2/G.692 – Application codes for multichannel systems with line amplifiers

Application	Long-haul spans (per span target distance 80 km)		Very long-haul spans (per span target distance 120 km)	
	5	8	3	5
Number of spans	5	8	3	5
4-channel systems	4L5-y.z	4L8-y.z	4V3-y.z	4V5-y.z
8-channel systems	8L5-y.z	8L8-y.z	8V3-y.z	8V5-y.z ^{a)}
16-channel systems	16L5-y.z	16L8-y.z	16V3-y.z	16V5-y.z ^{a)}
a)	The feasibility of this application code is for further study.			
b)	The target distances are to be used for classification only and not for specification.			
c)	y = 4, or 16.			
d)	z = 2, 3, 5.			

Systems of the type nL5 and nV3 are not a subset of nL8 and nV5 systems, respectively, because nL8 and nV5 systems require different technologies (including lower noise OAS and more stringent dispersion requirements) which may be significantly more challenging and may not be achievable for all fibre types.

The application codes are based on channel bit-rates of up to STM-16 per channel systems with higher bit-rates, such as STM-64, it will be necessary to re-evaluate application codes. The exact values are for further study.

It should be noted that, for example, a 4-channel system cannot be upgraded to an 8-channel system. Such option is only given by under equipped 8-channel systems. That means if operators choose, for example, the option to upgrade a 4-channel system to 8 channels, they have not only to choose the central frequency deviation in line with an 8-channel system but also all other relevant parameters.

5.2 Implementation

5.2.1 Reference configurations

Figure 1 illustrates the reference configuration for a G.692 system with the number of n channels, with reference points:

- $S_1 \dots S_n$ are reference points on the optical fibre at the output optical connectors of the transmitters for channels 1 ... n respectively.
- $R_{M1} \dots R_{Mn}$ are reference points on the optical fibre just before the OM/OA input optical connectors for channels 1 ... n respectively.
- MPI-S is a reference point on the optical fibre just after the OM/OA output optical connector.
- S' is a reference point just after the line OA output optical connector.
- R' is a reference point on the optical fibre just before the line OA input optical connector.
- MPI-R is a reference point on the optical fibre just before the OA/OD input optical connector.
- $S_{D1} \dots S_{Dn}$ are reference points at the OA/OD output optical connectors.
- $R_1 \dots R_n$ are reference points at the inputs to the receiver optical connectors.

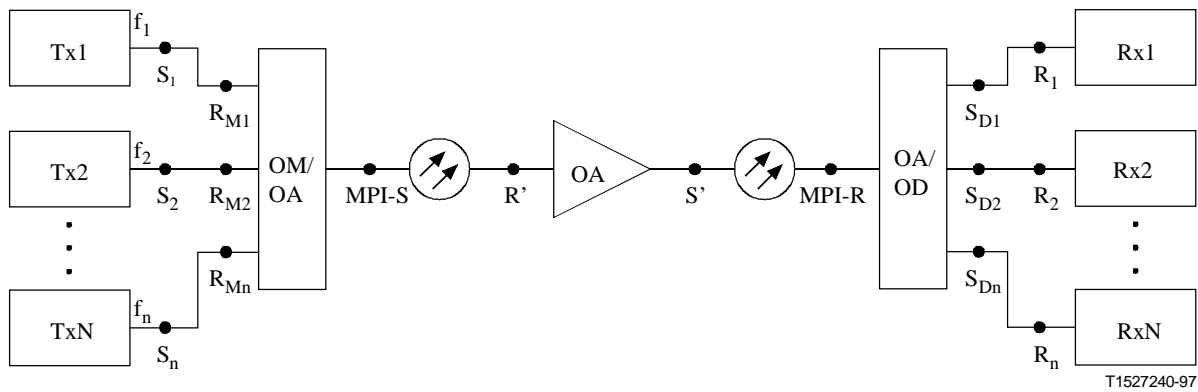

Figure 1/G.692 – Representation of optical line system interfaces

NOTE 1 – The attenuation of the OSC hybrid possibly used to access the OSC is not part of the optical path power budget.

NOTE 2 – When a combination of a G.957 compliant transmitter and an optical transponder, as shown in Figure 2, is used to realise the G.692 optical transmitter, the S_n reference points, as defined in this Recommendation, are located just after the optical transponder output optical connectors. In this case, the interface between the G.957 compliant transmitter and the transponder is appropriately chosen from the set of specifications given for the S point of G.957.

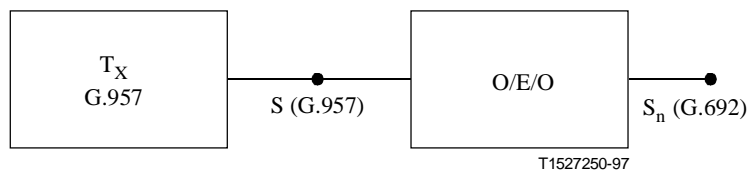

Figure 2/G.692 – Possible implementation of a G.692 transmitter using a G.957 compliant transmitter and a transponder

This Recommendation specifies the possibility of loss between reference points S_n and R_{Mn} . The minimum value of this loss is 0. Similarly, there may be loss between points S_{Dn} and R_n . It is also possible that the OM/OA and/or the OA/OD will not contain an OA. In addition, the possibility exists that the transmitters and the OM/OA (and likewise the OA/OD and the receivers) will be integrated; in this case, there will be no access to the interfaces at reference points S_n , R_{Mn} , S_{Dn} and R_n .

5.2.2 Optical supervisory channel implementations

Optical line systems described within this Recommendation that employ line amplifiers require an additional Optical Supervisory Channel (OSC). This channel shall be capable of being accessed at each amplifier. For optical line amplifiers implemented using Erbium-Doped Fibre Amplifier (EDFA) technology, the optical supervisory channel can be located outside the usable gain bandwidth of the EDFA ("out-of-band OSC") or alternatively, within the usable gain bandwidth ("in-band OSC"). There are design trade-offs associated with each of these possible choices. Subclause B.3 indicates the in-band OSC option.

The nominal preferred wavelength for the out-of-band Optical Supervisory Channel (OSC) is 1510 nm. Components for the 1510 nm wavelength (e.g. laser diodes, filters, etc.) are currently of limited availability. Until these components are mature and readily available, alternative wavelengths

of 1480 nm or a wavelength in the 1310 nm band may be used. These OSC alternatives are indicated in subclauses B.1 and B.2.

The selection of the 1310 nm band may preclude the use of that band for alternative traffic. Two amplifiers operating with different OSC wavelengths will not, in general, be transversely compatible.

6 Parameter definitions

Parameters applicable to this Recommendation are listed. Many of these parameters are defined in Recommendation G.957 and for these reference is made to G.957 for the definitions. Additional information pertaining to multichannel systems is included in addition to the G.957 definitions.

The parameters of subclauses 6.4.1, 6.4.2, 6.4.3 and 6.8.3 are sufficient to define longitudinally compatible multichannel systems on each optical fibre type (G.652, G.653, G.655) and for application codes considered in this Recommendation. However, according to the intent of this Recommendation, all parameters defined in clause 6 are required to obtain transverse compatible systems.

6.1 Individual transmitter outputs

These parameters apply to the outputs of the individual channel transmitters corresponding to points S_n in Figures 1 and 2.

6.1.1 Spectral characteristics

The spectral characteristics include maximum -20 dB width and minimum side modes suppression ratio as defined in Recommendation G.957.

6.1.2 Mean launched power

The maximum and minimum mean launched power are defined in Recommendation G.957.

6.1.3 Extinction ratio

The extinction ratio is defined in Recommendation G.957.

6.1.4 Eye pattern mask

For further study.

6.1.5 Central frequency

For channel spacings of 50 GHz on a fibre, the allowed channel frequencies are based on a 50 GHz grid with the reference frequency at 193.10 THz. For channel spacings of 100 GHz or more on a fibre, the allowed channel frequencies are based on a 100 GHz grid with the reference frequency at 193.10 THz. The table of the 50 and 100 GHz grid frequencies of the EDFA gain region is shown in Annex A. The endpoints are illustrative, not normative.

Suggested channel central frequency choices for applications on G.652/G.655 fibres are contained in Appendix III, in Table III.1.

Suggested channel central frequency choices for applications on G.653 fibres are contained in Appendix IV, in Table IV.1.

6.1.6 Channel spacing

The nominal channel spacing is the frequency difference between adjacent channels. The channel spacing may be equal or unequal. An unequal channel spacing may be used to mitigate FWM effects in G.653 fibres; a channel-allocation methodology is given in Appendix V.

6.1.7 Central frequency deviation

The central frequency deviation is defined as the difference between the nominal central frequency and the actual central frequency.

Included in the central frequency deviation are all the processes which affect the instantaneous value of the source central frequency over a measurement interval appropriate to the channel bit-rate. These processes include source chirp, information bandwidth, broadening due to SPM, and effects due to temperature and ageing.

Table 3 provides maximum end-of-life central frequency deviation to be associated with each channel spacing.

Table 3/G.692 – End-of-life central frequency deviation associated with each channel spacing

Channel spacing GHz (n)	50	100	n ≥ 200
Maximum Central Frequency Deviation ± GHz	For further study	For further study	n/5

For systems with unequal channel spacing, channels at boundaries between different channel spacings shall have the more restrictive of the two deviations.

6.2 Individual channel input ports

These parameters apply to the inputs of the OM/OA corresponding to points R_{Mn} in Figure 1.

6.3 Optical interface at points MPI-S and S'

These parameters apply to the optical interface at points MPI-S and S' in Figure 1.

6.3.1 Optical transmit-side crosstalk

For further study.

6.3.2 Channel output power

The Channel Output Power is the mean launched optical channel power. This includes the ASE noise within the channel band.

6.3.3 Total launched power

The total Launched power is the maximum mean launched optical power at point MPI-S or at point S'.

6.3.4 Channel optical signal-to-noise ratio

For further study.

6.3.5 Maximum channel power difference at point MPI-S or point S'

The maximum difference in Channel Power is the difference between the largest value of channel launch power and the smallest value of channel launch power present at the same time within a given optical resolution bandwidth, independent of the number of channels, within the application.

6.4 Optical path

To ensure system performance for each of the applications listed in Table 1, it is necessary to specify characteristics of the optical path between reference points MPI-S and MPI-R as well as between R' and S' respectively as shown in Figure 1.

6.4.1 Attenuation

Attenuation is defined in Recommendation G.957. The attenuation ranges required for the target distances are based on the assumption of 0.28 dB/km installed fibre loss (including splices and cable margin) in the 1530-1565 nm range. This fibre loss assumption leads to 11 dB for a target distance of 40 km. Attenuation ranges for distances which are a multiple of 40 km are based on the appropriate multiple of 11 dB. In practice these values may not apply to all fibre cables, in which case the realistic distances that can be reached may be shorter.

Table 4 contains the attenuation ranges for systems without optical line-amplifiers. Table 5 contains the attenuation ranges for systems with optical line-amplifiers.

Table 4/G.692 – Attenuation ranges for application codes without optical line-amplifiers

Application code	nL-y.z	nV-y.z	nU-y.z
Attenuation Range			
– maximum	22 dB	33 dB	44 dB
– minimum	For further study	For further study	For further study

Table 5/G.692 – Attenuation ranges for application codes with optical line-amplifiers

Application code	nLx-y.z	nVx-y.z
Attenuation Range (between OAs)		
– maximum	22 dB	33 dB
– minimum	For further study	For further study

6.4.2 Dispersion

Dispersion includes the effects of chromatic dispersion, as defined in Recommendation G.957, and polarisation mode dispersion. The dispersion limits required for the target distances on G.652 fibre are based on the assumption of 20 ps/(nm.km). The dispersion limits required for G.655 fibre are for further study.

Table 6 contains the dispersion ranges for systems without optical line-amplifiers and systems with optical line-amplifiers on G.652 fibre.

Table 6/G.692 – Maximum dispersion for applications on G.652 fibre

Application code	L	V	U	nV3-y.2	nL5-y.2	nV5-y.2	nL8-y.2
Maximum dispersion (ps/nm)	1600	2400	3200	7200	8000	12 000	12 800

NOTE – For STM-16 systems and dispersion values above 10 000 ps/nm, dispersion accommodation techniques might be required. Any loss associated with these techniques is considered not to be included in the attenuation ranges specified in 6.4.1.

6.4.3 Reflections

Reflection parameters include minimum optical return loss and maximum discrete reflectance and are defined in Recommendation G.957.

6.5 Optical line amplifier parameters

These parameters only apply to systems which include line amplifiers.

6.5.1 Multichannel gain variation

This parameter is defined in IEC 61291-4.

6.5.2 Multichannel gain tilt

This parameter is defined in IEC 61291-4.

6.5.3 Multichannel gain-change difference

This parameter is defined in IEC 61291-4.

6.5.4 Total received power

This parameter is the maximum mean input power present at point R' in Figure 1.

6.5.5 Total launched power

This parameter is the maximum mean input power present at point S' in Figure 1.

6.5.6 Signal spontaneous noise figure

This parameter is defined in G.661.

6.6 Optical interface at points MPI-R and R'

These parameters apply to the optical interface at points MPI-R and R' in Figure 1. The maximum and minimum values of these parameters are specified independent of the number of channels present.

6.6.1 Mean channel input power

The mean channel input power is the maximum and minimum mean input channel power measured at point MPI-R or at point R'.

6.6.2 Mean total input power

The mean total input power is the maximum mean total input power measured at point MPI-R or at point R'.

6.6.3 Channel optical signal-to-noise ratio

For further study.

6.6.4 Optical crosstalk at points MPI-R and R'

For further study.

6.6.5 Maximum channel power difference at point MPI-R or at point R'

Maximum difference in channel power is the difference between the largest value of channel input power and the smallest value of channel input power present at the same time within a given optical resolution bandwidth, independent of the number of channels, within the application.

6.7 Individual channel output ports

These parameters apply to the outputs of the OA/OD corresponding to points S_{Dn} in Figure 1.

6.7.1 Optical crosstalk at individual channel output ports

Optical Crosstalk is defined as the ratio of the combined total disturbing power due to signal power from all other channels, operating under all specified conditions, relative to the nominal signal power level in the desired channel, at the single-channel signal output reference points $S_{D1} \dots S_{Dn}$ according to Figure 1, within the resulting bandwidth of the optical demultiplexer and optical receiver, expressed in dB.

6.8 Individual receiver inputs

These parameters apply to the inputs of the individual channel receivers corresponding to point R_n in Figure 1.

6.8.1 Receiver sensitivity

Receiver sensitivity is defined as the minimum value of average received power at point R_n to achieve a 1×10^{-12} BER. It takes into account power penalties caused by use of a transmitter under standard operating conditions with worst-case values of extinction ratio, pulse rise and fall times, optical return loss at points S_n , receiver connector degradations, crosstalk, optical amplifier noise, and measurement tolerances. The receiver sensitivity does not include power penalties associated with dispersion, jitter, or reflections from the optical path; these effects are specified separately in the allocation of maximum optical path penalty. Ageing effects are not specified separately since they are typically a matter between a beginning-of-life, nominal temperature receiver and its end-of-life, worst-case counterpart are desired to be in the 2 to 4 dB range. The receiver sensitivities in this Recommendation are worst-case, end-of-life values.

6.8.2 Receiver overload

Receiver overload is the maximum acceptable value of the received average power at point R_n for a 1×10^{-12} BER.

6.8.3 Optical path penalty

To be defined.

6.8.4 Receiver reflectance

The receiver reflectance is defined in Recommendation G.957.

6.8.5 Optical signal-to-noise ratio

The minimum value of optical SNR required to obtain a 1×10^{-12} BER.

6.8.6 Receiver wavelength range

The receiver wavelength range is defined as the acceptable range of wavelengths at point R_n. This range must be wide enough to cover the entire range of central frequencies over the OA passband.

6.9 Optical supervisory channel parameters

6.9.1 Optical supervisory channel wavelength

The optical supervisory channel wavelength is the wavelength on which the optical supervisory channel is transmitted. It is nominally 1510 ± 10 nm (198.5 ± 1.4 THz). Other wavelengths are described in Annex B.

7 Optical interface parameter values

Table 7 identifies parameters that are required at various interfaces (see Figure 1) within an optical communication system, in order to ensure transverse compatibility. In principle, there is one Table for each application code. However, at the present stage of development of this Recommendation, only a single Table template is shown. The relevant subclauses describing the parameter definitions and values are given in the Table 7. Where no value is given, the value is for further study.

Table 7/G.692 – Table Template for optical interfaces

Application code	Value	Units	Note (Subclause)
Number of Channels			5.1
Bit-Rate/Format of Channels			5.1
Individual Transmitter Outputs			
Spectral Characteristics			6.1.1
Mean Launched Power		dBm	6.1.2
Extinction Ratio			6.1.3
Eye Pattern mask			6.1.4
Central Frequency		GHz	6.1.5
Channel Spacing		GHz	6.1.6
Central Frequency Deviation		GHz	6.1.7
Individual channel input ports			6.2
NOTE – Parameters are for further study			
Optical Interfaces at Points MPI-S and S'			
Optical Transmit-side Crosstalk		dB	6.3.1
Channel Output Power		dBm	6.3.2
Total Launched Power			6.3.3
– maximum		dBm	
Channel Signal-to-Noise Ratio		dB	6.3.4
Maximum Channel Power Difference at Point MPI-S or Point S'		dB	6.3.5

Table 7/G.692 – Table Template for optical interfaces (concluded)

Application code	Value	Units	Note (Subclause)
Optical Line Amplifier			
Multichannel Gain Variation		dB	6.5.1
Multichannel Gain Tilt		dB/dB	6.5.2
Multichannel Gain-change Difference		dB	6.5.3
Total Received Power – maximum		dBm	6.5.4
Total Launched Power – maximum		dBm	6.5.5
Signal Spontaneous Noise Figure		dB	6.5.6
Optical Path			
Attenuation		dB	6.4.1
Dispersion		ps/nm	6.4.2
Maximum Discrete Reflectance		dB	6.4.3
Minimum Return Loss		dB	6.4.3
Optical Interfaces at Points MPI-R and R'			
Mean channel input power – maximum – minimum		dBm dBm	6.6.1
Mean total input power – maximum		dBm	6.6.2
Channel Signal-to-Noise Ratio		dB	6.6.3
Optical Signal Crosstalk		dB	6.6.4
Maximum Channel Power Difference at Point MPI-R or at Point R'		dB	6.6.5
Individual channel output ports			
Optical Crosstalk at individual channel output ports NOTE – Additional parameters not defined in 6.7 are for further study		dB	6.7 6.7.1
Individual receiver inputs			
Receiver Sensitivity		dBm	6.8.1
Receiver Overload		dBm	6.8.2
Optical Path Penalty		dB	6.8.3
Receiver Reflectance		dB	6.8.4
Optical Signal-to-Noise Ratio		dB	6.8.5
Minimum Receiver Wavelength		nm	6.8.6
Maximum Receiver Wavelength		nm	6.8.6

ANNEX A

Nominal central frequencies

Table A.1 gives nominal central frequencies based on the 50 GHz minimum channel spacing anchored to the 193.10 THz reference. Note that the value of "c" (speed of light) that should be used for converting between frequency and wavelength is 2.99792458×10^8 m/s.

Table A.1/G.692 – Nominal central frequencies

Nominal central frequencies (THz) for spacings of 50 GHz	Nominal central frequencies (THz) for spacings of 100 GHz and above	Nominal central wavelengths (nm)
196.10	196.10	1528.77
196.05	–	1529.16
196.00	196.00	1529.55
195.95	–	1529.94
195.90	195.90	1530.33
195.85	–	1530.72
195.80	195.80	1531.12
195.75	–	1531.51
195.70	195.70	1531.90
195.65	–	1532.29
195.60	195.60	1532.68
195.55	–	1533.07
195.50	195.50	1533.47
195.45	–	1533.86
195.40	195.40	1534.25
195.35	–	1534.64
195.30	195.30	1535.04
195.25	–	1535.43
195.20	195.20	1535.82
195.15	–	1536.22
195.10	195.10	1536.61
195.05	–	1537.00
195.00	195.00	1537.40
194.95	–	1537.79
194.90	194.90	1538.19
194.85	–	1538.58
194.80	194.80	1538.98
194.75	–	1539.37
194.70	194.70	1539.77
194.65	–	1540.16

Table A.1/G.692 – Nominal central frequencies (continued)

Nominal central frequencies (THz) for spacings of 50 GHz	Nominal central frequencies (THz) for spacings of 100 GHz and above	Nominal central wavelengths (nm)
194.60	194.60	1540.56
194.55	–	1540.95
194.50	194.50	1541.35
194.45	–	1541.75
194.40	194.40	1542.14
194.35	–	1542.54
194.30	194.30	1542.94
194.25	–	1543.33
194.20	194.20	1543.73
194.15	–	1544.13
194.10	194.10	1544.53
194.05	–	1544.92
194.00	194.00	1545.32
193.95	–	1545.72
193.90	193.90	1546.12
193.85	–	1546.52
193.80	193.80	1546.92
193.75	–	1547.32
193.70	193.70	1547.72
193.65	–	1548.11
193.60	193.60	1548.51
193.55	–	1548.91
193.50	193.50	1549.32
193.45	–	1549.72
193.40	193.40	1550.12
193.35	–	1550.52
193.30	193.30	1550.92
193.25	–	1551.32
193.20	193.20	1551.72
193.15	–	1552.12
193.10	193.10	1552.52
193.05	–	1552.93
193.00	193.00	1553.33
192.95	–	1553.73
192.90	192.90	1554.13
192.85	–	1554.54

Table A.1/G.692 – Nominal central frequencies (concluded)

Nominal central frequencies (THz) for spacings of 50 GHz	Nominal central frequencies (THz) for spacings of 100 GHz and above	Nominal central wavelengths (nm)
192.80	192.80	1554.94
192.75	–	1555.34
192.70	192.70	1555.75
192.65	–	1556.15
192.60	192.60	1556.55
192.55	–	1556.96
192.50	192.50	1557.36
192.45	–	1557.77
192.40	192.40	1558.17
192.35	–	1558.58
192.30	192.30	1558.98
192.25	–	1559.39
192.20	192.20	1559.79
192.15	–	1560.20
192.10	192.10	1560.61

NOTE – The endpoints of this table are illustrative only. Future evolutions of multichannel systems are anticipated to include frequencies beyond those limits.

ANNEX B

Alternative optical supervisory channel approaches

Two amplifiers operating with different OSC wavelengths will not, in general, be transverse compatible.

B.1 OSC at 1480 nm

The wavelength should be 1480 ± 10 nm (202.6 ± 1.4 THz).

This approach is the same as for single channel systems.

B.2 OSC in 1310 nm band

This approach is the same as for single channel systems. The boundaries of this wavelength range are for further study.

B.3 OSC within EDFA gain bandwidth

The in-band OSC option is aimed for applications that are carrying several wavelengths through one or more line amplifiers at the greatest feasible distances between amplifiers, and with large channel capacity. For these applications, the EDFAs are making use of their maximum pump powers, while staying within the constraints of pump laser reliability.

APPENDIX I

Methodology for derivation of optical power levels

This Appendix provides further information on the choice of maximum and minimum channel optical power, as well as the maximum total power.

I.1 Channel power

I.1.1 Minimum channel power

This Appendix describes a methodology which can be used to derive the end-of-life minimum channel optical power that is required to maintain a desired Optical Signal-to-Noise Ratio (OSNR). In order to relate the OSNR to a BER, the detection process must be taken into account, which will be different for amplified and non-amplified systems. The relationship to the BER is a receiver characteristic, which is not yet included in the design methodology. The resulting minimum channel optical output power is independent of the number of channels (i.e. wavelengths) and can be used for both single and multiple channel systems. This methodology is of principal interest for systems with line, but can also be applied to systems using pre-amplifiers.

This Appendix describes how ASE effects limit the minimum channel optical power for both single and multiple channel optically amplified systems.

The ASE power per unit frequency interval for an optical amplifier is given by:

$$P_{ASE} = 2N_{SP}(G-1)h\nu \quad (\text{I-1})$$

where $N_{SP} \geq 1$ is the spontaneous noise factor, G is the internal gain, h is Planck's constant and ν is the optical frequency. The external amplifier noise figure is given (in dB) by:

$$NF = 10 \text{Log} \left[2N_{SP} - \frac{2N_{SP} - 1}{G} \right] + \eta_{IN} \quad (\text{I-2})$$

where η_{IN} is the input coupling loss for the amplifier in dB. If we make the simplifying assumptions that the total output power (including accumulated ASE power) is equal after each amplifier, and that the gain $G \gg 1$, then the optical signal-to-noise ratio is given approximately by:

$$OSNR = P_{out} - L - NF - 10 \text{Log} N - 10 \text{Log} [h\nu\Delta\nu_0] \quad (\text{I-3})$$

where P_{out} is the output power (per channel) in dBm, L is the span loss between amplifiers in dB, NF is the external noise figure in dB, $\Delta\nu_0$ is the optical bandwidth, N is the number of spans in the chain, and we have assumed that all the span losses are equal. In the 1.55 μm band, $10 \text{Log} (h\nu\Delta\nu_0) = -58$ dBm at 0.1 nm optical bandwidth. This approach could still be applied in a system where the span losses differ, by assuming that all losses are equal to or less than L , and would yield a worst-case estimate of the OSNR.

The above relationship provides a practical and useful prediction, since the OSNR at the input to the receiver (point R_n in Figure 1) is the result of an r.m.s. average of N effective noise sources, such that small differences in span losses on output powers tend to average out. The $G \gg 1$ assumption is true for most amplified systems.

Equation (I-3) can be used to estimate the minimum optical power (P_{out}) that is required to maintain a desired OSNR. This minimum output power would be measured at the output of the amplifiers as indicated by point S' in Figure 1. Since it is a limit on the minimum power (per channel) and is independent of the number of channels, it can be used for both single and multiple channel systems.

In the case where individual channel powers vary, if all channel powers are greater than or equal to the minimum power, then all OSNRs will also be greater than or equal to the minimum required value.

In a real WDM system, the output powers channel will probably not be equal because of unequal gain, and the noise figures may also differ among the amplifiers and among the channels. In addition, the span losses will likely not be equal. Nevertheless, equation (I-3) is useful in the establishment of minimum channel optical power levels because only the worst-case needs to be considered (i.e. all span losses are equal to their highest value, and considering the channel with the lowest output power).

I.1.2 Maximum channel power

Limitations on maximum optical power levels can be based on either fibre non-linear effects or laser safety considerations. If the maximum total output power (including ASE) is fixed at the Class 3A laser limit, P_{3A} , then the maximum nominal channel power, P_{chmax} , is related to the channel number as given in:

$$P_{chmax} = P_{3A} - 10 \text{ Log}(M), \quad (\text{I-4})$$

where M is the number of channels in operation. This equation is given for illustrative purposes, since output power may vary among individual channels as long as the total output power is less than P_{3A} . This limitation would be valid for systems with and without line amplifiers as described in this Recommendation.

In some cases, fibre non-linearities impose more restrictive limits on output power level than laser safety considerations. In particular, Self Phase Modulation (SPM), Cross-Phase Modulation (XPM) and Stimulated Brillouin Scattering (SBS) place limits on the maximum channel power. The limits on optical power level imposed by SPM and SBS are independent of the number of channels present and, in the case of SPM, only systems on G.652 and G.655 fibre will be affected. However, XPM affects only Multichannel systems and is more significant for systems that adopt narrow channel spacings. The impairments from XPM are more significant in G.652 fibre systems, relative to G.653 and G.655 fibre systems. Maximum permitted channel output powers due to SPM-imposed or XPM-imposed limitations will vary between application codes, and depends on the number of spans and the span target distance.

The limits on maximum channel optical power introduced by SBS are for further study and are not considered here. Four-Wave Mixing (FWM) affects only Multichannel systems and does not present a practical limitation in G.652 or G.655 fibre systems. Stimulated Raman Scattering also does not present a practical limitation to the Multichannel systems on G.652 fibres as described in this Recommendation. The impact of Stimulated Raman Scattering on some Multichannel systems with unequal channel spacing using G.653 fibre is also for further study.

I.1.3 Maximum range for channel power

The three power level limits as defined in I.1.1 and I.1.2 define the maximum range for channel power levels. The minimum channel power is independent of the number of channels present, whereas the maximum channel power depends on the number of channels present. As an example, for eight channels present, the maximum level is determined by the safety limit, whereas for one channel present, the maximum level will be dictated by the SPM limit applicable for the application code. A relatively high channel power is obtained when only few channels are present, whereas the channel power would drop to a lower level when channels are being added. This, however, depends on the OFA implementation.

I.2 Maximum total power

The total required output power from the optical amplifiers can be estimated by:

$$P_{tot} = \sum P_{out} + N \cdot BW_{eff} \cdot h\nu \cdot 10^{(NF+L)/10} \quad (I-5)$$

Here, NF and L are given in dBs, and all other terms in linear units. The last term is the total accumulated ASE power and BW_{eff} is the effective ASE bandwidth defined as total ASE power divided by the ASE power density. This bandwidth is about 20-30 nm for one amplifier, and about 15 nm for a chain of up to 10 amplifiers, as long as the signal gain is close to the maximum spectral gain of the amplifier. This approximation is sufficient as long as the total power is dominated by the signal power.

APPENDIX II

Selection of the minimum channel spacing and grid reference frequency for the WDM plan

This Appendix contains a summary of the discussions leading to the 100 GHz, and subsequently 50 GHz, channel spacing and some information associated with choosing an Absolute Frequency Reference (AFR).

II.1 50 GHz/100 GHz spacing and 193.10 THz reference

The grid reference frequency of 193.10 THz was chosen in part to not give preference to an Absolute Frequency Reference (AFR) based on any particular substance (selection of a particular AFR will vary for different applications). However, the value of 193.10 THz is in proximity of several AFR lines.

A minimum channel spacing of 100 GHz, and subsequently 50 GHz, was chosen based on the following considerations:

First, it was agreed that the channel spacing should be a multiple of 25 GHz. It was determined that a 100 GHz, and subsequently 50 GHz, minimum channel spacing provides the flexibility for meeting various G.692 application requirements. Multiples of the minimum channel spacing can meet these requirements with respect to usable EDFA gain spectrum and capacity.

Technology limits (i.e. filter and source tolerances) for determining a minimum channel spacing were discussed. This approach tries to make the best use of technology and not impose limitations associated with specific applications. Minimum channel spacings based on this consideration were 125 GHz and 150 GHz. The choice of 100 GHz, and subsequently 50 GHz, as a minimum channel spacing in light of these technology projections suggests that these spacings may be achievable for only a subset of G.692 applications.

II.2 Absolute frequency reference (AFR)

It is an optical frequency reference that provides an optical signal with frequency accuracy maintained at (*) or better, and with frequency stability maintained at (*) or better, both with verification to an ideal frequency standard such as each national standard or those recommended by the International Committee for Weights and Measures (CIPM), including an iodine-stabilised He-Ne and a methane stabilised He-Ne.

AFR's can be used for the following applications:

- 1) to calibrate WDM test equipment;
- 2) to provide a frequency reference for fabrication and calibration of WDM devices;

- 3) to directly provide reference frequency to Multichannel systems;
- 4) to control and/or maintain optical-source frequencies.

The requirements for an AFR can be expressed both in frequency and vacuum wavelength.

NOTE – Numerical values indicated by (*) are under study.

II.2.1 AFR accuracy

The long-term frequency offset of an AFR signal from its ideal frequency (where long term implies the period of the expected operation time of the AFR).

NOTE – Frequency accuracy includes possible frequency changes due to temperature and humidity changes and other environmental changes. Setability, reproducibility and traceability to an ideal frequency standard are also included.

II.2.2 AFR stability

For further study.

APPENDIX III

Suggested channel frequency allocations for applications on G.652/G.655 fibres

Table III.1 illustrates some suggested channel central frequency choices on either G.652 or G.655 fibres.

Table III.1/G.692 – Suggested channel central frequency choices for applications on G.652/G.655 fibres

Frequency in THz	100 GHz spacing (8 channels or more)	200 GHz spacing (4 channels or more)	400 GHz spacing (4 channels only)	500/400 GHz spacing (8 channels only)	600 GHz spacing (4 channels only)	1000 GHz spacing (4 channels only)	Wavelength in vacuum in nm
196.1	*	*					1528.77
196.0	*						1529.55
195.9	*	*					1530.33
195.8	*						1531.12
195.7	*	*					1531.90
195.6	*						1532.68
195.5	*	*			*	*	1533.47
195.4	*						1534.25
195.3	*	*		*			1535.04
195.2	*						1535.82
195.1	*	*					1536.61
195.0	*						1537.40
194.9	*	*			*		1538.19
194.8	*			*			1538.98
194.7	*	*					1539.77
194.6	*						1540.56

**Table III.1/G.692 – Suggested channel central frequency choices
for applications on G.652/G.655 fibres (concluded)**

Frequency in THz	100 GHz spacing (8 channels or more)	200 GHz spacing (4 channels or more)	400 GHz spacing (4 channels only)	500/400 GHz spacing (8 channels only)	600 GHz spacing (4 channels only)	1000 GHz spacing (4 channels only)	Wavelength in vacuum in nm
194.5	*	*				*	1541.35
194.4	*						1542.14
194.3	*	*		*	*		1542.94
194.2	*						1543.73
194.1	*	*					1544.53
194.0	*						1545.32
193.9	*	*	*	*			1546.12
193.8	*						1546.92
193.7	*	*		*	*		1547.72
193.6	*						1548.51
193.5	*	*	*			*	1549.32
193.4	*			*			1550.12
193.3	*	*		*			1550.92
193.2	*						1551.72
193.1	*	*	*		*		1552.52
193.0	*			*			1553.33
192.9	*	*		*			1554.13
192.8	*						1554.94
192.7	*	*	*				1555.75
192.6	*						1556.55
192.5	*	*		*	*	*	1557.36
192.4	*						1558.17
192.3	*	*	*				1558.98
192.2	*						1559.79
192.1	*	*		*			1560.61

APPENDIX IV

Suggested channel frequency allocations for applications on G.653 fibres

Table IV.1 illustrates some suggested channel central frequency choices for applications on G.653 fibre. Some applications may be limited by Four-Wave Mixing if equal channel spacing is used. One way to mitigate this limitation is to use unequal channel spacing. One method of unequal channel spacing is described in further detail in Appendix V. Another potential way to mitigate this limitation is to combine channel choices with bidirectional WDM transmission, as mentioned in Appendix VII.

**Table IV.1/G.692 – Suggested channel central frequency choices
for 4- or 8-channel applications on G.653 fibres**

Frequency in THz	100 GHz spacing (8 channels or more)	200 GHz spacing (4 channels or more)	Alternate 200 GHz spacing (4 or 8 channels) 25 GHz offset	Alternate 200 GHz spacing (4 or 8 channels) 50 GHz offset	Wavelength in vacuum in nm
	Unequal spacing on nominal frequency grid		Unequal spacing by offset from nominal frequency grid		
196.1	*				1528.77
196.0	*				1529.55
195.9	*	*			1530.33
195.8	*				1531.12
195.7	*	*			1531.90
195.6	*				1532.68
195.5	*	*			1533.47
195.4	*				1534.25
195.3	*	*			1535.04
195.2	*				1535.82
195.1	*	*			1536.61
195.0	*				1537.40
194.9	*	*			1538.19
194.8	*				1538.98
194.7	*	*			1539.77
194.6	*				1540.56
194.5	*	*		(194.45)	1541.35
194.4	*				1542.14
194.3	*	*		(194.2)	1542.94
194.2	*				1543.73
194.1	*	*			1544.53
194.0	*				1545.32
193.9	*	*	*		1546.12
193.8	*				1546.92
193.7	*	*	(193.675)	*	1547.72
193.6	*				1548.51
193.5	*	*	(193.525)		1549.32
193.4	*				1550.12
193.3	*	*	(193.35)	*	1550.92
193.2	*				1551.72
193.1	*	*	*	*	1552.52
193.0	*				1553.33
192.9	*	*	*		1554.13
192.8	*				1554.94

**Table IV.1/G.692 – Suggested channel central frequency choices
for 4- or 8-channel applications on G.653 fibres (concluded)**

Frequency in THz	100 GHz spacing (8 channels or more)	200 GHz spacing (4 channels or more)	Alternate 200 GHz spacing (4 or 8 channels) 25 GHz offset	Alternate 200 GHz spacing (4 or 8 channels) 50 GHz offset	Wavelength in vacuum in nm
	Unequal spacing on nominal frequency grid		Unequal spacing by offset from nominal frequency grid		
192.7	*	*	(192.625)	(192.75)	1555.75
192.6	*				1556.55
192.5	*	*	*	(192.45)	1557.36
192.4	*				1558.17
192.3	*	*		*	1558.98
192.2	*				1559.79
192.1	*	*			1560.61

APPENDIX V

A channel-allocation methodology for applications on G.653 fibre based on unequal channel spacing

Introduction

The transmission distance of multichannel systems over G.653 fibre is known to be severely restricted by Four-Wave Mixing (FWM) when channels are equally allocated in frequency. However, this restriction can be mitigated when, for example, the channels are unequally allocated. (See Appendix II, and 3.2/G.663 for further information).

Figure V.1 a) shows an example of signal frequencies allocated at equal spacing and resultant FWM optical powers, in which some FWM optical powers overlap the signal optical power thus degrading the transmission performance. Figure V.1 b) shows an example for unequal spacing, where unwanted overlap is avoided. This Appendix provides a channel-allocation methodology for G.653 fibres based on unequal channel spacing.

NOTE – The applicability of this methodology was confirmed up to 12 channels, although the text is described mostly for an 8-channel system.

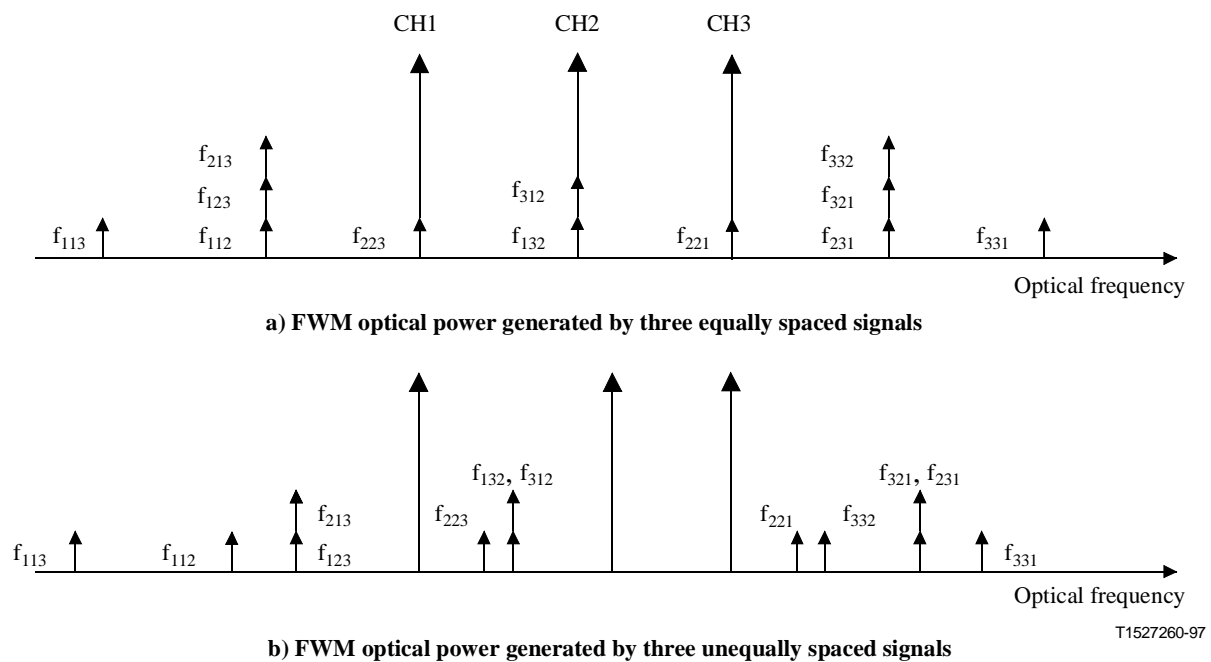

Figure V.1/G.692 – An Example of signal frequencies and resultant FWM optical powers

V.1 How to determine unequally-spaced channel frequencies

V.1.1 Basic design conditions

Firstly, it is necessary to meet the following two conditions.

(1-1) Unequally-spaced channel frequencies should, as many as possible, be on the 100 GHz grid given in Annex A. If some channel frequencies cannot be on the grid, they should be within the range of the temperature control of lasers that meet the grid.

Condition (1-1) aims to commonly use optical sources both in equally-spaced multichannel systems on G.652 and G.655 fibres and, in unequally-spaced multichannel systems on G.653 fibres.

(1-2) Each unequally-spaced channel frequency should be chosen such that no new optical power generated by FWM fall into any optical signal channel.

To meet (1-2), the channel spacing of any two channels must be different from that of any other pair of channels [1]. This is because the original signal frequencies f_i , f_j and f_k and resultant FWM optical power frequency f_{ijk} are linked by the following equation:

$$f_{ijk} - f_i = f_j - f_k (i, j \neq k) \quad (\text{V-1})$$

To practically select signal frequencies, "frequency slot"s denoted as "fs"s are to be used. In addition, each channel spacing is set to an integer multiple of f_s ($f_s \times n_i$, $i = 1, 2, \dots, N - 1$, where N is the number of channels), while ensuring that all channel spacing is different. Then, f_s is equal to the minimum frequency difference between FWM optical powers and optical signals. The set of the integers n_i should be selected to minimise the optical bandwidth that accommodates all signals.

Examples of sets of integers n_i for 8-channel systems that satisfy condition (1-2) are shown in Table V.1 and in reference [1].

Table V.1/G.692 – Sets of n_i for unequally spaced 8-channel allocation

Minimum n_i	Sets of n_i which minimise total optical bandwidth	Number of sets	Number of slots (Σn_i)	Examples
1	1,2,3,5,6,7,10	2	34	(1,3,5,6,7,10,2)
2	2,3,4,5,7,8,10	2	39	(2,4,10,3,8,7,5)
	2,3,4,5,6,8,11	2		(3,6,11,5,2,8,4)
	2,3,4,5,6,9,10	4		(2,6,5,10,4,3,9)
	2,3,4,5,6,7,12	14		(3,7,12,2,6,5,4)
	2,3,4,6,7,8,9	2		(3,2,8,4,7,9,6)
3	3,4,5,6,7,8,10	10	43	(3,6,7,4,8,10,5)
4	4,5,6,7,8,9,10	76	49	(8,9,7,6,5,10,4)
5	5,6,7,8,9,10,11	206	56	(9,6,7,10,8,11,5)
6	6,7,8,9,10,11,12	506	63	(6,7,8,9,10,12,11)

In addition to (1-1), (1-2), the following condition (1-3) needs to be considered.

(1-3) Sum of the frequency differences between each unequally spaced frequency and the nearest grid frequency should be minimum.

V.1.2 Determination of frequency slot

To determine signal frequencies, the minimum value of frequency slot should be first found out. To understand how to clarify the optimum "minimum frequency slot" 10 Gbit/s, three-channel transmission is simulated as shown in Figure V.2 a).

It is assumed that the three channels are externally modulated. The calculated penalty values against frequency slot are shown in Figure V.2 b) for the BER of 10^{-12} . The result indicates that frequency slot should be >20 GHz for penalties of <0.5 dB.

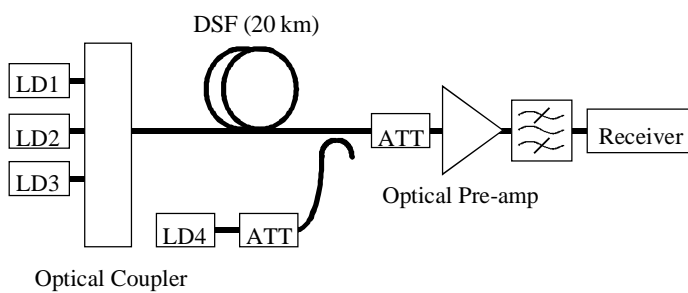
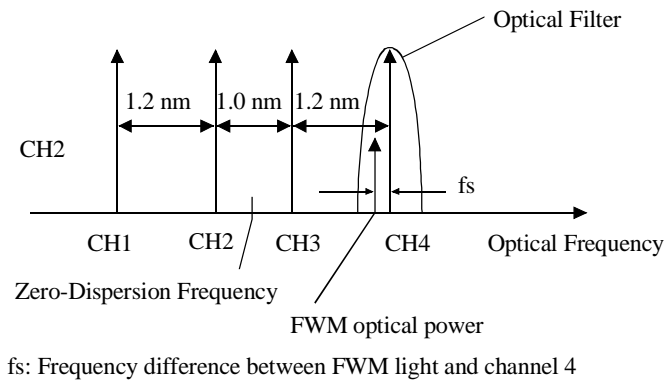

Fibre loss	0.22 dB/km
Dispersion Slope	0.07 ps/km/nm/nm
Non-linear Refractive Index, n_2	$2.7 \times 10^{-20} \text{ m}^2/\text{W}$
Effective Area, A_{eff}	$50 \mu\text{m}^2$

a)

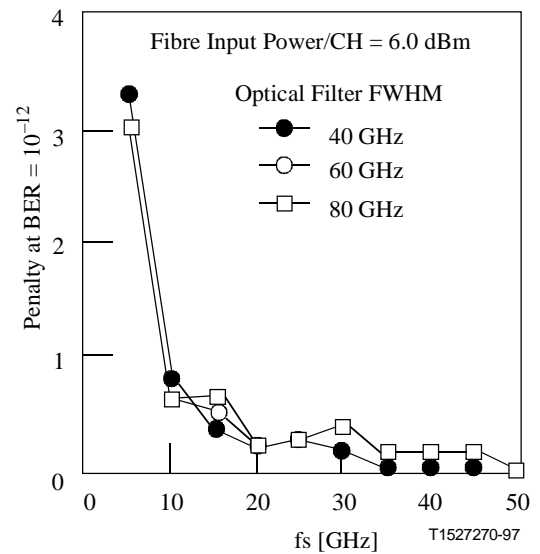

b)

Figure V.2/G.692 – Penalty Versus fs

Furthermore, when each optical signal frequency fluctuates by Δf , the frequency difference is reduced by $4\Delta f$, in the worst case as is understood from Equation V-1. If the source frequency fluctuation is suppressed to less than 1 GHz by using a frequency stabilisation [2], the frequency difference between the optical signal and the nearest FWM optical power is reduced from 24 GHz to 20 GHz in the worst case as is understood from Equation V-1. Since the best frequency stability achievable with conventional technologies today is ~ 1 GHz, it is concluded that a quarter of the 100 GHz grid spacing, or 25 GHz, is suitable as the minimum frequency slot.

V.1.3 Required optical bandwidth for unequally spaced frequency allocation

The required optical bandwidth for each frequency slot is shown in Figure V.3. The required optical bandwidth can be calculated from Table V.1.

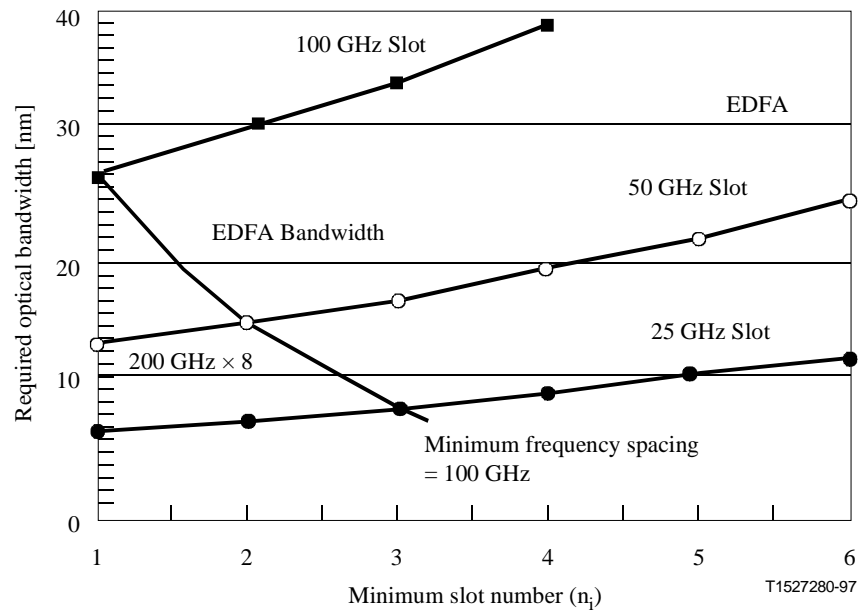

Figure V.3/G.692 – Required optical bandwidth

V.2 Unequally spaced channel frequency allocation with 25 GHz frequency slot

The design conditions for an unequally spaced frequency allocation with 25 GHz slot are as follows:

(2-1) The occupied optical bandwidth should be less than that of an 8-channel WDM system with 200 GHz equal channel spacing (11.2 nm) so that optical amplifiers with the same gain bandwidth can be used.

(2-2) The minimum frequency spacing is 125 GHz.

The widest minimum frequency spacing should be selected within the allowable optical bandwidth so as to reduce the pump depletion effect due to FWM. As shown in Figure V.3 GHz (25 GHz \times 5) is suitable for the minimum channel spacing in this case.

(2-3) Channel spacing is determined according to 25 GHz \times M (M = 5, 6, 7, 8, 9, 10, 11) to put all channels in the optical bandwidth of 11.2 nm. An integral set which satisfies the design condition (1-2) and (1-3) is selected. There are 206 combinations that satisfy the design condition.

(2-4) The maximum frequency difference between each unequally spaced frequency and the nearest 200 GHz grid frequency should be less than 75 GHz so that the unequally spaced frequencies can be tuned from the nearest 200 GHz grid frequency by controlling only the temperature.

V.3 Unequally spaced channel frequency allocation with 50 GHz frequency slot

The design conditions for unequally spaced frequency allocation with the 50 GHz slot are as follows:

(3-1) The optical signal wavelength should be less than 1560 nm, and occupied optical bandwidth should be less than 20 nm so that wideband Er³⁺ doped optical fibre amplifiers can be used [3].

(3-2) The minimum frequency spacing is 150 GHz (50 GHz \times 3).

As mentioned in (2-2) of subclause V.2, a minimum frequency spacing of more than 100 GHz is suitable.

(3-3) Channel spacing is determined according to 50 GHz \times M (M = 3, 4, 5, 6, 7, 8, 10) to minimise optical total bandwidth and satisfy the design conditions shown in V.1.

V.4 Unequal channel frequency allocation with 100 GHz frequency slot

The design conditions for an unequally spaced frequency allocation with 100 GHz slot are as follows:

(4-1) All optical signal wavelengths should lie in the range from 1530 nm to 1561 nm so that Er³⁺ doped fluoride fibre amplifiers can be used.

(4-2) The optical signal should not fall into the wavelength range around 1549 nm because Er³⁺ doped fluoride fibre amplifiers have a gain dip around this region.

(4-3) The minimum frequency spacing is 200 GHz.

There is no allocation that satisfies design conditions (4-1) and (4-2), if 100 GHz is selected as the minimum frequency spacing. Therefore, 200 GHz is more suitable as the minimum frequency spacing.

(4-4) Channel spacing is determined according to 100 GHz × M [M = (2, 3, 4, 5, 7, 8, 10), (2, 3, 4, 5, 6, 8, 11), (2, 3, 4, 5, 6, 9, 10), (2, 3, 4, 5, 6, 7, 12), (2, 3, 4, 6, 7, 8, 9)] to minimise optical total bandwidth and satisfy design condition (4-2) and (4-3).

V.5 Impacts of unequal spacing on other parameters

V.5.1 Frequency deviation for unequal spacing with frequency offset

As mentioned in subclause V.1, the minimum frequency slot should be more than 20 GHz when 10 Gbit/s is assumed as the transmission bit-rate. This means that the minimum frequency difference between an optical signal and the nearest FWM optical power should be more than 2.0 times the bit-rate when there is no frequency deviation. Furthermore, when each optical signal frequency fluctuates Δf, the frequency difference is reduced by 4Δf. Therefore, allowable frequency deviation is given by:

$$\Delta f \leq \frac{fs - 2.0 B}{4} \quad (\text{V-1})$$

where fs is the frequency slot.

When the transmission bit-rate is 2.5 Gbit/s, the allowable frequency deviation is as is shown in Table V.2.

Table V.2/G.692 – Allowable frequency deviation (2.5 Gbit/s)

Frequency slot	25	50	100
Maximum Central Frequency Deviation ± GHz	4-5	11	23

V.5.2 Power Levels

Unequal spacing will lead to limitation of the maximum fibre input power. Details are for further study.

V.6 Bibliography

- [1] FORGHIERI (F.), TKACH (R.W.), CHRAPLYVY (A.R.), MARCUSE (D.): Reduction of Four-Wave Mixing Crosstalk in WDM Systems Using Unequally Spaced Channels, *IEEE Photon. Technol. Lett.*, Vol. 6, No. 6, pp. 754-756, 1994.

- [2] ODA (K.), TOBA (H.), NOSU (K.): Long Term Laboratory Test of a Fully-Engineered 128 Channel Optical FDM Distribution System, in *ECOC'93, paper TuP4.3*, pp. 117-120, 1993.
- [3] KASHIWADA (T.), NAKAZATO (K.), OHNISHI (M.), KANAMORI (H.), NISHIMURA (M.): Spectral Gain Behavior of Er-doped Fibre with Extremely High Aluminum Concentration, *OAA '93, MA6-1*, 1993.

APPENDIX VI

Use of pre-equalisation at MPI-S

Pre-equalisation can be used at interface MPI-S to increase the amount of line amplifier gain variation and gain tilt that can be tolerated by a system while still maintaining a certain level of maximum channel power difference. This in turn ensures that amplifier designs and wavelength plans are not overly constrained.

Pre-equalisation partially compensates amplifier gain variation and gain tilt using the following scheme. The highest channel power at MPI-S is assigned to the channel that will undergo the least line amplifier gain, whereas the lowest channel power at MPI-S is assigned to the channel that will undergo the most channel line amplifier gain. Apart from specifying the maximum difference between any two channel powers at MPI-S, the channel power variation is also specified. This bounds the power variation at MPI-S of any particular channel and the channel dependent loss ranges associated with the optical paths between the transmitter interfaces S_1 - S_n and MPI-S. Pre-equalisation is most readily applicable to mitigating tolerances that have a systematic variation.

If pre-equalisation is not used, the amount of channel power difference at the transmit interface MPI-S leads to a reduction in the amount of amplifier gain variation and gain tilt that can be tolerated by the system. Therefore, in this case, one has to minimise the amount of channel power difference at MPI-S.

APPENDIX VII

Extension of G.692 to include bidirectional WDM transmission

Unidirectional WDM is the transmission of all optical channels on a fibre propagating simultaneously in the same direction (see Figure VII.1). Bidirectional WDM is the transmission of optical channels on a fibre propagating simultaneously in both directions (see Figure VII.2).

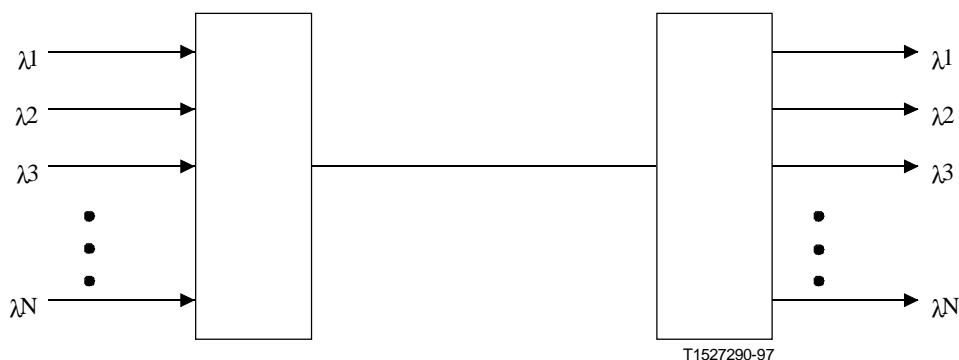

Figure VII.1/G.692 – Unidirectional WDM

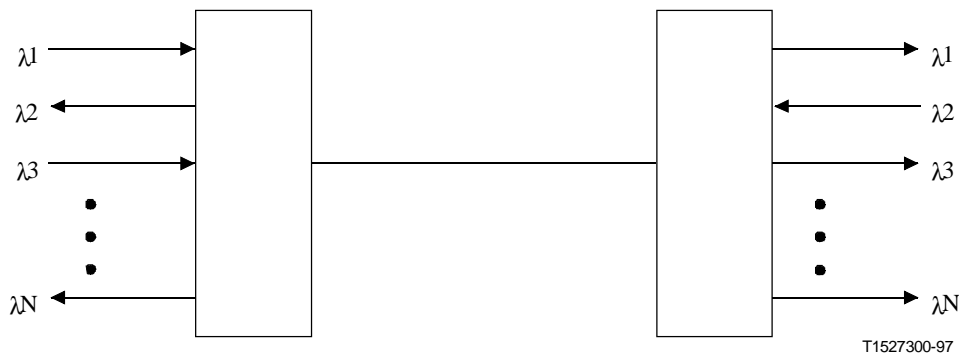

Figure VII.2/G.692 – Bidirectional WDM

In general, bidirectional WDM can lead to a reduction in the number of fibres and line amplifiers required as compared to systems using unidirectional WDM. A further benefit of bidirectional WDM may be performance improvement with respect to Four-Wave Mixing (FWM), particularly when being deployed with G.653 fibres.

Bidirectional WDM design must take into consideration several key systems issues. Care must be taken to optical reflections in order to avoid Multi Path Interference (MPI). Some additional considerations are types and values of crosstalk, values and interdependence of power levels for both directions of transmission, OSC transmission, and automatic power shutdown. Details are for further study.

Full specification of bidirectional WDM in this Recommendation may require additional application codes to be defined, as well as a modification of some existing and addition of new parameter definitions.

APPENDIX VIII

Extension of G.692 to include 16- and 32- or more channel transmission

With respect to market needs, the scope of G.692 has been extended to multichannel long-haul line systems with 16 and 32 or more channels. This extension has an impact on parameters and its values in the main part of G.692, for example, on:

- number and allocation of frequencies needed;
- frequency spacings;
- achievable total distances; and
- maximum nominal optical channel power,

which may lead to additional application codes.

The suggested channel central frequencies in Tables III.1 and IV.1 can be used to allocate 16 or 32 channels, for example:

- 16 channels with 100 GHz or 200 GHz spacing; or
- 32 channels with 100 GHz spacing.

In addition to central frequencies and frequency spacings, other optical parameters and the associated values for 16- and 32- or more (possibly with 50 GHz spacing) channel systems must be defined, which are for further study.

APPENDIX IX

Extension of G.692 to include STM-64 bit-rate

With respect to market requirements, the scope of G.692 has been extended to multichannel long-haul systems with STM-64 (10 Gbit/s) bit-rate. This extension has an impact on parameters and its values in the main part of G.692, for example, on:

- achievable total distances of multichannel systems for STM-64; and
- dispersion accommodation technique,

which may lead to additional application codes.

STM-64 WDM systems on G.652 fibres require a dispersion accommodation technique for all STM-64 application codes.

ITU-T RECOMMENDATIONS SERIES

- Series A Organization of the work of the ITU-T
- Series B Means of expression: definitions, symbols, classification
- Series C General telecommunication statistics
- Series D General tariff principles
- Series E Overall network operation, telephone service, service operation and human factors
- Series F Non-telephone telecommunication services
- Series G Transmission systems and media, digital systems and networks**
- Series H Audiovisual and multimedia systems
- Series I Integrated services digital network
- Series J Transmission of television, sound programme and other multimedia signals
- Series K Protection against interference
- Series L Construction, installation and protection of cables and other elements of outside plant
- Series M TMN and network maintenance: international transmission systems, telephone circuits, telegraphy, facsimile and leased circuits
- Series N Maintenance: international sound programme and television transmission circuits
- Series O Specifications of measuring equipment
- Series P Telephone transmission quality, telephone installations, local line networks
- Series Q Switching and signalling
- Series R Telegraph transmission
- Series S Telegraph services terminal equipment
- Series T Terminals for telematic services
- Series U Telegraph switching
- Series V Data communication over the telephone network
- Series X Data networks and open system communications
- Series Y Global information infrastructure
- Series Z Programming languages