



INTERNATIONAL TELECOMMUNICATION UNION

**ITU-T**

TELECOMMUNICATION  
STANDARDIZATION SECTOR  
OF ITU

**F.400/X.400**

(07/96)

SERIES F: NON-TELEPHONE TELECOMMUNICATION  
SERVICES

Message handling services

SERIES X: DATA NETWORKS AND OPEN SYSTEM  
COMMUNICATION

Message Handling Systems

---

**Message handling system and service overview**

ITU-T Recommendation F.400/X.400

(Previously "CCITT Recommendation")

---

ITU-T F-SERIES RECOMMENDATIONS  
NON-TELEPHONE TELECOMMUNICATION SERVICES

TELEGRAPH SERVICE	F.1-F.109
Operating methods for the international public telegram service	F.1-F.19
The gentex network	F.20-F.29
Message switching	F.30-F.39
The international telemesssage service	F.40-F.58
The international telex service	F.59-F.89
Statistics and publications on international telegraph services	F.90-F.99
Scheduled and leased communication services	F.100-F.104
Phototelegraph service	F.105-F.109
MOBILE SERVICE	F.110-F.159
Mobile services and multideestination satellite services	F.110-F.159
TELEMATIC SERVICES	F.160-F.399
Public facsimile service	F.160-F.199
Teletex service	F.200-F.299
Videotex service	F.300-F.349
General provisions for telematic services	F.350-F.399
<b>MESSAGE HANDLING SERVICES</b>	<b>F.400-F.499</b>
DIRECTORY SERVICES	F.500-F.549
DOCUMENT COMMUNICATION	F.550-F.599
Document communication	F.550-F.579
Programming communication interfaces	F.580-F.599
DATA TRANSMISSION SERVICES	F.600-F.699
AUDIOVISUAL SERVICES	F.700-F.799
ISDN SERVICES	F.800-F.849
UNIVERSAL PERSONAL TELECOMMUNICATION	F.850-F.899
HUMAN FACTORS	F.900-F.999

*For further details, please refer to ITU-T List of Recommendations.*

## FOREWORD

The ITU-T (Telecommunication Standardization Sector) is a permanent organ of the International Telecommunication Union (ITU). The ITU-T is responsible for studying technical, operating and tariff questions and issuing Recommendations on them with a view to standardizing telecommunications on a worldwide basis.

The World Telecommunication Standardization Conference (WTSC), which meets every four years, establishes the topics for study by the ITU-T Study Groups which, in their turn, produce Recommendations on these topics.

The approval of Recommendations by the Members of the ITU-T is covered by the procedure laid down in WTSC Resolution No. 1 (Helsinki, March 1-12, 1993).

ITU-T Recommendation F.400/X.400 was revised by ITU-T Study Group 1 (1993-1996) and was approved under the WTSC Resolution No. 1 procedure on the 19th of July 1996.

---

## NOTE

In this Recommendation, the expression "Administration" is used for conciseness to indicate both a telecommunication administration and a recognized operating agency.

© ITU 1997

All rights reserved. No part of this publication may be reproduced or utilized in any form or by any means, electronic or mechanical, including photocopying and microfilm, without permission in writing from the ITU.

## CONTENTS

	<i>Page</i>
1 Scope .....	1
2 Normative references .....	1
3 Definitions.....	5
4 Abbreviations .....	5
5 Conventions .....	6
6 Purpose.....	6
7 Functional model of MHS.....	7
8 Message Transfer service .....	12
9 IPM service .....	14
10 Intercommunication with physical delivery services .....	17
11 Specialized access .....	18
12 Naming and addressing .....	19
13 MHS use of directory .....	20
14 Distribution lists in MHS .....	21
15 Security capabilities of MHS .....	24
16 Conversion in MHS.....	29
17 Use of the MHS in provision of public services .....	29
18 Elements of service – Purpose .....	29
19 Elements of service – Classification .....	33
Annex A – Glossary of terms .....	41
Annex B – Definitions of elements of service.....	60
Annex C – Elements of service changes from 1992.....	82
Annex D – Differences between ITU-T Recommendation F.400 and ISO/IEC International Standard 10021-1 .	83
Annex E – Multinational PRMD .....	84

## INTRODUCTION

This Overview is one of a set of Recommendations for message handling. The entire set provides a comprehensive specification for message handling comprising any number of cooperating open-systems.

Message handling systems and services enable users to exchange messages on a store-and-forward basis. A message submitted by one user, the originator, is conveyed by the Message Transfer System (MTS), the principal component of a larger Message Handling System (MHS), and message is subsequently delivered to one or more additional users, the message's recipients.

An MHS comprises a variety of interconnected functional entities. Message Transfer Agents (MTAs) cooperate to perform the store-and-forward message transfer function. Message Stores (MSs) provide storage for messages and enable their submission, retrieval and management. User Agents (UAs) help users access the MHS. Access Units (AUs) provide links to other communication systems and services of various kinds (e.g. telematic services, postal services).

This Overview specifies the overall system and service description of message handling capabilities.

This Overview is technically aligned between ITU-T and ISO/IEC.

In the CCITT *Blue Book* (1988), Recommendations F.400 and X.400 were identical. Recommendation X.400 will not be published, but be kept as a title for reference purposes only carrying a reference to Recommendation F.400. This allows existing references to remain unchanged.



## **MESSAGE HANDLING SYSTEM AND SERVICE OVERVIEW**

*(revised in 1996)*

### **1 Scope**

This Overview defines the overall system and service of an MHS and serves as a general overview of MHS.

Other aspects of message handling systems and services are defined in other Recommendations. The layout of Recommendations defining the message handling system and services is shown in Table 1. The public services built on MHS, as well as access to and from the MHS for public services are defined in the F.400-Series Recommendations.

The technical aspects of MHS are defined in the X.400-Series Recommendations. The overall system architecture of MHS is defined in Recommendation X.402 and ISO/IEC 10021-2.

### **2 Normative references**

The following Recommendations and International Standards contain provisions which, through reference in this text, constitute provisions of this Recommendation. At the time of publication, the editions indicated were valid. All Recommendations and Standards are subject to revision, and parties to agreements based on this Recommendation are encouraged to investigate the possibility of applying the most recent editions of the Recommendations and Standards listed below. Members of IEC and ISO maintain registers of currently valid International Standards. A list of the currently valid ITU-T Recommendations is regularly published.

- CCITT Recommendation F.60 (1992), *Operational provisions for the international telex service.*
- ITU-T Recommendation F.160 (1993), *General operational provisions for the international public facsimile service.*
- ITU-T Recommendation F.300 (1993), *Videotex service.*
- CCITT Recommendation F.401 (1992), *Message handling services: Naming and addressing for public message handling services.*
- CCITT Recommendation F.410 (1992), *Message handling services: The public message transfer service.*
- CCITT Recommendation F.415 (1988), *Message handling services: Intercommunication with public physical delivery services.*
- CCITT Recommendation F.420 (1992), *Message handling services: The public interpersonal messaging service.*
- CCITT Recommendation F.421 (1988), *Message handling services: Intercommunication between the IPM service and the telex service.*
- CCITT Recommendation F.423 (1992), *Message handling services: Intercommunication between the interpersonal messaging service and telefax service.*
- CCITT Recommendation F.435 (1991), *Message handling: Electronic data interchange messaging service.*
- CCITT Recommendation F.440 (1992), *Message handling services: The voice messaging service.*
- CCITT Recommendation T.330 (1988), *Telematic access to interpersonal messaging system.*
- ITU-T Recommendation X.200 (1994) | ISO/IEC 7498-1:1994, *Information technology – Open Systems Interconnection – Basic Reference Model: The Basic Model.*
- ITU-T Recommendation X.207 (1993), *Information technology – Open Systems Interconnection – Application layer structure.*

TABLE 1/F.400

**Structure of ITU-T Recommendations and ISO/IEC International Standards  
for Message Handling Systems (MHSs)**

Short title	Joint MHS		Joint support		ITU-T only	
	ITU-T	ISO/IEC	ITU-T	ISO	System	Service
MHS: System and service overview		10021-1				F.400
MHS: Overall architecture	X.402	10021-2				
MHS: Encoded information type conversion rules					X.408	
MHS: MTS: Abstract service definition and procedures	X.411	10021-4				
MHS: MS: Abstract-service definition	X.413	10021-5				
MHS: Protocol specifications	X.419	10021-6				
MHS: Interpersonal messaging system	X.420	10021-7				
MHS: EDI messaging system					X.435	
MHS: Voice messaging system					X.440	
Telematic access to IPMS					T.330	
MHS: Naming and addressing for public MH services						F.401
MHS: The public message transfer service						F.410
MHS: Intercommunication with public physical delivery services						F.415
MHS: The public IPM service						F.420
MHS: Intercommunication between the IPM service and the telex service						F.421
MHS: Intercommunication between the IPM service and the telefax service						F.423
MHS: EDI messaging service						F.435
MHS: The voice messaging service						F.440
Information technology – Open Systems Interconnection – Basic reference model: The basic model			X.200	7498		
Information technology – Abstract Syntax Notation One (ASN.1): Specification of basic notation			X.680	8824-1		
Information technology – Abstract Syntax Notation One (ASN.1) – Specification of basic notation – Amendment 1: Rules of extensibility						
Information technology – ASN.1 encoding rules: Specification of Basic Encoding Rules (BER), Canonical Encoding Rules (CER) and Distinguished Encoding Rules (DER)			X.690	8825		
Information technology – Open Systems Interconnection – Service definition for the association control service element			X.217	8649		
OSI: Reliable transfer: model and service definition			X.218	9066-1		
Information technology – Remote Operations: concepts, model and notation			X.880	9072-1		
Information technology – Remote Operations: OSI realizations – Remote Operations Service Element (ROSE) service definition			X.881			
Information technology – Open Systems Interconnection – Connection-oriented protocol for the association control service element: Protocol specification			X.227	8650		
OSI: Reliable transfer: Protocol specification			X.228	9066-2		
Information technology – Remote Operations: OSI realizations – Remote Operations Service Element (ROSE) protocol specification			X.882	9072-2		



- CCITT Recommendation X.208 (1988), *Specification of Abstract Syntax Notation One (ASN.1)*.  
ISO/IEC 8824:1990, *Information technology – Open Systems Interconnection – Specification of Abstract Syntax Notation One (ASN.1)*.
- CCITT Recommendation X.209 (1988), *Specification of basic encoding rules for Abstract Syntax Notation One (ASN.1)*.  
ISO/IEC 8825:1990, *Information technology – Open Systems Interconnection – Specification of Basic Encoding Rules for Abstract Syntax Notation One (ASN.1)*.
- ITU-T Recommendation X.217 (1995) | ISO/IEC 8649:1996, *Information technology – Open Systems Interconnection – Service definition for the Association Control Service Element*.
- ITU-T Recommendation X.218 (1993), *Reliable transfer: Model and service definition*.  
ISO/IEC 9066-1:1989, *Information processing systems – Text communication – Reliable Transfer – Part 1: Model and service definition*.
- CCITT Recommendation X.219 (1988), *Remote Operations: Model, notation and service definition*.  
ISO/IEC 9072-1:1989, *Information processing systems – Text communication – Remote Operations – Part 1: Model, notation and service definition*.
- CCITT Recommendation X.402 (1992), *Message handling systems: Overall architecture*.  
ISO/IEC 10021-2:1990, *Information technology – Text communication – Message-Oriented Text Interchange Systems (MOTIS) – Part 2: Overall architecture plus Technical Corrigendum 1 (1991), Technical Corrigendum 2 (1991), Technical Corrigendum 3 (1992), and Technical Corrigendum 4 (1992)*.  
ISO/IEC 10021-2:1990/Amd.1:1994, *Information technology – Text Communication – Message-Oriented Text Interchange Systems (MOTIS) – Part 2: Overall Architecture – Amendment 1: Representation of O/R Addresses for Human Usage*.  
ISO/IEC 10021-2:1990/Amd. 2:1994, *Information technology – Text Communication – Message-Oriented Text Interchange Systems (MOTIS) – Part 2: Overall Architecture – Amendment 2: Minor Enhancements*.
- CCITT Recommendation X.407 (1992), *Message handling systems: Abstract service definition conventions*.  
ISO/IEC 10021-3:1990, *Information technology – Text communication – Message-Oriented Text Interchange Systems (MOTIS) – Part 3: Abstract Service Definition Conventions plus Technical Corrigendum 1 (1992)*.
- CCITT Recommendation X.408 (1988), *Message handling systems: Encoded information type conversion rules*.
- CCITT Recommendation X.411 (1992), *Message handling systems: Message transfer systems: Abstract service definition and procedures*.  
ISO/IEC 10021-4:1990, *Information technology – Text communication – Message-Oriented Text Interchange Systems (MOTIS) – Part 4: Message Transfer System: Abstract Service Definition and Procedures plus Technical Corrigendum 1 (1991), Technical Corrigendum 2 (1991), Technical Corrigendum 3 (1992), and Technical Corrigendum 4 (1992)*.  
ISO/IEC 10021-4:1990/Amd. 1:1994, *Information technology – Text Communication – Message-Oriented Text Interchange Systems (MOTIS) – Part 4: Message Transfer System: Abstract Service Definition and Procedures – Amendment 1: Minor Enhancements*.
- ITU-T Recommendation X.413 (1995) | ISO/IEC 10021-5:1995, *Information technology – Message handling systems (MHS): Message store – Abstract service definition*
- CCITT Recommendation X.419 (1992), *Message handling systems: Protocol specifications*.  
ISO/IEC 10021-6:1990, *Information technology – Text communication – Message-Oriented Text Interchange Systems (MOTIS) – Part 6: Protocol Specifications plus Technical Corrigendum 1 (1991), Technical Corrigendum 2 (1991), Technical Corrigendum 3 (1992), and Technical Corrigendum 4 (1992)*.

- CCITT Recommendation X.420 (1992), *Message handling systems: Interpersonal messaging system.*  
 ISO/IEC 10021-7:1990, *Information technology – Text communication – Message-Oriented Text Interchange Systems (MOTIS) – Part 7: Interpersonal Messaging System plus Technical Corrigendum 1 (1991), Technical Corrigendum 2 (1991), Technical Corrigendum 3 (1992), and Technical Corrigendum 4 (1992).*  
 ISO/IEC 10021-7:1990/Amd. 1:1994, *Information technology – Text Communication – Message-Oriented Text Interchange Systems (MOTIS) – Part 7: Interpersonal Messaging System – Amendment 1: Minor Enhancements.*
- CCITT Recommendation X.435 (1991), *Message handling systems: Electronic data interchange messaging system.*  
 ISO/IEC 10021-9:1995, *Information technology – Message Handling Systems (MHS) – Part 9: Electronic Data Interchange Messaging System.*
- CCITT Recommendation X.440 (1992), *Message handling systems: Voice messaging system.*
- ITU-T Recommendation X.460 (1995) | ISO/IEC 11588-1:1995, *Information technology – Message handling systems (MHS) management: Model and architecture.*
- ITU-T Recommendation X.500 (1993) | ISO/IEC 9594-1:1995, *Information technology – Open Systems Interconnection – The Directory: Overview of concepts, models and services.*
- ITU-T Recommendation X.501 (1993) | ISO/IEC 9594-2:1995, *Information technology – Open Systems Interconnection – The Directory: Models.*
- ITU-T Recommendation X.509 (1993) | ISO/IEC 9594-8:1995, *Information technology – Open Systems Interconnection – The Directory: Authentication framework.*
- ITU-T Recommendation X.511 (1993) | ISO/IEC 9594-3:1995, *Information technology – Open Systems Interconnection – The Directory: Abstract service definition.*
- ITU-T Recommendation X.518 (1993) | ISO/IEC 9594-4:1995, *Information technology – Open Systems Interconnection – The Directory: Procedures for distributed operation.*
- ITU-T Recommendation X.519 (1993) | ISO/IEC 9594-5:1995, *Information technology – Open Systems Interconnection – The Directory: Protocol specifications.*
- ITU-T Recommendation X.520 (1993) | ISO/IEC 9594-6:1995, *Information technology – Open Systems Interconnection – The Directory: Selected attribute types.*
- ITU-T Recommendation X.521 (1993) | ISO/IEC 9594-7:1995, *Information technology – Open Systems Interconnection – The Directory: Selected object classes.*
- ITU-T Recommendation X.525 (1993) | ISO/IEC 9594-9:1995, *Information technology – Open Systems Interconnection – The Directory: Replication.*
- ITU-T Recommendation X.680 (1994) | ISO/IEC 8824-1:1995, *Information technology – Abstract Syntax Notation One (ASN.1): Specification of basic notation.*
- ITU-T Recommendation X.680 Amend. 1 (1995), *Information technology – Abstract Syntax Notation One (ASN.1) – Specification of basic notation – Amendment 1: Rules of extensibility.*
- ITU-T Recommendation X.690 (1994), *Information technology – ASN.1 encoding rules: Specification of Basic Encoding Rules (BER), Canonical Encoding Rules (CER) and Distinguished Encoding Rules (DER).*
- ITU-T Recommendation X.880 (1994), *Information technology – Remote Operations: Concepts, model and notation.*
- ITU-T Recommendation X.881 (1994), *Information technology – Remote Operations: OSI realizations – Remote Operations Service Element (ROSE) service definition.*
- ITU-T Recommendation X.882 (1994), *Information technology – Remote Operations: OSI realizations – Remote Operations Service Element (ROSE) protocol specification.*

### 3 Definitions

For the purposes of this Overview, the definitions given in Annex A and the following definitions apply.

Definitions of the elements of service applicable to MHS are contained in Annex B.

#### 3.1 Open Systems Interconnection

This Overview makes use of the following terms defined in ITU-T Rec. X.200 | ISO/IEC 7498-1:

- a) application layer;
- b) application-process;
- c) Open Systems Interconnection;
- d) OSI reference model.

#### 3.2 Directory systems

This Overview makes use of the following terms defined in ITU-T Rec. X.500 | ISO/IEC 9594-1:

- a) directory entry;
- b) directory system agent;
- c) directory system;
- d) directory user agent.

This Overview makes use of the following terms defined in ITU-T Rec. X.501 | ISO/IEC 9594-2:

- e) attribute;
- f) group;
- g) name.

### 4 Abbreviations

For the purposes of this Recommendation, the following abbreviations are used.

A	Additional
ADMD	Administration Management Domain
AU	Access Unit
CA	Contractual Agreement
DL	Distribution List
DSA	Directory System Agent
DUA	Directory User Agent
E	Essential
EDI	Electronic Data Interchange
EIT	Encoded Information Type
EMS	Express Mail Service
I/O	Input/Output
IP	Interpersonal
IPM	Interpersonal Messaging
IPMS	Interpersonal Messaging System
MD	Management Domain
MH	Message Handling
MHS	Message Handling System
MS	Message Store

MT	Message Transfer
MTA	Message Transfer Agent
MTS	Message Transfer System
N/A	Not applicable
O/R	Originator/Recipient
OSI	Open Systems Interconnection
PD	Physical Delivery
PDAU	Physical Delivery Access Unit
PDS	Physical Delivery System
PFAXAU	Public Telefax Access Unit
PM	Per-message
PR	Per-recipient
PRMD	Private Management Domain
PTLXAU	Public Telex Access Unit
RPOA	Recognized Operating Agency
TLMA	Telematic Agent
TLXAU	Telex Access Unit
UA	User Agent

## 5 Conventions

In this Overview the expression “Administration” is used for shortness to indicate a telecommunication administration, a recognized operating agency, and, in the case of intercommunication with public physical delivery service, a postal administration.

## 6 Purpose

This Overview is one of a set of Recommendations which describes the system model and elements of service of the Message Handling System (MHS) and services. This Recommendation overviews the capabilities of an MHS that are used by Service providers for the provision of public Message Handling (MH) services to enable users to exchange messages on a store-and-forward basis.

The message handling system is designed in accordance with the principles of the Reference Model of Open Systems Interconnection (OSI Reference Model) for ITU-T applications (Recommendation X.200) and uses the presentation layer services and services offered by other, more general, application service elements. An MHS can be constructed using any network fitting in the scope of OSI. The message transfer service provided by the MTS is application independent. An example of a standardized application is the IPM service. End systems can use the Message Transfer (MT) service for specific applications that are defined bilaterally.

Message handling services provided by Service providers belong to the group of telematic services defined in F-Series Recommendations.

Various telematic services and telex (see Recommendations F.60, F.160, F.200, F.300, etc.), data transmission services (see Recommendation X.1), or physical delivery services (see Recommendation F.415) gain access to, and intercommunicate with, the IPM service or intercommunicate with each other, via access units.

Elements of service are the service features provided through the application processes. The elements of service are considered to be components of the services provided to users and are either elements of a basic service or they are *optional user facilities*, classified either as *essential optional user facilities*, or as *additional optional user facilities*.

## **7 Functional model of MHS**

The MHS functional model serves as a tool to aid in the development of Recommendations for MHS, and aids in describing the basic concepts that can be depicted graphically. It comprises several different functional components that work together to provide MH services. The model can be applied to a number of different physical and organizational configurations.

### **7.1 Description of the MHS model**

A functional view of the MHS model is shown in Figure 1. In this model, a user is either a person or a computer process. Users are either direct users (i.e. engage in message handling by direct use of MHS), or are indirect users [i.e. engage in message handling through another communication system (e.g. a physical delivery system) that is linked to MHS]. A user is referred to as either an originator (when sending a message) or a recipient (when receiving a message). Message handling elements of service define the set of message types and the capabilities that enable an originator to transfer messages of those types to one or more recipients.

An originator prepares messages with the assistance of his user agent. A User Agent (UA) is an application process that interacts with the Message Transfer System (MTS) or a Message Store (MS), to submit messages on behalf of a single user. The MTS delivers the messages submitted to it, to one or more recipient UAs, Access Units (AUs), or MSs, and can return notifications to the originator. Functions performed solely by the UA and not standardized as part of the message handling elements of service are called local functions. A UA can accept delivery of messages directly from the MTS, or it can use the capabilities of a MS to receive delivered messages for subsequent retrieval by the UA.

The MTS comprises a number of Message Transfer Agents (MTAs). Operating together, in a store-and-forward manner, the MTAs transfer messages and deliver them to the intended recipients.

Access by indirect users of MHS is accomplished by AUs. Delivery to indirect users of MHS is accomplished by AUs, such as in the case of physical delivery, by the Physical Delivery Access Unit (PDAU).

The Message Store (MS) is an optional general purpose capability of MHS that acts as an intermediary between the UA and the MTA. The MS is depicted in the MHS Functional Model as shown in Figure 1. The MS is a functional entity whose primary purpose is to store delivered, and, optionally, submitted messages and permit their retrieval by the MS-user (UA). The MS also allows for submission from, and alerting to the MS-user.

The collection of UAs, MSs, AUs and MTAs is called the Message Handling System (MHS).

### **7.2 Structure of messages**

The basic structure of messages conveyed by the MTS is shown in Figure 2. A message is made up of an envelope and a content. The envelope carries information that is used by the MTS when transferring the message within the MTS. The content is the piece of information that the originating UA wishes delivered to one or more recipient UAs. The MTS neither modifies or examines the content, except for conversion (see clause 16).

### **7.3 Application of the MHS model**

#### **7.3.1 Physical mapping**

Users access UAs for message processing purposes, for example, to create, present, or file messages. A user can interact with a UA via an input/output (I/O) device or process (e.g. keyboard, display, printer etc.). A UA can be implemented as a (set of) computer process(es) in an intelligent terminal.

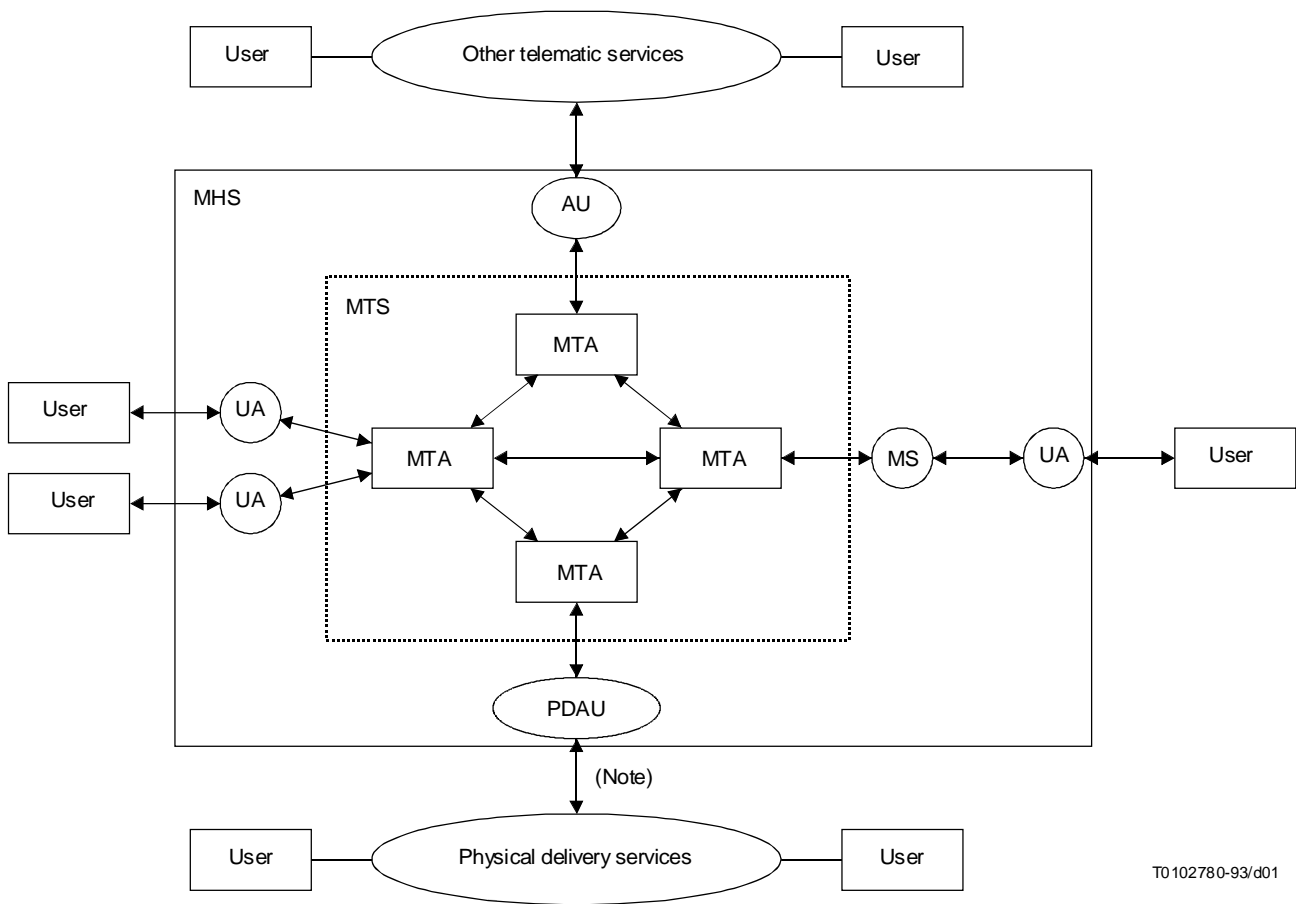

T0102780-93/d01

NOTE – Message input from PDS to MHS is for further study. Flow from PD services to the PDAU shown is for the purpose of notifications.

FIGURE 1/F.400  
MHS functional model

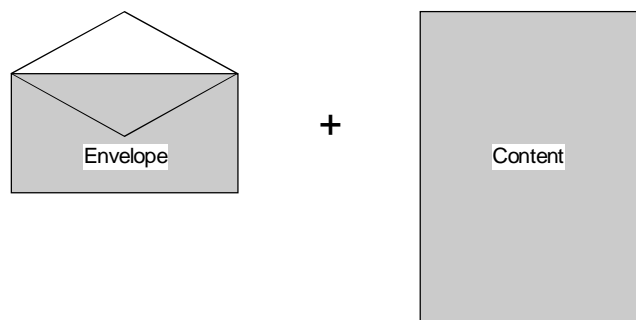

T0102790-93/d02

FIGURE 2/F.400  
Basic message structure

A UA and MTA can be co-located in the same system, or a UA/MS can be implemented in physically separate systems. In the first case the UA accesses the MT elements of service by interacting directly with the MTA in the same system. In the second case, the UA/MS will communicate with the MTA via standardized protocols specified for MHS. It is also possible for an MTA to be implemented in a system without UAs or MSs.

Some possible physical configurations are shown in Figures 3 and 4. The different physical systems can be connected by means of dedicated lines or switched network connections.

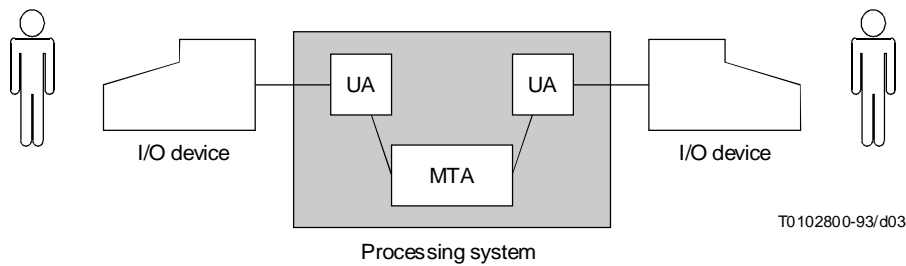

FIGURE 3/F.400  
Co-resident UA and MTA

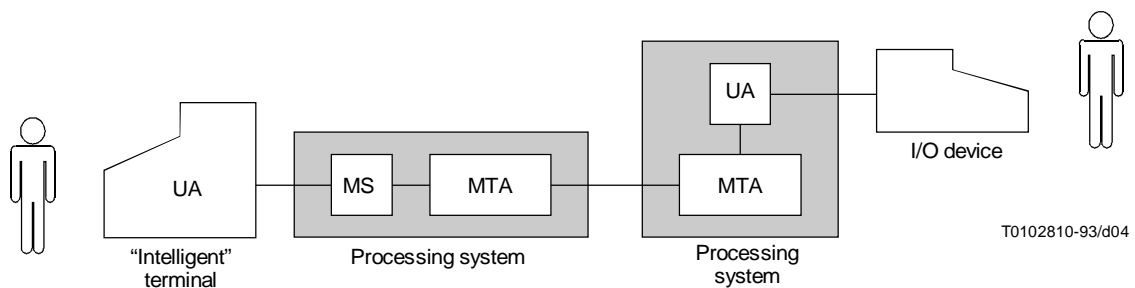

FIGURE 4/F.400  
Stand-alone UA and co-resident MS/MTA and UA/MTA

### 7.3.2 Organizational mapping

An Administration or organization can play various roles in providing message handling services. An organization in this context can be a company or a non-commercial enterprise.

The collection of at least one MTA, zero or more UAs, zero or more MSs, and zero or more AUs operated by a service provider or organization constitutes a Management Domain (MD). An MD managed by a service provider is called an Administration Management Domain (ADMD). An MD managed by an organization other than a service provider is called a Private Management Domain (PRMD). An MD provides message handling services in accordance with the classification of elements of service as described in clause 19. The relationships between management domains is shown in Figure 5.

### 7.3.3 Administration management domain

In one country, one or more ADMDs can exist. An ADMD is characterized by its provision of relaying functions between other management domains and the provision of the message transfer service for the applications provided within the ADMD.

A service provider can provide access for its users to the ADMD in one or more of the following ways:

- user to service provider-provided UA;
- private UA to service provider MTA;
- private UA to service provider MS;
- private MTA to Service provider MTA;
- user to service provider-provided AU.

See also the examples of configurations shown in Figures 3 and 4.

Service provider-provided UAs can exist as part of an intelligent terminal that the user can use to access the MHS. They can also exist as part of service provider resident equipment which itself is part of the MHS. In this case the user obtains access to the UA via an I/O device.

In the case of a private UA, the user has a private stand-alone UA which interacts with the service provider-provided MTA or MS, using submission, delivery and retrieval functions. A private, stand-alone UA can be associated with one or more MDs, provided that the required naming conventions are preserved.

A private MTA as part of a PRMD can access one or more ADMDs in a country, following national regulations.

Access can also be provided by service provider-provided AUs described in clauses 10 and 11.

#### **7.3.4 Private management domain**

An organization other than a service provider can have one or more MTA(s), and zero or more UAs, AUs and MSs forming a PRMD which can interact with an ADMD (or other PRMD) on an MD-to-MD (MTA-to-MTA) basis. A PRMD is characterized by the provision of messaging functions within that management domain.

A PRMD can have access to one or more ADMDs as shown in Figure 5. However, in the case of a specific interaction between a PRMD and an ADMD (such as when a message is transferred between MDs), the PRMD is considered to be associated only with that ADMD. A PRMD may act as a relay to other MDs if national regulations and bilateral agreements permit.

In the interaction between a PRMD and an ADMD, the ADMD takes responsibility for the actions of the PRMD which are related to the interaction. In addition to ensuring that the PRMD properly provides the message transfer service, the ADMD is responsible for ensuring that the accounting, logging, quality of service, uniqueness of names, and related operations of the PRMD are correctly performed. As a national matter, the name of a PRMD can be either nationally unique or relative to the associated ADMD. If a PRMD is associated with more than one ADMD, the PRMD can have more than one name.

See Annex E of this Overview for guidance in the case of multinational PRMDs.

### **7.4 Message Store (MS)**

Remote UAs can be implemented on a wide variety of equipment, including personal computers of varying capabilities. The MS service can complement a remote UA by providing continuously available storage and delivery services on behalf of a user, for example.

One MS acts on behalf of only one user, i.e. it does not provide a common or shared MS capability to several users. See also PRMD 3 of Figure 5.

The MS will store delivered messages and reports. As an option it may also store submitted messages, submitted probes, and draft messages. The MS may also keep a history of messages by storing extracts of previously and currently stored messages in logs. Messages may be grouped in a user-defined and potentially hierarchical structure.

The MS retrieval capability provides users who subscribe to an MS with basic message retrieval capabilities potentially applicable to all information held by the MS. Figure 6 shows the delivery, and subsequent retrieval of messages that are delivered to an MS, and the submission of messages via the MS.

When a user subscribes to an MS, all messages destined for the user are delivered to the MS only. The MS-user, if on line, may receive Alerts that announce the delivery of certain messages to the MS. Messages delivered to an MS are considered delivered from the MTS perspective.

The basic MS is independent of application specific services (see 8.7) and may store messages with all types of content, the type of content being dependent on the type of service. However, it may provide additional capabilities depending on the type of content.

When an MS-user submits a message, the MS conveys the submission request to the MTS and reports the outcome returned by the MTS to the MS-user. If requested by the MS-user, the MS may expand the message by forwarding parts of delivered or submitted messages that are currently stored in the MS before conveying the submission to the MTS. The MS may also store a copy of the message submitted to the MTS if the submission is successful. The MS service allows the user to transfer a message to the MS for storage as a draft message. The draft message may subsequently be retrieved, or the MS may include its body-parts in a message submitted to the MTS when requested in a message submitted by the MS-user.



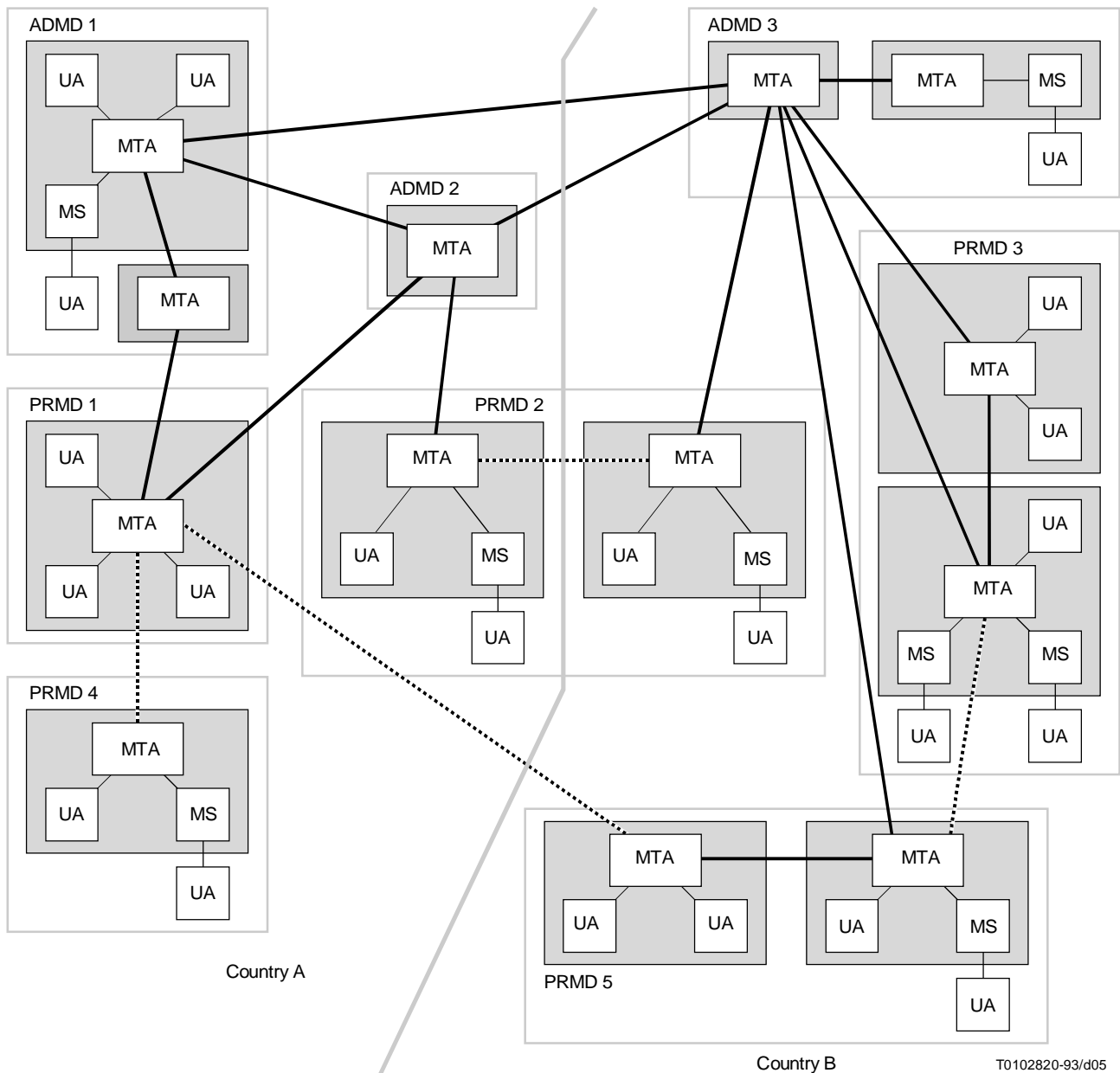

**NOTES**

- 1 The availability of the interconnections represented by the dotted lines between MTAs may be impacted by regulation.
- 2 This diagram gives examples of possible interconnections. It does not attempt to identify all possible configurations. This Overview places no restrictions on interconnections between MDs, although these may be the subject of regulatory agreements within and between countries.
- 3
  - PRMD 1 has connections to two ADMDs within country A;
  - PRMD 2 spans a country border, and has connections to an ADMD in each country;
  - PRMD 3 has multiple connections to ADMD 3;
  - PRMD 4 is only connected to other MDs by relaying through PRMD 1;
  - PRMD 5 has connections to other PRMDs, both within the same country (to PRMD 3) and internationally (to PRMD 1).
- 4 An Administration, in the context of ITU-T, that manages an ADMD, is understood as being a member of ITU or a Recognized Operating Agency (ROA), notified by a Member country to the ITU.
- 5 The lines between MTAs represent logical connections, which implies that the MTAs have the ability to establish associations between themselves when required, using supporting OSI layers over any physical medium.
- 6 The shaded boxes surrounding logical components (e.g. UAs, MTAs) represent examples of physically co-located systems.

**FIGURE 5/F.400**  
**Relationships between management domains**

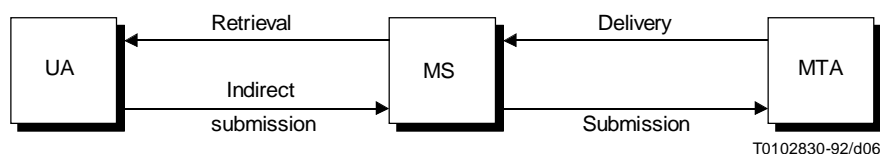

FIGURE 6/F.400

### Submission and delivery with an MS

The MS-user may be provided with the capability to request the MS service to forward selected messages automatically upon delivery. The MS may also provide automatic deletion of messages after a user specified period of time, or when the message expires, or when the message is rendered obsolete by another message.

The MS may automatically attach information to a previously submitted message concerning its delivery or non-delivery. The MS may also generate content-specific notifications, acknowledging receipt or acceptance when requested by the user or when the user has retrieved the message.

The elements of service describing the features of the MS are defined in Annex B and classified in clause 19. Users are provided with the capability based on various criteria, to get counts and lists of messages, to fetch messages, and to delete messages, currently held in the MS.

Figure 7 depicts a simplified model of the information types stored in the MS, and the functions the MS fulfils.

The scope of the MS services defined in CCITT Recommendation F.400 (1988) and (1992) and in ISO/IEC 10021-1:1990 was mainly limited to the storage of delivered messages and reports and their subsequent retrieval by the MS-user. The 1994 version of this part of ISO/IEC 10021 defines new extensions to provide a broader range of service facilities. These enhanced facilities particularly apply in those environments where the MS is used as a personal data base to store, retrieve, modify, and classify a user's messages, often with frequent and long-lasting interaction between the MS-user and MS. Examples of such environments might be found in local area networks, or in environments where the user employs different User Agent implementations at different locations to access one MS. In other environments where the MS is used mainly as a temporary storage system, to take delivery of messages and reports and provide for their retrieval by infrequent and short-lasting interactions, these enhanced facilities may not be required. In this latter case, some enhanced facilities may be provided locally by the MS-user itself.

Consequently, the basic and essential optional requirements defined for the MS in this part of ISO/IEC 10021 are the same as those defined in versions published prior to 1994.

#### 7.4.1 Physical configurations

The MS can be physically located with respect to the MTA in a number of ways. The MS can be co-located with the UA, co-located with the MTA, or stand-alone. From an external point of view, a co-located UA and MS are indistinguishable from a stand-alone UA. Co-locating the MS with the MTA offers significant advantages which will probably make it the predominant configuration.

#### 7.4.2 Organizational configurations

Either ADMDs or PRMDs can operate MSs. In the case of service provider-supplied MSs, the subscriber either provides his own UA or makes use of a service provider-supplied UA via an I/O device. In either case, all the subscriber's messages are delivered to the MS for subsequent retrieval.

The physical and organizational configurations described above are examples only and other equally valid cases can exist.

## 8 Message Transfer service

The MTS provides the general, application independent, store and forward Message Transfer service. The elements of service describing the features of the MT service are defined in Annex B, and classified in clause 19. Provision of the public Message Transfer service by service providers is described in Recommendation F.410.

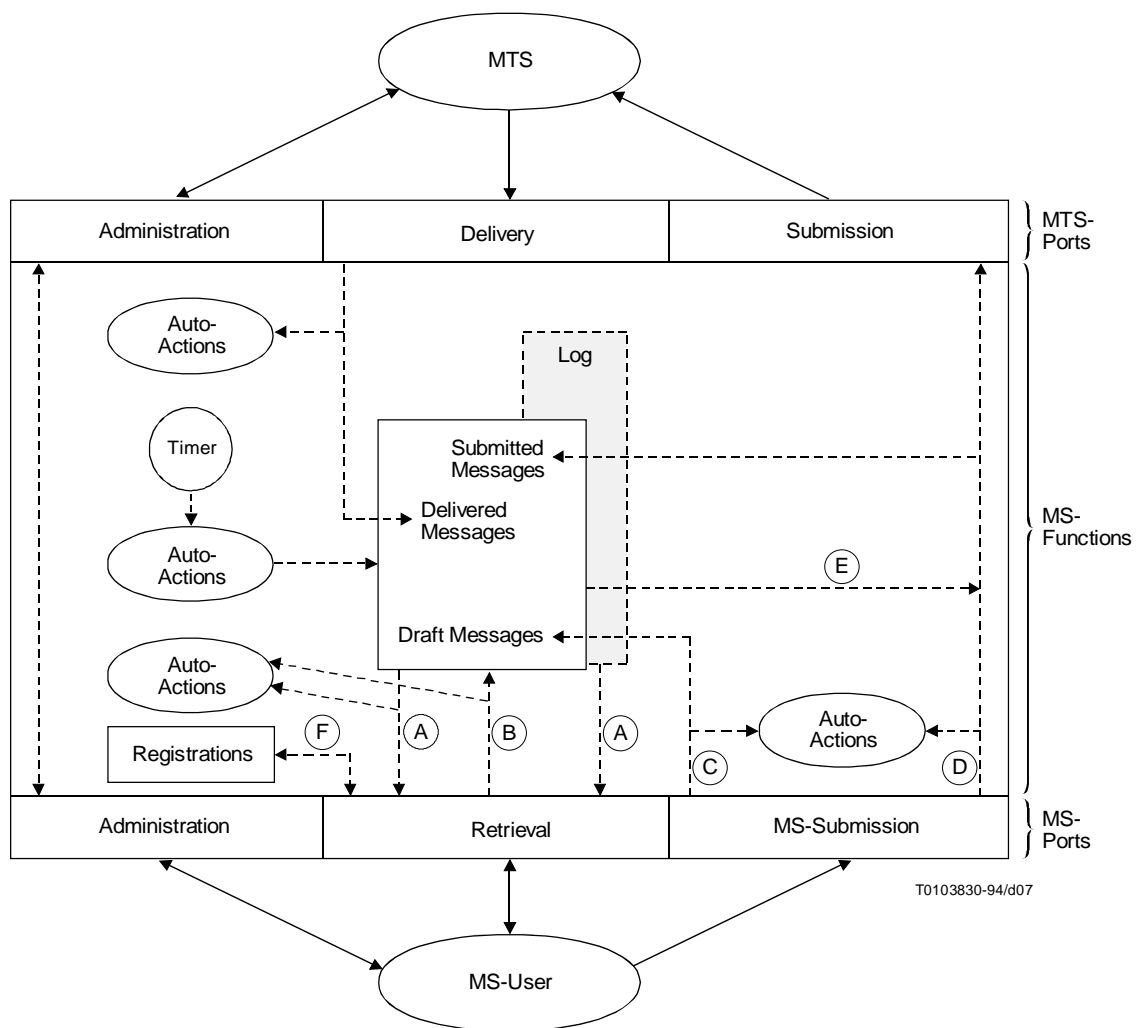

T0103830-94/d07

- (A) Fetch, list and summarize
- (B) Modify message attributes and delete
- (C) Draft storage
- (D) Submission to the MTS
- (E) Submission to the MTS with incorporation of parts of stored messages
- (F) Register-MS

FIGURE 7/F.400  
Message Store functional model

## 8.1 Submission and delivery

The MTS provides the means by which UAs exchange messages. There are two basic interactions between MTAs and UAs, or AUs, or MSs:

- 1) The submission interaction is the means by which an originating UA, AU or MS transfers to an MTA the content of a message and the submission envelope. The submission envelope contains the information that the MTS requires to provide the requested elements of service.
- 2) The delivery interaction is the means by which the MTA transfers to a recipient UA, AU or MS the content of a message plus the delivery envelope. The delivery envelope contains information related to delivery of the message.

In the submission and delivery interactions, responsibility for the message is passed between the MTA and the UA, AU or MS.

## **8.2 Transfer**

Starting at the originator's MTA, each MTA transfers the message to another MTA until the message reaches the recipients' MTA, which then delivers it to the recipient UA or MS using the delivery interaction.

The transfer interaction is the means by which one MTA transfers to another MTA the content of a message plus the transfer envelope. The transfer envelope contains information related to the operation of the MTS plus information that the MTS requires to provide elements of service requested by the originating UA.

MTAs transfer messages containing any type of binary coded information. MTAs neither interpret nor alter the content of messages except when performing a conversion.

## **8.3 Notifications**

Notifications in the MT service comprise the delivery and non-delivery notifications. When a message, or probe, cannot be delivered by the MTS, a non-delivery notification is generated and returned to the originator in a report signifying this. In addition, an originator can specifically ask for acknowledgment of successful delivery through use of the delivery notification element of service on submission.

## **8.4 User Agent**

The UA uses the MT service provided by the MTS. A UA is a functional entity by means of which a single direct user engages in message handling.

UAs are grouped into classes based on the type of content of messages they can handle. The MTS provides a UA with the ability to identify its class when sending messages to other UAs. UAs within a given class are referred to as cooperating UAs since they cooperate with each other to enhance the communication amongst their respective users.

NOTE – A UA can support more than one type of message content, and hence belong to several UA classes.

## **8.5 Message Store**

The user may submit messages through the MS, and retrieve messages that have been either delivered to the MS, or submitted by the user.

## **8.6 Access unit**

An Access Unit (AU) uses the MT service provided by the MTS. An AU is a functional entity associated with an MTA to provide for intercommunication between the MHS and another system or service.

## **8.7 Use of the MTS in the provision of various services**

The MTS is used by application specific services for the provision of message handling services of various types. The interpersonal messaging service, described in clause 9, is one example of this. Other examples are the Electronic Data Interchange (EDI) messaging service described in Recommendation F.435, and the voice messaging service described in Recommendation F.440. Other services (e.g. asynchronous group communications) can be built on the foundation of the MTS, either with corresponding Recommendations or as private applications.

# **9 IPM service**

The Interpersonal Messaging (IPM) service provides a user with features to assist in communicating with other IPM service users. The IPM service uses the capabilities of the MT service for sending and receiving interpersonal messages. The elements of service describing the features of the IPM service are defined in Annex B, and classified in clause 19. The provision of public interpersonal messaging service by service providers is described in Recommendation F.420.

### 9.1 IPM service functional model

Figure 8 shows the functional model of the IPM service. The UAs used in the IPM service (IPM-UAs) comprise a specific class of cooperating UAs. The optional access units shown (TLMA, PTLXAU, PFAXAU) allow for telex, and telefax users to intercommunicate with the IPM service. The optional Physical Delivery Access Unit (PDAU) allows IPM users to send messages to users outside the IPM service who have no access to MHS. The message store can optionally be used by IPM users to take delivery of messages on their behalf.

### 9.2 Structure of IP-messages

The IPM class of UAs create messages containing a content specific to the IPM. The specific content that is sent from one IPM-UA to another is a result of an originator composing and sending a message, called an IP-message. The structure of an IP-message as it relates to the basic message structure of MHS is shown in Figure 9. The IP-message is conveyed with an envelope when being transferred through the MTS.

Figure 10 shows an analogy between a typical office memo, and the corresponding IP-message structure. The IP-message contains information (e.g. To, cc, Subject) provided by the user which is transformed by the IPM-UA into the heading of the IP-message. The main information that the user wishes to communicate (the body of the memo) is contained within the body of the IP-message. In the example shown, the body contains two types of encoded information: text and facsimile, which form what are called, body parts. In general, an IP-message body can consist of a number of body parts, each which can be of a different encoded information type, such as voice, text, files, facsimile and graphics.

### 9.3 IP-notifications

In the IPM service, a user can request a notification of receipt or non-receipt of a message by a recipient. These notifications are requested by an originator and are generated as a result of some recipient action (such as reading/not reading the message). In certain cases, the non-receipt notification is generated automatically by the recipient's UA.

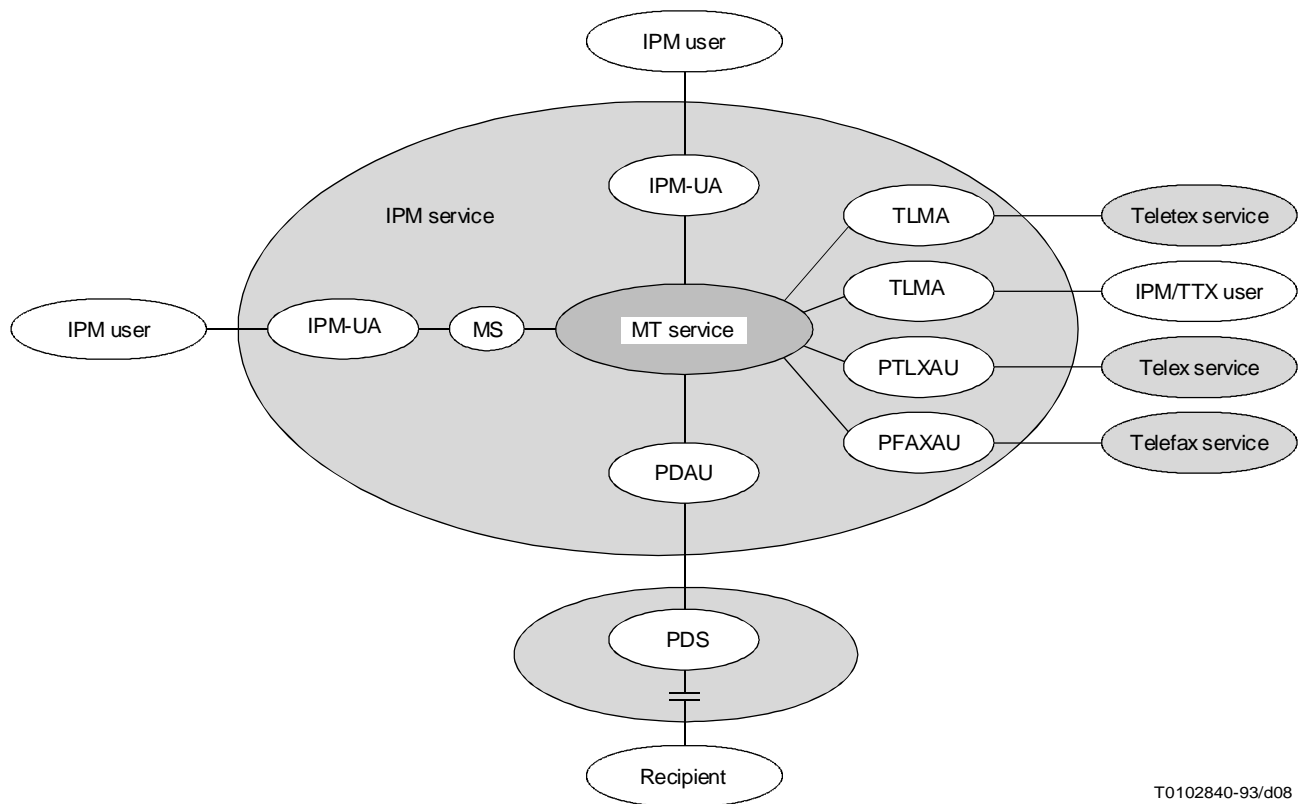

T0102840-93/d08

FIGURE 8/F.400  
IPM service functional model

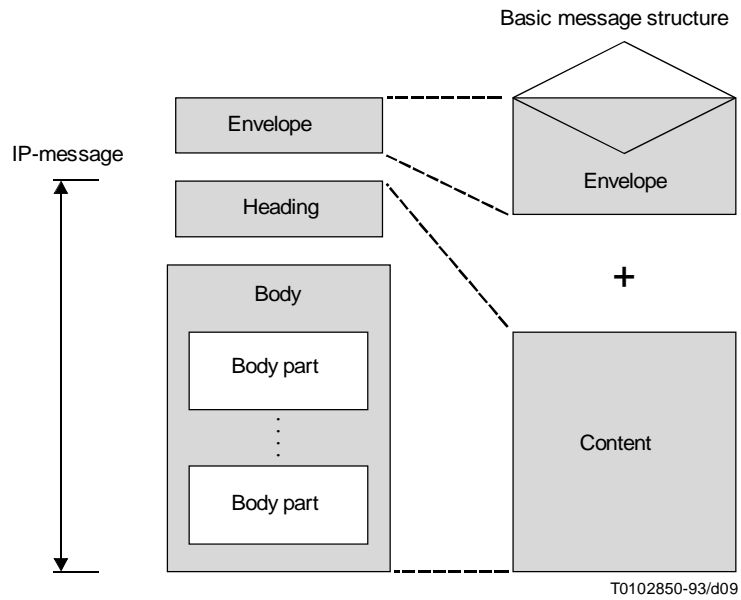

FIGURE 9/F.400  
**IP-message structure**

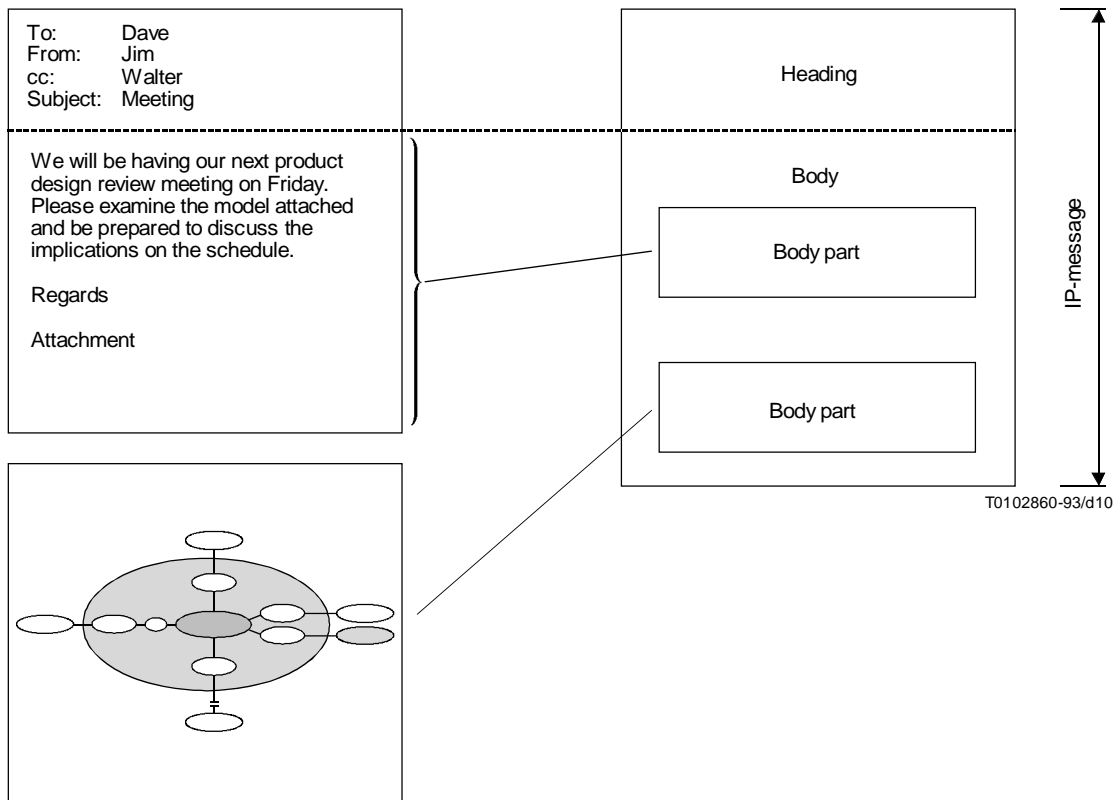

FIGURE 10/F.400  
**IP-message structure for a typical memo**

## 10 Intercommunication with physical delivery services

### 10.1 Introduction

The value of message handling systems can be increased by connecting them to Physical Delivery (PD) systems such as the traditional postal service. This will allow for the physical (e.g. hard copy) delivery of messages originated within MHS to recipients outside of MHS, and in some cases will allow for the return of notifications from the PD service to an MHS originator. The ability for origination of messages in the PD service for submission to MHS through the PDAU is for further study. The capability of intercommunication between PD and MH services is an optional capability of MHS, and is applicable to any application such as IPM. All users of MHS will have the ability to generate messages for subsequent physical delivery. Figure 11 shows the functional model of this interworking. Provision of intercommunication between public message handling services offered by service providers and PD services is described in Recommendation F.415. The elements of service describing the features of this intercommunication are defined in Annex B and classified in clause 19.

A physical delivery system is a system, operated by a management domain, that transports and delivers physical messages. A physical message is a physical object comprising a relaying envelope and its content. An example of a Physical Delivery System (PDS) is the postal service. An example of a physical message is a paper letter and its enclosing paper envelope.

A Physical Delivery Access Unit (PDAU) converts an MH user's message to physical form, a process called physical rendition. An example of this is the printing of a message and its automatic enclosure in a paper envelope. The PDAU passes the physically rendered message to a PDS for further relaying and eventual physical delivery.

A PDAU can be viewed as a set of UAs, each UA being identified by a postal address. To perform its functions, a PDAU must support submission (Notifications) and delivery interactions with the MTS, and also cooperate with other UAs. MH/PD service intercommunication is thus provided as part of the message transfer service.

To enable MH users to address messages to be delivered physically by a PDS, an appropriate address format is described in clause 12.

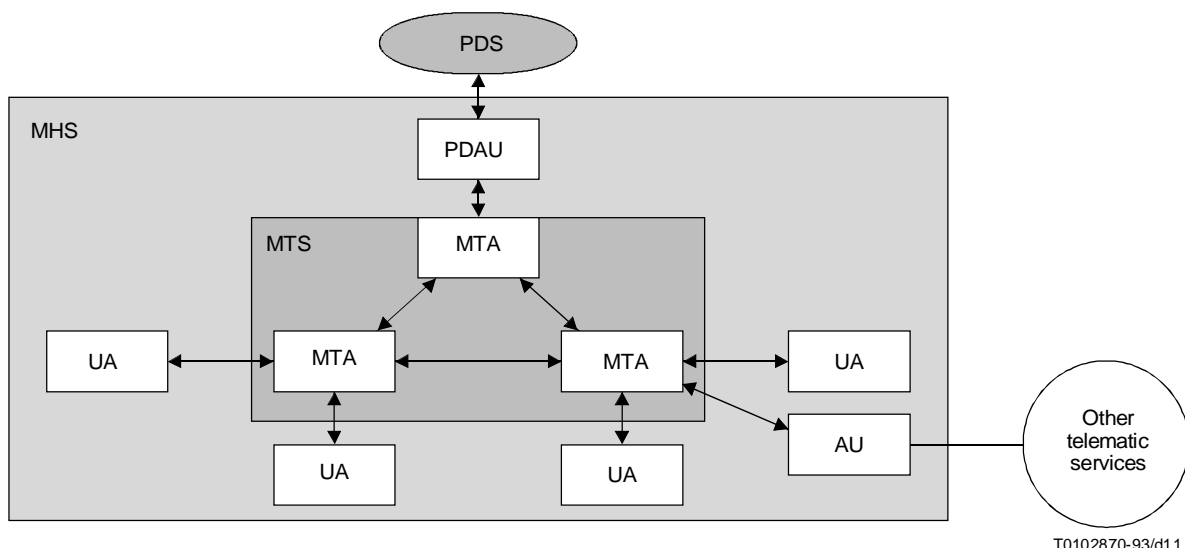

T0102870-93/d11

FIGURE 11/F.400

Functional model MHS-PDS interworking

## 10.2 Organizational configurations

Possible organizational mappings of the functional model described above are shown in Figure 12. In each model (A and B), the term PD domain denotes the domain of responsibility of an organization providing a PD service. In A, the PD domain comprises an MD and a PDS. The boundary between the PD domain and the rest of MHS is a boundary between MDs. In B, the PD domain comprises only the PDS; the PDAU is not part of the PD domain. The boundary between the PD domain and MHS lies at the point where the PDAU passes physical messages to the PDS.

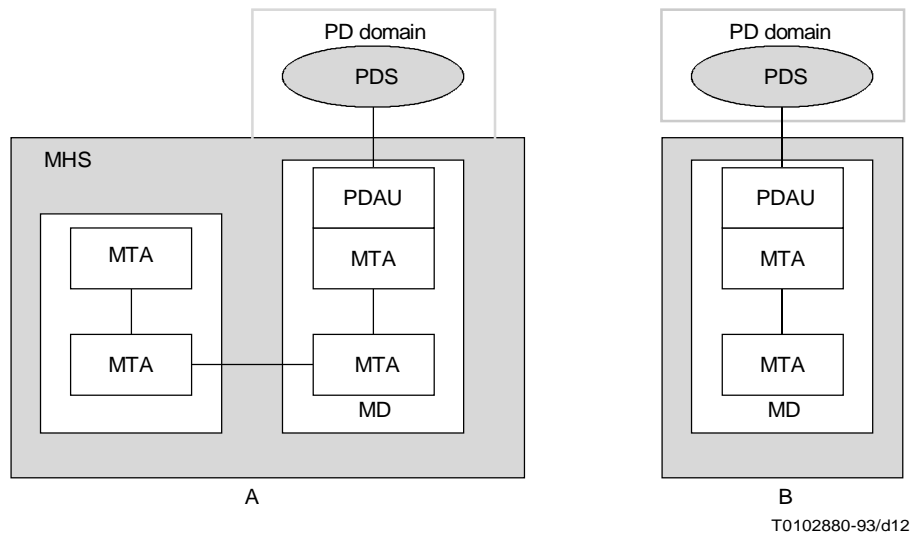

FIGURE 12/F.400

### Configurations for MH/PD service intercommunication

## 11 Specialized access

### 11.1 Introduction

The functional model of MHS (see Figure 1) contains Access Units (AUs) to allow access between MHS and other communication systems and services. The model shows a generic access unit between MHS and telex services.

Also shown is a physical delivery access unit to allow for physical delivery of MHS messages to recipients without the need for terminal access to MHS. The access to physical delivery services is available to any application carried by the MTS, through a PDAU described in clause 10.

Other forms of access are described below.

### 11.2 Telex access

#### 11.2.1 Registered access to the IPM service

A telex access unit (TLXAU) is defined in Recommendations to allow the intercommunication between IPM users and telex users. To provide a service with this type of AU is a national matter.

#### 11.2.2 Non-registered (public) access to the IPM service

A specialized access unit is defined to allow the intercommunication between IPM users and telex users. This AU provides for public access to the IPM service for telex users who are not registered users of the IPM service, and is called a Public Telex Access Unit (PTLXAU). This is shown in Figure 8. The telex users are not subscribers to the IPM



service, but use some of the features of the IPM service to pass messages to IPM users. IPM users can also send messages to telex users via this AU. The intercommunication between the IPM service and the telex service is defined in Recommendation F.421.

### 11.3 Facsimile access

#### 11.3.1 Non-registered (public) access from the IPM service

A specialized access unit is defined to allow the intercommunication between IPM users and telefax users. This AU provides for access from the IPM service to telefax users who are not registered users of the IPM service, and is called a public telefax access unit (PFAXAU). This is shown in Figure 8. IPM users can send messages to telefax users via this AU. Operation of the PFAXAU in the direction telefax to IPM is for further study. The intercommunication between the IPM service and telefax services is defined in Recommendation F.423.

## 12 Naming and addressing

### 12.1 Introduction

In an MHS, the principal entity that requires naming is the user (the originator and recipient of messages). In addition, Distribution Lists (DLs) have names for use in MHS. Users of MHS and DLs are identified by originator/recipient (O/R) names. O/R names are comprised of directory names and/or O/R addresses, all of which are described in this clause.

**12.2 directory names:** Users of the MH service, and DLs, can be identified by a name, called a directory name. A directory name must be looked up in a directory to find out the corresponding O/R address.

The structure and components of directory names are described in the ITU-T X.500-Series of Recommendations | ISO/IEC 9594.

A user can access a directory system directly to find the O/R address of a user, or O/R addresses of the members of a DL [both of which are outside the scope of the F.400/X.400-Series Recommendations and ISO/IEC 10021<sup>1)</sup>]. As an alternative, a user can use the directory name and have the MHS access a directory to resolve the corresponding O/R address or addresses automatically as described in clause 14.

An MH user or DL will not necessarily have a directory name, unless they are registered in a directory. As directories become more prevalent, it is expected that directory names will be the preferred method of identifying MHS users to each other.

**12.3 O/R names:** Every MH user or DL will have one or more O/R name(s).

An O/R name comprises a directory name, an O/R address, or both.

Either or both components of an O/R name can be used on submission of a message. If only the directory name is present, MHS will access a directory to attempt to determine the O/R address, which it will then use to route and deliver the message. If a directory name is absent, it will use the O/R address as given. When both are given on submission, MHS will use the O/R address, but will carry the directory name and present both to the recipient. If the O/R address is invalid, it will then attempt to use the directory name as above.

**12.4 O/R addresses:** An O/R address contains information that enables MHS to uniquely identify a user to whom a message is delivered or to whom a notification is returned. (The prefix "O/R" recognizes the fact that the user can be acting as either the originator or recipient of the message or notification in question.)

An O/R address is a collection of information called attributes. Recommendation X.402 and ISO/IEC 10021-2 specify a set of standard attributes from which O/R addresses can be constructed. Standard attributes mean that their syntax and semantics are defined in Recommendation X.402 and ISO/IEC 10021-2. In addition to standard attributes, and to cater for existing messaging systems, there are domain defined attributes whose syntax and semantics are defined by management domains.

---

<sup>1)</sup> See Table 1 for the correspondence of ISO/IEC 10021 to F.400/X.400-Series Recommendations.

Various forms of O/R addresses are defined, each serving their own purpose. These forms and their purpose are as follows:

- *Mnemonic O/R address*: Provides a user friendly means of identifying users in the absence of a directory. It is also used for identifying a distribution list.
- *Terminal O/R address*: Provides a means of identifying users with terminals belonging to various networks.
- *Numeric O/R address*: Provides a means of identifying users by means of numeric keypads.
- *Postal O/R address*: Provides a means of identifying originators and recipients of physical messages.

Various forms of O/R addresses are defined, each serving their own purpose. These forms and their purpose are as follows:

- *Mnemonic O/R address*: Provides a user friendly means of identifying users in the absence of a directory. It is also used for identifying a distribution list.
- *Terminal O/R address*: Provides a means of identifying users with terminals belonging to various networks.
- *Numeric O/R address*: Provides a means of identifying users by means of numeric keypads.
- *Postal O/R address*: Provides a means of identifying originators and recipients of physical messages.

## 13 MHS use of directory

### 13.1 Introduction

The directory defined by the ITU-T X.500-Series of Recommendations | ISO/IEC 9594 provides capabilities useful in the use and provision of a variety of telecommunication services. This clause describes how a directory can be used in message handling. Details can be found in other X.400-Series Recommendations and parts of ISO/IEC 10021.

The directory capabilities used in message handling fall into the following four categories:

- a) **User-friendly naming**: The originator or recipient of a message can be identified by means of his directory name, rather than his machine oriented O/R address. At any time MHS can obtain the latter from the former by consulting the directory.
- b) **distribution lists (DLs)**: A group whose membership is stored in the directory can be used as a DL. The originator simply supplies the name of the list. At the DL's expansion point MHS can obtain the directory names (and then the O/R addresses) of the individual recipients by consulting the directory.
- c) **Recipient UA capabilities**: MHS capabilities of a recipient (or originator) can be stored in his directory entry. At any time MHS can obtain (and then act upon) those capabilities by consulting the directory.
- d) **Authentication**: Before two MHS functional entities (two MTAs, or a UA and an MTA) communicate with one another, each establishes the identity of the other. This can be done by using authentication capabilities of MHS based on information stored in the directory.

In addition to the above, one user can directly access the directory, for example, to determine the O/R address or MHS capabilities of another. The recipient's directory name is supplied to the directory, which returns the requested information.

### 13.2 Functional model

Both UAs and MTAs can use the directory. A UA can present the directory with the directory name of the intended recipient, and obtain from the directory, the recipient's O/R address. The UA can then supply both the directory name and the O/R address to the MTS. Another UA can supply just the recipient's directory name to the MTS. The MTS would then itself ask the directory for the recipient's O/R address and add it to the envelope. The originating MTA normally carries out the name-to-O/R-address look-up using access rights granted to the MTA.

A functional model depicting the above is shown in Figure 13.

### 13.3 Physical configurations

Some possible physical configurations of the above functional model are shown in Figure 14. Where a Directory User Agent (DUA) and Directory System Agent (DSA) reside in physically separate systems, a standard directory protocol, defined in the ITU-T X.500-Series of Recommendations | ISO/IEC 9594, governs their interactions. It will often be desirable to physically co-locate a UA or MTA with a DUA/DSA. However, other physical configurations are also possible.

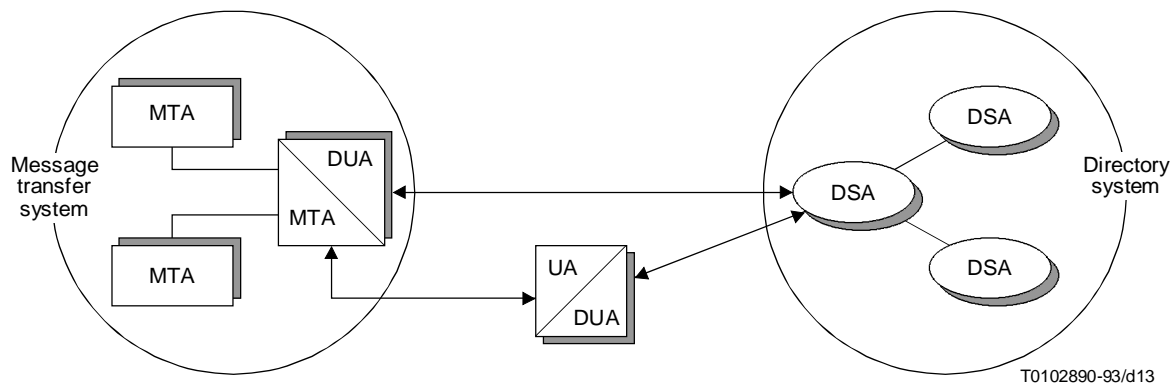

FIGURE 13/F.400  
Functional model of MHS-directory interworking

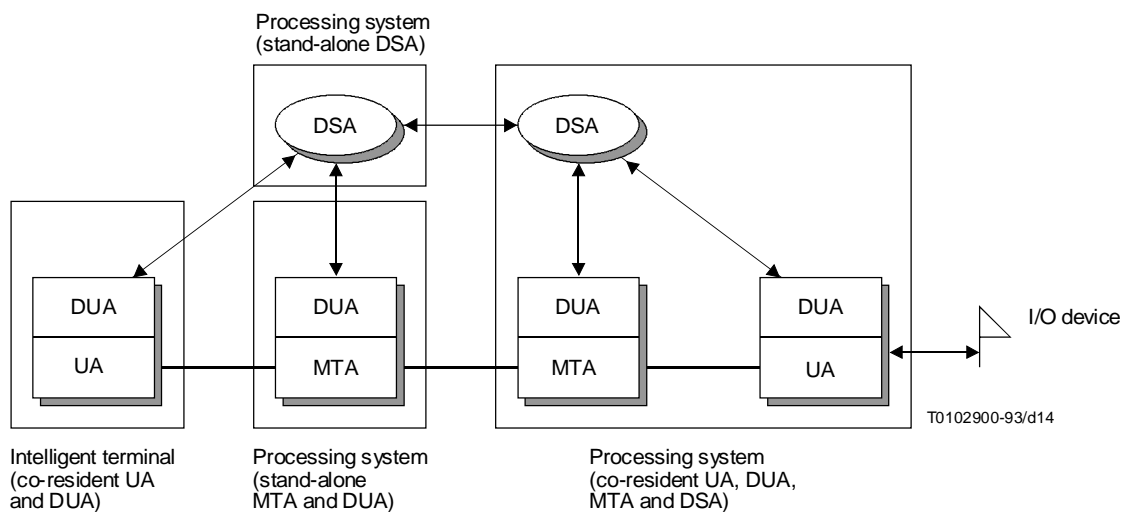

FIGURE 14/F.400  
Physical configurations for MHS-directory interworking

## 14 Distribution lists in MHS

### 14.1 Introduction

The ability to make use of a Distribution List (DL) is an optional capability of MHS provided through the MT service. DL expansion allows a sender to have a message transmitted to a group of recipients, by naming the group instead of having to enumerate each of the final recipients.

### 14.2 Properties of a DL

The properties of a DL can be described as follows:

- **DL members:** Users and other DLs that will receive messages addressed to the DL.
- **DL-submit permission:** A list of users and other DLs which are allowed to make use of the DL to send messages to the DL's members.

- **DL-expansion point:** Each DL has one or more O/R addresses. When a message is addressed to a DL, the O/R address is used to locate an expansion point, which is a domain or MTA where the names of the members of the DL are added to the recipient list. The message is transported to the expansion point before expansion, as shown in Figure 15. There may be more than one MTA capable of acting as the DL expansion point for a particular DL, especially if the Directory is used to store the membership of the DL.
- **DL owner:** A user who is responsible for the management of a DL.

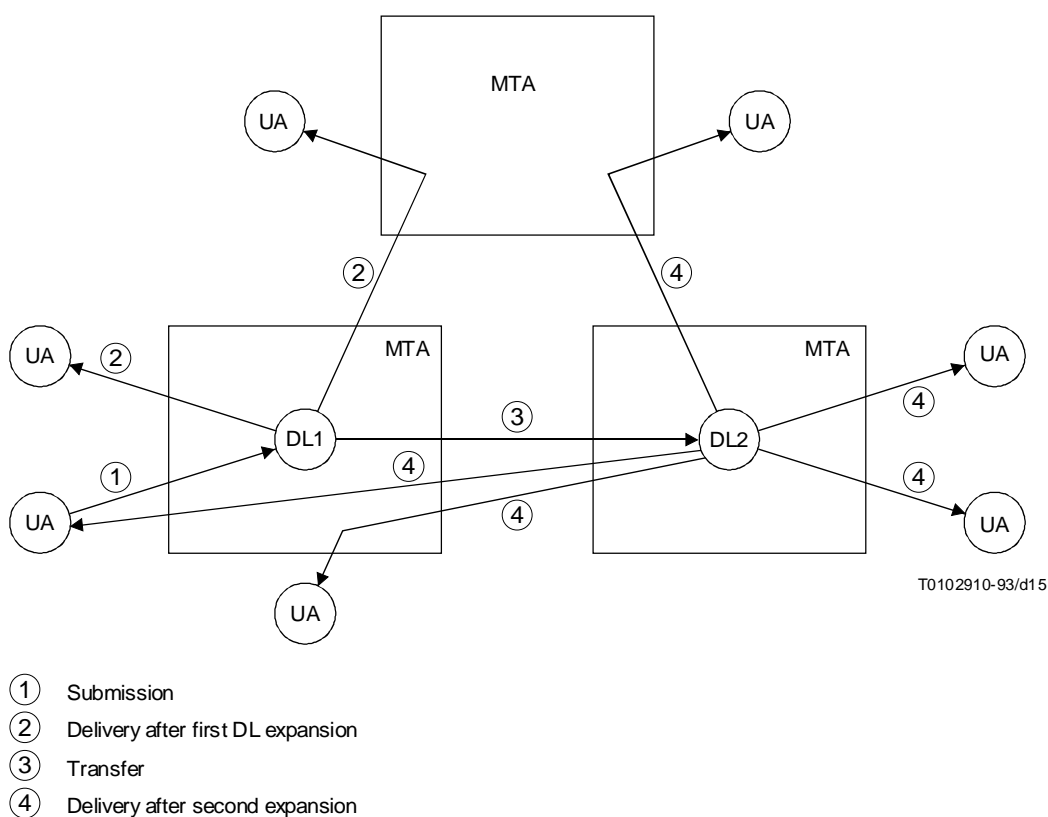

FIGURE 15/F.400  
Distribution list expansion

### 14.3 Submission

Submission of a message to a DL is similar to the submission of a message to a user. The originator can include in the DL's O/R name, the directory name, the O/R address, or both (see clause 12 for details). The originator need not be aware that the O/R name used is that of a DL. The originator can, however, through use of the element of service, DL expansion prohibited, prohibit the MTS from expanding a message unknowingly addressed to a DL.

### 14.4 DL use of a directory

A directory may or may not be used to store information about the properties of a DL. Among the information that can be stored are the following: DL members, DL owner, DL-submit permission and the DL-expansion point.

## 14.5 DL expansion

At the expansion point, the MTA responsible for expanding the DL will:

- a) Look up the information about the DL, e.g. in the directory, using access rights granted to the MTA.  

NOTE – Since this is done by the MTA at the expansion point, support of DLs in MHS does not require a globally interconnected directory.
- b) Verify whether expansion is allowed by checking the identity of the sender against the DL's submit permission.
- c) If expansion is allowed, add the members of the DL to the list of recipients of the message and transmit the message to them.

## 14.6 Nesting

A member of a DL can be another DL as shown in Figure 15. In this case the message is forwarded from the expansion point of the parent DL for further expansion. Thus during each expansion, only the members of a single DL are added to the message.

During expansion of a nested DL, the identity of the parent DL (e.g. DL1 in Figure 15) rather than that of the message originator, is compared against the submit permission of the member DL (e.g. DL2 in Figure 15).

NOTE – DL structures can be defined which reference a particular nested DL more than once at different levels of the nesting. Submission to such a parent DL can cause a recipient to receive multiple copies of the same message. The same result can occur if a message is addressed to multiple DLs which contain a common member. Correlation of such copies can be done at the recipient's UA, and/or in the MS.

## 14.7 Recursion control

If a certain DL is directly or indirectly a member of itself (a situation which can validly arise), or when DLs are combined with redirection, then a message might get back to the same list and potentially circulate infinitely. This is detected by the MTS and prevented from occurring.

## 14.8 Delivery

On delivery of the message, the recipient will find out that he received the message as a member of a DL, and through which DL, or chain of DLs he received the message.

## 14.9 Routing loop control

A message can be originated in one domain/MTA, expanded in a second domain/MTA, and then sent back to a DL member in the first domain/MTA. The MTS will not treat this as a routing loop error.

## 14.10 Notifications

Delivery and non-delivery notifications can be generated both at the DL-expansion point (e.g. if submit permission is denied), and at delivery to the ultimate recipient.

When a message coming from a DL generates a notification, this notification is sent to the DL from which the message came. The DL will then, depending on the policy of the list, forward the notification to the owner of the list, to the DL or originator from which it received the message, or both, as shown in Figure 16.

NOTE – When notifications are sent to the originator after DL expansion, the originator can receive many delivery/non-delivery notifications for one originator-specified recipient (the DL itself). The originator can even receive more than one notification from an ultimate recipient, if that recipient received the message more than once via different lists.

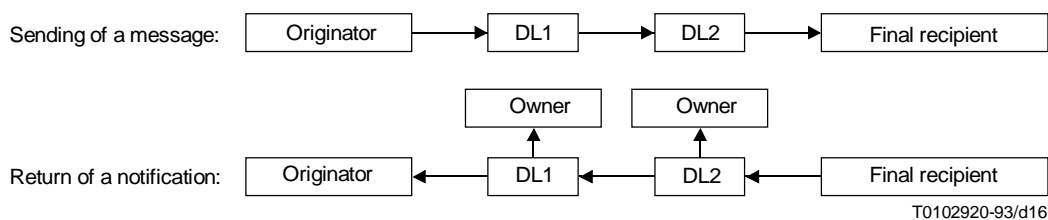

FIGURE 16/F.400  
DL notifications

### 14.11 DL-handling policy

An MTA may or may not provide different policies on DL handling. Such policies will control whether notifications generated at delivery to DL members should be propagated back through the previous DL, or to the originator if no such previous DL, and/or to the list owner. If the policy is such that notifications are to be sent only to the list owner, then the originator will receive notifications if requested, only during expansion of that DL. In order to accomplish this restriction, the MTS will, while performing the expansion, reset the notification requests according to the policy for the list.

## 15 Security capabilities of MHS

### 15.1 Introduction

The distributed nature of MHS makes it desirable that mechanisms are available to protect against various security threats that can arise. The nature of these threats and the capabilities to counter them are highlighted below.

### 15.2 MHS-security threats

#### 15.2.1 Access threats

Invalid user access into MHS is one of the prime security threats to the system. If invalid users can be prevented from using the system, then the subsequent security threat to the system is greatly reduced.

#### 15.2.2 Inter-message threats

Inter-message threats arise from unauthorized agents who are external to the message communication, and can manifest themselves in the following ways:

- Masquerade: A user who does not have proof of whom he is talking to can be easily misled by an impostor into revealing sensitive information.
- Message modification: A genuine message which has been modified by an unauthorized agent while it was transferred through the system can mislead the message recipient.
- Replay: Messages whose originators and contents are genuine can be monitored by an unauthorized agent and could be recorded to be replayed to the message's intended recipient at a later date. This could be done in order to either extract more information from the intended recipient or to confuse him.
- Traffic analysis: Analysis of message traffic between MH users can reveal to an eavesdropper how much data (if any) is being sent between users and how often. Even if the eavesdropper cannot determine the actual contents of the messages, he can still deduce a certain amount of information from the rate of traffic flow (e.g. continuous, burst, sporadic or none).

### 15.2.3 Intra-message threats

Intra-message threats are those performed by the actual message communication participants themselves, and can manifest themselves in the following ways:

- Repudiation of messages: One of the actual communication participants can deny involvement in the communication. This could have serious implications if financial transactions were being performed via MHS.
- Security level violation: If a management domain within MHS employs different security clearance levels (e.g. public, personal, private and company confidential), then users must be prevented from sending or receiving any messages for which they have an inadequate security clearance level if the management domain's security is not to be compromised.

### 15.2.4 Data-store threats

An MHS has a number of data stores within it that must be protected from the following threats:

- Modification of routing information: Unauthorized modification of the directory's contents could lead to messages being misrouted or even lost while unauthorized modification to the deferred delivery data store or the hold for delivery data store could mislead or confuse the intended recipient.
- Preplay: An unauthorized agent could make a copy of a deferred delivery message and send this copy to the intended recipient while the original was still being held for delivery in the MTA. This could fool the message recipient into replying to the message originator before the originator was expecting a reply or simply mislead or confuse the original intended message recipient.

## 15.3 Security model

Security features can be provided by extending the capabilities of the components in the message handling system to include various security mechanisms.

There are two aspects to security in message handling: secure access management and administration, and secure messaging.

### 15.3.1 Secure access management and administration

The capabilities in this subclause cover the establishment of an authenticated association between adjacent components, and the setting up of security parameters for that association. This can be applied to any pair of components in the message handling system: UA/MTA, MTA/MTA, MS/MTA, etc.

### 15.3.2 Secure messaging

The capabilities in this subclause cover the application of security features to protect messages in the message handling system in accordance with a defined security policy. This includes elements of service enabling various components to verify the origin of messages and the integrity of their content, and elements of service to prevent unauthorized disclosure of the message content.

The capabilities in this subclause cover the application of security features to protect messages directly submitted to the message transfer system by a user agent, message store, or an access unit. They do not cover the application of security features to protect communication between users and the message handling system, or MH user-to-MH user communication (a large part of MH user-to-MH user communication is protected between two UAs). Thus they do not apply, for example, to communication between a remote user's terminal and its UA, or to communication between these users' terminal equipment and other users in the MHS. Security capabilities to protect MH user-to-MH user communication are for further study.

Many of the secure messaging elements of service provide an originator-to-recipient capability, and require the use of user agents with security capabilities. They do not require the use of a message transfer system with security features. [As an example, content confidentiality can be applied by enciphering the message content by the originator, and deciphering by the recipient, with various security parameters transferred within the message envelope. Such a message can be transferred by any MTS which can handle the format of the content (unformatted octets), and transparently handle the security fields in the envelope.]



Some of the secure messaging elements of service involve an interaction with the Message transfer system, and require the use of message transfer agents with security capabilities. (As an example, non-repudiation of submission requires the MTA, to which the message is submitted, to contain mechanisms to generate a proof of submission field.)

Some of the secure messaging elements of service apply to the MS as well as UAs and MTAs, such as message security labelling. In general, however, the MS is transparent to security features that apply between the originators' and the recipient's UAs.

The scope of the secure messaging elements of service is given in Table 2. This describes the elements of service in terms of which the MHS component is the "provider" or the "user" of the security service. For example, probe-origin authentication is provided by the originating UA, and can be used by the MTAs through which the probe passes. An overview of these elements of service is given in 15.4.

This overview describes the use of security services by the UA, MS and the MTA. How these features are applied to access units is for further study.

## 15.4 MHS-security capabilities

The elements of service describing the security features of MHS are defined in Annex B, and classified in clause 19. An overview of these capabilities is as follows:

**15.4.1 message origin authentication:** Enables the recipient, or any MTA through which the message passes, to authenticate the identity of the originator of a message.

**15.4.2 report origin authentication:** Allows the originator to authenticate the origin of a delivery/non-delivery report.

**15.4.3 probe origin authentication:** Enables any MTA through which the probe passes to authenticate the origin of the probe.

**15.4.4 proof of delivery:** Enables the originator of a message to authenticate the delivered message and its content, and the identity of the recipient(s).

**15.4.5 proof of submission:** Enables the originator of a message to authenticate that the message was submitted to the MTS for delivery to the originally specified recipient(s).

**15.4.6 secure access management:** Provides for authentication between adjacent components, and the setting up of the security context.

**15.4.7 content integrity:** Enables the recipient to verify that the original content of a message has not been modified.

**15.4.8 content confidentiality:** Prevents the unauthorized disclosure of the content of a message to a party other than the intended recipient.

**15.4.9 message flow confidentiality:** Allows the originator of a message to conceal the message flow through MHS.

**15.4.10 message sequence integrity:** Allows the originator to provide to a recipient proof that the sequence of messages has been preserved.

**15.4.11 non-repudiation of origin:** Provides the recipient(s) of a message with proof of origin of the message and its content which will protect against any attempt by the originator to falsely deny sending the message or its content.

**15.4.12 non-repudiation of delivery:** Provides the originator of a message with proof of delivery of the message which will protect against any attempt by the recipient(s) to falsely deny receiving the message or its content.

**15.4.13 non-repudiation of submission:** Provides the originator of a message with proof of submission of the message, which will protect against any attempt by the MTS to falsely deny that the message was submitted for delivery to the originally specified recipient(s).

**15.4.14 message security labelling:** Provides a capability to categorize a message, indicating its sensitivity, which determines the handling of a message in line with the security policy in force.

TABLE 2/F.400

**Provision and use of secure messaging elements of service by MHS components**

Elements of service	Originating MTS user	MTS	Recipient MTS user
Message origin authentication	P	U	U
Report origin authentication	U	P	–
Probe origin authentication	P	U	–
Proof of delivery	U	–	P
Proof of submission	U	P	–
Secure access management	P	U	P
Content integrity	P	–	U
Content confidentiality	P	–	U
Message flow confidentiality	P	–	–
Message sequence integrity	P	–	U
Non-repudiation of origin	P	–	U
Non-repudiation of submission	U	P	–
Non-repudiation of delivery	U	–	P
Message security labelling	P	U	U
Request for Non-repudiation of Content Received	R	–	U
Non-repudiation of Content Received	U	–	P
Request for Non-repudiation of IP-notification	R	–	U
Non-repudiation of IP-notification	U	–	P
Request for Proof of Content Received	R	–	U
Proof of Content Received	U	–	P
Request for Proof of IP-notification	R	–	U
Proof of IP-notification	U	–	P
P The MHS component is a provider of the service U The MHS component is a user of the service R The MHS component is a requester of the service			

**15.5 Security management**

Aspects of an asymmetric key management scheme to support the above features are provided by the directory system authentication framework, described in ITU-T Rec. X.509 | ISO/IEC 9594-8. The Directory stores certified copies of public keys for MH users which can be used to provide authentication and to facilitate key exchange for use in data confidentiality and data integrity mechanisms. The certificates can be read from the Directory using the directory access protocol described in ITU-T Rec. X.519 | ISO/IEC 9594-5.

Other types of key management schemes, including symmetric encryption, to support the security features are for further study.

**15.6 MHS-security dependencies**

If, as a result of using MHS security capabilities, there are any dependencies, consequences or restrictions on other MHS capabilities (e.g. on distribution lists or conversion), then these shall be defined by the security policy.

The abstract security model for message transfer is described in clause 10/X.402. In particular, subclause 10.1/X.402 describes the concept of security policy.

## 15.7 IPM security

The Elements of Service describing the additional security features of IPMS are defined in Annex B, and classified in clause 19. An overview of these capabilities is as follows:

Request for Non-repudiation of Content Received	Enables the originator of an IP-message to request that the recipient of the IP-message provides irrevocable proof that the recipient received and verified the integrity of the IP-message content. This Element of Service provides only an indication of the originator's request. Fulfillment of the request requires support of the Non-repudiation of Content Received Element of Service
Non-repudiation of Content Received	Provides the originator of an IP-message with irrevocable proof that the recipient validated the security features of the IP-message. This provides a proof with non-repudiation properties of the authenticity and integrity of the contents of the IP-message as it was received by the recipient. The recipient is required to fulfill the request for this Element of Service only when the UA is subject to a security policy which mandates the support of this Element of Service
Request for Non-repudiation of IP-notification	Enables the originator of an IP-message to request that the recipient of the IP-message provides irrevocable proof that the recipient received the IP-message and the recipient of the IP-message originated the IP-notification. This Element of Service provides only an indication of the originator's request. Fulfillment of the request requires support of the Non-repudiation of IP-notification Element of Service
Non-repudiation of IP-notification	Provides the originator of an IP-message with irrevocable proof that the IP-message was received by the recipient and that the recipient originated the resulting IP-notification. This provides a signed receipt of the IP-message identifier which has non-repudiation properties. The recipient is required to fulfil the request for this Element of Service only when the UA is subject to a security policy which mandates the support of this element of service
Request for Proof of Content Received	Enables the originator of an IP-message to request that the recipient of the IP-message provides proof that the recipient received and verified the integrity of the IP-message contents. This Element of Service provides only an indication of the originator's request. Fulfillment of the request requires support of the Proof of Content Received Element of Service
Proof of Content Received	Provides the originator of an IP-message with proof that the recipient validated the security features of the IP-message. This Element of Service provides proof of the authenticity and integrity of the contents of the IP-message as it was received by the recipient. The recipient is required to fulfil the request for this Element of Service only when the UA is subject to a security policy which mandates the support of this Element of Service
Request for Proof of IP-notification	Enables the originator of an IP-message to request that the recipient of the IP-message provides proof that the recipient received the IP-message and the recipient of the IP-message originated the IP-notification. This Element of Service provides only an indication of the originator's request. Fulfillment of the request requires support of the Proof of IP-notification Element of Service
Proof of IP-notification	Provides the originator of an IP-message with proof that the IP-message was received by the recipient and that the recipient originated the resulting IP-notification. This provides a signed receipt of the IP-message identifier. The recipient is required to fulfil the request for this Element of Service only when the UA is subject to a security policy which mandates the support of this Element of Service

The application of security features between the IPM-UA and the MHS user, such as user authentication and local access control, is a local matter. Information required to implement local access control may be conveyed between the originator and recipient IPM-UAs using the Message Security Labelling Element of Service. The syntax and semantics of private and local access control information may be defined by registration of security policies and security categories.

The above IPM-UA security features use the MHS security capabilities defined in Recommendation X.411 and ISO/IEC 10021-4 provided by the user of the MTS. They do not require any extensions to the MTS defined in Recommendation X.411 and ISO/IEC 10021-4. IPM-UAs which support the above security features are required to support the related protocol extensions and associated procedures defined in Recommendation X.420 and ISO/IEC 10021-7. The IPM-UA security features use the MTS-User security mechanisms defined in Recommendation X.411 and ISO/IEC 10021-4 such as **Content-integrity-check**, **Message-origin-authentication-check**, and **Message-token**. The IPM-UA security features do not define any additional security mechanisms.

NOTE – In case of the use of a notarizing function, non-repudiation can be provided implicitly, and is not reflected in any specific protocol elements.

## 16 Conversion in MHS

The MTS provides conversion functions to allow users to input messages in one or more encoded formats, called Encoded Information Types (EITs) and have them delivered in other EITs to cater to users with various UA capabilities and terminal types. This capability is inherent in the MTS and increases the possibility of delivery by tailoring the message to the recipient's terminal capabilities. The EITs standardized in MHS are listed in Recommendation X.411 and ISO/IEC 10021-4. Conversions and the use of the elements of service relating to conversion are available for EITs not defined in Recommendation X.411 and ISO/IEC 10021-4, but supported by certain domains, either bilaterally between these domains or within a domain itself.

MH users have some control over the conversion process through various elements of service as described in Annex B. These include the ability for a user to explicitly request the conversion required or as a default to let the MTS determine the need for conversion, and the type of conversion performed. Users also have the ability to request that conversion not be performed or that conversion not be performed if loss of information will result. When the MTS performs conversion on a message, it informs the UA to whom the message is delivered that conversion took place and what the original EITs were.

## 17 Use of the MHS in provision of public services

The message handling system is used in the provision of public MH services that are offered by service providers for use by their subscribers. These public MH services are defined in the F.400-Series of Recommendations and include:

- the public message transfer service (Recommendation F.410);
- the public interpersonal messaging service (Recommendation F.420).

In addition, complementary public services are offered by service providers to allow for the intercommunication between ITU-T services and the public MH services mentioned above, as follows:

- intercommunication between the IPM service and the telex service (Recommendation F.421);
- intercommunication between the IPM service and telefax services (Recommendation F.423);
- intercommunication with public physical delivery services (Recommendation F.415).

A Recommendation describing the naming and addressing aspects for public MH services exists as follows:

- naming and addressing for public message handling services (Recommendation F.401).

See also Recommendations F.435 and F.440.

## 18 Elements of service – Purpose

Elements of service are particular features, functions, or capabilities of MHS. All the elements of service applicable for MHS are defined in Annex B, where they are listed in alphabetical order with a corresponding reference number. The realization of these elements of service in MHS are described in other Recommendations in the X.400-Series and parts of ISO/IEC 10021.

Elements of service are associated with the various services provided in MHS. There are elements of service for the message transfer service which provide for a basic capability for sending and receiving messages between UAs. There are elements of service for the interpersonal messaging service which provide for the sending and receiving of messages between a particular class of UAs called IPM-UAs. There are elements of service for the physical delivery service, enabling MH users to send messages and have them delivered in a physical medium to non-MH users. There are elements of service specifically available for the use of message stores.

The elements of service for the IPM service include those available for the MT service, the PD service and the message store as well as specific ones applicable to the IPM service.

Table 3 lists all the Elements of Service available in MHS, shows what services they are associated with of the presently defined services, MT Service, IPM Service, PD Service, and MS Service, and gives the corresponding reference number to the definition in Annex B. Elements of Service relevant to the IPM Message Store are marked on both the IPM and MS columns.

TABLE 3/F.400

**MHS elements of service**

Elements of service	MT	IPM	PD	MS	Annex B reference
Access management	X				B.1
Additional physical rendition			X		B.2
Alternate recipient allowed	X				B.3
Alternate recipient assignment	X				B.4
Authorizing users indication		X			B.5
Auto-acknowledgment of IP-messages		X		X	B.96
Auto-action Log		X			B.97
Auto-assignment of Annotations		X			B.98
Auto-assignment of Group Names		X			B.99
Auto-assignment of Storage Period		X			B.100
Auto-correlation of IP-messages		X		X	B.101
Auto-correlation of IP-notifications		X		X	B.102
Auto-correlation of Reports		X			B.103
Auto-deletion after Storage Period		X			B.104
Auto-discarding of IP-messages		X		X	B.105
Auto-forwarded indication		X			B.6
Auto-submitted indication		X			B.94
Basic physical rendition			X		B.7
Blind copy recipient indication		X			B.8
Body part encryption indication		X			B.9
Content confidentiality	X				B.10
Content integrity	X				B.11
Content type indication	X				B.12
Conversion prohibition	X				B.13
Conversion prohibition in case of loss of information	X				B.14
Converted indication	X				B.15
Copy precedence		X			B.123
Counter collection			X		B.16

TABLE 3/F.400 (continued)

## MHS elements of service

Elements of service	MT	IPM	PD	MS	Annex B reference
Counter collection with advice			X		B.17
Cross-referencing indication		X			B.18
Deferred delivery	X				B.19
Deferred delivery cancellation	X				B.20
Delivery Log		X			B.106
Delivery notification	X				B.21
Delivery time stamp indication	X				B.22
Delivery via bureaufax service			X		B.23
Designation of recipient by directory name	X				B.24
Disclosure of other recipients	X				B.25
Distribution codes		X			B.124
DL-expansion history indication	X				B.26
DL-expansion prohibited	X				B.27
EMS (express mail service)			X		B.28
Exempted address		X			B.125
Expiry date indication		X			B.29
Explicit conversion	X				B.30
Extended authorization information		X			B.126
Forwarded IP-message indication		X			B.31
Grade of delivery selection	X				B.32
Hold for delivery	X				B.33
Implicit conversion	X				B.34
Importance indication		X			B.35
Incomplete copy indication		X			B.36
IP-message Action Status		X		X	B.107
IP-message identification		X			B.37
Language indication		X			B.38
Latest delivery designation	X				B.39
Message flow confidentiality	X				B.40
Message identification	X				B.41
Message instructions		X			B.127
Message origin authentication	X				B.42
Message security labelling	X				B.43
Message sequence integrity	X				B.44
Message type		X			B.128
MS register				X	B.95
Multi-destination delivery	X				B.45
Multi-part body		X			B.46
Non-delivery notification	X				B.47
Non-receipt notification request indication		X			B.48
Non-repudiation of content received	X				B.115
Non-repudiation of delivery	X				B.49

TABLE 3/F.400 (continued)

## MHS elements of service

Elements of service	MT	IPM	PD	MS	Annex B reference
Non-repudiation of IP-notification	X				B.117
Non-repudiation of origin	X				B.50
Non-repudiation of submission	X				B.51
Obsoleting indication		X			B.52
Ordinary mail			X		B.53
Original encoded information types indication	X				B.54
Originator indication		X			B.55
Originator reference		X			B.129
Originator requested alternate recipient	X				B.56
Other recipients indicator		X			B.130
Physical delivery notification by MHS			X		B.57
Physical delivery notification by PDS			X		B.58
Physical forwarding allowed			X		B.59
Physical forwarding prohibited			X		B.60
Prevention of non-delivery notification	X				B.61
Primary and copy recipients indication		X			B.62
Primary precedence		X			B.131
Probe	X				B.63
Probe origin authentication	X				B.64
Proof of content received	X				B.119
Proof of delivery	X				B.65
Proof of submission	X				B.66
Receipt notification request indication		X			B.67
Redirection disallowed by originator	X				B.68
Redirection of incoming messages	X				B.69
Registered mail			X		B.70
Registered mail to addressee in person			X		B.71
Reply request indication		X			B.72
Replying IP-message indication		X			B.73
Report origin authentication	X				B.74
Request for forwarding address			X		B.75
Request for non-repudiation of content received		X			B.116
Request for non-repudiation of IP-notification		X			B.118
Request for proof of content Received		X			B.120
Request for proof of IP-notification		X			B.122
Requested preferred delivery method	X				B.76
Restricted delivery	X				B.77
Return of content	X				B.78
Secure access management	X				B.79
Sensitivity indication		X			B.80
Special delivery			X		B.81

TABLE 3/F.400 (concluded)

**MHS elements of service**

Elements of service	MT	IPM	PD	MS	Annex B reference
Storage of Draft Messages		X			B.108
Storage on Submission		X			B.109
Storage Period Assignment		X			B.110
Stored message alert				X	B.82
Stored Message Annotation		X			B.111
Auto-forwarding of IP-messages		X		X	B.83
Stored message deletion				X	B.84
Stored message fetching				X	B.85
Stored Message Grouping		X			B.112
Stored message listing				X	B.86
Stored message summary				X	B.87
Subject indication		X			B.88
Submission Log		X			B.113
Submission of IP-messages Incorporating Stored Messages		X		X	B.114
Submission time stamp indication	X				B.89
Typed body		X			B.90
Undeliverable mail with return of physical message			X		B.91
Use of distribution list	X				B.92
User/UA capabilities registration	X				B.93

**19 Elements of service – Classification****19.1 Purpose of classification**

The elements of service of MHS are classified either as belonging to a basic (also called base for PD and MS) service, or as optional user facilities. Elements of service belonging to a basic service are inherently part of that service; they constitute the basic service and are always provided and available for use of that service.

Other elements of service, called optional user facilities, can be selected by the subscriber or user, either on a per-message basis, or for an agreed contractual period of time. Each optional user facility is classified as either essential or additional. Essential (E) optional user facilities are to be made available to all MH users. Additional (A) optional user facilities can be made available for national use, and for international use on the basis of bilateral agreement.

**19.2 Basic Message Transfer service**

The basic MT service enables a UA to submit and to have messages delivered to it. If a message cannot be delivered, the originating UA is so informed through a non-delivery notification. Each message is uniquely and unambiguously identified. To facilitate meaningful communication, a UA can specify the encoded information type(s) that can be contained in messages which are delivered to it. The content type and original encoded information type(s) of a message and an indication of any conversions that have been performed, and the resulting encoded information type(s), are supplied with each delivered message. In addition, the submission time and delivery time are supplied with each message. The MT elements of service belonging to the basic MT service are listed in Table 4. A security policy will define when the security related MT Service Optional User Facilities are invoked.



TABLE 4/F.400

**Elements of service belonging to the basic MT service**

Elements of service	Annex B reference
Access management	B.1
Content type indication	B.12
Converted indication	B.15
Delivery time stamp indication	B.22
Message identification	B.41
Non-delivery notification	B.47
Original encoded information types indication	B.54
Submission time stamp indication	B.89
User/UA capabilities registration	B.93

**19.3 MT service optional user facilities**

Optional user facilities for the MT service can be selected on a per-message basis, or for an agreed period of time. Each optional user facility is classified as either essential or additional as described in 19.1. Table 5 lists the elements of service comprising the optional user facilities of the MT service with their classification and their availability [per-message (PM); Contractual Agreement (CA)]. Optional user facilities for the PD service and the message store, while forming a part of the MT service optional user facilities, are not listed in Table 5 because they are subject to either a PDAU or an MS being supplied, and are given separate classifications in Tables 6 to 9.

TABLE 5/F.400

**MT service optional user facilities**

Elements of service	Classification	Available	Annex B reference
Alternate recipient allowed	E	PM	B.3
Alternate recipient assignment	A	CA	B.4
Content confidentiality	A	PM	B.10
Content integrity	A	PM	B.11
Conversion prohibition	E	PM	B.13
Conversion prohibition in case of loss of information	A	PM	B.14
Copy precedence	A	PM	B.123
Deferred delivery	E	PM	B.19
Deferred delivery cancellation	E	PM	B.20
Delivery notification	E	PM	B.21
Designation of recipient by directory name	A	PM	B.24
Disclosure of other recipients	E	PM	B.25
DL-expansion history indication	E	PM	B.26
DL-expansion prohibited	A	PM	B.27
Exempted address	A	PM	B.125
Explicit conversion	A	PM	B.30
Grade of delivery selection	E	PM	B.32
Hold for delivery	A	CA	B.33
Implicit conversion	A	CA	B.34

TABLE 5/F.400 (concluded)

**MT service optional user facilities**

Elements of service	Classification	Available	Annex B reference
Latest delivery designation	A	PM	B.39
Message flow confidentiality	A	PM	B.40
Message origin authentication	A	PM	B.42
Message security labelling	A	PM	B.43
Message sequence integrity	A	PM	B.44
Multi-destination delivery	E	PM	B.45
Non-repudiation of delivery	A	PM	B.49
Non-repudiation of origin	A	PM	B.50
Non-repudiation of submission	A	PM	B.51
Originator requested alternate recipient	A	PM	B.56
Prevention of non-delivery notification	A	PM	B.61
Primary precedence	A	PM	B.131
Probe	E	PM	B.63
Probe origin authentication	A	PM	B.64
Proof of delivery	A	PM	B.65
Proof of submission	A	PM	B.66
Redirection disallowed by originator	A	PM	B.68
Redirection of incoming messages	A	CA	B.69
Report origin authentication	A	PM	B.74
Requested preferred delivery method	A (Note)	PM	B.76
Restricted delivery	A	CA	B.77
Return of content	A	PM	B.78
Secure access management	A	CA	B.79
Use of distribution list	A	PM	B.92

NOTE – Does not imply the provision of all delivery methods which may be requested.

**19.4 Base MH/PD service intercommunication**

The base MH/PD service intercommunication can be supplied, to enhance the MT service, and to enable messages to be delivered to recipients in a physical (typically hard copy) format via a physical delivery service such as the postal service. This capability is applicable for use by any application making use of the MT service. The MH/PD elements of service belonging to the base MH/PD service intercommunication are available on a per-recipient basis and are listed in Table 6. When this intercommunication is provided, through a PDAU, all the elements of service shown in Table 6 shall be supported.

TABLE 6/F.400

**Elements of service belonging to the base MH/PD service intercommunication**

Elements of service	Annex B reference
Basic physical rendition	B.7
Ordinary mail	B.53
Physical forwarding allowed	B.59
Undeliverable mail with return of physical message	B.91

## 19.5 Optional user facilities for MH/PD service intercommunication

Base MH/PD elements of service (see 19.4) together with the optional user facilities can be used for the provision of the MH/PD service intercommunication. This capability is applicable for use by any application making use of the enhanced MT service. These optional user facilities can be selected on a per-recipient basis and are listed in Table 7.

TABLE 7/F.400

**Optional user facilities for MH/PD service intercommunication**

Elements of service	Classification	Annex B reference
Additional physical rendition	A	B.2
Counter collection	E	B.16
Counter collection with advice	A	B.17
Delivery via bureaufax service	A	B.23
EMS (express mail service) <sup>a)</sup>	E	B.28
Physical delivery notification by MHS	A	B.57
Physical delivery notification by PDS	A	B.58
Physical forwarding prohibited	A	B.60
Registered mail	A	B.70
Registered mail to addressee in person	A	B.71
Request for forwarding address	A	B.75
Special delivery <sup>a)</sup>	E	B.81

<sup>a)</sup> At least one or the other element of service shall be supported by the PDAU and the associated PDS.

## 19.6 Base message store

The base message store is optionally available to provide for storage and management of incoming messages acting as an intermediary between a UA and an MTA. The MS is applicable for use in any application making use of the MT service. The elements of service belonging to the base message store are listed in Table 8. When an MS is provided, each Element of Service shown in Table 8 shall be supported for every type of message (delivered-message, submission-log, draft-messages etc.) stored in the MS to which that Element of Service is applicable.

TABLE 8/F.400

**Base message store**

Elements of service	Annex B reference
MS register	B.95
Stored message deletion	B.84
Stored message fetching	B.85
Stored message listing	B.86
Stored message summary	B.87

## 19.7 MS optional user facilities

Base MS elements of service (see 19.6) together with the optional user facilities can be used for enhanced use of a message store. The enhanced MS is applicable for use in any application making use of the MT service. The elements of service comprising the MS optional user facilities are listed in Table 9.

TABLE 9/F.400

**MS optional user facilities**

Elements of service	Classification	Annex B reference
Auto-action Log	A	B.97
Auto-assignment of Annotations	A	B.98
Auto-assignment of Group Names	A	B.99
Auto-assignment of Storage Period	A	B.100
Auto-correlation of Reports	A	B.103
Auto-deletion after Storage Period	A	B.104
Delivery Log	A	B.106
Storage of Draft Messages	A	B.108
Storage on Submission	A	B.109
Storage Period Assignment	A	B.110
Stored Message Alert	A	B.82
Stored Message Annotation	A	B.111
Stored Message Grouping	A	B.112
Submission Log	A	B.113

**19.8 Basic Interpersonal Messaging service**

The basic IPM service, which makes use of the MT service, enables a user to send and receive IP-messages. A user prepares IP-messages with the assistance of his User Agent (UA). User agents cooperate with each other to facilitate communication between their respective users. To send an IP-message, the originating user submits the message to his UA specifying the O/R name of the recipient who is to receive the IP-message. The IP-message, which has an identifier conveyed with it, is then sent by the originator's UA to the recipient's UA via the message transfer service.

Following a successful delivery to the recipient's UA, the IP-message can be received by the recipient. To facilitate meaningful communication, a recipient can specify the encoded information type(s) contained in IP-messages that he will allow to be delivered to his UA. The original encoded information type(s) and an indication of any conversions that have been performed and the resulting encoded information type(s) are supplied with each delivered IP-message. In addition, the submission time and delivery time are supplied with each IP-message. Non-delivery notification is provided with the basic service. The IPM elements of service belonging to the basic IPM service are listed in Table 10.

TABLE 10/F.400

**Elements of service belonging to the basic IPM service**

Elements of service	Annex B reference
Access management	B.1
Content type indication	B.12
Converted indication	B.15
Delivery time stamp indication	B.22
IP-message identification	B.37
Message identification	B.41
Non-delivery notification	B.47
Original encoded information types indication	B.54
Submission time stamp indication	B.89
Typed body	B.90
User/UA capabilities registration	B.93

## 19.9 IPM service optional user facilities

A set of the elements of service of the IPM service are optional user facilities. The optional user facilities of the IPM service, which can be selected on a per-message basis or for an agreed contractual period of time, are listed in Tables 11 and 12, respectively. Local user facilities can be usefully provided in conjunction with some of these user facilities.

The optional user facilities of the IPM service that are selected on a per-message basis are classified for both origination and reception by UAs. If an MD offers these optional user facilities for origination by UAs, then a user is able to create and send IP-messages according to the procedures defined for the associated element of service. If an MD offers these optional user facilities for reception by UAs, MSs and AUs, then the receiving UA, MS and PDAU will be able to receive and recognize the indication associated with the corresponding element of service and to inform the user of the requested optional user facility. Each optional user facility is classified as additional (A) or essential (E) for UAs from these two perspectives. A security policy will define and determine when the security related IPM Service Optional User Facilities are invoked.

TABLE 11/F.400

### IPM optional user facilities selectable on a per-message basis

Elements of service	Origination	Reception	Annex B reference
Additional physical rendition	A	A	B.2
Alternate recipient allowed	A	A	B.3
Authorizing users indication	A	E	B.5
Auto-forwarded indication	A	E	B.6
Basic physical rendition	A	E*	B.7
Blind copy recipient indication	A	E	B.8
Body part encryption indication	A	E	B.9
Content confidentiality	A	A	B.10
Content integrity	A	A	B.11
Conversion prohibition	E	E	B.13
Conversion prohibition in case of loss of information	A	A	B.14
Copy precedence	A	A	B.123
Counter collection	A	E*	B.16
Counter collection with advice	A	A	B.17
Cross-referencing indication	A	E	B.18
Deferred delivery	E	N/A	B.19
Deferred delivery cancellation	A	N/A	B.20
Delivery notification	E	N/A	B.21
Delivery via bureaufax service	A	A	B.23
Designation of recipient by directory name	A	N/A	B.24
Disclosure of other recipients	A	E	B.25
Distribution codes	A	A	B.124
DL-expansion history indication	N/A	E	B.26
DL-expansion prohibited	A	N/A	B.27
Exempted address	A	A	B.125

TABLE 11/F.400 (continued)

## IPM optional user facilities selectable on a per-message basis

Elements of service	Origination	Reception	Annex B reference
Expiry date indication	A	E	B.29
Explicit conversion	A	N/A	B.30
Extended authorization information	A	A	B.126
Forwarded IP-message indication	A	E	B.31
Grade of delivery selection	E	E	B.32
Importance indication	A	E	B.35
Incomplete copy indication	A	A	B.36
Language indication	A	E	B.38
Latest delivery designation	A	N/A	B.39
Message flow confidentiality	A	N/A	B.40
Message instructions	A	A	B.127
Message origin authentication	A	A	B.42
Message security labelling	A	A	B.43
Message sequence integrity	A	A	B.44
Message type	A	A	B.128
Multi-destination delivery	E	N/A	B.45
Multi-part body	A	E	B.46
Non-receipt notification request indication	A	E	B.48
Non-repudiation of content received	A	A	B.115
Non-repudiation of delivery	A	A	B.49
Non-repudiation of IP-notification	A	A	B.117
Non-repudiation of origin	A	A	B.50
Non-repudiation of submission	A	N/A	B.51
Obsoleting indication	A	E	B.52
Ordinary mail	A	E*	B.53
Originator indication	E	E	B.55
Originator reference	A	A	B.129
Originator requested alternate recipient	A	N/A	B.56
Other recipients indicator	A	A	B.130
Physical delivery notification by MHS	A	A	B.57
Physical delivery notification by PDS	A	E*	B.58
Physical forwarding allowed	A	E*	B.59
Physical forwarding prohibited	A	E*	B.60
Prevention of non-delivery notification	A	N/A	B.61
Primary and copy recipients indication	E	E	B.62
Primary precedence	A	A	B.131
Probe	A	N/A	B.63
Probe origin authentication	A	N/A	B.64

TABLE 11/F.400 (concluded)

**IPM optional user facilities selectable on a per-message basis**

Elements of service	Origination	Reception	Annex B reference
Proof of delivery	A	A	B.65
Proof of submission	A	N/A	B.66
Receipt notification request indication	A	A	B.67
Redirection disallowed by originator	A	N/A	B.68
Registered mail	A	A	B.70
Registered mail to addressee in person	A	A	B.71
Reply request Indication	A	E	B.72
Replying IP-message indication	E	E	B.73
Report origin authentication	A	A	B.74
Request for forwarding address	A	A	B.75
Requested preferred delivery method	A	A	B.76
Return of content	A	N/A	B.78
Sensitivity indication	A	E	B.80
Special delivery <sup>a)</sup>	A	E*	B.81
Storage of Draft Messages	N/A	A	B.108
Storage on Submission	N/A	A	B.109
Storage Period Assignment	N/A	A	B.110
Stored Message Annotation	N/A	A	B.111
Stored message deletion	N/A	E***	B.84
Stored message fetching	N/A	E***	B.85
Stored Message Grouping	N/A	A	B.112
Stored message listing	N/A	E**	B.86
Stored message summary	N/A	E**	B.87
Subject indication	E	E	B.88
Submission of IP-messages Incorporating Stored Messages	N/A	A	B.114
Undeliverable mail with return of physical message	A	E*	B.91
Use of distribution list	A	N/A	B.92

E Essential optional user facility has to be provided  
E\* Essential optional user facility only applying to PDAUs  
E\*\* Essential optional user facility applying to MSs. Additional optional user facility applying to UAs (which connect to MSs)  
E\*\*\* Essential optional user facility applying to MSs and Uas  
A Additional optional user facility can be provided  
N/A Not applicable

<sup>a)</sup> At least EMS or special delivery shall be supported by the PDAU and associated PDS.

NOTE – Bilateral agreement may be necessary in cases of reception by the UA of elements of service classified as “A”.

TABLE 12/F.400

**IPM optional user facilities agreed for a contractual period of time**

Elements of service	Classification	Annex B reference
Alternate recipient assignment	A	B.4
Auto-acknowledgment of IP-messages	A	B.96
Auto-action Log	A	B.97
Auto-assignment of Annotations	A	B.98
Auto-assignment of Group Names	A	B.99
Auto-assignment of Storage Period	A	B.100
Auto-correlation of IP-messages	A	B.101
Auto-correlation of IP-notifications	A	B.102
Auto-correlation of Reports	A	B.103
Auto-deletion after Storage Period	A	B.104
Auto-discarding of IP-messages	A	B.105
Auto-forwarding of IP-messages	A	B.83
Auto-submitted indication	A	B.94
Delivery Log	A	B.106
Hold for delivery	A	B.33
Implicit conversion	A	B.34
IP-message Action Status	A	B.107
MS register	A	B.95
Redirection of incoming messages	A	B.69
Restricted delivery	A	B.77
Secure access management	A	B.79
Stored message alert	A	B.82
Submission Log	A	B.113



TABLE 12/F.400

**IPM optional user facilities agreed for a contractual period of time**

Elements of service	Classification	Annex B reference
Alternate recipient assignment	A	B.4
Auto-acknowledgment of IP-messages	A	B.96
Auto-action Log	A	B.97
Auto-assignment of Annotations	A	B.98
Auto-assignment of Group Names	A	B.99
Auto-assignment of Storage Period	A	B.100
Auto-correlation of IP-messages	A	B.101
Auto-correlation of IP-notifications	A	B.102
Auto-correlation of Reports	A	B.103
Auto-deletion after Storage Period	A	B.104
Auto-discarding of IP-messages	A	B.105
Auto-forwarding of IP-messages	A	B.83
Auto-submitted indication	A	B.94
Delivery Log	A	B.106
Hold for delivery	A	B.33
Implicit conversion	A	B.34
IP-message Action Status	A	B.107
MS register	A	B.95
Redirection of incoming messages	A	B.69
Restricted delivery	A	B.77
Secure access management	A	B.79
Stored message alert	A	B.82
Submission Log	A	B.113

**Annex A****Glossary of terms**

(This annex does not form an integral part of Recommendation)

NOTE – The explanations given are not necessarily definitions in the strict sense. See also the definitions in Annex B and those provided in the other X.400-Series Recommendations and parts of ISO/IEC 10021 (especially Recommendation X.402 and ISO/IEC 10021-2), where many entries are sourced. The terms have, depending on the source, varying levels of abstraction.

**A.1 access unit (AU)**

*F: unité d'accès*

*S: unidad de acceso*

In the context of a message handling system, the functional object, a component of MHS, that links another communication system (e.g. a physical delivery system or the telex network) to the MTS and via which its patrons engage in message handling as indirect users.

In the context of message handling services, the unit which enables users of one service to intercommunicate with message handling services, such as the IPM service.

## **A.2 actual recipient**

*F: destinataire effectif*

*S: recipiente real*

In the context of message handling, a potential recipient for which delivery or affirmation takes place.

## **A.3 Administration**

*F: Administration*

*S: Administración*

In the context of ITU-T, an Administration (member of ITU) or a Recognized Operating Agency (ROA).

## **A.4 administration domain name**

*F: nom d'un domaine d'administration*

*S: nombre de dominio de administración*

In the context of message handling, a standard attribute of a name form that identifies an ADMD relative to the country denoted by a country name.

## **A.5 administration management domain (ADMD)**

*F: domaine de gestion d'administration*

*S: dominio de gestión de administración*

A management domain that comprises messaging systems managed (operated) by a service provider.

## **A.6 alternate recipient**

*F: destinataire suppléant*

*S: recipiente alternativo*

In the context of message handling, a user or a distribution list to which a message or probe may be conveyed if, and only if, it cannot be conveyed to a particular preferred recipient. The Alternate Recipient may be specified by the originator (see B.56), by the recipient (see B.69), or by the recipient MD (see B.4).

## **A.7 attribute**

*F: attribut*

*S: atributo*

In the context of message handling, an information item, a component of an attribute list, that describes a user or distribution list and that can also locate it in relation to the physical or organizational structure of MHS (or the network underlying it).

## **A.8 attribute list**

*F: liste d'attributs*

*S: lista de atributos*

In the context of message handling, a data structure, an ordered set of attributes, that constitutes an O/R address.

## **A.9 attribute type**

*F: type d'attribut*

*S: tipo de atributo*

An identifier that denotes a class of information (e.g. personal names). It is a part of an attribute.

#### **A.10 attribute value**

*F: valeur d'attribut*

*S: valor de atributo*

An instance of the class of information an attribute type denotes (e.g. a particular personal name). It is a part of an attribute.

#### **A.11 basic service**

*F: service de base*

*S: servicio básico*

In the context of message handling, the sum of features inherent in a service.

#### **A.12 body**

*F: corps*

*S: cuerpo*

Component of the content of a message. Another component is the heading.

#### **A.13 body part**

*F: partie du corps*

*S: parte del cuerpo*

Component of the body of a message.

#### **A.14 common name**

*F: nom courant*

*S: nombre común*

In the context of message handling, a standard attribute of an O/R address form that identifies a user or distribution list relative to the entity denoted by another attribute (e.g. an organizational name).

#### **A.15 content**

*F: contenu*

*S: contenido*

In the context of message handling, an information object, part of a message, that the MTS neither examines nor modifies, except for conversion, during its conveyance of the message.

#### **A.16 content type**

*F: type de contenu*

*S: tipo de contenido*

In the context of message handling, an identifier, on a message envelope, that identifies the type (i.e. syntax and semantics) of the message content.

#### **A.17 conversion**

*F: conversion*

*S: conversión*

In the context of message handling, a transmittal event in which an MTA transforms parts of a message's content from one encoded information type to another, or alters a probe so it appears that the described messages were so modified.

### **A.18 country name**

*F: nom de pays*

*S: nombre de país*

In the context of message handling, a standard attribute of a name form that identifies a country. A country name is a unique designation of a country for the purpose of sending and receiving messages.

NOTE – In the context of physical delivery, additional rules apply (see also *physical delivery country name* and Recommendation F.415).

### **A.19 delivery**

*F: remise*

*S: entrega*

In the context of message handling, a transmittal step in which an MTA conveys a message or report to the MS, UA or AU of a potential recipient of the message or of the originator of the report's subject message or probe.

### **A.20 delivery report**

*F: rapport de remise*

*S: informe de entrega*

In the context of message handling, a report that acknowledges delivery, non-delivery, export, or affirmation of the subject message or probe, or distribution list expansion.

### **A.21 direct submission**

*F: dépôt direct*

*S: depósito directo*

In the context of message handling, a transmittal step in which the originator's UA or MS conveys a message or probe to an MTA.

### **A.22 directory**

*F: annuaire*

*S: directorio*

A collection of open systems cooperating to provide directory services.

### **A.23 directory name**

*F: nom d'annuaire*

*S: nombre de directorio*

Name of an entry in a directory.

NOTE – In the context of message handling, the entry in the directory will enable the O/R address to be retrieved for submission of a message.

### **A.24 directory system agent (DSA)**

*F: agent de système d'annuaire*

*S: agente de sistema de directorio*

An OSI application process which is part of the directory, and whose role is to provide access to the directory information base to DUAs and/or other DSAs.

### **A.25 directory user agent (DUA)**

*F: agent d'utilisateur d'annuaire*

*S: agente de usuario de directorio*

An OSI application process which represents a user in accessing the directory. Each DUA serves a single user so that the directory can control access to directory information on the basis of the DUA names. DUAs can also provide a range of local facilities to assist users to compose requests (queries) and interpret the responses.

### **A.26 direct user**

*F: utilisateur direct*

*S: usuario directo*

In the context of message handling, a user that engages in message handling by direct use of the MTS.

### **A.27 distribution list (DL)**

*F: liste de distribution*

*S: lista de distribución*

In the context of message handling, the functional object, a component of the message handling environment, that represents a pre-specified group of users and other distribution lists and that is a potential destination for the information objects an MHS conveys. Membership can contain O/R names identifying either users or other distribution lists.

### **A.28 distribution list expansion**

*F: expansion de liste de distribution*

*S: expansión de lista de distribución*

In the context of message handling, a transmittal event in which an MTA resolves a distribution list, among a message's immediate recipients, to its members.

### **A.29 distribution list name**

*F: nom de liste de distribution*

*S: nombre de lista de distribución*

O/R name allocated to represent a collection of O/R addresses and directory names.

### **A.30 domain**

*F: domaine*

*S: dominio*

See *management domain*.

### **A.31 domain-defined attributes**

*F: attributs définis sur un domaine*

*S: atributos definidos por el dominio*

Optional attributes of an O/R address allocated to names in the responsibility of a management domain.

### **A.32 element of service**

*F: élément de service*

*S: elemento de servicio*

Functional unit for the purpose of segmenting and describing message handling features.

### **A.33 encoded information type (EIT)**

*F: type d'information codée*

*S: tipo de información codificada*

In the context of message handling, an identifier, on a message envelope, that identifies one type of encoded information represented in the message content. It identifies the medium and format (e.g. T.51 text, group 3 facsimile) on an individual portion of the content.

### **A.34 envelope**

*F: enveloppe*

*S: sobre*

In the context of message handling, an information object, part of a message, whose composition varies from one transmittal step to another and that variously identifies the message originator and potential recipients, documents its past and directs its subsequent conveyance by the MTS, and characterizes its content.

### **A.35 explicit conversion**

*F: conversion explicite*

*S: conversión explícita*

In the context of message handling, a conversion in which the originator selects both the initial and final encoded information types.

### **A.36 extension of physical delivery address components**

*F: développement de composantes d'adresse de remise physique*

*S: ampliación de los componentes de una dirección de entrega física*

Standard attribute of a postal O/R address as a means to give further information about the point of physical delivery in a postal address, e.g. the name of a hamlet, room and floor numbers in a large building.

### **A.37 extension of postal O/R address components**

*F: développement de composantes d'adresse postale O/R*

*S: ampliación de los componentes de una dirección postal O/R*

Standard attribute of a postal O/R address as a means to give further information to specify the addressee in a postal address, e.g. by organizational unit.

### **A.38 file transfer body part**

*F: partie du corps de transfert de fichier*

*S: parte de cuerpo de transferencia de fichero*

A body part for conveying the contents of a stored file, and other information associated with the file, from originator to recipient. The other information includes attributes which are typically stored along with the file content, information on the environment from which the transfer originated, and references to existing stored files or previous messages.

### **A.39 formatted postal O/R address**

*F: adresse postale O/R formatée*

*S: dirección postal O/R formatada*

Component of the content of a message. Another component is the body.

### **A.40 general text body part**

*F: partie de corps de texte général*

*S: parte de cuerpo de texto general*

A body part that represents character text of a general nature, using 8-bit-encoding. It has parameters and data components. The parameter component identifies the character sets that are present in the data component. The data component comprises a single general string.

### **A.41 heading**

*F: en-tête*

*S: encabezamiento*

Component of an IP-message. Other components are the envelope and the body.

### **A.42 immediate recipient**

*F: destinataire direct*

*S: recipiente inmediato; recipiente directo*

In the context of message handling, one of the potential recipients assigned to a particular instance of a message or probe (e.g. an instance created by splitting).

### **A.43 implicit conversion**

*F: conversion implicite*

*S: conversión implícita*

In the context of message handling, a conversion in which the MTA selects both the initial and final encoded information types.

### **A.44 indirect submission**

*F: dépôt indirect*

*S: depósito indirecto*

In the context of message handling, a transmittal step in which an originator's UA conveys a message or probe to an MTA via an MS.

### **A.45 indirect user**

*F: utilisateur indirect*

*S: usuario indirecto*

In the context of message handling, a user that engages in message handling by indirect use of MHS, i.e. through another communication system (e.g. a physical delivery system or the telex network) to which MHS is linked.

NOTE – Indirect users communicate via access units with direct users of MHS.

#### **A.46 intercommunication**

*F: intercommunication*

*S: intercomunicación*

In the context of message handling, a relationship between services, where one of the services is a message handling service, enabling the user of the message handling service to communicate with users of other services.

NOTE – Examples are the intercommunication between the IPM service and the telex service, and the intercommunication between message handling services and physical delivery services.

#### **A.47 interpersonal messaging service**

*F: service de messagerie de personne à personne*

*S: servicio de mensajería interpersonal*

Messaging service between users belonging to the same management domain or to different management domains by means of message handling, based on the message transfer service.

#### **A.48 IP-message**

*F: message de personne à personne; message IP*

*S: mensaje interpersonal; mensaje IP*

The content of a message in the IPM Service.

#### **A.49 local postal attributes**

*F: attributs postaux locaux*

*S: atributos postales locales*

Standard attributes of a postal O/R address as a means to distinguish between places with the same name (e.g. by state name, county name, or geographical attribute) in a postal address.

#### **A.50 management domain (MD)**

*F: domaine de gestion*

*S: dominio de gestión*

In the context of message handling, a set of messaging systems – at least one of which contains, or realizes, an MTA – that is managed by a single organization. It is a primary building block used in the organizational construction of MHS. It refers to an organizational area for the provision of services.

NOTE – A management domain may or may not necessarily be identical with a geographical area.

#### **A.51 management domain name**

*F: nom d'un domaine de gestion*

*S: nombre de dominio de gestión*

Unique designation of a management domain for the purpose of sending and receiving messages.

#### **A.52 members**

*F: membres*

*S: miembros*

In the context of message handling, the set of users and distribution lists implied by a distribution list name.



### **A.53 message**

*F: message*

*S: mensaje*

An instance of the primary class of information object conveyed by means of message transfer, and comprising an envelope and content.

### **A.54 message handling (MH)**

*F: messagerie*

*S: tratamiento de mensajes*

A distributed information processing task that integrates the intrinsically related subtasks of message transfer and message storage.

### **A.55 message handling environment (MHE)**

*F: environnement de messagerie*

*S: entorno de tratamiento de mensajes*

The environment in which message handling takes place, comprising MHS, users, and distribution lists.

The sum of all components of message handling systems.

NOTE – Examples of components are:

- message transfer agents;
- user agents;
- message stores;
- users.

### **A.56 message handling service**

*F: service de messagerie*

*S: servicio de tratamiento de mensajes*

Service provided by the means of message handling systems.

NOTES

- 1 Service may be provided through administration management domains or private management domains.
- 2 Examples of message handling services are:
  - Interpersonal Messaging service (IPM service);
  - Message Transfer service (MT service).

### **A.57 message handling system (MHS)**

*F: système de messagerie*

*S: sistema de tratamiento de mensajes*

The functional object, a component of the message handling environment, that conveys information objects from one party to another.

### **A.58 message storage**

*F: mémorisation des messages*

*S: almacenamiento de mensajes*

The automatic storage for later retrieval of information objects conveyed by means of message transfer. It is one aspect of message handling.

**A.59 message store (MS)**

*F: mémoire de messages*

*S: memoria de mensajes; almacenador de mensajes*

The functional object, a component of MHS, that provides a single direct user with capabilities for message storage.

**A.60 message transfer (MT)**

*F: transfert de messages*

*S: transferencia de mensajes*

The non-real-time carriage of information objects between parties using computers as intermediaries. It is one aspect of message handling.

**A.61 message transfer agent (MTA)**

*F: agent de transfert de messages*

*S: agente de transferencia de mensajes*

A functional object, a component of the MTS, that actually conveys information objects to users and distribution lists.

**A.62 message transfer service**

*F: service de transfert de messages*

*S: servicio de transferencia de mensajes*

Service that deals with the submission, transfer and delivery of messages for other messaging services.

**A.63 message transfer system (MTS)**

*F: système de transfert de messages*

*S: sistema de transferencia de mensajes*

The functional object consisting of one or more message transfer agents which provides store-and-forward message transfer between user agents, message stores and access units.

**A.64 messaging system**

*F: système de messagerie*

*S: sistema de mensajería*

A computer system (possibly but not necessarily an open system) that contains, or realizes, one or more functional objects. It is a building block used in the physical construction of MHS.

**A.65 mnemonic O/R address**

*F: adresse O/R mnémonique*

*S: dirección O/R nemotécnica*

An O/R address that mnemonically identifies a user or distribution list relative to the ADMD through which the user is accessed or the distribution list is expanded. It identifies an ADMD, and a user or distribution list relative to that ADMD.

**A.66 naming authority**

*F: autorité dénommatrice*

*S: autoridad de denominación*

An authority responsible for the allocation of names.

**A.67 network address**

*F: adresse réseau*

*S: dirección de red*

In the context of message handling, a standard attribute of an O/R address form that gives the network address of a terminal. It is comprising the numbering digits for network access points from an international numbering plan.

**A.68 non-delivery**

*F: non-remise*

*S: no entrega*

In the context of message handling, a transmittal event in which an MTA determines that the MTS cannot deliver a message to one or more of its immediate recipients, or cannot deliver a report to the originator of its subject message or probe.

**A.69 non-registered access**

*F: accès non homologué*

*S: acceso no registrado*

In the context of message handling services, access to the service through publicly available telecommunications means by users who have neither been explicitly registered by the service provider, nor been allocated an O/R address.

**A.70 numeric O/R address**

*F: adresse O/R numérique*

*S: dirección O/R numérica*

In the context of message handling, an O/R address that numerically identifies a user relative to the ADMD through which the user is accessed. It identifies an ADMD, and a user relative to that ADMD. It is identifying a user of message handling services by means of a numeric keypad.

**A.71 numeric user identifier**

*F: identificateur numérique d'utilisateur*

*S: identificador de usuario numérico*

Standard attribute of an O/R address as a unique sequence of numeric information for identifying a user.

**A.72 O/R address**

*F: adresse O/R*

*S: dirección O/R*

In the context of message handling, an attribute list that distinguishes one user or DL from another and identifies the user's point of access to MHS or the distribution list's expansion point.

### **A.73 O/R name**

*F: nom O/R*

*S: nombre O/R*

In the context of message handling, an information object by means of which a user can be designated as the originator, or a user or distribution list designated as a potential recipient of a message or probe. An O/R name distinguishes one user or distribution list from another and can also identify its point of access to MHS.

### **A.74 optional user facilities**

*F: fonctionnalités optionnelles d'utilisateur*

*S: facilidades facultativas de usuario*

In the context of message handling services the elements of service which are selectable by the user either on a contractual basis (agreed period of time) or on a per-message basis.

#### NOTES

- 1 Optional user facilities are classified as either essential or additional.
- 2 Essential optional user facilities are to be made available to all message handling users.
- 3 Additional optional user facilities can be made available for national and international use on the basis of bilateral agreement between the service providers.

### **A.75 organization name**

*F: nom d'organisation*

*S: nombre de organización*

Standard attribute of an O/R address as a unique designation of an organization for the purpose of sending and receiving of messages.

### **A.76 organizational unit name**

*F: nom d'une unité organisationnelle*

*S: nombre de unidad organizacional*

Standard attribute of an O/R address as a unique designation of an organizational unit of an organization for the purpose of sending and receiving of messages.

### **A.77 originator**

*F: expéditeur*

*S: originador*

In the context of message handling, the user (but not distribution list) that is the ultimate source of a message or probe.

### **A.78 personal name**

*F: nom personnel*

*S: nombre personal*

In the context of message handling, a standard attribute of an O/R address form that identifies a person relative to the entity denoted by another attribute (e.g. an organization name).

NOTE – Components are for example:

- surname;
- given name;
- initials;
- generation qualifier.

**A.79 physical delivery (PD)**

*F: remise physique*

*S: entrega física*

The delivery of a message in physical form, such as a letter, through a physical delivery system.

**A.80 physical delivery access unit (PDAU)**

*F: unité d'accès de remise physique*

*S: unidad de acceso de entrega física*

An access unit that subjects messages (but neither probes nor reports) to physical rendition.

**A.81 physical delivery address components**

*F: composantes d'une adresse de remise physique*

*S: componentes de dirección de entrega física*

In a postal address they contain the information necessary for the local physical delivery within the physical delivery area of the physical delivery office, i.e. a street address, a P.O. Box address, a poste restante address or a unique name alternatively.

NOTE – The information is generally restricted to one line with up to 30 printable graphic characters. Additional information may be supplied by using the attribute type “extension of physical delivery address component”.

**A.82 physical delivery country name**

*F: nom du pays de remise physique*

*S: nombre de país para entrega física*

In the context of physical delivery, a unique description of the country of the final destination.

**A.83 physical delivery domain**

*F: domaine de remise physique*

*S: dominio de entrega física*

The domain of responsibility of an organization providing a physical delivery system and optionally an MTA/PDAU.

**A.84 physical delivery office address components**

*F: composantes d'adresse de bureau de remise physique*

*S: componentes de dirección de oficina de entrega física*

In a postal address they contain the information to specify the office which is responsible for the local physical delivery.

NOTE – The information is generally restricted to one line with up to 30 printable graphic characters. In some countries the postal code will follow the physical delivery office address components in a separate line (possibly together with the country name).

**A.85 physical delivery office name**

*F: nom du bureau de remise physique*

*S: nombre de oficina de entrega física*

Standard attribute of a postal O/R address, in the context of physical delivery, specifying the name of the city, village, etc. where the physical delivery office is situated, or where the physical delivery is effected.

**A.86 physical delivery office number**

*F: numéro du bureau de remise physique*

*S: número de oficina de entrega física*

Standard attribute and in a postal O/R address a means to distinguish between more than one physical delivery office within a city, etc.

**A.87 physical delivery organization name**

*F: nom d'organisation de remise physique*

*S: nombre de organización de entrega física*

A free form name of the addressed entity in the postal address, taking into account the specified limitations in length.

**A.88 physical delivery personal name**

*F: nom personnel de remise physique*

*S: nombre personal de entrega física*

In a postal address a free form name of the addressed individual containing the family name and optionally the given name(s), the initial(s), title(s) and generation qualifier, taking into account the specified limitations in length.

**A.89 physical delivery service**

*F: service de remise physique*

*S: servicio de entrega física*

Service provided by a physical delivery system.

**A.90 physical delivery service name**

*F: nom du service de remise physique*

*S: nombre del servicio de entrega física*

Standard attribute of a postal O/R address in the form of the name of the service in the country electronically receiving the message on behalf of the physical delivery service.

**A.91 physical delivery system (PDS)**

*F: système de remise physique*

*S: sistema de entrega física*

A system that performs physical delivery. One important kind of physical delivery system is the postal system.

**A.92 physical message**

*F: message physique*

*S: mensaje físico*

A physical object comprising a relaying envelope and its content, e.g. a letter.

**A.93 physical rendition**

*F: conversion physique*

*S: reproducción física*

The transformation of an MHS message to a physical message, e.g. by printing the message on paper and enclosing it in a paper envelope.

**A.94 postal code**

*F: code postal*

*S: código postal*

Standard attribute of a postal O/R address to specify the geographical area, and in the context of MHS, used for routing of messages.

**A.95 postal O/R address**

*F: adresse O/R postale*

*S: dirección postal O/R*

In the context of message handling, an O/R address that identifies a user by means of its postal address. It identifies the physical delivery system through which the user is to be accessed and gives the user's postal address.

**A.96 postal O/R address components**

*F: composantes d'adresse O/R postale*

*S: componentes de la dirección postal O/R*

They contain in a postal address information to describe the sender or addressee by means of his name (personal name, organization name).

NOTE – In a postal address the information is generally restricted to one line of 30 printable characters. Additional information may be supplied by using the attribute type “extension of postal O/R address components”.

**A.97 post office box address (P.O. Box address)**

*F: adresse de boîte postale*

*S: dirección de apartado de correos*

A standard attribute in a postal address indicating that physical delivery through a P.O. Box is requested. It carries the P.O. Box number for distribution to the P.O. Box.

**A.98 post restante address**

*F: adresse en poste restante*

*S: dirección de lista de correos*

A standard attribute in a postal address indicating that physical delivery at the counter is requested. It may also carry a code.

**A.99 potential recipient**

*F: destinataire potentiel*

*S: recipiente potencial*

In the context of message handling, any user or distribution list to which a message or probe is conveyed during the course of transmittal. Equivalently, a preferred member, alternate member, or substitute recipient.

**A.100 preferred recipient**

*F: destinataire préféré*

*S: recipiente preferido*

In the context of message handling, one of the users and distribution lists that the originator selects as a message's or probe's preferred destination.

**A.101 private domain name**

*F: nom de domaine privé*

*S: nombre de dominio privado*

In the context of message handling, a standard attribute of an O/R address form that identifies a PRMD relative to the ADMD denoted by an administration domain name.

**A.102 private management domain (PRMD)**

*F: domaine de gestion privé*

*S: dominio de gestión privado*

In the context of message handling, a management domain that comprises messaging system(s) managed (operated) by an organization other than a service provider.

NOTE – This does not preclude a service provider from managing (operating) a PRMD.

**A.103 probe**

*F: message test*

*S: sonda*

In the context of message handling, an instance of a secondary class of information objects conveyed by means of message transfer that describes a class of messages and that is used to determine the deliverability of such messages.

**A.104 public message handling service**

*F: service public de messagerie*

*S: servicio público de tratamiento de mensajes*

Message handling service offered by a service provider.

**A.105 public services**

*F: services publics*

*S: servicios públicos*

In the context of telecommunication, the services offered by service providers.

**A.106 receipt**

*F: réception*

*S: recepción*

In the context of message handling, a transmittal step in which either a UA conveys a message or report to its direct user, or the communication system that serves an indirect user conveys such an information object to that user.

**A.107 recipient**

*F: destinataire*

*S: recipiente*

See *actual recipient*.

**A.108 recursion**

*F: récursion*

*S: repetición*

In the context of message handling, the situation that a message gets back to the same distribution list of origin and potentially circulates infinitely.



#### **A.109 redirection**

*F: réacheminement*

*S: redireccionamiento*

In the context of message handling, a transmittal event in which an MTA replaces a user among a message's immediate recipients with a user preselected for that message.

#### **A.110 registered access**

*F: accès homologué*

*S: acceso registrado*

In the context of message handling services, access to the service performed by subscribers who have been registered by the service provider to use the service, and been allocated an O/R address.

#### **A.111 report**

*F: rapport*

*S: Informe*

In the context of message handling, an instance of a secondary class of information object conveyed by means of message transfer. It is generated by the MTS, it reports the outcome or progress of a message's or probe's transmittal to one or more potential recipients.

#### **A.112 retrieval**

*F: extraction*

*S: extracción*

In the context of message handling, a transmittal step in which a user's message store conveys a message or report to the user's UA. The user is an actual recipient of the message or the originator of the subject message or probe.

#### **A.113 security capabilities**

*F: capacités de sécurité*

*S: capacidades de seguridad*

In the context of message handling, the mechanisms that protect against various security threats.

#### **A.114 specialized access**

*F: accès spécialisé*

*S: acceso especializado*

In the context of message handling, the involvement of specialized access units providing intercommunication between message handling services and other telecommunication services.

#### **A.115 standard attribute**

*F: attribut normalisé*

*S: atributo normalizado*

An attribute whose type is bound to a certain class of information.

#### **A.116 street address**

*F: adresse de rue*

*S: dirección de calle*

A standard attribute in a postal address giving information for the local distribution and physical delivery, i.e. the street name, the street identifier (like street, place, avenue) and the house number.

**A.117 subject**

*F: objet*

*S: asunto*

In the context of message handling, the information, part of the header, that summarizes the content of the message as the originator has specified it.

**A.118 subject message**

*F: message objet*

*S: mensaje de asunto*

The message that is the subject of a report.

**A.119 subject probe**

*F: message test objet*

*S: sonda de asunto*

The probe that is the subject of a report.

**A.120 submission**

*F: dépôt*

*S: depósito*

Direct submission or indirect submission.

**A.121 substitute recipient**

*F: destinataire substitut*

*S: recipiente sustituto*

In the context of message handling, the user or distribution list to which a preferred, alternate, or member (but not another substitute) recipient can have elected to redirect messages (but not probes).

**A.122 terminal identifier**

*F: identificateur de terminal*

*S: identificador de terminal*

Standard attribute in an O/R address providing information for identifying a terminal amongst others.

NOTE – An example is the telex answerback.

**A.123 terminal O/R address**

*F: adresse O/R de terminal*

*S: dirección O/R de terminal*

In the context of message handling, an O/R address that identifies a user by means of the network address of his terminal and that can identify the ADMD through which that terminal is accessed. The terminals identified can belong to different networks.

**A.124 terminal type**

*F: type de terminal*

*S: tipo de terminal*

Standard attribute of an O/R address that indicates the type of a terminal.

NOTE – Examples: telex, G3 facsimile, G4 facsimile, Recommendation T.51, videotex terminal.

**A.125 transfer**

*F: transfert*

*S: transferencia*

In the context of message handling, a transmittal step in which one MTA conveys a message, probe, or report to another.

**A.126 transfer system**

*F: système de transfert*

*S: sistema de transferencia*

A messaging system that contains one MTA; optionally one or more access units, and neither a UA nor a message store.

**A.127 transmittal**

*F: transmission*

*S: transmisión*

The conveyance or attempted conveyance of a message from its originator to its potential recipients, or of a probe from its originator to MTAs able to affirm any described message's deliverability to its potential recipients. It also encompasses the conveyance or attempted conveyance, to the originator of the message or probe, of any reports it provokes. It is a sequence of transmittal steps and events.

**A.128 unformatted postal O/R address**

*F: adresse O/R postale non formatée*

*S: dirección postal O/R no formatada*

O/R address based on an unformatted postal address.

**A.129 unique postal name**

*F: nom postal unique*

*S: nombre postal exclusivo*

In a postal address a standard attribute describing the point of physical delivery by means of a unique name, e.g. that of a building.

**A.130 user**

*F: utilisateur*

*S: usuario*

In the context of message handling, a functional object (e.g. a person), a component of the message handling environment, that engages in (rather than provides) message handling and that is a potential source or destination for the information objects an MHS conveys.

**A.131 user agent (UA)**

*F: agent d'utilisateur*

*S: agente de usuario*

In the context of message handling, the functional object, a component of MHS, by means of which a single direct user engages in message handling.

### **A.132 voice body part**

*F: partie de corps vocale*

*S: parte de cuerpo de datos vocales*

A body part sent or forwarded from an originator to a recipient which conveys voice encoded data and related information. The related information consists of parameters which are used to assist in the processing of the voice data. These parameters include information detailing the duration of the voice data, the voice encoding algorithm used to encode the voice data, and supplementary information.

## **Annex B**

### **Definitions of elements of service**

(This annex forms an integral part of this Recommendation.)

NOTE – The abbreviations used in the title line have the following meanings:

- MT Message Transfer
- IPM Interpersonal Messaging
- PD Physical Delivery
- MS Message Store
- PR Per recipient (available on a per-recipient basis)

### **B.1 access management**

**MT**

This element of service enables a UA and MTA to establish access to one another and to manage information associated with access establishment.

The element of service permits the UA and MTA to identify and validate the identity of the other. It provides a capability for the UA to specify its O/R address and to maintain access security. When access security is achieved through passwords, these passwords can be periodically updated.

NOTE – A more secure form of access management is provided by the element of service secure access management.

### **B.2 additional physical rendition**

**PD PR**

This element of service allows an originating user to request the PDAU to provide the additional rendition facilities (e.g. kind of paper, colour printing, etc.). Bilateral agreement is required to use this element of service.

### **B.3 alternate recipient allowed**

**MT**

This element of service enables an originating UA to specify that the message being submitted can be delivered to an alternate recipient as described below.

A destination MD will interpret all of the user attributes in order to select a recipient UA. Three cases can be distinguished:

- 1) all the attributes match precisely those of a subscriber UA. Delivery is attempted to that UA;
- 2) either insufficient attributes are supplied or those supplied match those of more than one subscriber UA. The message cannot be delivered;
- 3) at least the minimum set of attributes required by the destination MD is supplied. Nevertheless, taking all of the other attributes into account, the attributes match those of no UA.

In case 3) an MD that supports the alternate recipient assignment element of service can deliver the message to a UA that has been assigned to receive such messages. This UA will be notified of the O/R address of the intended recipient as specified by the originator. Delivery to this UA will be reported in a delivery notification if requested by the originator.

#### **B.4 alternate recipient assignment**

**MT**

This element of service enables a UA to be given the capability to have certain messages delivered to it for which there is not an exact match between the recipient attributes specified and the name of the user. Such a UA is specified in terms of one or more attributes for which an exact match is required, and one or more attributes for which any value is acceptable. For example, an organization can establish a UA to receive all messages for which country name, administration management domain name and organization name (for example, company name) are an exact match but the personal name of the recipient does not correspond to an individual known by an MHS in that organization. This permits the organization to manually handle the messages to these individuals.

In order for a message to be reassigned to an alternate recipient, the originator must have requested the alternate recipient allowed element of service.

#### **B.5 authorizing users indication**

**IPM**

This element of service allows the originator to indicate to the recipient the names of the one or more persons who authorized the sending of the message. For example, an individual can authorize a particular action which is subsequently communicated to those concerned by another person such as a secretary. The former person is said to authorize its sending while the latter person is the one who sent the message (originator). This does not imply signature-level authorization.

#### **B.6 auto-forwarded indication**

**IPM**

This element of service allows a recipient to determine that a body of an incoming IP-message contains an IP-message that has been auto-forwarded. Thus the recipient can distinguish from that where an incoming IP-message contains a forwarded message (as described in B.31) in the body. As with a forwarded IP-message, an auto-forwarded IP-message can be accompanied by information (for example, time stamps, indication of conversion) associated with its original delivery.

NOTE – The indication that auto-forwarding of an IP-message has occurred enables a recipient IPM-UA, should it so choose, to prevent further auto-forwarding and thus the possibility of loops. In addition, a recipient IPM-UA can choose whether or not to auto-forward based on other criteria (for example, sensitivity classification).

When an IPM-UA auto-forwards an IP-message, it designates it as auto-forwarded. If receipt/non-receipt notification has been requested for the IP-message being auto-forwarded, the IPM-UA generates a non-receipt notification informing the originator of the auto-forwarding of the IP-message. The notification optionally includes a comment supplied by the originally intended recipient. No further notification applying to the auto-forwarded IP-message is generated by any IPM-UA.

#### **B.7 basic physical rendition**

**PD PR**

This element of service enables the PDAU to provide the basic rendition facilities for converting the MHS message into a physical message. This is the default action to be taken by the PDAU.

#### **B.8 blind copy recipient indication**

**IPM PR**

This element of service allows the originator to provide the O/R name of one or more additional users, or DLs, who are intended recipients of the IP-message being sent. These names are not disclosed to either the primary or copy recipients. Whether or not these additional recipients are disclosed to one another is a local matter.

**B.9 body part encryption indication IPM**

This element of service allows the originator to indicate to the recipient that a particular body part of the IP-message being sent has been encrypted. Encryption can be used to prevent unauthorized inspection or modification of the body part. This element of service can be used by the recipient to determine that some body part(s) of the IP-message must be decrypted. This element of service, however, does not itself encrypt or decrypt any body part.

**B.10 content confidentiality MT**

This element of service allows the originator of a message to protect the content of the message from disclosure to recipients other than the intended recipient(s). Content confidentiality is on a per-message basis, and can use either an asymmetric or a symmetric encryption technique.

**B.11 content integrity MT PR**

This element of service allows the originator of the message to provide to the recipient of the message a means by which the recipient can verify that the content of the message has not been modified. Content integrity is on a per-recipient basis, and can use either an asymmetric or a symmetric encryption technique.

**B.12 content type indication MT**

This element of service enables an originating UA to indicate the content type for each submitted message. A recipient UA can have one or more content types delivered to it. An example of a content type is the contents generated by the IPM class of cooperating UAs.

**B.13 conversion prohibition MT**

This element of service enables an originating UA to instruct the MTS that implicit encoded information type conversion(s) shall not be performed for a particular submitted message.

**B.14 conversion prohibition in case of loss of information MT**

This element of service enables an originating UA to instruct the MTS that encoded information type conversion(s) shall not be performed for a particular submitted message if such conversion(s) would result in loss of information. Loss of information is discussed in detail in Recommendation X.408.

Should this and the conversion prohibition element of service both be selected, the latter shall take precedence.

NOTE – This element of service will not protect against possible loss of information in certain cases where the recipient is using an I/O device whose capabilities are unknown to the MTA.

**B.15 converted indication MT PR**

This element of service enables the MTS to indicate to a recipient UA that the MTS performed encoded information type conversion on a delivered message. The recipient UA is informed of the resulting types.

**B.16 counter collection PD PR**

This element of service allows an originating user to instruct the PDS to keep the physical message ready for counter collection at the post office specified by the originator, or at the post office which offers counter collection service closest to the given recipient's address.

**B.17 counter collection with advice PD PR**

This element of service allows an originating user to instruct the PDS to keep the physical message ready for counter collection at the post office specified by the originator, or at the post office which offers counter collection service closest to the given recipient's address, and to inform the recipient via telephone, or telex, using the number provided by the originator.

**B.18 cross-referencing indication****IPM**

This element of service allows the originator to associate with the IP-message being sent, the globally unique identifiers of one or more other IP-messages. This enables the recipient's IPM-UA, for example, to retrieve from storage a copy of the referenced IP-messages.

**B.19 deferred delivery****MT**

This element of service enables an originating UA to instruct the MTS that a message being submitted shall be delivered no sooner than a specified date and time. Delivery will take place as close to the date and time specified as possible, but not before. The date and time specified for deferred delivery is subject to a limit which is defined by the originator's management domain.

NOTE – Storage of the message shall be handled in the originating country.

**B.20 deferred delivery cancellation****MT**

This element of service enables an originating UA to instruct the MTS to cancel a previously submitted deferred delivery message. The cancellation attempt may or may not always succeed. Possible reasons for failure are: deferred delivery time has passed, or the message has already been forwarded within the MTS.

**B.21 delivery notification****MT PR**

This element of service enables an originating UA to request that the originating UA be explicitly notified when a submitted message has been successfully delivered to a recipient UA or in use of access units, may indicate that the message has been successfully received by the destination terminal. The notification is related to the submitted message by means of the message identifier and includes the date and time of delivery. In the case of a multidestination message, the originating UA can request this element of service on a per-recipient basis.

When a message is delivered after distribution list expansion, then, depending on the policy of the distribution list, the notification can be sent to either the list owner, the message originator, or both.

Delivery notification carries no implication that any UA or user action, such as examination of the message content, has taken place.

**B.22 delivery time stamp indication****MT PR**

This element of service enables the MTS to indicate to a recipient UA the date and time at which the MTS delivered a message. In the case of physical delivery, this element of service indicates the date and time at which the PDAU has taken responsibility for printing and further delivery of the physical message.

**B.23 delivery via bureaufax service****PD PR**

This element of service allows an originating user to instruct the PDAU and associated PDS to use the bureaufax service for transport and delivery.

**B.24 designation of recipient by directory name****MT PR**

This element of service enables an originating UA to use a directory name in place of an individual recipient's O/R address.

**B.25 disclosure of other recipients****MT**

This element of service enables the originating UA to instruct the MTS when submitting a multi-recipient message, to disclose the O/R names of all other recipients to each recipient UA, upon delivery of the message. The O/R names disclosed are as supplied by the originating UA. If distribution list expansion has been performed, then only the originator specified DL name will be disclosed, and not the names of its members.

**B.26 IPM-UA** **MT**

This element of service provides to a recipient, at delivery, information about the distribution list(s) through which the message has arrived. It is a local matter as to how much of this information is presented to the recipient.

**B.27 IPM-UA** **MT**

This element of service allows an originating user to specify that if any of the recipients can directly or via reassignment refer to a distribution list, then no expansion shall occur. Instead, a non-delivery notification will be returned to the originating UA, unless prevention of non-delivery notification has been requested.

**B.28 express mail service (EMS)** **PD PR**

This element of service allows an originating user to instruct the PDS to transport and deliver the physical message produced from the MHS message through accelerated letter circulation and delivery service (such as EMS or the equivalent domestic service) in the destination country.

**B.29 expiry date indication** **IPM**

This element of service allows the originator to indicate to the recipient the date and time after which he considers the IP-message to be invalid. The intent of this element of service is to state the originator's assessment of the current applicability of an IP-message. The particular action on behalf of a recipient by his IPM-UA, or by the recipient himself, is unspecified. Possible actions might be to file or delete the IP-message after the expiry date has passed.

**B.30 explicit conversion** **MT PR**

This element of service enables an originating UA to request the MTS to perform a specified conversion, such as required when interworking between different telematic services. When a message is delivered after conversion has been performed, the recipient UA is informed of the original encoded information types as well as the current encoded information types in the message.

NOTES

- 1 This element of service is intended to support interworking with telematic terminals/services.
- 2 When DL names are used in conjunction with this element of service, conversion will apply to all members of the DL.

**B.31 forwarded IP-message indication** **IPM**

This element of service allows a forwarded IP-message, or a forwarded IP-message plus its "delivery information" to be sent as the body (or as one of the body parts) of an IP-message. An indication that the body part is forwarded is conveyed along with the body part. In a multipart body, forwarded body parts can be included along with body parts of other types. "Delivery information" is information which is conveyed from the MTS when an IP-message is delivered (for example, time stamps and indication of conversion). However, inclusion of this delivery information along with a forwarded IP-message in no way guarantees that this delivery information is validated by the MTS.

The receipt notification request indication and the non-receipt notification request elements of service are not affected by the forwarding of a IP-message.

**B.32 grade of delivery selection** **MT**

This element of service enables an originating UA to request that transfer through the MTS be *urgent* or *non-urgent*, rather than *normal*. The time periods defined for non-urgent and urgent transfer are longer and shorter, respectively, than that defined for normal transfer. This indication is also sent to the recipient with the message.



**B.33 hold for delivery****MT**

This element of service enables a recipient UA to request that the MTS hold its messages and returning notifications for delivery until a later time. The UA can indicate to the MTS when it is unavailable to take delivery of messages and notifications, and also, when it is again ready to accept delivery of messages and notifications from the MTS. The MTS can indicate to the UA that messages are waiting due to the criteria the UA established for holding messages. Responsibility for the management of this element of service lies with the recipient MTA.

Criteria for requesting a message to be held for delivery are: encoded information type, content type, maximum content length, and priority. The message will be held until the maximum delivery time for that message expires, unless the recipient releases the hold prior to its expiry.

NOTE – The hold for delivery element of service is distinct from the message store facility. The hold for delivery element of service provides temporary storage to facilitate delivery and, only after a message has been transferred to the recipient's UA is delivery notification returned. The message store facility augments the storage of a UA and can be used to store messages for an extended period of time. Unlike the hold for delivery element of service, delivery notifications are returned as soon as the message is placed in (that is, delivered to) the message store.

**B.34 implicit conversion****MT**

This element of service enables a recipient UA to have the MTS perform for a period of time any necessary conversion on messages prior to delivery. Neither the originating nor recipient UA explicitly requests this element of service on a per-message basis. If the encoded information type capabilities of the recipient UA are such that more than one type of conversion can be performed, the most appropriate conversion is performed. When a message is delivered after conversion has been performed, the recipient UA is informed of the original encoded information types as well as the current encoded information types in the message.

**B.35 importance indication****IPM**

This element of service allows the originator to indicate to the recipients his assessment of the importance of the IP-message being sent. Three levels of importance are defined: *low*, *normal* and *high*.

This element of service is not related to the grade of delivery selection element of service provided by the MTS. The particular action taken by the recipient or his IPM-UA based on the importance categorization is unspecified. It is the intent to allow the recipient IPM-UA, for example, to present IP-messages in order of their importance or to alert the recipient of the arrival of IP-messages of high importance.

**B.36 incomplete copy indication****IPM**

This element of service allows an originator to indicate that this IP-message is an incomplete copy of an IP-message with the same IP-message identification in that one or more body parts, and/or heading fields of the original IP-message are absent.

**B.37 IP-message identification****IPM**

This element of service enables cooperating IMP-UAs to convey a globally unique identifier for each IP-message sent or received. The IP-message identifier is composed of an O/R name of the originator and an identifier that is unique with respect to that name. IPM-UAs and users use this identifier to refer to a previously sent or received IP-message (for example, in receipt notifications).

**B.38 language indication****IPM**

This element of service enables an originating UA to indicate the language type(s) of a submitted IP-message.

**B.39 latest delivery designation** **MT**

This element of service enables an originating UA to specify the latest time by which the message is to be delivered. If the MTS cannot deliver by the time specified, the message is not delivered and is cancelled. On multi-recipient messages, the latest delivery time can expire prior to delivery to all recipients, but this will not negate any deliveries which have already occurred.

**B.40 message flow confidentiality** **MT**

This element of service allows the originator of the message to protect information which might be derived from observation of the message flow.

NOTE – Only a limited form of this is supported.

**B.41 message identification** **MT**

This element of service enables the MTS to provide a UA with a unique identifier for each message or probe submitted or delivered by the MTS. UAs and the MTS use this identifier to refer to a previously submitted message in connection with elements of service such as delivery and non-delivery notification.

**B.42 message origin authentication** **MT PR**

This element of service allows the originator of a message to provide to the recipient(s) of the message, and any MTA through which the message is transferred, a means by which the origin of the message can be authenticated (i.e. a signature). Message origin authentication can be provided to the recipient(s) of the message, and any MTA through which the message is transferred, on a per-message basis using an asymmetric encryption technique, or can be provided only to the recipient(s) of the message, on a per-recipient basis using either an asymmetric or a symmetric encryption technique.

**B.43 message security labelling** **MT**

This element of service allows the originator of a message (or probe) to associate with the message (and any reports on the message or probe) an indication of the sensitivity of the message (a security label). The message security label may be used by the MTS and the recipient(s) of the message to determine the handling of the message in line with the security policy in force.

**B.44 message sequence integrity** **MT PR**

This element of service allows the originator of the message to provide to a recipient of the message a means by which the recipient can verify that the sequence of messages from the originator to the recipient has been preserved (without message loss, re-ordering, or replay). Message sequence integrity is on a per-recipient basis, and can use either an asymmetric or a symmetric encryption technique.

**B.45 multi-destination delivery** **MT PR**

This element of service enables an originating UA to specify that a message being submitted is to be delivered to more than one recipient UA. Simultaneous delivery to all specified UAs is not implied by this element of service.

**B.46 multi-part body** **IPM**

This element of service allows an originator to send to a recipient or recipients an IP-message with a body that is partitioned into several parts. The nature and attributes, or type, of each body part are conveyed along with the body part.

**B.47 non-delivery notification** **MT PR**

This element of service enables the MTS to notify an originating UA if a submitted message was not delivered to the specified recipient UA(s) or in the case of access units, may indicate that the message was not received by the

destination terminal. The reason the message was not delivered is included as part of the notification. For example, the recipient UA can be unknown to the MTS.

In the case of a multi-destination message, a non-delivery notification can refer to any or all of the recipient to which the message could not be delivered.

When a message is not delivered after distribution list expansion, then, depending on the policy of the distribution list, the notification can be sent to either the list owner, the message originator, or both.

NOTE – Non-delivery notifications are generated automatically, and do not depend on a request by an originator.

#### **B.48 non-receipt notification request indication IPM PR**

This element of service allows the originator to ask that he be notified, should the IP-message be deemed unreceivable. In the case of a multi-recipient IP-message, the originator can request this element of service on a per-recipient basis.

The originator's UA conveys his request to the recipient's UA. The recipient's UA automatically issues a non-receipt notification, if either receipt notification or non-receipt notification was requested, when any of the following events occur:

- 1) the recipient's UA auto-forwards the IP-message to another user;
- 2) the recipient's UA discards the IP-message prior to receipt;
- 3) the recipient's subscription is terminated before he receives the IP-message.

Since receipt can occur arbitrarily long after delivery, the recipient's failure to access the IP-message, even for a long period of time (for example, while on an extended business trip), does not constitute non-receipt and thus no notification is issued.

NOTE – No legal significance can be adduced from this element of service.

#### **B.49 non-repudiation of delivery MT PR**

This element of service allows the originator of a message to obtain from the recipient(s) of the message irrevocable proof that the message was delivered to the recipient(s). This will protect against any attempt by the recipient(s) to subsequently deny receiving the message or its content. Non-repudiation of delivery is provided to the originator of a message on a per-recipient basis using asymmetric encryption techniques.

#### **B.50 non-repudiation of origin MT PR**

This element of service allows the originator of a message to provide the recipient(s) of the message irrevocable proof of the origin of the message. This will protect against any attempt by the originator to subsequently revoke the message or its content. Non-repudiation of origin is provided to the recipient(s) of a message on a per-message basis using asymmetric encryption techniques.

#### **B.51 non-repudiation of submission MT**

This element of service allows the originator of a message to obtain irrevocable proof that a message was submitted to the MTS for delivery to the originally specified recipient(s). This will protect against any attempt by the MTS to subsequently deny that the message was submitted for delivery to the originally specified recipient(s). Non-repudiation of submission is provided to the originator of a message on a per-message basis, and uses an asymmetric encryption technique.

#### **B.52 obsoleting indication IPM**

This element of service allows the originator to indicate to the recipient that one or more IP-messages he sent previously are obsolete. The IP-message that carries this indication supersedes the obsolete IP-message.

The action to be taken by the recipient or his IPM-UA is a local matter. The intent, however, is to allow the IPM-UA or the recipient to, for example, remove or file obsolete messages.

**B.53 ordinary mail****PD PR**

This element of service enables the PDS to transport and deliver the letter produced from the MHS message in the mode available through the ordinary letter mail service in the country of destination. This is the default action for the transport and delivery of a physical message.

**B.54 original encoded information types indication****MT**

This element of service enables an originating UA to specify to the MTS the encoded information types of a message being submitted. When the message is delivered, it also indicates to the recipient UA the encoded information types of the message specified by the originating UA.

**B.55 originator indication****IPM**

This element of service allows the identity of the originator to be conveyed to the recipient. The intent of this IPM element of service is to identify the originator in a user-friendly way. In contrast, the MTS provides to the recipient the actual O/R address and directory name, if present, of the originator. DL names should not be used in originator indication.

**B.56 originator requested alternate recipient****MT PR**

This element of service enables an originating UA to specify, for each intended recipient, one alternate recipient to which the MTS can deliver the message, if delivery to the intended recipient is not possible. The alternate recipient can be a distribution list. For the purposes of determining success or failure (and hence delivery and non-delivery notifications), delivery to the originator requested alternate recipient is equivalent to delivery to the intended recipient. If the intended recipient has requested redirection of incoming messages, and if the originating UA has requested redirection allowed by the originator, the system first tries to redirect the message. If this fails, the system then attempts to deliver the message to the designated alternate recipient.

**B.57 physical delivery notification by MHS****PD PR**

This element of service allows an originating user to request that an explicit notification, informing the originator of either successful or unsuccessful delivery of the physical message, be generated and returned by MHS. The notification provides information on delivery but no physical record is provided by the PDS.

## NOTES

1 The notification includes the date and time of delivery based on the delivery confirmation given by the delivery person, the addressee or another authorized person. This is subject to national regulations in the destination country and is also dependent on the type of delivery requested (e.g. in the case of registered mail to addressee in person, the addressee would be the confirming person).

2 This notification carries no implication that any action on the part of the recipient (such as examination of the message content) has taken place.

3 When this element of service is requested, and the physical message is undeliverable, it is either returned or destroyed depending on national regulations in the destination country, which means that the default action of the element of service B.91 is overridden.

**B.58 physical delivery notification by PDS****PD PR**

This element of service allows an originating user to request that an explicit notification, informing the originator of either successful or unsuccessful delivery of the physical message, be generated and returned by the PDS. The notification serves as a record of delivery for the originating user to retain for reference.

## NOTES

1 The notification includes the date and time, and, in the case of successful delivery, the signature of the person confirming the delivery. The confirming person can be the delivery person, the addressee or another authorized person. This is subject to national regulations in the destination country and is also dependent on the type of delivery requested (e.g. in the case of registered mail to addressee in person, the addressee would be the confirming person).

2 This notification carries no implication that any action on the part of the recipient (such as examination of the message content) has taken place.

3 When this element of service is requested, and the physical message is undeliverable, it is either returned or destroyed depending on national regulations in the destination country, which means that the default action of the element of service B.91 is overridden.

**B.59 physical forwarding allowed PD PR**

This element of service enables the PDS to forward the physical message to a forwarding address if the recipient has changed his address and indicated this to the PDS. This is the default action taken by the PDS.

**B.60 physical forwarding prohibited PD PR**

This element of service allows an originating user to instruct the PDS not to forward the physical message to a forwarding address.

**B.61 prevention of non-delivery notification MT PR**

This element of service enables an originating UA to instruct the MTS not to return a non-delivery notification to the originating UA in the event that the message being submitted is judged undeliverable. In the case of a multi-destination message, the originating UA can request this element of service on a per-recipient basis.

**B.62 primary and copy recipients indication IPM**

This element of service allows the originator to provide the names of zero or more users, or DLs, who are the intended primary recipients of the IP-message, and the names of zero or more users, or DLs, who are the intended copy recipients of the IP-message. It is intended to enable a recipient to determine the category in which each of the specified recipients (including the recipient himself) was placed. The exact distinction between these two categories of recipients is unspecified. However, the primary recipients, for example, might be expected to act upon the IP-message, while the copy recipients might be sent the IP-message for information only.

NOTE – As an example of this element of service in a typical memorandum, the primary recipients are normally designated by the directive “to:” while “cc:” identifies the copy recipients.

**B.63 probe MT**

This element of service enables a UA to establish before submission whether a particular message could be delivered. The MTS provides the submission information and generates delivery and/or non-delivery notifications indicating whether a message with the same submission information could be delivered to the specified recipient UAs.

The probe element of service includes the capability of checking whether the content size, content type, and/or encoded information types would render it undeliverable. The significance of the result of a probe depends upon the recipient UA(s) having registered with the MTS the encoded information types, content type and maximum message size that it can accept. This element of service is subject to the same delivery time targets as for the urgent class. In the case of DLs, a probe indicates nothing about the likelihood of successful delivery to the DL members, but only whether the originator has the right to submit to the DL.

**B.64 probe origin authentication MT**

This element of service allows the originator of a probe to provide to any MTA through which the probe is transferred a means to authenticate the origin of the probe (i.e. a signature). Probe origin authentication is on a per-probe basis, and uses an asymmetric encryption technique.

**B.65 proof of delivery MT PR**

This element of service allows the originator of a message to obtain from the recipient(s) of the message the means to authenticate the identity of the recipient(s) and the delivered message and content. Message recipient authentication is provided to the originator of a message on a per-recipient basis using either symmetric or asymmetric encryption techniques.

**B.66 proof of submission****MT**

This element of service allows the originator of a message to obtain from the MTS the means to authenticate that the message was submitted for delivery to the originally intended recipient. Message submission authentication is provided on a per-message basis, and can use symmetric or asymmetric encryption techniques.

**B.67 receipt notification request indication****IPM PR**

This element of service allows the originator to ask that he be notified when the IP-message being sent is received by the recipient's UA. In the case of a multi-recipient message, the originator can request this element of service on a per-recipient basis. This element of service also implicitly requests non-receipt notification request indication.

The originator's UA conveys his request to the recipient's UA. The recipient can instruct his UA to honour such requests, either automatically (for example, when it first renders the IP-message on the recipient's terminal) or upon his explicit command. The recipient can also instruct his UA, either in blanket fashion or case by case, to ignore such requests.

**B.68 redirection disallowed by originator****MT**

This element of service enables an originating UA to instruct the MTS, if the recipient has requested the redirection of incoming messages element of service, that redirection should not be applied to a particular submitted message.

**B.69 redirection of incoming messages****MT**

This element of service enables a UA, through registration, to instruct the MTS to redirect incoming messages addressed to it, to another UA or to a DL, for a specified period of time, or until revoked.

## NOTES

1 This is an MT element of service that does not require delivery to the intended recipient before redirection can take place. It is therefore distinct from the Auto-forwarding of IP-messages element of service.

2 Different incoming messages, on the basis of their content-types, security labels, and other criteria, may be redirected to separate alternate recipients or not redirected at all.

**B.70 registered mail****PD PR**

This element of service allows an originating user to instruct the PDS to handle the physical message as registered mail.

**B.71 registered mail to addressee in person****PD PR**

This element of service allows an originating user to instruct the PDS to handle the physical message as registered mail and to deliver it to the addressee only.

**B.72 reply request indication****IPM PR**

This element of service allows the originator to request that a recipient send an IP-message in reply to the IP-message that carries the request. The originator can also specify the date by which any reply should be sent, and the one or more users and DLs to whom the originator requests (but does not demand) be among the preferred recipients of any reply. The recipient is informed of the date and names but it is up to the recipient to decide whether or not, and if so, to whom to reply.

NOTE – A blind copy recipient should consider carefully to whom he sends a reply, in order that the meaning of the blind copy recipient indication element of service is preserved.

### **B.73 replying IP-message indication**

**IPM**

This element of service allows the originator of an IP-message to indicate to the recipient(s) that this IP-message is being sent in reply to another IP-message. A reply can, depending on the wishes of the originator of the replied-to message, and the final decision of the originator of the reply, be sent to:

- 1) the recipients specified in the reply request indication of the replied-to message;
- 2) the originator of the replied-to message;
- 3) the originator and other recipients;
- 4) a distribution list, in which the originator of the replied-to message can be a receiving member;
- 5) other recipients as chosen by the originator of the reply.

The recipients of the reply receive it as a regular IP-message, together with an indication of which IP-message it is a reply to.

### **B.74 report origin authentication**

**MT**

This element of service allows the originator of a message (or probe) to authenticate the origin of a report on the delivery or non-delivery of the subject message (or probe), (a signature). Report origin authentication is on a per-report basis, and uses an asymmetric encryption technique.

### **B.75 request for forwarding address**

**PD PR**

This element of service allows an originating user to instruct the PDS to provide the forwarding address if the recipient has changed his address and indicated this to the PDS.

This element of service can be used with either physical forwarding allowed or prohibited. The provision of the forwarding address by the PDS to an originating user is subject to national regulations in the destination country. The default action is no provision of the forwarding address.

### **B.76 requested preferred delivery method**

**MT PR**

This element of service allows a user to request, on a per-recipient basis, the preference of method or methods of message delivery (such as through an access unit).

NOTE – This assumes availability of a directory and specification of a directory name by the originator together with this element of service. It may not be possible to match the request with the O/R address available in the directory. Non-delivery may occur if no feasible match can be found.

### **B.77 restricted delivery**

**MT**

This element of service enables a recipient UA to indicate to the MTS, through registration, that it is not prepared to accept delivery of messages which originate from, or are redirected by, or are DL-expanded by certain MTS-users.

#### **NOTES**

- 1 This element of service can be requested in either of two ways:
  - a) specification by the recipient UA of unauthorized originators, all other originators are considered as authorized;
  - b) specification by the recipient UA of authorized originators, all other originators are considered to be unauthorized.

2 The MTS abstract service specified in Recommendation X.411 and ISO/IEC 10021-4 does not provide a technical realization of this element of service. Its provision is for further study.

### **B.78 return of content**

**MT**

This element of service enables an originating UA to request that the content of a submitted message be returned with any non-delivery notification. This will not be done, however, if any encoded information type conversion has been performed on the message's content.

## **B.79 secure access management**

**MT**

This element of service enables an MTS user to establish an association with the MTS, or the MTS to establish an association with an MTS user, or an MTA to establish an association with another MTA. It also establishes the strong credentials of the objects to interact, and the context and security-context of the association. Secure access management can use either an asymmetric or a symmetric encryption technique. When access security is achieved through strong credentials, they can be periodically updated.

## **B.80 sensitivity indication**

**IPM**

This element of service allows the originator of an IP-message to specify guidelines for the relative sensitivity of the message upon its receipt. It is the intent that the sensitivity indication should control such items as:

- 1) whether the recipient should have to prove his identity to receive the IP-message;
- 2) whether the IP-message should be allowed to be printed on a shared printer;
- 3) whether an IPM-UA should allow the recipient to forward the received IP-message;
- 4) whether the IP-message should be allowed to be auto-forwarded.

The sensitivity indication can be indicated to the recipient or interpreted directly by the recipient's IPM-UA.

If no sensitivity level is indicated, it should be assumed that the IP-message originator has advised no restriction on the recipient's further disposition of the IP-message. The recipient is free to forward, print, or otherwise do as he chooses with the IP-message.

Three specific levels of sensitivity above the default are defined:

- *Personal*: The IP-message is sent to the recipient as an individual, rather than to him in his role. There is no implication that the IP-message is private, however.
- *Private*: The IP-message contains information that should be seen (or heard) only by the recipient, and not by anyone else. The recipient's IPM-UA can provide services to enforce this intent on behalf of the IP-message's originator.
- *Company-confidential*: The IP-message contains information that should be treated according to company-specific procedures.

## **B.81 special delivery**

**PD PR**

This element of service allows an originating user to instruct the PDS to transport the letter produced from the MHS message through the ordinary letter mail circulation system and to deliver it by special messenger delivery.

## **B.82 stored message alert**

**MS**

This element of service allows a user of an MS to register relevant sets of criteria that can cause an alert to be generated to the user when a message arrives at the MS satisfying the selected criteria. The generation of the alert can occur as follows:

- 1) If the UA is connected and on-line to the MS, the alert message will be sent to the UA as soon as a message arrives at the MS that satisfies the registered criteria for generating alerts. If the UA is off line then the next time the UA connects to his MS after a message arrives at the MS satisfying the registered criteria, the user will be informed that one or more alert cases have occurred, the details of which can be determined by performing a stored message summary.



2) In addition to, or as an alternative to 1) above, the MS can use other mechanisms to inform the user.

**B.83 auto-forwarding of IP-messages** **MS**

This element of service enables an MS-user to instruct the MS to auto-forward selected IP-messages that are delivered to it. The MS-user may specify through registration several sets of criteria chosen from the attributes available in the MS, and IP-messages meeting each set of criteria will be auto-forwarded to one or more users or DLs. If requested by the message originator, a non-receipt notification is generated indicating that the IP-message was auto-forwarded, even if the MS retains a copy of the forwarded message. For each set of selection criteria, a body part may be specified, to be included as a “cover-note” with each auto-forwarded IP-message.

NOTE – In versions of this part of ISO/IEC 10021 published prior to 1994, this element of service was named Stored Message Auto-forward, and classified as a general MS optional user facility; it has since been classified as IPM-specific.

**B.84 stored message deletion** **MS**

This element of service enables a recipient UA to delete certain of its messages from the MS. Subject to subscription, deletion may be restricted to messages meeting certain criteria, e.g. messages stored for longer than an agreed period of time. Messages cannot be deleted if they have not been previously listed.

**B.85 stored message fetching** **MS**

This element of service enables a recipient UA to fetch from the MS a message, or portions of a message. The UA can fetch a message (or message portion) based on the same search criteria that can be used for stored message listing.

**B.86 stored message listing** **MS**

This element of service provides a recipient UA with a list of information about certain of its messages stored in the MS. The information comprises selected attributes from a message’s envelope and content and others added by the MS. The UA can limit the number of messages that will be listed.

**B.87 stored message summary** **MS**

This element of service provides a recipient UA with a count of the number of messages satisfying a specified criteria based on one or more attributes of the message stored in the MS.

**B.88 subject indication** **IPM**

This element of service allows the originator to indicate to the recipient(s) the subject of an IP-message being sent. The subject information is to be made available to the recipient.

**B.89 submission time stamp indication** **MT**

This element of service enables the MTS to indicate to the originating UA and each recipient UA the date and time at which a message was submitted to the MTS. In the case of physical delivery, this element of service also enables the PDAU to indicate the date and time of submission on the physical message.

## **B.90 typed body**

**IPM**

This element of service permits the nature and attributes of the body of the IP-message to be conveyed along with the body. Because the body can undergo conversion, the body type can change over time.

### **NOTES**

1 One example is the use of a file transfer body part. This provides for conveying the contents of a stored file and other information associated with the file from originator to recipient. The other information includes:

- file attributes, which are typically stored along with the file contents;
- information on the environment from which the transfer originated;
- references to existing stored files or earlier messages.

2 Another example is the use of a voice body part.

## **B.91 undeliverable mail with return of physical message**

**PD PR**

This element of service enables the PDS to return the physical message without delay, with reason indicated to the originator, if it cannot be delivered to the addressee. This is the default action to be taken by the PDS.

NOTE – In the case of “poste restante” the return of the physical message will take place after some period of time.

## **B.92 use of distribution list**

**MT PR**

This element of service enables an originating UA to specify a distribution list in place of all the individual recipients (users or nested DLs) mentioned therein. The MTS will add the members of the list to the recipients of the message and send it to those members. Distribution lists can be members of distribution lists, in which case the list of recipients can be successively expanded at several places in the MTS.

## **B.93 user/UA capabilities registration**

**MT**

This element of service enables a UA to indicate to its MTA, through registration, the categories of message it is capable of handling, and which MTA may deliver to it. A message category is defined as a combination of various properties:

- 1) the content type(s) of messages which may be delivered;
- 2) the encoded information type(s) of messages which may or may not be delivered;
- 3) additional properties, including the maximum message length, and the security labels present.

NOTE – It is possible to register certain encoded information types such that they cause a message to be delivered regardless of the other encoded information types present. A user may declare certain encoded information types undeliverable to cause the MTS to perform implicit conversion.

The UA may specify different sets of registration information to control the delivery of different categories of message.

The MTA will not deliver to a UA a message that does not match, or exceeds, the capabilities registered.

## **B.94 auto-submitted indication**

**IPM**

This element of service allows the originator, or enables the UA/MS, to indicate to the recipient whether the message was or was not submitted automatically by a machine without either the direct or indirect control by a human of the submission, and to determine the nature of the submission, thus:

- not auto-submitted;
- auto-generated;
- auto-replied;
- auto-forwarded.

The absence of this indication yields no information as to whether the message submission involved human control or not.

## **B.95 MS register**

**MS**

This element of service enables an MS-user to register various items of information with the MS in order to modify certain aspects of its behaviour, such as:

- 1) the performance of automatic actions;
- 2) the default set of information retrieved when using the Stored Message Fetching and Stored Message Listing elements of service. One set of information may be registered per UA employed by the user;
- 3) the credentials used by the Message Store to authenticate the MS-user.

If a user employs more than one UA implementation, then as a subscription option the MS may store a separate set of registration information for each UA. The user may retrieve the registered information from the MS.

NOTE – The capability to store separate sets of registration information and to retrieve registered information was not defined in versions of this Recommendation published prior to 1996.

## **B.96 auto-acknowledgement of IP-messages**

**IPM MS**

This element of service enables an MS-user to instruct the MS to generate a receipt notification automatically for each IP-message containing a receipt notification request which is delivered to the MS. The receipt notification is sent when the complete IP-message has been retrieved by the user or when the user indicates to the MS that he regards the message as having been retrieved.

## **B.97 auto-action log**

**MS**

This element of service enables an MS-user to access a log that records details of selected auto-action executions performed by the MS. The MS-user is able to retrieve information from the Auto-action Log by means of the Stored Message Listing and Stored Message Fetching elements of service. The ability to delete Auto-action Log entries is subject to subscription. This log of information is available if and only if this element of service is subscribed to by the user of the MS. Support for an element of service which comprises an auto-action does not require support for the Auto-action Log element of service. For each type of auto-action that may generate log entries, it is a subscription option whether all auto-action executions are logged, or only those executions that result in an error, or no executions are logged for that auto-action.

## **B.98 auto-assignment of annotations**

**MS**

This element of service enables an MS-user to instruct the MS to attach annotations to a selected message automatically, when the message is stored in the MS and satisfies specified criteria. The MS-user may specify, through registration, several sets of selection criteria each of which may indicate the attachment of a different value of annotation. Subscription to this element of service requires subscription to the Stored Message Annotation element of service.

## **B.99 auto-assignment of group names**

**MS**

This element of service enables an MS-user to instruct the MS to assign group-names to a selected message automatically, when the message is stored in the MS and satisfies specified criteria. The MS-user may specify, through registration, several sets of selection criteria each of which may indicate the assignment of a different group-name. The MS will verify that only registered group-names are assigned to messages. Subscription to this element of service requires subscription to the Stored Message Grouping element of service.

## **B.100 auto-assignment of storage period**

**MS**

This element of service enables an MS-user to instruct the MS to assign a storage period to a selected message automatically, when the message is stored in the MS and satisfies specified criteria. The MS-user may specify, through registration, several sets of selection criteria each of which may indicate the attachment of a different value of storage period. Subscription to this element of service requires subscription to the Storage Period Assignment element of service.

### **B.101 auto-correlation of IP-messages**

**IPM MS**

This element of service enables an MS-user to retrieve information, automatically generated by the MS, concerning the correlation between various related IP-messages. The following types of messages may be correlated:

- 1) IP-messages received in reply to, or sent in reply to an IP-message;
- 2) the IP-messages which forwarded (or auto-forwarded) one or more messages;
- 3) the received or submitted IP-messages that obsolete an IP-message;
- 4) the received or submitted IP-messages that indicate that they are related to an IP-message.

Besides identifying each IP-message related to a given message in the ways indicated, the MS provides a summary of all such responding IP-messages.

### **B.102 auto-correlation of IP-notifications**

**IPM MS**

This element of service enables an MS-user to retrieve information, automatically generated by the MS, concerning the IP-notifications that have been received in response to a previously submitted IP-message. Information may also be retrieved concerning IP-notifications sent by the MS-user or the MS in response to delivered IP-messages. The MS identifies each IP-notification related to a given submitted or delivered message, and for submitted messages it also provides a summary of received IP-notifications. This enables the MS-user to access this information directly rather than perform an exhaustive search of all entries that could hold the information. This element of service is effective only if the submitted or delivered message that an IP-notification refers to is stored in the MS, or is recorded in the Submission Log or Delivery Log. Provision for the storage of submitted messages, and maintenance of the Submission Log and the Delivery Log are supported by separate elements of service.

### **B.103 auto-correlation of reports**

**MS**

This element of service enables an MS-user to retrieve information, automatically generated by the MS, concerning the delivery and non-delivery reports that have been received in response to a previously submitted message. Successful cancellations of deferred delivery for submitted messages are also recorded. In addition to identifying each report related to a given submitted message, the MS provides a summary of these reports. This enables the MS-user to access this information directly rather than perform an exhaustive search of all entries that could hold the information. This element of service requires that at least one of the Submission Log or Storage on Submission elements of service has also been subscribed to.

### **B.104 auto-deletion after storage period**

**MS**

This element of service enables an MS-user to instruct the MS to delete automatically any stored message whose storage period has elapsed. This registration remains in force until disabled by a subsequent registration. Messages that have not been listed or processed are not subject to auto-deletion. Equally, entries of the Submission Log, Delivery Log, and Auto-action-log are not subject to auto-deletion. Other content-specific message handling Specifications may lay down additional rules for the performance of this element of service. Subscription to this element of service requires subscription to the Storage Period Assignment element of service.

### **B.105 auto-discarding of IP-messages**

**IPM MS**

This element of service enables an MS-user to instruct the MS to discard stored IP-messages automatically, if they satisfy criteria registered by the MS-user. An IP-message becomes a candidate for auto-discarding if a subsequently delivered IP-message renders it obsolete, or if it contains an Expiry Time that has been reached. The MS-user may control whether auto-discarding occurs for such IP-messages by specifying additional conditions which the IP-message must satisfy, e.g. that the message has been fetched by the MS-user, or that the obsoleting IP-message has the same originator as the obsoleted IP-message. Where the message has not been fetched by the MS-user before being auto-discarded, a non-receipt notification is generated if requested in the discarded IP-message.

**B.106 delivery log****MS**

This element of service enables an MS-user to access a log that records details of the messages and reports delivered to the MS; these records persist even after the messages and reports have been deleted. A Delivery Log entry contains a subset of the information that may be stored for a delivered message. The quantity of information stored in the Delivery Log for each message is specified at subscription time. The MS-user is able to determine whether the delivered message corresponding to a Delivery Log entry has been deleted. The MS-user is able to retrieve information from the Delivery Log by means of the Stored Message Listing, Stored Message Fetching and Stored Message Summary elements of service. The ability to delete Delivery Log entries is subject to subscription, and may be restricted to messages meeting certain criteria, e.g. messages stored longer than an agreed period of time.

**B.107 IP-message action status****IPM MS**

This element of service enables an MS-user to determine whether a reply or a receipt notification has been requested of the user in an IP-message which the user has received. It allows the user to record in the MS (and subsequently retrieve the information) that the reply (or IP-notification) has been sent. In addition, the user may set a reminder that a reply is intended even if no reply was explicitly requested.

**B.108 storage of draft messages****MS**

This element of service enables an MS-user to store draft messages in the MS. The user may obtain summaries of draft messages and may access a draft message by means of the Stored Message Listing and Stored Message Fetching elements of service.

**B.109 storage on submission****MS**

This element of service enables an MS-user to instruct the MS to store a copy of a message upon its submission, either by the MS-user or as a result of the performance of an auto-action. Storage of a submitted message is conditional upon the success of the submission. The user may instruct the MS to store all submitted messages, or may control storage on a per message basis.

**B.110 storage period assignment****MS**

This element of service enables an MS-user to assign a storage period to a stored message. The storage period indicates the period of time for which the user anticipates the message should be retained in the MS; this may be expressed as a period of time (from the start of storage), or as an absolute date and time. This element of service must be subscribed to if the Auto-deletion after Storage Period or Auto-assignment of Storage Period elements of service are subscribed to.

**B.111 stored message annotation****MS**

This element of service enables an MS-user to attach one or more textual annotations to a stored message. Annotations apply to the complete message and may not be applied selectively to different parts of the message. Annotations are local to the MS and MS-user and are not transmitted through the MTS in any message. The "cover note" described in B.83 is not related to message annotations.

**B.112 stored message grouping****MS**

This element of service enables an MS-user to attach group-names to messages stored in the MS. A message can have zero, one, or more group-names associated with it that can subsequently be used for selection purposes. Each message group-name comprises a sequence of components which may be regarded as modelling a storage hierarchy. The setting, changing, or deletion of the group-names attached to a message can be performed by the MS-user.

The UA indicates to the MS, through registration, the name of each distinct group which the UA will employ to label each group of related messages. Each group-name may be assigned a descriptive text registered together with the group-name. The MS will verify that the group-names subsequently employed by the user belong to the registered set of

group-names, and will prevent the user from deregistering group-names which are currently attached to stored messages, or which are registered for use by the Auto-assignment of Group Names element of service. A group-name remains valid until it is deregistered. The MS will prohibit an attempt to register the same group-name twice.

### **B.113 submission log**

**MS**

This element of service enables an MS-user to access a log that records details of the messages submitted from the MS to the MTS. These records are generated regardless of whether a copy of the submitted message is stored by means of the Storage on Submission element of service. Even where a copy is stored, the corresponding Submission Log entry may persist after the message has been deleted. Both successful and unsuccessful submissions are recorded. A Submission Log entry contains a subset of the information that may be stored for a submitted message. The quantity of information stored in the Submission Log for each message is specified at subscription time. The MS-user is able to determine whether the submitted message corresponding to a Submission Log entry has been deleted. The MS-user is able to retrieve information from the Submission Log by means of the Stored Message Listing, Stored Message Fetching and Stored Message Summary elements of service. The ability to delete Submission Log entries is subject to subscription, and may be restricted to messages meeting certain criteria, e.g. messages stored longer than an agreed period of time.

### **B.114 submission of IP-messages incorporating stored messages**

**IPM MS**

This element of service enables an MS-user to instruct the MS to incorporate parts of one or more stored messages as body parts of a submitted IP-message. The submitted IP-message may also contain body parts supplied in the submission from the MS-user.

The stored message which is the source of a body part may be a delivered, submitted or draft message. Individual body parts or the whole content of a stored IP-message may be incorporated. When the content is incorporated it will form a Forwarded IP-message. Delivery-information may also be incorporated from delivered messages when the content is incorporated.

The MS may optionally support the forwarding of body parts from messages which are not IP-messages. In this case, only body parts whose definition is compatible with IPM (or for which rules of conversion into IPM body parts are defined) may be forwarded. The complete content of a message cannot be forwarded if the message is not an IP-message.

The message submitted to the MTS, incorporating the stored messages or body parts may be stored in the MS if the user subscribes to the Storage on Submission element of service. An extract of the message will also be stored in the Submission Log if this element of service is subscribed to.

### **B.115 non-repudiation of content received**

**IPM**

This Element of Service enables a recipient of an IP-message to provide an irrevocable proof that the original IP-message content was received by the recipient. This service provides irrevocable proof of the integrity of the content received and irrevocable proof of the authenticity of the recipient of the IP-message. This service fulfils the same function as the Proof of Content Received Element of Service, but in a manner which cannot be repudiated.

The corresponding irrevocable proof can be supplied in various ways depending on the security policy in force. The originator of the IP-notification always uses the “Non-repudiation of Origin” Element of Service when sending the IP-notification in response to the IP-message:

one way of providing the irrevocable proof is to incorporate the following in the IP-notification:

- A verified copy of the IP-message originator’s “Non-repudiation of Origin” arguments (when present in the IP-message and verified by the recipient of the IP-message).
- A verified copy of the complete IP-message content, if the IP-message originator’s “Non-repudiation of Origin” arguments are not present in the IP-message.

NOTE – As an alternative to invoking this Element of Service, equivalent security may be achieved by the use of a notarisation mechanism, which requires bilateral agreement outside the scope of this Recommendation.

The recipient is required to fulfil the request for this Element of Service only when the UA is subject to a security policy which mandates the support of this element of service.

### **B.116 request for non-repudiation of content received**

**IPM**

This Element of Service enables the originator of an IP-message to request the recipient of the IP-message to provide an irrevocable proof of the received IP-message content by means of an IP-notification.

This Element of Service may be subscribed to only if the Receipt Notification Request Indication Element of Service is subscribed to.

If this Element of Service is requested, the Request for Proof of Content Received Element of Service shall not be requested.

This Element of Service provides only an indication of the originator's request. Fulfilment of the request requires support of the Non-repudiation of Content Received Element of Service.

### **B.117 non-repudiation of IP-notification**

**IPM**

This Element of Service provides the recipient of a IP-notification with irrevocable proof of the identity of the originator of the IP-notification and with proof that the corresponding IP-message was received by the recipient.

This protects against any attempt by the recipient to deny subsequently that the IP-message was received or that the IP-notification was returned to the originator of the IP-message. This Element of Service fulfils the same service as Proof of IP-notification but in a manner which cannot be repudiated.

This Element of Service is used only in conjunction with Non-repudiation of Origin Element of Service applied to the IP-notification.

The corresponding irrevocable proof can be supplied in various ways depending on the security policy in force. One way of providing the irrevocable proof is by means of the MTS-user to MTS-user Data Origin Authentication Security Services defined in 10.2.1.1.1/X.402 and in ISO/IEC 10021-2 applied to the IP-notification, when the security service has non-repudiation properties.

The recipient is required to fulfil the request for this Element of Service only when the UA is subject to a security policy which mandates the support of this element of service.

### **B.118 request for non-repudiation of IP-notification**

**IPM**

This Element of Service enables the originator of an IP-message to request the recipient of the IP-message to provide irrevocable proof of the origin of an IP-notification generated in response to the IP-message.

This Element of Service may be subscribed to only if the Receipt Notification Request Indication Element of Service is subscribed to.

If this Element of Service is requested, the Request for Proof of IP-notification Element of Service shall not be requested.

This Element of Service provides only an indication of the originator's request. Fulfilment of the request requires support of the Non-repudiation of IP-notification Element of Service.

### **B.119 proof of content received**

This Element of Service enables a recipient of an IP-message to provide proof that the original IP-message content was received by the recipient. This service provides proof of the integrity of the content received and proof of the authenticity of the recipient of the IP-message.

This Element of Service is used only in conjunction with "Content Integrity" and/or "Message Origin Authentication" Elements of Service applied to the subject IP-notification.

The corresponding proof can be supplied in various ways depending on the security policy in force. The originator of the IP-notification always uses the "Content Integrity" and/or "Message Origin Authentication" Element of Service when sending the receipt IP-notification in response to the IP-message.

One way of providing the proof is to incorporate the following in the IP-notification:

- A verified copy of the IP-message originator's "Content Integrity" and/or "Message Origin Authentication" arguments (when present in the IP-message and verified by the recipient of the IP-message).

- A verified copy of the complete original IP-message content, if the IP-message originator's "Content Integrity" and/or "Message Origin Authentication" arguments are not present in the IP-message.

The recipient is required to fulfil the request for this Element of Service only when the UA is subject to a security policy which mandates the support of this element of service.

NOTES

1 The "Message Origin Authentication" Element of Service may be provided on a per message basis using the **Message-origin-authentication-check** and/or on a per recipient basis using the **Message-token** as defined in Recommendation X.411 | ISO/IEC 10021-4.

2 The "Content Integrity" Element of Service may be conveyed in several places on the message envelope. The **Content-integrity-check** can be stand-alone security argument in the message envelope and/or attributes of the **Message-token** as defined in Recommendation X.411 and ISO/IEC 10021-4.

**B.120 request for proof of content received**

**IPM**

This Element of Service enables the originator of the IP-message to request the recipient of the IP-message to provide proof of the received IP-message content by means of an IP-notification.

This Element of Service may be subscribed to only if the Receipt Notification Request Indication Element of Service is subscribed to.

This Element of Service provides only an indication of the originator's request. Fulfilment of the request requires support of the Proof of Content Received Element of Service.

**B.121 proof of IP-notification**

**IPM**

This Element of Service provides the originator of an IP-message with proof that the IP-message was received by its recipient, and that the recipient was the originator of the received IP-notification.

This protects against any attempt by the recipient IPM-UA to deny subsequently that the IP-message was received and that the IP-notification was returned to the originator.

This Element of Service is used only in conjunction with "Content Integrity" and /or the "Message Origin Authentication" Element of Service applied to the IP-notification.

The corresponding proof can be supplied in various ways depending on the security policy in force. One way of providing the proof is by means of the MTS-user to MTS-user Data Origin Authentication Security Services, defined in 10.2.1.1.1/X.402 and in ISO/IEC 10021-2, applied to the IP-notification.

The recipient is required to fulfil the request for this Element of Service only when the UA is subject to a security policy which mandates the support of this element of service.

**B.122 request for proof of IP-notification**

**IPM**

This Element of Service enables the originator of the IP-message to request the recipient of the IP-message to provide proof of the origin of an IP-notification generated in response to the IP-message.

This Element of Service may be subscribed to only if the Receipt Notification Request Indication Element of Service is subscribed to.

This Element of Service provides only an indication of the originator's request. Fulfilment of the request requires support of the Proof of IP-notification Element of Service.

**B.123 copy precedence**

**IPM MT**

This element of service enables an originating UA to convey the precedence level (i.e. supplemental importance information) of a message as it applies to the copy recipients. Six levels of precedence are defined for this field (please see Table B.1 defined in B.131 below for specific values and their semantics).

The value of the copy precedence field must always be equal to, or of a lesser priority than the value of the primary precedence field.

Additional levels of precedence may be defined for national use. Upon receipt, the handling of unknown precedence levels will be dictated by the local "precedence handling policy".



**B.124 distribution code****IPM**

This element of service enables the originating UA to give distribution information to a recipient UA. The recipient UA can use this information to perform local distribution of a message to one or more persons or staff cells. This service contains two components, the Subject Indicator Code (SIC) and a distribution code, each of which is optional.

The SICs are bilaterally agreed codes that define the subject matter of a message to support onward distribution after delivery to a recipient organization. Each SIC can consist of between three and eight characters. It is possible to attach up to eight SICs to a message.

The distribution code service the same function, but allows future use of object identifiers as the local distribution criteria. Any number of distribution codes may be specified. The assignment of the distribution code can be privately defined or may be subject to future standardization.

**B.125 exempted address****IPM MT**

This element of service is used to convey the names of members of a DL that the originator has specified are to be excluded from receiving the message. Exclusion is performed at the point of DL expansion. The names or addresses of exempted list members are also conveyed to the remaining recipient UAs. There is no guarantee that the exempted addresses will not receive the message as the result of redirection.

**B.126 extended authorization information****IPM**

This element of service enables the originating UA to indicate to a recipient UA the date and time of some important event associated with the message, such as when the release of the message was formally approved. Depending upon local requirements, this date and time stamp may vary from the date and time when the message was submitted to the MTS. This element of service may be used in conjunction with B.5 to provide supplementary information.

**B.127 message instructions****IPM**

This element of service enables the originating UA to indicate to the recipient UA that message instructions (e.g. remarks) accompany the message. Examples of message instructions include special recipient handling requests, special body descriptions and bilateral information.

**B.128 message type****IPM**

This service element enables receiving UAs to distinguish messages that relate to a specific project, contract, company position, press release, operation, exercise or drill. The service can convey a discrete identifier for each particular type plus optional printable information capable of identifying a particular project, press release, contract, company position, exercise, operation or drill. The value is provided by the originator.

**B.129 originator reference****IPM**

This element of service enables the originating UA to indicate to a recipient UA a reference called the "originator's number". The originator's number may be used by the originating organizational unit as an internal reference. This service element is different from the identifier in that this reference is assigned by the originator, while the identifier is supplied by the UA.

**B.130 other recipients indicator****IPM**

The intent of this service element is to enable a recipient to determine which recipients are intended to receive the message without the use of MHS, as well as the category in which they are placed. While the primary and copy recipients indication service provides the names of recipients that can be reached through MHS, other recipients can be determined with this service element.

NOTE – This service element does not allow the originator to convey the reason why the other recipient(s) will not receive the message via the MHS.

## B.131 primary precedence

IPM MT

This element of service enables an originating UA to convey the precedence level (i.e. supplemental importance) information of a message as it applies to the primary recipients. Six levels of precedence are defined for this element of service (see below for specific values and their semantics).

Additional levels of precedence may be defined for national use. Upon receipt, the handling of unknown precedence levels will be dictated by the local "precedence handling policy".

This service is provided not only as information from originator to recipient, but also is used to automatically select the MTS grade of delivery. The six levels of precedence are mapped to only three levels of grade of delivery which is conveyed in the MTS envelope. Table B.1 maps primary precedence values onto the MTS priority protocol element. Behaviour upon receipt is determined by local policy.

TABLE B.1/F.400

### Primary precedence value mapping onto the MTS Priority EOS

Primary Precedence	MTS EOS Priority
Override (5)	Urgent (2)
Flash (4)	Urgent (2)
Immediate (3)	Normal (0)
Priority (2)	Normal (0)
Routine (1)	Non-urgent (1)
Deferred (0)	Non-urgent (1)

NOTE – Elements of service specific to EDI messaging and voice messaging are defined in Recommendations F.435 and F.440.

## Annex C

### Elements of service changes from 1992

(This annex does not form an integral part of this Recommendation)

#### C.1 New elements of service in 1996

Elements of service	MT	IPM	PD	MS	Annex B reference
Auto-acknowledgement of IP-messages	X	X			B.96
Auto-action Log	X				B.97
Auto-assignment of Annotations		X			B.98
Auto-assignment of Group Names		X			B.99
Auto-assignment of Storage Period		X			B.100
Auto-correlation of IP-messages	X	X			B.101
Auto-correlation of IP-notifications	X	X			B.102
Auto-correlation of Reports		X			B.103
Auto-deletion after Storage Period		X			B.104

(concluded)

Elements of service	MT	IPM	PD	MS	Annex B reference
Auto-discarding of IP-messages	X	X			B.105
Copy precedence		X			B.123
Delivery Log	X				B.106
Distribution codes		X			B.124
Exempted address		X			B.125
Extended authorization information		X			B.126
IP-message Action Status	X	X			B.107
Message instructions		X			B.127
Message type		X			B.128
Originator reference		X			B.129
Other recipients indicator		X			B.130
Primary precedence		X			B.131
Storage of Draft Messages		X			B.108
Storage on Submission		X			B.109
Storage Period Assignment		X			B.110
Stored Message Annotation		X			B.111
Stored Message Grouping		X			B.112
Submission Log	X				B.113
Submission of IP-messages Incorporating Stored Messages	X	X			B.114

## C.2 Classification of new elements of service

The new elements of service that were added to the 1992 X.400-Series Recommendations to create the 1996 F.400/X.400-Series Recommendations are all classified as additional optional user facilities.

## Annex D

### Differences between ITU-T Recommendation F.400 and ISO/IEC International Standard 10021-1

(This annex does not form an integral part of this Recommendation)

#### D.1 Differences

This annex points out the major differences between this Recommendation and the corresponding ISO/IEC International Standard. Because the differences in many cases involve the inclusion or exclusion of a word, a phrase, or a sentence, and these occur in many places throughout the text, this annex does not specifically point to these instances. Rather it summarizes the intent of these differences.

The following are the major differences:

- 1) the ITU-T text makes references throughout to ITU-T services and their relationship to MHS;
- 2) the ITU-T text has a note about responsibility for storing deferred delivery messages (B.19) which is not included in the ISO/IEC text.

## Annex E

### Multinational PRMD

(This annex does not form an integral part of this Recommendation)

See also Annex G/Recommendation X.402 and ISO/IEC 10021-2.

Many large organizations and service providers will have the requirement for message handling management domains covering more than one country. The naming conventions of X.400-Series and F.400-Series Recommendations and the idea of global uniqueness of names have to be applied where ADMDs are involved in international messaging. While direct PRMD to PRMD messaging is mentioned in these Recommendations, it is not viewed as the choice for global applicability. Each PRMD is free to use its own conventions but may have problems entering public transfer if the standard concept of naming is not observed.

Starting from the assumption that in every country the responsible naming authorities are in place, names of PRMDs can be registered by the responsible naming authority at the country level. Furthermore, an organization may wish to use the same PRMD name with various ADMDs in a country. The PRMD name together with the ADMD name concerned and the country name establishes global uniqueness. A multinational PRMD can easily manage its structure to meet these requirements by subdividing its global domain into sub-domains, each sub-domain registering its sub-domain name separately in the country concerned. Unambiguous names in the country and a unique name globally are the result of these provisions. Relaying of messages being transferred via ADMDs through PRMDs may be restricted by ADMD practices. See Figure E.1.

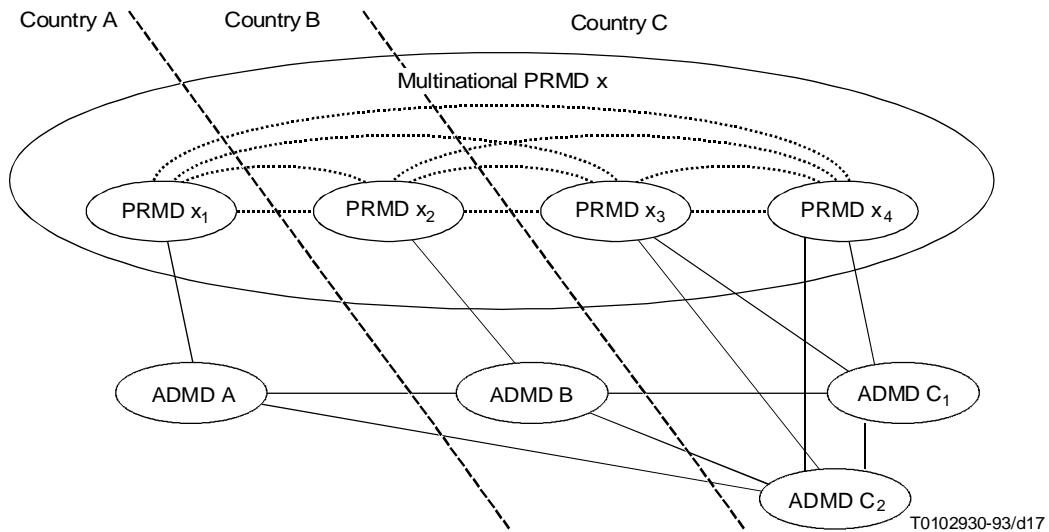

*Examples*

Country: A	Country: B	Country: C	Country: C	Country: C	Country: C
ADMD: A	ADMD: B	ADMD: C <sub>1</sub>	ADMD: C <sub>2</sub>	ADMD: C <sub>1</sub>	ADMD: C <sub>2</sub>
PRMD: x <sub>1</sub>	PRMD: x <sub>2</sub>	PRMD: x <sub>3</sub>	PRMD: x <sub>3</sub>	PRMD: x <sub>4</sub>	PRMD: x <sub>4</sub>

Name of the multinational PRMD: x  
 Sub-domain names: x<sub>1</sub>, x<sub>2</sub>, x<sub>3</sub>, x<sub>4</sub>

NOTES

- 1 Numbers used for PRMD names are for illustration only.
- 2 PRMD names can be the same in various countries if legal requirements are met.

FIGURE E.1/F.400

**Model for a multinational PRMD**

## ITU-T RECOMMENDATIONS SERIES

- Series A Organization of the work of the ITU-T
- Series B Means of expression
- Series C General telecommunication statistics
- Series D General tariff principles
- Series E Telephone network and ISDN
- Series F Non-telephone telecommunication services**
- Series G Transmission systems and media
- Series H Transmission of non-telephone signals
- Series I Integrated services digital network
- Series J Transmission of sound-programme and television signals
- Series K Protection against interference
- Series L Construction, installation and protection of cables and other elements of outside plant
- Series M Maintenance: international transmission systems, telephone circuits, telegraphy, facsimile and leased circuits
- Series N Maintenance: international sound-programme and television transmission circuits
- Series O Specifications of measuring equipment
- Series P Telephone transmission quality
- Series Q Switching and signalling
- Series R Telegraph transmission
- Series S Telegraph services terminal equipment
- Series T Terminal equipments and protocols for telematic services
- Series U Telegraph switching
- Series V Data communication over the telephone network
- Series X Data networks and open system communication**
- Series Z Programming languages