



INTERNATIONAL TELECOMMUNICATION UNION

ITU-T

TELECOMMUNICATION
STANDARDIZATION SECTOR
OF ITU

E.301

(03/93)

**TELEPHONE NETWORK AND ISDN
OPERATION, NUMBERING, ROUTING
AND MOBILE SERVICE**

**IMPACT OF NON-VOICE APPLICATIONS
ON THE TELEPHONE NETWORK**

ITU-T Recommendation E.301

(Previously "CCITT Recommendation")

FOREWORD

The ITU Telecommunication Standardization Sector (ITU-T) is a permanent organ of the International Telecommunication Union. The ITU-T is responsible for studying technical, operating and tariff questions and issuing Recommendations on them with a view to standardizing telecommunications on a worldwide basis.

The World Telecommunication Standardization Conference (WTSC), which meets every four years, established the topics for study by the ITU-T Study Groups which, in their turn, produce Recommendations on these topics.

ITU-T Recommendation E.301 was revised by the ITU-T Study Group II (1988-1993) and was approved by the WTSC (Helsinki, March 1-12, 1993).

NOTES

1 As a consequence of a reform process within the International Telecommunication Union (ITU), the CCITT ceased to exist as of 28 February 1993. In its place, the ITU Telecommunication Standardization Sector (ITU-T) was created as of 1 March 1993. Similarly, in this reform process, the CCIR and the IFRB have been replaced by the Radiocommunication Sector.

In order not to delay publication of this Recommendation, no change has been made in the text to references containing the acronyms "CCITT, CCIR or IFRB" or their associated entities such as Plenary Assembly, Secretariat, etc. Future editions of this Recommendation will contain the proper terminology related to the new ITU structure.

2 In this Recommendation, the expression "Administration" is used for conciseness to indicate both a telecommunication administration and a recognized operating agency.

© ITU 1994

All rights reserved. No part of this publication may be reproduced or utilized in any form or by any means, electronic or mechanical, including photocopying and microfilm, without permission in writing from the ITU.

CONTENTS

	<i>Page</i>
1 Introduction	1
2 Scope	1
3 Related Recommendations	2
4 Category 1 applications	2
4.1 Voice	2
4.2 Non-voice	2
4.3 Mixed	3
5 Signalling and transmission considerations for Category 1 applications	3
5.1 Signal interference	3
5.2 Transmission	3
5.3 Potential solutions	3
6 DCME for Category 1 applications	4
6.1 Speech quality considerations	4
6.2 Impact of DLC on blocking performance	5
6.3 Other considerations	5
6.4 Tandem DCME connections	6
7 Category 2 applications	6
8 Signalling, dialling and routing considerations for Category 2 applications	7
8.1 Signalling considerations	7
8.2 Dialling and numbering considerations	7
8.3 Routing considerations	8
9 Network architecture considerations	8
9.1 Overlay networks	8
9.2 Integrated networks	8
10 Recommendation history	8
Annex A – Teletraffic characteristics of non-voice traffic	8
A.1 Mean call duration	8
A.2 24-hour traffic profile	8
Annex B	11
Annex C	12
Annex D	13
Annex E	14

IMPACT OF NON-VOICE APPLICATIONS ON THE TELEPHONE NETWORK

(Modified at Helsinki, 1993)

1 Introduction

recognizing

that true Integrated Service Digital Networks (ISDNs) as described in the I-Series Recommendations, will evolve from Public Switched Telephone Networks (PSTNs);

that this evolutionary process is already well under way in that digital capabilities are being introduced in PSTNs all over the world, in place of analogue facilities;

that although the realization of true ISDNs worldwide is unlikely to occur for many years, the introduction of digital capabilities nevertheless provides the opportunity for Administrations to improve the quality of existing services and simultaneously also offer new "ISDN-like" services; and

that these same digital capabilities may also introduce network elements that may adversely impact service quality in ways not yet fully understood;

this Recommendation provides an analysis of some of the problems which may be encountered in the existing telephone network during the PSTN to ISDN transition period. Further, this Recommendation also described network control and routing procedures that can be used to provide high levels of service quality for all services until a comprehensive ISDN can be achieved.

2 Scope

From a network capabilities point of view, it is convenient to separate the various types of traffic that PSTNs may be expected to carry into the following two broad categories.

Category 1 applications are those traffic streams that can be carried over analogue networks but will henceforth be carried on digital facilities in order to realize the quality improvements inherent in digital transmission. Examples of such applications include data and facsimile with further details contained in section 4.

Category 2 applications are primarily those traffic streams that inherently require digital facilities and in addition may require further network actions to accommodate requirements peculiar to the particular traffic stream. Examples of such applications include switched digital services with fuller details given in clause 7. However, there may be cases where an Administration may choose to treat an application normally considered to be of Category 1 as a Category 2 application. For example, an Administration providing switched transit service may choose to provide special treatment to transit calls.

Within this framework, the scope of this Recommendation is as follows:

This Recommendation only deals with PSTNs which are evolving, by the introduction of digital capabilities, towards ISDNs.

Clauses 4, 5 and 6 deal with Category 1 applications. Clauses 7, 8 and 9 deal with Category 2 applications.

CSPDNs and PSPDNs, which are based on the X.121 numbering plan, and the interworking between these networks and PSTNs is outside the scope of this Recommendation.

Finally, it should be noted that this Recommendation does not consider Packet Circuit Multiplication Equipment (PCME) technology. The impact of this technology on the issues discussed here are for further study.

3 Related Recommendations

The following Recommendations cover related topics in the evolution of PSTNs towards ISDN:

- Rec. E.164 *Numbering plan for the ISDN era*;
- Rec. E.171 *International telephone routing plan*;
- Rec. E.172 *ISDN routing plan*;
- Rec. G.721 *32 kbit/s Adaptive Differential Pulse Code Modulation (ADPCM)*;
- Rec. G.726 *Adaptive pulse code modulation for 40, 32, 24, 16 kbit/s(ADPCM)*;
- Rec. G.727 *5-, 4-, 3-, 2- bits sample, embedded ADPCM*;
- Rec. G.728 *16 kbit/s low-delay CELP (LD-CELP) speech coding algorithm*;
- Rec. G.763 *Digital circuit multiplication equipment using 32 kbit/s ADPCM and digital speech interpolation*;
- Rec. G.766 *Facsimile demodulation and remodulation in DCME*;
- Rec. P.84 *Subjective listening test method for evaluating digital circuit multiplication and packetized voice systems*.

4 Category 1 applications

In this clause we consider three types of Category 1 applications classified as the following.

4.1 Voice

Voice traffic is mainly composed of speech conversation. Because of the rapid deployment of Digital Circuit Multiplication Equipment (DCME) which utilizes speech interpolation and compression to efficiently utilize digital facilities, increasing volumes of non-voice traffic can cause problems that can affect the performance of voice traffic.

4.2 Non-voice

Voice-band traffic which is not speech. Example applications for which the present telephone network is capable of providing bearer services include:

- data (analogue coded);
- facsimile;
- scrambled speech;
- phototelegraphy;
- Voice Frequency (VF) telegraphy.

VF telegraphy is not widely carried on PSTNs. Furthermore, phototelegraphy calls use telephone circuits removed from normal service, as set out in Recommendation E.320. Therefore, for calls on the PSTN, only Voice-Band Data (VBD) and facsimile services are considered below.

Between these two non-voice applications, probably the most common type is facsimile. In fact, for certain traffic streams the majority of the traffic is facsimile. At the same time facsimile traffic is growing at several times the rate of voice traffic.

Special considerations may need to be given to the suitability of the telephone network to carry these services because of their particular characteristics which differ from those of voice traffic in the following ways:

- a) the transmission of some of these services is characterized by a continuous power loading, compared to the syllabic bursts found in speech;

- b) non-voice traffic often has a 24-hour traffic profile different from voice traffic; this is especially true for international routes, where time zone differences result in the peaks of voice and non-voice traffic occurring at different times (see Annex A for some typical traffic profiles);
- c) mean call holding times are often significantly shorter than voice traffic.

4.3 Mixed

Traffic which has both voice and non-voice transmission. An example of one such service would be videotelephony.

5 Signalling and transmission considerations for Category 1 applications

The increasing presence of non-voice traffic in Category 1 applications may result in signalling and transmission problems.

5.1 Signal interference

Non-voice service signals can interfere with telephone circuit signalling systems and vice versa.

Data or facsimile signals can interfere with signalling systems which use in-band line signalling such as Signalling Systems No. 4, No. 5 and R1. Thus such non-voice calls should use the standardized systems set out in the Series-V and -T Recommendations since these are designed to prevent interference with the standard signalling systems, either by avoiding the particular signalling frequencies or by operating the guard circuit of the signalling receiver.

Despite the safeguards mentioned above, it may sometimes happen that the signalling receiver is momentarily operated by the carried service signal. In this case the splitting device in the signalling receiver will operate and cause a short discontinuity in the received service signal.

5.2 Transmission

5.2.1 Interference to transmission systems

If the proportion of non-voice calls is large, it can increase the overall power loading in a transmission assembly (group or supergroup). This can cause distortion in the group of signals and/or the operation of power limiters which can adversely affect other calls or services in the same transmission assembly.

5.2.2 Interference by transmission systems

It may be the case that ordinary speech channels do not provide an adequate transmission path for some types of non-voice service, resulting in an unacceptable error performance, or in the worst case not allowing any service at all.

For example, echo suppressors may not allow the transmission of duplex data unless the tone-disabling signal is first applied and immediately followed by the service signal.

Some types of transmission systems do not support higher speed data transmission. For example, the 32 kbit/s ADPCM algorithm in Recommendation G.726 supports VBD traffic only up to 4800 bit/s and the 40 kbit/s algorithm in G.726 supports VBD rates up to 9600 bit/s with 14 400 bit/s supported only for non-tandem connections. Also the LD-CELP algorithm in G.728 supports VBD only up to 2400 bit/s.

5.3 Potential solutions

If the transmission of non-voice services on the telephone network is found to cause problems due to the issues discussed in 5.2.1 and 5.2.2, the Administrations concerned should take the following actions:

5.3.1 It should be established for each bilateral relationship what commercial and regulatory arrangements exist which recognize the need to provide for non-voice services within prescribed Quality of Service parameters.

5.3.2 If it is decided by the Administration concerned that certain services must be supported, then two approaches can be taken:

- a) only transmission systems allowing suitable performance for non-voice services are used;
- b) separate routings are established for the whole or part of the networks, where unsuitable transmission would otherwise occur.

5.3.3 In case b) above, it is necessary to know when subscribers are initiating non-voice calls. There are two methods for achieving this:

- i) the subscriber line is known to be one originating only non-voice calls, e.g. it is a facsimile terminal;
- ii) the subscriber sends some form of service indication to the network, identifying a non-voice call request (e.g. Recommendation E.131).

If these indications are directly available at the exchange where the separate routing is selected, then path selection need only combine this indication with the dialled digits. In other cases it is necessary for a suitable signalling system to be employed to carry this indication forward to the special selection point. This may be done using signalling systems including special call categories. In particular, a call category "data call" is provided in Signalling Systems R2, No. 6 and No. 7, also No. 5 by bilateral agreement. The separate routing may be continued throughout the network using either "path of entry" indications at the exchanges concerned or the special call category signals within the signalling system (see Recommendation E.172).

6 DCME for Category 1 applications

As mentioned in 4.1, in order to economize on the provision of international voice channels, international digital transmission systems are increasingly being deployed with speech interpolation systems such as DCME. Information on speech interpolation systems can be found in Supplement 2 of Fascicle VI.1. Circuit gains are realized by speech compression and by exploiting the silent period normally existing during speech conversations. DCME equipment uses Low Rate Encoding (LRE) for non-voice signals and a combination of LRE and Variable Bit Rate Encoding (VBR) for speech signals (see Recommendation P.84, *Blue Book* for a definition of LRE and VBR). In the absence of VBD traffic, circuit gains of 4:1 are achievable. Annex B shows a functional view of a typical DCME configuration.

6.1 Speech quality considerations

Continuous non-voice service signals will cause the continuous operation of the speech detectors and give rise to permanent association of the telephone circuit to the transmission channel. This in turn increases the probability of noticeable speech clipping due to freeze-out where no channel is available. Thus the quality of speech on parallel voice calls can be affected, resulting in a need to reduce the gain advantage of the speech interpolation system.

LRE and VBR raise the possibility of further speech degradation in time of overload, in addition to the speech clipping.

This degradation can be alleviated by the use of the Dynamic Load Control (DLC) signal which causes the sending switch to block all fresh calls to the transmission facility until the condition improves. (See Recommendation G.763 for a definition of DLC.) The DLC signal can be triggered by the lowering of the Average Bits per Sample (ABS) below a specified threshold. Also, all brands of DCME have a physical limit on the number of non-voice signals that can be processed simultaneously. As this limit is approached, DLC may be invoked.

6.1.1 It should be noted that the gain realized in units can be less for DCME units with DLC than for units without DLC. However, since DLC is an effective way of preventing excessive degradation in speech Quality of Service, this capability should be provided.

6.1.2 The DLC capability should be provided at both ends of the DCME system. When a DLC signal is sent to the switch, the selection of trunk circuits associated with the specified DCME should be skipped immediately.

6.1.3 Wherever possible, Administrations should avoid the connection of one particular circuit sub-group to more than one DCME. This is necessary to avoid controlling too much traffic. If one circuit sub-group is assigned to more than one DCME, then even if only one DCME is in an overload condition, all traffic in that circuit sub-group is controlled and the blocking may therefore increase.

Also, if the selection scheme of trunk circuits with DCME is simply the ascending or descending order, traffic will be concentrated into one particular DCME. This may be a cause of speech clipping and degradation in time of overload as the ABS decreases, especially at the non-voice peak hours. Thus, as a general principle, Administrations should balance the load on all DCMEs connected to a single circuit group. The circuit selection scheme described in Figure C.1, can be considered to decrease the probability of overloading a particular DCME unit. Thus, the selection order for the circuit sub-groups is 1A-1B-2A-2B-3A-3B-4A-4B. This order may be implemented as a hunt group or, if the technology permits, on a call-by-call basis. Balanced loading is even more important if the DLC capability cannot be provided since this may be the only method available to maintain service quality.

6.2 Impact of DLC on blocking performance

In periods of high non-voice activity, there is the possibility of high blocking as a result of DLC. Annex D shows the blocking, as a function of the per cent of VBD traffic, on a group of 120 circuits, with the total load fixed at 103 Erlangs. The triplet (T, w, s) in Figure D.1 represents a combination of the maximum allowable number of VBD calls, the ABS threshold for DLC activation and the speech activity factor respectively. Two values, 37 and 57 for T are considered. The range of consideration for w is 3.3 to 3.7 and for s is 0.35 to 0.40.

6.2.1 The Administrations concerned should observe the operating condition of each DCME system and measure the ratio of non-voice traffic on each route on a regular basis. Network planning practices should consider the quantity of non-voice traffic present within the international network. The proper observation and maintenance of DCME operation can help optimize the Quality of Service provided within the international network.

6.2.2 For traffic streams containing a high degree of VBD traffic, Administrations should consider operating the DCME at lower compression ratios than with traffic streams with primarily voice traffic.

6.3 Other considerations

6.3.1 Given the high growth rate of facsimile traffic, expected compression ratios may not be achievable. This difficulty may be alleviated by the use of facsimile demodulation technology. This technology permits, for a given number of derived circuits, the accommodation of a higher percentage of facsimile traffic than would be possible otherwise. With appropriate dimensioning of the DCME, the result will be more consistent quality of speech.

6.3.2 Wherever possible, Administrations should ensure that all traffic terminated to a particular DCME can be controlled at times of overload. This is particularly important when circuit sub-groups from more than one switch are connected to a single DCME. In such cases it is necessary to control the traffic in all concerned switches to ensure that no fresh traffic is originated which could further degrade the Quality of Service.

6.3.3 As described in 4.2, on international routes the peaks of voice and non-voice traffic may occur at different times. Generally non-voice traffic such as facsimile transmission is concentrated in the closing hours of business. This difference has implications when calculating the gain of speech interpolation systems such as DCME and TASI. The gain is basically the ratio of the number of telephone circuits (those connected with the telephone switching system), to the number of bearer circuits (those connected to the transmission facilities).

The number of required telephone circuits is designed to meet the busy-hour traffic volume. The number of required bearer circuits is determined using a compression ratio agreed to on a bilateral basis and the total number of telephone circuits required.

6.3.4 It is recommended that Administrations consider the volume of voice and non-voice traffic when establishing the compression ratio. As a result, there is a possibility that the peak time of required telephone circuits and bearer circuits may appear at different hours. Therefore the number of required telephone circuits with speech interpolation systems and bearer circuits need to be dimensioned considering the 24-hour traffic profiles of both voice and non-voice.

6.3.5 Administrations should note that for DCME circuit groups (or circuit sub-groups) with DLC, high blocking may not necessarily imply lack of derived circuits. The problem could be insufficient bearer capacity. Administrations should ensure that remedial measures are directed at the appropriate network elements. Administrations are further cautioned that traditional relationships between blocking call attempts and observed traffic may not apply.

6.4 Tandem DCME connections

Tandem DCME connections occur when two links in an international connection are both equipped with DCME. DCME is used extensively in the international networks, especially on long haul routes where the circuit efficiency makes its use economically attractive. It is likely that penetration of DCME will continue to increase, and hence the likelihood of switched transit calls involving tandem connection of DCMEs will also increase. This could result in tandem encoding/decoding of voice and non-voice traffic. Although the impact on quantizing distortion units (QDU's) of such connections requires further study, present estimates are that if Recommendation G.721 coding is used, the international portion of tandem connections could result in an accumulated QDU allocation of 8, which is considered unacceptable. Non-voice applications such as facsimile are known to be adversely affected by such tandem encodings. Whether voice is similarly affected from a customer perception point of view is a matter for further study. If a tandem connection is anticipated, the Administrations concerned should take the following network control procedures to maintain an acceptable Quality of Service for both voice and non-voice traffic:

- select a circuit sub-group derived by DCME equipped with facsimile demodulation capability. Although this option does not alleviate the accumulation of QDU's, because of reduced load on the bearer, some improvement in speech quality and blocking call attempts is anticipated;
- select a circuit sub-group which is normally derived by DCME but ADPCM/DSI functions inactivated;
- select a non-DCME derived circuit sub-group.

Annex E provides further clarification of these options.

Tandem DCME connections could also result in tandem signal detection of voice and non-voice traffic. This is expected to have an adverse impact on voice traffic because signal levels vary during a conversation.

In addition, if the tandem DCME units are engineered with different signal activity detection thresholds and/or if each portion of the link is individually optimized for signal detection performance, then further degradation of speech quality in the form of clipping and signal loss can result.

Thus from a Quality of Service viewpoint, Administrations establishing routing arrangements that result in tandem DCME connections should carefully negotiate signal detection performance issues.

7 Category 2 applications

As noted in clause 1, the introduction of digital capabilities makes it possible for Administrations to offer services that cannot be carried by analogue networks. Examples of such Category 2 applications are as follows:

- end-to-end digital connectivity;
- switched digital services at 56, 64 or $n \times 64$ kbit/s;
- premium voice telephony services such as high fidelity audio;
- premium facsimile services such as a guarantee to provide the optimal facility type for facsimile calls.

It should be noted that in some cases no formal service definition exists in CCITT Recommendations, and will not be developed. This is because these services will vary from network to network since different PSTNs will have different capabilities. The introduction of such services internationally will be by bilateral agreement between Administrations.

To provide these and other Category 2 services, the PSTN, in addition to having digital transmission facilities, may need to perform additional functions so that these services are feasible. Examples of such functions are:

- i) ensuring that only compatible digital circuits must be selected, e.g. all circuits use transparent 64 kbit/s transmission;
- ii) disable or bypass all digital speech processing systems (e.g. DCME, DSI, echo control equipment, other compression systems) in the data transmission phase;
- iii) disable or bypass any μ -law to A-law converters in the data transmission phase;
- iv) disable or bypass all echo suppressors or cancellers in the data transmission phase;
- v) prevent the use of digital transmission attenuation pads;
- vi) permit the use either in-band or out-of-band network and access signalling.

As mentioned in clause 2, these functions may be used to handle some Category 1 applications also. For example, in a switched transit arrangement, the originating Administration may provide for transit calls to bypass any DCME circuit groups to the transit Administration in order to avoid the problems with tandem DCME connections discussed in 6.4.

Details for these arrangements are for further study. In order that these arrangements may be provided from the originating network to the destination network, the signalling system applied should have the capability to convey such non-voice service requests; for example, in the case of the Telephone User Part (TUP) of Signalling System No. 7, at least such an additional function must be implemented among Administrations concerned in order to convey the customer request for "unrestricted bearer capability" to the transit and destination networks. It should be also noted that terminal compatibility cannot be negotiated between the originating terminal and destination terminal within the capability of TUP. In this case, therefore, the subscriber can only communicate with the destination number which, he knows in advance, is accommodating a compatible non-voice terminal.

8 Signalling, dialling and routing considerations for Category 2 applications

This clause identifies some signalling and routing techniques which can be utilized for providing the types of services identified in clause 7.

8.1 Signalling considerations

In an ISDN, the necessary routing and control functions are provided by utilizing ISDN access (see Recommendation Q.931) and network [C7 Integrated Services User Part (ISUP)] signalling systems, and the associated call control functions in ISDN exchanges. However, some lower capability signalling systems can also be used to support "ISDN-like" service, e.g. C7 TUP – J-bit can be used to indicate 64 (or 56) kbit/s. Various other signalling systems have indicators such as Calling Party Category (CPC) which can be used in a similar way.

8.2 Dialling and numbering considerations

Within a national network, national dialling provisions may be used to access services such as "premium international telephony".

Alternatively, an E.164 number, from within the national numbering plan, could be assigned to the service and some form of two-stage dialling arrangement employed.

8.3 Routing considerations

From a routing point of view, it is necessary for a switching node to know what kind of service is requested in order to select appropriate network facilities. In an ISDN this is achieved by examining various parameters and indicators in the signalling system (see Recommendation E.172). In the absence of these indicators, other techniques can be used. For example, customers subscribing to the services described could be provided with a dedicated digital access link to a network node which supports the service. Appropriate route selection could then be made based on analysis of the path of entry and dialled numbers.

9 Network architecture considerations

The following subclauses apply to those situations where the switching nodes in the PSTN are shared by both Category 1 and 2 services.

To provide the necessary functionalities, Administrations may use two different types of network architecture.

9.1 Overlay networks

In this arrangement, network transmission facilities meeting the above requirements may be dedicated for the exclusive use of these services. The advantage of this approach is that the required facilities are already provisioned and the switching node need only match up the requested capability with already existing facilities. The disadvantage is that these facilities may not be suitable for Category 1 applications. For example, a circuit with echo cancellers or suppressors permanently disabled may not be suitable for voice. Thus, there is a loss of efficiency in this inability to share capacity.

9.2 Integrated networks

In this arrangement, all facilities are capable of handling all types of services. We now gain the efficiency of pooled resources. However, the switching node and the appropriate network elements must now set up the required bearer capabilities on a call-by-call basis. The processing overhead thus increases. The current trend is for Administrations to begin with overlay networks and migrate towards shared networks as switching technology advances in functionality.

10 Recommendation history

- First published 1988 (*Blue Book*).
- Revised 1992.

Annex A

Teletraffic characteristics of non-voice traffic (This annex forms an integral part of this Recommendation)

A.1 Mean call duration

There can be a significant difference in call duration between voice and non-voice traffic. For example, the mean call duration of non-voice traffic is three minutes in most cases, while the average call holding time for voice traffic can range between 6-9 minutes.

A.2 24-hour traffic profile

The 24-hour non-voice traffic profiles measured are in general alignment with business activities. The traffic peak appears at the end of office hours in the originating country, which is similar to the profiles of telex and record-type telecommunication services in non-attended mode of operation. The calculated profiles according to the hour(s) of time difference (i.e. $r = 0, 1, 2, \dots, 12$) are shown in Figure A.1, together with the examples of measured 24-hour profile of the mixed voice and non-voice traffic in Figure A.2. In cases where the countries have a significant time difference, the both-way traffic (sum of outgoing and incoming traffic) has two traffic peaks, corresponding to the end of the business hours in each country.

Voice communication is only possible when calling and called parties are present at both ends and therefore, generally align with the schedule of human activities. Thus, peak hours of voice and non-voice traffic may differ. In Figure A.2, countries A and B have similar peak hours for both traffic streams while country C has two peaks, one (earlier) for voice and the other for non-voice. This can contribute to flattening the traffic profile thus making more efficient use of the circuit group. It should also be noted that non-voice traffic may sharpen, the peak of the profile in case of short overlapping of business hours between two countries. This may affect the dimensioning of the network and require additional circuits to cover only a short period of time.

It is therefore important that countries measure and understand the traffic on their routes so that efficient dimensioning of the network can be undertaken.

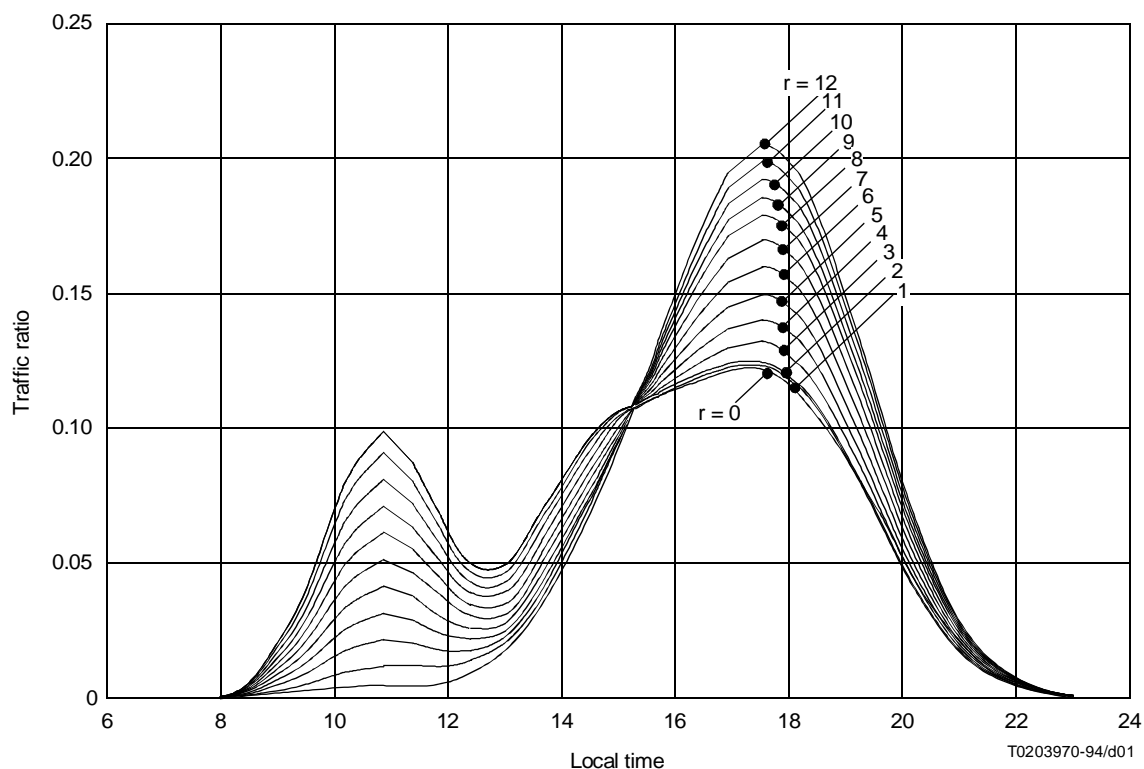
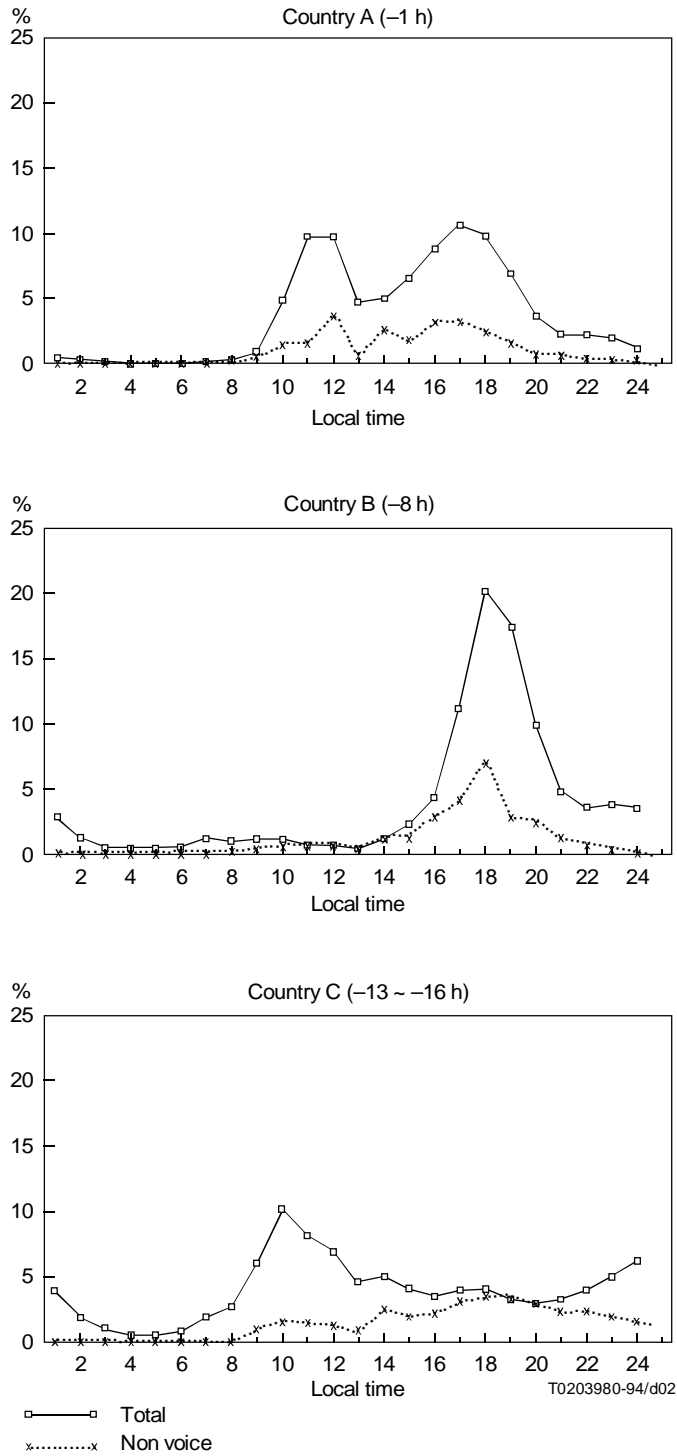

FIGURE A.1/E.301
**24-hour traffic profile for telex and record-type
 telecommunication services (calculated)**



NOTES

- 1 This figure shows outgoing traffic from the reference country.
- 2 This figure shows traffic volume expressed by concentration ratio.

FIGURE A.2/E.301

24-hour distribution of total telephone traffic and non-voice traffic contained in it (measured)

Annex B

(This annex forms an integral part of this Recommendation)

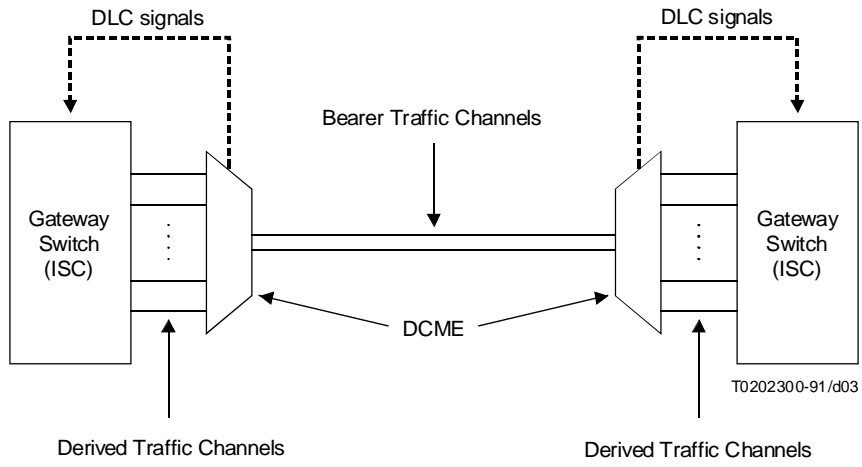

FIGURE B.1/E.301

A functional view of a typical DCME configuration

Annex C

(This annex forms an integral part of this Recommendation)

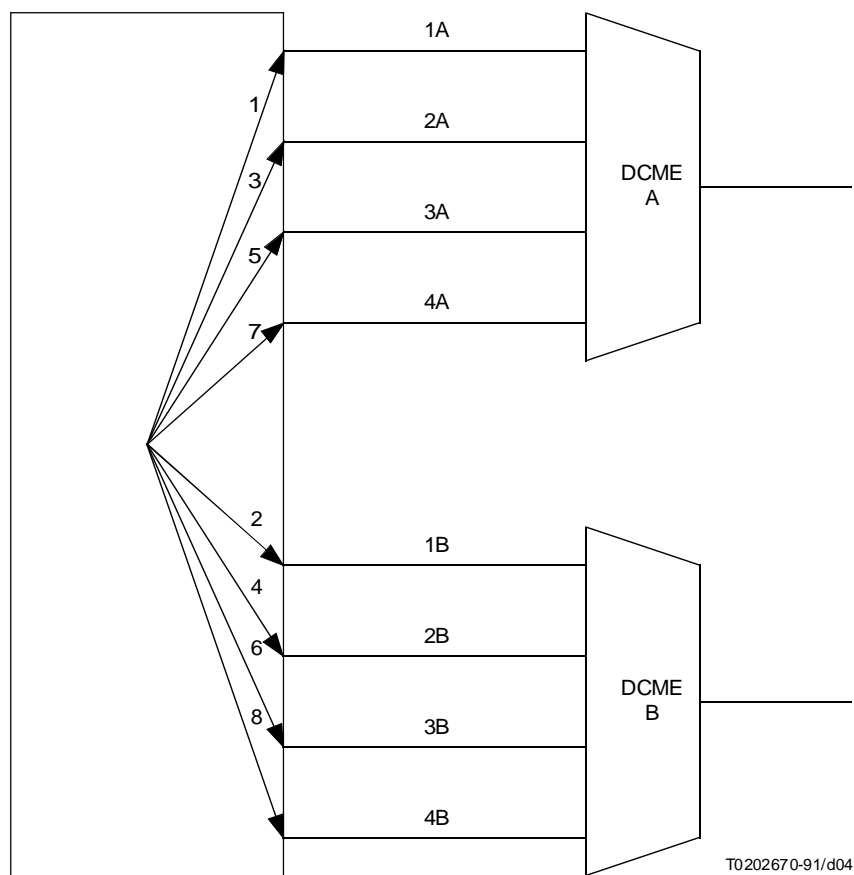

FIGURE C.1/E.301
Circuit selection scheme

Annex D

(This annex forms an integral part of this Recommendation)

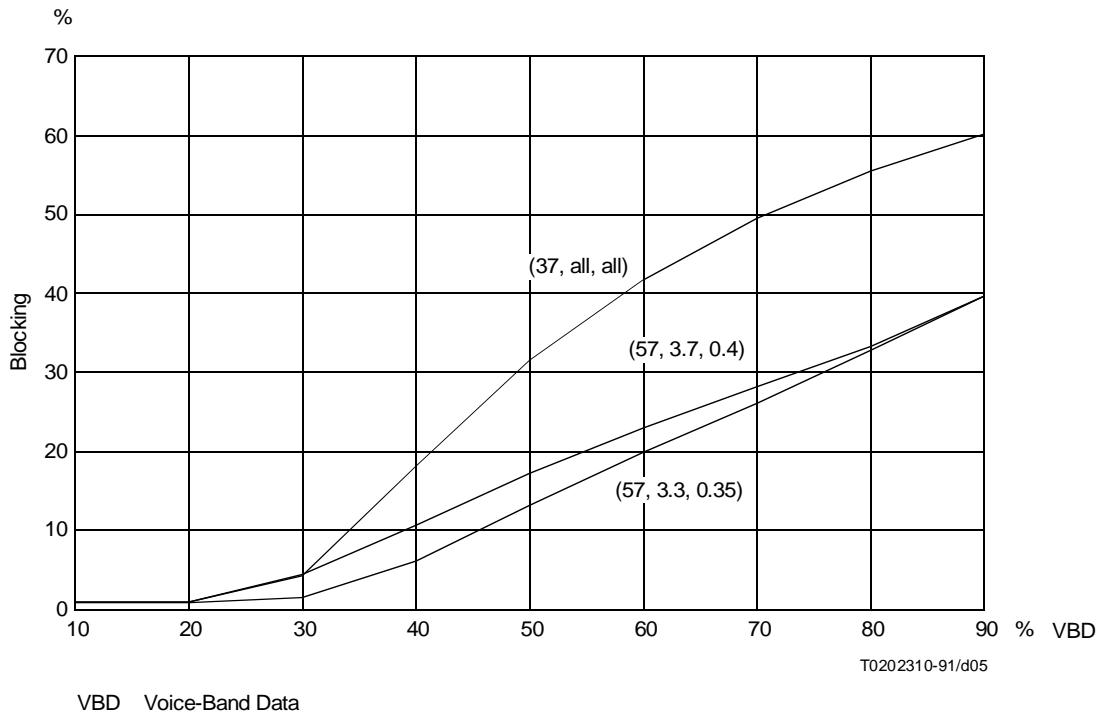

FIGURE D.1/E.301

Effect on VBD component on blocking

Trunks: 120

Total Load: 103 Erlangs

Voice Holding Time: 300 s

VBD Holding Time: 100 s

(T, w, s): Model Parameters

Annex E

(This annex forms an integral part of this Recommendation)

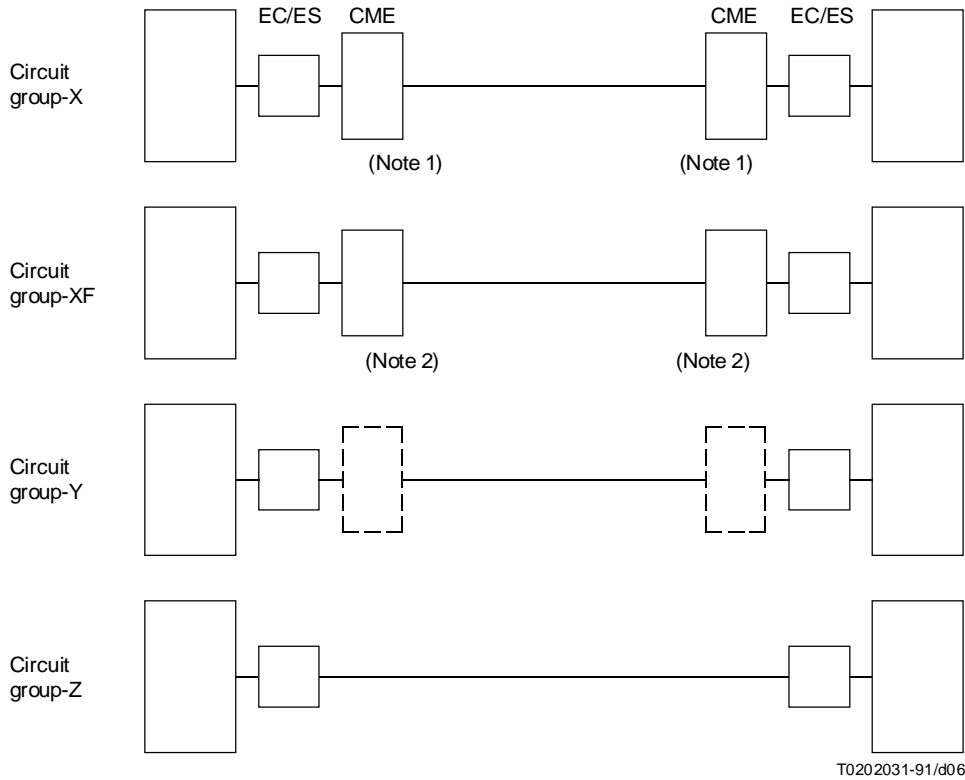

NOTES

- 1 DCME equipped with facsimile demodulation.
- 2 Changeable to 64 kbit/s clear circuit by inactivating ADPCM/DSI functions on call-by-call basis.

FIGURE E.1/E.301

Circuit groups to be provided and its combination

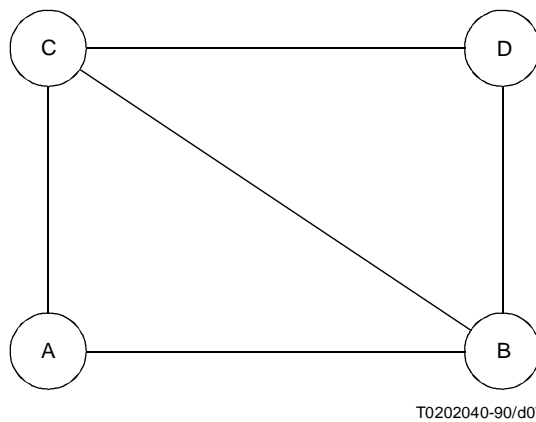

FIGURE E.2/E.301

Anticipated connections

TABLE E.1/E.301

Examples of possible circuit groups

Anticipated connection	Selected circuit group at originating ISC A	Possible circuit group at transit ISC C	Possible circuit group at transit ISC D
A-B	X, XF, Y or Z		
A-C-B	X	XF, Y or Z	
	XF	X, XF, Y or Z	
	Y		
	Z		
A-C-D-B	X	XF, Y or Z	XF, Y or Z
	XF	X	XF, Y or Z
		XF	X, XF, Y or Z
		Y	X, XF, Y or Z
		Z	X, XF, Y or Z
	Y	X	XF, Y or Z
		XF	X, XF, Y or Z
		Y	X, XF, Y or Z
		Z	X, XF, Y or Z
	Z	X	XF, Y or Z
		XF	X, XF, Y or Z
		Y	X, XF, Y or Z
		Z	X, XF, Y or Z

NOTE – Selection order of circuit groups is subject to the agreement among Administrations concerned.