



INTERNATIONAL TELECOMMUNICATION UNION

ITU-T

TELECOMMUNICATION
STANDARDIZATION SECTOR
OF ITU

E.164

(05/97)

SERIES E: OVERALL NETWORK OPERATION,
TELEPHONE SERVICE, SERVICE OPERATION AND
HUMAN FACTORS

Operation, numbering, routing and mobile services –
International operation – Numbering plan of the
international telephone service

**The international public telecommunication
numbering plan**

ITU-T Recommendation E.164

(Previously CCITT Recommendation)

ITU-T E-SERIES RECOMMENDATIONS

OVERALL NETWORK OPERATION, TELEPHONE SERVICE, SERVICE OPERATION AND HUMAN FACTORS

OPERATION, NUMBERING, ROUTING AND MOBILE SERVICES

INTERNATIONAL OPERATION	E.100–E.229
Definitions	E.100–E.103
General provisions concerning Administrations	E.104–E.119
General provisions concerning users	E.120–E.139
Operation of international telephone services	E.140–E.159
Numbering plan of the international telephone service	E.160–E.169
International routing plan	E.170–E.179
Tones in national signalling systems	E.180–E.199
Maritime mobile service and public land mobile service	E.200–E.229
OPERATIONAL PROVISIONS RELATING TO CHARGING AND ACCOUNTING IN THE INTERNATIONAL TELEPHONE SERVICE	E.230–E.299
Charging in the international telephone service	E.230–E.249
Procedures for remuneration of Administrations for facilities made available	E.250–E.259
Measuring and recording call durations for accounting purposes	E.260–E.269
Establishment and exchange of international accounts	E.270–E.299
UTILIZATION OF THE INTERNATIONAL TELEPHONE NETWORK FOR NON-TELEPHONY APPLICATIONS	E.300–E.329
General	E.300–E.319
Phototelegraphy	E.320–E.329
ISDN PROVISIONS CONCERNING USERS	E.330–E.399
<i>QUALITY OF SERVICE, NETWORK MANAGEMENT AND TRAFFIC ENGINEERING</i>	
NETWORK MANAGEMENT	E.400–E.489
TRAFFIC ENGINEERING	E.490–E.799
QUALITY OF TELECOMMUNICATION SERVICES: CONCEPTS, MODELS, OBJECTIVES AND DEPENDABILITY PLANNING	E.800–E.899

For further details, please refer to ITU-T List of Recommendations.

ITU-T RECOMMENDATION E.164

THE INTERNATIONAL PUBLIC TELECOMMUNICATION NUMBERING PLAN

Summary

This Recommendation provides the number structure and functionality for the three categories of numbers used for international public telecommunication – they are geographic areas, global services and Networks. For each of the categories, it details the components of the numbering structure and the digit analysis required to successfully route the calls. Annex A provides additional information on the structure and function of E.164 numbers. Annex B provides information on network identification, service parameters, calling/connected line identity, dialling procedures and addressing for geographic-based ISDN calls. Specific E.164-based applications which differ in usage are defined in separate Recommendations.

Source

ITU-T Recommendation E.164 was revised by ITU-T Study Group 2 (1997-2000) and was approved under the WTSC Resolution No. 1 procedure on the 26th of May 1997.

FOREWORD

ITU (International Telecommunication Union) is the United Nations Specialized Agency in the field of telecommunications. The ITU Telecommunication Standardization Sector (ITU-T) is a permanent organ of the ITU. The ITU-T is responsible for studying technical, operating and tariff questions and issuing Recommendations on them with a view to standardizing telecommunications on a worldwide basis.

The World Telecommunication Standardization Conference (WTSC), which meets every four years, establishes the topics for study by the ITU-T Study Groups which, in their turn, produce Recommendations on these topics.

The approval of Recommendations by the Members of the ITU-T is covered by the procedure laid down in WTSC Resolution No. 1.

In some areas of information technology which fall within ITU-T's purview, the necessary standards are prepared on a collaborative basis with ISO and IEC.

NOTE

In this Recommendation, the expression "Administration" is used for conciseness to indicate both a telecommunication administration and a recognized operating agency.

INTELLECTUAL PROPERTY RIGHTS

The ITU draws attention to the possibility that the practice or implementation of this Recommendation may involve the use of a claimed Intellectual Property Right. The ITU takes no position concerning the evidence, validity or applicability of claimed Intellectual Property Rights, whether asserted by ITU members or others outside of the Recommendation development process.

As of the date of approval of this Recommendation, the ITU had/had not received notice of intellectual property, protected by patents, which may be required to implement this Recommendation. However, implementors are cautioned that this may not represent the latest information and are therefore strongly urged to consult the TSB patent database.

© ITU 1997

All rights reserved. No part of this publication may be reproduced or utilized in any form or by any means, electronic or mechanical, including photocopying and microfilm, without permission in writing from the ITU.

CONTENTS

		<i>Page</i>
1	Introduction	1
2	Scope	1
3	References	1
4	Definitions	2
5	Abbreviations	5
6	International public telecommunication number structure	6
	6.1 International public telecommunication number length	6
	6.2 Structure of the international public telecommunication number	6
	6.3 Assignment of Country Codes (CCs)	7
	6.4 Assignment of Identification Codes	8
7	International public telecommunication number for geographic areas	8
	7.1 Country Code for geographic areas	8
	7.2 National (significant) number	8
	7.3 Prefixes	9
	7.4 National numbering plan	10
	7.5 Digit analysis	10
8	International public telecommunication number for global services	11
	8.1 Country Code for global services	11
	8.2 Global Subscriber Number	11
	8.3 Digit analysis	11
	8.4 Evolution path to an international public telecommunication number for global services	11
9	International public telecommunication number for Networks	12
	9.1 Country Code for Networks	12
	9.2 Identification Code	12
	9.3 Subscriber Numbers	12
	9.4 Digit analysis	12
10	Escape codes	12
11	International prefix	12
12	Recommendation history	13
Annex A – Clarification and explanation of the structure and function of E.164 numbers		13
	A.1 Scope	13
	A.2 Structure	13
	A.3 Number length	13
	A.4 Unique identification of international number for geographic areas	15
	A.5 Unique identification of international number for global services	15
	A.6 Unique identification of international number for Networks	15
	A.7 Non-E.164 numbers	15
Annex B – Application of international public telecommunication numbers for ISDN		17
	B.1 Scope	17
	B.2 ISDN numbers	17
	B.3 Addressing	17
	B.4 Dialling procedures	18
	B.5 Network identification	18
	B.6 Service parameters	19
	B.7 Calling/connected line identity	19

THE INTERNATIONAL PUBLIC TELECOMMUNICATION NUMBERING PLAN

(revised in 1997)

1 Introduction

The rapid advances in telecommunication technology coupled with increased diversification of customer demands served by a number of different types of dedicated public switched networks (telephone, telex, data, etc.) have created a need to provide a uniform customer access to the multitude of network structures (i.e. ISDN, IN, etc.). Implementation of these network architectures has begun in a number of countries and eventually these will be able to carry the full range of existing and new services.

To provide a broad base for these new arrangements, numbering has been kept compatible with that originally established for international telephone service. As covered in this Recommendation, numbering for ISDN and the international telephone service are an integral part of this international telecommunication numbering plan.

2 Scope

This Recommendation provides the number structure and functionality for the three categories of numbers used for international public telecommunication – they are geographic areas, global services, and Networks. For each of the categories, it details the components of the numbering structure and the digit analysis required to successfully route the calls. Annex A provides additional information on the structure and function of E.164 numbers. Annex B provides information on network identification, service parameters, calling/connected line identity, dialling procedures and addressing for geographic-based ISDN calls. Specific E.164-based applications which differ in usage are defined in separate Recommendations, e.g. Recommendation E.168 – Application of E.164 numbering plan for UPT.

3 References

The following ITU-T Recommendations and other references contain provisions which, through reference in this text, constitute provisions of this Recommendation. At the time of the publication, the editions indicated were valid. All Recommendations and other references are subject to revision. All users of this Recommendation are therefore encouraged to investigate the possibility of applying the most recent edition of the Recommendation and other references listed below. A list of the current valid ITU-T Recommendations is regularly published.

- CCITT Recommendation E.123 (1988), *Notation for national and international telephone numbers.*
- CCITT Recommendation E.131 (1988), *Subscriber control procedures for supplementary telephone services.*
- ITU-T Recommendation E.164.1¹, *Criteria and procedures for the assignment of E.164 country codes and associated identification codes.*
- CCITT Recommendation E.165 (1988), *Timetable for coordinated implementation of the full capability of the numbering plan for the ISDN era (Recommendation E.164).*
- ITU-T Recommendation E.165.1 (1996), *Use of escape code "0" within the E.164 numbering plan during the transition period to implementation of NPI mechanism.*

¹ Presently at the stage of draft.

- ITU-T Recommendation E.166/X.122 (1996), *Numbering plan interworking for the E.164 and X.121 numbering plans.*
- ITU-T Recommendation E.168 (1993), *Application of E.164 numbering plan for UPT.*
- ITU-T Recommendation E.169 (1996), *Application of Recommendation E.164 numbering plan for universal international freephone numbers for international freephone service.*
- ITU-T Recommendation E.190 (1997), *Principles and responsibilities for the management, assignment and reclamation of E-Series international numbering resources.*
- ITU-T Recommendation E.191 (1996), *B-ISDN numbering and addressing.*
- CCITT Recommendation E.213 (1988), *Telephone and ISDN numbering plan for land mobile stations in Public Land Mobile Networks (PLMN).*
- CCITT Recommendation E.214 (1988), *Structure for the land mobile global title for the Signalling Connection Control Part (SCCP).*
- CCITT Recommendation E.331 (1991), *Minimum user-terminal interface for a human user entering address information into an ISDN terminal.*
- CCITT Recommendation I.330 (1988), *ISDN numbering and addressing principles.*

4 Definitions

Within the integrated service environment, the terms used for all networks and services must be compatible and consistent. This Recommendation defines the following terms.

4.1 number

F: número

S: número

A string of decimal digits that uniquely indicates the public network termination point. The number contains the information necessary to route the call to this termination point.

A number can be in a format determined nationally or in an international format. The international format is known as the International Public Telecommunication Number which includes the country code and subsequent digits, but not the international prefix.

4.2 numbering plan

F: plan de numérotage

S: plan de numeración

A numbering plan specifies the format and structure of the numbers used within that plan. It typically consists of decimal digits segmented into groups in order to identify specific elements used for identification, routing and charging capabilities, e.g. within E.164 to identify countries, national destinations, and subscribers.

A numbering plan does not include prefixes, suffixes, and additional information required to complete a call.

The national² numbering plan is the national implementation of the E.164 numbering plan.

² For the purposes of this Recommendation, national is defined as a country, group of countries, global service or Network.

4.3 dialling plan

F: plan de numérotation

S: plan de marcación

A string or combination of decimal digits, symbols, and additional information that defines the method by which the numbering plan is used. A dialling plan includes the use of prefixes, suffixes, and additional information, supplemental to the numbering plan, required to complete the call.

4.4 address

F: adresse

S: dirección

A string or combination of decimal digits, symbols, and additional information which identifies the specific termination point(s) of a connection in a public network(s) or, where applicable, in interconnected private network(s).

4.5 prefix

F: préfixe

S: prefijo

A prefix is an indicator consisting of one or more digits, that allows the selection of different types of number formats, networks and/or service.

4.6 international prefix

F: préfixe international

S: prefijo internacional

A digit or combination of digits used to indicate that the number following is an International Public Telecommunication Number.

4.7 country code (CC) for geographic areas

F: indicatif de pays pour zones géographiques

S: indicativo de país para áreas geográficas

The combination of one, two or three digits identifying a specific country, countries in an integrated numbering plan, or a specific geographic area.

4.8 national (significant) number [N(S)N]

F: numéro national (significatif) [N(S)N]

S: número nacional (significativo) [N(S)N]

That portion of the number that follows the country code for geographic areas. The national (significant) number consists of the National Destination Code (NDC) followed by the Subscriber Number (SN). The function and format of the N(S)N is nationally determined.

4.9 national destination code (NDC)

F: indicatif national de destination (NDC)

S: indicativo nacional de destino (NDC)

A nationally optional code field, within the E.164 number plan, which combined with the Subscriber's Number (SN) will constitute the national (significant) number of the international public telecommunication number for geographic areas. The NDC will have a network and/or trunk code selection function.

The NDC can be a decimal digit or a combination of decimal digits (not including any prefix) identifying a numbering area within a country (or group of countries included in one integrated numbering plan or a specific geographic area) and/or network/services.

4.10 national (trunk) prefix

F: préfixe (interurbain) national

S: prefijo (interurbano) nacional

A digit or combination of digits used by a calling subscriber, making a call to a subscriber in his own country but outside his own numbering area. It provides access to the automatic outgoing trunk equipment.

4.11 trunk code (TC)

F: indicatif interurbain (TC)

S: indicativo interurbano (TC)

A digit or combination of digits, not including the national (trunk) prefix, identifying the numbering area within a country (or group of countries included in one integrated numbering plan or a specific geographic area).

The trunk code has to be used before the called subscriber's number when the calling and called subscribers are in different numbering areas. The trunk code is a particular application of NDC.

4.12 destination network (DN) code

F: indicatif de réseau de destination (DN)

S: indicativo de red de destino (DN)

An optional code field within the E.164 numbering plan which identifies the destination network serving the destination subscriber. It performs the destination network selection function of the NDC. In some instances it can be combined with a trunk code to form the NDC. The DN code can be a decimal digit or a combination of decimal digits (not including any prefix).

4.13 country code (CC) for global services

F: indicatif de pays pour les services mondiaux

S: indicativo de país para servicios mundiales

A 3-digit Country Code used to identify the global service.

4.14 global service

F: service mondial

S: servicio mundial

A service defined by the ITU-T, provisioned on the public switched network, to which the ITU-T has assigned a specific country code to enable the provision of that international service between two or more countries and/or integrated numbering plans.

4.15 global subscriber number (GSN)

F: numéro d'abonné mondial (GSN)

S: número de abonado mundial (GSN)

The number identifying a subscriber for a particular global service.

4.16 country code (CC) for Networks

F: indicatif de pays pour les Réseaux

S: indicativo de país para Redes

A shared 3-digit Country Code used in combination with an identification code to identify an international Network.

4.17 Network

F: Réseau

S: Red

Internationally interconnected physical nodes and operational systems operated and maintained by one or more ROAs to provide public telecommunications services. Private networks are not included in this definition. Note that the use of capital "N" in Networks indicates that this definition applies.

4.18 identification code (IC)

F: code d'identification (IC)

S: código de identificación (SC)

The code subsequent to a shared E.164 country code that uniquely identifies an international Network.

4.19 subscriber number (SN)

F: numéro d'abonné (SN)

S: número de abonado (SN)

The number identifying a subscriber in a network or numbering area.

4.20 escape code

F: code d'échappement

S: código de escape

One or more digits which indicate that the digits that follow are from a specific numbering plan which is different from the originating numbering plan.

An escape code can be carried forward through the originating network and can be carried across internetwork and international boundaries. Therefore the digits used for escape codes should be standardized.

5 Abbreviations

This Recommendation uses the following abbreviations.

CC	Country Code
CCITT	International Telegraph and Telephone Consultative Committee
CDLI	Called Line Identity
CLI	Calling Line Identity
COLI	Connected Line Identity
DN	Destination Network
GSN	Global Subscriber Number
IC	Identification Code
IN	Intelligent Network
ISDN	Integrated Services Digital Network
ITU	International Telecommunication Union
ITU-T	International Telecommunication Union – Telecommunication Standardization Sector
NDC	National Destination Code
NPI	Numbering Plan Identifier
N(S)N	National (Significant) Number
NT2	Network Termination 2
PSTN	Public Switched Telephone Network
ROA	Recognized Operating Agency
SA	Sub-Address
SN	Subscriber Number
TC	Trunk Code

TON	Type of Number
TSB	Telecommunication Standardization Bureau
UIFN	Universal International Freephone Number

6 International public telecommunication number structure

This clause identifies three different structures for the international public telecommunication number:

- International public telecommunication number for geographic areas.
- International public telecommunication number for global services.
- International public telecommunication number for Networks.

6.1 International public telecommunication number length

The ITU-T recommends that the maximum number of digits for the international geographic, global services, and network applications should be 15 (excluding the international prefix). Administrations are invited to do their utmost to limit the digits to be dialled to the degree possible consistent with the service needs.

6.2 Structure of the international public telecommunication number

6.2.1 The international public telecommunication number for geographic areas (Figure 1) is composed of a variable number of decimal digits arranged in specific code fields. The international public telecommunication number code fields are the Country Code (CC) and the National (Significant) Number N(S)N .

Figure 1 shows the international public telecommunication number structure for geographic areas.

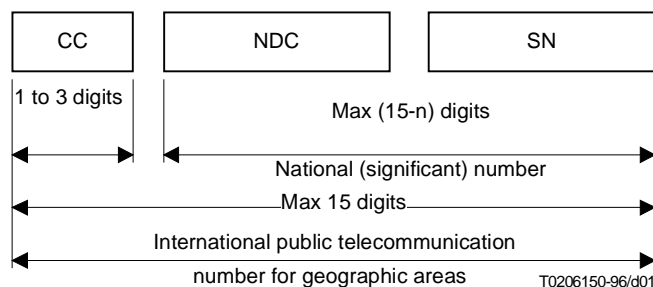

CC Country Code for geographic areas
NDC National Destination Code (optional)
SN Subscriber Number
n Number of digits in the country code

NOTE – National and international prefixes are not part of the international public telecommunication number for geographic areas.

Figure 1/E.164 – International public telecommunication number structure for geographic areas

6.2.2 The international public telecommunication number for global services (Figure 2) is composed of decimal digits that vary depending on the specific service. The international service number code fields are the 3-digit country code and the Global Subscriber Number (GSN).

Figure 2 shows the international public telecommunication number structure for global services. The use of this format is service specific and is dependent on the numbering requirements as detailed in the appropriate Recommendation, e.g. Recommendation E.169 – Application of Recommendation E.164 numbering plan for universal international freephone numbers for international freephone service.

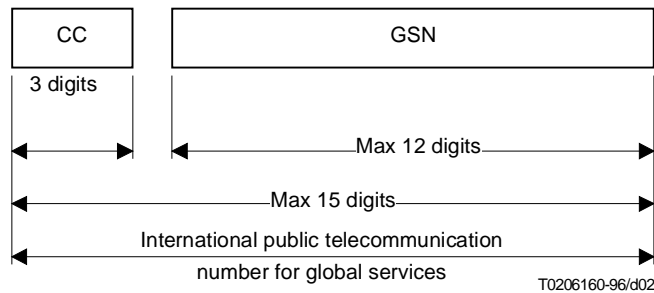

CC Country Code for Global Services
 GSN Global Subscriber Number

NOTE – National and international prefixes are not considered to be part of the international public telecommunication number for global services.

Figure 2/E.164 – International public telecommunication number structure for global services

6.2.3 The international public telecommunication number for Networks (Figure 3) is composed of decimal digits arranged in three code fields. The code fields are the 3-digit shared Country Code (CC) field, the IC field, which varies in length between 1 to 4 digits, and the Subscriber Number (SN) which can be up to 15 minus the number of digits in the CC and IC fields.

Figure 3 shows the international public telecommunication number for Networks.

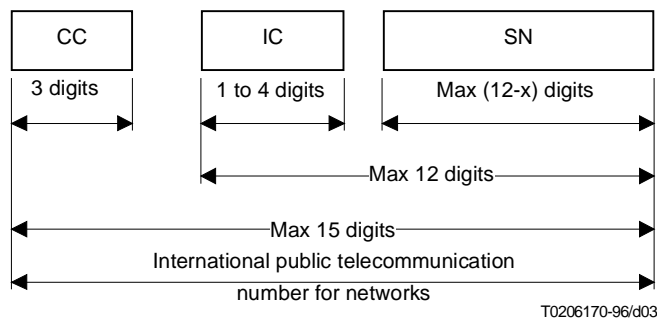

CC Country Code for Networks
 IC Identification Code
 SN Subscriber Number
 x Number of digits in Identification Code (IC)

NOTE – National and international prefixes are not part of the international public telecommunication number for Networks.

Figure 3/E.164 – International public telecommunication number structure for Networks

6.3 Assignment of Country Codes (CCs)

6.3.1 Country codes may be assigned to either geographic areas, global services or shared among Networks.

6.3.2 The status of country codes for geographic areas, global services, and Networks is published periodically by the TSB.

6.3.3 All spare country codes will be assigned on a three-digit basis.

6.3.4 The assignment and reservation of country codes shall follow the criteria and procedures as defined in Recommendation E.164.1.

6.4 Assignment of Identification Codes

6.4.1 The list of assigned and reserved identification codes with their associated country codes is published periodically by the TSB.

6.4.2 The assignment and reservation of identification codes shall follow the criteria and procedures as defined in Recommendation E.164.1.

7 International public telecommunication number for geographic areas

Principles, criteria and procedures for the assignment of international public telecommunication numbers for geographic areas may be found in Recommendations E.190 and E.164.1.

7.1 Country Code for geographic areas

The Country Code is used to select the destination country³ and varies in length from 1 to 3 digits.

7.2 National (significant) number

7.2.1 The ITU-T recommends that the maximum number of digits of the National (Significant) Number, N(S)N, should be equal to $15-n$, where n is the number of digits of the country code.

7.2.2 The N(S)N is used to select the destination subscriber. In selecting the destination subscriber, however, it may be necessary to select a destination network. To accomplish this selection, the N(S)N code field comprises a National Destination Code (NDC) followed by the Subscriber's Number (SN). The NDC and SN may be inseparably connected in some national applications to form a single composite dialling sequence.

7.2.3 The NDC field, if used, will be variable in length depending upon the requirements of the destination country. Each NDC may have one of the following structures:

- a) a Destination Network (DN) code, which can be used to select a destination network serving the destination subscribers;
- b) a Trunk Code (TC);
- c) any combination of Destination Network (DN) code and Trunk Code (TC).

The NDCs of an Administration may consist of one of the above structures or others as defined by national Administrations.

NOTE – The sequences DN-TC and TC-DN are a national matter. The various NDC options (TC/DN) are reflected in Figure 4.

7.2.4 The SN varies in length depending on the requirements of the destination country.

7.2.5 Where appropriate, identification of a specific network within the destination country shall be through the use of a NDC incorporated in the public telecommunication number.

³ Whenever the term country, destination country or originating country is used in this subclause, it identifies a specific country, a group of countries in an integrated numbering plan or a specific geographical area.

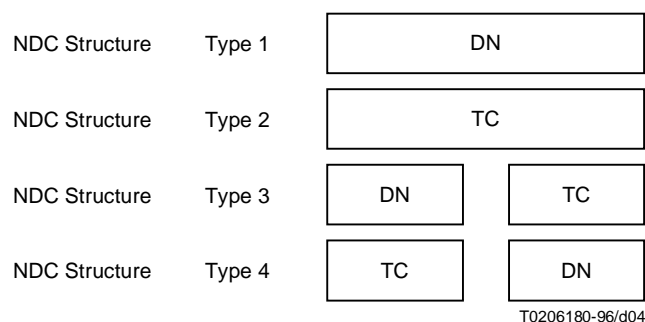

Figure 4/E.164 – Options for NDC structure

7.3 Prefixes

7.3.1 Applications

A prefix is an indicator consisting of one or more digits that allows the selection of different types of number formats, networks and/or service. Prefixes are not part of the number and are not signalled over international boundaries. It is a national matter to decide whether prefixes can be signalled between domestic networks.

Prefixes can also be used for carrier network and service selection nationally.

7.3.2 National (trunk) prefix

The national (trunk) prefix is not included in N(S)N. Accordingly, in the international service, the national (trunk) prefix of the country of destination must not be dialled.

It should be noted that, in some countries, it is customary to consider for national purposes that the national (trunk) prefix is included in the national number which is then not the N(S)N. A careful distinction must therefore be made between such national definition or practice and the ITU-T definition, which is internationally valid. In order to avoid misunderstanding, the ITU-T definition includes the word "significant" between brackets, reading as follows: "national (significant) number".

It is recommended by the ITU-T that the Administrations of countries that have not yet adopted a trunk prefix for access to their national automatic trunk network adopt a prefix composed of a single digit, preferably 0. Irrespective of what digit is adopted as a trunk prefix, this digit should be precluded from being used also as a first digit of the N(S)N.

The reasons for this recommendation are:

- to provide the maximum degree of standardization of the national (trunk) prefixes used in different countries, so that dialling is made as easy as possible for a person travelling from one country to another;
- to minimize the number of digits to be dialled;
- to reduce user problems which arise because of the requirement, in automatic international operation, that the trunk prefix of the country of destination must not be dialled.

In the automatic international service, following the international prefix and country code of the called country, the caller should dial the N(S)N of the called subscriber [i.e. without dialling the national (trunk) prefix].

The use and printing of symbols and separators in national and international telephone numbers are detailed in Recommendation E.123.

7.4 National numbering plan

7.4.1 Characteristics of national numbering plan

Each Administration should give the most careful consideration to the preparation of a national numbering plan for its own network. This plan should be designed:

- a) to allow generous provision for future growth in the number of subscribers and services to the national system;
- b) with the consideration that the national network will ultimately be accessible to subscribers in other countries by means of international dialling procedures;
- c) so that subscribers would always be called by either the same N(S)N or SN, a national matter, regardless of where the call originated from within the national numbering plan.

The numbering plan will be based on and evolve from the existing numbering plans applicable to national and international public telephone networks.

Where multiple destinations (i.e. ROAs/networks) serve the called party's geographical area, the national numbering arrangement in the country of destination shall provide for discrimination between these ROAs/networks. The procedure for discrimination between multiple transit ROAs/networks is not considered to be a destination address requirement and shall therefore be excluded from these numbering arrangements.

The ten-digit decimal character set 0-9 is used throughout the numbering plan format including subscriber number, national (significant) number and the country code.

Prefixes and other information concerned with identifying selection procedures or Network Service parameters (such as Quality of Service or transit delay) do not form part of the number.

An integrated numbering plan shall include an unambiguous identification of a particular country. In addition, the number will identify networks within these countries, if required.

7.4.2 Notification of national numbering changes

Administrators should advise the ITU-T, on a non-binding informational basis, of significant national numbering plan changes well in advance of the event, so that this information can be published by the TSB. It is recommended that this notification be submitted at least 2 years in advance to ensure formal and timely information to the widest possible distribution.

Resource administrators are encouraged to inform other resource administrators of significant national numbering plan changes well in advance of its implementation.

7.5 Digit analysis

7.5.1 In order to determine:

- the country of destination;
- the most appropriate network routing;
- the proper charging,

the originating country must analyze a number of digits of the E.164 international number. The length of the National Destination Code (NDC) increases the potential requirement for number analysis because it provides for a combination of either a Trunk Code (TC) and/or a network identification function. Careful consideration should be given to the preparation of the National Destination Code (NDC) assignments.

7.5.2 On international calls the number analysis performed at the originating country need not be more than the country code and:

- four digits of the N(S)N in the case of a country with a three-digit country code;
- five digits of the N(S)N in the case of a country with a two-digit country code;
- six digits of the N(S)N in the case of a country with a one-digit country code.

Although the potential for seven-digit analysis exists, it is not required for every call. The terminating country will inform the originating country which of the seven dialled digits of the E.164 number will indicate when seven-digit analysis is required. Some Administrations will be able to implement the charging arrangements with seven-digit analysis at the same time as the associated routing. Others may not be able to implement the charging arrangements at the same time; bilateral arrangements should be agreed with these Administrations.

7.5.3 The national numbering plan of a country should be such that digit analysis for incoming international calls need not exceed established limits applicable to the N(S)N but allows:

- a) determination of routing that reflects economic and other appropriate network factors;
- b) distinctions for charging in those countries where distinctions are applicable.

8 International public telecommunication number for global services

The numbering plan for global services is service specific. Each use of an E.164 country code for a global service needs to comply with numbering assignment principles, as specified in Recommendation E.190, as identified for the specific service, and the criteria and procedures as specified in Recommendation E.164.1. Refer to the appropriate numbering Recommendation for documentation regarding the numbering scheme and any service specific principles, e.g. Recommendation E.168 – Application of E.164 numbering plan for UPT.

The international public telecommunication number for global services is composed of the 3-digit country code applied for the global service and the Global Subscriber Number (GSN). The maximum length is 15 digits (see Figure 2).

8.1 Country Code for global services

The country code for a global service is used to identify the global service and is three digits in length.

8.2 Global Subscriber Number

The Global Subscriber Number (GSN) consists of the digits following the country code for the global service. The structure and functionality of these digits is application dependent and will be addressed in the appropriate global service numbering Recommendations, e.g. Recommendation E.169 – Application of Recommendation E.164 numbering plan for universal international freephone numbers for international freephone service.

8.3 Digit analysis

Digit analysis for global services is service specific. In order to determine the specific global service, and the call routing and charging, the digit analysis should not exceed 7 digits, e.g. 3-digit CC + 4 digits of N(S)N. Refer to the appropriate ITU-T numbering Recommendation for documentation regarding the number analysis requirements for the specific global service.

8.4 Evolution path to an international public telecommunication number for global services

The development of a numbering plan for a global service should consider the possibility for the subscribers, who already have a number for the same comparable domestic service, to evolve their domestic Subscriber Number (SN) to the Global Subscriber Number (GSN).

It is assumed that ITU-T recognized global services will be location independent.

If in the implementation of the global service there are duplicate numbering requests and there are no service specific resolution procedures, then the duplicate request procedures should be invoked as defined in Recommendation E.169 – Application of Recommendation E.164 numbering plan for universal international freephone numbers for international freephone service.

9 International public telecommunication number for Networks

Principles, criteria and procedures for the assignment of international public telecommunication numbers for international Networks may be found in Recommendations E.164.1 and E.190.

International public telecommunication numbers used by Networks consist of three parts: a shared 3-digit E.164 country code; an identification code; and a subscriber number (see Figure 3). The maximum length of international public telecommunication numbers used by Networks is fifteen (15) digits.

9.1 Country Code for Networks

These digits are the first three digits of international public telecommunication numbers for Networks. A country code for networks is a shared combination of 3 digits and is used in combination with the Identification Code to identify networks.

9.2 Identification Code

An Identification Code (IC) is a combination of 1 to 4 digits used for identification of Networks. These digits follow the shared country code field within international public telecommunication numbers for Networks.

9.3 Subscriber Numbers

Subscriber numbers are the remaining digits which follow the shared country code and the IC. The structure and functionality is determined by the network operator. The maximum length of the subscriber number is 15 minus, the total of the CC and IC digits.

9.4 Digit analysis

For calls utilizing the international public telecommunication number for Networks, the maximum number of digits to be analyzed is seven, which includes the three digits of the E.164 country code, the identification code, and the initial significant digits (if any) of the subscriber number. A minimum of the 3-digit country code and IC must always be analyzed to determine the appropriate routing and charging.

10 Escape codes

The use of escape codes shall be in accordance with Recommendation E.166, which describes the use of digit "0" (zero) as an escape code for numbering plan interworking between E.164 and X.121 numbering plans until 31/12/2000 at 2359 UTC.

11 International prefix

It is recommended by the ITU-T that the Administrations of countries that have not yet introduced automatic international operation, or Administrations and international network operators that are, for various reasons, defining or revising their numbering plans, adopt an international prefix (a code for access to the international automatic network) composed of the two digits 00⁴.

In accordance with Recommendation E.123, the symbol "+" is recommended to indicate that an international prefix is required.

⁴ Where there is a requirement for further discrimination between international network operators and/or the different network services they provide, the method for accommodating this need is a national matter.

12 Recommendation history

Recommendation E.163, first issue 1964 – revised at all subsequent Plenary Assemblies.

Recommendation E.163 – merged with Recommendation E.164 (see below).

Recommendation E.164, first issue 1984.

Recommendation E.164, second issue 1988.

Recommendation E.164, third issue 1991 – merged with Recommendation E.163.

Recommendation E.164, fourth issue 1997 – incorporates Recommendations E.160 and E.162.

Annex A

Clarification and explanation of the structure and function of E.164 numbers

A.1 Scope

A.1.1 E.164 numbering is the basis for global addressing in fixed and mobile terminal networks. These numbering resources uniquely identify user-network interfaces, e.g. PSTN/ISDN, mobile terminals, and individuals utilizing specific global services, e.g. Universal International Freephone Numbers (UIFNs). Most of the services/subscribers can be addressed directly, but in cases where indirect addressing is used number translation is required, e.g. for UIFNs.

A.1.2 This Annex provides clarification and explanation to the structure and functionality of E.164 numbers. These structures/functions are independent of the technical arrangement to record, charge or route the calls.

A.2 Structure

A.2.1 The international number, which is the foundation of the hierarchy, consists of the country code plus the necessary additional elements (NDC + SN, GSN or IC + SN). The international public telecommunication number exists only at the international level, i.e. the CC and GSN are combined to form a single dialling sequence.

A.2.2 In countries where NDC and SN are combined to form a single dialling sequence or where the NDC does not exist, the local and national levels are integrated and there is no difference between the subscriber number and the national (significant) number.

A.2.3 E.164 numbers have hierarchical structures as shown in Figure A.1.

A.2.4 When in the local level, typically the use of a national (trunk) prefix provides access to the national level, and the use of an international prefix provides access to the international level.

A.2.5 Numbers that only exist in the local, intraNetwork and/or national level are not considered E.164 numbers.

A.3 Number length

A.3.1 International number for geographic areas

A.3.1.1 International numbers for geographic areas have a maximum length of 15 digits.

A.3.1.2 The maximum length of national (significant) numbers is 15 digits minus the length of the country code.

A.3.1.3 The maximum length of subscriber numbers is 15 digits minus the length of the country code and the national destination code.

International number for geographic areas

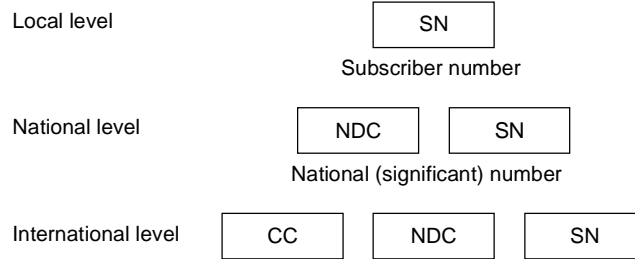

International number for global services

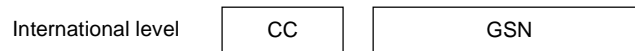

International number for networks

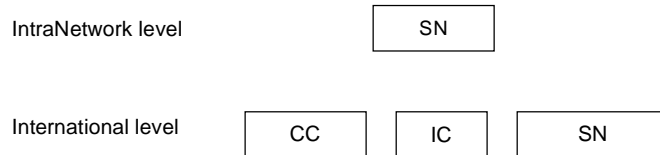

T0206190-96/d05

- NDC National Destination Code
- CC Country Code
- IC Identification Code
- SN Subscriber Number
- GSN Global Subscriber Number

NOTE – IntraNetwork level is used when calling and called parties are within the same network.

Figure A.1/E.164 – Hierarchical structures of E.164 numbers

A.3.2 International number for global services

The maximum length of a global subscriber number is 12 digits since the country code assigned to global services is always 3 digits in length.

A.3.3 International number for Networks

The maximum length of the combined identification code and subscriber number is 12 digits since the country code for networks is always 3 digits in length.

A.3.4 Summary of number length

Table A.1 summarizes the maximum number length on each level for the three categories of international numbers.

Table A.1/E.164 – Maximum number length

Level	Geographic areas	Global services	Networks
Local	15 minus (number of digits in CC + NDC)	NA	NA
National	15 minus (number of digits in CC)	NA	NA
IntraNetwork	NA	NA	15 minus (number of digits in CC + IC)
International	15	15	15
NA Not Applicable			

A.4 Unique identification of international number for geographic areas

A.4.1 An international number for geographic areas uniquely identifies a subscriber within a geographical area locally, nationally and internationally, i.e. dialling the subscriber number locally, the national (significant) number nationally and the international number internationally always provides identification of the same subscriber.

A.4.2 The national (significant) number provides unique identification of one subscriber irrespective of where the call is generated from within the country or geographical area characterized by CC.

A.4.3 The subscriber number provides unique identification of one subscriber irrespective of where the call is generated from within a local area identified by NDC, where applicable. The subscriber number is a complete number and can therefore not be separated.

A.4.4 Use of prefixes to distinguish the national (significant) number and the international number from the subscriber number does not alter the uniqueness of E.164 numbers.

A.5 Unique identification of international number for global services

The international number for global services uniquely identifies subscribers only at the international level. The international number for global services is a complete number, and can therefore not be separated.

A.6 Unique identification of international number for Networks

For illustrative purposes only, it is assumed that intraNetwork dialling is by subscriber number.

A.6.1 An international number for Networks uniquely identifies a subscriber within a Network, and internationally, i.e. dialling the subscriber number and the international number, always provides identification of the same subscriber.

A.6.2 The subscriber number provides unique identification of one subscriber irrespective of where the call is generated from within the Network identified by CC + IC. The subscriber number is a complete number and can therefore not be separated.

A.6.3 Use of an international prefix to distinguish the subscriber number and the international number for Networks does not alter the uniqueness of E.164 numbers.

A.7 Non-E.164 numbers

A.7.1 Any international number for geographical areas, global services or Networks which does not conform to the structure, length and uniqueness as defined in this Annex or in the main body of this Recommendation is not an E.164 number.

A.7.2 Non-E.164 numbers may not be passed across any Network boundaries without a specific bilateral agreement.

A.7.3 Listed below are some examples of non-E.164 numbers from the first category of numbers. These examples are not exhaustive.

A.7.3.1 Local special numbers

For example Local Special Numbers (LSPNs) with significantly fewer digits than subscriber numbers, and which are valid for a specific purpose only, within a limited part of the same NDC area.

The LSPNs are part of a hierarchical structure with three levels as follows:

- Local level: LSPN.
- IntraNetwork level: NDC + LSPN.
- International level: CC + NDC + LSPN.

Since LSPNs are significantly shorter than the subscriber numbers, they are within the limits of Table A.1.

If LSPNs and NDC + LSPN terminate at the same service then LSPN would be an E.164 number, but this is not the case in this example. In our example the LSPN terminates at, for instance, two different services within the NDC area, depending upon from where the calling user is located. LSPN and NDC + LSPN are ambiguous and therefore not E.164 numbers.

A.7.3.2 International special numbers used nationally

In this example, the International Special Numbers (ISPNs) are numbers with significantly fewer digits than ordinary subscriber numbers, and which only exist in an international format within the country which provides it. The digits of ISPN are identical to the leading digits of one or more subscriber numbers.

Nationally, the ISPNs exist only at the international level as follows:

- International level: CC + NDC + ISPN.

Since ISPNs are significantly shorter than the subscriber numbers, they are within the limits of Table A.1.

Nationally the CC + NDC + ISPN could terminate at a service center. As the digits of ISPN are identical to the leading digits of a subscriber number, all incoming international calls to the service center will fail because the CC + NDC + ISPN and the leading digits of CC + NDC + SN are ambiguous, and therefore not E.164 numbers.

A.7.3.3 Network specific numbers

In this example network specific numbers are numbers that belong to subscribers connected to one network operator in a country with more than one operator, but where the network operator demands that the calling user dials some additional digits.

The network specific numbers have a hierarchical structure with 3 levels as follows:

- Local level: SN.
- National level: NDC + SN.
- International level: CC + AD + NDC + SN (see Note.)

NOTE – ADs (Additional Digits) are the network operator identification digits that would have to be added by the calling users abroad to remove ambiguity and reach a particular subscriber in specific national network.

The international number does not fit in the hierarchical structure because it consists of more than the country code plus the national (significant) number. AD is not part of the national (significant) number, but may be part of a national prefix used to distinguish the national (significant) numbers from the subscriber numbers.

The numbers are not unique because NDC + SN and CC + NDC + SN lead to two different subscribers.

Network-specific numbers that are manipulated in this way are not E.164 numbers.

A.7.3.4 National (significant) numbers with excessive length

In this example, the national (significant) numbers (NDC + SN) as used nationally have differing lengths, and the longest national (significant) numbers violate the maximum given in Table A.1.

The numbers have a hierarchical structure as follows. The structure is independent of the number length.

- Local level: SN.
- National level: NDC + SN.
- International level: CC + NDC + SN.

Some of the national (significant) numbers (NDC + SN) and international numbers (CC + NDC + SN) are longer than the maximum given in Table A.1. These numbers are not E.164 numbers. The most significant part of the national (significant) numbers, truncated to the limits given in Table A.1, are E.164 numbers provided that they are unique.

Annex B

Application of international public telecommunication numbers for ISDN

B.1 Scope

This Annex describes the application of international public telecommunication numbers to ISDN numbering and addressing. Additional numbering and addressing requirements are covered in separate Recommendations, e.g. B-ISDN is contained in Recommendation E.191.

B.2 ISDN numbers

Numbering for ISDN is an integral part of the international public telecommunication numbering plan.

The ISDN number is an application of international public telecommunication numbering for geographic areas and for international networks, to the ISDN user-network interface/network termination.

B.3 Addressing

B.3.1 Identification

Identification within a subscriber's installation of a point beyond the ISDN boundary requires the transfer of address information from the public network to the subscriber's equipment. Two cases can apply:

- identification by an ISDN number;
- identification by an ISDN number plus additional address information.

B.3.2 Addressing by an ISDN number

When selecting a destination in the subscriber installation, digits forming the end of the ISDN subscriber number are transferred to the called subscriber's installation as a partial number (see Figure B.1). The number of digits used depends upon the requirements of the called subscriber's equipment and the capacity of the numbering plan used.

In instances where a partial number is utilized, e.g. Network Termination 2 (NT2), the number will be used in the context of the direct-dialling-in supplementary service.

If the subscriber's installation consists of terminal equipment only, the transferred digits will be used in the context of the multiple-subscriber-number supplementary service.

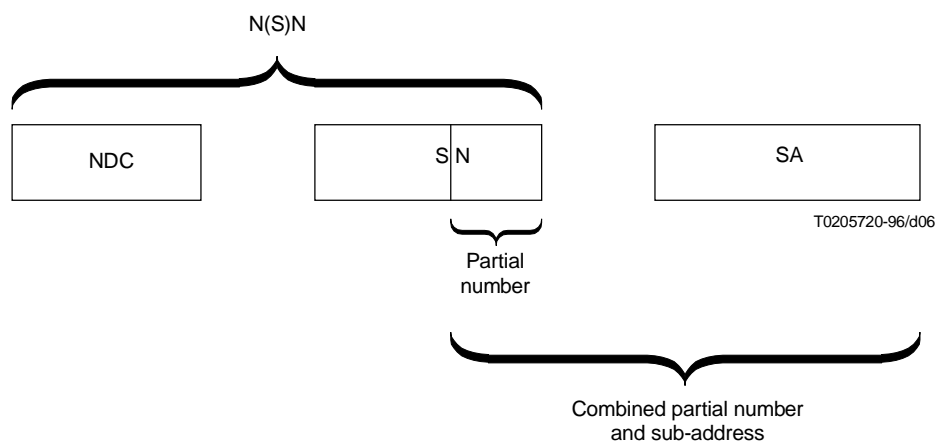

NDC National Destination Code (optional)
 N(S)N National (Significant) Number
 SA Sub-Address
 SN Subscriber Number

NOTE – The multiple-subscriber-number application is not covered in the diagram.

Figure B.1/E.164

B.3.3 Sub-addressing (network address extension)

Sub-addressing provides an additional addressing capacity outside the ISDN numbering plan but constitutes an intrinsic part of the ISDN addressing capabilities. The sub-address is a sequence of digits, following the ISDN number. The maximum length should be 20 octets (40 digits). As shown in Figure B.1, the sub-address may follow the ISDN number and form the ISDN address, which is transferred to the equipment at the subscriber's premises.

When required, the sub-address is sent by the calling party within the call set-up procedure and is passed transparently through the network as a separate entity from both the ISDN number and user-to-user information. Sub-address information is not required to be processed within the public network.

B.3.4 Combination of addressing and sub-addressing

Sub-addressing may be used separately or in combination with a partial number (see Figure B.1).

B.4 Dialling procedures

B.4.1 The subscriber dialling procedures for local, national and international calls shall be in accordance with clause 7. However, subscriber's control procedures for supplementary services will be as defined in Recommendation E.131 or in separate Recommendations for each service.

B.4.2 ISDN subscribers will always be called by the same subscriber number irrespective of where in the public network the call originates. For calls in the same numbering area or local network, the subscriber number alone is dialled. For national calls between numbering areas or local networks, the subscriber number may be preceded by the national prefix and the national destination code.

B.4.3 The addressing procedures for calls using sub-addressing are described in B.3.

B.5 Network identification

B.5.1 Geographic areas

In countries served by more than one ISDN and/or Public Switched Telephone Network (PSTN), the network identification of each is a national matter.

Network identification within the national (significant) number shall be such that:

- in a country all destination ISDN and PSTN networks shall operate under a single country code;
- the international number maximum length of 15 digits shall not be exceeded, nor shall it be necessary for the number of digits for number analysis to exceed that specified in 7.5;
- provision of network identification is not mandatory for countries using a single integrated numbering plan arrangement for their ISDNs and PSTNs.

B.5.2 Networks

In all cases when Network codes are assigned, they are supplemented with Identification Codes (ICs) which uniquely identify each international Network.

Digit analysis of the CC + IC provides the required network identification.

B.6 Service parameters

The ISDN number by itself will not identify the particular nature of the service, which is derived from particular signalling parameters that are not part of the numbering plan. For example, for ISDN calls, in addition to a number and possible prefix, there is a requirement to provide a choice of bearer capability in the signalling protocol. One number can therefore facilitate access to more than one service.

B.7 Calling/connected line identity

Calling/Connected Line Identity (CLI/COLI) is address information which is passed across the network to provide supplementary services such as calling (or connected) line identification presentation. The format of the CLI and COLI for international calls should be the full international number, i.e. Country Code (CC), National Destination Code (NDC) and Subscriber Number (SN). No other information, such as prefixes or symbols (e.g. "+"), should be included, although a sub-address may be associated with the CLI/COLI. However, in a country where network-specific numbers are utilized for identifying customers or network services it remains a national matter. When implemented, the NPI (Numbering Plan Identifier) TON (Type of Number) mechanism should define the numbering status of the calling/connected line. The authorization to pass CLI/COLI across an international boundary is a national matter.

ITU-T RECOMMENDATIONS SERIES

Series A	Organization of the work of the ITU-T
Series B	Means of expression: definitions, symbols, classification
Series C	General telecommunication statistics
Series D	General tariff principles
Series E	Overall network operation, telephone service, service operation and human factors
Series F	Non-telephone telecommunication services
Series G	Transmission systems and media, digital systems and networks
Series H	Audiovisual and multimedia systems
Series I	Integrated services digital network
Series J	Transmission of television, sound programme and other multimedia signals
Series K	Protection against interference
Series L	Construction, installation and protection of cables and other elements of outside plant
Series M	TMN and network maintenance: international transmission systems, telephone circuits, telegraphy, facsimile and leased circuits
Series N	Maintenance: international sound programme and television transmission circuits
Series O	Specifications of measuring equipment
Series P	Telephone transmission quality, telephone installations, local line networks
Series Q	Switching and signalling
Series R	Telegraph transmission
Series S	Telegraph services terminal equipment
Series T	Terminals for telematic services
Series U	Telegraph switching
Series V	Data communication over the telephone network
Series X	Data networks and open system communication
Series Z	Programming languages