



INTERNATIONAL TELECOMMUNICATION UNION

**ITU-T**

TELECOMMUNICATION  
STANDARDIZATION SECTOR  
OF ITU

**E.121**

(07/96)

**SERIES E: TELEPHONE NETWORK AND ISDN  
OPERATION, NUMBERING, ROUTING AND MOBILE  
SERVICE – INTERNATIONAL OPERATION –  
GENERAL PROVISIONS CONCERNING USERS**

---

**PICTOGRAMS, SYMBOLS AND ICONS  
TO ASSIST USERS OF THE TELEPHONE  
SERVICE**

**ITU-T Recommendation E.121**

(Previously "CCITT Recommendation")

---

## FOREWORD

The ITU-T (Telecommunication Standardization Sector) is a permanent organ of the International Telecommunication Union (ITU). The ITU-T is responsible for studying technical, operating and tariff questions and issuing Recommendations on them with a view to standardizing telecommunications on a worldwide basis.

The World Telecommunication Standardization Conference (WTSC), which meets every four years, establishes the topics for study by the ITU-T Study Groups which, in their turn, produce Recommendations on these topics.

The approval of Recommendations by the Members of the ITU-T is covered by the procedure laid down in WTSC Resolution No. 1 (Helsinki, March 1-12, 1993).

ITU-T Recommendation E.121 was revised by ITU-T Study Group 1 (1993-1996) and was approved under the WTSC Resolution No. 1 procedure on the 19th of July 1996.

---

### NOTE

In this Recommendation, the expression "Administration" is used for conciseness to indicate both a telecommunication administration and a recognized operating agency.

© ITU 1996

All rights reserved. No part of this publication may be reproduced or utilized in any form or by any means, electronic or mechanical, including photocopying and microfilm, without permission in writing from the ITU.

## CONTENTS

	<i>Page</i>
1 Scope .....	1
2 References .....	1
3 Definitions .....	1
4 Abbreviations .....	2
5 Elements of symbols and pictograms .....	2
5.1 Use of elements.....	2
5.2 Guidelines for design .....	2
6 Graphical representation of tones.....	3
6.1 Temporal structure.....	3
6.2 Pitch variation in a tone .....	3
6.3 Tone quality .....	4
6.4 Loudness variation in the tone .....	4
7 Pictograms to aid location of service .....	4
7.1 Symbol for telephone.....	4
7.2 Symbol for information .....	5
7.3 Symbol for facsimile.....	5
7.4 Symbol of access for the physically handicapped .....	6
7.5 Symbol for special facilities for the hard of hearing.....	6
7.6 Symbol for special facilities for the deaf .....	7
8 Pictograms to aid identification of information.....	7
9 Pictograms to aid in the use of a public service .....	8
10 Pictogram to aid identification of telephone subscriber services and telephone functions .....	9
11 Pictograms to aid identification of videotelephony functions .....	12
12 Guidelines for testing .....	21
References .....	21

## **SUMMARY**

The purpose of this Recommendation is to identify pictograms, symbols and icons that could be used to aid users in the identification of services available and then in the use of such services. The revisions to this Recommendation include new symbols and pictograms, developed in close collaboration with the International Electrotechnical Commission (IEC).

## PICTOGRAMS, SYMBOLS AND ICONS TO ASSIST USERS OF THE TELEPHONE SERVICE

(revised in 1995 and in 1996)

### 1 Scope

The purpose of this Recommendation is to identify pictograms, symbols and icons that could be used to aid users in the identification of services available and then in the use of such services.

### 2 References

The following Recommendations and other references contain provisions which, through reference in this text, constitute provisions of this Recommendation. At the time of publication, the editions indicated were valid. All Recommendations and other references are subject to revision: all users of this Recommendation are therefore encouraged to investigate the possibility of applying the most recent edition of the Recommendations and other references listed below. A list of the currently valid ITU-T Recommendations is regularly published.

- CCITT Recommendation E.181 (1988), *Customer recognition of foreign tones.*
- CCITT Recommendation E.122 (1988), *Measures to reduce customer difficulties in the international telephone service.*
- ITU-T Recommendation F.910 (1995), *Procedures for designing, evaluating and selecting symbols, pictograms and icons.*

### 3 Definitions

For the purposes of this Recommendation, the following definitions apply:

**3.1 symbols, pictograms and icons:** are graphical representations that convey information with a minimum of reliance on language.

**Pictograms** are typically said to be simplified pictorial representations, used to guide people and tell them how to achieve a certain goal. Pictograms are, as far as possible, self-explanatory, and require little or no learning on the part of users.

**Symbols**, on the other hand, are usually defined as abstract representations that stand for something but that require learning on the part of users to take on their meaning.

Symbols and pictograms can be considered to lie at opposite ends of a continuum defined by the degree to which they are pictorial representations of the things they represent. As a practical matter, many of the symbols and pictograms in use today, including many of those found in this Recommendation, lie some distance from either end of that continuum. That is, they may contain some degree of abstraction combined with a degree of pictorial representation.

**Icons** are similar representations that have become widely used as objects of manipulation in graphical user interfaces for computer applications. They may be entirely abstract, like symbols, or pictorial, like pictograms, or fall at some point between those extremes. The use of this term is growing beyond its origin in computer user interfaces.

In this Recommendation, the terms «symbol», «pictogram» and «icon» will be used as far as possible in the spirit of the definitions given above. However, it must be realized that the choice of one term or the other is to some considerable degree arbitrary in many cases. No effort has been made here to adhere strictly to clearly delineated distinctions between these terms, as distinctions have proved impossible to draw reliably.

## 4 Abbreviations

For the purposes of this Recommendation, the following abbreviations are used:

IEC	International Electrotechnical Commission
ROA	Recognized Operating Agency

## 5 Elements of symbols and pictograms

### 5.1 Use of elements

Symbols and pictograms can be made up of other symbols and pictograms, known as elements.

The following elements are examples of those used in the standardized pictograms and symbols:

- a telephone handset

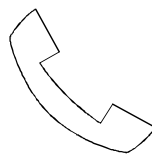

- a loudspeaker

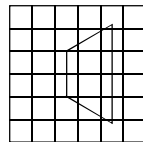

- letters



Information

- a volume control

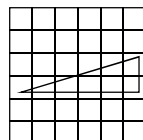

Variability (417-IEC-5004)

T0104340-95/d01

The elements used in graphically representing tones are described in clause 6. The elements used in the supplementary services symbols are listed in clause 10.

### 5.2 Guidelines for design

The idea for a pictorial design for a particular device, function or service should, whenever possible, be based on the user's mental picture of that device, function or service.

Realistic pictograms are more self-explanatory and require less learning than abstract symbols. Hence, whenever possible, the designer should aim at realistic representation. If a pictogram or symbol exists in a context other than telecommunications and is understood by customers, then, where applicable, it should be used. This has two benefits. The first benefit is that users can transfer the knowledge that they already have to the telecommunications environment, and so complete their goal quicker and easier. The second benefit is to limit the introduction of new pictograms or symbols. This will minimize the mental load that a customer may encounter when trying to remember the meaning of a pictogram or symbol. It will also reduce the confusion that a user might have between different pictograms or symbols performing the same function in different contexts and similar pictograms or symbols performing different functions in different contexts.

To achieve fast visual recognition, pictograms and symbols should be as simple as possible and they should be easily distinguishable from other currently used pictograms and symbols.

The design of a consistent set of pictograms or symbols should be guided by a few unambiguous rules about the meaning of pictorial elements within a particular application and the relationship between these elements (see, for example, clause 10). The set should not be larger than strictly necessary; a maximum of three different elements is recommended.

The design of pictograms and symbols should meet the technical requirements of their application. If they are to be displayed on the individual keys of a keyboard or on a VDU screen, their design should allow this without essential modification. In both these cases they should be easily recognizable from a distance of 50 cm.

The styling, size, colour and position of each recommended pictogram or symbol is left to the discretion of the Administration, service provider or ROA. Each pictogram or symbol should, however, bear a close perceptual similarity to those shown in this Recommendation.

## 6 Graphical representation of tones

Graphical representations of tones are useful for printed instructions given to customers. They can be used to help customers understand the relationship between a tone and its meaning, starting from either the tone or the meaning. For example, the graphical representation of call progress tones might help customers recognize the unfamiliar ringing tone when calling another country. They can also be used as a reference to identify the meaning of unexpected and unfamiliar tones. Thus, they might help answer questions of the form:

What does the ringing tone sound like in (country X)?

or

What does the rapid «pipping» tone mean?

The following subclauses describe how best to represent various aspects of tones graphically. Whenever graphical representations of tones are used:

- Intermittent tones should normally be represented by at least two full cycles.
- The same time-scale should be used in the representation of all tones in the same figure.

### 6.1 Temporal structure

This factor should be represented by appropriate blank intervals along a horizontal time axis.

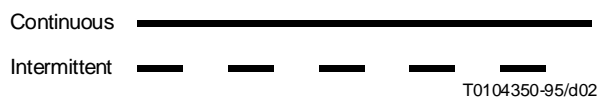

### 6.2 Pitch variation in a tone

This factor should be represented by the vertical displacement of a linear element above the time axis.

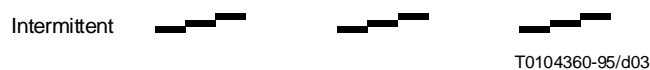

### 6.3 Tone quality

Pure tones (sinusoidal waves) should be represented by linear elements on a horizontal axis.

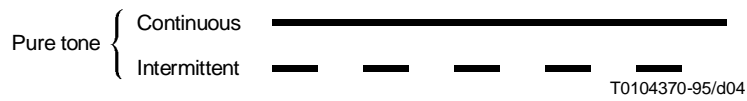

If non-pure tones consist of two frequencies, the optimal representation depends on the frequency difference between the tones. This frequency difference may be greater than the critical bandwidth (consonant tone-pairs) or smaller (dissonant tone-pairs) [2]; for consonant tone-pairs, the optimal representation is two parallel linear elements; for dissonant tone-pairs, a wavy line is optimal.

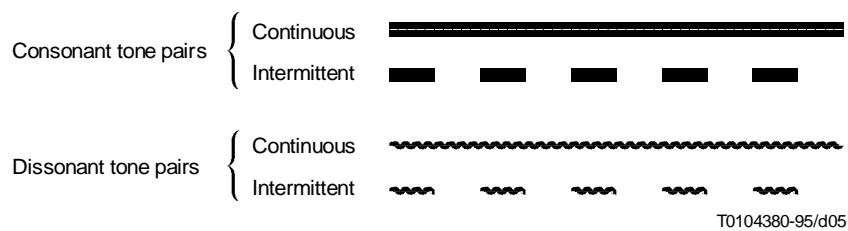

If the frequency difference between the two tones is near the critical bandwidth, neither of the representations may be satisfactory.

### 6.4 Loudness variation in the tone

This factor should be represented by variation in the thickness of a linear element.



## 7 Pictograms to aid location of service

### 7.1 Symbol for telephone

A symbol for telephone may be used:

- in place of the word telephone;
- as an adjunct to a telephone number;
- to indicate a place where telephone calls can be made;
- to refer to the telephone service in general.

When such a symbol is used, it should be a representation of a telephone handset. The symbol given here (see Figure 1) is similar to the one cited in [1] and those commonly found on road traffic signs and in railway stations.



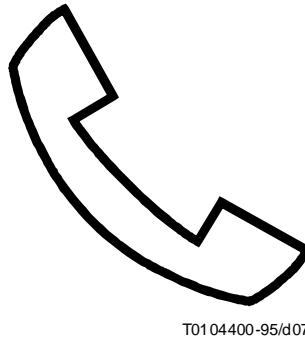

FIGURE 1/E.121

**Symbol for telephone: telephone handset in upper left-lower right orientation, with the microphone directed upwards**

## 7.2 Symbol for information

A symbol for information can be used in telephone directories, in lists of relevant telephone numbers shown in telephone booths, in other places where information via the telephone can be given, or in printed information for foreign visitors. It may also be used in association with several telephone (service) numbers. It may be used to draw attention to:

- a) general telephone service information;
- b) information about national or international telephone numbers;
- c) assistance in specific languages;
- d) information about hotels, theatres, etc.

When such a symbol is used, it should consist of the letter i (lower case) as shown in Figure 2. The symbol may be contained within a suitable frame or border. Since this symbol is a general reference, it should be associated with appropriate words or other symbols to show the nature of the information provided at the corresponding telephone number. For example, the “telephone” for general telephone inquiry and the words “English”, “Deutsch”, “Français” for assistance in specific languages.



FIGURE 2/E.121

**Symbol for information (lower case letter “i”)**

## 7.3 Symbol for facsimile

A symbol for facsimile may be used:

- a) in place of the word facsimile;
- b) to indicate a place where a facsimile service can be used;
- c) to refer to the facsimile service in general;
- d) as an adjunct to the facsimile number of a subscriber (see also clause 7/E.123).

When such a symbol is used, it should consist of the word FAX in capital letters as indicated in Figure 3.



FIGURE 3/E.121  
Symbol for facsimile [uppercase letters (FAX)]

#### 7.4 Symbol of access for the physically handicapped

A symbol of access for the physically handicapped may be used to indicate that a public telecommunication facility such as a telephone booth is accessible to a handicapped person, particularly one using a wheelchair.

The symbol to be used for this purpose is the symbol in Figure 4. This symbol has been adopted for international standardization in a resolution of the 1978 assembly of Rehabilitation International. For specific regulations regarding the design and application of this symbol, it is recommended that Administrations contact their national member organization of Rehabilitation International or the central office of Rehabilitation International, 25 East Street, New York, 10010, United States of America.



T0104430-95/d10

FIGURE 4/E.121  
Symbol of access for the handicapped

#### 7.5 Symbol for special facilities for the hard of hearing

A symbol for special facilities for the deaf and hard of hearing may be used to indicate that a telecommunication facility such as a public telephone has been specially adapted for the deaf and/or hard of hearing. Such special facilities may consist either of amplification or of textual presentation.

The symbol to be used for these purposes is the symbol in Figure 5. This symbol was adopted by the World Federation of the Deaf during their meeting in 1980. For specific regulations regarding the design and applications of this symbol, it is recommended that Administrations contact their national member organization of the World Federation of the Deaf or the General Secretariat of this organization at 120 via Gregorio VII, 00165, Rome, Italy.



T0104440-95/d11

FIGURE 5/E.121

**Symbol for special facilities for the deaf and hard of hearing**

## 7.6 Symbol for special facilities for the deaf

A symbol may be used to indicate that the facility of a text telephone is available through use with a specially adapted public terminal. The symbol to be used for such purposes is the symbol in Figure 6.

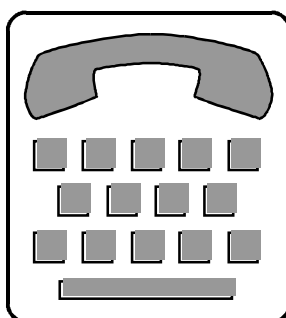

T0104450-95/d12

FIGURE 6/E.121

**Symbol for a text telephone connection in a public box**

## 8 Pictograms to aid identification of information

In some countries, a general emergency number is available to be dialled in all emergency situations. In other countries, different telephone numbers are used for each emergency service such as fire brigade, ambulance or police. Where a symbol is used to indicate the general emergency number, that symbol should be “SOS” as shown in Figure 7. Where no general emergency number exists, the symbol may be used to draw attention to the list of emergency numbers.

**SOS** T0104460-95/d13

FIGURE 7/E.121

**Symbol for general emergency number (the letters “SOS” in uppercase)**

The symbols shown in Figure 8 may be used in cases where different symbols are required, possibly in combination with Figure 7.

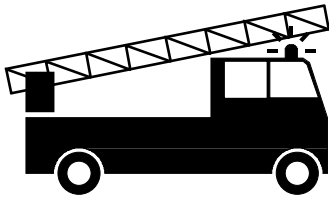

Symbol for fire brigade:  
side view of a fire engine,  
showing a flashing light  
and a ladder

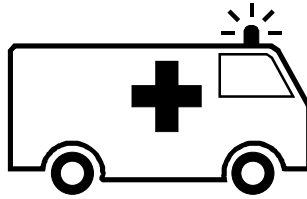

Symbol for ambulance:  
side view of an ambulance,  
showing a flashing light  
and a cross (Note 1)



T0104470-95/d14

Symbol for police:  
side view of a police car,  
showing a flashing light  
and the word police in the  
national language (Note 2)

#### NOTES

1 The cross may be replaced by a crescent in some countries. A red cross and a red crescent are reserved symbols of the International Committee of the Red Cross, and should not be used unless special arrangements are made with the International Committee of the Red Cross.

2 Shown here is an example in the Dutch language. If for typographical reasons, printing of the word for "police" in the national language is not feasible, this may be omitted

FIGURE 8/E.121

#### Symbols for emergency services

### 9 Pictograms to aid in the use of a public service

A sequence of pictograms is an effective means of instructing users of payphones, especially if certain users, e.g. foreign visitors, are not familiar with the equipment or operating procedures. Various studies on the design of pictographic instructions for payphones have led to the following guidelines.

If it is likely that certain users will be unfamiliar with the equipment (e.g. foreign visitors), realistic drawings showing the equipment to the extent necessary to locate the different parts would be helpful; where it is likely that users will be familiar with the equipment, or that locating the different elements is not a problem, less representative pictograms may be acceptable.

Movement (or certain actions) should be indicated by arrows. These could be provided in a different colour from the rest of the pictogram, for greater conspicuity.

Movement, or actions, in a sequence of pictographic instructions, should be labelled by numbers 1, 2, 3, etc. in the appropriate order.

Pictograms can be arranged in a horizontal strip (as illustrated in Figure 9) or in a vertical column, or (provided that the numbering is clear) in a block.

Pictograms should be placed where they will most easily be seen by the user and, wherever possible, should be fastened to the body of the equipment. Ideally, new payphones should be designed with a space on the front specifically to accommodate the pictograms, and the larger the space allowed, the better.

New pictogram designs should be tested in realistic conditions on a sample of the user population before being implemented generally.

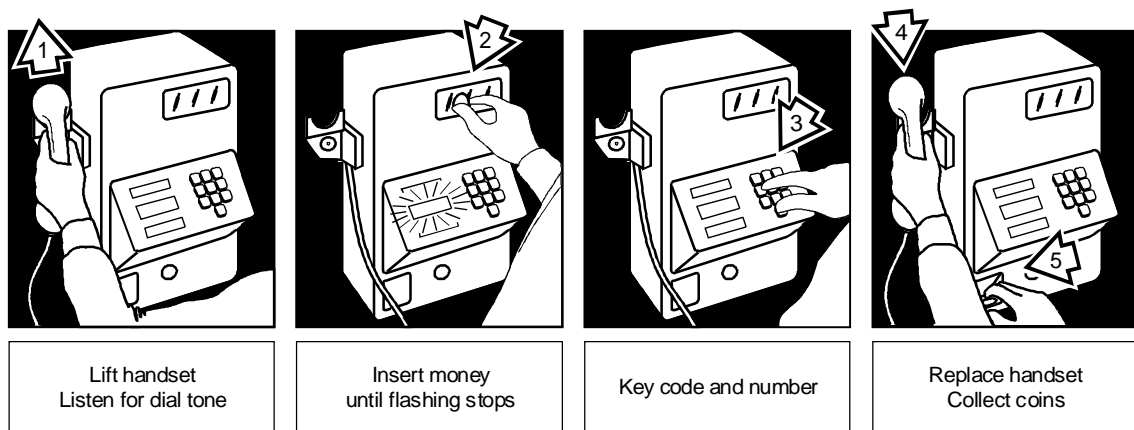

T0104480-95/d15

FIGURE 9/E.121

**Example of pictographic instructions**

**10 Pictogram to aid identification of telephone subscriber services and telephone functions**

Symbols may be used to designate telephone subscriber services. They may appear on subscriber equipment, e.g. on the push-buttons by which these services are operated. They may also be used in instructional material<sup>1)</sup>.

A symbol has the advantage – contrary to a name or an abbreviated name – of being independent of language. For users familiar with a certain language, the full name or a mnemonic code may be more easily understood.

Figures 10<sup>2)</sup> and 11<sup>3)</sup> show symbols for twelve supplementary services and six telecommunication functions. The difference between the elements of the symbols shown in Figures 10 and 11 reflects the different use being made of them. Figure 10 affects call set-up, and hence interworking with services, whilst Figure 11 deals with terminal functions.

The symbols presented in Figure 10 may also be displayed on a screen as long as they appear closely similar to their presentation on paper. On a commonly available display screen, this can be achieved by using a minimum of 60 × 50 or 60 × 60 pixels per symbol.

The majority of the standardized symbols in Figure 10 are based on the following elements:

- a point represents a subscriber's station;
- a line between points represents a connection between subscribers;
- a dashed line represents a connection on hold;
- an arrow represents a call:
  - outgoing calls ... an arrow away from the user ↑
  - incoming calls ... an arrow toward the user ↓
  - calls passing by ... an arrow passing by the user →

1) At the time these symbols were developed and tested, the procedures by which subscriber services are operated were not yet standardized. This may lead to the undesirable situation that the same symbol is used for different procedural implementations of a service. Efforts have therefore to be made to standardize the operational procedures for supplementary services.

2) During the study period 1981-1984, two experimental studies were conducted in order to develop an appropriate set of symbols. In either one study or both studies, the following Administrations and manufacturers took part: AT&T, United States; Bell-Northern Research, Canada; British Telecom, United Kingdom; Bundespost, Germany; Chile; France; ITT, United Kingdom; KTAS, Denmark; Netherlands; NTT, Japan; Sweden and Uruguay.

3) Figure 11 shows symbols for six telecommunication functions. With the exception of the volume (variability) symbol (IEC Publication 417, symbol No. 417-IEC-5004) the names of the functions and their applications are those used in the experiments conducted by the Communication Industries Association of Japan (CIAJ) in which the symbols were evaluated.

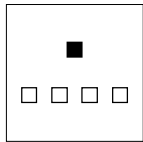

*Short code dialling*

You only need to dial a simple code (e.g. a number from 1-9) in place of the complete telephone number when calling commonly used numbers (abbreviated dialling services, see 2.1<sup>a)</sup>)

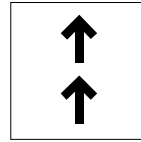

*Repeat last call*

The last number that you dialled is called again (e.g. if it was previously engaged). This service can be repeated (e.g. if still engaged) (number repetition service, see 2.26<sup>a)</sup>)

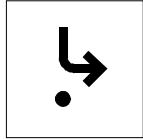

*Basic diversion*

All calls made to your telephone will be diverted to another telephone (do not disturb service, see 1.2<sup>a)</sup>)



*No-reply diversion*

If you do not answer your telephone, the call will be diverted to another telephone (absent subscriber service, see 1.1<sup>a)</sup>)

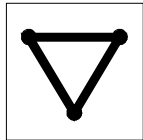

*Three-party call*

Allows you to set up a telephone conference between yourself and two other parties (three-party services, see 1.15<sup>a)</sup>)

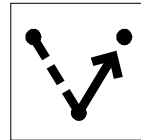

*Enquiry call*

Allows you to "hold" someone you are talking to while you make another call (three-party service, see 1.15<sup>a)</sup>)

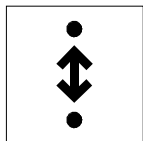

*Call-back*

If a party you have called is engaged, the call will automatically be made again as soon as he is free (completion of calls to busy subscribers service, see 1.12<sup>a)</sup>)

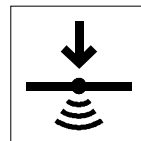

*Call waiting*

If you are speaking to another party, further calls to your telephone will cause a signal to inform you that someone is trying to reach you (call waiting services, see 2.23<sup>a)</sup>)

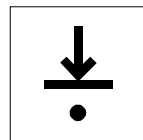

*Incoming calls barred*

Any call made to your telephone will be stopped (incoming calls barring, see 1.10<sup>a)</sup>)

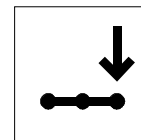

*Call pick-up*

You may use your own telephone to answer calls made to another telephone in the same "group" (e.g. a colleague's telephone) (PBX line-hunting service, see 2.6<sup>a)</sup>)



*General cancel*

Cancels any of the services you have previously activated (e.g. to cancel "incoming calls barred")

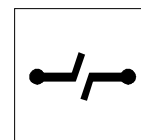

*Disconnect*

Allows you to finish a call and make a new one without replacing the handset

T0104490-95/d16

<sup>a)</sup> Paragraph numbers refer to Supplement No. 1, Fascicle II.2, *Blue Book*, Geneva 1988.

FIGURE 10/E.121  
Symbols for supplementary services

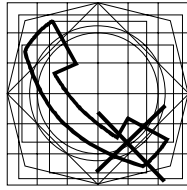

Transmission mute

To indicate stopping transmission temporarily

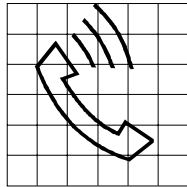

Receiver volume

To indicate the receiver volume control

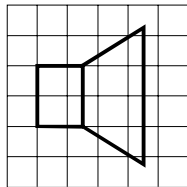

Loudspeaker receiving

To indicate the receiving sound from the loudspeaker

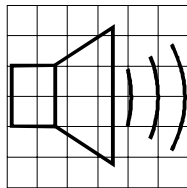

Loudspeaker volume

To indicate the volume control for the loudspeaker

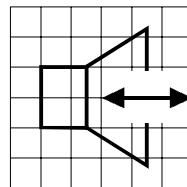

Handsfree communication

To indicate communicating by microphone and loudspeaker without picking up a handset

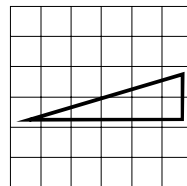

Volume Variability  
(417-IEC-5004)

T0104500-95/d17

On any kind of equipment. To identify the control by means of which a quantity is controlled. The controlled quantity increases with the figure width

FIGURE 11/E.121  
Symbols for telecommunication functions

## 11 Pictograms to aid identification of videotelephony functions

Figure 12 contains pictograms representing eight point-to-point videotelephony functions. The eight functions are:

- a) videophone/telephone (switching between videophone and telephone modes);
- b) videophone camera on/off (turning on and off the transmission of the camera signal);
- c) videophone microphone on/off (turning on and off the transmission of the microphone signal);
- d) videophone selfview on/off (turning on and off the selfview function);
- e) videophone still picture on/off [turning on and off the still picture function (screen freeze)];
- f) videophone document camera on/off (...);
- g) videophone handsfree on/off (switching on and off the handsfree mode);
- h) videophone loudspeaking on/off (switching on and off the loudspeaking mode).

The pictograms have been recommended on the basis of an empirical evaluation study of several pictograms sets. The evaluation study has been carried out in eight European countries (using more than 600 subjects) in order to take into account possible cultural and linguistic differences. The testing method used was the Multiple Index Approach for the evaluation of pictograms (as described in ETR 070 [3] which is similar to Recommendation F.910). The results of the study are reported in ETR 113 [4].

For the purposes of this Recommendation, the following definitions of videophone functions apply:

**videophone/telephone:** in videotelephony, for switching between videophone (sound and picture) and telephone (sound only) modes.

**videophone camera on/off:** in videotelephony, for switching on and off the transmission of the camera signal.

**videophone microphone on/off:** in videotelephony, for switching on and off the transmission of the microphone signal.

**videophone selfview on/off:** in videotelephony, for switching on and off the selfview function.

**videophone still picture on/off:** in videotelephony, for switching on and off the still picture function (screen freeze).

**videophone document camera on/off:** in videotelephony, for switching on and off the document camera.

**videophone handsfree on/off:** in videotelephony, for switching on and off the handsfree mode.

**handsfree mode:** a telephone set using a loudspeaker associated with an amplifier as a telephone receiver and which may be used without a handset [see Recommendation P.10 (1988)].

**videophone loudspeaking on/off:** in videotelephony, for switching on and off the loudspeaking mode.

**loudspeaking mode:** a telephone set using a loudspeaker associated with an amplifier as a telephone receiver [see Recommendation P.10 (1988)].

The pictogram for the videophone handsfree on/off function is identical with the IEC symbol for “Loudspeaker/Microphone” (417-IEC-5081) and is contained in Figure 11 as “Handsfree communication”. The pictogram for the videophone loudspeaking on/off function is identical with the IEC symbol for “Loudspeaker” (417-IEC-5080) and is contained in Figure 11 as “Loudspeaker receiving”.

They are repeated here in the set of videotelephony pictograms for purposes of completeness and because they were included in the empirical evaluation study cited earlier in this clause.

If one control only is used for switching between handset mode, handsfree mode and loudspeaking mode, the pictogram for identifying this control shall be the one for videophone loudspeaking on/off.



Symbole graphique n° 1: Visiophone/téléphone  
Graphical symbol No. 1: Videophone/telephone

SYMBOLE ORIGINAL  
ORIGINAL SYMBOL  
(a = 50 mm)

Dimensions réelles  
hauteur = 1,30 a  
largeur = 1,41 a

Real dimensions  
height = 1.30 a  
width = 1.41 a

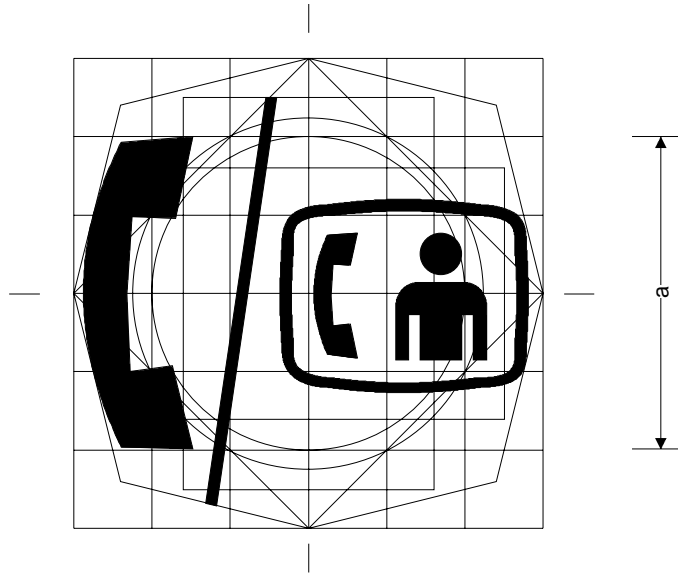

Application: In videotelephony, for switching between videophone (sound and picture) and telephone (sound only) modes.

T0104510-95/d18

FIGURE 12/E.121

Symbole graphique n° 2: Camera du visiophone marche/  
arrêt

Graphical symbol No. 2: Videophone camera on/off

SYMBOLE ORIGINAL  
ORIGINAL SYMBOL  
(a = 50 mm)

Dimensions réelles  
hauteur = 1,30 a  
largeur = 1,41 a

Real dimensions  
height = 1.30 a  
width = 1.41 a

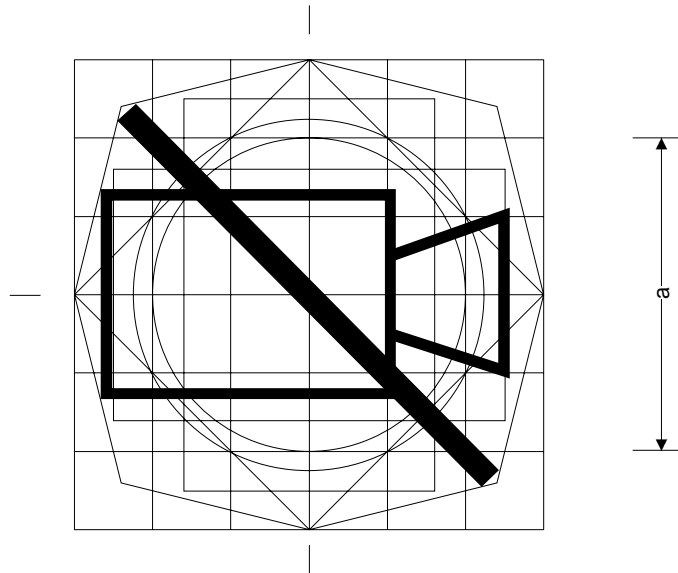

Application: In videotelephony, for switching on and off the transmission of the camera signal.

NOTE – The diagonal bar may be omitted when the normal system state is one in which the camera is turned off.

T0104520-95/d19

FIGURE 12/E.121 (continued)

Symbole graphique n° 3: Microphone du visiophone  
marche/arrêt

Graphical symbol No. 3: Videophone microphone on/off

SYMBOLE ORIGINAL  
ORIGINAL SYMBOL  
(a = 50 mm)

Dimensions réelles  
hauteur = 1,30 a  
largeur = 1,41 a

Real dimensions  
height = 1.30 a  
width = 1.41 a

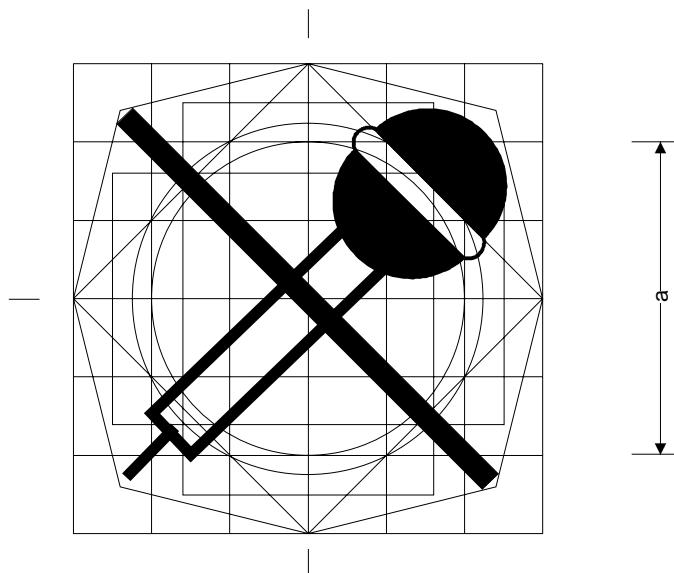

Application: In videotelephony, for switching on and off the transmission of the microphone signal.

NOTE – The diagonal bar may be omitted when the normal system state is one in which the camera is turned off.

T0104530-95/d20

FIGURE 12/E.121 (continued)

Symbole graphique n° 4: Visiophonie en mode autoportrait  
marche/arrêt

Graphical symbol No. 4: Videophone selfview on/off

SYMBOLE ORIGINAL  
ORIGINAL SYMBOL  
(a = 50 mm)

Dimensions réelles  
hauteur = 1,30 a  
largeur = 1,41 a

Real dimensions  
height = 1.30 a  
width = 1.41 a

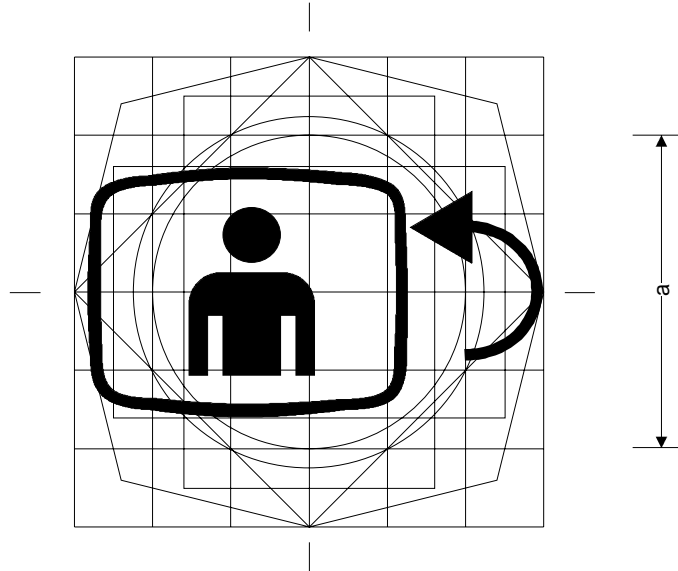

Application: In videotelephony, for switching on and off the selfview function.

T0104540-95/d21

FIGURE 12/E.121 (continued)

Symbole graphique n° 5: Visiophonie en mode image fixe  
marche/arrêt

Graphical symbol No. 5: Videophone still picture on/off

SYMBOLE ORIGINAL

ORIGINAL SYMBOL

(a = 50 mm)

Dimensions réelles  
hauteur = 1,30 a  
larguer = 1,41 a

Real dimensions  
height = 1.30 a  
width = 1.41 a

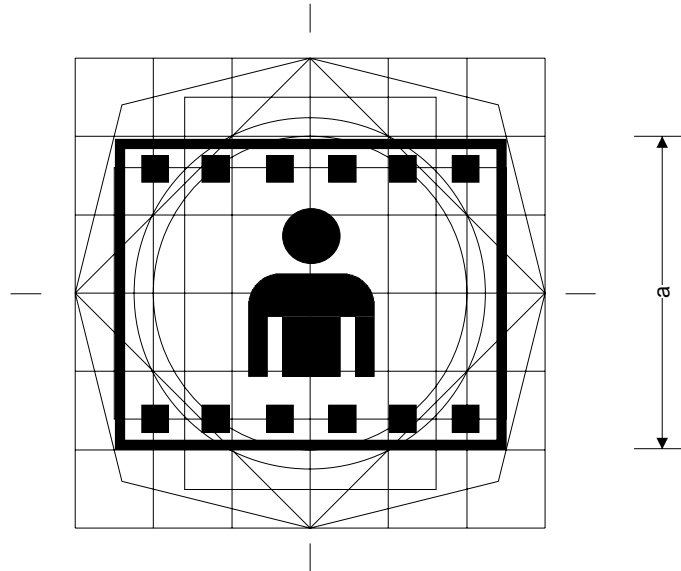

Application: In videotelephony, for switching on and off the still picture (screen freeze) function.

T0104550-95/d22

FIGURE 12/E.121 (continued)

Symbole graphique n° 6: Caméra document du visiophone  
marche/arrêt

Graphical symbol No. 6: Videophone document camera  
on/off

SYMBOLE ORIGINAL  
ORIGINAL SYMBOL  
(a = 50 mm)

Dimensions réelles  
hauteur = 1,30 a  
largeur = 1,41 a

Real dimensions  
height = 1.30 a  
width = 1.41 a

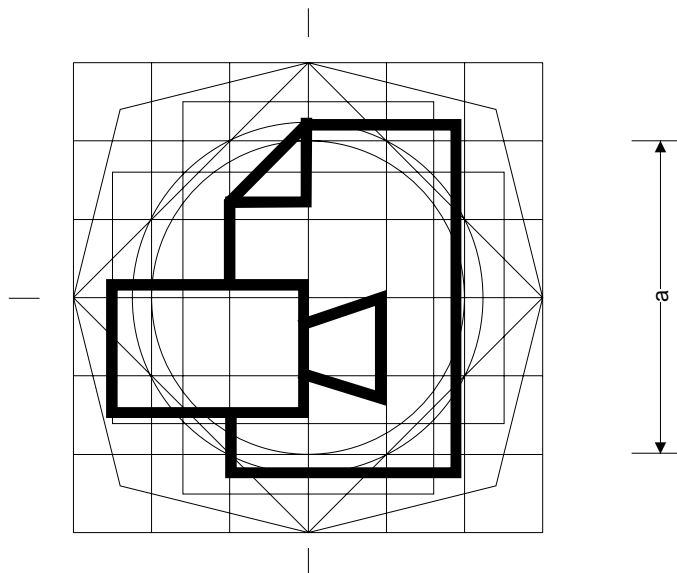

Application: In videotelephony, for switching on and off the document camera.

T0104560-95/d23

FIGURE 12/E.121 (continued)

Symbole graphique n° 7:	Mains libres du visiophone marche arrêt
Graphical symbol No. 7:	Videophone handsfree on/off

SYMBOLE ORIGINAL  
ORIGINAL SYMBOL  
(a = 50 mm)

Dimensions réelles  
hauteur = 1,30 a  
largeur = 1,41 a

Real dimensions  
height = 1.30 a  
width = 1.41 a

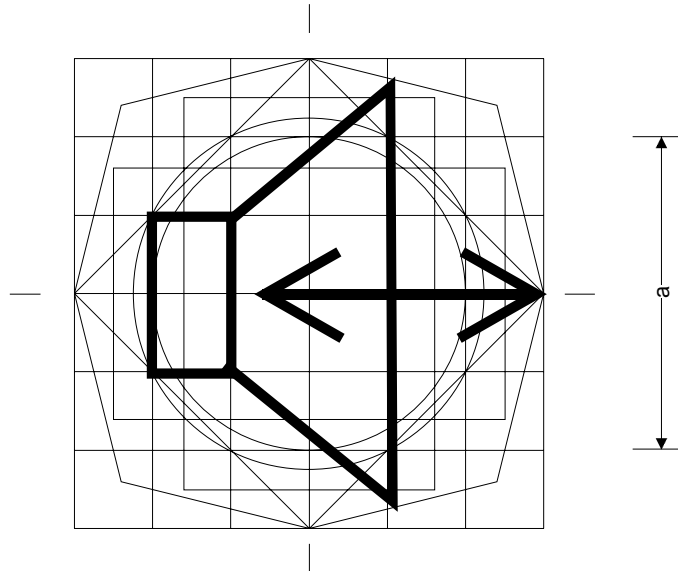

Application: In videotelephony, for switching on and off the handsfree mode.

Reference: This symbol is identical with the IEC symbol for "Loudspeaker/Microphone" (417-IEC-5081: Graphical symbol: Loudspeaker/Microphone) and is contained in Figure 11 as "Handsfree communication".

T0104570-95/d24

FIGURE 12/E.121 (continued)

Symbole graphique n° 8: Ecoute amplifiée du visiophone  
marche/arrêt

Graphical symbol No. 8: Videophone loudspeaking on/off

SYMBOLE ORIGINAL  
ORIGINAL SYMBOL  
(a = 50 mm)

Dimensions réelles  
hauteur = 1,30 a  
largeur = 1,41 a

Real dimensions  
height = 1.30 a  
width = 1.41 a

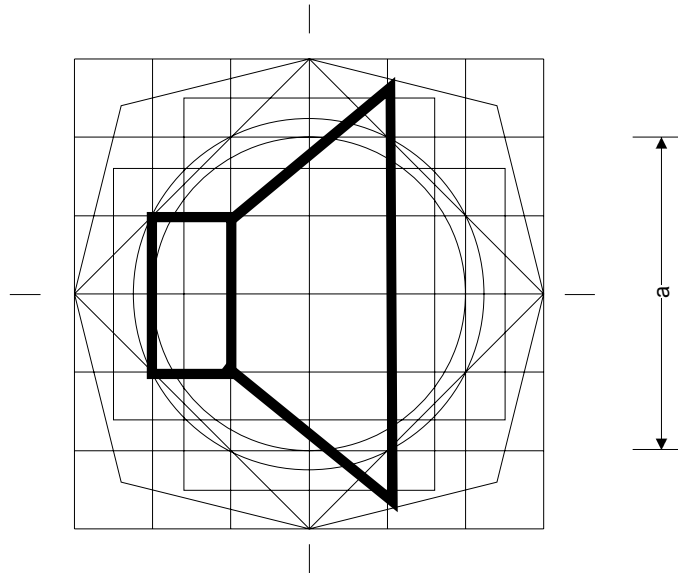

Application: In videotelephony, for switching on and off the loudspeaking mode.

Reference: This symbol is identical with the IEC symbol for "Loudspeaker"  
(417-IEC-5081: Graphical symbol: Loudspeaker) and is contained in Figure 11 as "Loudspeaker receiving".

T0104580-95/d25

FIGURE 12/E.121 (concluded)



## 12 Guidelines for testing

Guidelines for designing, evaluating and selecting symbols, pictograms and icons are contained in Recommendation F.910.

### References

- [1] IEC Publication 417 (1973) 5090-a.
- [2] ZWICKER (E.) *et al.*: Critical bandwidth in loudness summation, *Journal of the Acoustical Society of America*, Vol. 29, pp. 548-557, 1957.
- [3] ETR 070 (1993), *Human Factors (HF); The Multiple Index Approach (MIA) for the evaluation of pictograms*.
- [4] ETR 113 (1993), *Human Factors (HF); Results of and Evaluation Study of pictograms for point-to-point videotelephony*.