

# IEEE Guide for the Protection of Stationary Battery Systems

*Circuits and Devices*

*Communications Technology*

*Computer*

*Electromagnetics and Radiation*

*Energy and Power*

*Industrial Applications*

*Signal and  
Applications*

IEEE Std 1375-1998

**IEEE Standards Coordinating  
Committee 29  
on Stationary Batteries**



LEAD-ACID BATTERY STANDARD ENDORSED  
BY BATTERY COUNCIL INTERNATIONAL



*Published by the Institute of Electrical and Electronics Engineers, Inc., 345 East 47th Street, New York, NY 10017, USA.*

*2 July 1998*

*SH94617*

IEEE Std 1375-1998

# IEEE Guide for the Protection of Stationary Battery Systems

Sponsor

**IEEE Standards Coordinating Committee 29  
on Stationary Batteries**

Approved 19 March 1998

**IEEE-SA Standards Board**

**Abstract:** Guidance in the protection of stationary battery systems is provided. For the purposes of this guide, stationary battery systems include the battery and dc components to and including the first protective device downstream of the battery terminals. This guide does not set requirements; rather, it presents a number of options to the dc system designer of the different types of stationary battery system protection available.

**Keywords:** circuit breaker, current limiting, equipment grounding, fuse, grounding, lead-acid batteries, nickel-cadmium batteries, overvoltage protection, short-circuit current, stationary battery, system grounding, temperature compensation, undervoltage protection

---

The Institute of Electrical and Electronics Engineers, Inc.  
345 East 47th Street, New York, NY 10017-2394, USA

Copyright © 1998 by the Institute of Electrical and Electronics Engineers, Inc.  
All rights reserved. Published 1998. Printed in the United States of America.

ISBN 0-7381-0187-7

*No part of this publication may be reproduced in any form, in an electronic retrieval system or otherwise, without the prior written permission of the publisher.*

**IEEE Standards** documents are developed within the IEEE Societies and the Standards Coordinating Committees of the IEEE-SA Standards Board. Members of the committees serve voluntarily and without compensation. They are not necessarily members of the Institute. The standards developed within IEEE represent a consensus of the broad expertise on the subject within the Institute as well as those activities outside of IEEE that have expressed an interest in participating in the development of the standard.

Use of an IEEE Standard is wholly voluntary. The existence of an IEEE Standard does not imply that there are no other ways to produce, test, measure, purchase, market, or provide other goods and services related to the scope of the IEEE Standard. Furthermore, the viewpoint expressed at the time a standard is approved and issued is subject to change brought about through developments in the state of the art and comments received from users of the standard. Every IEEE Standard is subjected to review at least every five years for revision or reaffirmation. When a document is more than five years old and has not been reaffirmed, it is reasonable to conclude that its contents, although still of some value, do not wholly reflect the present state of the art. Users are cautioned to check to determine that they have the latest edition of any IEEE Standard.

Comments for revision of IEEE Standards are welcome from any interested party, regardless of membership affiliation with IEEE. Suggestions for changes in documents should be in the form of a proposed change of text, together with appropriate supporting comments.

**Interpretations:** Occasionally questions may arise regarding the meaning of portions of standards as they relate to specific applications. When the need for interpretations is brought to the attention of IEEE, the Institute will initiate action to prepare appropriate responses. Since IEEE Standards represent a consensus of all concerned interests, it is important to ensure that any interpretation has also received the concurrence of a balance of interests. For this reason, IEEE and the members of its societies and Standards Coordinating Committees are not able to provide an instant response to interpretation requests except in those cases where the matter has previously received formal consideration.

Comments on standards and requests for interpretations should be addressed to:

Secretary, IEEE-SA Standards Board  
445 Hoes Lane  
P.O. Box 1331  
Piscataway, NJ 08855-1331  
USA

Note: Attention is called to the possibility that implementation of this standard may require use of subject matter covered by patent rights. By publication of this standard, no position is taken with respect to the existence or validity of any patent rights in connection therewith. The IEEE shall not be responsible for identifying patents for which a license may be required by an IEEE standard or for conducting inquiries into the legal validity or scope of those patents that are brought to its attention.

Authorization to photocopy portions of any individual standard for internal or personal use is granted by the Institute of Electrical and Electronics Engineers, Inc., provided that the appropriate fee is paid to Copyright Clearance Center. To arrange for payment of licensing fee, please contact Copyright Clearance Center, Customer Service, 222 Rosewood Drive, Danvers, MA 01923 USA; (978) 750-8400. Permission to photocopy portions of any individual standard for educational classroom use can also be obtained through the Copyright Clearance Center.

## Introduction

(This introduction is not part of IEEE Std 1375-1998, IEEE Guide for the Protection of Stationary Battery Systems.)

Stationary batteries are used in a wide variety of industry applications including electric generating stations, substations, telecommunications installations, petrochemical installations, large industrial and commercial installations, large uninterruptible power supply (UPS) installations, and renewable energy plant installations. Stationary batteries are often classified as the emergency power source to critical facility loads, and the loss of the battery supply could result in significant damage to facility components or to the facility itself. When developing the design of a stationary battery supply for a new or existing facility, the protection of the stationary battery is just one of a number of items the dc system designer has to consider. Proper protection of the stationary battery, along with the proper installation and maintenance of the stationary battery system, will ensure the reliability of the battery supply to the facility's dc loads.

There is a wide variety of existing standards concerning the sizing, installation, maintenance, testing, and replacement of stationary batteries. This guide provides guidance to the dc system designer for the electrical and physical protection of stationary batteries. This guide does not set requirements; rather, it presents a number of options to the dc system designer of the different types of stationary battery system protection available. This guide also provides an in-depth discussion of the protective devices available for use in the protection of stationary battery systems as well as in-depth discussions of stationary batteries and the short-circuit characteristics of battery chargers.

This guide provides references to other published industry standards as applicable. The reader is cautioned to use this guide in conjunction with applicable IEEE standards and industry standards.

This guide was prepared by a working group of the Battery Protection Subcommittee of SCC 29, the IEEE Standards Coordinating Committee on Stationary Batteries. At the time this guide was approved, the working group consisted of the following members:

### Harold E. Epstein, *Chair*

Curtis Aston  
William Bennett  
Mark Bowman  
Richard Buttner  
Cindy Cline  
Yun Ko Chien  
James Erickson  
George Farrell

Dan Giblin  
Paul Gogan  
George Gregory  
Michael Hartmann  
Richard Higdon  
John Hilditch  
Anil Julka

George Morris  
Phillip Prechtel  
Robert D. Soileau, Jr.  
Kurt W. Uhler  
Lee Underwood  
Stephen L. Vechy  
Graham Walker  
John Wiles

The following persons, members of SCC 29, were on the balloting committee:

James W. Anderson	Paul E. Hellen	Ronald Roman
Robert R. Beavers	Robert M. Herritty	Thomas E. Ruhlmann
Jack H. Bellack	Mark J. Hlavac	Marco Ruvalcaba
Tim Bolgeo	Wayne E. Johnson	Amiya B. Samanta
William P. Cantor	Harold J. Kelly	Desi Santanna
Jay L. Chamberlin	Sharad C. Khamanikar	Robert D. Soileau, Jr.
John K. Coyle	Alan L. Lamb	Witold Sokolski
Joseph A. Cristino	Peter Langan	Edward C. Stallings
Thomas G. Croda	Glenn E. Latimer	Martin M. Stanton
Eddie Davis	Daniel S. Levin	J. E. Staudacher
Peter J. Demar	Demetrios N. Logothetis	Frank L. Tarantino
Harold E. Epstein	Gary J. Markle	Shawn Tyler
David O. Feder	Jose Marrero	Kurt W. Uhler
Robert J. Fletcher	James A. McDowall	Isaac H. Vaneman
Kyle D. Floyd	Marco W. Migliaro	Lesley Varga
Paul W. Gaffney	Arne O. Nilsson	Stephen L. Vecchy
Jimmy G. Godby	Zbig Noworolski	Graham Walker
Jerry C. Gordon	Donald Ogden	Michael C. Weeks
Richard A. Greco	Bansi Patel	Walter A. Wylie

When the IEEE-SA Standards Board approved this guide on 19 March 1998, it had the following membership:

**Richard J. Holleman, *Chair***

**Donald N. Heirman, *Vice Chair***

**Judith Gorman, *Secretary***

Satish K. Aggarwal  
Clyde R. Camp  
James T. Carlo  
Gary R. Engmann  
Harold E. Epstein  
Jay Forster\*  
Thomas F. Garrity  
Ruben D. Garzon

James H. Gurney  
Jim D. Isaak  
Lowell G. Johnson  
Robert Kennelly  
E. G. "Al" Kiener  
Joseph L. Koepfinger\*  
Stephen R. Lambert  
Jim Logothetis  
Donald C. Loughry

L. Bruce McClung  
Louis-François Pau  
Ronald C. Petersen  
Gerald H. Peterson  
John B. Posey  
Gary S. Robinson  
Hans E. Weinrich  
Donald W. Zipse

\*Member Emeritus

Valerie E. Zelenty  
*IEEE Standards Project Editor*

National Electrical Code and NEC are registered trademarks of the National Fire Protection Association.  
Uniform Building Code is a trademark of the International Conference of Building Officials (ICBO).

## Contents

1. Overview.....	1
1.1 Scope.....	1
1.2 Purpose.....	1
2. References.....	2
3. Definitions.....	3
4. Philosophy of stationary battery protection.....	3
5. DC system considerations.....	4
5.1 Use of a battery protective device.....	5
5.2 Overvoltage and undervoltage protection.....	5
5.3 Grounding.....	6
5.4 Temperature compensation and current limiting.....	7
6. Batteries.....	7
6.1 Lead-acid batteries.....	8
6.2 Nickel-cadmium batteries.....	8
6.3 Battery voltage characteristics during short-circuit conditions.....	9
6.4 Battery current characteristics during short-circuit conditions.....	9
6.5 Battery withstand capability during short-circuit conditions.....	10
6.6 Environmental and operational effects on battery short-circuit current.....	11
6.7 Damage and failures of batteries.....	12
7. Characteristics of other dc system components.....	14
7.1 Battery charger short-circuit characteristics.....	14
7.2 Characteristics of fuses in dc circuits.....	16
7.3 Characteristics of circuit breakers in dc circuits.....	23
7.4 Characteristics of fused circuit breakers in dc circuits.....	31
7.5 Switches.....	32
7.6 Use of ac rated devices for battery protection.....	34
7.7 Ratings considerations for devices used in dc systems.....	35
7.8 Main battery feeder cables.....	36
8. Battery electrical protection schemes.....	37
8.1 Fuses between the battery terminals and main dc panel.....	37
8.2 Circuit breakers between the battery terminals and main dc panel.....	38
8.3 A switch between the battery terminals and main dc panel.....	39
8.4 Cable only between the battery terminals and main dc panel.....	42
8.5 Mid-span battery protection.....	42
8.6 Multiple voltage battery systems.....	43
8.7 Parallel battery string systems.....	43
9. Physical protection of batteries.....	44

10. Indication and annunciation.....	44
Annex A (informative) Bibliography.....	45
Annex B (informative) DC system time constants.....	46
Annex C (informative) Sample battery system time constant determination.....	50

# IEEE Guide for the Protection of Stationary Battery Systems

## 1. Overview

### 1.1 Scope

This document provides guidance in the protection of stationary battery systems. For the purposes of this guide, stationary battery systems include the battery and dc components to and including the first protective device downstream of the battery terminals. The recommendations provided are not intended to set requirements; rather, they present options to the designer of the battery system concerning the types of protection available.

This guide provides discussions and recommendations regarding the forms of stationary battery protection as well as characteristics, sizing, application, and ratings of protective devices used in dc circuits and the short-circuit characteristics of batteries and battery chargers. A discussion of physical protection of battery systems as well as electrical protection is provided within this guide. Discussions are also presented in Annexes B and C regarding dc system time constants.

A discussion of coordination of protective devices for selective tripping is not treated within this guide and is considered beyond its scope. The user of this guide is referred to IEEE Std 242-1986<sup>1</sup> for guidance concerning coordination of protective devices.

Both grounded and ungrounded dc battery systems are used widely in different industry applications. The philosophy employed in the protection of stationary battery systems shall take into consideration whether the dc system is a grounded or ungrounded system. This guide provides guidance in the protection of both grounded and ungrounded stationary battery systems.

### 1.2 Purpose

This document provides guidance concerning items to consider in the protection of stationary battery systems. The guide is intended for use in the protection of battery systems in a wide industry perspective including electric generating stations, substations, telecommunications installations, large industrial and commercial installations, large uninterruptible power supply (UPS) installations, and renewable energy plant installations. While voltage levels indicated within this guide may be applicable to a particular industry, the concepts and recommendations provided apply to most installations of stationary battery systems.

<sup>1</sup>Information on references can be found in Clause 2.

## 2. References

This guide shall be used in conjunction with the following publications.

ANSI C37.16-1988, American National Standard for Switchgear—Low Voltage Power Circuit Breakers and AC Power Circuit Protectors—Preferred Ratings, Related Requirements, and Application Recommendations.<sup>2</sup>

ANSI C37.17-1979 (Reaff 1988), American National Standard for Trip Devices for AC and General Purpose DC Low-Voltage Power Circuit Breakers.

ANSI T1.311-1991, American National Standard for DC Power Systems—Telecommunications Environment Protection.<sup>3</sup>

IEEE Std 100-1996, The IEEE Standard Dictionary of Electrical and Electronics Terms.<sup>4</sup>

IEEE Std 142-1991, IEEE Recommended Practice for Grounding of Industrial and Commercial Power Systems.

IEEE Std 242-1986 (Reaff 1991), IEEE Recommended Practice for Protection and Coordination of Industrial and Commercial Power Systems.

IEEE Std 450-1995, IEEE Recommended Practice for Maintenance, Testing, and Replacement of Vented Lead-Acid Batteries for Stationary Applications.

IEEE Std 484-1996, IEEE Recommended Practice for Installation Design and Installation of Vented Lead-Acid Batteries for Stationary Applications.

IEEE Std 485-1997, IEEE Recommended Practice for Sizing Lead-Acid Batteries for Stationary Applications.

IEEE Std 946-1992, IEEE Recommended Practice for the Design of DC Auxiliary Power Systems for Generating Stations.

IEEE Std 1106-1995, IEEE Recommended Practice for Maintenance, Testing, and Replacement of Nickel-Cadmium Storage Batteries for Generating Stations and Substations.

IEEE Std 1115-1992, IEEE Recommended Practice for Sizing Nickel-Cadmium Batteries for Stationary Applications.

IEEE Std 1187-1996, IEEE Recommended Practice for Installation Design and Installation of Valve-Regulated Lead-Acid Storage Batteries for Stationary Applications.

IEEE Std 1188-1996, IEEE Recommended Practice for Maintenance, Testing, and Replacement of Valve Regulated Lead-Acid (VRLA) Batteries for Stationary Applications.

<sup>2</sup>ANSI C37 standards are available from the Institute of Electrical and Electronics Engineers, 445 Hoes Lane, P.O. Box 1331, Piscataway, NJ 08855-1331, USA. They are also available from the Sales Department, American National Standards Institute, 11 West 42nd Street, 13th Floor, New York, NY 10036, USA.

<sup>3</sup>ANSI publications are available from the Sales Department, American National Standards Institute, 11 West 42nd Street, 13th Floor, New York, NY 10036, USA.

<sup>4</sup>IEEE publications are available from the Institute of Electrical and Electronics Engineers, 445 Hoes Lane, P.O. Box 1331, Piscataway, NJ 08855-1331, USA.

IEEE Std 1189-1996, IEEE Guide for Selection of Valve-Regulated Lead-Acid (VRLA) Batteries for Stationary Applications.

IEEE Std C37.14-1992, IEEE Standard for Low-Voltage DC Power Circuit Breakers Used in Enclosures.

IEEE Std C37.100-1992, IEEE Standard Definitions for Power Switchgear.

NEMA KS-1-1996, Enclosed and Miscellaneous Distribution Equipment Switches (600 Volts Maximum).<sup>5</sup>

UL 98-1994, Enclosed and Dead-Front Switches (DoD).<sup>6</sup>

UL 198L-1995, D-C Fuses for Industrial Use.

UL 198M-1995, Mine-Duty Fuses.

UL 248-5-1996, Low-Voltage Fuses—Part 5: Class G Fuses.

UL 248-14-1994, Low-Voltage Fuses—Part 14: Supplemental Fuses.

UL 489-1991, Molded-Case Circuit Breakers and Circuit-Breaker Enclosures (DoD).

UL 977-1994, Fused Power-Circuit Devices (DoD).

NFPA 70-1996, National Electrical Code® (NEC®).<sup>7</sup>

NFPA 220-1996, Types of Building Construction.<sup>8</sup>

### 3. Definitions

For definition of terms contained in this guide refer to IEEE Std 100-1996 and the definitions contained in the referenced publications of Clause 2.

### 4. Philosophy of stationary battery protection

The protection of stationary batteries can take a number of different forms depending on the service requirements of the battery. Several options available to the designer are presented below. These options include the use of an interrupting device (fuse, circuit breaker, or fused circuit breaker) for short circuit and, if applicable, overload protection of the battery, and mid-span protection of the battery.

Also presented is an option where there is no interrupting device between the battery and the main dc bus it supplies (cable only) as well as one where there is a disconnect switch installed between the battery and the main dc bus it supplies. In these cases there would be no short circuit or overload protection for a fault either

<sup>5</sup>NEMA publications are available from the National Electrical Manufacturers Association, 1300 N. 17th St., Ste. 1847, Rosslyn, VA 22209, USA.

<sup>6</sup>UL standards are available from Global Engineering, 1990 M Street NW, Suite 400, Washington, DC, 20036, USA.

<sup>7</sup>The National Electrical Code is available from the Institute of Electrical and Electronics Engineers, 445 Hoes Lane, P.O. Box 1331, Piscataway, NJ 08855-1331, USA. It is also available from Publications Sales, National Fire Protection Association, 1 Batterymarch Park, P.O. Box 9101, Quincy, MA 02269-9101, USA.

<sup>8</sup>NFPA publications are available from Publications Sales, National Fire Protection Association, 1 Batterymarch Park, P.O. Box 9101, Quincy, MA 02269-9101, USA.

on the battery cable supplying the main dc bus or at the bus. For these options, the stationary battery system includes the battery, the battery cable, the main dc bus, and the branch protective devices it supplies.

The philosophy of stationary battery system protection should begin with a knowledge of the application of the battery, its service requirements, and whether the dc system is grounded or ungrounded. It is important to note that *no one option presented below for the protection of stationary battery systems is more correct than another*. Rather, the option chosen by the designer of the stationary battery system is dependent upon its application.

For example, the designer of the system should consider whether the stationary battery is the last available electrical source to supply critical loads on an interruption of the ac supply or if there is an alternate supply available if the battery supply is interrupted on a short circuit or overload. If the overriding factor is that on a loss of ac power for an electrical auxiliary system there will be serious and significant damage to the installation because the dc supply to critical loads is interrupted, and there is no alternate means to provide dc service to these critical loads other than the stationary battery, the designer may wish to consider the installation of either a switch, or just a cable between the battery and the main dc bus supplied by it, to maintain the dc source as long as possible and reduce the probability of premature loss of the source.

On the other hand, if the overriding factor is that there has to be a dc supply available to plant loads, and there is an alternate means to supply the critical dc loads on a loss of the stationary battery supply without significant damage to the installation, the designer may wish to consider the installation of short-circuit protection (and overload protection if applicable) between the battery and the main dc bus it supplies. This form of stationary battery protection provides the user with the ability to interrupt a fault or overload on the stationary battery system; investigate, locate, and clear the fault that caused the interruption of the battery supply; and restore the battery to service.

The designer of the battery system should consider the physical installations of the battery, as described in Clause 9. In addition, physical protection of the stationary battery system should be considered in concert with the form of electrical protection of the battery. For example, if there is no short-circuit protective device installed between the battery and its main dc bus, then the designer should consider a separate enclosure for the battery with appropriate fire-rated walls. If the dc fault occurs on the cable between the battery and its main dc bus, then the battery will supply the fault until the circuit is broken or the battery is completely discharged. Significant heating may occur under these circumstances, resulting in possible combustion of materials in the battery cable or the battery itself.

This guide presents discussions on the electrical protection and physical protection of stationary battery systems. Discussions are presented on short-circuit characteristics of lead-acid and nickel-cadmium batteries, battery chargers, characteristics of fuses, circuit breakers and disconnect switches, conductors, use of ac rated devices in the protection of stationary battery systems, fire protection and detection, ventilation, and alarms among others.

## 5. DC system considerations

The function of the battery system should be understood. Battery systems are usually relied upon as the last and/or only source of reliable electrical power at a facility or installation. However, they can also be the prime source of electrical power in special cases. The operating philosophy of the electrical system determines the level of sophistication and the type of protective devices used in the battery system. Because dc systems and battery power sources differ from ac systems, it is important that the dc system protection designer be aware of some special considerations.

The two competing objectives when designing the protection scheme for a battery system are as follows:

- a) Minimize the risk of equipment damage during electrically faulted conditions.
- b) Limit the number and duration of the battery system service interruptions as a result of an electrically faulted condition.

The dc system protection designer should consider the aspects discussed below when balancing objectives and choosing protection schemes.

### 5.1 Use of a battery protective device

Protective devices at the battery serve to minimize the extent of damage to the battery system during electrically faulted conditions. The same devices also increase the risk of a battery system service interruption due to a malfunction or human error. Factors to consider are

- a) The conductor distance between the battery and the distribution bus;
- b) The physical configuration of the conductor (physical cable protection afforded by conduit and/or separation of positive and negative conductors);
- c) The facility staffing level (a continuously manned facility versus an unmanned, remote location);
- d) The expected level of fault current due to an electrical fault in the battery system;
- e) The effects of equipment damage or personnel injury due to a violent battery failure.

When a protective device is used in a battery system, the trip setpoint should be chosen to compromise between service continuity and possible battery system damage. High currents of sufficient duration may cause damage to cable insulation, conductor material, battery posts, battery intercell connectors, battery post seals, and battery cell covers. For example, an overcurrent protective device may be selected with a time-current characteristic just below that of the weakest element in the circuit.

### 5.2 Overvoltage and undervoltage protection

Overvoltage and undervoltage protection of lead-acid, nickel-cadmium, vented, and valve-regulated batteries is sometimes overlooked by the designer of the dc system. For the effects of overvoltage and undervoltage protection on other dc components, refer to IEEE Std 946-1992. Batteries can withstand moderate overvoltage and undervoltage for short periods of time. If a lead-acid battery is subjected to a prolonged undervoltage there may be heavy sulfation on the plates, which may be difficult to reverse. Loss of battery capacity will occur as a result of heavy sulfation on the plates of lead-acid batteries. If a battery is subjected to a prolonged or frequent overvoltage it can age more quickly and damage can possibly occur.

Undervoltage protection of the battery is desired when the battery charger is both energized and de-energized. If the charging voltage drops below the minimum recommended float voltage for the battery, the battery will not receive sufficient charging current to offset internal losses (self discharge), resulting in a gradual loss of capacity.

If the battery charger is de-energized, the battery will then power the load(s), which will eventually cause the battery voltage to drop below a level such that

- The dc system loads can no longer function; and/or
- The battery has exhausted its capacity and may suffer damage.

Overvoltage on a battery is a long-term charging voltage higher than the recommended float voltage for the battery. Under these conditions, the battery will

- Age at an accelerated rate;
- Accelerate the dryout process (in valve-regulated battery cell designs) potentially resulting in thermal runaway;
- Generate heat;
- Generate increased amounts of hydrogen gas; and
- Deplete fluid.

For attended stations or facilities, the usual practice is to only alarm undervoltage and overvoltage conditions. This is acceptable because batteries are the last line of defense in the emergency backup system, the failure modes occur over a long time period, and trained personnel are available on-site. Overvoltage and undervoltage alarms in these installations can usually be purchased as options for the battery charger and/or be specified as part of the dc system distribution equipment.

For unattended stations or facilities, a voltage sensing device to disconnect the battery from its loads can be used as protection from over discharging and irreversible damage. The designer of the dc system will need to evaluate and compare the risk of damage to the battery or the system when considering this option.

The battery charger design should incorporate a high-voltage disconnect that shuts off the charger should component failure result in high-voltage output. Battery chargers may have blocking diodes to prevent discharging through the charger.

### 5.3 Grounding

The term *grounding* is commonly used in electric power systems to include both *system grounding* and *equipment grounding*.

- a) A *system ground* is a connection from one of the current-carrying conductors of a system to ground.
- b) An *equipment ground* is a connection to ground from one or more of the non-current-carrying metal parts of the system or apparatus connected to the system (such as electrical raceways, the enclosures of distribution system equipment, motor frames, and other load enclosures).

The objectives of both of these parts of the grounding system are to provide protection for personnel and equipment and to provide a fault clearing path.

#### 5.3.1 System grounding

There are two types of dc systems—grounded and ungrounded. In practice, both grounded and ungrounded systems are used extensively, with certain industries preferring one type over the other. The following definitions from IEEE Std 142-1991, though intended for ac systems, are applicable to dc systems as well:

- a) *Grounded system.* A system of conductors in which at least one conductor or point is intentionally grounded, either solidly or through a non-interrupting current-limiting device.
- b) *Ungrounded system.* A system, circuit, or apparatus without an intentional connection to ground except through potential-indicating or measuring devices or other very-high-impedance devices.

A grounded dc system provides a low-impedance path for fault currents, enhancing fast operation of protective devices to isolate the faulted branch to protect personnel and equipment.

A low-resistance ground fault on one of the polarities of an ungrounded dc system will not affect operation of the system, thus increasing system reliability and continuity of service. This benefit of an ungrounded dc

system is most easily understood for the case where a ground fault occurs on a feeder conductor to a dc bus or subpanel from which multiple circuits are fed. When contemplating the use of an ungrounded system, the requirements of applicable codes shall be considered. In general, when an ungrounded system is used, a ground fault detection system is prudent in order to identify and isolate ground faults.

### 5.3.2 Equipment grounding

Electrical equipment frames/enclosures are usually grounded. In industrial and power plants, electrical equipment is located in many different locations throughout the plant. Typically, electrical equipment frames/enclosures are grounded to nearby building steel (columns, frames, etc.) with electrical conductors. The building steel members and electrical raceways are electrically connected together via the plant grounding system for protection of personnel and equipment. A detailed description of this type of system is provided in IEEE Std 142-1991.

In telecommunications, electrical equipment frames/enclosures are frequently electrically isolated from nearby building steel and electrical raceways by conductors routed to a central "ground window" (isolated systems). An alternative is a combination of the above two techniques (integrated systems). A detailed description of these types of systems is provided in ANSI T1.311-1991.

### 5.4 Temperature compensation and current limiting

Elevated operating temperatures lower cell voltage for a given charging current, and raise charging current for a given voltage. Under constant potential charging, this results in higher rates of gas evolution and more heat to dissipate. If the rate of heat generation exceeds the rate of heat dissipation, the cell temperature will rise, resulting in more charging current to maintain the float voltage. The additional current causes the temperature to rise further, resulting in a further increase in the charging current, and so on. Normally associated as a failure mode with valve-regulated lead-acid (VRLA) cells, the net effect of this thermal runaway condition can be melting of the battery. (See IEEE Std 1187-1996 for more information on thermal runaway.)

The risk of this very dangerous phenomenon can be significantly reduced by controlling temperature and providing adequate ventilation (see Clause 9), and limiting charging current. Two popular means of limiting charging current are temperature compensation and charge current limiting. Temperature-compensated chargers sense the ambient temperature or battery temperature (preferably the latter), and adjust the charging voltage based on this temperature. As the temperature increases, the charging voltage is lowered. This effectively limits the current flowing into the batteries, and helps to prevent thermal runaway. The current flowing into the batteries can also be controlled by placing a charge current-limiter between the battery and battery charger. This device limits the charging current, but not the discharge current, and also helps to prevent thermal runaway.

Strong consideration should be given to the use of one or both of these techniques with VRLA batteries, especially those located in "unconditioned" environments (no air-conditioning).

## 6. Batteries

In a dc system, the battery is considered a finite source of power. The dc current delivered by a battery under fault conditions is dependent on the resistance of the battery and the circuit resistance between the battery terminals and the fault. If the circuit resistance is very low, large batteries can discharge up to 40 000 A for several seconds.

A battery stores electrical energy by virtue of the chemical reactions taking place at the electrodes (plates). The electrical energy that a battery can supply depends on the amount of chemical energy it contains and its ability to convert chemical energy to electrical energy.

A short circuit of a storage battery initiates rapidly changing high currents and high-voltage drops within the system. These conditions result in transient currents that dissipate rapidly to a steady-state level. The following parameters are important to the transient and steady-state response of a battery under short-circuit conditions:

- a) Electrochemical response of the battery;
- b) Internal and external circuit resistance of the battery;
- c) Inductance of the battery and the circuit;
- d) Capacitance of the battery.

### 6.1 Lead-acid batteries

Excluding the impedance of the short-circuit path, the magnitude of a lead-acid battery's output current under fault conditions is dependent on the battery's resistance. The resistance is a result of many design variables, such as

- a) Separator material and porosity;
- b) Spacing between the plates;
- c) Specific gravity of the electrolyte;
- d) Surface area of the plates; and
- e) Conductivity of the plates, connecting straps, terminal posts, and intercell connections.

Therefore, the maximum short-circuit current that a battery can deliver, assuming a zero impedance fault, is based on a battery's resistance and the effective emf of the battery. The total resistance of the battery is equal to the sum of the internal resistance of the series-connected cells, plus the resistance of the intercell connections.

Other factors affecting the resistance of the lead-acid battery are its state of charge and to a lesser extent, its age. Lead sulfate, which forms on the plates during discharge, is a non-conductor, and increases the internal resistance of the cell. At the same time, the loss of sulfate ions from the electrolyte reduces the electrolyte's conductivity and increases the cell's resistance. The resistance of a battery increases during the discharge, and can be two to three times the initial resistance at the end of the anticipated duty cycle. As the lead-acid battery ages, the corrosion process acting on the grid structure of the positive plate increases its resistance to current flow. VRLA batteries also experience progressive water loss, leading to a corresponding increase in internal resistance.

### 6.2 Nickel-cadmium batteries

As with lead-acid batteries, the magnitude of a nickel-cadmium battery's output current during fault conditions is dependent on the internal resistance of the cell. This resistance is the result of design variables, such as

- a) Separation between the plates;
- b) Surface area of the plates; and
- c) Conductivity of the plates, connecting straps, terminal posts, and intercell connections.

Unlike lead-acid batteries, the alkaline electrolyte, an aqueous solution of potassium hydroxide, does not enter into the electrochemical reactions. Instead, it merely acts as an ionic conductor of uniform resistance. Consequently, the specific gravity does not change with the state of charge, and internal resistance during discharge will not increase as much as in a lead-acid cell. This means that even when fully discharged at the end of its anticipated duty cycle, the nickel-cadmium battery will still have a substantial short-circuit current available.

### 6.3 Battery voltage characteristics during short-circuit conditions

When a short-circuit discharge begins, there is a sudden decrease of voltage at the battery terminals because of the voltage drop through the resistance, and then a gradual decrease in voltage caused by chemical changes occurring at the surface of the electrodes, as shown in Figure 1. The chemical changes within the battery produce a counter emf called polarization. This polarization can be approximated as a capacitance shunted by a leakage resistance. The capacitance is responsible for the initial slope of the voltage curve, while the leakage resistance is responsible for the curvature of the line. The subsequent slope can be approximated by using the time constant of the circuit.

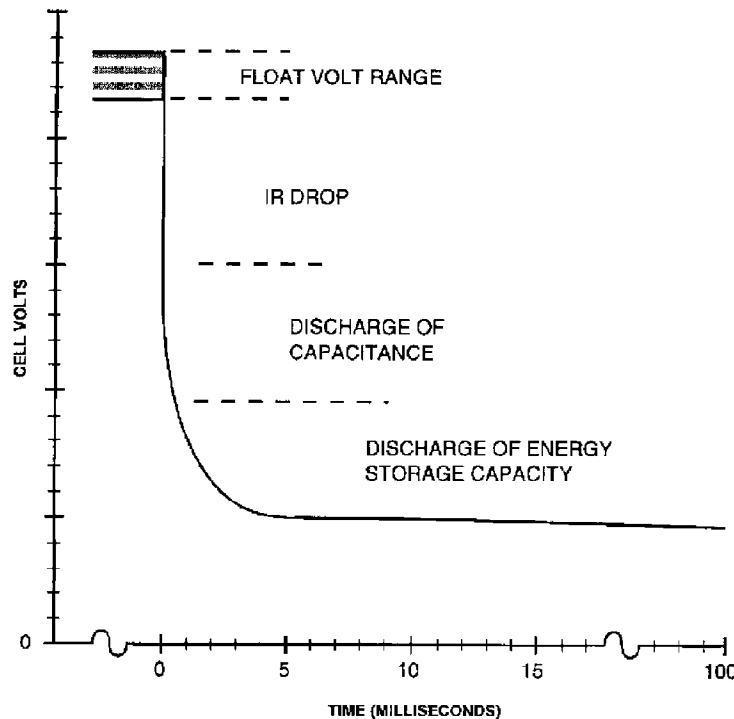

Figure 1—Lead-acid battery typical initial voltage characteristic during short circuit

### 6.4 Battery current characteristics during short-circuit conditions

The transient and steady-state currents are interpreted in terms of resistance, capacitance, and inductance of the battery and external circuit network. The transients from capacitance and inductance are influential typically during the first 15 ms after the short circuit is applied. After this time, the steady-state current is determined primarily by the resistance network of the battery and the external circuit, as shown in Figure 2.

The battery and battery circuit possess a measurable inductance, which has the effect of slowing down the rise of current when a short circuit is applied to the battery, and can be a significant factor when cables are employed in the circuit as intercell connectors. When a battery is subjected to a short circuit, the time constant is on the order of 1–3 ms for a fault at the battery terminals. Depending on the circuit inductance, the current will rise rapidly to a peak value within 5–15 ms.

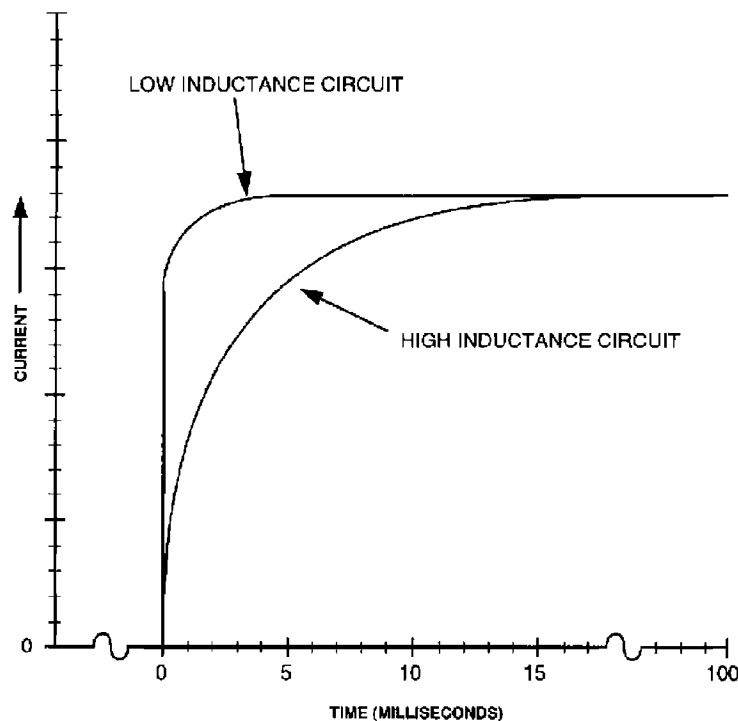

Figure 2—Lead-acid battery typical initial current characteristic during short circuit

### 6.5 Battery withstand capability during short-circuit conditions

From the battery's perspective, a short circuit is nothing more than a very high rate discharge through a constant resistance load (neglecting resistance changes due to temperature increase). After approximately 0.1 s, the battery voltage remains relatively constant for several seconds, then slowly declines as the transport of electrolyte to the reacting zones of the electrodes becomes limiting. From this point on, the current also declines with the voltage in accordance with Ohm's Law (see Figure 3).

#### 6.5.1 Lead-acid batteries

The length of time a lead-acid battery can deliver current of the magnitude available under short-circuit conditions is dependent on the impedance of the fault and the design of the battery cell. The current-carrying capability of individual cells and multi-cell units of less than 200 Ah ratings is generally limited by the size of their terminals and connectors, which have small cross-sectional areas and are often made of lead or lead alloy. Given the high current density resulting from a low-impedance short-circuit discharge, these components are not able to dissipate the energy being generated, and in extreme cases, the temperature rise in the component can exceed its melting point within 10 s. On the other hand, larger cells, and particularly those designed for high discharge rate applications (i.e., those designs that feature copper inserted terminals and thick copper intercell connectors), can withstand the short-circuit current for several minutes, or even the duration required to completely discharge the battery.

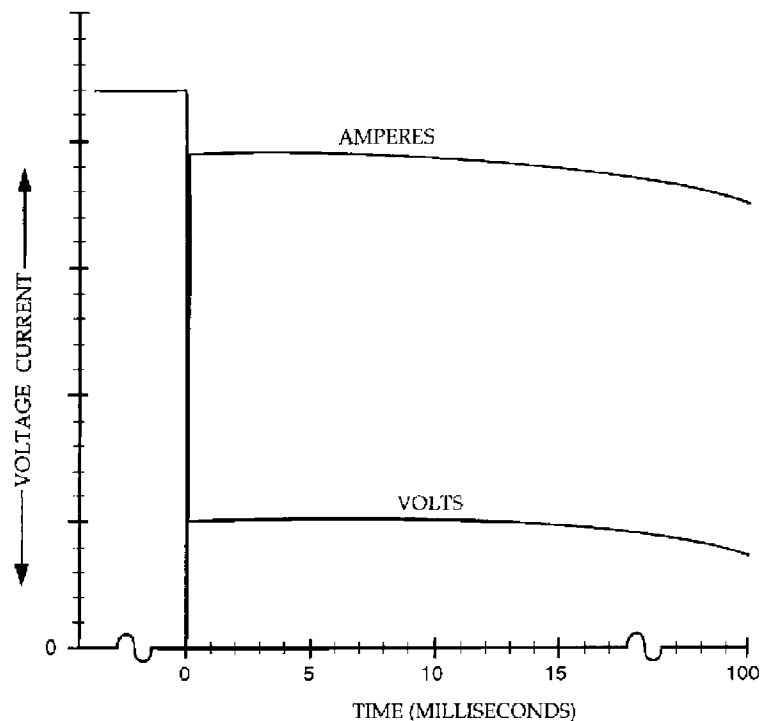

Figure 3—Lead-acid battery typical long duration characteristics during short circuit

### 6.5.2 Nickel-cadmium batteries

Nickel-cadmium battery cells employ nickel-plated steel for the conducting parts. The plates in the cell are bolted or welded to the current collectors and the cell terminals. The use of these strong, highly conductive metals allows the battery to withstand fault conditions for longer durations than comparable lead-acid batteries.

## 6.6 Environmental and operational effects on battery short-circuit current

### 6.6.1 Effect of elevated temperatures on battery short-circuit current

#### 6.6.1.1 Lead-acid batteries

It is well established that the discharge capacity of a lead-acid battery increases with temperatures above 25 °C (77 °F) and decreases at temperatures below this value. At temperatures greater than 25 °C under normal discharge conditions, the conversion rate of chemical energy to electrical energy is improved, primarily due to the higher rate of electrolyte diffusion at the plate surfaces, and lower electrolyte resistivity. This results in the battery maintaining a higher voltage throughout the discharge, and consequently, a longer reserve time. Under short-circuit conditions at electrolyte temperatures greater than 25 °C, there is no significant increase in electrical energy because the conversion process cannot keep pace with the rate of current being discharged. Over the short duration that the battery discharges into a short circuit, the resistance of the current-carrying components determines the output current. Tests indicate that an increase in electrolyte temperature above 25 °C will have no appreciable effect on the magnitude of short-circuit current delivered by a lead-acid battery.

### 6.6.1.2 Nickel-cadmium batteries

Nickel-cadmium battery discharge capability is increased only slightly as electrolyte temperatures rise above 25 °C. As with lead-acid batteries under short-circuit conditions, the current is limited by the resistance of the current-carrying components. Therefore, an increase in electrolyte temperature will not significantly increase the magnitude of the short-circuit current that a nickel-cadmium battery is capable of delivering.

### 6.6.2 Effects of charging voltage on battery short-circuit current

To maintain a standby battery in a fully charged condition, the battery is connected to a charger having an output higher than the nominal battery voltage. This allows a small charging current to flow through the battery, compensating for inherent self-discharge losses. This higher voltage does nothing to increase the chemical energy available from the battery; however, during the first 0.5 s of a short circuit, the magnitude of the short-circuit current may be affected to a small degree by the initial battery voltage (i.e., float or equalize). Test results indicate that higher than nominal battery voltage may produce a slight increase (on the order of 1%) in the initial short-circuit current. This increase is not proportional to the increase in battery voltage, and disappears in less than 1 s.

## 6.7 Damage and failures of batteries

If properly maintained and operated, the battery is a very dependable and trouble-free device. The failure of the battery can be attributed to both internal and external failure mechanisms (internal failure mechanisms are considered failures of the stationary battery, including battery cells and their intercell connections).

The consequences of a battery system failure will be different for each individual application. For example, in the telecommunications industry, the considerations of the failure of a telecommunications switch will include possible hardware and software damage, interrupted revenue streams, and the cost of fault correction and restoration. Likewise, the failure of a vital dc system in a generating station may result in the false actuation or loss of the safety systems. Further, the loss of a battery in a power substation could result in the inability to trip faulted ac feeders. The designer of the dc system should first define the operability and maintenance requirements and capabilities of the system before attempting to design the protection requirements of the system. The following factors should be considered when attempting to define these characteristics:

- a) The ability to alarm and monitor to predict the failure/degradation of the dc system;
- b) The ability to restore power to the dc system from an alternate dc source or by correcting the cause of failure and restoring the power source;
- c) An evaluation of the possible failure modes and the associated postulated consequences due to a failure of the system or a malfunction of a component (e.g., protective device failures) in the dc system.

A facility in which there is continuous monitoring of the equipment following the recommendations of Table 2 of IEEE Std 946-1992, and a trained electrical maintenance staff, would require less automatic protection of the system than would be required in a non-manned installation. This is due to the fact that the battery would be regularly maintained in accordance with IEEE Std 450-1995 or IEEE Std 1188-1996 and surveillance testing would help predict failure prior to its occurrence. In addition, the staff would be available to take immediate corrective action to clear the fault, limiting damage to the system.

The ability to restore power to the dc system from an alternate dc source provides the user with equipment protection, additional time to clear the fault, and the ability to restore the system while minimizing downtime. This can be accomplished through redundant dc systems (battery-charger switchboard) or redundant components (battery or charger), or through alternate feeds from independent dc systems. In considering the ability to recover from a faulted situation, the designer should also consider the equipment's capability to be reset or the availability of spare parts (e.g., fuses) and the associated time to replace those components.

### 6.7.1 Internal failure mechanisms

Internal failure mechanisms common to both lead-acid and nickel-cadmium batteries are as follows:

- Container failures which entail the cracking of the container and the subsequent loss of electrolyte and loss of seal around posts, particularly for VRLA cells.
- Cell internal and external terminations and connections can cause degradation of the batteries' performance and subsequent failure. Loose or corroded (dirty) connections can lead to higher resistance points and subsequent higher voltage drops and "hot spots." If left undetected, these "hot spots" can eventually lead to arcing and under the correct combination of hydrogen gas and oxygen concentrations can result in an explosion. The high temperature at these "hot spots" can also result in the melting of the lead posts on lead-acid batteries.
- Material contamination can lead to reduction in battery capacity and the deterioration of the plates and posts (e.g., copper contamination for lead-acid cells).

Internal failure mechanisms specific to vented lead-acid batteries are as follows:

- Expansion and corrosion of the plate group due to oxidation of the grid and other current-carrying components.
- Loss of active material from the positive plate.
- Physical changes in the material (sulfation) of the plates which result in loss of capacity.

Internal failure mechanisms specific to valve-regulated batteries are as follows:

- Dryout of the cell.
- Thermal runaway.

Internal failure mechanisms specific to vented nickel-cadmium batteries are as follows:

- Gradual aging and degradation of the active materials in the plates. The degradation in the plates is due to the recrystallization of the nickel hydroxide in the positive plates.
- Carbonation of electrolyte (see IEEE Std 1106-1995).

### 6.7.2 External failure mechanisms

The following are external failure mechanisms common to both lead-acid and nickel-cadmium batteries:

- a) Personnel errors during operation, maintenance, and testing;
- b) Defective procedures or setpoints;
- c) Charger malfunction;
- d) DC system faults (short circuits) [see 6.7.3].

### 6.7.3 Battery failure modes under fault conditions

In an uncontrolled short-circuit situation, the battery cell or the cell connections can melt, sometimes with dramatic results and possibly disastrous consequences for the battery and its surrounding environment. Potential weak links in the current path and the consequences resulting from failure are described below.

It should be noted that the failure modes described below can occur in both lead-acid and nickel-cadmium batteries, but have a much higher probability of occurrence in lead-acid batteries due to the materials of

construction. The only credible failure modes under fault conditions for nickel-cadmium batteries involve cable connectors and the plastic cover/container.

- a) *Failure of the plate-to-connecting strap weld.* In valve-regulated batteries (particularly where the post seal, or jar to cover seal is compromised and the outside atmosphere is allowed to enter the cell), there is no free electrolyte to quench a resultant arc when the strap pulls away from the plate, and there is the possibility of igniting the hydrogen gas in the cell.
- b) *Failure of the terminal post.* In both vented and valve-regulated cells, the terminal can melt, either above or below the cell cover. The resultant arc or heat can ignite the cell cover and/or the hydrogen in the head space beneath the cover.
- c) *Failure of the intercell connection.* In both vented and valve-regulated cells, the consequences of this type of failure depends on the type and material of the connection, and the system voltage. Connectors outside the cell simply melt, opening the battery circuit. As the nominal system voltage increases (i.e., 24 V dc, 48 V dc, 125 V dc, etc.), the possibility of a sustained arc increases, resulting in a higher probability of cell cover, or hydrogen gas, ignition. Failed intercell connections that are inside the container (generally found in small, multi-cell valve-regulated batteries) have the same impact as the loss of the plate-to-strap weld.
- d) *Failure of the terminal lug connection.* The heat generated in cable connectors of either lead-acid or nickel-cadmium batteries can melt the insulation and the solder in terminal lugs.
- e) *Failure of the terminal post.* Copper or steel bar connectors outside the cell normally will not fail. However, the heat generated at the connector/terminal interface can result in failure of the terminal post of lead-acid batteries. In nickel-cadmium batteries, the cell cover can be compromised due to heat transfer from the steel terminal post.

The above failure mechanisms can have varying consequences that can result in a catastrophic failure (loss of service) of the battery.

## 7. Characteristics of other dc system components

This clause is intended to provide the stationary battery system designer with the background knowledge necessary to make prudent design decisions. Specific guidance is provided in Clause 8.

### 7.1 Battery charger short-circuit characteristics

When a charger is presented with a sudden fault at its output terminals, it provides fault current in short-term, mid-term, and long-term periods.

The short-term fault contribution comes from energy stored in the capacitive output filter elements. Mid-term current is the short-circuit output of the charger with no current limit. The long-term fault current is the steady-state output current of the charger under short-circuit conditions (current limit for chargers equipped with current-limiting capability).

Whether a charger actually produces the mid-term and long-term fault currents depends on whether output fault protection, if present, clears during the short-term fault current.

The magnitude and duration of currents in each period depend on several factors including the following:

- a) Charger types (SCR, controlled ferroresonant, etc.);
- b) Whether the charger is filtered;
- c) If filtered, the filter network design and degree of filtering;

- d) Response time of the current limit control circuit, if included;
- e) Coordination and clearing time of protective device(s).

Refer to IEEE Std 946-1992 for the short-circuit contribution of the battery charger and its impact on the overall dc system design.

### 7.1.1 Charger types

The power conversion technology of a battery charger can be divided into two groups—those that are inherently current limited and those that require some sort of limiting impedance or control. A discussion of the commonly available battery charger types follows.

- a) Ferroresonant and controlled ferroresonant chargers are inherently current limited, normally to between two and three times the rated output current of the charger. The mid-term and long-term fault currents are the same.
- b) Phase-controlled SCR chargers have only minor inherent current limiting from the dc circuit resistance and a minimal ac circuit impedance. However, an electronic current limit circuit is usually added to control the behavior of the phase-controlled SCR charger during short-circuit conditions. The response time of a current limit circuit to a severe overcurrent is at least 1/2 cycle at line frequency, and may be as long as 100 ms.
- c) The mid-term fault current, which lasts until the current limit circuit is effective, is limited by the circuit resistance and leakage reactance. Typical values for mid-term current are 5 to 20 times the rated charger output current.
- d) Magnetic amplifier chargers are similar to SCR chargers, but the inherent current limit is lower, due to higher reactance in the ac circuit. The response time for the current limit circuit is the same.
- e) High-frequency switch mode power supply (SMPS) chargers have only minor inherent current limiting from the dc circuit resistance and a minimal ac circuit reactance. A very fast current limit circuit (significantly faster than other types available) is used to protect the switching transistors.

### 7.1.2 Effects of filtering

A variety of dc low-pass filter configurations is used in the output circuits of battery chargers. Most consist of series inductance and parallel capacitance. Filters usually are one- or two-stage filters. Not all filtered chargers have an output capacitor, but one is usually present in battery eliminator filtered chargers.

When a fault occurs at the charger output terminals, the output capacitor discharges through the output fuse or circuit breaker. The duration of this short-term fault current is generally on the order of microseconds. The resulting peak current is a function of the output voltage before the fault and the total series resistance in the output circuit. The series resistance is the sum of the capacitor effective series resistance (ESR), the wiring resistance, and the resistance of any other components, such as fuses or circuit breakers. The waveform is exponential, with the time constant a function of the capacitance and series resistance.

Other capacitors in the filter circuit discharge through the series inductors into the fault, resulting in lower peak currents and longer time constants. The total charge delivered to the fault can be calculated from the values of the filter components.

### 7.1.3 Current limit control

The dc output current of ferroresonant chargers is inherently current limited by the design of the transformer. Other conversion types require some form of electronic current limiting. The current limit control of phase-controlled chargers typically responds in several cycles at the line frequency. Newer designs for output current limiting in phase-controlled chargers generally respond in one-half to one cycle.

During the mid-term period, before the current limit circuit is effective, the charger delivers a current to the fault that is limited only by the circuit resistance and ac leakage reactance. The maximum current may range from 5 to 20 times the normal rated output current of the charger.

#### 7.1.4 Protective devices in the output circuit

One or more fuses are usually provided in the output circuit of a battery charger. The fuse is sometimes a fast-clearing, semiconductor type. A consequence of using a fast-clearing fuse is that it may also clear on the discharge of the charger filter into a fault on the dc bus.

Circuit breakers provide resettable protection and the convenience of a manual switch, along with long-term overload protection. For large fault currents, they are usually slow, clearing in about 15 ms for very large fault currents, to as long as 1 s for moderate faults. A charger equipped with a properly rated output circuit breaker instead of fuses has a better chance of surviving the initial filter discharge, and reaching its current limit output.

### 7.2 Characteristics of fuses in dc circuits

In the past, ac rated fuses have been traditionally applied in dc circuits using one-half their ac voltage rating (i.e., a fuse rated at 600 V ac was considered to have a voltage rating of 300 V dc). In some cases this led to misapplication of fuses in dc circuits. While this practice may be valid for a particular class of fuse whose dc circuit performance has been verified by testing, the principle cannot be applied to all fuses. The following subclauses discuss the fundamentals governing the construction and performance of fuses.

#### 7.2.1 Principles of fuse design

The satisfactory performance of fuses in dc circuits depends on the selection of a fuse with characteristics suitable for the circuit parameters. The required characteristics are substantially different for dc circuits as opposed to ac circuits. This discussion defines the required characteristics of cartridge fuses rated up to 600 V dc used for the protection of stationary batteries.

Standard types of power fuses up to 600 V are UL Listed for dc operation under UL 198L-1995, which is the basic UL dc fuse standard, and/or UL 198M-1995, which is the dc performance standard required for certification by the Mine Safety and Health Administration (MSHA) for use belowground in mines.

The two standards differ only in detail. Fuses that meet the requirements of UL 198M-1995 also meet the requirements of UL 198L-1995, but the reverse is not true. Since there is a cost involved in maintaining UL listings, manufacturers may choose to list only under UL 198M-1995.

##### 7.2.1.1 Fuse link construction

Fuse links in modern fuses are usually copper or silver, although some compound fuse links have been developed. Fuses with smaller ratings may contain only a single link. Larger ratings, or other designs, may contain multiple parallel links, in some cases more than 100 parallel links, where each link is a parallel path for the current flowing through the fuse. For the sake of simplicity, this discussion will be limited to fuses with single links. The performance of fuses with parallel links is identical except for the division of current between the parallel paths.

In order to control the point at which the fuse links melt on overcurrent, fuse links have one or more narrowed sections termed bridges or "weak spots." Since the bridges have higher resistance than the rest of the link, and because current flow is concentrated at the bridges, the bridges operate at a higher temperature than the rest of the link. The fuse designer determines the location, number, and shape of the bridges in a fuse link, based on desired performance. Bridges may take the form of one or more circular or rectangular holes, or may consist of notches of various shapes cut into the edges of each fuse link. See Figure 4.

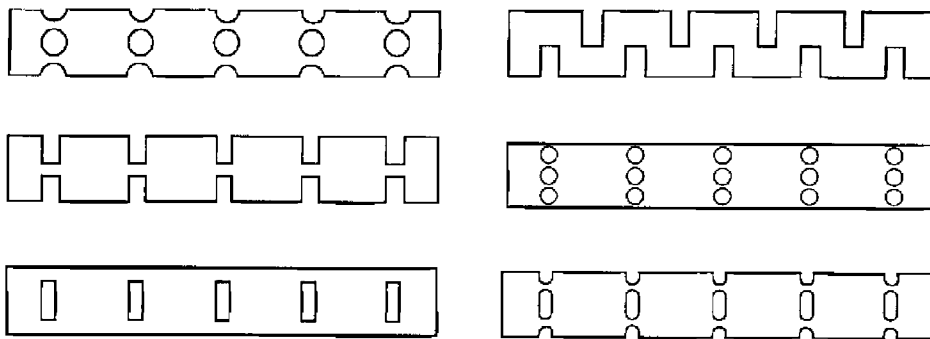

Figure 4—Typical bridges used in fuse link construction

There may be several bridges in parallel at one point in a fuse link. For all practical purposes, these bridges open simultaneously; therefore, for discussion purposes, they will be referred to as a single bridge. Fuses with voltage ratings of less than 100 V and those with very low ampere ratings may have bridges at only one point in the fuse link. Higher voltage fuses and those with larger ampere ratings have two or more bridges in series. The number of series bridges in a link is governed primarily by the voltage rating of the fuse and whether the fuse is designed for ac or dc operation.

#### 7.2.1.2 Time-delay fuse design

Time delay may be built into a fuse to enable it to carry motor and transformer inrush currents, as well as harmless temporary overloads. Fuse designers accomplish time delay in several different ways. Since time-delay fuses have to pass the same sustained overload tests of non-time-delay fuses, time delay is only effective for given overcurrents for a short period of time. Standard types of power fuses shall carry 500% rated current for a minimum of 10 s. Currents over five or six times rated current cause the fuse to open quickly.

In single element designs, heat sink(s) are added to the basic fuse link. The heat sink absorbs and dissipates the heat resulting from transient overcurrents. When higher currents occur, indicating a fault, the heating occurs so rapidly that the heat sink cannot delay opening of the fuse link(s). Dual-element time-delay fuses incorporate a totally separate element to provide time delay and open currents up to 500–600% rating. The other element will clear currents above 500–600% rating. They are termed dual-element fuses. These designs also incorporate a heat sink of some type to provide time delay; however, rather than melting the basic fuse link on low-value overcurrents, these designs melt a eutectic alloy (an alloy with a specific melting point). Since the melting point of the eutectic alloy is much less than the basic silver or copper fuse link, the clearing characteristics of dual-element fuses provide a slower opening of the fuse at low overload currents. Higher values of current cause the fuse link bridges to open as previously described. Both types of time-delay fuses have been successfully UL Listed for dc service.

#### 7.2.1.3 Current-limiting fuse design

UL Classes R, L, J, T, and CC are UL Listed as current-limiting fuses. Other fuses such as fuses for semiconductor protection are also current limiting, but are not labeled as such since they do not fall into a particular UL Class. For a fuse to be labeled current limiting, it has to have unique dimensions or a rejection feature that matches with fuseholders which will reject fuses of other dimensions or which do not have a matching rejection feature.

In ac circuits, current-limiting performance is defined as opening a circuit within 180 electrical degrees (one-half cycle) and limiting the peak current through the fuse to a value less than would flow if the fuse were

replaced with a conductor having the same impedance. In order to do this, the fuse has to be "zero-forcing," i.e., it has to be capable of forcing a rapidly rising current to zero without waiting for zero voltage to occur. As current increases, melting time decreases rapidly, and a point is reached where the fuse just becomes current limiting. The value of current where this occurs is called the threshold current. The range of currents from the threshold current to the interrupting rating of the fuse is termed the current-limiting range or zone.

In dc circuits, current-limiting performance is not defined by industry standards. However, dc rated fuses may exhibit current-limiting characteristics when interrupting short-circuit currents.

When a fuse is opening a circuit within its current-limiting range, the thermal characteristics of the fuse are within the adiabatic range, i.e., the heat generated by current flow through the fuse's resistance is generated so quickly that the fuse link has begun to melt before the heat can be dissipated by convection, conduction, or radiation. Under these conditions the melting  $I^2t$  of the fuse is approaching a constant.

## 7.2.2 Principles of fuse operation

During "normal" circuit conditions, when the fuse is operating within its rating, the fuse acts as a conductor. The only voltage across the fuse, from one end to the other, is that caused by voltage drop due to the resistance of the fuse. This voltage drop is in the millivolt range. When one or more of the bridges open due to current flow, arcs are drawn across each open bridge. The voltage across the fuse now equals the voltage drop caused by the total arc resistance. When the fuse has interrupted current flow, the voltage across the fuse equals system voltage. When several series bridges in a link open, creating several arcs in series, voltage drop is divided about equally across each open bridge. Fuse designers generally hold the voltage drop across each bridge to less than 150 V for an ac fuse and 100 V for a dc fuse. Therefore, a 600 V fuse link might have about 5 to 7 series bridges, while each link in a 5000 V fuse could have about 35 to 50 bridges.

### 7.2.2.1 Fuse current ratings

General fuse design is based on sound engineering principles. However, the design of fuses with specific characteristics is very empirical. Fuses obey the laws of thermodynamics. The rated current assigned to a fuse is determined in specific test circuits established by UL. Fuses are tested in the open air at a temperature of 25 °C. The test circuit also establishes the wire length and size connected to the fuse block for each fuse ampere rating. The test circuit creates a specific thermal environment. Under these conditions, all standard low-voltage fuses 600 A and smaller such as UL Class H, K, RK1, RK5, and J shall carry 110% of their rated current for a minimum of 3 h. Maximum opening times at 135% rated current, and for some fuses at 200% rated current, are also part of the standard. While the above types of UL Listed fuses are subject to these tests, those fuses that indicate time delay on their labels are subjected to an additional test; they shall carry 500% rated current for a minimum of 10 s. Actually, as fuse ampere ratings increase, time delay at 500% rated current usually increases.

Midget fuses and electronic fuses that are marked time delay have different standards. Time-delay miscellaneous fuses listed under UL 248-14-1994 and time-delay Class CC fuses listed under UL 248-5-1996 shall carry 200% of rated current for a minimum of 12 s. Electronic fuses (UL miniature and micro fuses) have varying amounts of time delay and users should refer to each fuse's specifications. Fuses may require derating when applied in the field since thermal characteristics of the application may differ from the test circuit.

Other things (such as bridge design) being equal, the center bridge in each link operates at the highest temperature since the heat generated by the resistance is primarily conducted to the fuse ends where it bleeds off into the circuit components. This normally causes the center bridge to open first when the fuse is lightly overloaded. Other methods of causing the fuse to open at a particular bridge are increasing its resistance by reducing the area of the bridge(s) and/or providing an overlay of a material with a low melting point. When current flow raises the temperature of the bridge higher than the melting point of the overlay, the overlay melts and molecules of the overlay begin to migrate into the fuse link at the bridge. The amalgamation rapidly causes an increase in the resistance of the bridge, elevating its temperature, causing it to melt.

### 7.2.2.2 Fuse operation on light overcurrents

If the fuse opens on a light overcurrent, only one bridge may open. An arc develops at this gap causing the fuse link to burn back, increasing the length of the gap. The arc resistance causes a voltage drop across the arc, and as the gap increases, voltage drop increases. Arcing continues until the voltage drop across the arc is equal to the applied voltage, at which time the arc is extinguished. Depending on fuse design, voltage rating, interrupting rating, and other factors, fuse bodies may be filled with various types of material to help extinguish the arc.

### 7.2.2.3 Fuse operation on larger overcurrents

When larger overcurrents occur, such as are experienced under fault conditions, the bridges are heated so rapidly that multiple bridges melt, creating arcs in series. The total voltage drop divides about equally across each arc. Total arc resistance and voltage drop increase rapidly as the gaps increase in length, aided in most fuses by the effect of fuse fillers. When the total voltage drop is equal to or greater than system voltage, current flow stops.

### 7.2.2.4 Differences in fuse function on ac and dc

Although the fundamental differences between ac and dc are well known, the way in which these differences affect the operation of fuses when they are called upon to interrupt overcurrents has not been widely understood. An RMS ac current has been defined as a current that produces the same heating effect in a given resistor as a dc current of the same magnitude. If, in a given circuit, the fuse is capable of carrying the current (ac or dc) flowing in the fuse, the heat generated within the fuse by its resistance is conducted, convected, and radiated from the fuse until it reaches a thermal balance. If a given current is too large for a fuse to carry (overcurrent conditions), more heat will be generated than the fuse can dissipate, and the fuse link(s) will open. If the fuse has been applied within its rated voltage and interrupting rating, and is rated for the type of current (ac or dc or both), current will be interrupted.

### 7.2.2.5 Fuse operation on ac overloads

When the current is too large for a given fuse to carry continuously, the fuse will open the circuit. If a current 200% of rating is considered, the time required to melt the fuse link will take from 30 s to 200 s or more depending on the type and rating of fuse. The arcing time of the fuse will be less than one-half cycle.

In a 60 Hz ac circuit, one full cycle is 1/60 s or 16.7 ms. Voltage passes through zero every 8.3 ms. In a fuse with an opened link, as voltage decreases toward zero, a point is reached where the instantaneous applied voltage is less than the voltage drop across the arc. Arcing ceases, and in a properly designed fuse it will not restrike as voltage begins to increase.

### 7.2.2.6 Fuse performance in dc circuits

In dc circuits, voltage is sustained and arcing continues until the increasing voltage drop is greater than system voltage. If the fuse is properly designed to handle light dc overcurrents, the current will be extinguished. In some dc fuses, the arc extinguishing filler materials stop the arc; in other designs it is a combination of the fillers and multiple bridges opening in series. If the fuse is not designed to handle small dc overcurrents, the arc is not promptly extinguished. Arcing at the bridge continues, burning back more of the fuse link and increasing arc resistance. This reduces current flow so that the other bridges do not see sufficient current for them to open. If there is sufficient voltage to continue driving the arc, arcing will continue until the fuse link burns back to the ends of the fuse and in some cases burns through the ferrules or end caps. In some cases, the burning fuse link(s) may generate enough pressure from the sustained arcing that the fuse body (tube) may rupture, expelling molten material.

When designing fuses to interrupt dc currents such as those that occur during short circuits, the three important considerations are as follows:

- a) *The energy stored in the system due to inductance.* Inductance in a dc circuit stores magnetic energy ( $U$ ). When a fuse is interrupting an overcurrent, this stored energy is discharged into the system and has to be dissipated by the fuse while it is opening the circuit. Magnetic energy can be determined by the equation:

$$U = \frac{1}{2} Li^2$$

- b) *The highest dc voltage that may appear across the fuse when it is interrupting an overcurrent.* It is important to note that the voltage rating of a fuse is the maximum voltage to which the fuse has been tested. This voltage should never be exceeded (this does not include the transient voltage that may occur during fuse opening). Systems need to be analyzed to determine the highest voltage that may be across the fuse at the time it is attempting to interrupt an overcurrent. For example, fuses with a 250 V dc rating have been used in 240 V nominal voltage circuits where the charging voltage may be 270 V. Under severe fault conditions this could result in fuse failure.
- c) *The characteristics of the fault current in relation to the dc time constant.* As defined by UL 198L-1995, the time constant of a dc circuit is the length of time, in seconds, it takes for the instantaneous current to reach 63.2% of its maximum value (see Figure 5). It is expressed by the equation:

$$\tau = \frac{L}{R}$$

The relationship between instantaneous current and RMS current for different numbers of time constants is shown in Figure 6.

An example of a time constant calculation is given in Annex C.

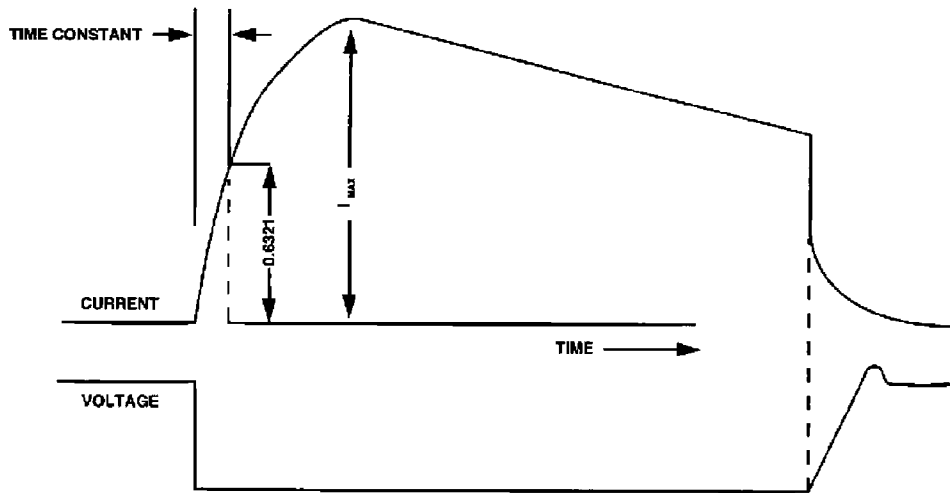

Figure 5—Time constant for dc circuits<sup>a</sup>

<sup>a</sup>Reprinted from Figure 5.1 of UL 198L-1995 with permission of Underwriters Laboratories, Inc.

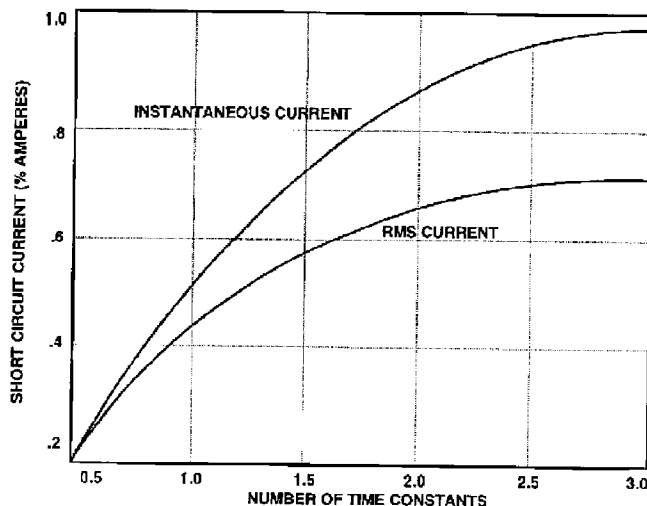

Figure 6—Current as a function of time constants during a dc short circuit

### 7.2.3 DC time constants

When a fault occurs in a dc circuit with time constants of 2.5 ms or less, current increases at about the same rate as would occur in an ac circuit with current of the same magnitude. Fuses will open the circuit in about the same time as they would for an equivalent ac short circuit. However, as time constants increase, especially when they are over 6 ms, current increases more slowly. The fuse is not in the adiabatic range and it is dissipating part of the energy being created by current flow. This increases the melting time of the fuse link significantly. The result is that the entire fuse is heated. Initially, only one bridge may open. As stated before, this increases the fuse's resistance and decreases current flow.

The longer time constants also indicate increased inductance and therefore more stored energy which has to be discharged while the fuse is interrupting the overcurrent. Since the entire fuse has been heated, the fuse filler materials are also heated. At elevated temperatures, filler materials are not as effective at arc quenching. Consequently, unless the fuse has been designed and tested at the longer time constants, the fuse may sometimes be destroyed, with attendant equipment damage.

#### 7.2.3.1 Time constants used in testing for UL 198L-1995 and UL 198M-1995

Interrupting ability tests for UL 198L-1995 are performed with a minimum time constant of 10 ms. Overload testing required by UL 198L-1995 is only at 200% of rated current with minimum time constants as shown in Table 1.

UL 198M-1995 has somewhat more severe testing procedures. Overload tests are performed at 200%, 300%, and 900% of rating plus interrupting ability tests at 10 000 A or more. Minimum time constants used for these tests are shown in Table 2.

The data in this subclause should provide sufficient information for users to understand the importance of the following application guidelines. New applications should follow these recommended practices, and existing installations should be carefully evaluated to determine whether they follow these recommendations. Where they do not, installations should be upgraded whenever possible. A careful evaluation should be made to determine if existing installations are hazardous, and priorities should be established that will correct the most urgent conditions first.

**Table 1—Minimum time constants used for 200% overload testing<sup>a</sup>**

Test current (A)	Time constant (ms)
60	1.7
120	2.1
200	2.5
270	2.7
400	3.0
540	3.3
800	3.7
900	3.8
1200	4.2
1800	4.7
3600	5.8
5400	6.6

<sup>a</sup>Reprinted from Table 5.1 of UL 198L-1995 with permission of Underwriters Laboratories, Inc.

**Table 2—Minimum circuit time constants for overcurrent testing<sup>a</sup>**

Test current (A)	Time constant (ms)
0-99	2
100-999	6
1000-9999	8
10 000 or greater	16

<sup>a</sup>Reprinted from Table 5.2 of UL 198M-1995 with permission of Underwriters Laboratories, Inc.

#### 7.2.4 Selecting fuses for use in dc circuits

- a) The fuse should be rated for use in dc circuits. Whenever possible, fuses should be used that have been certified by a third-party organization that incorporates follow-up testing. If the fuses are UL Component Recognized for dc applications, or are self-certified by the manufacturer (not UL Listed to UL 198L-1995 or UL 198M-1995), the designer should obtain the manufacturers' reports which indicate how the fuses have been tested. Semiconductor fuses may have dc ratings, but are not UL Listed.
- b) Determine the maximum circuit voltage where the fuse will be applied. This will usually be the maximum equalizing voltage from the battery charger. Select fuses with voltage ratings equal to or greater than this voltage. In existing installations, since fuses may have been installed in switches or fuse blocks and holders that prevent the installation of fuses with adequate ratings, an evaluation

should be made to determine if the fuses have an adequate rating for the maximum voltage that could occur at the point where the fuses are applied. If not, switches or fuse blocks and holders that will accommodate the correct fuses should be installed.

- c) Determine the maximum available dc fault current by performing a fault study following the guidelines contained within IEEE Std 946 1992. Fuses should be used that will open quickly enough to protect system components. AC current-limiting fuses that are also dc rated will tend to provide better protection against high-level dc faults.
- d) Determine the time constant, as necessary, of the circuit by determining the L/R ratio where the fuses will be applied (refer to Annexes B and C for a further discussion of time constants). When the fault is close to the batteries, time constants will be short, usually 3–4 ms or less. Long time constants in excess of levels used in UL testing are unlikely for stationary battery systems. The presence of large motors, coils, crane rails, etc. may produce time constants in excess of levels used in UL testing. If so, fuse manufacturers should be contacted to determine if fuses are available with characteristics suitable for the particular application.
- e) Determine the environmental conditions where the fuses will be applied. Although fuses are reliable devices, long time exposure to corrosive fumes, and similar destructive conditions can adversely affect their performance. Fuse cabinets and enclosures should be selected that will protect the fuses from such conditions.
- f) Use time-delay fuses for general-purpose circuits and all individual circuits not requiring fast *overload* protection. Time-delay fuses withstand transient switching surges, inrush currents, and other harmless system surges better than fast-acting fuses. They provide the same protection for sustained overloads as do non-time-delay fuses.
- g) Protect solid-state devices with fast-acting fuses designed for the protection of semiconductors wherever required. If applied on the dc side of rectifiers and similar devices, be sure fuses are dc rated.
- h) Devices, components, and fuse ratings should comply with the requirements of the National Electrical Code® (NEC®) (NFPA 70-1996), although this may not be required for many utility applications. In most cases, UL standards for conductors, control components, switchboards, and similar equipment and devices have been developed and tested to perform satisfactorily when applied in accordance with the NEC. Arbitrary use of smaller wire sizes, overrating contactors, and similar practices lead to early equipment failure, and may lead to nuisance fuse opening from circuit overheating.

### 7.3 Characteristics of circuit breakers in dc circuits

#### 7.3.1 Basic function of a circuit breaker

A circuit breaker is a device designed to open and close a circuit by non-automatic means and to open the circuit automatically on a predetermined current without damage to itself when properly applied within its ratings. In other words, it has two functions. The first is to switch rated current at rated voltage. The second is to sense overcurrent conditions and to operate to open them automatically, providing overcurrent protection.

The typical circuit breaker has a set of contacts that can be switched open and closed using a manual operating handle or an electrical operator. This accomplishes the first function. In a multi-pole circuit breaker, all poles are mechanically linked to open and close together.

The circuit breaker also has a current sensing system for each pole. The sensing system is mechanically linked to a latch. If an overcurrent condition is reached and sustained for the predetermined time delay, the sensing element will cause delatching of the mechanism. The circuit breaker opens automatically by means of energy stored in springs when its mechanism is unlatched. Since all poles are mechanically linked, all poles of a multi-pole circuit breaker open. This accomplishes the second function of overcurrent protection.

After the overcurrent has been cleared, the circuit breaker can be reset (relatched) and is then in a condition to be turned on again. The current sensing system may be contained in an interchangeable trip unit or may be an integral part of a sealed circuit breaker.

As the circuit breaker contacts open under overload or short circuit conditions, an electric arc is formed between them. Typically, in order to extinguish the arc and clear the circuit, the arc is forced into an arc stack of metal plates (arc chute). These metal plates separate the arc into a series of smaller arcs, stretch the arc, and cool it until the level of ionization is reduced sufficiently such that it will no longer sustain current flow. In the ac case, the current passes through a current zero driven by a sinusoidal voltage. In this case, if the degree of ionization is sufficiently low as current normally reaches zero in a sine wave, the arc will not reignite and the overcurrent is cleared. Many designs, especially current-limiting circuit breakers, will force an early current zero such that the circuit breaker does not wait for the normal sine wave period under short-circuit conditions.

In the dc case, the interruption system has to stretch and cool the arc sufficiently to reduce ionization to a point at which the current cannot be sustained. The physical laws are the same as in the ac case except that driving voltage is not sinusoidal and does not cause a normal current zero condition. In most cases the circuit breaker itself is the same as in the ac case. Even though the same circuit breaker may be used for ac and dc applications, correlation between ac and dc ratings cannot normally be established and testing is the only way to verify interruption performance.

### 7.3.2 Types of circuit breakers

#### 7.3.2.1 Molded case circuit breaker (MCCB)

An MCCB is a circuit breaker that is assembled as an integral unit in a supportive and enclosing housing of insulating material. Typically, MCCBs are rated 10 A to 2 000 A, 600 V or lower, and are operated by a toggle mechanism. They are tested to UL 489-1991.

MCCBs typically can have either fixed or adjustable time-current characteristics. They are used predominantly on smaller battery installations. Auxiliary switches can be added for alarm and position indicating functions. Typically, MCCBs are not remotely operated unless a motor operator or a shunt trip is installed.

#### 7.3.2.2 Low-voltage power circuit breaker (LVPCB)

An LVPCB is a circuit breaker rated for use on circuits rated 1000 V ac and below or 3000 V dc and below, but not including MCCBs. LVPCBs are typically in larger frame sizes from 400 A to 6000 A. They generally have a two-step stored energy mechanism. They are tested to the ANSI C37 series of standards.

LVPCBs typically have adjustable time-current characteristics that allow them to be more flexible when the system characteristics change. They typically have high short-time withstand and interrupting ratings and are used predominantly on large battery installations where the available fault currents are relatively high. LVPCBs are also ideal for those applications where remote control of a main bus breaker or a bus tie breaker is desired. LVPCBs can be easily coordinated with downstream circuit breakers. Auxiliary switches can be added for alarm and position indicating functions.

The physical size of power circuit breakers requires a large enclosure to house the power circuit breaker operating mechanism and associated wiring. This requirement can easily double the required floor space compared to the use of fuse panels.

#### 7.3.2.3 Molded case switch

A molded case switch is a switch formed from an MCCB by removing the tripping elements. In some cases, the high instantaneous trip elements are retained for protection of the switch. These switches are not intended to provide circuit protection.

### 7.3.2.4 Insulated case circuit breaker (ICCB)

An ICCB is a circuit breaker that has a supportive and enclosing housing of insulating material, and is operated by means of a two-step stored energy mechanism. They are typically larger frame sizes from 400 A to 5000 A. They are tested to UL 489-1991, and in specific instances are also tested to the ANSI C37 series of standards.

### 7.3.3 Types of circuit breaker trip units

- a) *Thermal magnetic.* The most common trip unit found on dc rated MCCBs.
- b) *Pneumatic magnetic.* Used on smaller, special application MCCBs. A pneumatically damped electromagnet senses current in the long time region. The unique characteristic for dc applications should be provided by the manufacturer. This is also referred to as a dual-magnetic trip element.
- c) *Instantaneous only.* These electromagnetically tripped MCCBs provide tripping in the instantaneous, or short-circuit, region only. The magnetic trip level is adjustable. Because they have no protection in the long time region, they are Component Recognized by UL such that the suitability of the application shall be determined by UL or another recognized authority.
- d) *Mechanical dashpot.* These trip units are most frequently installed on dc rated LVPCBs. Each has a unique characteristic that is provided by the manufacturer. They are tested under IEEE Std C37.14-1992.
- e) *Electronic trip.* Virtually all circuit breakers with electronic trip units use current transformers to sense current. Since the current transformers are not suited to dc circuits, these circuit breakers are not rated for use on dc circuits. For special cases in which electronically tripped circuit breakers have been designed for dc sensing, the manufacturers should be consulted for application information.

### 7.3.4 Thermal-magnetic characteristics

Figure 7 illustrates a typical time-current, tripping characteristic for a circuit breaker. In most cases today, the time-current, tripping characteristic curve is provided by manufacturers as the ac curve, and multipliers or similar tools are given to convert for use with dc circuits. This curve shape depicts the most common design, a thermal-magnetic circuit breaker.

The characteristic can be separated into three regions: the long time delay region at the top; the transition, or overload, region at the center; and the instantaneous region at the bottom.

#### 7.3.4.1 Long time region

The long time delay region generally includes currents from 100% of rated which the circuit breaker will carry indefinitely to the level at which it will trip instantaneously. In most cases this maximum long time delay current is about 500% of rated current. The sensing element in this region is a bimetal for the thermal-magnetic circuit breaker. The bimetal is heated by current flowing through the circuit breaker. Deflection is proportional to  $I^2$  so it is an ideal RMS current sensor. Deflection with dc will be the same as with the RMS value of ac current so that the time-current characteristic is the same for both ac and dc in the long time delay region.

#### 7.3.4.2 Transition region

The transition region generally covers overcurrents just higher than the stalled rotor currents for motors, usually 400–1200% of rated current. Trip times in this region are not precisely defined since it is here that transition from thermal to magnetic tripping occurs. Depending on the level of current flowing, tripping can be thermal, with the built-in delay shown on the thermal curve, or magnetic with no intentional delay. Magnetic tripping can be thought of as an override for thermal tripping for higher current levels. The electromagnet is

activated by current flowing through the circuit breaker. The magnetic force is proportional to the square of the instantaneous value of current, rather than the RMS value over some period. Current on ac trip units is expressed in terms of RMS trip values, while dc currents are expressed as instantaneous values. The difference in expressing current is an essential factor in adjusting ac curves to dc systems.

There is another factor for differentiating dc from ac magnetic tripping having to do with cycles of force from cycles of ac current. Under ac overcurrents, the armature may "chatter," knocking the latch partially off with each electrical cycle. With dc current, the magnet force has to be sufficient to work to the detached position with its single forced motion.

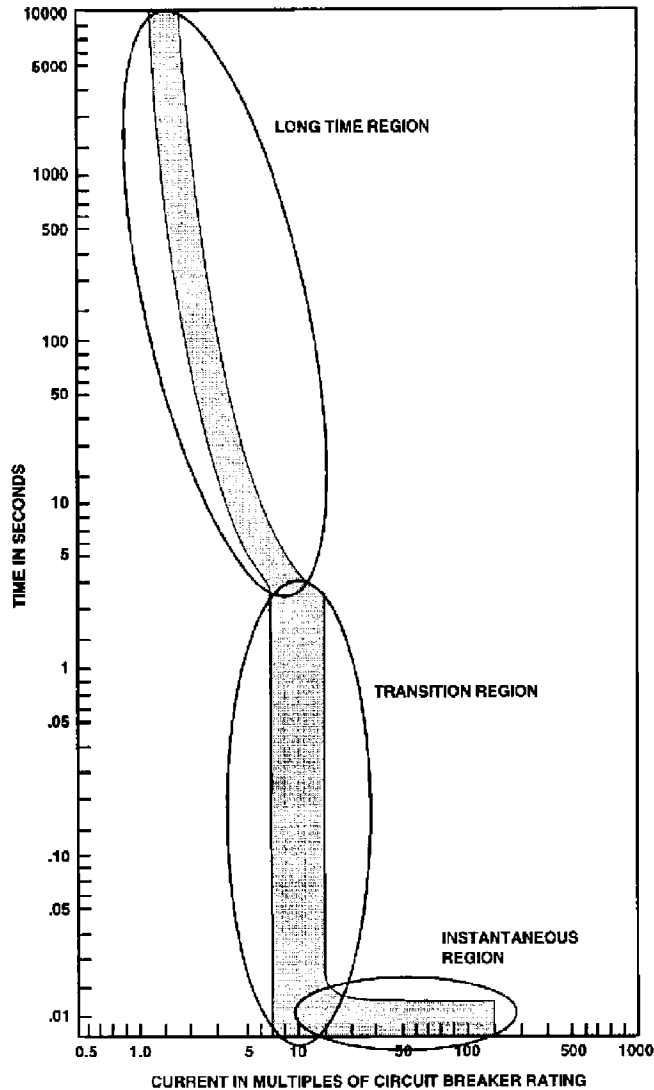
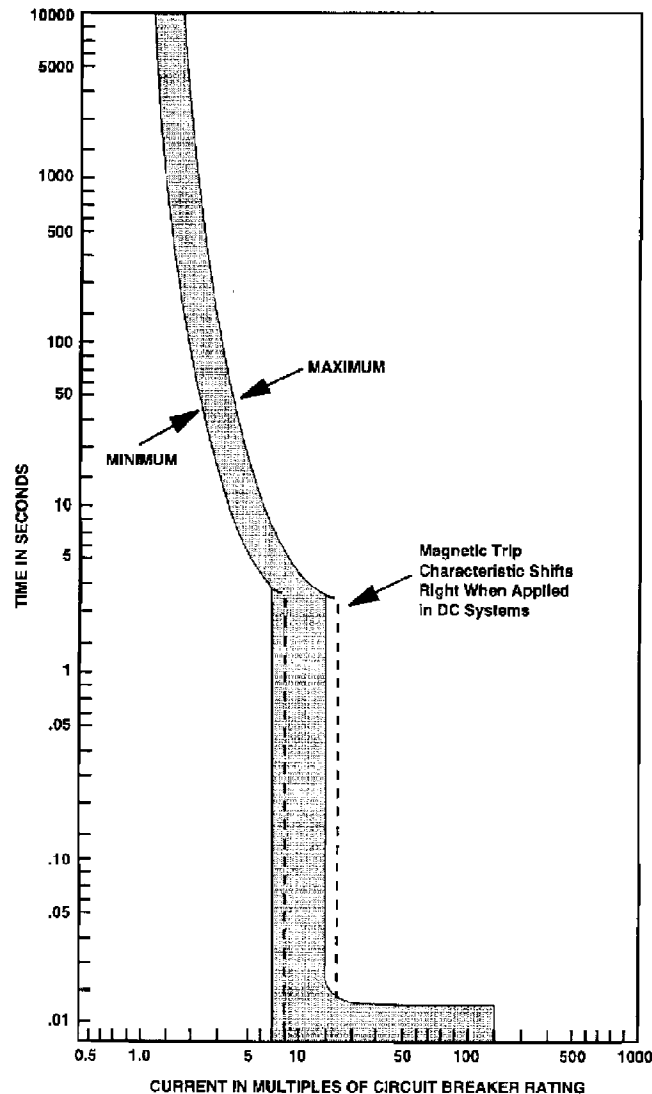

Figure 7—Typical time-current curve for a non-adjustable thermal-magnetic trip unit

There may be other differences between dc and ac characteristics in the transition region that are unique to each design. Combining the various differences, manufacturers will generally provide adjustments to the trip curves in the transition region in the form of multipliers or redrawn ac trip curves. The effect of these adjustments is to slightly increase the stated ac magnetic tripping current levels when the same circuit breaker is used in dc circuits as indicated in Figure 8. Several manufacturers express this difference in a multiplying factor of 1.1 to 1.4 times the ac tripping current for dc applications.



**Figure 8—Characteristic curve for a thermal-magnetic MCCB modified for dc application**

Several manufacturers provide circuit breakers with special magnetic trip levels designed lower than standard and intended for protection of batteries against sustained overloads.

### 7.3.4.3 Instantaneous region

The instantaneous region is the trip range at current levels higher than transition. In this region, tripping and clearing are instantaneous, with no intentional delay, whether in an ac or dc circuit. Tripping is accomplished by the electromagnet discussed for the transition region. Actual clearing time will vary depending on whether the circuit is ac or dc. However, the maximum total clearing time is generally expressed as a conservatively long duration on ac trip curves because of the large number of other variables. As long as the time constant is 10 ms or lower, the dc clearing time will not be greater than the ac maximum clearing time as shown on the curve.

### 7.3.5 Ratings, certification, and testing of MCCBs and ICCBs

MCCBs and ICCBs intended for application under the NEC are certified to UL 489-1991. Whenever possible, circuit breakers should be used that have been certified by a third-party organization that incorporates follow-up testing. Whether evaluated for ac or dc ratings, they are subjected to a series of tests in each of the three characteristic curve regions. These tests are comprehensive in evaluating the circuit breaker performance to the ratings claimed. Regardless of whether UL certification is required in the application being considered, the UL 489-1991 series of tests have been shown over time to demonstrate safe and competent protection over a range of conditions. When evaluating the ratings for protection of battery systems, there are several factors to which special attention is called.

#### 7.3.5.1 MCCBs certified for use with UPS

UL 489-1991 contains a supplement with requirements specifically for battery protection in UPS installations. Circuit breakers certified to these requirements are marked "Suitable only for use on UPS." These requirements are identical to core UL 489-1991 requirements with the following special points:

- a) *Nominal and maximum voltages.* Considering that battery systems will normally operate at a voltage above nominal, endurance and overload tests are performed at the maximum voltage. Both nominal and maximum voltages are marked on the circuit breaker.
- b) *Overload and endurance operations.* For some circuit breaker sizes, the number of endurance and overload operations is reduced from that required for the general application circuit breaker. It is not expected that these circuit breakers will be used for frequent switching applications.
- c) *Pole connections.* Many circuit breakers used for dc protection have circuit breaker poles connected in series, especially above 250 V dc. Figure 9 illustrates the most commonly specified connections. By connecting poles in series, arc interruption is shared, permitting better effective elongation and segregation of the inductive arc. Requirements for such connections are marked on the circuit breaker and in instructions for its application. Circuit breakers connected this way are not considered generally suitable for use on systems with one polarity grounded as discussed under grounded systems in 7.3.5.3.

UL Listed circuit breakers marked with dc ratings and not identified as "Suitable only for use on UPS" are suitable for general application on dc as well as for UPS when the marked voltage is taken as the maximum voltage.

#### 7.3.5.2 Current rise time

Tested under UL 489-1991, current rise time for interruption test circuits is calculated for RL circuits that exhibit exponential rise of current on dc circuits. The rise time is expressed as the time constant, or the time from current initiation until it reaches 63.2% of its maximum value. This measure determines the degree of reactive impedance in the circuit.

The time constants are noted in Table 3.

If the system time constant exceeds the above tested values, the manufacturer should be consulted.

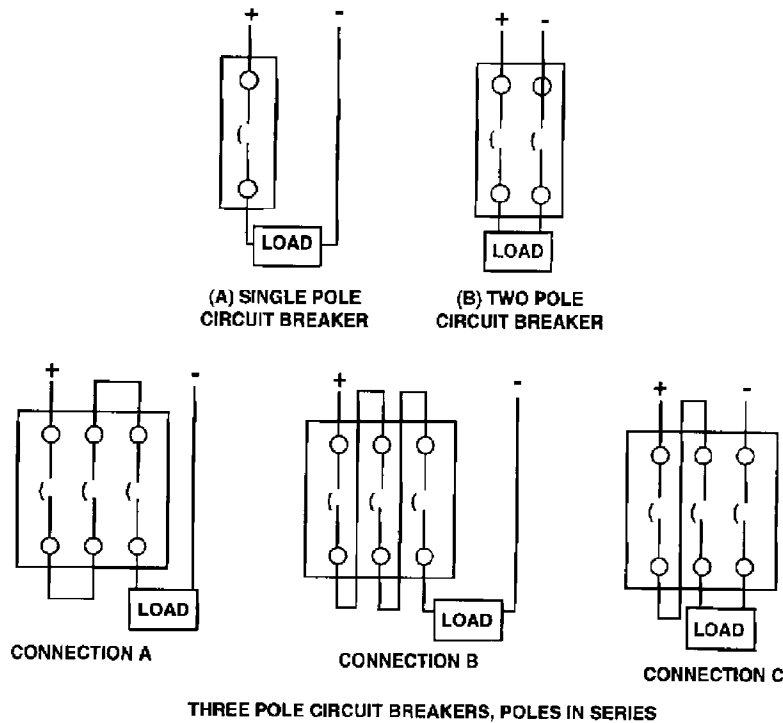

Figure 9—Common circuit breaker dc connections

Table 3—Time constants used in UL testing<sup>a</sup>

Test	Test current (A)	Minimum time constant (ms)
Endurance	Rated current	3
Overload	6 × rated current	3
Short circuit	10 000 and below	3
Short circuit	Above 10 000	8

<sup>a</sup>Reprinted from Table 22.4 of UL 489-1991 with permission of Underwriters Laboratories, Inc.

### 7.3.5.3 Grounded and ungrounded systems

UL Listed circuit breaker designs that have been short-circuit tested with full-rated voltage across individual poles in the limited available interrupting ability test are considered suitable for use on systems in which one polarity is grounded. These circuit breakers will have no special marking regarding ground connections. Circuit breakers evaluated for use in UPS or other systems using multi-pole connections illustrated in Figure 9 (illustrated as Connections A, B, and C), are not considered suitable for use in systems with one polarity grounded. The reason is that a single fault could cause a full-voltage overcurrent condition across a

single pole. These multi-pole connected circuit breakers will be marked for use only on ungrounded systems. It is recommended that in an ungrounded system, both the positive and negative poles be interrupted.

Table 4 indicates typical dc interrupting ratings for MCCBs available today. Standard ratings are those found with the most commonly available frames while high ratings are those available with higher performance circuit breakers.

**Table 4—Typical dc interrupting ratings of MCCBs for commercial and industrial applications**

Frame size (A)	No. of poles	Interrupting rating in kA at dc voltage				
		125 V dc	250 V dc		500 V dc or 600 V dc	
		Standard	Standard	High	Standard	High
100, 150	1	10	—	—	—	—
	2	—	10	30	—	—
	3	—	—	—	14	42
225, 250	2	—	10	30	—	—
	3	—	—	—	20	42
400, 600	2	—	10	30	—	—
	3	—	—	—	20	42
800, 1000	2	—	14	30	—	—
	3	—	—	—	20	50
1200	2	—	14	30	—	—
	3	—	—	—	25	50
1600–2500	2	—	—	30	—	—
	3	—	—	—	25	50

### 7.3.6 Ratings, certification, and testing of LVPCBs

LVPCBs for application in dc systems are evaluated and rated under IEEE Std C37.14-1992, ANSI C37.16-1988, and ANSI C37.17-1979.

LVPCBs will be marked with their dc ratings and have a time-current characteristic that specifically applies to dc applications at rated voltage.

DC LVPCBs are subdivided according to their specified ability to limit fault-current magnitude by being called general purpose, high speed, semi-high speed, or anode.

The "Application Guide" section of IEEE Std C37.14-1992 provides details beyond those presented here. It states, "Semi-high-speed circuit breakers will limit short-circuit current produced by rotating machines, batteries, and electrolytic cells so that the crest value of current occurs not later than 30 ms after the start of short-circuit current... and a maximum rate of rise of short-circuit current no less than 1.7 A/μs." It further states, "High-speed circuit breakers will limit short-circuit current so that the crest value of the current occurs no later than 10 ms after the short-circuit current reaches the pickup setting of the trip device... and a rate of rise of short-circuit current no less than 5.0 A/μs." General purpose LVPCBs are not intended to limit short-circuit current.

Consider the following ratings when applying LVPCBs:

- a) Rated maximum voltage(s);
- b) Rated continuous current;
- c) Rated peak current;
- d) Rated short-time current;
- e) Rated short-circuit current;
- f) Rated control voltage(s).

### 7.3.7 Application of circuit breakers in dc circuits

Many circuit breakers are rated for switching and overcurrent protection of dc systems including battery systems. Both thermal-magnetic MCCBs and LVPCBs with direct acting trip units are available with ratings for these systems. The following factors apply:

- a) Look for dc ratings since interruption of dc cannot be directly related to ac interruption.
- b) Voltages may be expressed as maximum and nominal. In the absence of both voltages, rated voltage is considered maximum.
- c) For systems with long current rise time, tested time constants may need to be considered. For LVPCBs, energy dissipation may also need to be evaluated.
- d) Many MCCBs are rated and tested for operation and interruption with two or more poles of the circuit breaker connected in series. These connections are not recommended for systems in which one polarity is grounded.
- e) Multiple poles should not be connected in parallel.
- f) Trip curves drawn for ac application of MCCBs are frequently used for dc applications as well. Manufacturers generally publish adjustment factors for instantaneous tripping current levels.

### 7.4 Characteristics of fused circuit breakers in dc circuits

Fuses are sometimes used in conjunction with circuit breakers on ac and dc systems where the available short-circuit current exceeds the interrupting rating of the circuit breaker alone. This subclause discusses fuses that are part of and supplied with the breaker assembly itself. They are often called *limiters* and are normally downstream of the breaker contacts to allow easy de-energization for replacement. However, with today's breaker technology that can interrupt higher fault levels, this need is decreasing.

A number of design considerations are necessary with this type of protection. First, the limiters have to be coordinated with the circuit breaker characteristic. The dc system designer cannot assume the ac time-current characteristic will necessarily be the same for a dc application. A typical set of time-current curves is shown in Figure 10. Here, the circuit breaker acts normally for overloads that are interrupted in the thermal time delay region of the curve and for low-level short circuits that are interrupted by the magnetic instantaneous element. However, at high fault levels that are near or above the capability of the circuit breaker alone, the fuse limiters will clear the circuit. These limiters are selected by the manufacturer to clear before the circuit breaker is damaged. In Figure 10, the available fault current in the circuit could be off the right end of the scale, but shall be within the capability of the circuit breaker-limiter combination. In addition, the limiters shall be selected and designed so that a low-level fault interrupted by the circuit breaker will in no way affect the limiters.

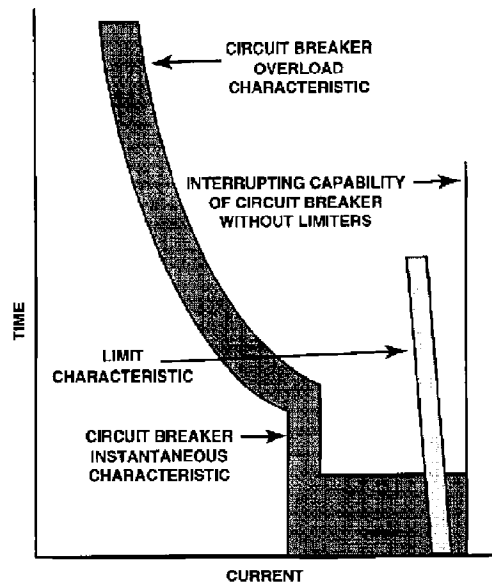

**Figure 10—Typical time-current characteristics of circuit breakers in series with fuses**

Additional considerations involve operational features after a fault is cleared and the circuit breaker contacts open. These may include preventing the reset of the circuit breaker if any of the limiters have opened, and providing a visual means to show which limiter operated. Whether these are required depends upon the experience and expertise of the maintenance personnel who will be restoring power.

### 7.5 Switches

Battery switches provide a disconnecting means for battery circuits. Overcurrent protection can be provided by fused switches and non-fused switches with downstream protective devices. Fault current and overvoltage protection can be provided by switches with shunt trips and sensing devices. Fusible switches that can provide overcurrent, fault current, or undervoltage protection should be properly rated load-break switches.

Switches are generally designed to the requirements of NEMA KS-1-1996, UL 98-1994, and/or UL 977-1994. These standards, however, are mostly written for ac rated devices, and each has its limitations regarding dc requirements. Consequently, many installed battery disconnect switches do not bear third-party listings, and/or the ratings were based on ac testing at elevated levels. Only recently have fuses with fault current ratings above 10 kA become available that bear third-party listings for dc use. This has allowed switch manufacturers to test and obtain third-party listings on fusible switches with fault current ratings above 10 kA.

Because of the limited availability of dc listed fuses and dc testing facilities, switch manufacturers typically applied derating factors to ac rated devices. In some cases, special wiring schemes utilizing center taps of battery banks were recommended to limit the voltage across each switching pole. Other schemes, such as wiring switching poles in series, were also commonly recommended. Now, however, with dc listed fuses and dc testing laboratories becoming increasingly available, it can be expected that third-party listed switches with dc ratings will become increasingly available. Whenever possible, switches should be used that have been certified by a third-party organization that incorporates third-party testing.

Switches may be either fusible or non-fusible, although it is common for non-fusible applications to use a fusible device with “dummy fuse” links. On fusible devices, the fuse mounting is usually an integral part of the switch. The fuse type should be marked at or near the fuse mounting location. Switches with short-circuit current ratings above 10 kA should accept only the fuse specified. Parallel fusing is generally not acceptable, unless the switch is specifically designed for such use.

To ensure safety, switches should have external operating handles and provisions for padlocking in the OFF position. An operating handle of conducting material should be in electrical connection with the enclosure. The outside of the enclosure should be clearly marked to indicate the ON/OFF and any other functional positions of the switch. If handle movement is vertical, the upper position should be the ON position.

### 7.5.1 Switching dc

Closing and interrupting dc differs considerably from closing and interrupting ac. Design criteria generally requires the switch contacts to close and interrupt circuits at various current levels up to six times the switch rating for both ac and dc rated devices. Switches equipped with shunt trip mechanisms interrupt even higher current levels. When closing the switch contacts at these elevated levels on ac circuits, contact erosion (pitting), release of ionized gases, and lubrication breakdown are not uncommon. In comparison, closing on dc circuits compares more closely to closing under moderate ac load conditions. When interrupting a circuit at these elevated levels, the results are quite the opposite. An ac arc is difficult to sustain, since the current and voltage are continually passing through zero. The dc arc, however, truly wants to “hang-on,” making it much more difficult to extinguish. The resulting arc produces more heat, causing greater contact erosion, greater erosion of arc chute grids, and accelerated lubrication breakdown. These differences become apparent in laboratory testing, particularly when ac switch designs are subjected to dc circuits.

### 7.5.2 Ratings

Switches are usually voltage and ampere rated, with typical dc voltage ratings of 125 V dc, 250 V dc, or 600 V dc. The ampere rating indicates a maximum continuous load current of either 80% or 100% of their nameplate rating. Switches intended for use at 80% should be marked accordingly. However, it is generally recommended by switch and fuse manufacturers alike to derate all devices to 80% whenever possible. In addition, switches may be designed for either load-break or non-load-break operation. Non-load-break devices are normally marked that they are intended for isolation use only, and not intended for opening under load.

The short-circuit current rating of a switch indicates the maximum fault current the switch is able to close into or withstand without hazard. Non-fusible and fusible switches have a 10 kA rating when protected by Class H or Class K fuses. This rating is typically assumed without testing. Short-circuit current ratings above 10 kA require laboratory testing. Upon completion, it is required that the switch can be opened by its normal operating means.

### 7.5.3 Design tests

Switch manufacturers typically conduct design tests on sample products to evaluate temperature rise, overload capabilities (close and open), endurance (with and without current), fault current capabilities, dielectric voltage withstand, and strength of components. Brief descriptions of the design tests are as follows:

- *Temperature.* At rated current (or 80% if marked), no part should exceed parameters established to ensure the integrity of the device or its connections.
- *Overload/endurance.* Combination of operations at 200%, 150%, and/or 100% rated current, at rated voltage, along with no-load operations. A substantial number of operations at these levels is required.

Additional tests for fault current ratings above 10 kA are as follows:

- *Close-open.* At least three make and break operations at 600% (6 times) rated current, at rated voltage.
- *Contact opening.* At least three break operations at 1000% (10 times) rated current, at rated voltage.
- *Withstand and closing.* Withstand and close into circuits having available fault currents of 20 kA, 50 kA or 100 kA, at rated voltage.

Upon conclusion of each test (excluding temperature tests), the test sample is subjected to dielectric voltage withstand tests to check for insulation breakdown. A voltage of double the rated voltage plus 1000 is applied across current-carrying parts of different potential, across the open switch contacts, and across current-carrying parts and the enclosure. The voltage is applied for 60 s and breakdown shall not be detected.

Some of the above testing may be conducted on ac circuits. For many dc voltage ratings, standards may allow for the overload/endurance tests to be conducted on ac circuits at elevated voltage levels. Also, temperature and withstand and closing tests, when conducted on ac circuits, are sometimes considered more severe than if conducted on dc circuits. The tests requiring load-break operation, however, usually require dc test circuits.

## 7.6 Use of ac rated devices for battery protection

While it is important that protective devices used in dc applications be rated for dc use, underrated devices or devices rated for ac only may sometimes be found on existing systems. It is often not possible, or even safe, to remove the system from service immediately, so analysis should be performed to determine the risks associated with the misapplication and the best action to take to correct the problem. Where ac rated devices are used in dc circuits, the manufacturer of the device should be consulted for its dc rating or testing of the device should be performed to ensure its adequacy in the desired application.

For ac-only rated fuses, sometimes a general rule-of-thumb is used that approximates the dc voltage rating of the fuse as a fraction of the ac rating. This practice should be avoided, since it does not take into account the effects of the circuit time constant on the interrupting capability of the fuse.

There may be protective devices installed in existing dc applications with voltage ratings below the maximum dc voltage that the device may be exposed to. For protective devices which have a dc rating, but which are applied above their published dc voltage, the manufacturer of the protective device should be contacted to determine whether unpublished tests have been performed. Protective devices can be listed only at specific voltages, and a protective device may have been tested at voltages higher than that listed, but not high enough to meet the requirements of the next highest rating. Similarly, a single type of protective device may have several different physical sizes and ampere ratings. All but a few ampere ratings within a protective device family may have been successfully tested at higher voltages, but all sizes may be listed at a lower voltage to avoid confusion. In such cases, if third-party listing is not required, test data and additional certification may be available from the manufacturer that will allow for continued operation of the system.

For current-limiting fuses in ac circuits, the peak-let-through and RMS-let-through currents are determined using published let-through curves. Some fuses are also provided with tabulated let-through values for various prospective short circuits. Although the definition of current limiting does not apply in dc circuits, fuses may act to reduce actual fault currents below prospective faults in dc circuits, depending on the time constant and the fuse characteristics. In general, however, the published let-through data cannot be used in dc applications, even when the fuse is dc rated, due to the differences in fault interruption in dc circuits. Therefore, it is not usually possible to use analysis to apply fuses specifically as current limiters for equipment protection in dc systems.

Many MCCBs were originally designed for use in ac circuits, and later tested for use in dc applications. Therefore, most thermal-magnetic MCCBs of less than 1000 A frame are rated for use in dc systems, usually

with voltage rating and interrupting rating less than the ac ratings. However, dc voltage ratings sometimes vary for different size and pole configurations within a frame size. Larger thermal-magnetic and electronic circuit breakers are generally not rated for use in dc systems, since such breakers usually employ a current transformer to supply current to the trip elements.

Time-versus-current curves are usually published only for ac applications. Using these curves for dc applications of a breaker is valid only when circuit breaker tripping is provided by thermal elements, which for most MCCBs includes low current overloads less than 7–10 times the circuit breaker rating. For most MCCBs, protection for faults is provided by an instantaneous magnetic element. A multiplier has to be used to correct the magnetic portion of the time-versus-current curves for dc operation. The multiplier is applied to the nominal magnetic trip current, and the published tolerance for the trip value remains constant. For adjustable magnetic MCCBs, multipliers may be provided for both high and low settings. Magnetic trip multipliers will vary depending on the size and type of circuit breaker, so the manufacturer should be consulted to determine the appropriate value.

## 7.7 Ratings considerations for devices used in dc systems

### 7.7.1 Voltage ratings

Figure 11 shows a comparison of nominal 120 V ac and 125 V dc systems. Typical minimum and maximum voltages are shown. It is important to note that the voltage regulation is much better for the ac than the dc system. AC systems are typically supplied by high capacity sources. This is not the case for a dc system supplied by a battery. Batteries need to be charged and equalized. Charging and equalizing are usually performed at voltages higher than the system voltage. If batteries are equalized off-line (disconnected from the system), this voltage can be neglected. Additionally, batteries are not infinite sources. Battery voltage decreases over time when the charger is not carrying the dc system load. The final discharge voltage may be well below the system's nominal voltage. The effects of these voltage swings are discussed below.

Care should be taken when selecting voltage ratings for equipment. Figure 11 shows, for a nominal system voltage of 125 V dc, a typical maximum voltage range of 135 V dc and a system equalizing voltage of 140 V dc. It is important for the designer to account for these equalizing and charging voltages when selecting equipment. The designer may be required to select voltage ratings higher than the nominal system voltage. In the case of a nominal 125 V dc system, equipment with a 250 V dc rating may have to be used.

In some cases even small overvoltages may not be tolerated. Thermal energy is proportional to voltage squared for resistive loads. Equipment thermal ratings can be easily exceeded. Additionally, fuses and circuit breakers frequently do not operate satisfactorily for overloads or faults with this higher driving voltage if it is above the rating of the protective device. The equipment should be rated for at least the highest expected voltage on the system.

### 7.7.2 Current ratings

The NEC and manufacturers of protective devices provide recommendations for selecting equipment for loading and overcurrent protection. However, these recommendations are written primarily for well regulated ac systems. Because these systems are well regulated, the voltage effects on current are accounted for. This may not be true for dc systems, and voltage effects need to be accounted for. Figure 12 shows voltage effects on currents in a dc system.

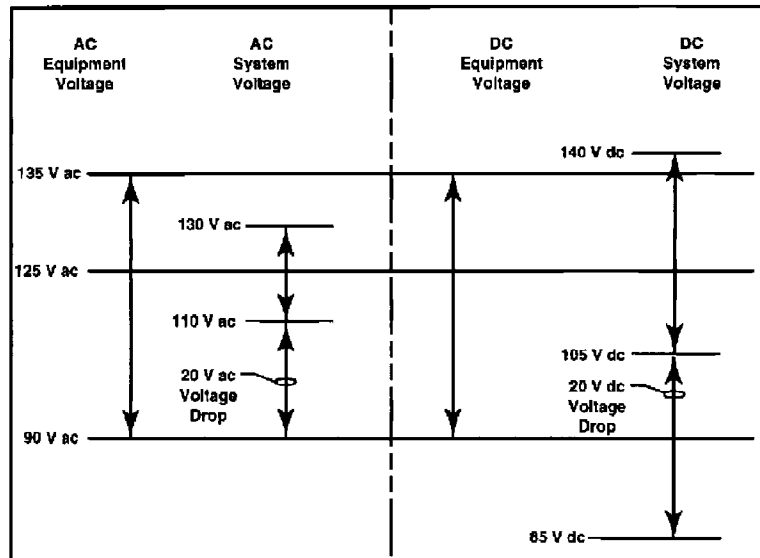

Figure 11—AC versus dc voltage regulation

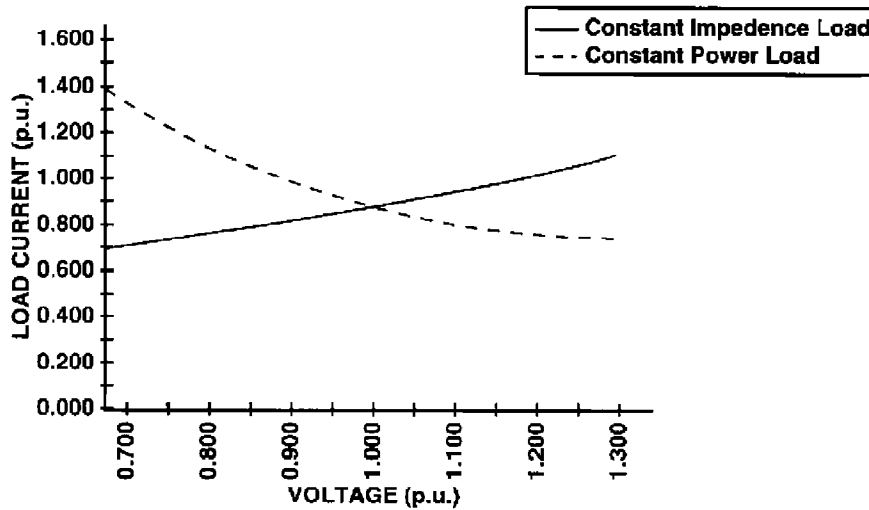

Figure 12—Voltage effects on current

### 7.8 Main battery feeder cables

The main battery feeder cables should be selected to carry the maximum anticipated loads, with impedances such that there will be adequate voltage at the main dc panel; and function properly in normal use, during overloads, and during short circuits. A discussion of factors considered in sizing the main battery feeder cables is contained in IEEE Std 946-1992.

## 8. Battery electrical protection schemes

This clause provides options to the battery system designer of the commonly available schemes that can be utilized for stationary battery protection. The battery system designer should note that one protection scheme is not more correct than another. The battery system designer should consider the benefits of each protection scheme and the effects on the battery and its supply to the dc system when choosing which option to employ.

Discussions of the following protection schemes are included in this clause:

- a) Fuses between the battery terminals and main dc panel;
- b) Circuit breakers between the battery terminals and main dc panel;
- c) A switch between the battery terminals and main dc panel;
- d) Direct cable between the battery terminals and main dc panel;
- e) Mid-span battery protection;
- f) Multiple voltage battery systems; and
- g) Parallel battery string systems.

### 8.1 Fuses between the battery terminals and main dc panel

Installation of a fuse as a protective device between the battery and the devices it supplies (Figure 13) will provide both overload and short-circuit protection. However, it is not readily apparent in some fuses if the fuse has operated to interrupt a circuit condition.

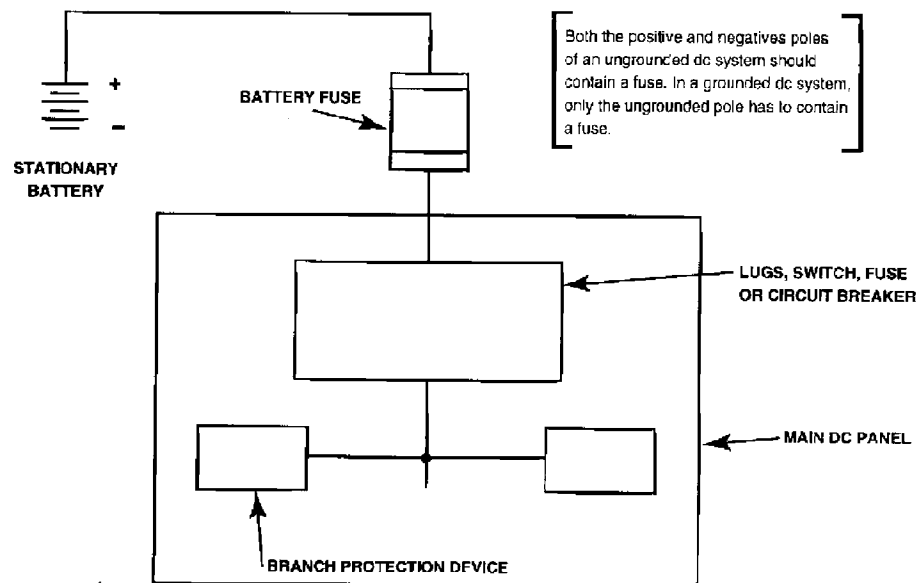

Figure 13—Fuses between the battery terminals and main dc panel

When sizing fuses, consideration should be made to avoid a partial melt of the fuse element during a fault condition by coordinating the protective devices used on the load side of the battery fuse. The partial melt condition is not readily detectable.

Although fuses can be installed in a disconnect type holder, the disconnect cannot be opened under a significant load unless it is a load-break switch. A switching device can be employed to allow manual current interruption in a fuse protected system.

Fuse operating characteristics are stable and well defined; therefore, fuses do not usually require periodic maintenance or testing. However, it is possible for an incorrect size or type of fuse to be installed into a fuse holder without detection. A fuse control program may be desirable to maintain the proper system configuration.

If a fuse is continually being replaced, the fuse may be improperly sized or there may be an undetected circuit problem. Since fuses do not have adjustable time-current characteristics, they may need to be replaced if the system characteristic changes.

The fuse to be used should be selected carefully and the battery system designer should consider the following items:

- a) The rated voltage of the fuse should be higher than the battery system equalizing voltage.
- b) The rated current of the fuse should be at least of 125% of the sum of the calculated continuous current and 100% of the momentary loads from the battery load profile. This calculated current should be compared to the anticipated highest current during the battery discharge or charging cycle.
- c) The interrupting rating shall be sufficient to interrupt the maximum calculated short-circuit current.
- d) The fuse should interrupt a fault or overload prior to the battery cables being damaged.
- e) The fuse should be coordinated with the downstream protective devices.
- f) For new installations, use of dc fuses is recommended. If ac fuses are used, they should be properly re-rated for dc applications.
- g) Blown fuse/disconnect switch open indications or alarms may be provided.

## 8.2 Circuit breakers between the battery terminals and main dc panel

Installation of a circuit breaker as the main battery protection (Figure 14) can be provided as both overload and short-circuit protection or short-circuit protection only. There are many types of circuit breakers available for use.

Circuit breakers can act as a switch that allows the circuit to be interrupted under load. They also can be opened locally or remotely and provide positive indication of circuit-breaker operation. Circuit breakers can also be designed to open automatically for conditions other than an overcurrent condition. Operation of a circuit breaker to interrupt an overload will generally not require its replacement. However, it is usually recommended to inspect, and replace as necessary, circuit breakers after they have interrupted a short circuit.

The circuit breaker to be used should be selected carefully and the battery system designer should consider the following items:

- a) The rated voltage of the circuit breaker should be higher than the battery system equalizing voltage.
- b) The rated current of the circuit breaker should be at least of 125% of the sum of the calculated continuous current and 100% of the momentary loads from the battery load profile. This calculated current should be compared to the anticipated highest current during the battery discharge or charging cycle.
- c) The interrupting rating shall be sufficient to interrupt the maximum calculated short-circuit current.
- d) The circuit breaker should interrupt a fault or overload prior to the battery cables being damaged.
- e) The circuit breaker should be coordinated with the downstream protective devices.
- f) For new installations, use of dc rated circuit breakers is recommended. If ac-only rated circuit breakers are used, they should be properly re-rated for dc applications.

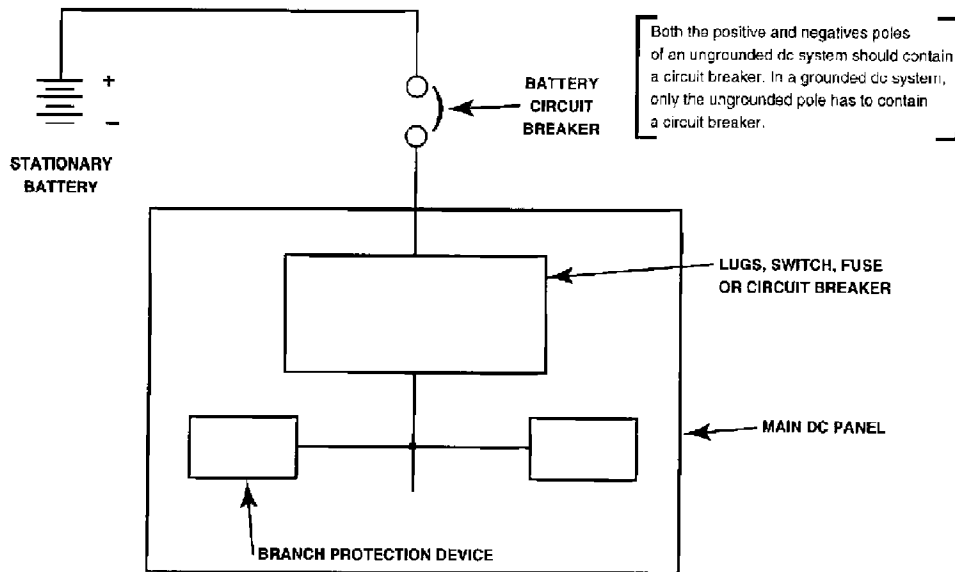

Figure 14—Circuit breakers between the battery terminals and main dc panel

### 8.3 A switch between the battery terminals and main dc panel

Installation of a switch between the battery and main dc panel (Figure 15) provides the user with a means to disconnect the battery from the dc system to perform maintenance and testing while ensuring the battery supply will not be interrupted during fault or overload conditions when it is essential that the battery continue to supply the dc system.

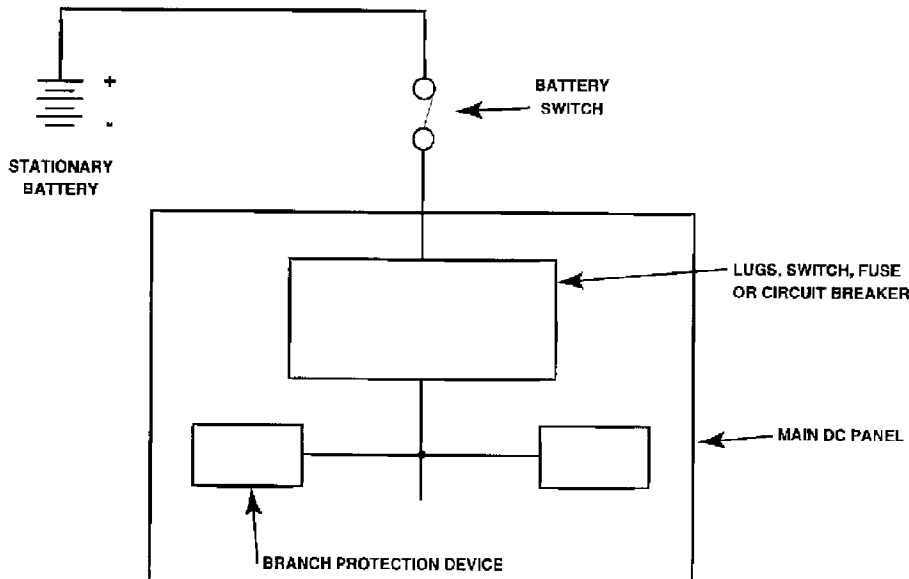

Figure 15—A switch between the battery terminals and main dc panel

If no overload and/or short-circuit protection is provided between the terminals of the battery and main dc panel, physical protection of the cables and main dc panel should be provided as recommended in IEEE Std 946-1992.

The advantage to this form of circuit design is that the battery supply will not be interrupted unless the disconnect switch is opened. If it is essential that the battery supply not be interrupted for any condition other than maintenance, testing, or replacement, then the system designer may wish to consider use of a switch without other forms of circuit interruption. However, the designer of the battery system should, as a minimum, review the following characteristics of the switch when considering this option:

- a) The rated voltage of the switch should always be higher than the equalizing voltage of the battery system.
- b) The rated continuous current of the switch should be at least of 125% of the sum of the calculated continuous current and 100% of the momentary loads from the battery load profile. This calculated current should be compared to the anticipated highest current during the battery discharge or charging cycle.
- c) The switch should be sized to remain in the closed position when exposed to the maximum calculated short-circuit current. If an ac rated disconnect switch is used, the manufacturer of the switch should be consulted for its dc rating.
- d) The switch should meet the requirements of applicable industry standards.
- e) The cables supplying the dc system from the battery may be of significant size with several parallel cables per pole. The system designer should ensure that the disconnect switch will accommodate the incoming and outgoing cable bend radius and terminations.

Battery system designers who favor the use of fuses may wish to consider the use of a switch with the fuse (Figures 16, 17, and 18).

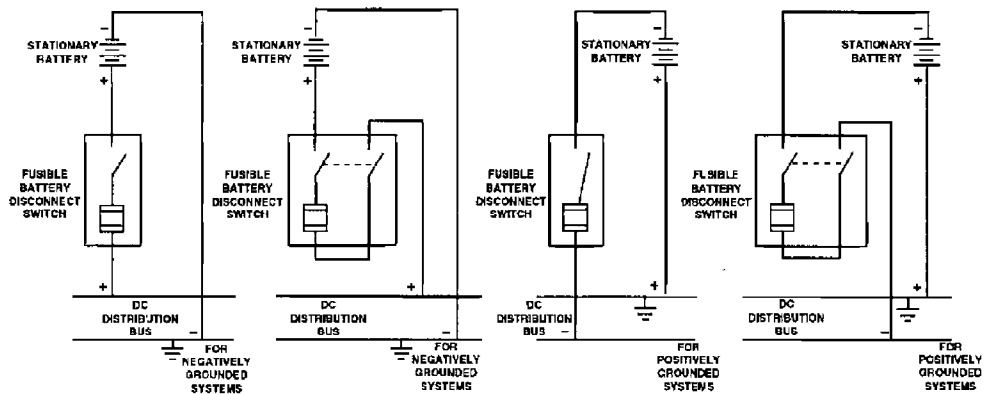

Figure 16—Typical fusible battery disconnect switch schematics—  
1-pole and 2-pole switches

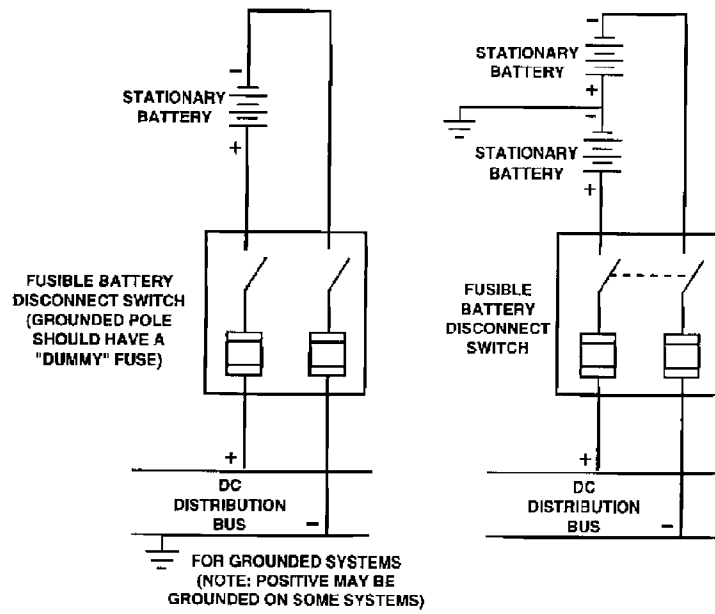

Figure 17—Typical fusible battery disconnect switch schematics—  
2-pole switches

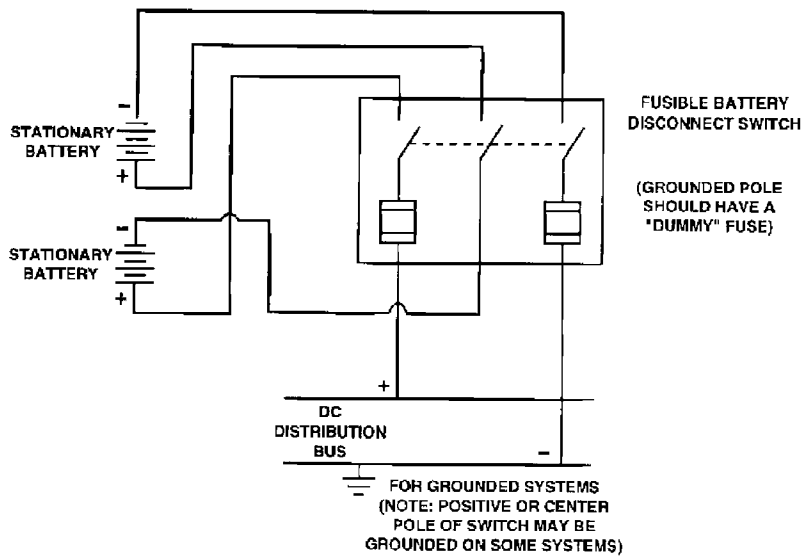

Figure 18—Typical fusible battery disconnect switch schematics—  
3-pole switches

This circuit scheme will provide the battery system with the advantage of fuse protection for overloads and faults while providing a simple means to disconnect the battery from the dc system to perform maintenance, testing, or battery replacement. The battery system designer should review the same switch characteristics noted in this subclause when considering this option along with the fuse application guidelines contained in 8.1.

#### 8.4 Cable only between the battery terminals and main dc panel

When interruption of the battery supply cannot be tolerated for any reason, the system designer may wish to consider direct connection of the battery to the dc system without the use of any interrupting devices [just cable between the battery and main dc panel (Figure 19)].

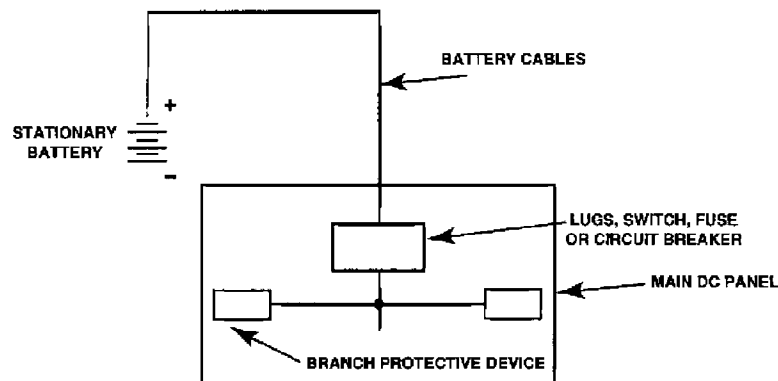

Figure 19—Cable only between the battery terminals and main dc panel

The primary advantage to this option is the reliability of the system since there are no interrupting devices. This precludes the possibility of inadvertent opening of an interrupting device which may render the system out of service during a critical time.

There are several disadvantages to this option. The primary disadvantages are the lack of overload and short-circuit protection of the battery. There may be significant damage to the battery system during fault or overloads on the dc system when no circuit protection is provided.

In some cases, the cable may act as a form of overload protection depending on its size and the extent of the overload. The cable may be damaged and possibly melt, opening the circuit prior to significant damage being done to the battery. In this case, the extent of the damage will depend on the nature of the fault.

It is recommended that a careful evaluation of the system needs and economics be performed if direct connections between the battery and the dc distribution bus are utilized. Physical protection of the battery feeder cables and the positive/negative main dc panel buses should be provided as recommended in IEEE Std 946-1992.

#### 8.5 Mid-span battery protection

Mid-span protection is the installation of one or more protective devices (fuse or circuit breaker) in the middle of a battery string (Figure 20). The purpose of such protection is to limit short-circuit current through the battery and minimize or prevent battery damage or failure. Mid-span protection will open the battery circuit for external faults and in some cases for internal faults which may involve only a portion of the battery.

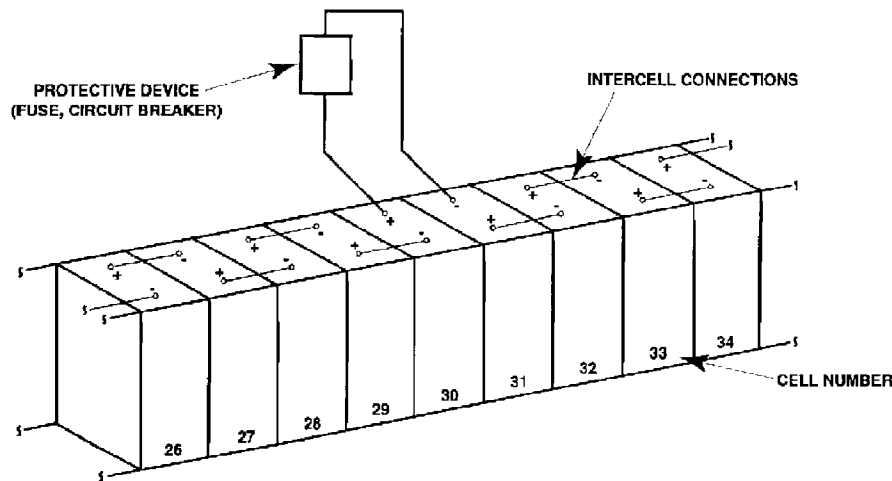

Figure 20—Mid-span protection for a 60-cell stationary battery

A benefit of mid-span protection is that only a single pole protective device is required. This minimizes the added battery circuit resistance from device connections and contacts, and reduces the number of devices that could potentially cause a failure of the battery system.

Mid-span protection protects the battery from external faults, and some internal faults, and can limit the number of cells that could be involved in an internal fault. This advantage should be considered in cases where batteries are grounded or when batteries are connected in groups such as multi-cabinet or multi-rack installations, especially when connected in series. Available fault energy is reduced by up to one-half for certain types of faults.

A drawback to mid-span protection is that opening of the mid-span device does not isolate the battery from the rest of the circuit. Operating and safety procedures have to address this.

Single pole protective devices are generally located at the mid-point of the battery string, i.e., between cells 30 and 31 in a 60-cell battery. Multiple locations are typically used between racks or groups of batteries.

## 8.6 Multiple voltage battery systems

The philosophy of overload and fault protection for a multiple voltage system is similar to that of a single battery voltage system when the battery supply cable is protected by a fuse or circuit breaker. Refer to 8.1 and 8.2.

## 8.7 Parallel battery string systems

In parallel battery string installations, the total short-circuit current will be the sum of the short-circuit current of each string. The designer of the dc system should consider the effects of multiple string short circuits and the effect of a short circuit on an individual string in the parallel system. While the service requirements of individual strings in a parallel system may be different from those of a single string battery system, the concepts of protection for a single string battery system may be applied to parallel battery string systems. *However, the designer of the dc system should take caution to be aware of the different characteristics of parallel battery string systems from those of single string battery systems.*

## 9. Physical protection of batteries

Physical protection of batteries is comprised of the enclosure of battery areas, adequate ventilation and temperature control, fire protection and detection, and properly designed battery racks or stands.

A protective enclosure for batteries should be considered, with accessibility limited to qualified personnel. For the purposes of this guide, a protective enclosure may be a battery room, building, cabinet, case, cage, or fence, or anything that will protect and minimize the possibility of the inadvertent contact of personnel or other equipment with energized parts and/or the potentially corrosive batteries.

Complete compartmentation or a separate enclosure for the battery installation may also serve to protect the batteries from extreme temperatures. A controlled atmosphere will contribute to optimum battery life, performance, and cost of operation; therefore, an enclosure with a heating, ventilation and air-conditioning (HVAC) system may be considered. Extreme ambient temperatures should be avoided because low temperatures decrease battery capacity, while prolonged high temperatures shorten battery life. For example, VRLA cells need proper ventilation and temperature control to reduce heat effects on life, recombination efficiency, and to help prevent thermal runaway. As a minimum, the battery should be located in a well ventilated area. The sizing of the ventilation system and frequency of its operation should take into account the gassing of the batteries. IEEE Std 484-1996, IEEE Std 1106-1995, and IEEE Std 1187-1996 each provide a method of calculating the gas generated by the battery so that the ventilation system can be sized accordingly.

Fire protection systems in a battery area are meant to protect the batteries from fires, and to protect other equipment from fires originating in the battery area. The walls of a battery enclosure, for example, can serve as a fire barrier, both to and from the battery area. For guidelines on enclosure materials and application, refer to NFPA 220-1996, the Uniform Building Code™ [B10],<sup>9</sup> IEEE Std 484-1996, IEEE Std 1106-1995, IEEE Std 1187-1996, and IEEE Std 946-1992. Fire detection systems generally consist of remote smoke detectors and an alarm system, and some means of extinguishing the fire. This means may be a suppression system, or standpipes and hoses, or a combination of the two. Local fire extinguishers should be considered near the battery area. For more information regarding fire system design requirements and affects on stationary batteries, refer to IEEE Std 484-1996, IEEE Std 1187-1996, NFPA 14-1996 [B7], other applicable standards, and the battery manufacturer.

Batteries are normally placed on racks or stands. These should be earthquake-braced for the geographic area in which they are installed. Stands should also leave sufficient space for easy maintenance of the batteries and removal and installation of individual cells. More information on choosing appropriate stands can be found in IEEE Std 484-1996, IEEE Std 1106 1995, and IEEE Std 1187 1996.

## 10. Indication and annunciation

The need for, and level of complexity of, the monitoring of a dc system are dependent upon the criticality and remoteness of the application. IEEE Std 946-1992 provides typical recommendations for instrumentation, controls, and alarms for a nominal 125 V dc system for a generating station. These recommendations are also generally applicable for applications other than generating stations.

Systems are available for remote monitoring of battery and/or cell conditions, and parameters such as voltage, current, and temperature as desired to indicate battery condition.

<sup>9</sup>The numbers in brackets correspond to those of the bibliography in Annex A.

## Annex A

(informative)

### Bibliography

- [B1] IEEE Std 141-1993, IEEE Recommended Practice for Electric Power Distribution for Industrial Plants.
- [B2] IEEE Std 446-1995, IEEE Recommended Practice for Emergency and Standby Power Systems for Industrial and Commercial Applications.
- [B3] IEEE Std 666-1991 (Reaff 1996), IEEE Design Guide for Electric Power Service Systems for Generating Stations.
- [B4] NEMA AB 4-1996, Guidelines for Inspection and Preventive Maintenance of Molded Case Circuit Breakers Used in Commercial and Industrial Applications.
- [B5] NEMA PE 5-1996, Utility Type Battery Chargers.
- [B6] NEMA PE 7-1996, Communication Type Battery Chargers
- [B7] NFPA 14-1996, Installation of Standpipe and Hose Systems.
- [B8] "Short Circuit Calculating Procedure for DC Systems with Motors and Generators," *AIEE Transactions*, vol. 73, pt. III-A, 1954, pp. 816-824.
- [B9] Stevenson, W. D., Jr. *Elements of Power System Analysis*. 2d ed., McGraw-Hill, 1962.
- [B10] Uniform Building Code™, 1994.<sup>10</sup>

<sup>10</sup>This publication is available from the International Conference of Building Officials (IBCO), South Workman Mill Rd., Whittier, CA 90601.

## Annex B

(informative)

### DC system time constants

To protect dc circuits and battery systems, protective device manufacturers have traditionally re-rated their standard ac products. However, some manufacturers have given special attention to dc applications and the specific current clearing abilities required to safely open under a dc fault.

In addition to dc voltage and prospective fault current, an important aspect of clearing a dc fault is the system's short-circuit time constant. Fault currents in dc systems rise exponentially in accordance to the inductance and resistance of the system. The time constant ( $\tau$ ) of a dc circuit is:

$$\tau = \frac{L}{R}$$

where

$L$  is the inductance (H) of the system as seen by the protective device;  
 $R$  is the resistance ( $\Omega$ ) of the system as seen by the protective device.

By definition, the dc time constant is the time ( $t$ ) required for a physical quantity to rise from zero to 63.2% of its steady-state value, based on the following relationship:

$$i(t) = \frac{V}{R} \left( 1 - e^{-\frac{t}{\tau}} \right)$$

where

$i$  is dc current;  
 $V$  is dc voltage.

The short-circuit time constant gives a measure of how quickly the current will rise or fall under transient conditions. A longer time constant is indicative of more stored energy. This makes it more difficult to extinguish the arc.

The initial rate of rise of current is dependent upon the circuit  $L/R$  ratio. The higher the inductance, the slower the rate of rise. The slower rise increases the time needed for the fuse to reach its melting point and ultimately interrupt the circuit.

The impact of time constant on the interrupting capability of the protective device will vary according to the device and the value of the time constant. For example, many protective device manufacturers recommend a de-rating of the voltage for long time constants.

To summarize, the time constant is a very important, but often overlooked, factor in dc applications. If the manufacturer's protective device tested time constant is less than the circuit time constant, then the manufacturer should be consulted for the impact on the protective device's rating.

To further examine the role of dc time constants, consider Figure B.1, which shows a simple battery system. In this figure, the battery is modeled as an ideal voltage source,  $V_{\text{batt}}$ , for the purposes of short-circuit calcu-

lation. The resistance of the cells, the intercell connectors, and the external cables are lumped as  $R_{batt}$ . The inductance for the same components are lumped as  $L_{batt}$ . Also, it is assumed that a protective device eventually opens to isolate the short circuit by rapidly increasing its internal resistance. This is modeled as  $R_{arc}$  and initially has a zero resistance. The open switch closes at time  $t = 0$  to initiate the fault.

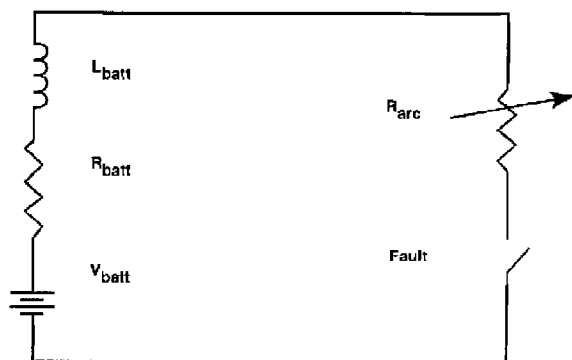

Figure B.1—Schematic of a simple battery system

Immediately after the fault is initiated, the current rises rapidly, based on the time constant,  $\tau = L_{batt}/R_{batt}$ . This circuit has a time constant of approximately 3 ms, as shown in Figure B.2.

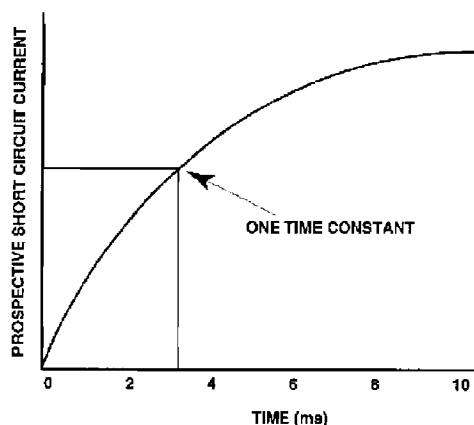

Figure B.2—Short-circuit current rise as a factor of time constant

Any change in current is opposed by the circuit inductance. Therefore a voltage is developed across  $L_{batt}$  as shown in Figure B.3 and in accordance with the relation:

$$V_L = L \frac{dI}{dt}$$

where

- $V_L$  is inductive voltage;
- $I$  is circuit current;
- $t$  is time.

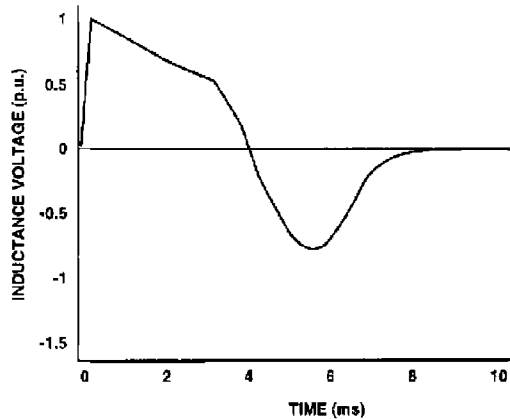

**Figure B.3—Circuit inductive voltage**

During this period, the inductance is absorbing energy. The larger the inductance, the more energy it can store. If there is no protective device to interrupt the current, it will continue rising to its full prospective value as shown in Figure B.2.

When a certain amount of time has elapsed with a high enough current, the protective device begins to open and an arc develops with a corresponding rise in the resistance  $R_{arc}$ . For fuses, this occurs when the weakest part of the fuse link completely melts and an arc is initiated. In the case of circuit breakers, this is the contact parting time. In Figure B.4 this occurs just before the peak.

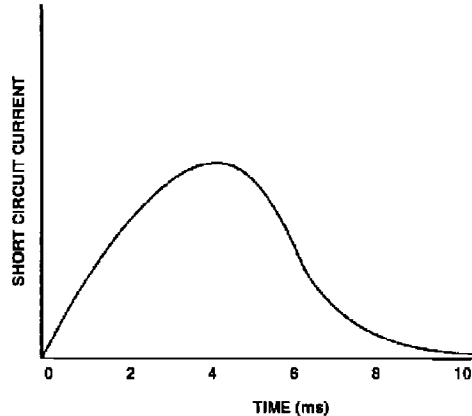

**Figure B.4—Short-circuit current interrupted by protective device**

Protective devices are designed to rapidly lengthen this arc and extinguish it. This causes a rapid rise in the value of  $R_{arc}$  to reduce the current flow. Once again, the circuit inductance will oppose this change in current. This is accomplished by the inductance voltage reversing as shown in Figure B.3. This reversal effectively applies more voltage across the protective device as shown in Figure B.5 to try to maintain the pre-arc current value. This voltage is usually higher than the nominal circuit voltage. During this time period, energy stored in the inductance is transferred to the arc. If the protective device operates properly, the current eventually goes to zero and the fault is isolated.

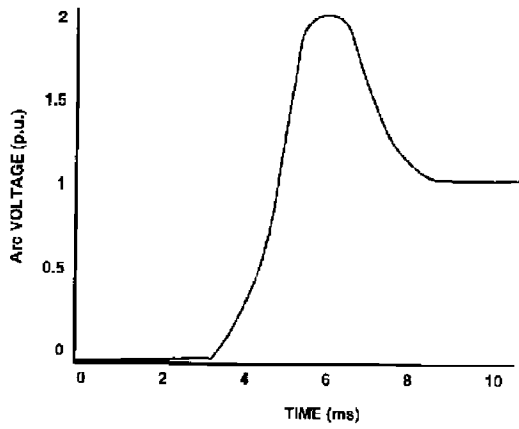

Figure B.5—Voltage applied across protective device

Thus, circuits with larger time constants are able to store more energy in their inductance. When a protective device is called upon to open, more energy has to be dissipated in the arc and the device shall be able to open under higher voltages.

## Annex C

(informative)

### Sample battery system time constant determination

This annex provides a method of analyzing dc system time constants for a stationary battery system, shown in Figure C.1. The time constants calculated in this example are the time constants of the fault current that will flow through, and be interrupted by, the protective device (in this case a fuse), not the time constants of the dc circuit. The stationary battery system (the circuit) in this example consists of a multi-cell battery bank with connecting cables to the main dc bus, a battery charger, a dc motor load, and a non-motor dc load whose cable is protected by a fuse. The battery charger and the dc loads are connected to the main dc bus.

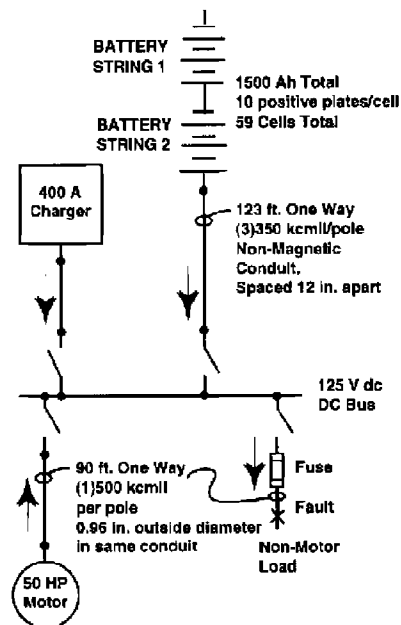

Figure C.1—Single-line diagram of sample battery system  
(arrows denote current flows for fault)

#### C.1 Analyzing the fault current time constant

In order to illustrate the combined effects of the battery, battery charger, and motor contributions to the time constant of the fault current, a short circuit is postulated within the circuit at the location labeled "Fault." This location within the circuit was chosen because the combined inductance and resistance from all circuit branches are seen by the same protective device. The value of the time constant of the short-circuit current will change for different fault locations in the dc system. Two fault locations are postulated in this example:

- A fault at the load side terminals of the fuse; and
- A fault at the non-motor load terminals protected by the fuse.

In each case, bolted faults without fault impedance are postulated.

To evaluate this stationary battery system for a short circuit at the postulated fault locations, the resistance and inductance of each circuit element have to be determined.

### C.1.1 The battery

The battery resistance can be calculated using the method given in Annex B of IEEE Std 946-1992. The internal resistance of a cell is calculated from the slope of the initial voltage line on the manufacturer's discharge characteristic curve for that cell. For this example:

$$R_p = \frac{2.0 \text{ V} - 1.85 \text{ V}}{97.5 \frac{\text{A}}{\text{positive}} - 14.5 \frac{\text{A}}{\text{positive}}}$$

$$R_p = 0.001807 \frac{\text{ohm}}{\text{positive}}$$

$$R_t = \frac{R_p}{10 \frac{\text{cell}}{\text{positive}}}$$

$$R_t = 0.000181 \frac{\text{ohm}}{\text{cell}}$$

$$R_{batt} = 59 \times \text{cell} \times R_t$$

$$R_{batt} = 0.0107 \text{ ohm}$$

where

- $R_p$  is the resistance per positive plate;
- $R_t$  is the total cell resistance;
- $R_{batt}$  is the total battery resistance.

The internal inductance of the battery can be determined based on

- a) The manufacturer's short-circuit current test profile;
- b) The geometry of the cells; or
- c) A generic time constant for batteries.

Since a battery cell does not consist of true resistance and inductance, but rather a chemical reaction that produces the voltage and current response, the calculated inductance in this example is largely an "apparent" inductance.

The battery manufacturer may be able to provide a short-circuit current-versus-time curve for a bolted fault at the battery's terminals (without a time constant shown). When this curve is available, the time constant of the battery can be derived from the curve, as described below, and the equivalent battery inductance calculated. Figure C.2 is an example of such a curve.

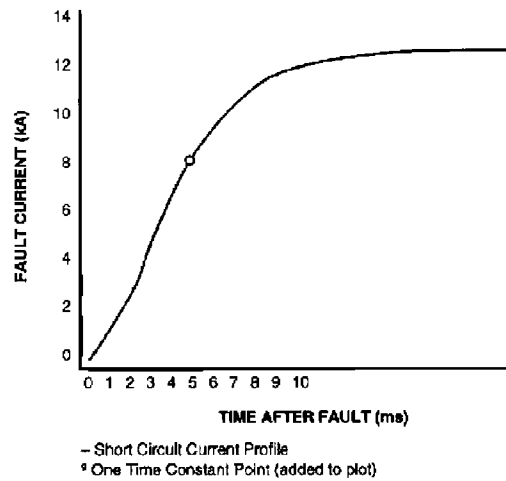

**Figure C.2—Battery short-circuit test**

The time constant derived from this figure is graphically estimated to be 2.75 ms based on the time for current to reach 63% of its maximum value. Using the relationship for the time constant of an RL circuit, the battery inductance can be determined as follows:

$$\tau_{batt} = 2.75 \text{ ms}$$

$$\tau = \frac{L}{R}$$

$$L_{batt} = \tau_{batt} \times R_{batt}$$

$$L_{batt} = 2.75 \text{ ms} \times R_{batt}$$

$$L_{batt} = 29.32 \text{ } \mu\text{s}$$

where

- $\tau_{batt}$  is the time constant of the battery;
- $L_{batt}$  is the equivalent battery inductance.

### C.1.2 The battery charger

Where a typical static battery charger with current limit only provides a substantial contribution to the fault (as compared to the total fault current) early in the event (first ac half-cycle) and its steep current rise tends to result in a shorter overall time constant, it can be neglected for the purposes of this example.

### C.1.3 The motor

DC motors will also contribute to a fault for a short period of time. A precise calculation of the current profile is very complex and depends upon many factors, some of which are not readily available from the motor nameplate or the motor manufacturer. Where the primary objective of this example is to conservatively estimate the longest time constant, a simpler approach to deriving the motor contribution to the circuit time constant is shown below. This simpler approach underestimates the rate of rise of the motor current, which results in a somewhat longer calculated time constant. An approximation of the short-circuit current contribution of the motor can be made using an exponential of the following form (this approximation is based on IEEE Std 666-1991 [B3] and "Short Circuit Calculating Procedure for DC Systems with Motors and Generators" [B8]):

$$I_a = \frac{V_{np}}{R'_d} \left( 1 - e^{-\frac{t}{\tau_{motor}}} \right)$$

$$\tau_{motor} = \frac{L'_a}{R'_d}$$

$$L'_a = \frac{19.1 \times C_x \times V_{np}}{P \times N_{np} \times I_{np}}$$

where

- $C_x$  is the inductance factor;
- $L'_a$  is the armature circuit unsaturated inductance (H);
- $P$  is the number of poles;
- $N_{np}$  is the base speed (rpm);
- $I_{np}$  is the nameplate rated current (A);
- $V_{np}$  is the nameplate rated voltage (V);
- $R'_d$  is the transient effective resistance of the armature circuit ( $\Omega$ ).

Values for  $R'_d$  and  $C_x$  should be obtained from the motor manufacturer. When these values are not available from the motor manufacturer, estimates for  $R'_d$  can be derived using Figure C.3. Values for  $C_x$  can be estimated as follows: 0.1 for motors with pole face windings and 0.4 for motors without pole face windings.

Determination of the decay profile is much more complicated and depends on several factors related to the field winding. The decay time usually ranges from 0.1 s to 1.0 s. The decay will be neglected for the purposes of calculating the initial time constant.

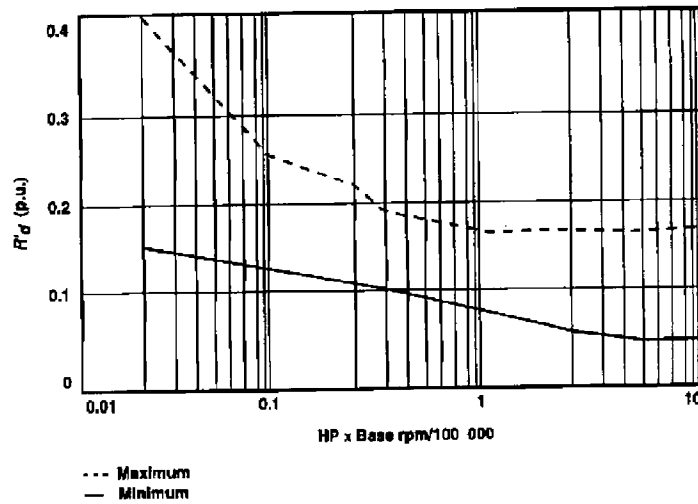

Figure C.3—Transient resistance of dc motor armature circuit

The data for the large hypothetical motor in the example circuit are as follows:

$$C_x = 0.4$$

$$V_{np} = 125 \text{ V}$$

$$I_{np} = 340 \text{ A}$$

$$\text{HP} = 50$$

$$N_{np} = 3500 \text{ rpm}$$

$$P = 4 \text{ poles}$$

Solving the above equations yields the following results:

$$I'_a = \frac{19.1 \times C_x \times V_{np}}{P \times N_{np} \times I_{np}}$$

$$L'_a = 0.201 \text{ mH}$$

$$R'_{d\_pu} = 0.06 \text{ per unit}$$

$R'_{d\_pu}$  is derived from Figure C.3 by calculating the X axis location (HP times the base rpm divided by 100 000) and identifying where it intersects the minimum  $R'_d$  (p.u.) curve. For this example, the X axis location of Figure C.3 is  $50 \text{ HP} \times 3500 \text{ rpm}/100\,000 = 1.75$ . This X axis location intersects the minimum  $R'_d$  (p.u.) curve at approximately 0.06 p.u.

NOTE—The minimum  $R'_d$  (p.u.) curve is used because it results in the longest time constant and highest peak current, based on the equations for  $\tau_{\text{motor}}$  and  $I'_a$ .

$$R'_d = R'_{d-PW} \frac{V_{np}}{I_{np}}$$

$$R'_d = 0.022 \text{ ohms}$$

$$\tau_{motor} = \frac{L'_d}{R'_d}$$

$$\tau_{motor} = 9.1 \text{ ms}$$

### C.1.4 Cable contribution to time constant

The battery cables can have a significant affect on the circuit time constant where most of the fault current will be supplied by the battery.

The dc resistance of cable is available in a number of wire tables and can be derived directly from the tables. The inductance of the cable can sometimes be estimated from the 60 Hz reactance tables by using the ohms-to-neutral value, dividing by  $2 \times \pi \times 60$ , and multiplying by 2 times the cable length. This is accurate only when the dc return conductor and configuration match the assumptions of the table. However, for the battery cables in this example, no suitable table could be found since the configuration is not one that would be normally used in an ac system. Therefore, the cable inductance is calculated using the basic equations for a transmission line (refer to Elements of Power System Analysis [B9] for a discussion of the calculation of transmission line cable impedances).

Figure C.4 shows the battery cables (350 kcmil triplex cable per pole) without the conduit, i.e., one triplex bundle contains the positive conductors and the other triplex bundle contains the negative conductors.

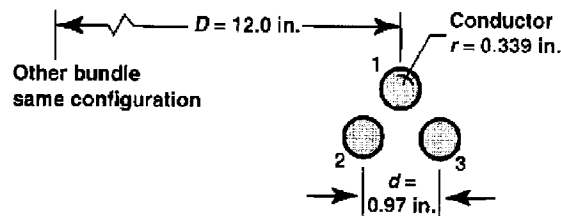

Figure C.4—Battery cable configuration

The one-way length of the cable is 123 ft. The one-way dc resistance of a single conductor at 25 °C is:

$$R_{350} = 0.0308 \frac{\text{ohm}}{\text{Mft}}$$

$$D = 12.0 \text{ in}$$

$$d = 0.97 \text{ in}$$

$$r = 0.339 \text{ in}$$

For two identical cable bundles (the positive and negative poles) separated by a large distance as compared to the bundle diameter, in free space, the cable resistance and inductance are:

$$GMR = [(r' \times d_{12} \times d_{13})(r' \times d_{21} \times d_{23})(r' \times d_{31} \times d_{32})]^{\frac{1}{3}}$$

$$L_{\text{total}} = (4 \times 10^{-7}) \times \ln\left(\frac{D}{GMR}\right) \times \frac{\text{henry}}{\text{meter}}$$

where

- $GMR$  is the geometric mean radius of each bundle (in);
- $d_{a,b}$  is the distance of conductor a to conductor b in the same cable bundle;
- $r'$  is the self GMR of a single conductor in the cable bundle;
- $L_{\text{total}}$  is the total self and mutual inductance of the positive and negative cables.

The above equation for the GMR of the cable bundle can be simplified where the distance between conductors for the cable bundle are the same (i.e.,  $d_{12} = d_{13} = d_{21} = d_{23} = d_{31} = d_{32}$ ).

Therefore,

$$GMR = (r')^{\frac{1}{3}} \times (d)^{\frac{2}{3}}$$

$r' = 0.260$  in (derived from wire tables for the self GMR of a 37-strand 350 kcmil copper conductor);

$GMR = 0.625$  in; and

$$L_{\text{total}} = (1.18 \times 10^{-6}) \times \frac{\text{henry}}{\text{meter}}; \text{ or}$$

$$L_{\text{total}} = 0.36 \times \frac{\text{microhenry}}{\text{foot}}$$

The total inductance ( $L_{\text{bcable}}$ ) and resistance ( $R_{\text{bcable}}$ ) of the battery cables are:

$$L_{\text{bcable}} = 123 \text{ ft} \times L_{\text{total}}$$

$$L_{\text{bcable}} = 44.3 \times \mu\text{H}$$

$$R_{\text{bcable}} = \frac{2}{3} \times 123 \text{ ft} \times R_{350}$$

$$R_{\text{bcable}} = 0.00253 \times \text{ohm}$$

NOTE—In the equation  $R_{\text{bcable}}$ , the factor of 2/3 is used to account for the total circuit length (multiplying by 2 to account for the return cable length) and the number of conductors per pole (dividing by 3 for 3 conductors per pole).

The impedance of the motor feeder cable shown in Figure C.5 can be calculated in a manner similar to the battery cable.

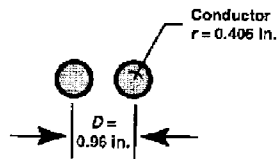

Figure C.5—Motor load and non-motor load cable configurations

The motor feeder cable is a one 500 kcmil conductor rated 600 V per pole with a length of 90 ft. The impedance of this cable is calculated as follows:

$$R_{500} = 0.0216 \frac{\text{ohm}}{1000 \text{ ft}}$$

$$D = 0.96 \text{ in}$$

$$r = 0.406 \text{ in}$$

$$GMR = 0.313 \text{ in}$$

$$L_{motor} = (4 \times 10^{-7}) \times 1\pi \left( \frac{D}{GMR} \right) \times \frac{\text{henry}}{\text{meter}}$$

$$L_{ncable} = 90 \text{ ft} \times L_{motor}$$

$$L_{ncable} = 12.3 \times \mu\text{H}$$

$$R_{ncable} = 2 \times 90 \text{ ft} \times R_{500}$$

$$R_{ncable} = 0.0039 \times \text{ohm}$$

The non-motor load cable is also a one 500 kcmil conductor rated 600 V per pole with a length of 90 ft. Therefore, the impedance of this cable is also:

$$L_{lcable} = 12.3 \times \mu\text{H}$$

$$R_{lcable} = 0.0039 \times \text{ohm}$$

### C.1.5 The time constant at the fault

An estimate of the time constant of the fault current flowing through the fuse can be made by combining the parallel and series resistances into one equivalent resistance ( $R_{eq}$ ) and the parallel and series inductances into one equivalent inductance ( $L_{eq}$ ). Note that this is an approximation where branch circuits with different L/R ratios will not combine into a single exponential curve.

For a bolted fault at the load side terminals of the fuse, see Figure C.6.

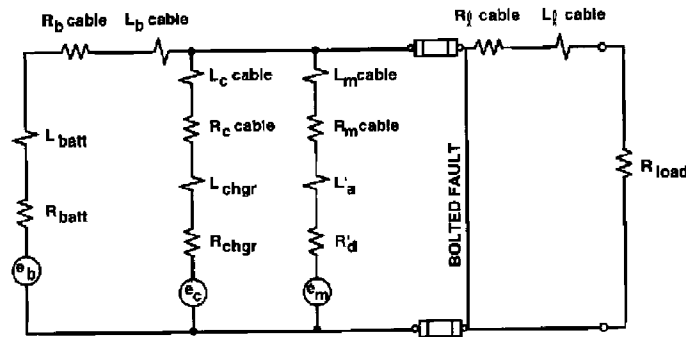

$e_b$  = The battery voltage behind the fault

$e_c$  = The charger voltage behind the fault

$e_m$  = The motor counter emf

**Figure C.6—Equivalent circuit with bolted fault at the fuse load side terminals**

The equivalent resistance and inductance of the circuit as well as the time constant of the fault current flowing through the fuse for a bolted fault located at the load side terminals of the fuse are as follows:

$$R_{eq} = \frac{1}{\left( \frac{1}{R_{batt} + R_{bcable}} + \frac{1}{R'_d + R_{mcable}} \right)}$$

$$R_{eq} = 0.0087 \text{ ohm}$$

$$L_{eq} = \frac{1}{\left( \frac{1}{L_{batt} + L_{bcable}} + \frac{1}{L'_a + L_{mcable}} \right)}$$

$$L_{eq} = 54.7 \text{ } \mu\text{H}$$

$$\tau_{eq} = \frac{L_{eq}}{R_{eq}}$$

$$\tau_{eq} = 6.26 \text{ ms}$$

For a bolted fault at the non-motor load terminals, see Figure C.7.

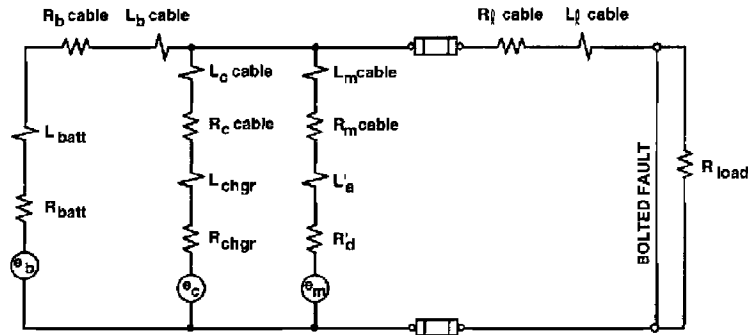

- $e_b$  = The battery voltage behind the fault
- $e_c$  = The charger voltage behind the fault
- $e_m$  = The motor counter emf

**Figure C.7—Equivalent circuit with bolted fault at the non-motor load terminals**

A change in the location of the fault will result in a different value of the time constant. A bolted fault at the terminals of the non-motor load will cause a change in the value of the time constant for the current flowing through the fuse as a result of the added series resistance and inductance of the load cable. The time constant for the fault current to be interrupted by the fuse for a bolted fault at the non-motor load terminals is as follows:

$$R_{eq} = \frac{1}{\left( \frac{1}{R_{batt} + R_{bcable}} + \frac{1}{R'_d + R_{mcable}} \right)} + R_{lcable}$$

$$R_{eq} = 0.0126 \text{ ohm}$$

$$L_{eq} = \frac{1}{\left( \frac{1}{L_{batt} + L_{bcable}} + \frac{1}{L'_a + L_{mcable}} \right)} + L_{lcable}$$

$$L_{eq} = 67 \text{ } \mu\text{H}$$

$$\tau_{eq} = \frac{L_{eq}}{R_{eq}}$$

$$\tau_{eq} = 5.3 \text{ ms}$$

In the case of a bolted fault at the non-motor load terminals, the added series resistance and inductance of the load cable results in a lower time constant (not as long) and there will be a lower peak fault current where there is a higher equivalent resistance.

STD.IEEE 1375-ENGL 1998 ■ 4805702 0559814 809 ■

**To order IEEE standards...**

Call 1. 800. 678. IEEE (4333) in the US and Canada.

*Outside of the US and Canada:*

1. 732. 981. 0600

*To order by fax:*

1. 732. 981. 9667

*IEEE business hours: 8 a.m.-4:30 p.m. (EST)*

**For on-line access to IEEE standards information...**

*Via the World Wide Web:*

<http://standards.ieee.org/>

*Via ftp:*

[stdsbs.ieee.org](ftp://stdsbs.ieee.org)

ISBN 0-7381-0187-7



ISBN 0-7381-0187-7