

# IEEE Guide for Service to Equipment Sensitive to Momentary Voltage Disturbances

Sponsor

**Transmission and Distribution Committee  
of the  
IEEE Power Engineering Society**

Approved March 16, 1995

**IEEE Standards Board**

Corrected Edition

*Second Printing*

**Abstract:** Computers, computer-like products, and equipment using solid-state power conversion have created entirely new areas of power quality considerations. There is an increasing awareness that much of this new user equipment is not designed to withstand the surges, faults, and reclosing duty present on typical distribution systems. Momentary voltage disturbances occurring in ac power distribution and utilization systems, their potential effects on this new, sensitive, user equipment, and guidance toward mitigation of these effects are described. Harmonic distortion limits are also discussed.

**Keywords:** disturbance analyzers, faults, harmonic distortion, momentary voltage disturbances, noise, power conditioners, sensitive equipment, surge protection, surges

---

The Institute of Electrical and Electronics Engineers, Inc.  
345 East 47th Street, New York, NY 10017-2394, USA

Copyright © 1995 by the Institute of Electrical and Electronics Engineers, Inc.  
All rights reserved. Published 1995. Printed in the United States of America.

ISBN 1-55937-528-0

*No part of this publication may be reproduced in any form, in an electronic retrieval system or otherwise, without the prior written permission of the publisher.*

**IEEE Standards** documents are developed within the Technical Committees of the IEEE Societies and the Standards Coordinating Committees of the IEEE Standards Board. Members of the committees serve voluntarily and without compensation. They are not necessarily members of the Institute. The standards developed within IEEE represent a consensus of the broad expertise on the subject within the Institute as well as those activities outside of IEEE that have expressed an interest in participating in the development of the standard.

Use of an IEEE Standard is wholly voluntary. The existence of an IEEE Standard does not imply that there are no other ways to produce, test, measure, purchase, market, or provide other goods and services related to the scope of the IEEE Standard. Furthermore, the viewpoint expressed at the time a standard is approved and issued is subject to change brought about through developments in the state of the art and comments received from users of the standard. Every IEEE Standard is subjected to review at least every five years for revision or reaffirmation. When a document is more than five years old and has not been reaffirmed, it is reasonable to conclude that its contents, although still of some value, do not wholly reflect the present state of the art. Users are cautioned to check to determine that they have the latest edition of any IEEE Standard.

Comments for revision of IEEE Standards are welcome from any interested party, regardless of membership affiliation with IEEE. Suggestions for changes in documents should be in the form of a proposed change of text, together with appropriate supporting comments.

Interpretations: Occasionally questions may arise regarding the meaning of portions of standards as they relate to specific applications. When the need for interpretations is brought to the attention of IEEE, the Institute will initiate action to prepare appropriate responses. Since IEEE Standards represent a consensus of all concerned interests, it is important to ensure that any interpretation has also received the concurrence of a balance of interests. For this reason IEEE and the members of its technical committees are not able to provide an instant response to interpretation requests except in those cases where the matter has previously received formal consideration.

Comments on standards and requests for interpretations should be addressed to:

Secretary, IEEE Standards Board  
445 Hoes Lane  
P.O. Box 1331  
Piscataway, NJ 08855-1331  
USA

IEEE Standards documents may involve the use of patented technology. Their approval by the Institute of Electrical and Electronics Engineers does not mean that using such technology for the purpose of conforming to such standards is authorized by the patent owner. It is the obligation of the user of such technology to obtain all necessary permissions.

*On page 3, the second item in the list in 3.1.8 has been corrected to read “2 s” rather than “2 min”.*

## Introduction

(This introduction is not a part of IEEE Std 1250-1995, IEEE Guide for Service to Equipment Sensitive to Momentary Voltage Disturbances.)

This guide was developed out of an increasing awareness of the incompatibility of modern electronics equipment with a normal power system environment. Simply put, much new user equipment is not designed to withstand the surges, faults, and reclosing duty present on typical electric utility distribution systems or within the user's facility.

This guide describes the operating environment of sensitive utilization equipment, identifies potential problem areas, and suggests effective ways to satisfy its special voltage requirements. Cooperation among users, utilities, and equipment designers is needed to ensure both adequate electric service to all users and proper equipment operations. Solutions are presented from the perspectives of both the customer and the utility provider, since the problems users of sensitive equipment experience often originate from either area.

The Working Group on Distribution Voltage Quality, which undertook the development of this guide, had the following membership:

### **Daniel J. Ward, *Chair***

M. Andresen	G. C. Hensley	K. Price
R. Archibald	M. D. Higgins	G. B. Rauch
R. H. Arndt	L. Hong	J. M. Roberts
V. Basch	M. B. Hughes	J. A. Roiz
R. Bergeron	M. J. Kempker	S. Sabir
A. J. Braun	T. S. Key	N. K. Saini
J. F. Buch	D. Kreiss	A. N. St. John
J. J. Burke	T. M. Kulas	M. Samotyj
D. M. Chamberlin	A. Kusko	L. M. Saulsman
L. Clark	J. A. LaPoint	W. E. Schwabe
L. E. Conrad	J. Lamoree	R. J. Serocki
T. M. Croushore	J. Lemke	M. T. Sheehan
A. J. Csomay	F. D. Martzloff	G. Shomo
A. Domijan	A. McEachern	T. A. Short
P. E. Eichin	M. F. McGranaghan	J. C. Smith
A. E. Emanuel	J. C. McIver	K. Srinivasan
R. C. Ender	H. Mehta	R. P. Stratford
T. J. Gentile	W. A. Moncrief	J. E. Sullivan
T. N. Gerstnecker	L. Morgan	R. S. Thallam
R. S. Glickman	A. G. Morinec	B. Tobin
W. M. Grady	R. C. Mukherji	H. Tram
T. Grebe	J. E. Mungenast	D. B. Vannoy
D. C. Griffith	T. H. Ortmeyer	M. Waclawiak
E. W. Gunther	D. J. Pileggi	V. Wagner
D. P. Hartmann		S. G. Whisenant

In addition to the working group members, the following people contributed their experience and knowledge to this guide:

T. M. Gruz	C. L. Rudasill	D. R. Smith
------------	----------------	-------------

The following persons were on the balloting committee:

James E. Applequist	George G. Karady	R. J. Piwko
J. F. Buch	Nestor Kolcio	F. S. Prabhakara
James J. Burke	Robert E. Lee	Edward W. Reid
I. S. Grant	Thomas J. McDermott	Dennis Reisinger
J. W. Janischewsky	Franklin D. Myers	B. R. Shperling
J. G. Kappenman	D. L. Nickel	Daniel J. Ward
	Stig L. Nilsson	

When the IEEE Standards Board approved this standard on March 16, 1995, it had the following membership:

**E. G. “Al” Kiener, *Chair***

**Donald C. Loughry, *Vice Chair***

**Andrew G. Salem, *Secretary***

Gilles A. Baril  
Clyde R. Camp  
Joseph A. Cannatelli  
Stephen L. Diamond  
Harold E. Epstein  
Donald C. Fleckenstein  
Jay Forster\*  
Donald N. Heirman

Richard J. Holleman  
Jim Isaak  
Ben C. Johnson  
Sonny Kasturi  
Lorraine C. Kevra  
Ivor N. Knight  
Joseph L. Koepfinger\*  
D. N. “Jim” Logothetis  
L. Bruce McClung

Marco W. Migliaro  
Mary Lou Padgett  
John W. Pope  
Arthur K. Reilly  
Gary S. Robinson  
Ingo Rusch  
Chee Kiow Tan  
Leonard L. Tripp

\*Member Emeritus

Also included are the following nonvoting IEEE Standards Board liaisons:

Satish K. Aggarwal  
Richard B. Engelman  
Robert E. Hebner  
Chester C. Taylor

Paula M. Kelty  
*IEEE Standards Project Editor*

# Contents

CLAUSE	PAGE
1. Overview.....	1
1.1 Scope.....	1
1.2 Problem definition .....	1
1.3 Purpose of guide .....	1
2. References.....	2
3. Terminology.....	2
3.1 Definitions .....	2
3.2 Differing usage of technical terms.....	4
4. Electrical environment .....	6
4.1 Steady-state voltage .....	6
4.2 Momentary disturbances.....	7
4.3 Causes of momentary disturbances.....	7
4.4 Identifying and quantifying the causes .....	11
4.5 Harmonic distortion .....	12
5. Sensitive loads .....	14
5.1 Types of sensitive loads.....	14
5.2 Ride-through capability .....	16
6. Solutions .....	17
6.1 Utility-side solutions.....	17
6.2 Customer-side solutions.....	18
6.3 Additional problems and solutions .....	31
Annex Bibliography .....	32
A.1 Standards.....	32
A.2 Texts.....	32
A.3 Technical papers .....	33

# IEEE Guide for Service to Equipment Sensitive to Momentary Voltage Disturbances

## 1. Overview

### 1.1 Scope

This guide describes momentary voltage disturbances (short-duration transients) occurring in ac power distribution and utilization systems, their potential effects on sensitive equipment, and guidance toward mitigation of these effects. Also provided is a description of the operating environment of sensitive utilization equipment as well as information on harmonic distortion limits.

### 1.2 Problem definition

Computers, computer-like products, and equipment using solid-state power conversion have created entirely new areas of power quality considerations. There is an increasing awareness that much of this new user equipment is not designed to withstand the surges, faults, and reclosing duty present on typical distribution systems. In addition to the usual steady-state concerns, designers and users of these types of equipment, as well as suppliers of utilities, are concerned with transients, brief momentary disturbances, and harmonics of these often sensitive loads.

Most voltage problems associated with computers and other sensitive equipment are related to not only high or low steady-state voltage levels, but also to momentary voltage disturbances, such as surges, sags, interruptions, or rapid changes in voltage. The starting of a large motor, for example, can result in voltage sag due to the high inrush current. A fault on the utility lines, even though cleared, can result in a momentary sag, surge, or interruption. Momentary voltage disturbances may result from a wide variety of causes on a utility system or within a user's facility.

Site monitoring with disturbance recorders helps to identify the nature of the problem and the frequency of occurrence. Such information can then be correlated to events on either side of the meter to help identify possible solutions. However, difficulty often arises in matching recorded disturbances to equipment sensitivities.

A variety of power-conditioning equipment is available to buffer the sensitive load from various disturbances (and in some cases, from harmonics) where necessary. Ideally, the power-quality tolerance of the particular sensitive equipment should be analyzed to determine the proper solution; however, this information is often unknown. In addition, the user should be aware of some of the nonlinear characteristics of certain types of conditioning equipment.

### 1.3 Purpose of guide

Equipment application problems exist today because of certain incompatibilities among the sensitive equipment and various disturbances present on typical power systems. Some of the newer sensitive loads are particularly vulnerable to momentary disturbances. In addition, some of these loads introduce considerable harmonic content into the system and can be detrimental to other equipment in the area. Because of increasing use of computers and other sensitive equipment, such problems will continue to grow unless corrective measures are taken.

The primary purpose of this guide is to assist in identifying potential problems and to suggest effective ways to satisfy sensitive equipment voltage requirements. This discussion should provide insight into the distinction between those voltage-related problems that are controlled by the utility and those that can only be addressed by the user or equipment designer. Cooperation among users, utilities, and equipment designers is needed to ensure both adequate electric service to all users and proper equipment operations. Solutions are presented from the perspectives of both the customer and the utility provider, since the problems users of sensitive equipment experience often originate from either area.

The secondary purpose of this guide is to help provide the designers of sensitive equipment with an understanding of the environment in which their equipment is expected to operate.

## 2. References

This guide shall be used in conjunction with the following publications. When the following standards are superseded by an approved revision, the revision shall apply:

ANSI C84.1-1989, American National Standard Voltage Ratings (60 Hz) for Electric Power Systems and Equipment.<sup>1</sup>

IEEE Std 100-1992, The New IEEE Standard Dictionary of Electrical and Electronics Terms (ANSI).<sup>2</sup>

IEEE C62.1-1989 (Reaff 1994), IEEE Standard for Gapped Silicon-Carbide Surge Arresters for AC Power Circuits (ANSI).

IEEE Std C62.41-1991, IEEE Recommended Practice on Surge Voltages in Low-Voltage AC Power Circuits (ANSI).

## 3. Terminology

### 3.1 Definitions

Whenever possible, the definitions of the terms used in this guide are those found in IEEE Std 100-1992<sup>3</sup> or Std 1100-1992 [B7].<sup>4</sup> In some instances, the IEEE definition in the current dictionary may be either too broad or too restrictive; in such a case, an additional definition is included in this subclause.

**3.1.1 clamping voltage:** The maximum magnitude of voltage across a surge-protective device during the passage of a specified surge current (e.g., 100 A, 8/20  $\mu$ s waveshape).

**3.1.2 distortion factor:** The ratio of the rms of the harmonic content to the rms value of the fundamental quantity, often expressed as a percent of the fundamental. *Syn:* **total harmonic distortion**. *See also:* **harmonic distortion**.

**3.1.3 flicker:** A perceptible change in electric light source intensity due to a fluctuation of input voltage.

NOTE—The general meaning of this term could make it applicable to describe the pulsation of luminous flux from a low-inertia source (such as gas discharge lamps) caused by the zero crossings of the supply voltage at twice the power-system frequency. However, in the context of power supply disturbances, the term applies to perceptible, subjective, objectionable, and random or periodic variations of the light output.

<sup>1</sup>ANSI publications are available from the Sales Department, American National Standards Institute, 11 West 42nd Street, 13th Floor, New York, NY 10036, USA.

<sup>2</sup>IEEE publications are available from the Institute of Electrical and Electronics Engineers, 445 Hoes Lane, P.O. Box 1331, Piscataway, NJ 08855-1331, USA.

<sup>3</sup>The numbers in brackets correspond to those of the references in clause 2.

<sup>4</sup>The numbers in brackets preceded by the letter B correspond to those of the bibliography in the annex.

**3.1.4 ground loop:** A potentially detrimental loop formed when two or more points in an electrical system that are nominally at ground potential are connected by a conducting path such that either or both points are not at the same ground potential.

**3.1.5 harmonic:** A sinusoidal component of a periodic wave having a frequency that is an integral multiple of the fundamental frequency.

**3.1.6 harmonic distortion:** The mathematical representation of the distortion of a pure sine waveform. *See also:* **distortion factor; total harmonic distortion.**

**3.1.7 impulse:** A surge of unidirectional polarity, for example, a 1.2/50  $\mu$ s voltage surge.

NOTE—This usage conforms to that in IEC documents.

**3.1.8 interruption:** The complete loss of voltage for a time period. The time-base of the interruption is characterized as follows:

- Instantaneous: 0.5 to 30 cycles
- Momentary: 30 cycles to 2 s
- Temporary: 2 s to 2 min
- Sustained: greater than 2 min

**3.1.9 linear load:** An electrical load device that, in steady-state operation, presents an essentially constant load impedance to the power source throughout the cycle of applied voltage.

**3.1.10 momentary disturbance:** A variation in the level of the steady-state supply voltage that results from surges, sags, faults, circuit and equipment switching, or from the operation of circuit breakers or reclosers resulting from their response to abnormal circuit conditions. *See also:* **transient.**

**3.1.11 noise:** Unwanted electrical signals that produce undesirable effects in the circuits of the control systems in which they occur. (For this guide, “control systems” include sensitive electronic equipment in total or in part.)

**3.1.12 nonlinear load:** Electrical load that draws current discontinuously or whose impedance varies during the cycle of the input ac voltage waveform.

**3.1.13 notch:** A transient reduction in the magnitude (absolute value) of the quasi-sinusoidal mains voltage. (The duration is always less than a half-cycle and usually less than a few milliseconds.) *See also:* **sag; undervoltage.**

**3.1.14 overvoltage:** An rms increase in the ac voltage, at the power frequency, for durations greater than a few seconds. *See also:* **surge; swell.**

**3.1.15 permanent fault:** One that will persist regardless of how fast the system is de-energized or the number of times that the system is de-energized and re-energized.

**3.1.16 power factor, total:** The ratio of the total power input in watts to the total voltampere input.

**3.1.17 ride-through capability:** The ability of equipment to withstand momentary interruptions or sags.

**3.1.18 sag:** An rms reduction in the ac voltage, at the power frequency, for durations from a half-cycle to a few seconds. *See also:* **notch; undervoltage.**

NOTE—The IEC terminology is *dip*.

**3.1.19 SPD:** Surge-protective device.

**3.1.20 surge:** A transient wave of voltage or current. (The duration of a surge is not tightly specified, but it is usually less than a few milliseconds.) *See also:* **overvoltage; swell.**

**3.1.21 surge-protective device (SPD):** A device intended to either limit transient overvoltages or divert surge currents or both. It contains at least one nonlinear component.

**3.1.22 swell:** An rms increase in the ac voltage, at the power frequency, for durations from a half-cycle to a few seconds. *See also:* **overvoltage; surge.**

**3.1.23 TDD:** Total demand distortion.

**3.1.24 temporary fault:** One that may be self-clearing, or may be cleared if the faulted circuit is rapidly de-energized by opening of a protective device, such as a circuit breaker or recloser.

**3.1.25 THD:** Total harmonic distortion.

**3.1.26 total demand distortion (TDD):** The total rms current distortion in percent of maximum demand current.

**3.1.27 total harmonic distortion (THD):** The ratio of the rms value of the sum of the squared individual harmonic amplitudes to the rms value of the fundamental frequency of a complex waveform. *Syn:* **distortion factor.**

**3.1.28 transient:** Any disturbance with a duration of less than a few cycles. *See also:* **notch; sag; surge; swell.**

**3.1.29 undervoltage:** An rms decrease in the ac voltage, at the power frequency, for durations greater than a few seconds. *See also:* **notch; sag.**

**3.1.30 voltage distortion:** Any deviation from the nominal sine wave of the ac line voltage.

## 3.2 Differing usage of technical terms

Some of the terms used to describe voltage disturbances are defined differently by utility engineers and by manufacturers and users of disturbance analyzers and power conditioners [B25]. Table 1 defines the terms, and figure 1 illustrates the waveforms, as they are commonly understood by these two groups.

**Table 1—Voltage terminology differences**

Term	Utility meaning	Monitoring equipment manufacturer or user meaning
Impulse	Unidirectional surge	Same
Momentary interruption	Complete loss of line voltage for a duration of 30 cycles to 2 min, while automatic equipment is acting to resolve an abnormal circuit condition	Complete loss of line voltage for a duration of a half-cycle or more
Notch	An impulse that subtracts from the fundamental frequency wave	Same
Sustained interruption	The complete loss of line voltage for a duration greater than 2 min	Complete loss of line voltage for a duration of half-cycle or more
Sag	Momentary undervoltage at fundamental frequency lasting from a half-cycle to a few seconds	Same
Surge	Unidirectional surge	Momentary overvoltage at fundamental frequency lasting from a half-cycle to a few seconds
Swell	Momentary overvoltage at fundamental frequency lasting from a half-cycle to a few seconds	Same







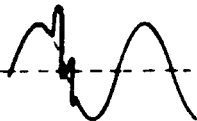
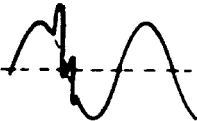
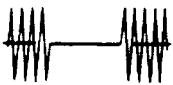
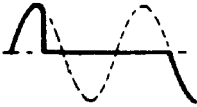
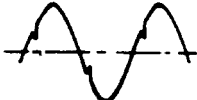
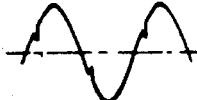

Term	Utility Meaning	Monitoring Equipment Manufacturer or User Meaning
Impulse		
Momentary Interruption		
Notch		
Sustained Interruption		
Sag (dip)		
Surge		
Swell		

Figure 1—Voltage terminology differences

*Power quality* is a broadly used term that has been applied to voltage, service availability, and even harmonic content. Except for clause 1, this guide has purposely avoided the use of this term.

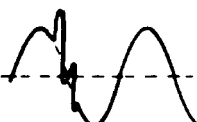
*Voltage quality* is a term used to describe the relative amount of voltage disturbances or variations—particularly interruptions, sags, surges, and harmonics—as measured at a specific point. This usage of the term, applied from a utility viewpoint, refers to the quality level measured at the point of service; from the customer viewpoint, it refers to the quality level measured at the point of utilization. At the point of utilization, a customer’s perception of poor voltage quality may result from disturbances elsewhere on the customer’s system, from a nearby customer, or from the utility system. Specific voltage quality requirements, from the customer viewpoint, can differ from one customer to another, and depend on the special needs of the equipment involved.

## 4. Electrical environment

### 4.1 Steady-state voltage

Over the years, electric utility companies, equipment manufacturers, and end-users have cooperated in establishing standards for operating voltage limits that have resulted in satisfactory operation without excessive demands upon the design of the power supply or the utilization equipment. As a result of this cooperative effort, the American National Standards Institute (ANSI) has developed and published ANSI C84.1-1989. This standard is concerned with the range of steady-state voltage levels and is not related to momentary disturbances.

Figure 2 illustrates the standard voltage range for service (meter) and utilization (load) voltages from ANSI C84.1-1989. The customer’s utilization voltage is based on the utility meeting the service requirements plus an additional allowance for voltage drop in the customer’s wiring.

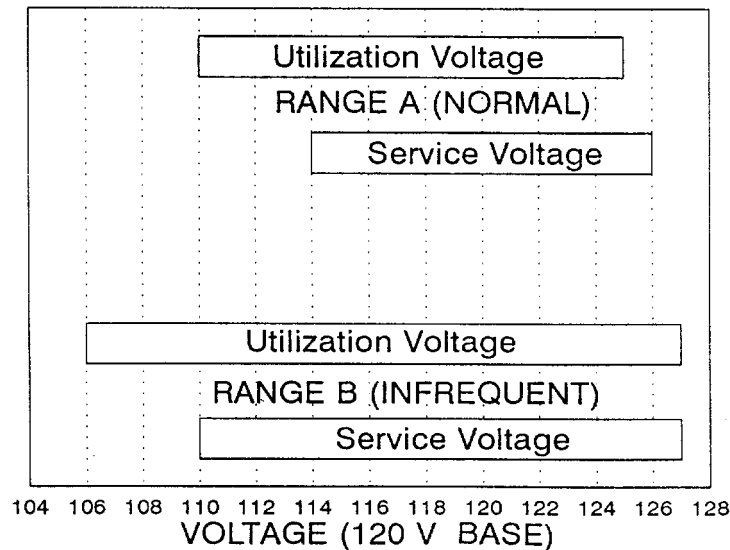

Source: ANSI C84.1-1989. Reprinted with permission from the American National Standards Institute, © 1989.

**Figure 2—Voltage ranges**

The Range A values of ANSI C84.1-1989 are defined in that standard as the span over which supply systems shall be designed and operated under normal conditions. Supply voltage variations outside Range A limits are to be infrequent. Voltage Range B levels are allowable provided they occur infrequently and are of limited duration. Note that the utilization range is within the steady-state tolerance of typical computer equipment (and most sensitive equipment) as shown in figure 8.

## 4.2 Momentary disturbances

Electrical utility and utilization supply systems are designed to provide an adequate and reliable voltage supply to meet the basic needs of all users. Normally, both utility and utilization systems used for the production and distribution of electricity are subjected to unexpected momentary variations from both natural and man-made disturbances. As a result, most electrical systems will experience certain voltage disturbances.

Some electric and electronic equipment, because of special sensitivities, may require a voltage supply that has fewer momentary disturbances than what is otherwise adequate. The nature of the offending disturbances, severity, incidence rate, effects on sensitive equipment, and the degree of control will vary.

## 4.3 Causes of momentary disturbances

Voltage disturbances may be a problem to certain users of sensitive equipment if they cause lost or spurious data, false triggering, or other equipment failure.

Many of these disturbances are generated at the user's facility by user equipment; others result from an event on the utility system, such as lightning and equipment switching; others may be generated by other user-owned equipment on adjacent circuits.

### 4.3.1 Lightning

Lightning-related surges in the low-voltage system can either occur from direct strikes to the customer's service or by induction from strokes elsewhere.

Lightning can cause surges at loads and commonly leads to sags or momentary interruptions as a result of temporary faults (including arrester operation) initiated by lightning [B20]. Some lightning-induced transients cause the tripping and automatic reclosing of protective switchgear. Such operations are similar to those caused by line-to-ground faults from tree limbs and other objects grounding or short-circuiting transmission or distribution lines. The fault is detected and is momentarily disconnected by protective switchgear long enough for an arcing fault to extinguish and then the circuit is automatically reconnected at intervals of 0.5 s to a few seconds. This results in a momentary total loss of voltage on the faulted circuit and possibly voltage sags on other feeders sharing the same source as the faulted circuit. At the same time that a line-to-ground fault occurs on a multi-grounded neutral distribution system, voltage swells on the unfaulted phases may be experienced.

The frequency and severity of lightning vary geographically. One study involving more than 400 locations with 120 V services revealed several lightning-caused surge occurrences above 3000 V at the service entrance, with one reaching 5600 V [B26].

### 4.3.2 Faults (short circuits)

Faults on the utility system are classified as either temporary or permanent. The normal utility overcurrent protective practice is based on the fact that most faults (on overhead systems) are temporary or can be selectively isolated in order to restore the remainder of the system.

Temporary faults may be due to a flashover from a lightning stroke, an animal contact, wind, etc. When a fault occurs, the line should be de-energized to stop the flow of fault current and to allow enough time to deionize the faulted path. To do this, a circuit breaker or line recloser opens to clear the fault, and then automatically recloses after some time delay. This reclosing can occur several times in an effort to re-establish continuity of service following a temporary fault. Dead times (zero voltage) between reclosures are shown in the current trace of figure 3 for a two-shot reclosing operation for a permanent fault.

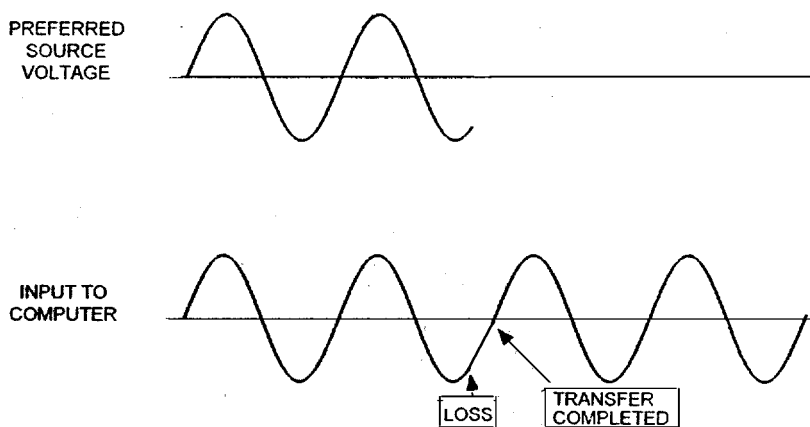

**Figure 3—Fault current trace showing dead times**

If the fault had been temporary, it would have cleared during one of the dead times and, thus, avoided the eventual lockout of the protective device. Survey results on recent industry practices are provided in [B22].

The opening and reclosing times of circuit breakers, although short in duration, may have serious adverse effects to many customers. Most residential loads will return to normal operation with the return of voltage; however, industrial and commercial customers may experience extensive shutdowns of their operations that may take several hours to restore. Some equipment, such as a computer, can be protected by an *uninterruptible power supply* (UPS); however, large motor loads and heavy machinery are too large for UPS systems and cannot be protected against this type of interruption.

Permanent (long-term) faults may be due to equipment failure, accidents with vehicles, a tree limb falling onto the line, etc. They result in service interruptions, which can last from minutes to hours. During a permanent fault condition, the breaker is usually programmed to operate three or four times in an attempt to re-establish power before it locks open (figure 3). The fault must then be located and repaired before service is restored to all customers.

Most (roughly 75%) conductor-related faults on overhead distribution lines are of a temporary nature. By contrast, most faults on underground systems are permanent and take much longer to locate and repair.

Momentary interruptions and disturbances due to circuit reclosing practices for temporary faults may adversely affect the operation of sensitive loads, unless the loads themselves have the necessary ride-through capability or are provided with proper power-conditioning equipment.

Utilities have traditionally employed an overcurrent protective practice referred to as *feeder selective relaying* (sometimes called fuse saving). Feeder selective relaying simply means that, for the system shown in figure 4, the lateral fuse should blow for permanent faults and the feeder circuit breaker should operate faster than the fuse for temporary faults.

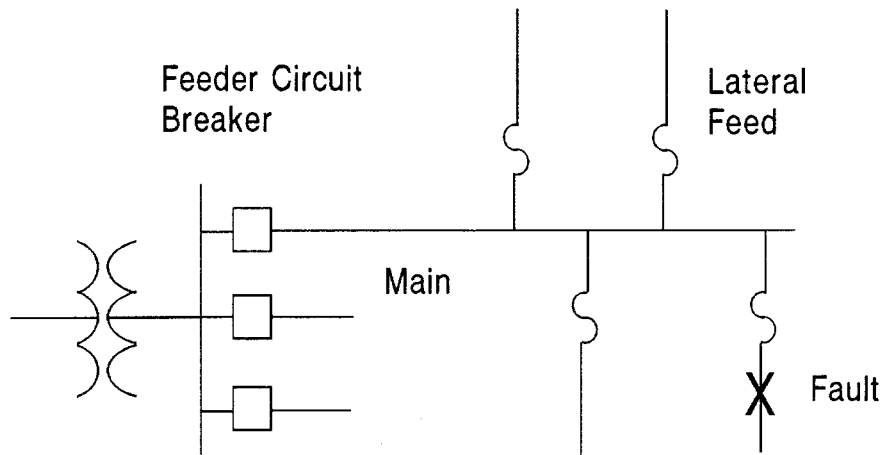

**Figure 4—Feeder selective relaying**

When a fault occurs on a circuit like that shown in figure 4, the other circuits experience a voltage sag or a series of voltage sags on the faulted phase (and voltage swells on the unfaulted phases), depending on how long it takes to clear or isolate the fault. From the standpoint of momentary disturbances, customers on a given circuit are exposed to voltage sags (of varying degrees) from all faults on circuits connected to the same substation transformer. As a result, changing the design of a particular circuit or changing the type of service system supplying the customer may have little or no effect on reducing the exposure to momentary disturbances.

Because of sensitive loads, many utilities no longer practice fuse saving because the breaker operation interrupts the entire circuit. The operation of the fuse interrupts only the lateral with the temporary fault, but it results in a permanent interruption for the lateral. This is the tradeoff for reducing the frequency of momentary interruptions to all the other customers.

### 4.3.3 Switching

Most switching operations, both utility and user, result in momentary voltage disturbances. These operations include fault clearing, rapid clearing, load transfer, fault closing, current-chopping, etc. For example, rapid clearing and current-chopping produce voltage surges (i.e.,  $e = L^{di}/dt$ ).

Although most users of sensitive equipment are aware that their equipment may be subjected to transients, many are not aware of the magnitude or source of the transients or the specific sensitivities of their equipment. Transients from within the customer's premises occur with load switching or fault clearing. The transient voltage results from the rapid rate of change of current through the inductance of the wiring. The magnitudes of these transients can be quite high.

Information from actual recorded data indicates that internally generated surges (impulses) caused by load switching are likely to be repetitive and can generally be associated with a specific device. Peak values as high as 2500 V on 120 V services have been observed [B26]. Surges may be repeated several times a day. While not a problem for normal wiring, this could be severe to sensitive equipment.

### 4.3.3.1 Capacitor switching

In addition to voltage regulators and *load tap-changers* (LTCs), most utilities and many industrial and commercial users employ shunt capacitor banks to help control the power factor or voltage profile by supplying reactive power (vars) to inductive loads, such as motors. Placed strategically on the circuit, shunt capacitors also reduce the losses associated with the primary circuit while improving the power factor.

To accommodate widely varying load conditions, most capacitor banks are switched automatically. When capacitor banks are energized, the transient oscillation between the capacitor and the system inductance produces transient voltages as high as 2 times normal at the capacitor location. The magnitude of the overvoltage is usually less than this due to damping provided by systems loads and losses. Certain sensitive loads may not be able to tolerate the normal switching transients associated with routine capacitor switching (see figure 5). This problem will be discussed further in 6.2.

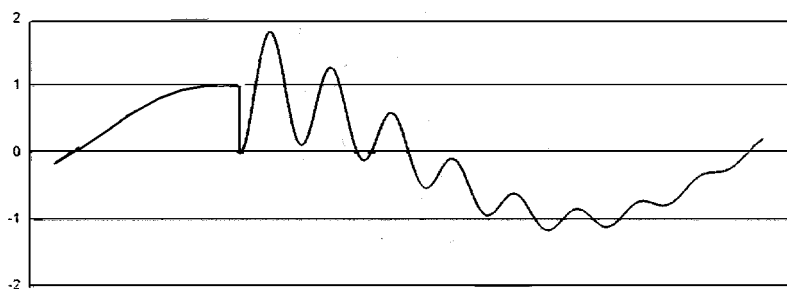

Figure 5—Voltage transient from capacitor switching

### 4.3.4 Motor-starting

The starting of large motors is accompanied by a voltage sag resulting from the inrush current flowing through the system impedances. The maximum voltage sag occurs at the motor terminals and can have a noticeable or even objectionable effect on other customers in the area, or on nearby load sensitive to sags. The criteria normally used for flicker is shown in figure 6. The upper curve has been determined, based on visual perception, to be the one in which objectionable incandescent lamp flicker will result. More frequent starts result in lower allowable voltage fluctuations in terms of human response. Unfortunately, certain electrical loads are much more sensitive than human beings and may not be able to tolerate voltage sags that are deemed acceptable by figure 6.

### 4.3.5 Cyclic and variable loads

These loads include automatic spot welders, reciprocating compressors, etc. As with motor starting, the flicker curve of figure 6 applies. The human eye is particularly sensitive to this type of disturbance because of the high repetition rate. At six fluctuations per second, the objectionable voltage flicker limit is only 0.5%.

### 4.3.6 Tap-changing

The control of operating voltage levels on a distribution system is accomplished through the use of voltage regulators, LTCs and shunt (power factor correction) capacitors. A load tap-changer is functionally equivalent to a voltage regulator. Both consist of an autotransformer with a tapped series winding. A voltage-level-sensing control and a tap-changing mechanism are provided that change the tap position and the voltage level under load.

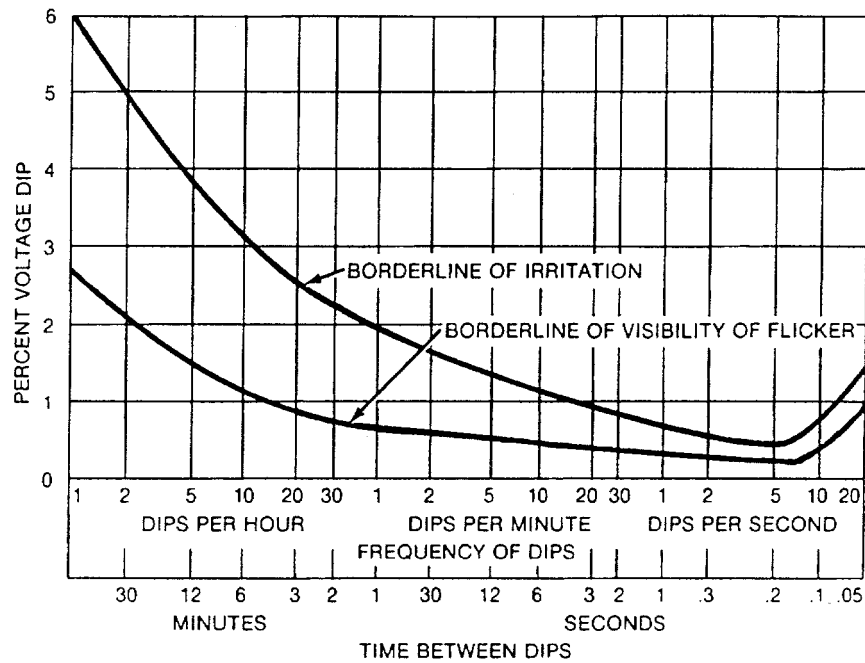

Source: [B3]

**Figure 6—Human response flicker curve**

The voltage control provided for a tap-changer or voltage regulator is not instantaneous and does not ensure a constant voltage. It basically maintains a voltage level within a bandwidth (typically,  $\pm 0.625\%$ , or  $\pm 0.75$  V on a 120 V base) for a given load condition. The voltage level is adjusted if the regulator control senses a voltage outside the limits of the bandwidth setting. There is a time-delay setting (typically, 30 or 45 s) before the adjustment is made. As a result of the time-delay, the LTC does not respond to brief disturbances that may affect sensitive equipment and, therefore, is not considered to be a power conditioner.

#### 4.4 Identifying and quantifying the causes

The direct approach for investigating a specific problem is to conduct an on-site power line disturbance study at the supply point of the sensitive equipment. Monitoring equipment should be capable of recording the types of disturbances that can affect that particular sensitive load [B25]. Depending on available information and the nature of the problem, monitoring may be brief, extending up to 1 or 2 weeks, or it may be required for a longer period.

Transient monitors or disturbance analyzers are available that produce a digital recording of the disturbances with the ability to expand the waveforms to examine them in detail [B10], [B13]. With this data, it is possible to determine whether a disturbance is harmful by comparing it with specific tolerance requirements for the sensitive equipment actually used on site. This determination is often difficult because either the device tolerance information is not readily available or no industry standard exists that is applicable to that aspect of the equipment's design.

With the expanded waveform capability, it is often possible to examine transients and observe a characteristic "signature" that will help identify the source of the disturbance; for example, contact bounce of a contactor within the site (see figure 7 for a typical recording).

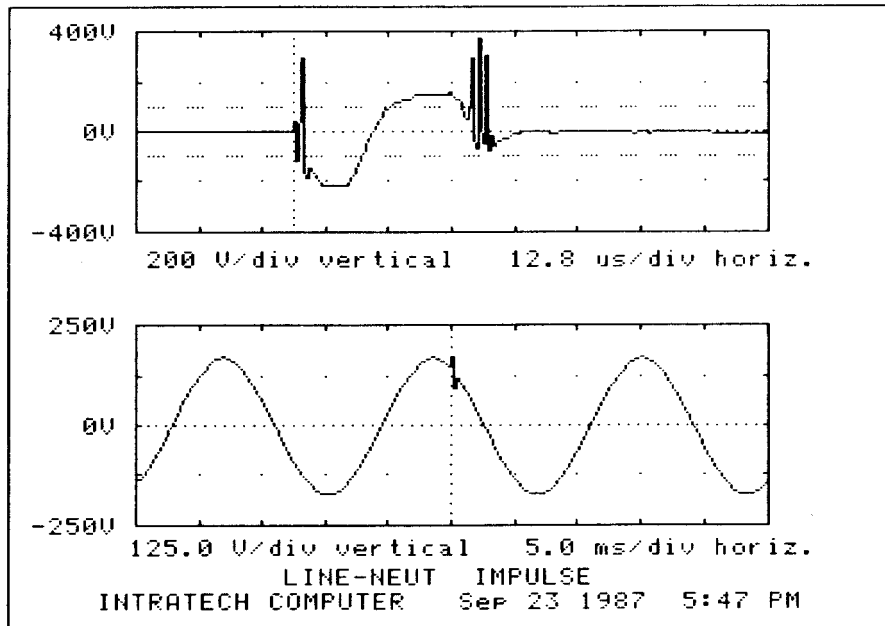

Source: [B13]. Reprinted with permission from Basic Measuring Instruments.

**Figure 7—Recording from a disturbance analyzer**

Causes can also be tied to supply system events by correlation of monitor activity with known faults or capacitor switching; for example, see [B20].

#### 4.5 Harmonic distortion

Ideally, the voltage supply to utilization equipment and the resulting load current are perfect sine waves. However, actual conditions are seldom ideal, and these waveforms are sometimes distorted. The deviation from perfect sinusoids is normally expressed in terms of the harmonic distortion of the voltage and current waveforms.

A nonlinear load draws a nonsinusoidal current (rich in harmonics) when a sinusoidal voltage is applied. The distorted load current then may cause distorted voltages to appear not only near the nonlinear load, but also elsewhere in the system. In the past, such nonlinear harmonic-creating loads were not very widely used, and most concern revolved around the third harmonic (and odd multiples), which could often be avoided through use of the delta-wye transformer connection.

However, modern equipment using power electronic technology produces load currents rich in a broader range of odd harmonics and introduces new concerns. In addition, many of the power conditioners used with sensitive equipment are also harmonics producers.

Two criteria have been proposed to evaluate harmonic distortion. The first is a recommended maximum allowable harmonic voltage distortion (in percent) that is acceptable on the utility system. Table 2 is a simplified version of the one found in IEEE Std 519-1992 [B6]. The recommended values are intended to be low

enough to ensure that properly designed equipment will operate correctly provided no additional harmonics are generated by the sensitive load itself.

**Table 2—Voltage distortion limits**

Maximum distortion (%)	Bus voltage at point of common coupling		
	2.3–69 kV	69–138 kV	>138 kV
Individual harmonic distortion	3.0	1.5	1.0
Total harmonic distortion (THD)	5.0	2.5	1.5

Source: IEEE Std 519-1992 [B6].

NOTE—See definition for *harmonic distortion* (3.2).

Some nonlinear loads can be a significant source of harmonics and the addition to an existing electrical system can result in improper operation of neighboring loads that were previously operating satisfactorily.

The second criterion limits the harmonic current that may be injected into the utility system. Table 3 lists the proposed harmonic-current limits (in percent) based on the size of the user with respect to the size of the power supply to which the user is connected. These limits on current injection acknowledge a responsibility on the part of equipment designers and users.

**Table 3—Current distortion limits for general distribution  
120 V through 69 kV**

Maximum harmonic current distortion in percent of $I_{load}$						
$I_{sc}/I_{load}$	Individual harmonic order					Total demand distortion (TDD)
	<11	11–16	17–22	23–34	≥35	
<20	4.0	2.0	1.5	0.6	0.3	5.0
20–50	7.0	3.5	2.5	1.0	0.5	8.0
50–100	10.0	4.5	4.0	1.5	0.7	12.0
100–1000	12.0	5.5	5.0	2.0	1.0	15.0
>1000	15.0	7.0	6.0	2.5	1.4	20.0

Source: IEEE Std 519-1992 [B6].

Key:  $I_{sc}$  = maximum three-phase fault current per phase at customer supply point.

$I_{load}$  = maximum load current per phase at customer location.

The term,  $I_{sc}/I_{load}$ , is the ratio of the three-phase short-circuit current available at the *point of common coupling* (PCC) to the maximum fundamental frequency load current. As the size of the user load decreases

compared to the size of the system, the percentage of harmonic current the user is allowed to inject into the utility system becomes larger. This helps to protect other users on the same circuit as well as the utility.

While IEEE Std 519-1992 provides direction for conscientious equipment designers, it does not yet represent a consensus from the manufacturing industry needed to control harmonic injection nor for proper equipment operation. Also, there is no guarantee that harmonic voltage distortion limits will not be exceeded even though each customer on a given line conforms to the current injection limits.

## 5. Sensitive loads

Digital electronic devices, particularly those with a memory, are extremely sensitive to very short-duration power disturbances. These momentary disturbances, impulses, or transients may result in customer complaints unless adequate ride-through capability is provided. This clause discusses some common devices that can be included in the category of sensitive loads.

### 5.1 Types of sensitive loads

Minicomputers, electronic cash registers, and data terminals are a few examples of sensitive loads that often fall victim to momentary voltage disturbances. These disturbances can interrupt the operation of sensitive circuitry and cause memory loss, system malfunction, or component failure.

#### 5.1.1 Computers

Computer equipment is more sensitive to voltage disturbances than most other equipment. It is reasonable to expect that quality computer equipment will meet the requirements of the curve shown in figure 8.

The curve is actually an envelope that defines the transient and steady-state limits within which the input voltage can vary without either affecting the proper performance of the computer equipment or damaging it.

Note that the curve allows a complete loss of voltage for only 0.5 cycles (8.3 ms), but permits 80% voltage for 0.5 s. In addition to voltage, such sensitive loads typically require the frequency to be within  $\pm 0.5$  Hz; the rate of change of frequency, less than 1 Hz/s; voltage THD, under 5%; and voltage unbalance on three-phase systems, less than 3% [B5]. For specific applications, the electric service requirements should be obtained from the equipment manufacturer prior to installation; however, this information may be difficult to obtain.

Computers generate harmonic distortion and typically are not very sensitive to it unless the voltage waveform is very distorted. Distortion of the voltage near the zero-crossings can cause timing errors.

#### 5.1.2 Process control

The microprocessor and microcomputer have fostered the emergence of a new family of commercial and industrial process automation techniques, referred to as *facility management systems* (for commercial buildings) and *flexible manufacturing systems* (for industrial applications). Commercial facility management systems typically include sensors for input data, remote terminal units, the central processor, and man-machine interface devices. Functions managed can include heating, ventilating, and air-conditioning; security; access control; and energy management. Industrial flexible manufacturing systems are assemblies of machine tools, cutting tools, and workpiece-handling devices employed to process a variety of finished parts.

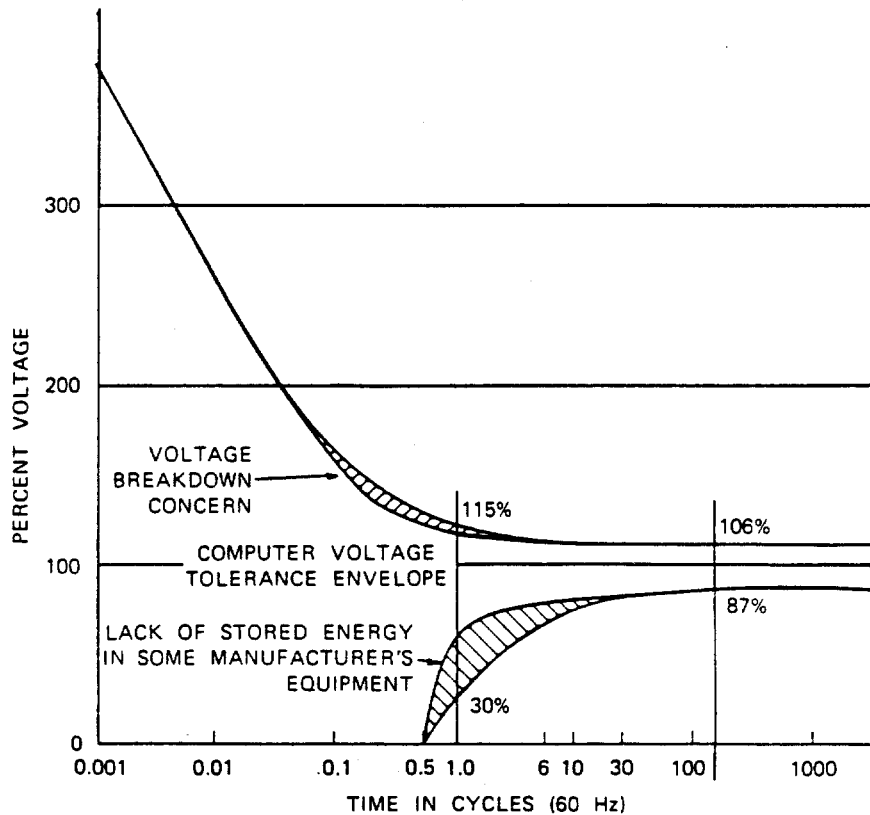

Source: IEEE Std 446-1987 [B5]

**Figure 8—Typical computer voltage tolerance**

The previous discussion on computer sensitivity likewise applies to process control. In addition, motor starters, contactors, relays, and other devices held closed by a coil and magnetic structure are especially sensitive to short-time interruptions and voltage sags. As a guide, a voltage sag to 60 or 70% of rated voltage for 0.5 s will de-energize many of these devices. Many control relays, sealed-in by their own contacts, will drop out if voltage is lost for 0.5 cycle or more [B4].

### 5.1.3 Telecommunications

When considering the sensitivity of telecommunications equipment, a distinction should be made between common equipment in the public telecommunications network and individual terminal equipment that connects to the network. Most of the critical common equipment uses batteries to buffer disturbances and interruptions of the electric utility service, so short-term transients normally have little or no effect. However, the individual terminals that connect to the public telecommunication networks often connect directly to the electric utility service and are subjected to disturbances.

### 5.1.4 Electric arc lighting

High-intensity discharge (HID) lighting includes mercury, metal halide, and high-pressure sodium lamps used for security and street lighting applications. In the event of a power interruption or voltage sag lasting more than 1 cycle, HID lamps extinguish and do not restart for several minutes. The exact magnitude of the voltage drop causing this condition depends on the lamp ballast.

### 5.1.5 Consumer electronics

An ever-increasing variety and number of digital electronics are found in video-cassette recorders, microwave ovens, stereos, televisions, and clocks. Some of these have back-up systems (e.g., batteries) that prevent disruption to timer/clock functions when power is lost for short periods of time. Others do not.

### 5.1.6 Adjustable speed drives

Adjustable speed drives (ASDs) are used to control the speed, torque, acceleration, and direction of rotation of a motor. Unlike constant speed systems, the ASD permits the selection of an infinite number of speeds within its operating range. The two basic types of ASDs commonly used today are dc drives and adjustable ac frequency drives.

DC drives utilize a power converter to convert the fixed ac voltage to an adjustable dc output for controlling a dc motor. Adjustable-frequency ac drives convert three-phase 60 Hz input power to an adjustable frequency and voltage source for controlling the speed of squirrel-cage induction motors or other ac motors.

Problems have been documented involving nuisance tripping of some manufacturers' ac drives due to switching transients associated with capacitors on the customer's or utility's system.

## 5.2 Ride-through capability

As was mentioned in 4.3.2, the practice of removing temporary faults on utility systems calls for tripping the circuit breaker (or recloser), reclosing, and repeating these steps a number of times if the initial trip and reclose operation is not successful in clearing the fault.

If reclosing is successful on the initial attempt, customer loads on the faulted circuit would have experienced a complete loss of voltage for a duration ranging from approximately 0.5 s to several seconds, depending on the characteristics of the protective device as well as the reclosing cycle used by the particular utility. For adjacent circuits connected to the same substation bus, a voltage sag is experienced for the duration of the fault; although this sag may last for only a few cycles, the voltage can be low enough to cause sensitive equipment to reset or ASDs to trip.

Subsequent reclosing attempts commonly involve durations of 15 s or more during which the circuit voltage supply is interrupted. Figure 8 shows that most computer equipment can tolerate a complete loss of voltage for 0.5 cycle (60 Hz basis) or less. Thus, a single reclosing operation would cause this equipment to malfunction.

Momentary power interruptions can result in a wide variety of user equipment problems, ranging in severity from blinking clocks to the shutdown of a factory process. Most of the momentary interruptions result from circuit breakers (or reclosers) tripping and reclosing to clear temporary faults and thus to avoid long-term interruptions.

Power supplies found in sensitive equipment have some inherent ride-through capability. Typical ride-through capabilities of power supplies range from 10 to 25 ms. This time is too short to be of much help in averting problems associated with utility momentary interruptions; it may, however, be sufficient to allow the operation of static switches or other high-speed source transfer devices used to assure the supply of power to sensitive equipment.

A study of electronically controlled consumer electronic equipment [B16] indicates that, without battery backup, loss of memory occurs for relatively short interruptions of supply power. Digital clocks, microwave ovens, and video-cassette recorders (VCRs) were tested for susceptibility to voltage abnormalities. Although there were significant differences between the models studied, the average data indicates that 40% of all

clocks malfunctioned for a 120-cycle (2 s) interruption, and all malfunctioned at 1000 cycles. All microwave ovens malfunctioned at 120 cycles; 62% of the VCRs malfunctioned at 120 cycles and all malfunctioned at 1000 cycles, except two VCRs that had battery backup (these withstood all momentary interruptions). An extension of this study to personal computers and printers [B17] showed that all these devices malfunctioned with a 6-cycle interruption, with four computers malfunctioning for interruption durations of 1 cycle or less.

Based on a survey of 95 companies, 90% of all first reclosure operations used by electric utilities last 10 s or less [B22]. In addition, [B11] notes that a 2 s interval is most common for reclosers.

## 6. Solutions

Given the rapid growth in the utilization of computers and other sensitive loads that are vulnerable to misoperation from voltage disturbances, it is useful to consider the range of measures that is available to help address the special electrical needs of this type of equipment.

### 6.1 Utility-side solutions

As cited in the preceding material, the design and operating practices that a utility normally employs to comply with industry standards, safety, and regulatory guidelines may at times contribute to voltage disturbances that affect sensitive customer equipment. In some cases, the measures required on the utility side of the system to mitigate such effects may inequitably affect the reliability or cost of service to other customers. In these cases, alternative solutions, especially on the customer side, may be preferable.

#### 6.1.1 Measures to minimize interruptions

Utility studies on service reliability deal with the number of interruptions, their causes, the number of customers affected and the amount of time interrupted. When applied to customers with sensitive equipment, the greatest potential for improvement lies in minimizing the number of interruptions and the number of customers affected.

A review of the number of interruptions per year and their causes forms a logical starting point from which to generate possible solutions. For example, if a high number of interruptions on a given circuit is related to trees, then additional tree trimming might produce a significant improvement. Also, the increased use of surge arresters on the line to prevent line flashover might actually eliminate some of the momentary interruptions where lightning has been identified as a leading cause.

**Table 4—Utility measures to minimize interruptions**

Design measures	Operating measures
General circuit layout and construction	Equipment inspection and maintenance
Circuit exposure, length, and type	Line inspection and maintenance
Protective coordination	Right of way inspection and maintenance
Fault sectionalizing	Prompt identification of chronic problems
Grounding considerations	Analysis of interruption data
Surge arrester application	Line monitoring
Equipment and material standards	

Table 4 lists several utility design and operating measures to consider where reductions in the frequency and duration of interruptions and the number of customers interrupted are desired. These measures are useful starting points to check when reliability improvements are being sought for a particular customer or for a

particular circuit. However, many of the items listed may not have a significant impact in reducing the number of momentary interruptions or may not be totally effective or practical.

The basic system serving a particular customer is usually determined by economics. As the load grows or as the importance of greater long-term reliability becomes evident, changes in the type of supply might be considered. Much of this is gained at the expense of short-term reliability (e.g., going from a radial system to a spot network improves long-term reliability but increases the circuit exposure for momentary disturbances).

Modifications in the design or operation of the utility supply system that are oriented toward the improved quality of service to a specific end user may, in fact, degrade the quality of service or increase the cost of service to other end users. In 4.3.2, an example is cited where different protection philosophies present a tradeoff between a permanent interruption to a small group of customers on a branch circuit and momentary interruptions to a larger group on a main or feeder circuit. Such compromises are inherent in the design and operation of utility supply systems to meet the diverse needs of many customers.

Also, as cited earlier, voltage disturbances that affect the utilization equipment of one utility customer may have their origin in the operation of loads of another customer or, perhaps, in the operation of other equipment in the facility of the customer experiencing problems with sensitive equipment. Thus, the identification of the causes of voltage disturbances and their resolution usually involves multiple parties. Such disturbances are an electric *system* problem and their avoidance or mitigation are matters of concern not only to utilities and their customers experiencing problems with sensitive equipment, but also to equipment manufacturers, regulatory agencies, customers who do not have sensitive equipment, and others.

### **6.1.2 Static var compensators (SVCs)**

SVCs have been used to serve large industrial loads that result in voltage flicker excursions beyond the limits of figure 6. Such loads can interfere with the industrial customer or other electrical customers near the plant. The SVC regulates voltage by providing a variable reactive supply to the load. Applications include rapidly changing poor power factor loads like ASDs and arc furnaces.

### **6.1.3 Series capacitors**

Series capacitors with bypass varistors provide a compensating (capacitive) reactance to reduce voltage flicker. Under normal conditions, the same current that causes the voltage drop along the feeder reactance creates a desired voltage rise across the series capacitor; consequently, voltage regulation is instantaneous and self-regulating. In the event of power system faults, the varistors bypass the fault current and limit the voltage across the capacitors. As a result, the available fault current hardly increases. The reduction in voltage flicker is dependent on the load characteristics, the system impedances, the location, and the sizing of the series capacitor.

## **6.2 Customer-side solutions**

On the customer side, equipment operation, circuit design, and power-conditioning measures can be used to mitigate or protect against voltage disturbances. The source of these voltage disturbances may be from the customer as well as from the utility side of the meter.

On the customer side, building wiring problems, such as poor connections, open neutrals, overloads, faults, or locally generated switching transients need to be considered before the addition of power conditioning. Also, grounding techniques may affect the performance of equipment and, most importantly, may amplify load equipment sensitivity and the adverse effects of voltage disturbances. As an alternative to modifying their electrical system, the customer may attempt to specify and purchase less sensitive or more tolerant load equipment.

### 6.2.1 Changes in equipment operation

During the process of identifying and quantifying the causes of voltage disturbances affecting sensitive loads in a specific situation, conditions may be revealed in which a change in the timing or mode of operation of either the sensitive equipment or the equipment causing the disturbance may avoid all or a majority of mis-operations. However, this may be a difficult accomplishment if the sensitive equipment and the offending equipment have different owners.

If the processes in which the two categories of equipment operate can accommodate such change, then the solution avoids the cost of circuit design changes or power-conditioning measures.

### 6.2.2 Grounding, noise elimination, and circuit design

Before considering power-conditioning equipment, it is important that the installation be thoroughly checked to determine if there are other problems that might adversely affect sensitive equipment. The signature previously described can point to some cause, such as loose connections or poor contacts in the wiring or switchgear. Obviously, such problems should be addressed before more costly measures are considered.

Where appropriate, the sensitive equipment should be fed with a separate “dedicated” circuit, which connects as close as possible to the utility source to minimize effects of other customer loads that could otherwise cause voltage disturbances. This may require the use of extra transformers, circuits, conduit, and equipment. Exposure to overvoltage transients may be limited by appropriate application of low-voltage surge-protection equipment.

Noise problems in sensitive-equipment installations most often result from improper grounding practices. Proper grounding techniques are outside the scope of this guide. Refer to [B7] and to FIPS Pub. 94 [B1] for details on this subject.

Many grounding problems for large data processing rooms can be avoided and safer installations provided by the use of properly designed portable power distribution units (often called PDUs), usually arranged for installation on a computer room floor close to the loads they serve (see figure 9).

These units generally contain input isolating (and usually step-down) transformers with electrostatic shielding to minimize the effects of potential line-to-ground noise. They include a main circuit breaker that provides isolation and emergency power-off by pushbutton. The transformers feed panelboards equipped with multiple circuit breakers (and sometimes fuses). Each circuit breaker is connected to a properly wired and properly grounded flexible under-floor cable with plug-compatible receptacle for the sensitive equipment it serves (see figure 9, which illustrates a typical PDU circuit, several of which might be used in a large installation). PDUs can also be equipped with power monitoring and alarm functions, as well as some of the simple forms of power conditioning discussed in 6.2.3. Note that typical utility distribution transformers are not shielded and, hence, cannot be relied on to provide such shielding in situations where no power-distribution unit exists.

### 6.2.3 Power conditioners

Many types of conditioners are available, ranging from the very inexpensive, which protect against only the least significant types of voltage disturbances, to the expensive, which protect against almost all eventualities. Table 5 is a summary and comparison of the types described in 6.2.3.1–6.2.3.10.

#### 6.2.3.1 Surge-protective devices (SPDs)

SPDs protect sensitive electronic equipment from surges. These devices usually contain component(s) that provide a voltage-dependent diversion of surge current. Some units also contain passive filter components, such as series inductors and parallel capacitors.

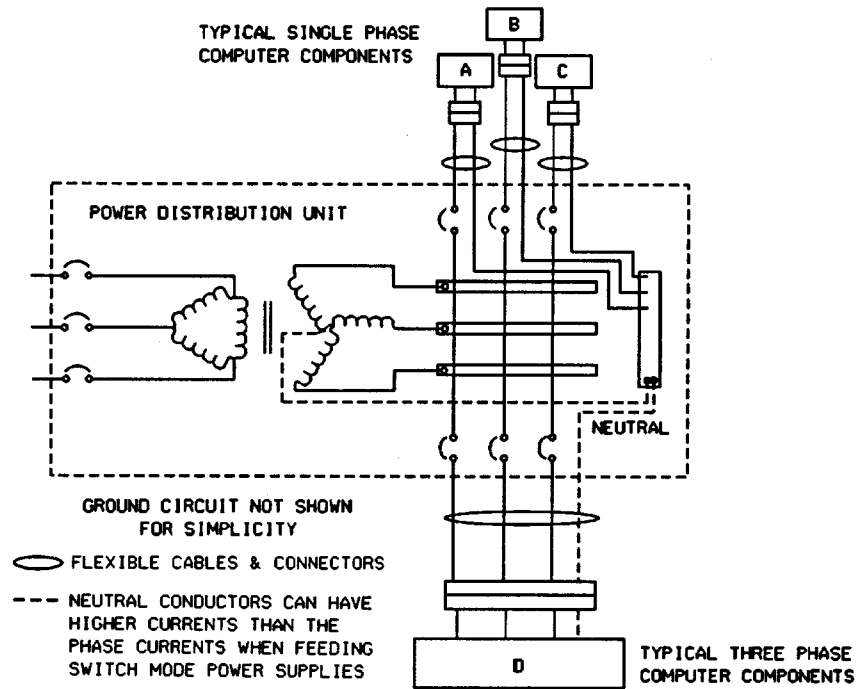

Figure 9—Power distribution unit

Two of the most common voltage-dependent components that are used in these devices are *metal oxide varistors* (MOVs) and large junction avalanche diodes that are specifically designed for surge diversion.

Components exhibiting surge-protection characteristics are often integrated into the PDUs, UPSs, power supplies, and power-conditioning equipment. However, these provide a level of surge protection that may not be adequate for all conditions. Additional surge protection may be needed, depending upon the severity of the environment.

The proper application of an SPD requires a coordinated approach based upon the expected energy deposition into the candidate device at the applied location. Typically, a building service entrance or main panel device would be expected to divert a greater part of the surge current than a device installed at a secondary panel, a receptacle, or within an equipment. If two SPDs are installed in cascade, coordination of the operation—that is, energy deposition commensurate with the respective ratings of the two devices—depends on the relative clamping voltages of the devices, on the distance separating them, and on the waveform (postulated in the absence of known specifics about the installation) of the impinging surge [B23].

The selection of the appropriate voltage rating is based upon the nominal service voltage, including normal and abnormal upward deviations (ANSI C84.1-1989) and the *maximum continuous operating voltage* (MCOV) of the SPD. The MCOV rating of the SPD should be selected to be at least 120% of the nominal rms service voltage [B15], [B33]. Specifying the MCOV to be between 150% and 200% of the nominal rms service voltage provides additional protection against degradation of the SPD by swells or relatively low-level transient overvoltages [B27].

### 6.2.3.2 Noise filters

Noise (line) filters are used to reduce electromagnetic interference (EMI) and radio frequency interference (RFI) to acceptable levels. Generally small and low in cost, they, too, are usually built into sensitive equipment and often into PDUs and more expensive power-conditioning equipment. Some surge-protective outlet strips also contain these filters.

A low-pass filter, is designed to pass 60 Hz voltage but to block very high frequencies or steep wavefront transients. They are not effective for frequencies near 60 Hz, such as low-order harmonics, but become effective in the 10 kHz range.

Filters can be connected line-to-line, line-to-neutral, or line-to-ground for noise rejection.

**Table 5—Power conditioner comparison**

Power conditioner type	Relative cost (%) <sup>a</sup>	Surge protection	Sag or swell protection	Sustained protection		Harmonic distortion protection	Noise protection	Outage ride-through capability
				Under-voltage	Interruption			
Surge suppressors	<1	X						nil
Filters	<1					SP	X	nil
Isolation transformers								
Without filter	4						C	nil
With filter	5					SP	X	nil
Low-voltage line reactors	<1					X		nil
Voltage regulators	35							
Normal-response		A	A, P	X		A		1/4 cycle
Fast-response		A	X	X		A	A	1/4 cycle
Ferroresonant		X	X	X		A	X	1 cycle
Motor generators	45	X	X	X	P	X	A	0.3 s <sup>b</sup>
Dual feeders								<sup>d</sup>
Static transfer	25	A	X		X			continuous
Static transfer and VR <sup>c</sup>	50	X	X	X	X	A	A	continuous
UPS	60							
Standby		A	X	A	X	A	A	15 min
On-line		X	X	X	X	X	X	15 min
Line interactive		A	X	X	X	A	A	15 min
UPS and engine generator <sup>e</sup>	100	X	X	X	X	X	X	continuous

<sup>a</sup>Varies with power level (100% = UPS + engine generator)

<sup>b</sup>Typically, 1 s with flywheel

<sup>c</sup>Fast-response or ferroresonant voltage regulator

<sup>d</sup>Except simultaneous loss of both feeders

<sup>e</sup>Engine generator sized to support on-line UPS and air conditioning

KEY:

X = protection provided

SP = special distortion-correction filters are available

C = common-mode noise

A = available or provided

P = very short periods only

VR = voltage regulator

UPS = uninterruptible power supply

### **6.2.3.3 Isolation transformers**

Isolation transformers provide two functions. One function is the ability to change to a new voltage level and/or to compensate for high- or low-site voltage. The second function of the isolation transformer is to provide for the ground reference at the point of use, thus eliminating the problem of noise induced through ground loops or multiple current paths in the ground circuit upstream of the established reference ground point.

Isolation transformers are often equipped with an electrostatic shield between the primary and secondary windings. The shield is a conducting sheet of nonmagnetic material connected to ground to reduce the effect of capacitive coupling and, hence, noise transfer between primary and secondary windings.

The transformers, in combination with capacitors in the sensitive-equipment power supplies they serve, form filters for noise rejection. Isolation transformers without such loads do not reduce line-to-line transients; they can actually magnify them [B24].

Adding additional shields around each winding to further reduce the capacitive coupling is unnecessary if the transformer secondary is grounded in accordance with code requirements and proper ground referencing is used.

### **6.2.3.4 Low-voltage line reactors**

Low-voltage line reactors (inductors) provide an alternative to isolation transformers for attenuating voltage disturbances on sensitive circuits. They have been successfully applied to three-phase ac ASDs to prevent nuisance overvoltage tripping during capacitor switching. The additional series inductance of the reactor reduces the current surge into the ASD, thereby limiting the dc overvoltage. The main difference (compared to using isolation transformers) is that inductors cannot be used to introduce a new ground reference (separately derived system).

### **6.2.3.5 Line voltage regulators**

Most steady-state voltage problems, except interruptions, can be handled by the addition of voltage regulators. In many cases, voltage regulators are equipped with transient suppressors to provide transient protection as well.

#### **6.2.3.5.1 Normal-response regulators**

Normal-response regulators refer to those with a return to near normal voltage in 10–12 cycles after a step change of input voltage or load. This is very fast compared with the electromechanical types (which are considered not suitable for this service); however, they are not sufficiently fast nor do they contain sufficient stored energy to handle severe sags such as occur upon clearing utility or internal distribution faults. An automatic feedback circuit holds the output voltage constant. See figure 10 for one example of a normal-response regulator.

#### **6.2.3.5.2 Ferroresonant regulators**

Ferroresonant regulators consist of a linear and a nonlinear inductor and a capacitor in a parallel resonant circuit with the nonlinear inductor (see figure 11).

These elements are generally incorporated into an isolation transformer configuration together with additional filtering to eliminate self-induced harmonics. This filtering can handle a reasonable level of harmonic distortion at the output induced by nonlinear computer load, but excess harmonics can produce overheating of the regulator. The circuit is tuned to rated output voltage and frequency.

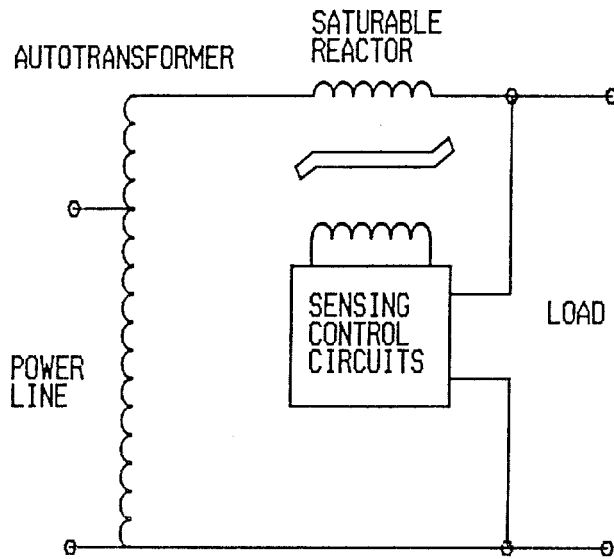

Figure 10—Normal-response voltage regulator

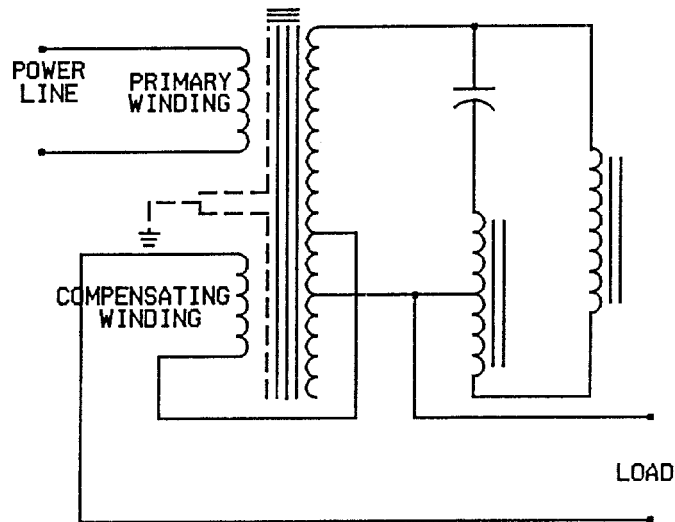

Figure 11—Ferroresonant regulator

Ferroresonant regulators maintain a constant output voltage for a wide range of input voltage, particularly at light load. Their inherent current-limiting characteristic, which limits maximum current at full voltage, can be a limitation when starting motors or computer central processing units (CPUs). Because of this characteristic, they are generally operated at a considerably underrated condition. Some short-term overvoltages occur at the output ferroresonant regulator upon recovery from an interruption.

The tuned circuit has a small amount of stored energy and will ride through interruptions of about one cycle, provided the interruption is not a fault close to the input, which would drain the stored energy. It will not ride through a 0.5 s interruption typical of the automatic reclosure on a utility circuit; however, many will ride through up to 50% voltage sag for 0.5 s, which would probably be sufficient to handle fault clearing on a nearby circuit. Ferroresonant regulators are large and heavy due to the magnetics involved, but are simple and reliable.

### 6.2.3.5.3 Fast-response regulators

Fast-response regulators divide into two generic classes. The first (see figure 12), the tap-changing regulator, is designed to adjust varying input voltage by automatically transferring taps on a power transformer (either isolating type or autotransformer type) at the zero current point of the output wave.

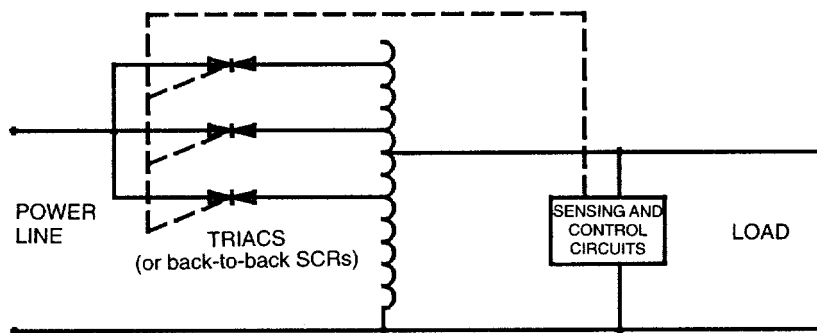

**Figure 12—Fast-response tap-changing regulator**

The number of taps determines the magnitude of the steps and the range of regulation possible. Regulators will commonly have at least 4 taps below normal and 2 taps above normal for a total of 7 taps. Response time is usually one cycle and is limited to that speed because of the zero current switching criteria.

A major advantage of the tap-changer is that its only impedance is the transformer or autotransformer and the semiconductor switches. It introduces little harmonic distortion and will minimize load-induced distortion, but will not filter out any distortion from the input. It also has high short-time overload capability. On the other hand, this type of regulator has a significant number of discrete steps when correcting for varying input voltage.

Another class of fast-response regulators is the phase-modulating type. It usually utilizes thyristor (SCR) control of buck and boost transformers in combination with filters to provide stable sinusoidal output—even with nonlinear loads typical of computer systems. This can be done in a rapid, smooth, continuous manner. Heavy loads can be delivered for start-up inrush typical of computer central processors or disc-drive motors while maintaining full voltage, a typical problem with fully loaded ferroresonant regulators. Utility power is typically passed through an input isolating transformer, providing stepdown to the utilization voltage.

Power is fed to the regulator, which either boosts or bucks the incoming voltage, so that the output is maintained constant despite variation of input voltage or load. This is done by comparing the output voltage to the

desired (set) level and by the use of feedback to modify the level of boost or buck so that the desired level is maintained, as shown in figure 13.

The filter provides a path for a reasonable level of nonlinear currents generated by the load and by the regulator itself and produces a sine wave output with low THD with built-in transient suppression. It effectively eliminates overvoltage transients of the magnitudes typical in power supplies.

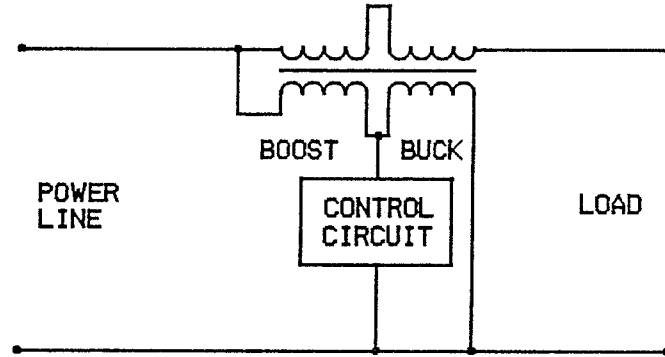

Figure 13—Phase modulation regulator

Some fast-response regulators have the ability to accommodate one of the most severe and also the most common types of power disturbances, a voltage sag of up to 50% for up to 0.5 s resulting from a nearby power-line fault cleared by a circuit breaker. This is possible because these regulators can correct the output voltage to within the equipment's voltage tolerance level fast enough to avoid upset until line voltage returns to near-normal, as shown in figure 14.

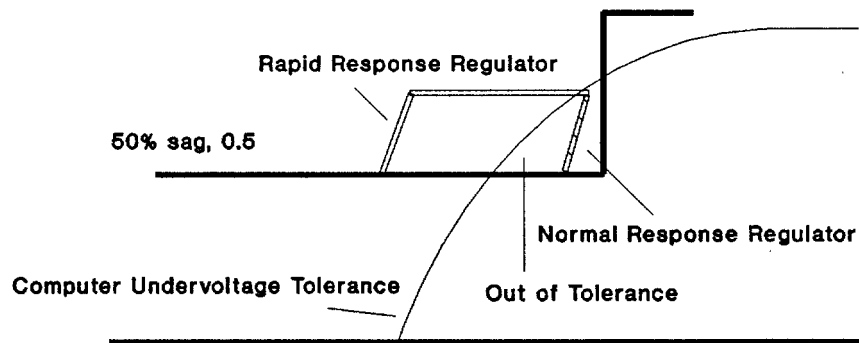

Figure 14—Regulator response to deep voltage sag

Note that normal-response regulators with the same regulating range do not remain within the envelope. In this usual configuration with isolating transformers and with wide undervoltage capability, as well as transient surge suppressors, modern voltage regulators can handle most voltage problems except interruptions.

### 6.2.3.6 Motor-generator sets

Motor-generator sets consist of electric motors driving ac generators. The load is supplied by the generator and is electrically isolated from the utility supply. Motor-generators are used widely as a source of 400 Hz power for large computer central processors requiring this frequency. Because of the wide-frequency tolerance of computers powered at 400 Hz, a simple induction motor can be used to drive a brushless synchro-

nous generator (alternator). The speed changes with load and input voltage variations hold output frequency (which is proportional to speed) well within tolerance and constant voltage is maintained by automatic voltage regulators controlling the generator's field excitation.

For the 60 Hz case, however, the frequency tolerance for computers is generally  $\pm 0.5$  Hz and usually requires the use of synchronous motor drives or induction motor drives specifically designed for low-slip operations.

Motor-generators can shield the load from impulses and from voltage sags and swells. For power-line voltage changes of  $\pm 20\%$  or more, voltage to the load is maintained at nominal.

A useful feature of the motor-generator is its ability to bridge severe short-term sags or interruptions. The inertia of the rotating elements permits the motor-generator to span interruptions of up to about 0.3 s. This is mainly limited by the drop in frequency (speed) as energy is removed. This period can be extended by adding inertia via a flywheel as shown in figure 15. It is now practical to extend the time long enough to protect for the typical case of clearing and reclosure due to circuit faults by the use of variable-speed constant frequency or quick-starting engine generator techniques in addition to flywheel inertia. The cost is considerably higher than conventional motor-generators. The motor-generator set with flywheel is sometimes classified as UPS equipment.

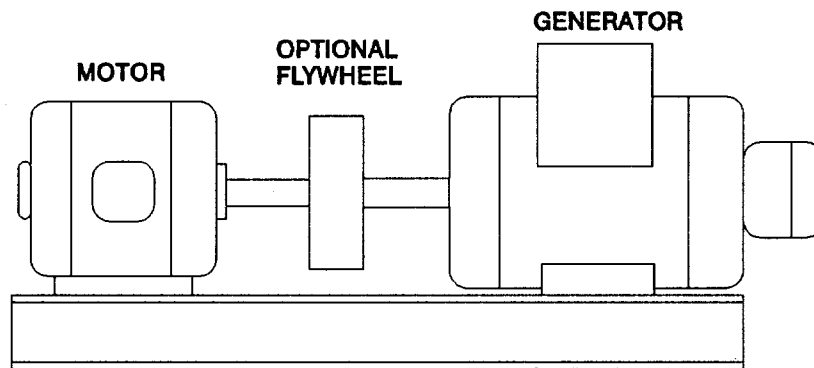

**Figure 15—Motor-generator set with flywheel**

The problems with motor-generators are mostly on the output or load side. High generator output impedance can cause substantial voltage sags in response to sudden load changes, such as resulting from large motor-starting current, and response to load changes can be sluggish. Also, unless it is oversized, the drive motor may overheat under long-term low-line voltage conditions.

Motor-generator efficiency is typically relatively low, so that electrical energy costs over its lifetime may be substantial. Heat dissipation, equipment weight and bulk, and the potential for audible noise are factors that should be considered in motor-generator installations. Essentially silent machines are available at extra cost. Bearings should be inspected and periodically replaced and/or lubricated in many cases, particularly when flywheels are used. Reliability potential, however, is very high.

### **6.2.3.7 Dual feeders with static transfer**

If a facility is equipped with two utility power feeds or if two can be provided at reasonable cost (such as the secondary selective system), adequate power supply can be provided for a very high percentage of power problems with a static automatic line transfer switch.

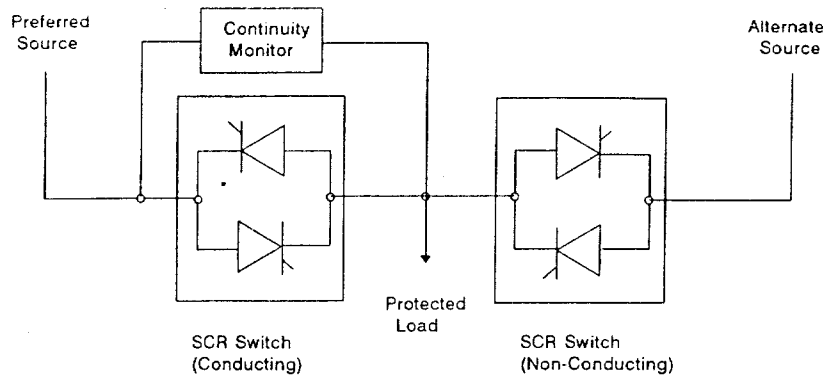

TRANSFER VOLTAGE SET POINTS

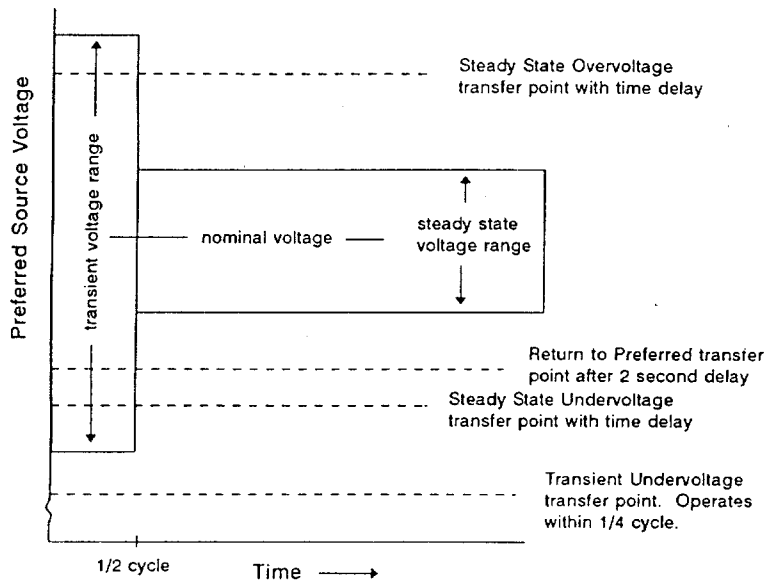

Figure 16—Static transfer switch

A typical static switch power circuit consists of two pairs of thyristors per phase connected as shown in figure 16. When the preferred source is of proper voltage, control logic turns on its thyristors. Power can then flow from the preferred source to the load. The control logic is typically equipped with three “preferred source voltage sensors,” which monitor overvoltage, undervoltage, and loss of voltage, as shown in figure 16.

The static switch can automatically transfer computer and other sensitive loads when power is suddenly lost on either one of the two synchronized incoming utility lines without disturbance. Total sensing and transfer time is within 0.25 cycle and will not affect most sensitive-equipment operations.

Figure 17 illustrates the automatic transfer of a typical switch. Deviations outside the preset limits (set points) cause the static switch to transfer to the alternate source. Transfer is prevented, however, if the alternate source voltage is not present.

Upon restoration of preferred voltage above the “return to preferred” level and below the overvoltage level for a timed period, the control logic checks for synchronism of the phase and voltage balance between the preferred and alternate sources and then initiates retransfer to preferred.

If, during normal operation, a malfunction of the static switch occurs that would otherwise cause a disturbance to the load, automatic transfer and latch to the alternate source takes place to maintain load power continuity.

Properly made static switches are dependable and inherently maintenance-free with no periodic exercising requirements to maintain high-speed operation and no contacts to clean.

Static switches, of course, are not effective in the event of an interruption of both circuits and do not provide power conditioning if both feeds sag in voltage simultaneously, as might be the case for a fault on the utility transmission system. This latter condition can be aided, however, by the addition of a downstream fast-response or ferroresonant voltage regulator as previously described in 6.2.3.5.2.

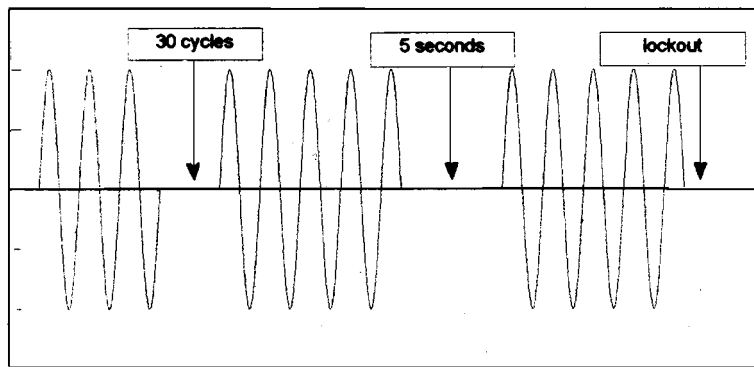

Figure 17—Dual feeder with static switch performance

### 6.2.3.8 Uninterruptible power supply (UPS)

For continuous operation of computer or other sensitive systems when line voltage interruptions last approximately 0.5 s or longer (a common event for utility fault clearing), the only solution is a UPS. A UPS can provide continuous regulated power under all normal and abnormal utility power conditions, including interruptions.

UPS systems are typically solid-state, although some are currently made using rotating machinery in combination with solid-state conversion. UPS systems have three general configurations, as illustrated in simplified form in figure 18. Most systems contain a storage battery.

#### 6.2.3.8.1 Standby UPS systems

A standby UPS system includes a rectifier/battery charger, a static inverter, and a static automatic-transfer switch. The normal flow of power is directly from the line to the load through the transfer switch. In some versions, however, a regulator is included on the line side or on the load side of the transfer switch to provide output regulation to sensitive loads. In the event of incoming power loss, the transfer switch is actuated to pick up the inverter output, which delivers phase-synchronized power to sensitive loads, resulting in less than a 0.25 cycle break.

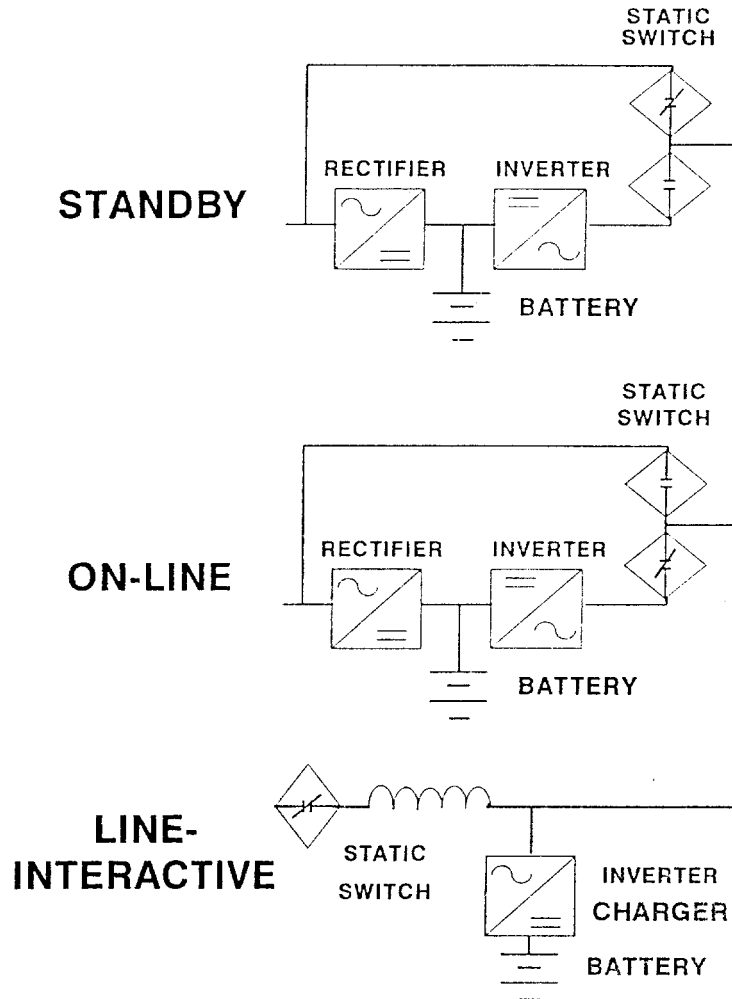

Figure 18—UPS configurations

During ac line failure, a standby UPS supplies sensitive-equipment power from the battery through the inverter.

#### 6.2.3.8.2 On-line UPS systems

An on-line UPS system, which includes a larger rectifier/battery charger than the other systems, provides power to the load through the rectifier and inverter. During a line failure, the inverter operates from the battery to provide phase-synchronized power to the sensitive load. In the event of inverter output failure or overload, phase synchronized transfer to the bypass line results in an interruption of less than 0.25 cycles.

#### 6.2.3.8.3 Line-interactive UPS systems

A line-interactive UPS system usually includes a single-throw static switch, an inductor, and a converter, which in normal operation act as a battery charger. By various techniques, the voltage to the sensitive load can be conditioned by controlling the voltage drop across the inductor. Upon failure of the line, the static switch is opened and the function of the converter is changed to that of an inverter, delivering power to the sensitive load with less than a 0.25-cycle interruption.

### 6.2.3.9 UPS and engine generators

In most sensitive-equipment sites, operation of the sensitive equipment without cooling can extend to about 15 min. Beyond that time, even with sensitive-equipment power available, the system should be shut down. To provide for indefinite interruptions, therefore, a combination of UPS and engine generator is added.

Figure 19 illustrates such a system. The UPS operates normally, conditioning the power to the sensitive equipment with the engine generator at rest. Upon loss of power, the battery continues to supply the sensitive equipment, while the cooling and lighting loads go out.

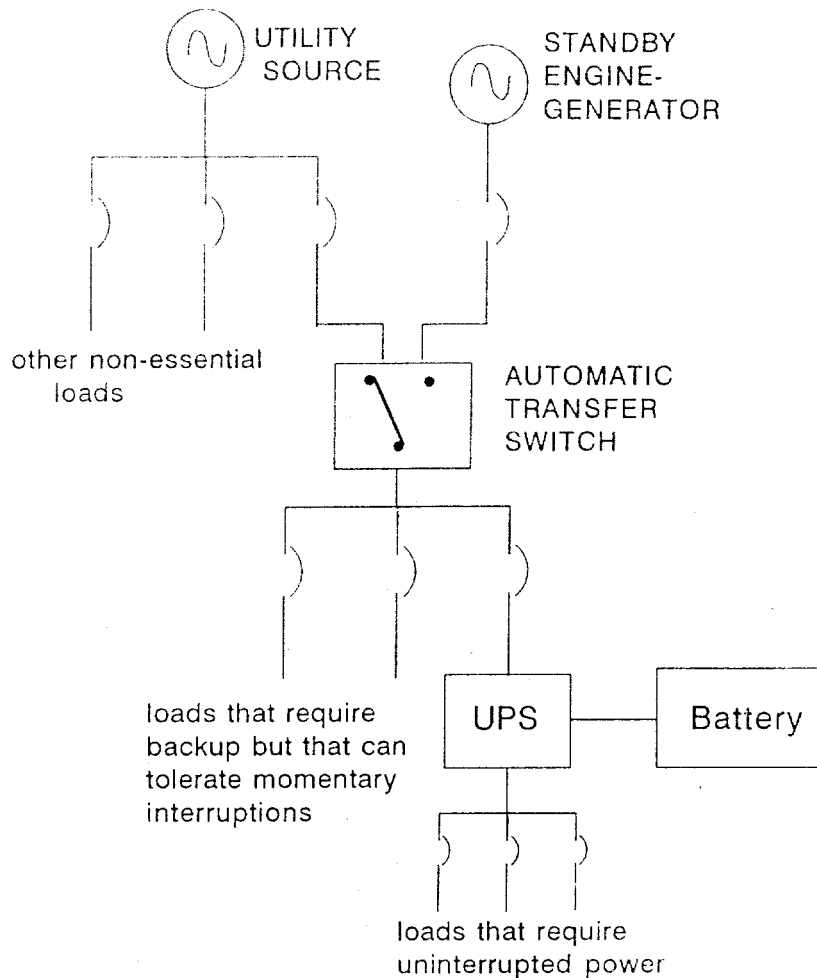

**Figure 19—Combination UPS and engine generator**

After a preset period (typically 15–30 s to prevent nuisance starts), the engine generator automatically starts and restores power to the cooling and lighting systems and to the UPS. Normal UPS operation resumes and the battery is no longer discharged. This permits the use of a smaller (perhaps 5 min) battery. While operating in this mode, the engine generator may be subjected to sudden load changes, such as the starting of a compressor motor in the air conditioning system. This situation can cause a momentary frequency excursion, due to engine-speed change, until corrected by the governor. The frequency (and/or its rate of change) is likely to exceed the tolerance of the sensitive equipment causing malfunctions. However, with the interposing UPS, the frequency can be maintained within tolerance, eliminating the problem.

Engine generators increase the cost and maintenance of an installation and should be added only if long interruptions are anticipated and if these losses create a significant problem.

### 6.2.3.10 Harmonic filters

Harmonic filters are designed to control the level of voltage and current distortion generated by all of the elements of the equipment to which they are connected, including sensitive equipment, which often generates distortion by itself. Filters consist of active or passive circuit elements. Most such filters in use today are passive and provide a short-circuit path for the harmonics generated by the load using one or more series-tuned traps.

Problems in application include excessive voltage or current due to resonance with other elements in the power system and excessive power frequency current drawn by the filter. In addition, because of their low impedance to specific harmonics, they attract currents of the same harmonic if they exist elsewhere on the power system, potentially overloading the filter. For these reasons, such filters are generally applied on an engineered or special basis. However, some filters are standardly equipped with isolating and/or power-factor-correcting circuitry that can mitigate these problems.

## 6.3 Additional problems and solutions

### 6.3.1 Harmonics at point of use

In general, electrical and electronic equipment, such as rectifier power supplies, are not greatly affected by small amounts of harmonic distortion. Problems may occur where there is enough harmonic current distortion to adversely affect the supply voltage. High levels of reactive harmonic current injection may overload building wiring and service transformers and may cause abnormal rms voltage or very distorted waveshape. IEEE Std 519-1992 [B6] recommends TDD limits at the point of common coupling to other users, including the effect of customer load-induced harmonics. In actual practice, the utility system distortion is usually less than the proposed limits, but the customer load-induced harmonics often cause voltage THD to exceed 5% at the point of use. Also, current distortion in three-phase, 4-wire systems feeding multiple nonlinear single-phase loads, such as computer power supplies, often creates excessive neutral current. The result may be wiring overloads and fire hazards or damage to the delta-wye supply transformer typically provided (figure 9).

It is recommended that the harmonic current limits be followed to protect the facility power system, which is probably more vulnerable to adverse harmonic effects than the facility loads.

The following are actions that help reduce the effects of load-induced waveform distortion (see [B12] for more detail):

- Reduce the impedance of the power source. A larger source transformer (or generator) of the same type will have a lower impedance and will reduce voltage distortion proportionally. This may also be necessary to accommodate the extra heating because of third harmonics (and odd multiples of third) circulating in the delta winding [B19]. This is typically an expensive solution.
- Move the symptomatic load to a lower impedance circuit. Best results occur when a dedicated circuit is run from the main service transformer to the load, or to a stepdown transformer adjacent to the load.
- Move the harmonic-producing loads to other circuits. The best results occur when the harmonic-producing loads are moved to a circuit that is on a separate power source, thereby providing some degree of electrical isolation.
- Provide a separate ferroresonant regulating transformer for each load element. This method provides correction for distortion by harmonic isolation of each load from the other load elements and from the common power source. This is the result of the filter characteristics of the *constant voltage trans-*

*former* (CVT). Because of the tuned circuit in the CVT, unstable operation of certain sensitive loads sometimes occurs.

- For the special case of third harmonics and their odd multiples, a properly sized delta-connected transformer will provide a circulating path for these harmonics, reducing their effect upstream from the transformer (toward the power source and other loads common to it). Computer power supplies are rich in third harmonic current, but also contain significant higher-order harmonics.
- Provide harmonic filters in lieu of capacitors to control harmonic current flow.
- In three-phase systems, harmonics can also be mitigated by special transformer circuitry. One example is the use of a zigzag transformer or a Scott- or T-connected transformer.
- In three-phase systems supplying separate single-phase loads with non-sinusoidal current input, the shared neutral circuit should be increased in current rating to about twice the phase rating [B19]. The capability of the supply transformer should be checked for the nonsinusoidal load by consulting to IEEE Std C57.110-1986 [B8].

## Annex A

(informative)

## Bibliography

### A.1 Standards

[B1] FIPS No. 94, Guideline on Electrical Power for ADP Installations, Sept. 21, 1983.<sup>5</sup>

[B2] IEC Pub 555-2 (1990), Disturbances Caused by Equipment Connected to the Public Low-Voltage Supply Systems.<sup>6</sup>

[B3] IEEE Std 141-1993, IEEE Recommended Practice for Electric Power Distribution for Industrial Plants (IEEE Red Book) (ANSI).<sup>7</sup>

[B4] IEEE Std 242-1986 (Reaff 1991), IEEE Recommended Practice for Protection and Coordination of Industrial and Commercial Power Systems (IEEE Buff Book) (ANSI).

[B5] IEEE Std 446-1987, IEEE Recommended Practice for Emergency and Standby Power Systems for Industrial and Commercial Applications (IEEE Orange Book) (ANSI).

---

<sup>5</sup>FIPS publications are available from the National Technical Information Service (NTIS), U. S. Dept. of Commerce, 5285 Port Royal Rd., Springfield, VA 22161.

<sup>6</sup>IEC publications are available from IEC Sales Department, Case Postale 131, 3, rue de Varembe, CH-1211, Genève 20, Switzerland/Suisse. IEC publications are also available in the United States from the Sales Department, American National Standards Institute, 11 West 42nd Street, 13th Floor, New York, NY 10036, USA.

<sup>7</sup>IEEE publications are available from the Institute of Electrical and Electronics Engineers, 445 Hoes Lane, P.O. Box 1331, Piscataway, NJ 08855-1331, USA.

[B6] IEEE Std 519-1992, IEEE Recommended Practices and Requirements for Harmonic Control in Electric Power Systems (ANSI).

[B7] IEEE Std 1100-1992, IEEE Recommended Practice for Powering and Grounding Sensitive Electronic Equipment (IEEE Emerald Book) (ANSI).

[B8] IEEE Std C57.110-1986 (Reaff 1992), IEEE Recommended Practice for Establishing Transformer Capability When Supplying Nonsinusoidal Load Currents (ANSI).

[B9] IEEE Std C62.11-1993, IEEE Standard for Metal-Oxide Surge Arresters for Alternating Current Power Circuits (ANSI).

## A.2 Texts

[B10] *The Dranetz Field Handbook for Power Quality Analysis*. Edison, NJ: Dranetz Technologies, Inc., 1991.

[B11] *Electrical Distribution—System Protection*, Third Edition. Cooper Power Systems, 1990.

[B12] Griffith, D. C., *Uninterruptible Power Supplies and Other Power Conditioners for Critical Equipment*. Marcel Dekker, Inc., 1989.

[B13] McEachern, A., *Handbook of Power Signatures*. Foster City, CA: Basic Measuring Instruments, 1988.

[B14] Morrison, R., and Lewis, W. H., *Grounding and Shielding in Facilities*. New York: Wiley Interscience, 1990.

[B15] Standler, R. B., *Protection of Electronic Circuits from Overvoltages*. New York: Wiley Interscience, 1989.

## A.3 Technical papers

[B16] Anderson, L. M., and Bowes, K. B., “The Effects of Power-Line Disturbances on Consumer Electronic Equipment,” *IEEE Transactions on Power Delivery*, vol. 5, no. 2, pp. 1062–1065, April 1990.

[B17] Bowes, K. B., “The Effects of Power Line Disturbances on Electronic Products,” *Official Proceedings of the First International Power Quality Conference*, Long Beach, CA, p. 216, Oct. 15–20, 1989.

[B18] Burke, J. J., Griffith, D. C., and Ward, D. J., “Power Quality—Two Different Perspectives,” *IEEE Transactions on Power Delivery*, vol. 5, no. 3, pp. 1501–1513, July 1990.

[B19] CBEMA (Computer and Business Equipment Manufacturers Association) Information Letter, “Three Phase Power Source Overloading Caused by Small Computers and Electronic Office Equipment,” 1988.

[B20] Chamberlin, D. M., and Pidcock, D. J., “The Northeast Utilities Distribution Disturbance and Interruption Monitoring System,” *IEEE Transactions on Power Delivery*, vol. 6, no. 1, pp. 267–274, Jan. 1991.

[B21] Davidson, R., “Suppression Voltage Ratings on UL Listed Transient Voltage Surge Suppressors (TVSS),” *Proceedings, Open Forum on Surge Protection Application*, National Institute of Standards and Technology Special Publication, pp. 89–92, 1991.

- [B22] “Distribution Line Protection Practices—Industry Survey Results,” *IEEE Transactions on Power Delivery*, vol. 3, no. 2, Apr. 1988.
- [B23] Lai, J. S., and Martzloff, F. D., “Coordinating Cascaded Surge-Protective Devices: High-Low versus Low-High,” *Conference Proceeding, Vol. 2, IEEE/IAS Annual Meeting*, Oct. 1991.
- [B24] Martzloff, F. D., and Gauper, H. G., “Surge and High-Frequency Propagation in Industrial Power Lines,” *IEEE Transactions on Industry Applications*, vol. IA-22, no. 4, July/Aug. 1986.
- [B25] Martzloff, F. D., and Gruzs, T. M., “Power Quality Site Surveys: Facts, Fiction, and Fallacies,” *IEEE Transactions on Industry Applications*, vol. 24, no. 6, Nov./Dec. 1988.
- [B26] Martzloff, F. D., and Hahn, G. J., “Surge Voltages in Residential and Industrial Power Circuits,” *IEEE Transactions on Power Apparatus and Systems*, vol. PAS-89, no. 6, July/Aug. 1970.
- [B27] Martzloff, F. D., and Leedy, T. F., “Selecting Varistor Clamping Voltage: Lower is not Better!,” *Proceedings, Zürich EMC Symposium*, pp. 137–142, 1989.
- [B28] Key, T. S., “Diagnosing Power Quality-Related Computer Problems,” *IEEE Transactions on Industry Applications*, vol. IA-15, no. 4, July/Aug. 1979.
- [B29] Key, T. S., “Evaluation of Grid-Connected Power Systems: The Utility Interface,” *Transactions on Industry Applications*, vol. IA-20, no. 4, pp. 735–741, July/Aug. 1984.
- [B30] “Power System Reliability Analysis: Application Guide Report,” prepared by CIGRE Working Group 03 of Study Committee 38, 1987.
- [B31] Smith, S. B., and Standler, R. B., “The Effects of Surges on Electronic Appliances,” *IEEE Transactions on Power Delivery*, vol. 7, no. 3, pp. 1275–1281, July 1992.
- [B32] Standler, R. B., “Coordination of Surge Arresters and Suppressors for Use on Low-Voltage Mains,” *Proceedings, Zürich EMC Symposium*, pp. 517–524, 1991.
- [B33] Standler, R. B., “Development of a Performance Standard for Surge Arresters and Suppressors,” *IEEE 1991 Symposium on Electromagnetic Compatibility*, Cherry Hill, NJ, pp. 458–463, Aug. 15, 1991.