

ETSI TS 101 493-2 V1.2.1 (2001-12)

Technical Specification

**Broadband Radio Access Networks (BRAN);
HIPERLAN Type 2;
Packet based Convergence Layer;
Part 2: Ethernet Service Specific
Convergence Sublayer (SSCS)**



Reference

RTS/BRAN-0024004-2R1

Keywords

access, broadband, HIPERLAN, radio

ETSI

650 Route des Lucioles
F-06921 Sophia Antipolis Cedex - FRANCE

Tel.: +33 4 92 94 42 00 Fax: +33 4 93 65 47 16

Siret N° 348 623 562 00017 - NAF 742 C
Association à but non lucratif enregistrée à la
Sous-Préfecture de Grasse (06) N° 7803/88

Important notice

Individual copies of the present document can be downloaded from:

<http://www.etsi.org>

The present document may be made available in more than one electronic version or in print. In any case of existing or perceived difference in contents between such versions, the reference version is the Portable Document Format (PDF). In case of dispute, the reference shall be the printing on ETSI printers of the PDF version kept on a specific network drive within ETSI Secretariat.

Users of the present document should be aware that the document may be subject to revision or change of status. Information on the current status of this and other ETSI documents is available at

<http://portal.etsi.org/tb/status/status.asp>

If you find errors in the present document, send your comment to:

editor@etsi.fr

Copyright Notification

No part may be reproduced except as authorized by written permission.
The copyright and the foregoing restriction extend to reproduction in all media.

© European Telecommunications Standards Institute 2001.
All rights reserved.

Contents

Intellectual Property Rights	4
Foreword.....	4
1 Scope	5
2 References	5
3 Definitions, symbols and abbreviations	6
3.1 Definitions	6
3.2 Symbols.....	6
3.3 Abbreviations	6
4 Overview	7
5 User plane.....	8
5.1 General	8
5.2 Primitives (informative)	9
5.2.1 Primitive types	9
5.2.2 Parameter definitions	9
5.2.3 Interface to the Ethernet Layer	10
5.2.4 Interface to the Common Part	10
5.3 Functionality.....	10
5.3.1 General.....	10
5.3.2 Coding of the Ethernet SSCS PDU.....	11
5.4 Procedures	12
5.4.1 General.....	12
5.4.2 Procedures at the sender - Access Point.....	12
5.4.3 Procedures at the sender - Mobile Terminal	14
5.4.4 Procedures at the receiver - Access Point	14
5.4.5 Procedures at the receiver - Mobile Terminal.....	15
6 Control Plane.....	15
6.1 General	15
6.2 Convergence Layer specific parameters.....	16
6.2.1 Convergence Layer Identifier	16
6.2.2 Convergence Layer Version	16
6.2.3 Maximum Transmission Unit	16
6.3 Information Elements for Ethernet SSCS.....	16
6.3.1 Information element format	16
6.3.2 Information element type coding	17
6.3.3 IEEE 802 MAC Address IE.....	17
6.3.4 AP Network Address IE	17
6.4 Procedures	19
6.4.1 Association	19
6.4.2 Network Handover.....	20
6.4.3 Multicast	20
6.4.4 Miscellaneous	21
7 Ethernet SSCS MIB	21
Annex A (normative): Numbering and Coding Conventions.....	22
Annex B (informative): Association procedure for Ethernet SSCS.....	23
Annex C (informative): Example of the MAC_ID table	27
Annex D (informative): Bibliography.....	28
History	29

Intellectual Property Rights

IPRs essential or potentially essential to the present document may have been declared to ETSI. The information pertaining to these essential IPRs, if any, is publicly available for **ETSI members and non-members**, and can be found in ETSI SR 000 314: "*Intellectual Property Rights (IPRs); Essential, or potentially Essential, IPRs notified to ETSI in respect of ETSI standards*", which is available from the ETSI Secretariat. Latest updates are available on the ETSI Web server (<http://webapp.etsi.org/IPR/home.asp>).

Pursuant to the ETSI IPR Policy, no investigation, including IPR searches, has been carried out by ETSI. No guarantee can be given as to the existence of other IPRs not referenced in ETSI SR 000 314 (or the updates on the ETSI Web server) which are, or may be, or may become, essential to the present document.

Foreword

This Technical Specification (TS) has been produced by ETSI Project Broadband Radio Access Networks (BRAN).

It defines the functionality required for interworking High Performance Radio Local Area Network Type 2 (HIPERLAN/2) with IEEE 802.3 Local Area Networks [5]. Separate ETSI documents provide details on the system overview, data link control layer, radio link control sublayer, other convergence sublayers and conformance testing requirements for HIPERLAN/2.

The Packet based Convergence Layer is split into two parts, a Common Part and a Service Specific Part. The Common Part describes the functionality for adapting variable length packets/frames to the fixed size data units used at the Data Link Control (DLC) layer while the Service Specific part describes the functionality required to support a certain protocol, e.g. Ethernet or IP. It is envisioned that several, independent, Service Specific Convergence Sublayers (SSCS) will be defined in the future as market requirements develop. The SSCSs all use the services of the Common Part and the DLC.

The present document is part 2 of a multi-part deliverable covering the Packet based Convergence Layer, as identified below:

- Part 1: "Common Part";
- Part 2: "Ethernet Service Specific Convergence Sublayer (SSCS)";**
- Part 3: "IEEE 1394 Service Specific Convergence Sublayer (SSCS)";
- Part 4: "IEEE 1394 Bridge Specific Functions sub-layer for restricted topology";
- Part 5: "IEEE 1394 Bridge Specific Functions sub-layer for unrestricted topology".

Part 1 describes the functionality for adapting variable length packets/frames to the fixed size used in the Data Link Control (DLC) layer. Further parts, each defining a Service Specific Convergence Sublayer (SSCS), describe the functionality required to support a certain protocol, e.g. IEEE 1394 [7] or Ethernet protocols. The SSCSs all use the services of the Common Part and the DLC [2]. It is envisioned that several, independent, service specific parts will be defined in the future as market requirements develop. As a result, further parts may be added in the future.

1 Scope

The present document is applicable to HIPERLAN/2 equipment supporting interworking with IEEE 802.3 Local Area Networks [5].

The present document does only address the functionality required to transfer IEEE 802.3 [5] frames over the radio interface between an HIPERLAN/2 Access Point and Mobile Terminal. Note that the frame type described in IEEE 802.3 [5], also covers Ethernet v2 (see bibliography). The present document does not address the requirements and technical characteristics for wired network interfaces at the Access Point and at the Mobile Terminal.

The present document supports both best effort and the IEEE 802.1p priority mechanisms developed to enable Quality-of-Service in LANs.

The present document uses the services provided by the Common Part of the Packet based Convergence Layer and by the Data Link Control layer of HIPERLAN/2.

The present document does not address the requirements and technical characteristics for conformance testing. Those are covered in separate documents.

2 References

The following documents contain provisions which, through reference in this text, constitute provisions of the present document.

- References are either specific (identified by date of publication and/or edition number or version number) or non-specific.
- For a specific reference, subsequent revisions do not apply.
- For a non-specific reference, the latest version applies.

- [1] ETSI TS 101 493-1 (V1.1.1): "Broadband Radio Access Networks (BRAN); HIPERLAN Type 2; Packet based Convergence Layer; Part 1: Common Part".
- [2] ETSI TS 101 761-2: "Broadband Radio Access Networks (BRAN); HIPERLAN Type 2; Data Link Control (DLC) layer; Part 2: Radio Link Control (RLC) sublayer".
- [3] ETSI TS 101 761-1: "Broadband Radio Access Networks (BRAN); HIPERLAN Type 2; Data Link Control (DLC) Layer; Part 1: Basic Data Transport Functions".
- [4] ISO/IEC 15802-3 (1998) [ANSI/IEEE Std 802.1D, 1998 Edition]: "Information technology - Telecommunications and information exchange between systems - Local and metropolitan area networks - Common specifications - Part 3: Media Access Control (MAC) Bridges".
- [5] IEEE 802.3 (1998): "Information technology - Telecommunications and information exchange between systems - Local and metropolitan area networks - Specific requirements - Part 3: Carrier sense multiple access with collision detection (CSMA/CD) access method and physical layer specifications".
- [6] IEEE 802.3ac (1998): "Information technology - Telecommunications and information exchange between systems - Local and metropolitan area networks - Specific requirements - Part 3: Carrier sense multiple access with collision detection (CSMA/CD) frame extensions for Virtual Bridged Local Area Networks (VLAN) tagging on 802.3 networks".
- [7] IEEE 1394 (1995): "Standard for a High Performance Serial Bus".
- [8] RFC 791 (1981): "Internet Protocol".
- [9] RFC 2373 (1998): "IP Version 6 Addressing Architecture", R. Hinden, S. Deering".

3 Definitions, symbols and abbreviations

3.1 Definitions

For the purposes of the present document, the following terms and definitions apply:

Maximum Transmission Unit (MTU): maximum packet size in octets that can be conveyed in one piece over a link

Protocol Data Unit (PDU): data unit exchanged between entities at the same ISO layer

Service Data Unit (SDU): data unit exchanged between adjacent ISO layers

3.2 Symbols

For the purposes of the present document, the following symbol applies:

0x Hexadecimal notation

3.3 Abbreviations

For the purposes of the present document, the following abbreviations apply:

AP	Access Point
BRAN	Broadband Radio Access Networks (Project)
CL	Convergence Layer
CPCS	Common Part Convergence Sublayer
C-SAP	Control Service Access Point
DLC	Data Link Control
DLCC	DLC Connection
DUC	DLC User Connection
HIPERLAN/2	High Performance Radio Local Area Network Type 2
H/2	see HIPERLAN/2
IE	Information Element
IEEE	Institute of Electrical and Electronics Engineers
IP	Internet Protocol
IPv4	IP version 4
IPv6	IP version 6
LAN	Local Area Network
LLC	Logical Link Control
LSB	Least Significant Bit
M-SAP	MAC Service Access Point
MAC	Medium Access Control
MSB	Most Significant Bit
MT	Mobile Terminal
MTU	Maximum Transmission Unit
PDU	Protocol Data Unit
QoS	Quality of Service
RLC	Radio Link Control
RFC	Request For Comments
SAP	Service Access Point
SDU	Service Data Unit
SFD	Start Frame Delimiter
SSCS	Service Specific Convergence Sublayer
TCI	Tag Control Information field
TCP	Transmission Control Protocol
TPID	Tag Protocol Identifier
UDP	User Datagram Protocol

4 Overview

The Ethernet Service Specific Convergence Sublayer is a part of the Packet based Convergence Layer and it resides on top of the Common Part and the DLC. It provides a method of using and preserving the IEEE 802.3 frame format over the radio interface by adapting service requests for transmission and reception of 802.3 frames to bearer services offered by the DLC.

All Mobile Terminals (MT), associated to the same AP, appear like connected to one common fixed shared medium LAN segment. In contrast to a normal fixed LAN segment where all terminals are able to listen to all traffic on the segment, traffic that is originated by one MT is always first sent up to the AP. It is then the task of the AP to relay the traffic to either the fixed network and/or to other MTs associated to that AP.

The network topology when applied to HIPERLAN/2 is shown in figure 4.1. Please note that the scope of the Ethernet SSCS is limited to the radio interface only (shaded in grey). The architecture of the AP, e.g. if it only contains Layer 2 (i.e. MAC bridging) functionality or if it also includes Layer 3 (i.e. IP routing) functionality, is not standardized.

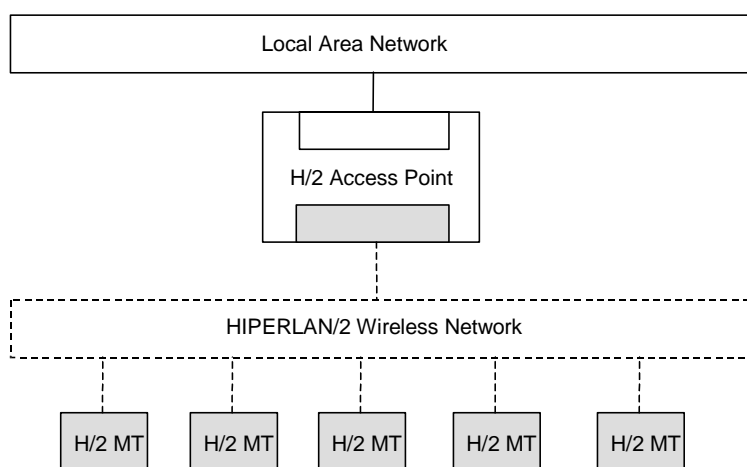

Figure 4.1: HIPERLAN/2 network topology using Ethernet SSCS

The corresponding protocol model for Ethernet SSCS is depicted in figure 4.2. The Ethernet SSCS replaces the MAC entity in the IEEE 802 model. At the MT, the CL User Service Access Point is mapped to the M-SAP, the SAP between IEEE 802.2 (LLC) and the IEEE 802.3 (MAC) layers. At the AP, the Ethernet SSCS replaces the IEEE 802.3 MAC entity and interacts with the MAC relay entity of an IEEE 802.1D bridge.

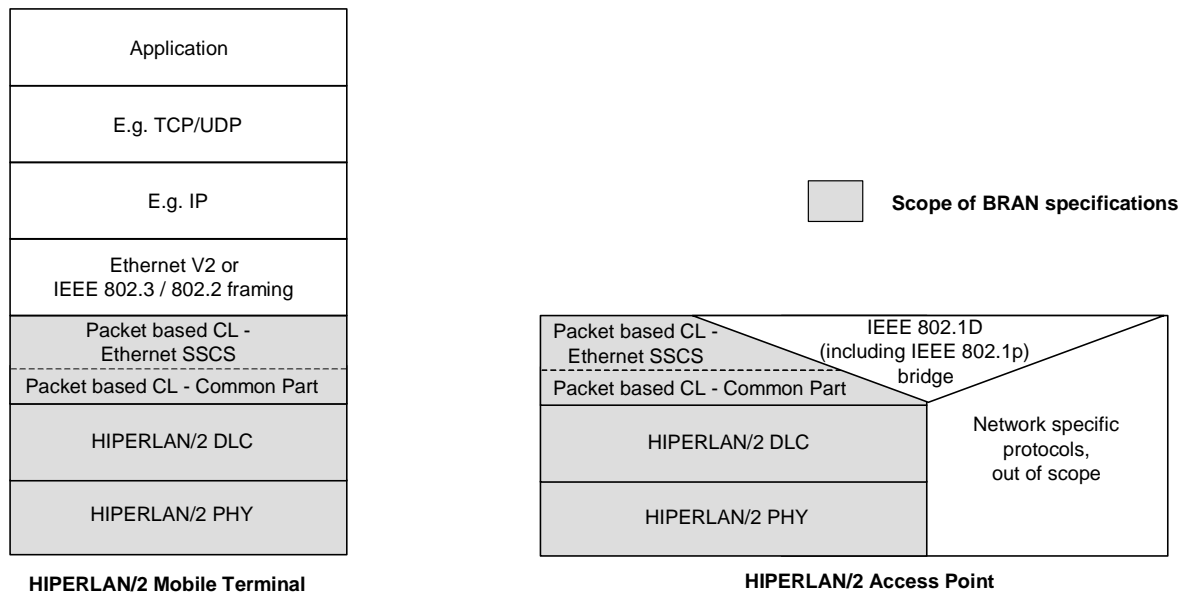

Figure 4.2: Ethernet SSCS architecture applied to HIPERLAN/2

The Ethernet SSCS supports two Quality-of-Service types:

a) Best Effort

This is the default QoS type that shall be supported. All traffic is treated equally and no Quality-of-Service guarantees can be provided.

b) IEEE 802.1p priority based QoS scheme

IEEE 802.1p provides priority mechanisms to enable Quality-of-Service in Local Area Networks. These mechanisms have been incorporated into IEEE 802.1D [4]. Eight (numbered 0-7) different priority levels are defined. The user priorities are mapped one-to-one or many-to-one to queues, depending on the number of queues supported. In HIPERLAN/2 each queue corresponds to one DLC user connection. The mapping between user priorities and DLC user connections is defined in clause 5.4.2. The user priority information is carried in each IEEE 802.3 frame using a Tag Header inserted following the source and destination address. The Tag Header is defined in [6] (see clause 5.3.2 for more details on supported frame types). The support for IEEE 802.1p is optional for both the MT and AP.

The Quality-of-Service type and additional parameters used by the SSCS are negotiated at association time using the control plane procedures defined in clause 6.

The Ethernet SSCS consists of a user plane and a control plane. The user plane, described in clause 5, provides services to the Higher Layer via the CL-Service Access Point (SAP) and uses the services of the Common Part of the Packet based Convergence Layer [1]. The control plane of the Ethernet SSCS, described in clause 6, interacts with the DLC control plane, i.e. the RLC sublayer, via the DLC Control SAP. The DLC Control SAP is defined in [2].

5 User plane

5.1 General

The user plane procedures of the Ethernet SSCS provide the capability to transfer Ethernet SSCS SDUs between the Ethernet SSCS of the AP and one or more Ethernet SSCSs of MTs over the HIPERLAN/2 network.

It is the task of the Ethernet SSCS to map the address and priority scheme of the Higher Layer to the address and priority scheme of the DLC layer.

Ethernet SSCS SDUs coming from the Higher Layer are mapped onto different DLC user connections, depending on the Ethernet destination address and priority. The relation between Ethernet address/priority and DLC user connections is managed by the Ethernet SSCS control plane (see clause 6).

The behaviour of the user plane procedures for AP and MT is asymmetric. All MTs transfer all Ethernet SSCS SDUs to the Ethernet SSCS of the AP. It is the task of the Ethernet SSCS of the AP to reflect Ethernet SSCS SDUs back to the HIPERLAN/2 network, if necessary to emulate the behaviour of a shared medium LAN segment (see clause 5.3). The AP directs the Ethernet SDUs to one Ethernet SSCS in case of unicast. In case of multicast and broadcast the AP directs the Ethernet SDU to one or more Ethernet SSCS of MTs, if multiple MTs have subscribed to a multicast group or if multiple MTs have associated to the AP.

5.2 Primitives (informative)

The Ethernet SSCS exchanges service primitives with the Higher Layer and the CPCS.

NOTE: The primitives are defined only for the purpose of describing layer-to-layer and sublayer-to-sublayer interactions. These primitives are defined as an abstract list of parameters, and their concrete realization may vary between implementations. No formal testing of primitives is intended. The following primitive definitions have no normative significance.

5.2.1 Primitive types

Interface between layers

Four primitive types may be used between different layers:

- req (request), for a higher layer to request service from a lower layer;
- cnf (confirm), for the layer providing the service to confirm the activity has been completed;
- ind (indication), for a layer providing service to notify the next higher layer of any specific service related activity;
- rsp (response), for a layer to acknowledge receipt of an indication primitive from the next lower layer.

Interface between sublayers

Two different primitives may be used between different sublayers. To indicate the absence of a Service Access Point these primitives differ to the primitives between different layers.

- inv (invoke), for a higher layer to request service from a lower layer;
- sig (signal), for a layer providing service to notify the next higher layer of any specific service related activity.

The defined types for each category of primitive are shown as a list in curly brackets.

EXAMPLE: CL_UNITDATA {req, ind}

In this example, the defined types are request and indication but not confirm or response.

5.2.2 Parameter definitions

Endpoint identifiers: some primitives contain an endpoint identifier. This identifier shall be used to distinguish primitives related to different protocol instances. As identifier the DLC User Connection ID, which is the concatenation of a MAC_ID and DLCC_ID [3], shall be used. The coding of this identifier is a local matter not defined in the present document. The identifier is defined as:

- DLC User Connection ID (DUC_ID)

Message unit: each piece of higher layer information that is included in the primitive is called a message unit. A series of one or more message units may be associated with each primitive where each separate unit is related to one information element in the corresponding DLC layer message. The list of message units is derived from the message definitions by reference to the information elements that may contain information from or (to) the CL.

5.2.3 Interface to the Ethernet Layer

The following primitives are used

CL_UNITDATA {req, ind}

PARAMETER	REQ	CNF	IND	RSP
Message units (possible elements)				
Destination address	A	-	A	-
Source address	A	-	A	-
Interface Data (SSCS-SDU)	A	-	A	-
Priority	O	-	-	-
NOTE: A = Always present; O = Optional; "-" = Not applicable.				

Destination address

This parameter specifies a 48-bit IEEE MAC Destination Address as defined in [5].

Source address

This parameter specifies a 48-bit IEEE MAC Source Address as defined in [5].

Interface Data

This parameter specifies the Interface Data exchanged between the Higher Layer and the Ethernet SSCS entity. The Interface Data represents a complete Ethernet SSCS-SDU. The types of SDUs that shall be supported are described in clause 5.3.2.

Priority

This parameter specifies the priority assigned to each Ethernet SSCS-SDU according to IEEE 802.1D [4].

5.2.4 Interface to the Common Part

The interface to the Common Part of the Packet based Convergence Layer is defined in [1].

5.3 Functionality

5.3.1 General

The Ethernet Service Specific Convergence Sublayer functions are performed on an Ethernet SSCS-PDU basis. The Ethernet SSCS accepts different types of frames. The types that shall be supported are described in clause 5.3.2.

The functions implemented by the Ethernet SSCS user plane include:

- a) Preservation of Ethernet SSCS-SDU

This function provides the delineation and transparent transfer of Ethernet SSCS-SDUs.

- b) Traffic class mapping according to 802.1p (optional)

This function provides the mapping of different traffic classes to different priority queues, depending on how many priority queues are supported.

- c) Mapping of Ethernet broadcast to HIPERLAN/2 DLC broadcast service

This function provides the mapping of Ethernet broadcast to the broadcast service offered by the HIPERLAN/2 DLC.

- d) Mapping of Ethernet multicast to HIPERLAN/2 DLC multicast service

This function provides the mapping of Ethernet multicast to the multicast service offered by the HIPERLAN/2 DLC.

e) Emulation of a collision domain

This function provides that MTs associated to the same AP appear to be connected as if connected to a shared medium LAN segment.

To emulate the behaviour of a shared medium LAN segment the following functionality is required:

At the Access Point

Ethernet frames shall be reflected back to the radio interface in case of:

- Ethernet broadcast frames if an MT associated to the AP is the source;
- Ethernet multicast, if one or more MTs associated to the same AP have registered to the same multicast group and one MT associated to the AP is the source;
- Ethernet unicast, if an MT sends frames destined to another MT that is associated to the same AP.

In case of multicast and broadcast, the Ethernet frames shall also be forwarded to the Higher Layer.

At the Mobile Terminal

- Ethernet traffic that has been reflected back to the radio interface shall be filtered out and discarded by the originating MT;
- The Higher layer shall not receive Ethernet frames that have been sent by itself before.

5.3.2 Coding of the Ethernet SSCS PDU

The Ethernet SSCS shall accept the Ethernet frame types described in figures 5.1 and 5.2. The Ethernet frames shall be mapped to the CPCS-SDU beginning with the Destination Address field and ending with the Payload (including Padding if present). Preamble, Start Frame Delimiter (SFD) and Frame Check Sequence (FCS) shall be omitted.

In contrast to the transmission order specified for Ethernet [5], where the least significant bit is transmitted first on the physical medium, the Ethernet SSCS-PDUs shall be transmitted according to the transmission order defined in the DLC [3] and RLC [2], see also annex A.

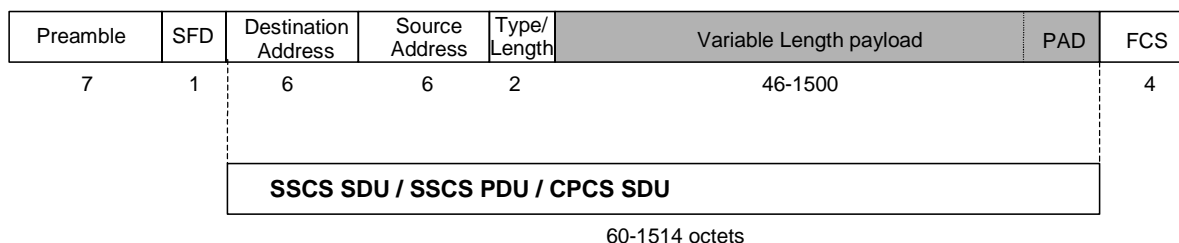

Figure 5.1: IEEE 802.3 frame

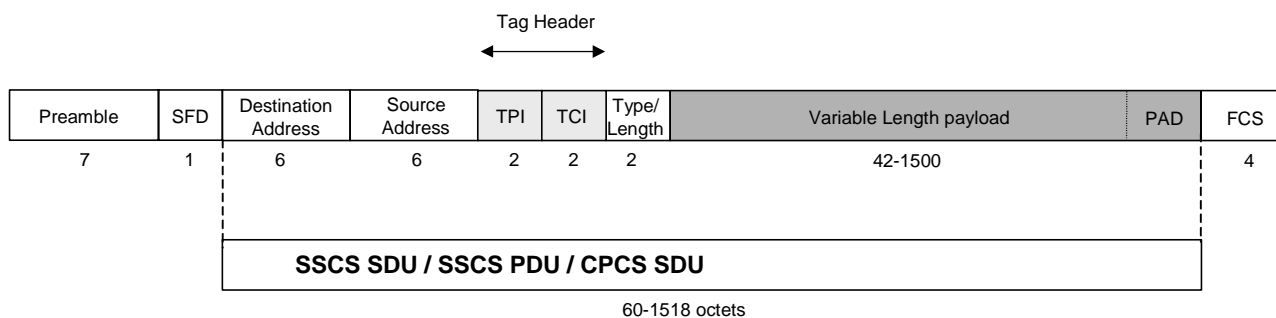

Figure 5.2: IEEE 802.3 frame with IEEE 802.3ac Tagging

5.4 Procedures

5.4.1 General

The procedures of the Ethernet SSCS, defined in the following clauses, are asymmetric and thus differ between Access Point and Mobile Terminal.

5.4.2 Procedures at the sender - Access Point

NOTE 1: The following parameters have no normative significance. The parameters are only defined for the purpose of describing the procedures of sender and receiver.

The sender maintains the following parameters:

<MAC ID table>

This table is shared by sender and receiver within one CL entity. Entries are set by control functions and entries are read by the sender and the receiver. The table maps IEEE 802 MAC Addresses to DLC MAC_IDs, see annex C. It is possible that multiple MAC_IDs are associated to one IEEE 802 MAC address in case Ethernet multicast is sent as DLC unicast.

<Number of DLC Connections table>

Entries in this table, reflecting the negotiated number of DLC connections for each MAC_ID, are set by control functions during association and read by the sender. The number of DLC Connections shall be set to a value from 1 to 8.

<DUC_ID>

The DUC_ID identifies the instance of the Common Part to which the CPCS_UNITDATA invoke primitive is sent. The DUC_ID is the concatenation of MAC_ID and DLCC_ID.

The AP sender shall perform the following procedures:

- 1) Upon reception of a CL_UNITDATA request primitive the sender validates if one or more MAC_IDs are registered for the <Destination address> by querying the <MAC ID table>.

If there is no MAC_ID registered for this <Destination Address>, the SSCS-SDU shall be discarded and the sender waits for the next CL_UNITDATA request.

If there are one or more MAC_IDs registered for the <Destination address>, the sender shall duplicate the Ethernet SSCS-SDU for each MAC_ID that is registered and shall proceed with the steps listed below for each Ethernet SSCS SDU:

- 2) The sender shall set the DLCC_ID:

If the <Destination address> in the Ethernet SSCS-SDU is the 48-bit IEEE broadcast address as specified in [5], the DLCC_ID shall be set to 63.

If the <Destination address> in the Ethernet SSCS-SDU is any of the 48-bit IEEE multicast addresses as specified in [5], the DLCC_ID shall be set to 63 if the related MAC_ID is one of the multicast MAC_IDs (224-255). If the related MAC_ID is not a multicast MAC_ID, the DLCC_ID shall be set according to tables 5.1 and 5.2, depending on the entries of the <Number of DLC Connections table> and the <Priority> received in the primitive.

If the Ethernet SSCS-SDU is an Ethernet unicast, the DLCC_ID shall be set according to tables 5.1 and 5.2, depending on the entries of the <Number of DLC Connections table> and the <Priority> received in the primitive.

- 3) The sender shall construct the SSCS-PDU as shown in clause 5.3.2. It then sends the CPCS_UNITDATA invoke primitive to the CPCS instance identified by the <DUC_ID>.

IEEE 802.1p defines 8 priorities and describes which type of traffic is expected to be carried in this priority. Priority number 2 is currently reserved for future use. The mapping between user priority, traffic type, traffic class and DLCC_ID is described in tables 5.1 and 5.2. Different traffic classes are mapped to different DLCCs. After connection setup the RLC indicates which DLCC_IDs have been assigned to DLCCs in a list (see clause 6.4) and traffic classes are mapped to DLCC_IDs depending on the numerical order of the value of the DLCC_IDs, as shown in table 5.2.

Table 5.1: IEEE 802.1p Traffic Types [4]

User priority	Traffic Type	Comments
1	Background (BK)	
2	-	Spare
0 (Default)	Best Effort (BE)	Default LAN traffic
3	Excellent Effort (EE)	For valued customers
4	Controlled Load (CL)	Traffic will have to conform to some form of Higher Layer admission control
5	"Video" (VI)	< 100 ms delay and jitter
6	"Voice" (VO)	< 10 ms delay and jitter
7	Network Control (NC)	

Table 5.2: Mapping between IEEE 802.1p and DLCC-ID

Number of DLCCs	Traffic Classes	DLCC-Id
1	{ Best Effort , Excellent Effort, Background, Voice, Controlled Load, Video, Network Control }	Lowest
2	{ Best Effort , Excellent Effort, Background } { Voice , Controlled Load, Video, Network Control }	Lowest 2 nd lowest
3	{ Best Effort , Excellent Effort, Background } { Controlled Load , Video } { Voice , Network Control }	Lowest 3 rd lowest 2 nd lowest
4	{ Background } { Best Effort , Excellent Effort } { Controlled Load , Video } { Voice , Network Control }	4 th lowest Lowest 3 rd lowest 2 nd lowest
5	{ Background } { Best Effort , Excellent Effort } { Controlled Load } { Video } { Voice , Network Control }	4 th lowest Lowest 3 rd lowest 5 th lowest 2 nd lowest
6	{ Background } { Best Effort } { Excellent Effort } { Controlled Load } { Video } { Voice , Network Control }	4 th lowest Lowest 6 th lowest 3 rd lowest 5 th lowest 2 nd lowest
7	{ Background } { Best Effort } { Excellent Effort } { Controlled Load } { Video } { Voice } { Network Control }	4 th lowest Lowest 6 th lowest 3 rd lowest 5 th lowest 2 nd lowest 7 th lowest
8	{ Background } { Best Effort } { Excellent Effort } { Controlled Load } { Video } { Voice } { Network Control } { Spare }	4 th lowest Lowest 6 th lowest 3 rd lowest 5 th lowest 2 nd lowest 7 th lowest 8 th lowest

NOTE 2: The traffic types written in bold are the distinguishing traffic types that have driven the allocation of types to classes. The "Spare" queue is reserved for future use. The traffic type for this queue has not been specified in 802.1p.

EXAMPLE: The RLC indicates that the following DLCC_IDs have been assigned to DLCCs: [DLCC_ID=6, DLCC_ID=4]. The traffic class {Best effort, Excellent Effort, etc.} shall be mapped to DLCC_ID= 4, as this is the lowest DLCC_ID number, while the traffic class {Voice, Controlled Load etc.} shall be mapped to DLCC_ID=6.

5.4.3 Procedures at the sender - Mobile Terminal

NOTE 1: The following parameters have no normative significance. The parameters are only defined for the purpose of describing the procedures of sender and receiver.

The sender maintains the following parameters:

<Number of DLC Connections>

This parameter is set by control functions during association and read by the sender. It reflects the negotiated number of DLC connections. It shall be set to a value from 1 to 8.

<DUC_ID>

The DUC_ID identifies the instance of the Common Part to which the CPCS_UNITDATA invoke primitive is sent. The DUC_ID is the concatenation of MAC_ID and DLCC_ID.

The MT sender shall perform the following procedures:

- 1) The sender shall set the DLCC_ID according to tables 5.1 and 5.2, depending on the <Number of DLC Connections> and the <Priority> received as parameter.
- 2) The sender shall construct the SSCS PDU as shown in clause 5.3.2. Then it sends the CPCS_UNITDATA invoke primitive to the CPCS instance identified by the <DUC_ID>.

NOTE 2: Ethernet broadcast and multicast originated by the MT is sent as unicast traffic to the AP. The AP distributes this traffic if applicable.

5.4.4 Procedures at the receiver - Access Point

NOTE: The following parameters have no normative significance. The parameters are only defined for the purpose of describing the procedures of sender and receiver.

The receiver maintains the following parameters:

<MAC ID table>

This table is shared by sender and receiver within one CL entity. Entries are set by control functions and entries are read by the sender and the receiver. The table maps IEEE 802 MAC Addresses to DLC MAC_IDs. It is possible that multiple MAC_IDs are associated to one IEEE 802 MAC address in case of multicast, see also annex C.

<DUC_ID>

The DUC Identifier identifies the instance of the Common Part to which the CPCS_UNITDATA invoke primitive is sent. The DUC_ID is the concatenation of MAC_ID and DLCC_ID.

The AP receiver shall perform the following procedures:

- 1) When the receiver receives a CPCS_UNITDATA signal primitive the receiver examines the value of the destination address, which is always sent in the first 6 octets of the Interface Data.
- 2) If the destination address is equal to the 48-bit IEEE 802 MAC broadcast address, the receiver shall invoke the sender procedure at the same entity with the Interface Data. The sender shall treat the SDU as if it was received in a CL_UNITDATA request. The receiver shall create a CL_UNITDATA indication primitive including the parameters, Source Address, Destination Address and Interface Data and send it also to the Higher Layer.

- 3) If the destination address is equal to any 48-bit IEEE 802 MAC multicast address, the receiver shall invoke the sender procedure at the same entity with the Interface Data. The sender shall treat the SDU as if it was received in a CL_UNITDATA request, but it may filter out the SDU back to the originating MT, to avoid unnecessary traffic duplication. The receiver shall create a CL_UNITDATA indication primitive including the parameter Source Address, Destination Address and Interface Data and send it also to the Higher Layer.
- 4) If the destination address is equal to any 48-bit IEEE 802 MAC unicast address and a MAC_ID is registered for this address, the receiver shall invoke the sender procedure at the same entity with the Interface Data. The sender shall treat the SDU as if it was received in a CL_UNITDATA request.
- 5) In all other cases the receiver shall create a CL_UNITDATA indication primitive including the parameters, Source Address, Destination Address and Interface Data and send it to the Higher Layer.

5.4.5 Procedures at the receiver - Mobile Terminal

The receiver maintains the following parameter:

<Own IEEE address>

This parameter is used to filter traffic that has been sent by the MT and was subsequently received by it. The parameter corresponds to the 48-bit IEEE 802 MAC address of the Mobile Terminal.

The MT receiver shall perform the following procedures:

- 1) When the receiver receives a CPCS_UNITDATA signal primitive the receiver shall compare the Source Address, the six octets following the Destination Address of the Interface Data, to the parameter <Own IEEE address>.
- 2) If the Source Address is equal to the value of <Own IEEE address>, the Interface Data shall be discarded.
- 3) If the Source Address is not equal to the value of <Own IEEE address>, the receiver shall create a CL_UNITDATA indication primitive including the parameters, Source Address, Destination Address and Interface Data and send it to the Higher Layer.

6 Control Plane

6.1 General

The control plane of the Ethernet SSCS interacts with the DLC control plane (i.e. the RLC sublayer) via the DLC Control Service Access Point defined in [2].

The following functions are performed by the control plane procedures of the Ethernet SSCS:

- a) Implicit QoS type negotiation during association and network handover (using DLC connection setup procedures);
- b) Triggering of MT originated DLC connection setup at association and network handover;
- c) Triggering of DLC multicast and broadcast join procedures;
- d) AP network address transfer during association and network handover;
- e) MT IEEE 802 MAC address transfer during association and network handover.

The following DLC C-SAP primitives [2] are used by the control plane procedures of the Ethernet SSCS:

- DLC_SETUP - {req, ind};
- DLC_CONNECT - {req, cnf, ind, rsp};
- DLC_MULTICAST_JOIN - {req, cnf, ind, rsp};

- DLC_MULTICAST_LEAVE - {req, ind};
- DLC_CL_BROADCAST_JOIN - {req, cnf, ind, rsp};
- DLC_INFO_TRANSFER - {req, cnf, ind, rsp}.

6.2 Convergence Layer specific parameters

6.2.1 Convergence Layer Identifier

The Convergence Layer ID used in the RLC [2] shall be set according to the table below to indicate the support of Ethernet SSCS in the MT and AP. Bits 6 to 8 identify the Convergence Layer. In case of the Packet based Convergence Layer bits 1 to 5 identify the Service Specific Convergence Sublayer (SSCS).

Bits	8 7 6 5 4 3 2 1	Meaning
	0 0 1 0 0 0 0 0	Ethernet SSCS supported

All other values are reserved for other Convergence Layers.

6.2.2 Convergence Layer Version

The Convergence Layer Version number is an 8-bit field used in the RLC [2]. This field is split into two 4-bit subfields. The four most significant bits (bits 5 to 8) identify the version of the Common Part and the four least significant bits (bits 1 to 4) identify the version of the SSCS. The Convergence Layer Version number shall be set according to the table below to indicate the support of this edition (version 1) of the Ethernet SSCS.

Bits	8 7 6 5 4 3 2 1	Meaning
	x x x x 0 0 0 1	Ethernet SSCS version 1 supported

6.2.3 Maximum Transmission Unit

The Maximum Transmission Unit (MTU) used in the Common Part of the Packet based Convergence Layer [1] shall be set to 1 518 octets.

6.3 Information Elements for Ethernet SSCS

6.3.1 Information element format

In order to transfer Convergence Layer specific information between AP and MT a number of CL information elements are defined. These Convergence Layer specific information elements are transferred transparently by RLC messages within the RLC specific information element <<CL-ATTRIBUTES>> [2]. Each Convergence Layer information element consists of a Type field, a Length field and an Information field, see figure 6.1.

The purpose of the Information Element Type is to identify the information element being sent. The IE Type field is 8 bits, allowing for up to 256 information elements to be defined for a certain SSCS.

The Reserved field is for future use and shall be coded as zero.

The Length field indicates the length of the Information field in octets. It does not include the length of the IE Type field, the Reserved field, or the length of the Length field itself.

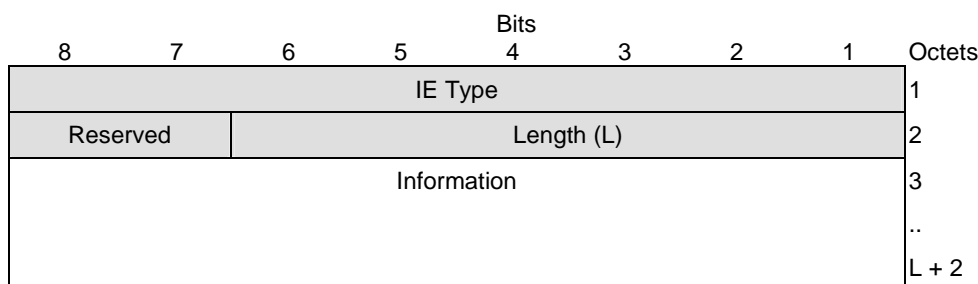

Figure 6.1: Convergence Layer information element structure

6.3.2 Information element type coding

The following IE Type codes are used in the Ethernet SSCS:

Bits	8	7	6	5	4	3	2	1	Meaning
	0	0	0	0	0	0	0	0	IEEE 802 MAC Address (see clause 6.3.3)
	0	0	0	0	0	0	0	1	AP Network Address (see clause 6.3.4)

All other values are reserved for future IEs.

6.3.3 IEEE 802 MAC Address IE

The <<IEEE 802 MAC Address>> information element is used to inform the AP of the MT's IEEE 802 MAC address during association and handover. The information element is also used in the multicast and broadcast procedures to inform the AP about the IEEE 802 MAC address of a certain multicast or broadcast group it wants to join or leave (in case of multicast).

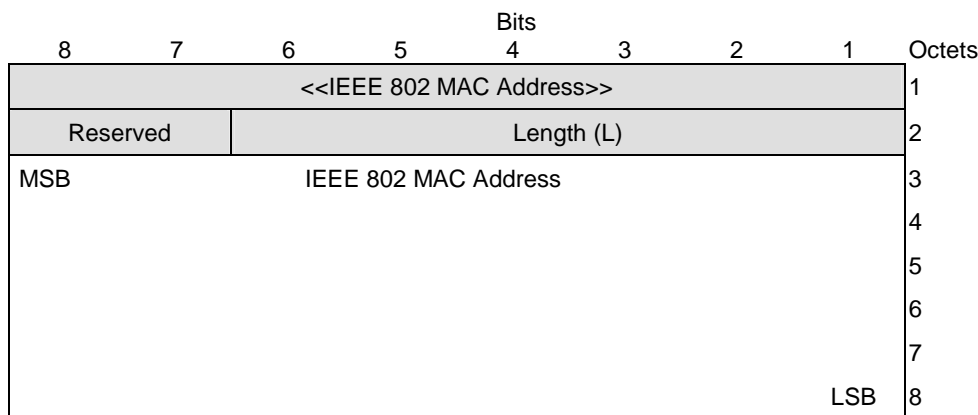

Figure 6.2: IEEE 802 MAC Address information element

6.3.4 AP Network Address IE

The purpose of the <<AP Network Address>> information element is to facilitate routing of network handover messages between APs via the fixed network. It is also used to inform the MT about a change of the network topology, e.g. change of IP subnet, during a handover. The AP shall provide this IE to the MT at association time and at Network Handover. The MT shall provide the IE to the new AP during Network Handover. The address type used in the network is out of scope of the present document.

Address Type (octet 4)

Bits	8 7 6 5 4 3 2 1	Meaning						
0	0	0	0	0	0	0	0	IEEE 802 48 bit MAC address
0	0	0	0	0	0	0	1	IEEE EUI-64 address
0	0	0	0	0	1	0		IP version 4 address
0	0	0	0	0	1	1		IP version 6 address

All other values are reserved for future use.

AP Network Address (octet 5...)

Address Type	Reference	Length (octets)
IEEE 802 48 bit MAC address	[5]	6
IEEE EUI-64	[7]	8
IP version 4 address	RFC 791, [8]	4
IP version 6 address	RFC 2373, [9]	16

AP IPv4 Subnet Mask (32 bits)

The AP IPv4 Subnet Mask is used to inform the MT about the subnet mask of the IP subnet to which the AP is attached. This field is optional and only valid together with an IP version 4 address type in the AP to MT direction. The subnet mask has a length of 32 bits.

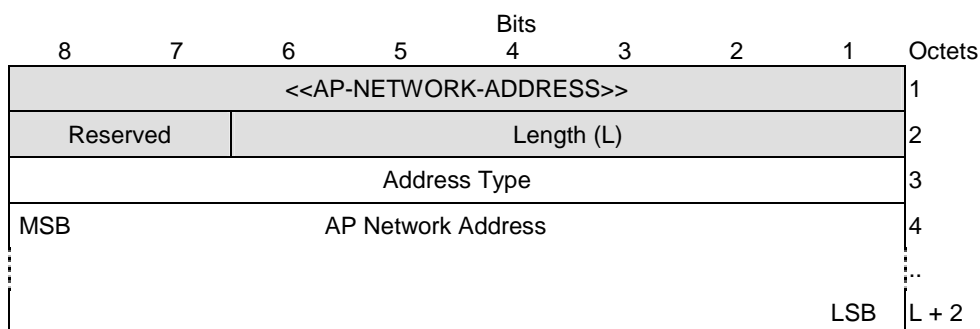
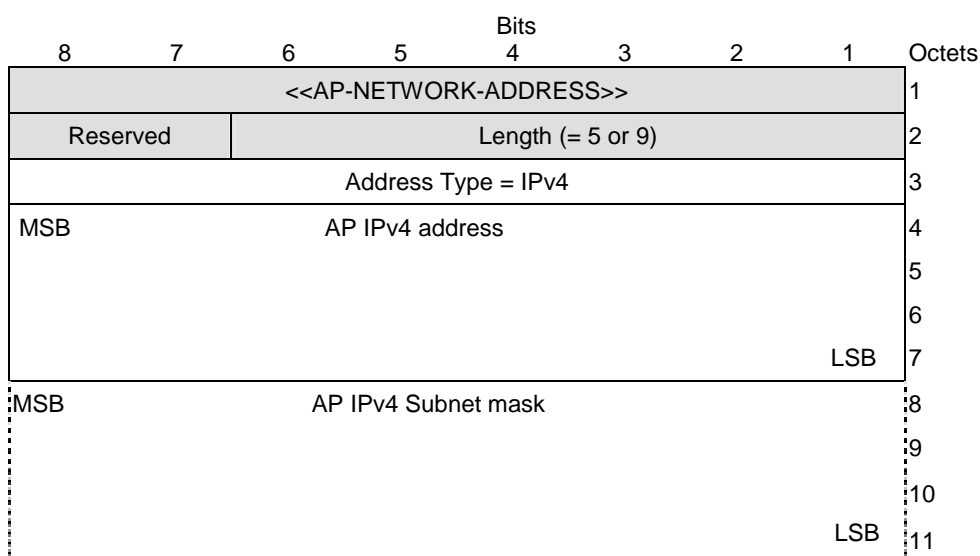

Figure 6.3: AP Network Address information element



NOTE: AP IPv4 Subnet mask is optional and only used with an IPv4 address.

Figure 6.4: AP Network Address information element (for IPv4 address + IPv4 Subnet mask)

AP IPv6 Prefix Length (8 bits)

The AP IPv6 Prefix Length is used to inform the MT about the length of the IPv6 address prefix of the AP. This field is optional and only valid together with an IP version 6 address type in the AP to MT direction. The Prefix Length is a binary coded value specifying how many of the leftmost continuous bits of the address comprise the prefix.

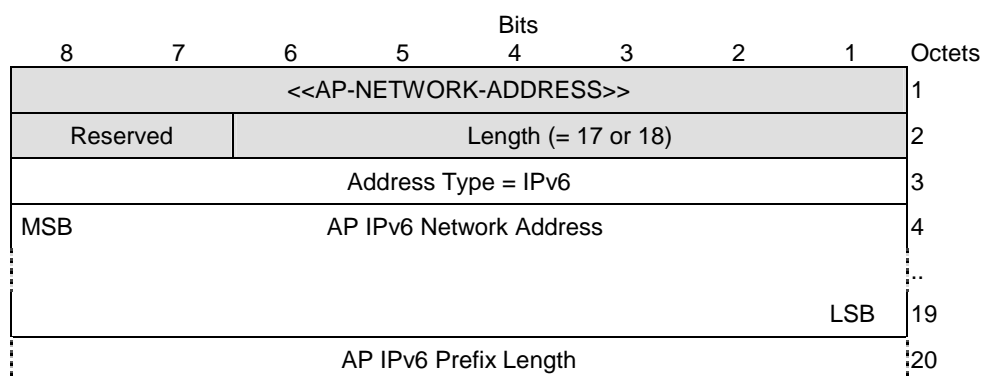

NOTE: AP IPv6 Prefix Length is optional and only used with an IPv6 address.

Figure 6.5: AP Network Address information element (for IPv6 address + IPv6 Prefix Length)

6.4 Procedures

6.4.1 Association

The information field of the <<CL-ATTRIBUTES>> IE in the DLC_INFO_TRANSFER request primitive triggered by the MT during association, see [2], shall contain the following CL information element:

Information Element	Reference	Status	Total length (octets)	Description
IEEE 802 MAC address	Clause 6.3.3	M	8	Contains the IEEE 802 MAC address of the MT

Upon receiving a DLC_INFO_TRANSFER indication the AP shall update the <MAC ID table> with the IEEE 802 MAC address of the MT received in the <<CL-ATTRIBUTES>> IE and the MAC ID assigned to the MT by the DLC.

The AP shall then respond with a DLC_INFO_TRANSFER response primitive. The information field in the <<CL-ATTRIBUTES>> information element sent in the primitive shall contain the following CL information element:

Information Element	Reference	Status	Total length (octets)	Description
AP Network Address	Clause 6.3.4	M	7 - 20	Contains the network address of the AP

Upon receiving a DLC_INFO_TRANSFER the MT shall then trigger a connection setup by issuing a DLC_SETUP request primitive including the number of connections it wants to use. One DLCC equals best effort mode, while 2 to 8 DLCCs indicate that the MT wants to use IEEE 802.1p.

Upon receiving a DLC_SETUP indication primitive the AP shall compare the number of connections requested by the MT with the number of connections supported by the AP. The AP decides on the number of DLC connections that shall be used. However, the value chosen shall not exceed the number of connections requested by the MT. The AP sets the <Number of DLC connections table> entry for the MAC ID of the MT and shall then respond with a DLC_CONNECT request primitive including the number of DLC connections the MT shall use.

Upon reception of a DLC_CONNECT indication primitive the MT shall set the <Number of DLC connections> parameter.

The MT shall then issue a DLC_CL_BROADCAST_JOIN request primitive containing the Ethernet broadcast address (0x) FF:FF:FF:FF:FF:FF. This address shall be transferred by the IEEE 802 MAC address information element within the <<CL_ATTRIBUTES>> IE, see below.

Information Element	Reference	Status	Total length (octets)	Description
IEEE 802 MAC address	Clause 6.3.3	M	8	Contains the IEEE 802 MAC broadcast address (0x) FF:FF:FF:FF:FF:FF

Upon reception of DLC_CL_BROADCAST_JOIN indication primitive the AP shall add the IEEE 802 MAC broadcast address and the broadcast MAC ID allocated by the DLC to the <MAC ID table>.

The AP then issues a DLC_CL_BROADCAST_JOIN response primitive. The SSCS in the AP shall indicate to the user plane that the MT has been successfully associated and user plane operation may commence

The MT receives a DLC_CL_BROADCAST_JOIN confirm primitive including the MAC ID allocated by the AP for Ethernet broadcast. An indication is sent to the user plane that the MT is associated and user plane operation may commence.

NOTE: A single MAC ID is allocated by the AP for all Ethernet broadcasts.

The details of the association procedure are shown in annex B.

6.4.2 Network Handover

For the CL the procedures for Network Handover are the same as the association procedure described in the previous clause, with the following exceptions:

- 1) The <<CL_ATTRIBUTES>> IE in the DLC_INFO_TRANSFER request primitive triggered by the MT during network handover, see [2], shall contain also the AP Network Address of the old AP, see below.

Information Element	Reference	Status	Total length (octets)	Description
IEEE 802 MAC address	Clause 6.3.3	M	8	Contains the IEEE 802 MAC address of the MT
AP Network Address	Clause 6.3.4	M	7 - 19	Contains the network address of the old AP

The AP Network Address shall be the address of the AP to which the MT was associated before the handover. This information may be used by an inter-AP handover protocol specified in the future.

- 2) After the connection setup the MT should join the multicast groups, see clause 6.4.3, which it had joined at the old AP.

NOTE: If Network Handover is supported via the core network the DLC C-SAP primitives triggered by the CL may be ignored by the RLC.

6.4.3 Multicast

The <<CL_ATTRIBUTES>> information element in the DLC_MULTICAST_JOIN request primitive triggered by the MT shall contain the following information element:

Information Element	Reference	Status	Total length (octets)	Description
IEEE 802 MAC address	Clause 6.3.3	M	8	Contains the IEEE 802 MAC multicast group address the MT wants to join.

NOTE: The MT may request to join several multicast groups simultaneously, in which case several IEEE 802 MAC address IEs will be included in the <<CL_ATTRIBUTES>> in the DLC_MULTICAST_JOIN primitives.

Upon reception of a DLC_MULTICAST_JOIN indication primitive the AP updates the <MAC_ID table> with the IEEE 802 MAC multicast address received from the MT and the corresponding MAC ID allocated by the AP. This can either be a multicast MAC ID or a unicast MAC ID. Each IEEE 802 MAC multicast group address can correspond to several MAC IDs.

The AP triggers a DLC_MULTICAST_JOIN response primitive. Upon reception of DLC_MULTICAST_JOIN confirm the MT user plane operation for this multicast address may commence. Filtering for this multicast address at the MT is handled in the DLC layer.

The DLC_MULTICAST_LEAVE primitive triggered by the MT shall contain the IEEE 802 MAC address of the multicast group the MT wants to leave, as in the multicast join procedure (see above). Upon reception of a DLC_MULTICAST_LEAVE indication the AP shall remove the entry for that multicast group from the <MAC ID table> if the MT was the only member of the multicast group.

6.4.4 Miscellaneous

When the AP notices that an MT has left or upon reception of a disassociation indication the AP shall remove all entries in the <MAC ID Table> for that MT. If the MT was the only member of a multicast group the entry for that group shall be removed.

7 Ethernet SSCS MIB

The Management Information Base parameters for the Ethernet SSCS of the Packet based Convergence Layer will be defined in the H/2 Network Management Technical Specification. These MIB parameters may be moved into this clause in a future edition of the present document.

Annex A (normative): Numbering and Coding Conventions

Information elements and PDUs are transferred between the Ethernet SSCS and the underlying protocol layers in units of octets, in ascending numerical octet order (i.e. octet 1, 2, ..., n-1, n), see figure A.1.

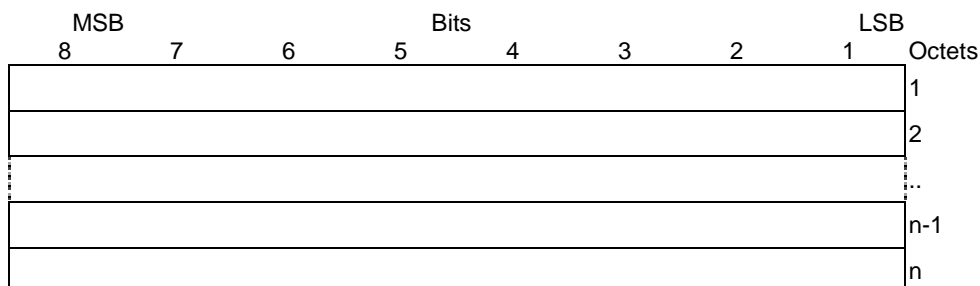

Figure A.1: Format convention

When a field is contained within a single octet, the highest bit number (i.e. the bit labelled 8) represents the high order or most significant bit (MSB).

In a multi-octet field the order (i.e. the significance) of bit values within each octet decreases as the octet number increases. For example, a 16-bit field is coded in the following way, see figure A.2.

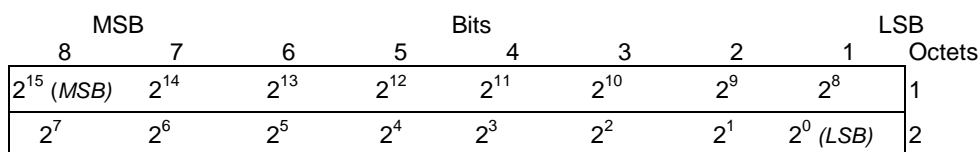

Figure A.2: Corresponding coding in an IE or PDU

Annex B (informative): Association procedure for Ethernet SSCS

Figures B.1 to B.4 highlight the sequence of RLC procedures at association time that is specific to the Ethernet SSCS.

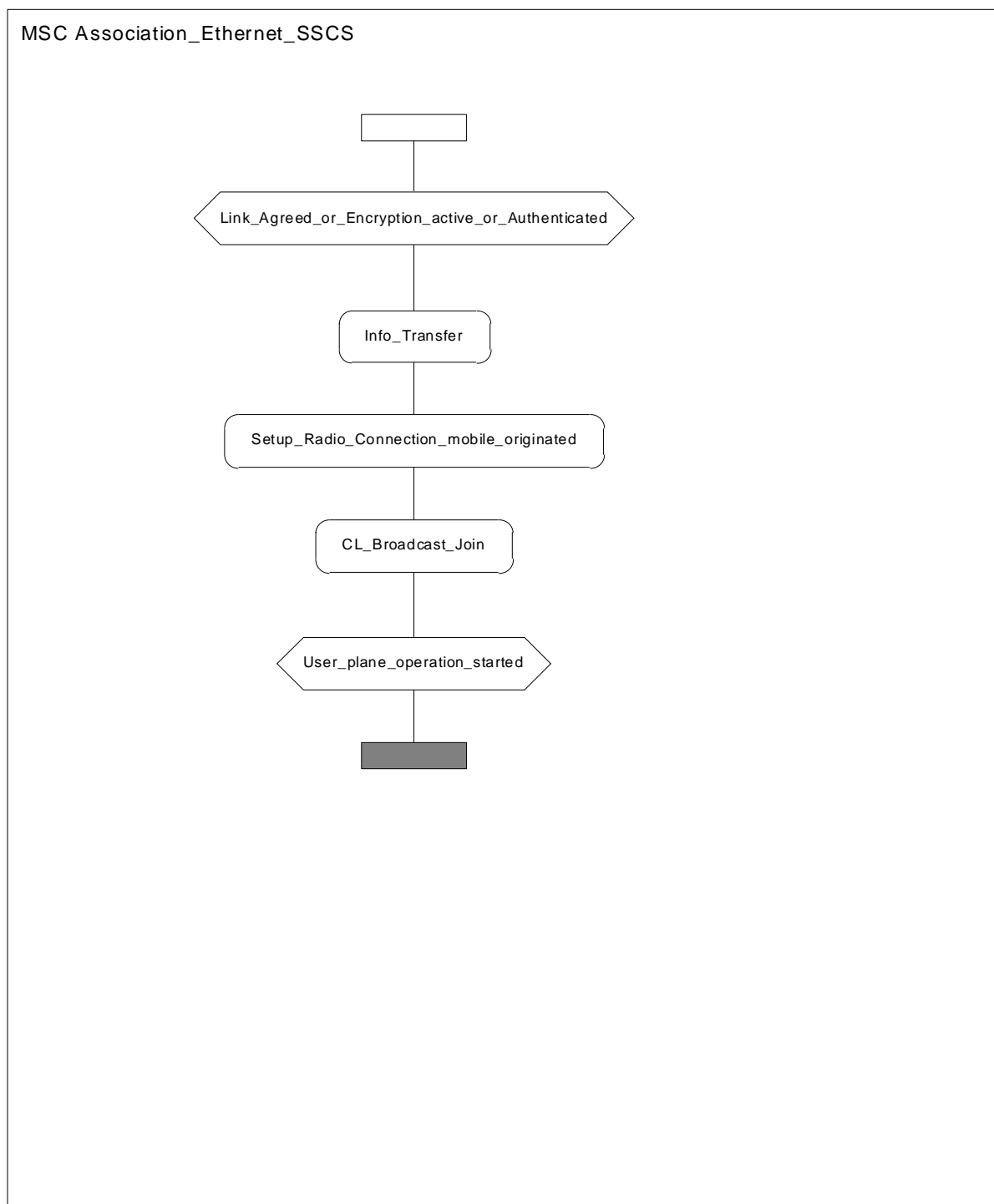

Figure B.1: High-level association procedure for Ethernet SSCS

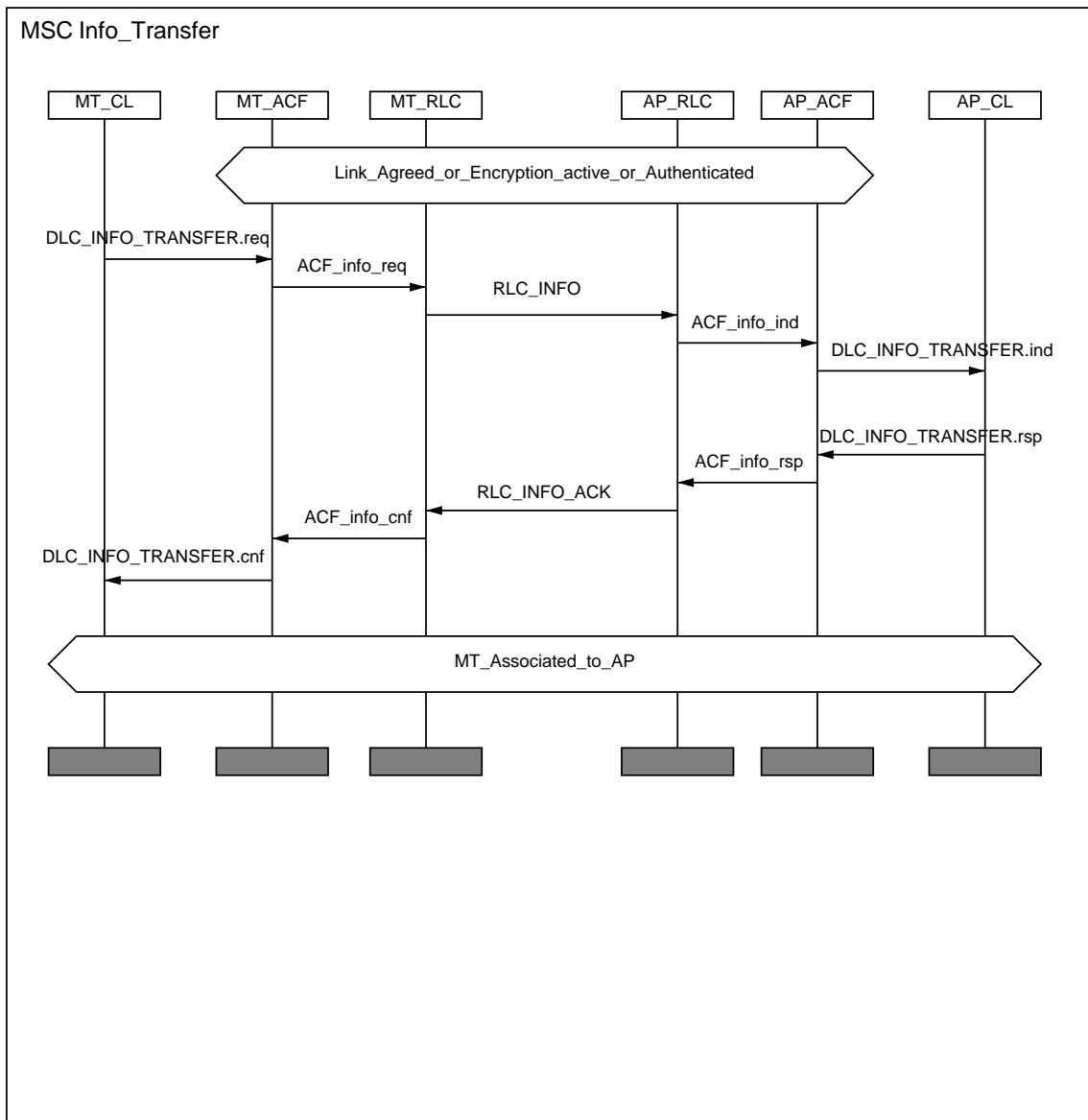

Figure B.2: Info transfer procedure

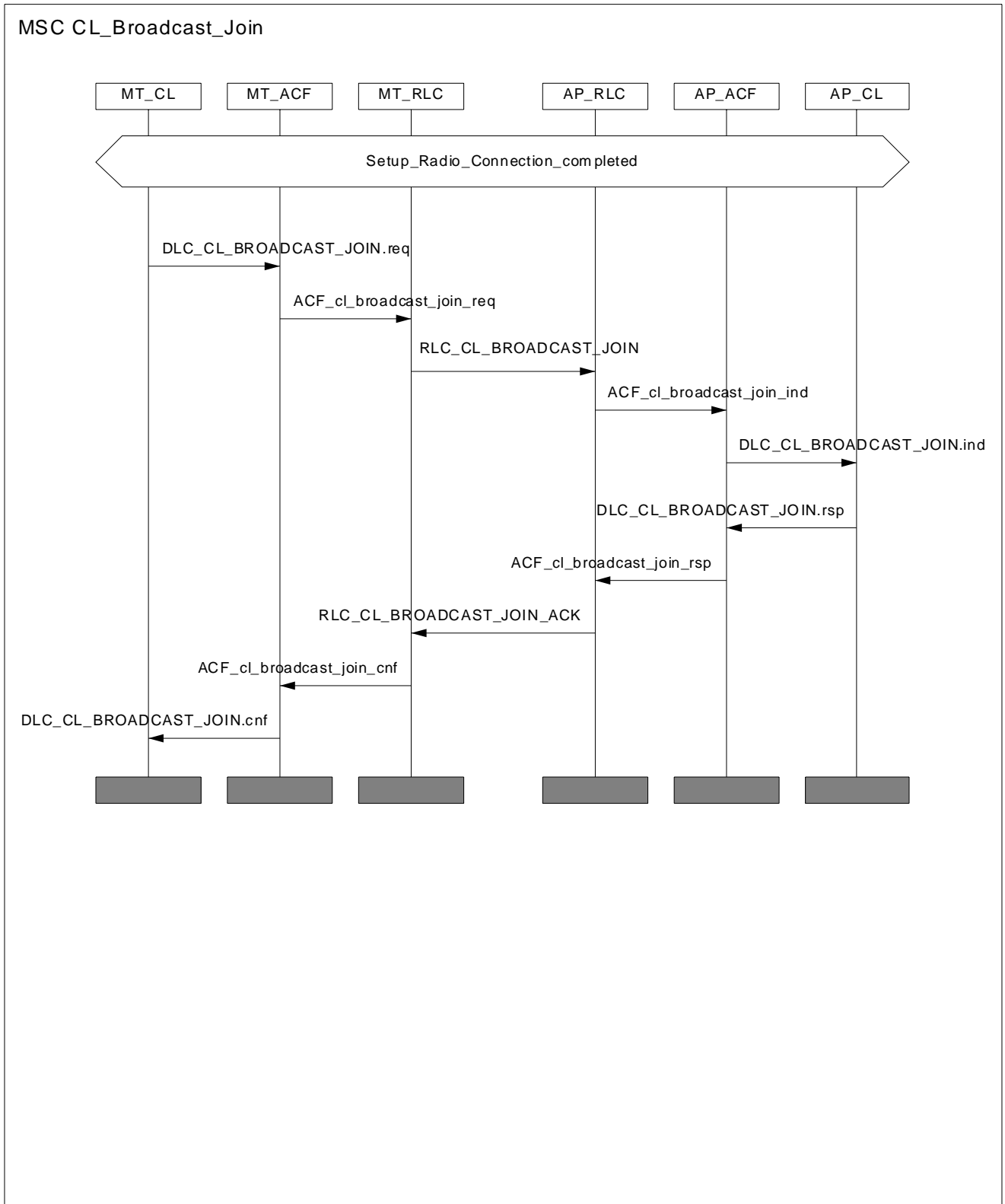

Figure B.3: CL Broadcast Join procedure

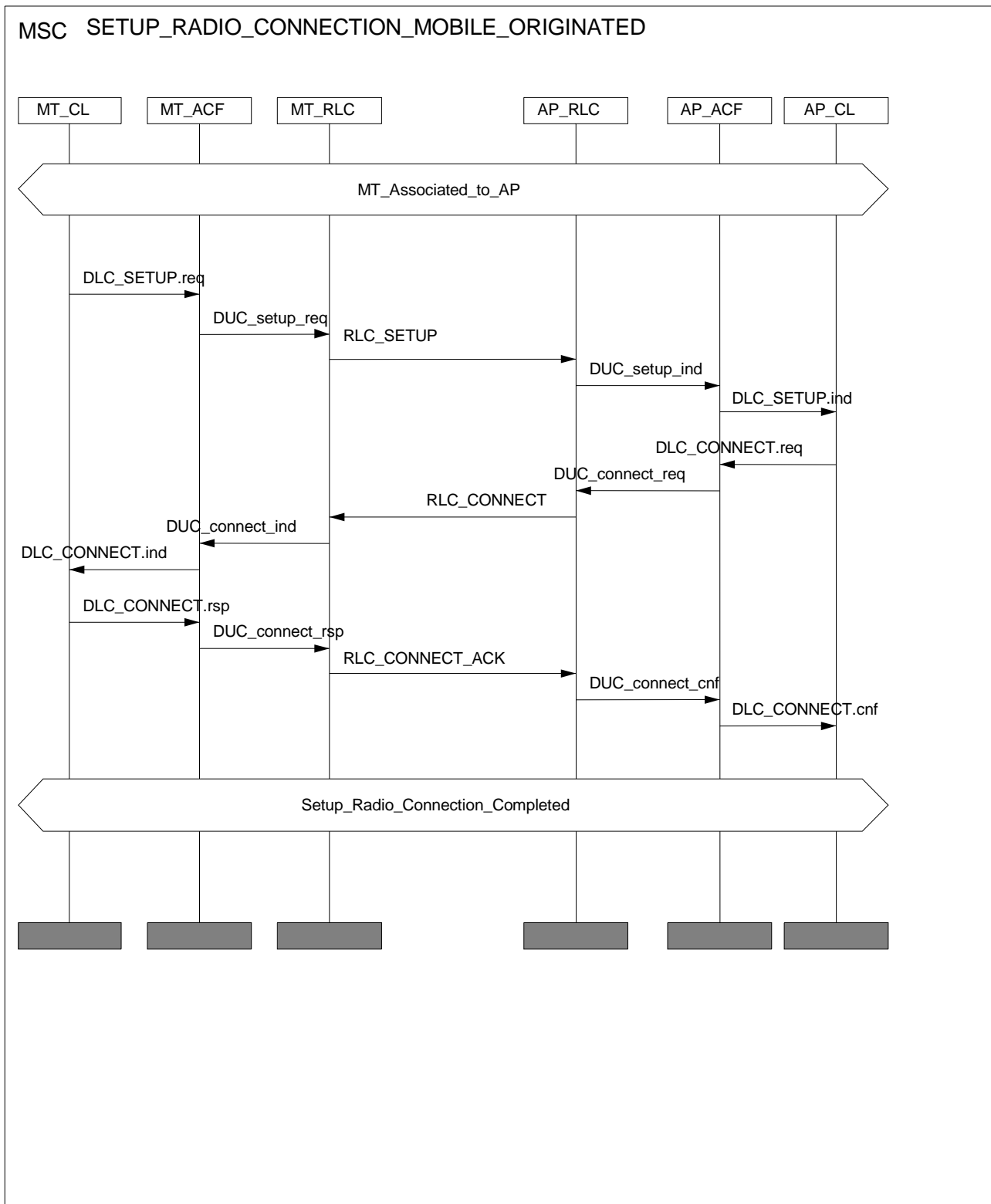

Figure B.4: MT originated DUC setup procedure

Annex C (informative): Example of the MAC_ID table

The MAC_ID table consists of mappings between Ethernet unicast, multicast and broadcast addresses to HIPERLAN/2 MAC_IDs. In case of unicast and broadcast only one MAC_ID is used per Ethernet address. Ethernet multicast is mapped to HIPERLAN/2 unicast MAC_IDs and/or to HIPERLAN/2 multicast MAC_IDs (see table C.1).

Table C.1: Example of the <MAC ID table> in the AP

IEEE 802 MAC Address (48 bits)	MAC IDs
Broadcast address:	
(0x) FF:FF:FF:FF:FF:FF	223
Multicast addresses:	
(0x) 01:00:5E:00:00:00	1, 2, 6
(0x) 01:00:5E:01:02:10	225
(0x) 01:00:5E:12:B1:00	3, 2
(0x) 01:00:32:21:A1:01	4, 6
MT addresses:	
(0x) 00:10:5A:2D:4D:83	1
(0x) 00:12:5A:3D:4D:82	2
(0x) 00:11:4A:2C:33:43	3
(0x) 00:10:4E:2E:22:12	4
(0x) 00:11:2E:A1:11:A2	5
(0x) 00:12:3E:11:2A:1A	6

Annex D (informative): Bibliography

AA-K759B-TK Ethernet V2.0 (1982): "The Ethernet, Digital Equipment, Intel, and Xerox Corps".

History

Document history		
V1.1.1	April 2000	Publication
V1.2.1	December 2001	Publication