



EUROPEAN
TELECOMMUNICATION
STANDARD

ETS 300 632

March 1997

Source: ETSI TC-TM

Reference: DE/TM-04025

ICS: 33.020

Key words: Analogue, radio, relay, transmission, video

**Transmission and Multiplexing (TM);
Fixed radio link equipment for the transmission of
analogue video signals operating in the
frequency range 24,25 GHz to 29,50 GHz**

ETSI

European Telecommunications Standards Institute

ETSI Secretariat

Postal address: F-06921 Sophia Antipolis CEDEX - FRANCE

Office address: 650 Route des Lucioles - Sophia Antipolis - Valbonne - FRANCE

X.400: c=fr, a=atlas, p=etsi, s=secretariat - **Internet:** secretariat@etsi.fr

Tel.: +33 4 92 94 42 00 - Fax: +33 4 93 65 47 16

Copyright Notification: No part may be reproduced except as authorized by written permission. The copyright and the foregoing restriction extend to reproduction in all media.

© European Telecommunications Standards Institute 1997. All rights reserved.

Contents

Foreword	5
1 Scope	7
2 Normative references	7
3 Abbreviations and symbols	8
3.1 Abbreviations	8
3.2 Symbols	8
4 General characteristics	8
4.1 Frequency bands and channel arrangements	8
4.1.1 Channel plan	8
4.1.2 Co-polar channel spacing.....	8
4.2 Compatibility requirements between systems.....	8
4.3 Environmental conditions.....	8
4.3.1 Equipment within weather protected locations	9
4.3.2 Equipment for non-weather protected locations.....	9
4.4 Electromagnetic compatibility	9
4.5 System block diagram	9
4.6 Branching/feeder/antenna requirements	9
4.6.1 Antenna radiation patterns	9
4.6.2 Waveguide flanges.....	9
4.6.3 Cross-Polar Discrimination (XPD).....	10
4.7 Power supply.....	10
5 Baseband characteristics	12
5.1 Transmit/receive capacity	12
5.2 Baseband parameters	12
5.2.1 Video interfaces.....	12
5.2.2 Audio interface	12
5.2.3 IF interface	12
6 Transmitter characteristics	13
6.1 Transmitter power range.....	13
6.2 Transmitter output power tolerance	13
6.3 Radiated spectrum.....	13
6.3.1 Frequency deviation	13
6.3.2 Spectrum masks	13
6.4 Spurious emissions.....	15
6.5 Radio frequency tolerance	15
7 Receiver characteristics	15
7.1 Input level range	15
7.2 Spurious emissions.....	16
7.3 Noise figure.....	16
7.4 Receiver sensitivity	16
8 System performance	16
8.1 Performance characteristics	16
8.2 Interference sensitivity	16
History.....	18

Blank page

Foreword

This European Telecommunication Standard (ETS) has been prepared by the Transmission and Multiplexing (TM) Technical Committee of the European Telecommunications Standards Institute (ETSI).

This ETS specifies the minimum performance parameters for analogue radio relay equipment operating in the frequency range 24,25 GHz to 29,50 GHz. The minimum performance parameters for digital radio relay equipment operating in the frequency range 24,25 GHz to 29,50 GHz are given in ETS 300 431 [10].

Transposition dates	
Date of adoption:	21 February 1997
Date of latest announcement of this ETS (doa):	30 June 1997
Date of latest publication of new National Standard or endorsement of this ETS (dop/e):	31 December 1997
Date of withdrawal of any conflicting National Standard (dow):	31 December 1997

Blank page

1 Scope

This ETS covers the minimum technical requirements for terrestrial analogue radio relay systems operating in bands in the frequency range 24,25 GHz to 29,50 GHz.

Such systems are intended to be used for Point-to-Point (P-P) connections and video distribution (Point-to-Multipoint (P-MP)).

Typical applications include:

- a) TV of contribution quality;
- b) TV of distribution quality;
- c) TV of surveillance quality;
- d) Radar remoting.

Safety aspects are outside the mandate of ETSI and they will not be considered in this ETS.

The requirements and limits given in this ETS are relevant to all environmental conditions for the chosen climatic class.

2 Normative references

This ETS incorporates by dated or undated reference, provisions from other publications. These normative references are cited at the appropriate place in the text and the publications are listed hereafter. For dated references, subsequent amendments to, or revisions of, any of these publications apply to this ETS only when incorporated in it by amendment or revision. For undated references, the latest edition of the publication referred to applies.

- [1] CEPT Recommendation T/R 13-02: "Preferred channel arrangements for fixed services in the range 22,0 - 29,5 GHz".
- [2] ITU-R Recommendation F 748-1: "Radio-frequency channel arrangements for radio-relay systems operating in the 25, 26 and 28 GHz bands".
- [3] ETS 300 019: "Electrical Equipment (EE); Environmental conditions and environmental tests for telecommunications equipment".
- [4] prETS 300 339: "Radio Equipment and Systems (RES); General Electro-Magnetic Compatibility (EMC) for radio equipment".
- [5] IEC 154: "Flanges for Waveguides".
- [6] ETS 300 132: "Equipment Engineering (EE); Power supply interface at the input to telecommunications equipment".
- [7] ITU-T Recommendation J.61 (1990): "Transmission performance of television circuits designed for use in international connections".
- [8] ITU-T Recommendation J.21 (1994): "Performance characteristics of 15 kHz-type sound-programme circuits – Circuits for high quality monophonic and stereophonic transmissions".
- [9] CCIR Recommendation F.403-3 (1990): "Intermediate frequency characteristics for the interconnection of analogue radio-relay systems".
- [10] ETS 300 431: "Transmission and Multiplexing (TM); Digital fixed point-to-point radio link equipment operating in the frequency range 24,25 GHz to 29,50 GHz".

3 Abbreviations and symbols

3.1 Abbreviations

For the purposes of this ETS, the following abbreviations apply:

C/N	Carrier to Noise ratio
CW	Continuous Wave
FM	Frequency Modulation
IF	Intermediate Frequency
PAL	Phase Alternation Line
P-MP	Point-to-Multipoint
P-P	Point-to-Point
RF	Radio Frequency
RSL	Receive Signal Level
S/N	Signal to Noise ratio
XPD	Cross-Polar Discrimination

3.2 Symbols

For the purposes of this ETS, the following symbols apply:

dB	decibel
dBc	decibel relative to mean carrier power
dB _i	decibel relative to an isotropic radiator
dBm	decibel relative to 1 mW
dBW	decibel relative to 1 W
GHz	gigahertz
km	kilometre
Mbit/s	Mega-bits per second
MHz	megahertz
ppm	parts per million
ns	nanosecond
mW	milliwatt
W	Watt

4 General characteristics

4.1 Frequency bands and channel arrangements

4.1.1 Channel plan

The frequency range is 24,25 GHz to 29,50 GHz. The channel arrangements shall align with those given in CEPT Recommendation T/R 13-02 [1] which is in accordance with ITU-R Recommendation F.748-1 [2].

4.1.2 Co-polar channel spacing

Table 1

Video baseband	up to 10 MHz (standard frequency deviation)	up to 10 MHz (wide frequency deviation)
Channel spacing	35 MHz	42 MHz

4.2 Compatibility requirements between systems

Equipment conforming with this ETS is not guaranteed to operate together across the radio interface (mid-air compatibility) with similar equipment provided by another manufacturer.

4.3 Environmental conditions

The equipment shall meet the environmental conditions set out in ETS 300 019 [3] which defines weather protected and non-weather protected locations, classes and test severities.

4.3.1 Equipment within weather protected locations

Equipment intended for operation within temperature controlled locations or partially temperature controlled locations shall meet the requirements of ETS 300 019 [3] classes 3.1 and 3.2 respectively.

Optionally, the more stringent requirements of ETS 300 019 [3] classes 3.3 (non-temperature controlled locations), 3.4 (sites with heat trap) and 3.5 (sheltered locations) may be applied.

4.3.2 Equipment for non-weather protected locations

Equipment intended for operation within non-weather protected locations shall meet the requirements of ETS 300 019 [3], class 4.1 or 4.1E.

Class 4.1 applies to many European countries and class 4.1E applies to all European countries.

Weather protected equipment conforming to classes 3.3, 3.4 and 3.5, together with an enclosure or cabinet may fulfil the requirements for operating in a non-weather protected environment, but this is outside the scope of this ETS.

4.4 Electromagnetic compatibility

Equipment shall operate under the conditions specified in ETS 300 339 [4] for fixed radio links and ancillary equipment.

4.5 System block diagram

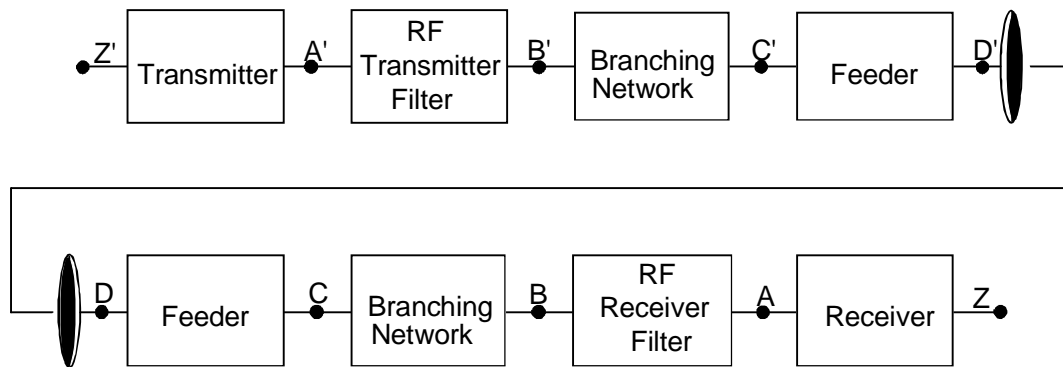

NOTE 1: The points listed above are reference points only.

NOTE 2: Points B and C, B' and C' may coincide.

Figure 1: System block diagram

4.6 Branching/feeder/antenna requirements

4.6.1 Antenna radiation patterns

The antenna radiation pattern shall be within one of the envelopes given in figures 2a, 2b, 2c and 2d. Type B antennas are intended for applications where high nodal capacity is required, and type C antennas are intended for distribution (P-MP) applications.

4.6.2 Waveguide flanges

Where integral antennas are not used, one of the following flange types, define in IEC 154 [5] shall be used:

- UBR/PBR/CBR 260, for the complete frequency range 24,25 GHz to 29,5 GHz;
- UBR/PBR/CBR 220, may be used for the lower part of the band, from 24,25 GHz to 26,5 GHz;
- UBR/PBR/CBR 320, may be used for the higher part of the band, from 26,5 GHz to 29,5 GHz.

4.6.3 Cross-Polar Discrimination (XPD)

The antenna XPD value within the 1 dB beamwidth shall not be less than 24 dB.

4.7 Power supply

The power supply interface shall be in accordance with ETS 300 132 [6].

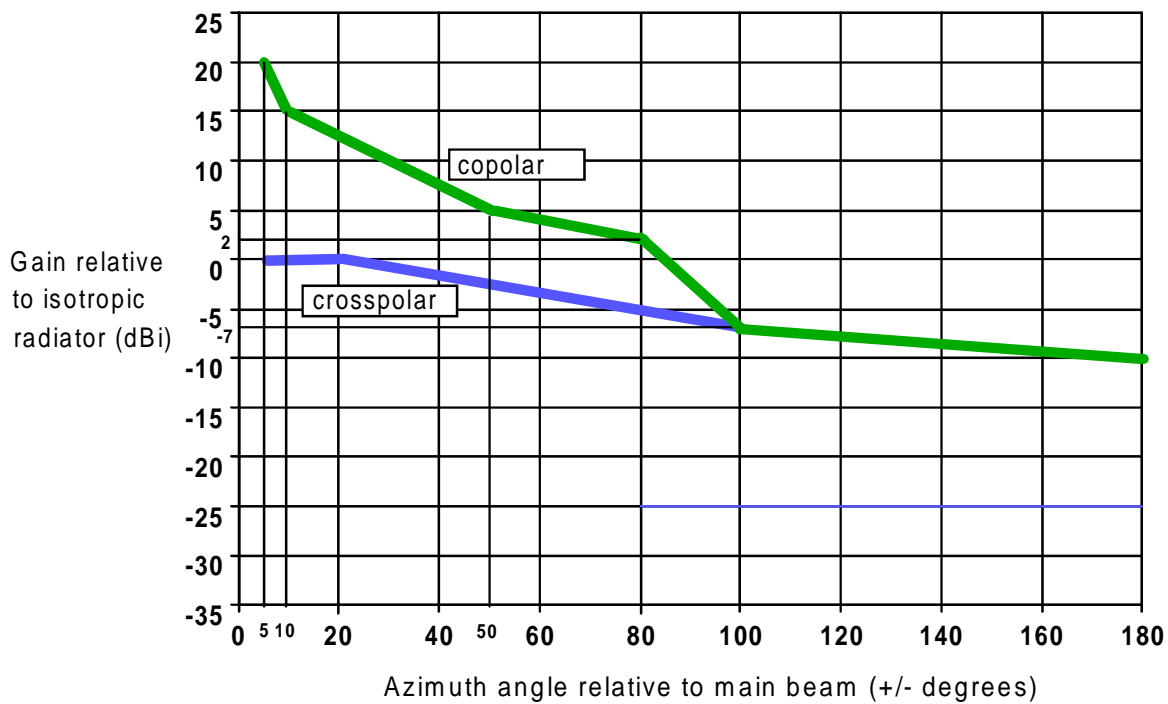

Figure 2a: Standard performance (Type A) antenna radiation pattern (under test conditions)

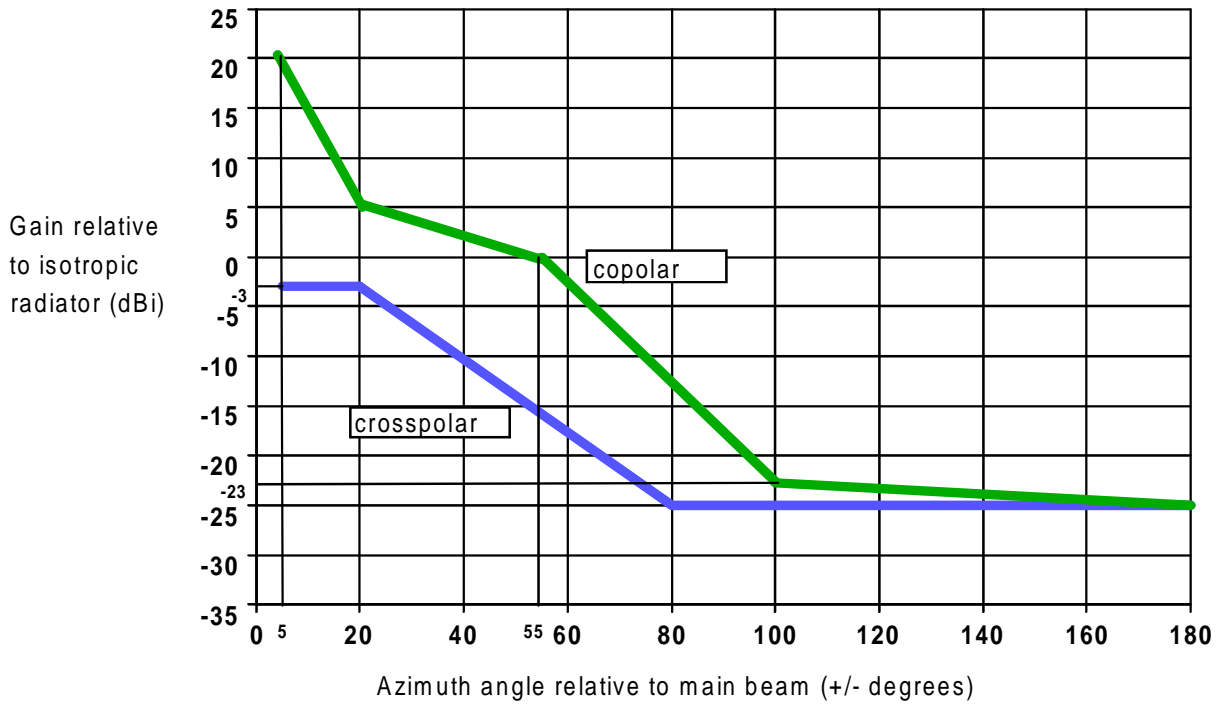

Figure 2b: High performance (Type B) antenna radiation pattern (under test conditions)

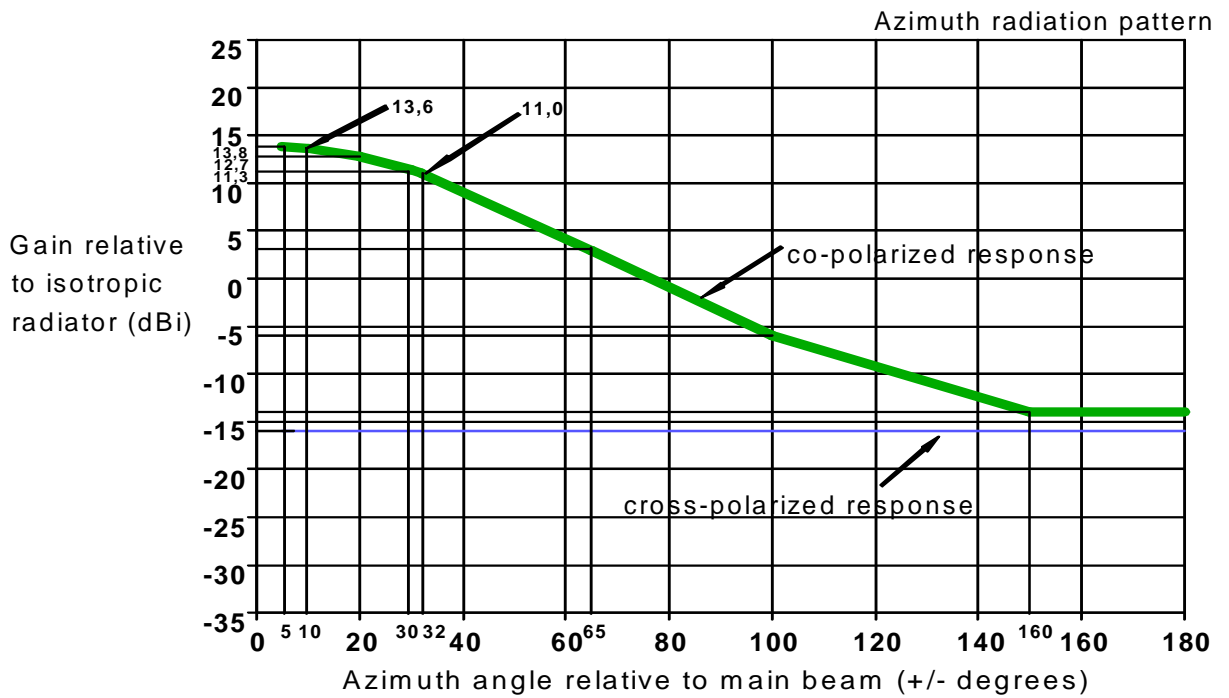

Figure 2c: Sector coverage (Type C) antenna radiation pattern for TV distribution (under test conditions)

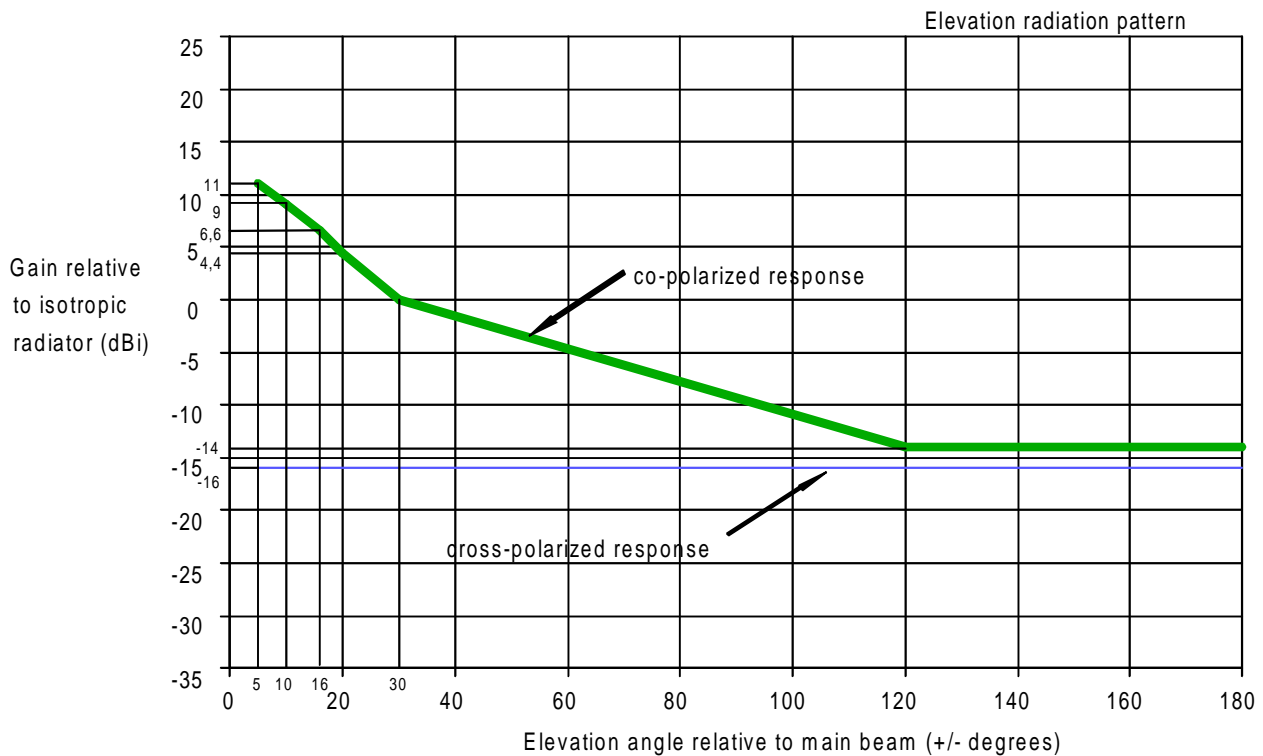

Figure 2d: Sector coverage (Type C) antenna radiation pattern for TV distribution (under test conditions)

5 Baseband characteristics

5.1 Transmit/receive capacity

A video baseband bandwidth of up to 10 MHz may be used. This may have subcarriers associated with it.

It is recognized that subcarriers will be used to carry four distinct traffic types:

- Continuous Wave (CW) (e.g. continuity pilot);
- low frequency analogue (e.g. audio);
- wideband analogue (e.g. secondary video);
- digital signals.

5.2 Baseband parameters

5.2.1 Video interfaces

The video interface shall be in accordance with ITU-T Recommendation J.61 [7].

5.2.2 Audio interface

If an audio interface is implemented, then it shall be in accordance with ITU-T Recommendation J.21 [8].

5.2.3 IF interface

If an IF interface is implemented, then it shall be in accordance with CCIR Recommendation F.403-3 [9].

6 Transmitter characteristics

6.1 Transmitter power range

Transmitter output power at point C' of the system block diagram (figure 1) shall be in the range +5 dBm to +27 dBm.

Regulatory administrations may define sub-ranges within the above range.

NOTE: At WARC 92, an amendment was made to the Radio Regulations for this band, adding footnote 2504A which states: "As far as practical, sites for transmitting stations in fixed or mobile services, employing maximum values of equivalent isotropic radiated power (e.i.r.p.) density exceeding 24 dBW in any 1 MHz band in the frequency range 25,25 GHz to 27,50 GHz should be selected so that the direction of maximum radiation of any antenna will be at least 1,5° from the geostationary-satellite orbit, taking into account the effect of atmospheric refraction. The provisions of No. 2504A shall apply until such time as the CCIR has made a recommendation on the e.i.r.p. density limits which should apply in the band".

6.2 Transmitter output power tolerance

The tolerance of the output power shall be within:

- nominal output power ± 3 dB for systems operating within non-weather protected locations;
- nominal output power ± 2 dB for systems operating within weather protected locations.

6.3 Radiated spectrum

6.3.1 Frequency deviation

With the limited system gain available in this band, predominantly due to economic limits on the transmit power available, relatively narrow frequency deviations (e.g. 8 MHz peak to peak) will have rather low ranges. Wide deviation systems (e.g. 16 MHz peak to peak for Phase Alternation Line (PAL) video signals) can provide lower receiver threshold levels and thus result in longer ranges being obtained. Therefore this ETS includes two spectral masks, one for standard frequency deviation systems, and the other for wide frequency deviation systems.

The frequency deviation of the primary traffic and sub-carriers shall be limited to a level that will ensure that the spectrum masks are not exceeded when the carrier is modulated with the relevant standard test signals. For television this shall be 100 % colour bars.

NOTE: The mask also contains the maximum allowable centre frequency tolerance and this should be taken into consideration when setting up the deviation.

6.3.2 Spectrum masks

The radiated spectrum of the composite wideband signal shall fall within the spectrum masks given in figure 3a (for standard frequency deviation) or figure 3b (for wide frequency deviation). The masks take into account an allowance for short term frequency tolerance.

NOTE: Spectrum analyser settings for RF power spectrum measurements should be as shown in table 2.

Table 2: Spectrum analyser settings

RF centre frequency	Transmitter carrier frequency
IF bandwidth	30 kHz
Total sweep width	210 MHz
Amplitude scale	Logarithmic, 10 dB/division
Video filter	300 Hz
Total scan time	Auto

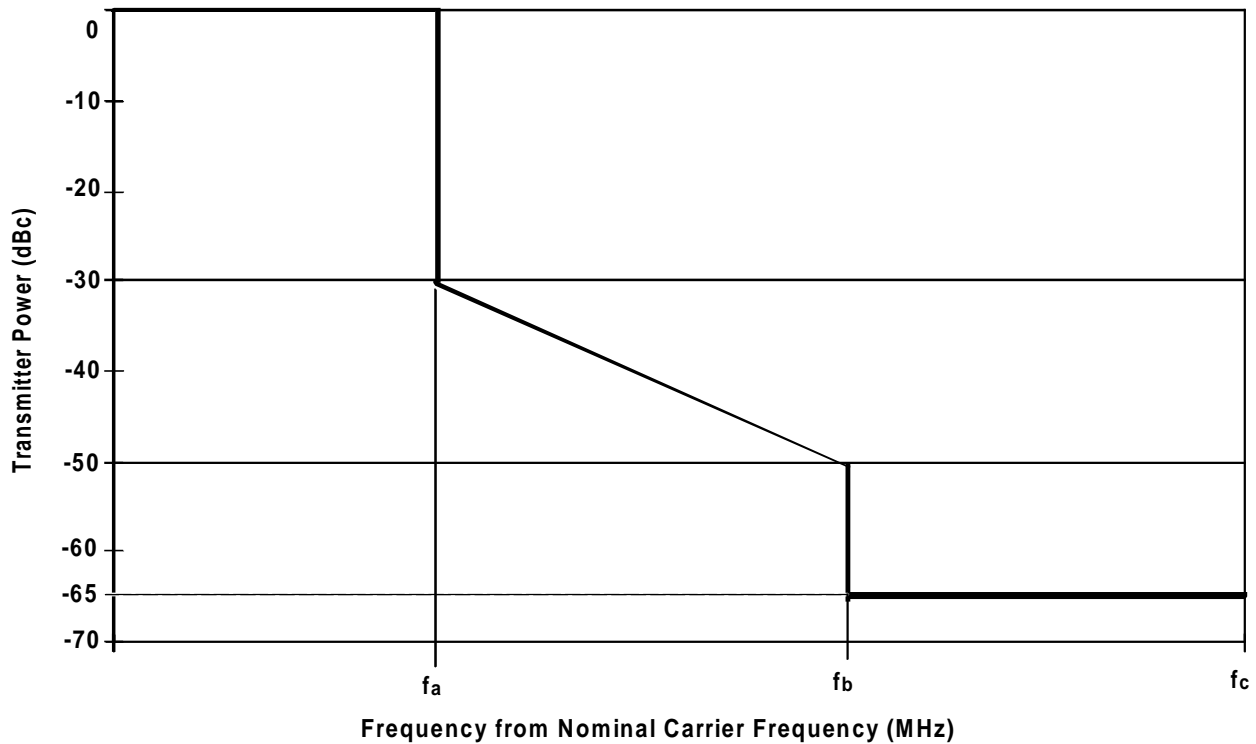

Baseband	f_a	f_b	f_c	Channel spacing
Up to 10 MHz	10,5 MHz	21 MHz	87,5 MHz	35 MHz

Figure 3a: Limits of spectral power density for video, standard frequency deviation

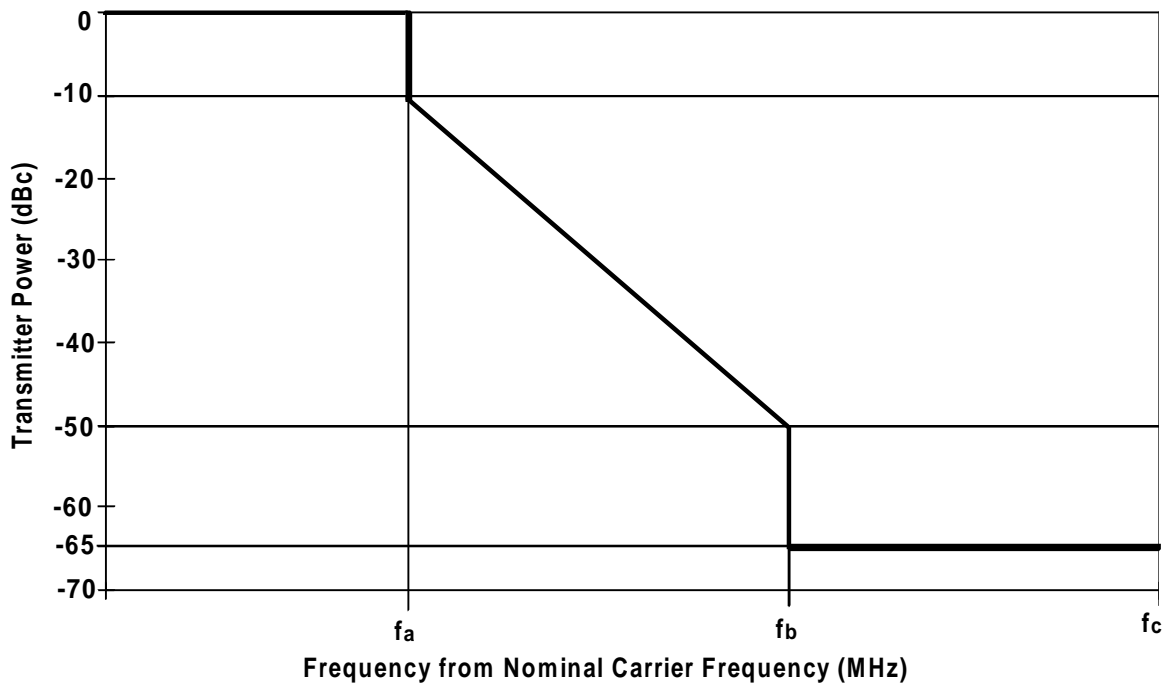

Baseband	f_a	f_b	f_c	Channel spacing
10 MHz	15 MHz	28 MHz	105 MHz	42 MHz

Figure 3b: Limits of spectral power density for video, wide frequency deviation

6.4 Spurious emissions

For the purposes of this ETS, the spurious emissions are defined as emissions at frequencies which are outside the nominal carrier frequency $\pm 2,5$ times the relevant channel spacing.

The frequency range in which the spurious emissions specifications apply is 30 MHz to 60 GHz. The values referenced to point C' shall be:

- 30 MHz to 21,2 GHz: ≤ -60 dBm;
- 21,2 GHz to 60 GHz: ≤ -30 dBm.

These are provisional limits subject to consultation with CEPT and other relevant parties.

For the purpose of this ETS the measurement bandwidth shall be in the range 100 kHz to 120 kHz.

6.5 Radio frequency tolerance

Radio frequency tolerances are included in the spectrum masks. Short term radio frequency tolerance shall be less than 20 ppm.

7 Receiver characteristics

All levels are referenced to point C on the block diagram.

7.1 Input level range

The input level range shall extend from the upper limit of -20 dBm to the limit specified in subclause 7.4.

7.2 Spurious emissions

The frequency range in which the spurious emissions specifications apply is 30 MHz to 60 GHz. The limits referenced to point C shall be:

- 30 MHz to 21,2 GHz: ≤ -60 dBm;
- 21,2 GHz to 60 GHz: ≤ -30 dBm.

These are provisional limits subject to consultation with CEPT and other relevant parties.

For the purpose of this ETS the measurement bandwidth shall be in the range 100 kHz to 120 kHz.

7.3 Noise figure

The receiver noise figure shall not exceed 11 dB.

7.4 Receiver sensitivity

The receiver sensitivity is defined as the receive signal level referred to point C of the system block diagram (see figure 1) at which a certain minimum performance is reached. The receiver sensitivity which corresponds to ITU-R picture quality grade 5 shall not be worse than -56 dBm for standard frequency deviation equipment and -70 dBm for wide frequency deviation equipment.

8 System performance

8.1 Performance characteristics

In view of the varied and numerous potential applications for analogue links it is not practicable to specify the overall performance characteristics for individual applications.

The receiver sensitivities given in subclause 7.4 for ITU-R picture quality grade 5 are based on the Carrier to Noise (C/N) ratios given in table 4. Other picture grades for a typical wide deviation system can be obtained at lower thresholds, as shown in table 3.

Table 3: Typical minimum C/N requirements for different picture qualities

Picture quality	Minimum video Signal to Noise (S/N) ratio (dB)	Minimum Carrier to Noise (C/N) ratio (dB)
Grade 5	48	18
Grade 4	42	12
Grade 3	38	8

8.2 Interference sensitivity

a) Co-channel interference:

The IF C/N ratio shall be measured for a receiver operating with a wanted signal, the level of which at the receiver input port shall be the reference sensitivity input level given in subclause 7.4. The value of that C/N ratio shall not be less than the value given in table 4.

Table 4: Specified C/N ratios

Video bandwidth (MHz)	C/N ratio (dB)
Up to 10 MHz, standard frequency deviation	32
Up to 10 MHz, wide frequency deviation	18

An interfering test signal shall then be added, the frequency of which shall also be at the nominal frequency of the wanted signal and at a level of -97 dBm. The IF C/N ratio of the wanted signal shall again be measured. The IF C/N shall not be less than the C/N ratio given in table 5 minus 1 dB.

b) Adjacent channel interference:

For a receiver operating with a wanted signal of nominal level, the introduction at point C of a like modulated interferer at the level and frequency separation given in table 5 shall not result in a degradation of the output signal/noise ratio of more than 1 dB.

Table 5: Adjacent channel separation and interference levels

Separation of wanted and interfering signal (MHz)	Interference level (carrier/interference) (dB)
35	0
42	0

c) CW spurious interference:

For a receiver operating with a wanted signal at the level of sensitivity given in subclause 7.4, the introduction at point C of a CW interferer at a level of +30 dB with respect to the wanted signal and at any frequency up to 60 GHz, excluding frequencies either side of the wanted signal by up to twice the relevant co-polar spacing, shall not result in a degradation of any output S/N of more than 1 dB.

History

Document history			
July 1995	Public Enquiry	PE 88:	1995-07-27 to 1995-11-17
December 1996	Vote	V 117:	1996-12-23 to 1997-02-14
March 1997	First Edition		