

ETSI EN 302 217-2-1 V1.3.1 (2010-01)

European Standard (Telecommunications series)

**Fixed Radio Systems;
Characteristics and requirements for
point-to-point equipment and antennas;
Part 2-1: System-dependent requirements
for digital systems operating in frequency bands
where frequency co-ordination is applied**



Reference

REN/ATTM-04010

Keywords

DFRS, digital, DRRS, FWA, point-to-point, radio,
regulation, transmission

ETSI

650 Route des Lucioles
F-06921 Sophia Antipolis Cedex - FRANCE

Tel.: +33 4 92 94 42 00 Fax: +33 4 93 65 47 16

Siret N° 348 623 562 00017 - NAF 742 C
Association à but non lucratif enregistrée à la
Sous-Préfecture de Grasse (06) N° 7803/88

Important notice

Individual copies of the present document can be downloaded from:

<http://www.etsi.org>

The present document may be made available in more than one electronic version or in print. In any case of existing or perceived difference in contents between such versions, the reference version is the Portable Document Format (PDF). In case of dispute, the reference shall be the printing on ETSI printers of the PDF version kept on a specific network drive within ETSI Secretariat.

Users of the present document should be aware that the document may be subject to revision or change of status. Information on the current status of this and other ETSI documents is available at

<http://portal.etsi.org/tb/status/status.asp>

If you find errors in the present document, please send your comment to one of the following services:

http://portal.etsi.org/chaicor/ETSI_support.asp

Copyright Notification

No part may be reproduced except as authorized by written permission.
The copyright and the foregoing restriction extend to reproduction in all media.

© European Telecommunications Standards Institute 2010.
All rights reserved.

DECT™, **PLUGTESTS™**, **UMTS™**, **TIPHON™**, the TIPHON logo and the ETSI logo are Trade Marks of ETSI registered for the benefit of its Members.

3GPP™ is a Trade Mark of ETSI registered for the benefit of its Members and of the 3GPP Organizational Partners.

LTE™ is a Trade Mark of ETSI currently being registered

for the benefit of its Members and of the 3GPP Organizational Partners.

GSM® and the GSM logo are Trade Marks registered and owned by the GSM Association.

Contents

Intellectual Property Rights	6
Foreword.....	6
Introduction	6
1 Scope	7
2 References	7
2.1 Normative references	8
2.2 Informative references.....	9
3 Definitions, symbols and abbreviations	10
3.1 Definitions	10
3.2 Symbols.....	10
3.3 Abbreviations	10
4 General characteristics	10
4.1 Frequency bands and channel arrangements	10
4.2 Special compatibility requirements between systems	11
4.3 Transmission capacity and spectral efficiency	11
5 Main requirements.....	12
5.0 Environmental profile.....	12
5.1 Transmitter characteristics.....	12
5.1.1 Transmitter power.....	12
5.1.2 Transmitter power and frequency control.....	13
5.1.2.1 Transmitter power control (ATPC and RTPC)	13
5.1.2.1.1 Automatic Transmitter Power Control (ATPC).....	13
5.1.2.1.2 Remote Transmitter Power Control (RTPC)	13
5.1.2.2 Remote Frequency Control (RFC).....	13
5.1.3 Transmitter output power tolerance	13
5.1.4 Radio Frequency (RF) spectrum mask.....	14
5.1.5 Discrete CW components exceeding the spectrum mask limit	14
5.1.5.1 Discrete CW components at the symbol rate	14
5.1.5.2 Other discrete CW components exceeding the spectrum mask limit	15
5.1.6 Spurious emissions - external	15
5.1.7 Radio frequency tolerance	15
5.2 Receiver characteristics	15
5.2.1 Spurious emissions-external	15
5.3 System performance without diversity	15
5.3.1 BER as a function of receiver signal level.....	15
5.3.2 Interference sensitivity.....	16
5.3.2.1 Co-channel "external" interference sensitivity	16
5.3.2.2 Adjacent channel interference sensitivity.....	16
5.3.2.3 CW spurious interference.....	16
6 Complementary requirements	16
6.1 Branching/feeder requirements	16
6.1.1 Waveguide flanges (or other connectors)	16
6.1.2 Return loss at equipment antenna port (C/C' reference point)	17
6.2 Intermodulation products	18
6.3 Transmitter characteristics.....	18
6.3.1 Spurious emissions - internal	18
6.4 Receiver characteristics	18
6.4.1 Input level range	18
6.4.2 Spurious emissions - internal	19
6.4.3 Image rejection	20
6.4.4 Innermost channel selectivity	20
6.5 System performance without diversity	20

6.5.1	Equipment Residual BER (RBER)	20
6.5.2	Interference sensitivity for CCDP with XPIC operation.....	22
6.5.2.1	Co-channel "internal" interference sensitivity in flat fading conditions.....	22
6.5.2.2	Co-channel "internal" interference sensitivity under dispersive fading conditions.....	22
6.5.3	Distortion sensitivity	22
6.6	System characteristics with diversity	23
6.6.1	Differential delay compensation	23
6.6.2	BER performance	23
Annex A (normative): Frequency bands from 1,4 GHz to 2,7 GHz		24
A.0	Introduction	24
Annex B (normative): Frequency bands from 3 GHz to 11 GHz (channel separation up to 30 MHz and 56 / 60 MHz)		25
B.0	Introduction	25
B.1	System B.1 (2 - 2 × 34 Mbit/s; STM-0 - 2 × STM-0 / 3 GHz to 11 GHz / 1,75 MHz to 29,65 MHz)	26
B.1.1	Distortion sensitivity	26
B.2	System B.2 (STM-1 / 3 GHz to 10,5 GHz / about 30 MHz ACAP)	26
B.2.1	Radio Frequency (RF) spectrum mask	26
B.2.2	Receiver innermost channel selectivity	29
B.3	System B.3 (2 × STM-1 / 3 GHz to 11 GHz / about 30 MHz CCDP)	29
B.3.1	Radio Frequency (RF) spectrum mask	29
B.3.2	Innermost channel selectivity	31
B.3.3	Distortion sensitivity - dynamic behaviour	33
B.4	System B.4 (4 × STM-0 / 5 × 34 / 3 GHz to 10,5 GHz / about 30 MHz ACAP).....	33
B.5	System B.5 (8 × STM-0 / 10 × 34 / 3 GHz to 10,5 GHz / about 60 MHz ACAP).....	33
B.6	System B.6 (2 × STM1 (ACCP) or STM-4 / 4× STM1 (CCDP) / 3 GHz to 10,5 GHz / about 60 MHz)	33
Annex C (normative): Frequency bands from 3 GHz to 11 GHz (channel separation 40 MHz)		34
C.0	Introduction	34
C.1	System C.1 (2 × STM-1 / 3 GHz to 11 GHz / 40 MHz - CCDP).....	34
C.1.1	Radio Frequency (RF) spectrum mask	35
C.1.2	Distortion sensitivity	36
C.2	System C.2 (2 × STM-1 / 3 GHz to 11 GHz / 40 MHz - ACAP).....	36
C.2.1	Radio Frequency (RF) spectrum mask	36
C.2.2	Receiver input level range	37
C.3	System C.3 (4 × STM-1 / 3 GHz to 11 GHz / 40 MHz - CCDP).....	37
C.3.1	Transmitter Radio Frequency (RF) spectrum mask.....	37
C.3.2	Receiver input level range	38
C.3.3	Distortion sensitivity	38
Annex D (normative): Frequency bands 13 GHz, 15 GHz and 18 GHz.....		39
D.0	Introduction	39
D.1	System D.1 (2 / 2 × 34 Mbit/s / 13 GHz, 15 GHz and 18 GHz / 1,75 MHz / 28 MHz).....	40
D.1.1	Distortion sensitivity	40
D.2	System D.2 (sub STM-0 / 18 GHz / 3,5 MHz).....	41
D.3	System D.3 (STM-0 / 13 GHz, 15 GHz and 18 GHz / 28 MHz ACCP-14 MHz ACAP).....	41
D.4	System D.4 (STM-0 or 2 × STM-0 / 13 GHz, 15 GHz and 18 GHz / 14 MHz or 28 MHz ACCP).....	41

D.4.1	Distortion sensitivity	41
D.5	System D.5 (STM-1 / 13 GHz, 15 GHz and 18 GHz / about 30 MHz ACAP).....	41
D.6	System D.6 (2 × STM-1 / 13 GHz, 15 GHz and 18 GHz / about 30 MHz CCDP).....	41
D.6.1	RF spectrum mask	41
D.7	System D.7 (STM-1 / 15 GHz and 18 GHz / 55/56 MHz).....	42
D.7.1	RF spectrum mask	42
D.8	System D.8 (2 × STM-1 (ACAP or ACCP) and STM-4 (CCDP) / 13 GHz, 15 GHz and 18 GHz / 55 MHz and 56 MHz)	43
D.9	System B.4 (4 × STM-0 / 5 × 34 / 13 GHz, 15 GHz and 18 GHz / 27,5 MHz and 28 MHz ACAP).....	43
D.10	System B.5 (8 × STM-0 / 10 × 34 / 13 GHz, 15 GHz and 18 GHz / 55 MHz and 56 MHz ACAP).....	43
Annex E (normative): Frequency bands from 23 GHz to 55 GHz		44
E.0	Introduction	44
E.1	Systems E.1, E.2 and E.3: Transmitter spectrum mask for class 5B equipment.....	45
Annex F (normative): Transmission of packet data and combinations of other signals in bands from 3 GHz to 55 GHz		46
F.1	Introduction	46
F.2	General characteristics	46
F.2.1	Frequency characteristics and channel arrangements.....	46
F.2.2	Transmission capacities and equipment assessment.....	46
Annex G (informative): Additional information.....		47
G.1	Residual Bit Error Ratio (RBER) and Frame Error Ratio (RFER)	47
G.2	Measurement test set for XPI characteristics	48
G.3	Differential delay compensation range.....	49
G.4	FER/BER equivalence and FER performance measurement equipment settings (example).....	49
G.4.1	FER/BER equivalence.....	49
G.4.2	FER equipment settings and measurement techniques (example).....	50
G.5	Automatic Transmitter Power Control (ATPC)	50
Annex H (informative): Mitigation techniques referred in ERC/DEC/(00)07 (18 GHz band).....		52
History		53

Intellectual Property Rights

IPRs essential or potentially essential to the present document may have been declared to ETSI. The information pertaining to these essential IPRs, if any, is publicly available for **ETSI members and non-members**, and can be found in ETSI SR 000 314: "*Intellectual Property Rights (IPRs); Essential, or potentially Essential, IPRs notified to ETSI in respect of ETSI standards*", which is available from the ETSI Secretariat. Latest updates are available on the ETSI Web server (<http://webapp.etsi.org/IPR/home.asp>).

Pursuant to the ETSI IPR Policy, no investigation, including IPR searches, has been carried out by ETSI. No guarantee can be given as to the existence of other IPRs not referenced in ETSI SR 000 314 (or the updates on the ETSI Web server) which are, or may be, or may become, essential to the present document.

Foreword

This European Standard (Telecommunications series) has been produced by ETSI Technical Committee Access, Terminals, Transmission and Multiplexing (ATTM).

The present document is part 2-1 of a multi-part deliverable covering the Fixed Radio Systems; Characteristics and requirements for point-to-point equipment and antennas. Full details of the entire series can be found in part 1 [15].

National transposition dates	
Date of adoption of this EN:	18 January 2010
Date of latest announcement of this EN (doa):	30 April 2010
Date of latest publication of new National Standard or endorsement of this EN (dop/e):	31 October 2010
Date of withdrawal of any conflicting National Standard (dow):	31 October 2010

Introduction

The introduction of EN 302 217-1 [15] applies.

1 Scope

The present document summarizes all system-dependent requirements for Point-to-Point (P-P) equipment in applications deployed in bands where frequency co-ordination is generally applied. These requirements are introduced in two different clauses sub-sets:

- **Main requirements** are requirements that are also related to the "essential requirements" under article 3.2 of the R&TTE Directive [1] and further detailed in EN 302 217-2-2 [16].
- **Complementary requirements** are requirements that are not related to essential requirements under article 3.2 of the R&TTE Directive [1]. Nevertheless they are considered having been commonly agreed for proper system operation and deployment when specific deployment conditions or compatibility requirements are present. Compliance to all or some of these requirements is made on a voluntary basis.

Description and limits for parameters relevant to essential requirements under article 3.2 of R&TTE Directive [1] are given in EN 302 217-2-2 [16].

For other system-dependent parameters where standardization is required but that do not affect the R&TTE Directive "essential requirements" mentioned above, description and limits are detailed in the present document in the annexes A to G, subdivided by frequency band or specific applications.

The present document deals with Radio Frequency (RF) and base-band equipment characteristics; antenna system requirements are covered in EN 302 217-4-1 [i.4] and EN 302 217-4-2 [i.5].

The present document does not cover test procedures and test conditions which are set out in EN 301 126-1 [14].

As the maximum transmission rate in a given bandwidth depends on system spectral efficiency, different equipment classes are defined in EN 302 217-2-2 [16].

The spectral efficiency classes are indicative only and do not imply any constraint to the actual modulation format, provided that all the requirements in the relevant parts of this EN 302 217 series are met.

In some cases, where within the same spectral efficiency class there are different applications, (e.g. for multi-channel trunk or single channel operation), that justify different radio frequency parameters, two different equipment "types" (e.g. type 1 and 2) are provided.

Guidance on the definition of radio parameters relevant to the essential requirements under article 3.2 of R&TTE Directive [1] for DFRS may be found in TR 101 506 [i.2].

Technical background for most of the parameters and requirements referred to in this EN 302 217 series may be found in TR 101 036-1 [i.1].

2 References

References are either specific (identified by date of publication and/or edition number or version number) or non-specific.

- For a specific reference, subsequent revisions do not apply.
- Non-specific reference may be made only to a complete document or a part thereof and only in the following cases:
 - if it is accepted that it will be possible to use all future changes of the referenced document for the purposes of the referring document;
 - for informative references.

Referenced documents which are not found to be publicly available in the expected location might be found at <http://docbox.etsi.org/Reference>.

NOTE: While any hyperlinks included in this clause were valid at the time of publication ETSI cannot guarantee their long term validity.

2.1 Normative references

The following referenced documents are indispensable for the application of the present document. For dated references, only the edition cited applies. For non-specific references, the latest edition of the referenced document (including any amendments) applies.

- [1] Directive 1999/5/EC of the European Parliament and of the Council of 9 March 1999 on radio equipment and telecommunications terminal equipment and the mutual recognition of their conformity (R&TTE Directive).
- [2] CENELEC EN 122150: "Sectional Specification: Radio frequency coaxial connectors - Series EIA flange".
- [3] CEPT/ERC/DEC/(00)07: "ERC Decision of 19 October 2000 on the shared use of the band 17.7 - 19.7 GHz by the fixed service and Earth stations of the fixed-satellite service (space-to-Earth)".
- [4] ETSI EN 300 019-1-0: "Environmental Engineering (EE); Environmental conditions and environmental tests for telecommunications equipment; Part 1-0: Classification of environmental conditions; Introduction".
- [5] ETSI EN 300 019-1-1: "Environmental Engineering (EE); Environmental conditions and environmental tests for telecommunications equipment; Part 1-1: Classification of environmental conditions; Storage".
- [6] ETSI EN 300 019-1-2: "Environmental Engineering (EE); Environmental conditions and environmental tests for telecommunications equipment; Part 1-2: Classification of environmental conditions; Transportation".
- [7] ETSI EN 300 019-1-3: "Environmental Engineering (EE); Environmental conditions and environmental tests for telecommunications equipment; Part 1-3: Classification of environmental conditions; Stationary use at weatherprotected locations".
- [8] ETSI EN 300 019-1-4: "Environmental Engineering (EE); Environmental conditions and environmental tests for telecommunications equipment; Part 1-4: Classification of environmental conditions; Stationary use at non-weatherprotected locations".
- [9] ETSI EN 300 019-2-0: "Environmental Engineering (EE); Environmental conditions and environmental tests for telecommunications equipment; Part 2-0: Specification of environmental tests; Introduction".
- [10] ETSI EN 300 019-2-1: "Environmental Engineering (EE); Environmental conditions and environmental tests for telecommunications equipment; Part 2-1: Specification of environmental tests; Storage".
- [11] ETSI EN 300 019-2-2: "Equipment Engineering (EE); Environmental conditions and environmental tests for telecommunications equipment; Part 2-2: Specification of environmental tests; Transportation".
- [12] ETSI EN 300 019-2-3: "Environmental Engineering (EE); Environmental conditions and environmental tests for telecommunications equipment; Part 2-3: Specification of environmental tests; Stationary use at weatherprotected locations".
- [13] ETSI EN 300 019-2-4: "Environmental Engineering (EE); Environmental conditions and environmental tests for telecommunications equipment; Part 2-4: Specification of environmental tests; Stationary use at non-weatherprotected locations".
- [14] ETSI EN 301 126-1: "Fixed Radio Systems; Conformance testing; Part 1: Point-to-Point equipment - Definitions, general requirements and test procedures".
- [15] ETSI EN 302 217-1: "Fixed Radio Systems; Characteristics and requirements for point-to-point equipment and antennas; Part 1: Overview and system-independent common characteristics".

- [16] ETSI EN 302 217-2-2: "Fixed Radio Systems; Characteristics and requirements for point-to-point equipment and antennas; Part 2-2: Digital systems operating in frequency bands where frequency co-ordination is applied; Harmonized EN covering the essential requirements of Article 3.2 of the R&TTE Directive".
- [17] IEC 60153-2: "Hollow metallic waveguides. Part 2: Relevant specifications for ordinary rectangular waveguides".
- [18] IEC 60154-2: "Flanges for waveguides. Part 2: Relevant specifications for flanges for ordinary rectangular waveguides".
- [19] IEC 60169-1: "Radio-frequency connectors. Part 1: General requirements and measuring methods".
- [20] IEC 60339 (all parts): "General purpose rigid coaxial transmission lines and their associated flange connectors".
- [21] IEC 60835-2-4: "Methods of measurement for equipment used in digital microwave radio transmission systems - Part 2: Measurements on terrestrial radio-relay systems - Section 4: Transmitter/receiver including modulator/demodulator".
- [22] IEC 60835-2-8: "Methods of measurement for equipment used in digital microwave radio transmission systems - Part 2: Measurements on terrestrial radio-relay systems - Section 8: Adaptive equalizer".
- [23] IEEE 802.3-2002: "IEEE Standard for Information technology - Telecommunications and information exchange between systems - Local and metropolitan area networks - Specific requirements - Part 3: Carrier Sense Multiple Access with Collision Detection (CSMA/CD) Access Method and Physical Layer Specifications".
- [24] IEEE 1802.3-2001: "IEEE Conformance Test Methodology for IEEE Standards for Local and Metropolitan Area Networks - Specific Requirements - Part 3: Carrier Sense Multiple Access with Collision Detection (CSMA/CD) Access Method and Physical Layer Specifications".
- [25] ITU Radio Regulations (2008).
- [26] ITU-T Recommendation G.708: "Sub STM-0 network node interface for the synchronous digital hierarchy (SDH)".
- [27] ITU-T Recommendation O.151: "Error performance measuring equipment operating at the primary rate and above".
- [28] ITU-T Recommendation O.181: "Equipment to assess error performance on STM-N interfaces".
- [29] ITU-T Recommendation O.191: "Equipment to measure the cell transfer performance of ATM connections".

2.2 Informative references

The following referenced documents are not essential to the use of the present document but they assist the user with regard to a particular subject area. For non-specific references, the latest version of the referenced document (including any amendments) applies.

- [i.1] ETSI TR 101 036-1: "Fixed Radio Systems; Generic wordings for standards on DFRS (Digital Fixed Radio Systems) characteristics; Part 1: General aspects and point-to-point equipment parameters".
- [i.2] ETSI TR 101 506: "Fixed Radio Systems; Generic definitions, terminology and applicability of essential requirements under the article 3.2 of 1999/05/EC Directive to Fixed Radio Systems".
- [i.3] ETSI TR 102 243-1: "Fixed Radio Systems; Representative values for transmitter power and antenna gain to support inter- and intra-compatibility and sharing analysis; Part 1: Digital point-to-point systems".

- [i.4] ETSI EN 302 217-4-1: "Fixed Radio Systems; Characteristics and requirements for point-to-point equipment and antennas; Part 4-1: System-dependent requirements for antennas".
- [i.5] ETSI EN 302 217-4-2: "Fixed Radio Systems; Characteristics and requirements for point-to-point equipment and antennas; Part 4-2: Antennas; Harmonized EN covering the essential requirements of article 3.2 of the R&TTE Directive".

3 Definitions, symbols and abbreviations

3.1 Definitions

For the purposes of the present document, the terms and definitions given in EN 302 217-1 [15] apply.

3.2 Symbols

For the purposes of the present document, the symbols given in EN 302 217-1 [15] apply.

3.3 Abbreviations

For the purposes of the present document, the abbreviations given in EN 302 217-1 [15] apply.

4 General characteristics

For commonality of purpose, systems are sub-divided into families by frequency range of operation; one normative annex is assigned to each family of equipment. There are six families of annexes, referenced from A to F, which may be found in both in the present document and EN 302 217-2-2 [16]:

- A Frequency bands from 1,4 GHz to 2,7 GHz.
- B Frequency bands from 3 GHz to 11 GHz (Channel separation up to 30 MHz and 56/60 MHz).
- C Frequency bands from 3 GHz to 11 GHz (Channel separation 40 MHz).
- D Frequency bands 13 GHz, 15 GHz and 18 GHz.
- E Frequency bands from 23 GHz to 55 GHz.
- F Transmission of packet data and combinations of other signals in bands from 3 GHz to 55 GHz.

4.1 Frequency bands and channel arrangements

Frequency bands and channel arrangements, which are relevant for equipment covered by the present document, are defined by ITU-R Recommendations and/or CEPT Recommendations and are referenced in the first table of each annex A through E (i.e. tables A.1 through E.1) of EN 302 217-2-2 [16].

ITU-R Recommendations or CEPT/ECC (see note) recommended frequency channel arrangements, known at the date of publication of this EN 302 217 series, are set out for reference only. In general, the channel arrangement is relevant neither to article 3.2 of the R&TTE Directive [1] nor for other requirements in the present document; only the frequency band, actual channel separation and, in some cases innermost channels separation are relevant for defining the set of parameters and test suites relevant to each system.

NOTE: CEPT Recommendations were published until 2002 as CEPT/ERC Recommendations; consequently to the restructuring of ERC under new ECC organization, new and revised Recommendations might formally change their reference as ECC Recommendations, without changing their technical content and applicability.

Other national or future ITU-R Recommendations or CEPT/ECC Recommendations, set around the same or close to the frequency range of present ITU-R Recommendations or CEPT/ECC Recommendations, are considered applicable to systems assessed against this EN 302 217 series, provided that they use the same channel separation.

Specification and tests of wide radio-frequency band covering units and multirate equipment are placed in normative annex G of EN 302 217-2-2 [16]. Whenever applicable, it is also valid for assessing parameters specified in the present document.

4.2 Special compatibility requirements between systems

There shall be no requirement to operate transmitting equipment from one supplier with receiving equipment from another and, depending on the deployment conditions, it shall be possible to operate the system in vertical and/or horizontal polarization, if required by the channel arrangement.

To be compatible with certain constraints given by existing installations and/or deployments already made with systems from other supplier or for different FS applications, new systems on the same path may be subject to additional requirements, other than those derived for a single supplier or same application environment.

NOTE: This does not imply that when a single supplier is involved there are no similar requirements; however, they do not need standardization because many other technical and cost-effective solutions might be flexibly adopted under suppliers' own responsibility only.

For the purposes of this EN 302 217 series the following set of compatibility requirements between systems has been defined:

- a) There may be a requirement to multiplex different suppliers' equipment on the same polarization of the same antenna. This will not apply to systems with an integral antenna.
- b) There may be a requirement to multiplex different suppliers' equipment on different polarizations of the same antenna. This will not apply to systems with an integral antenna.
- c) There may be a requirement to coexist with analogue systems on adjacent cross-polarized channels on the same route.

4.3 Transmission capacity and spectral efficiency

The payload bit rates considered in this EN 302 217 series are commonly tailored to typical PDH and SDH baseband interfaces: 2,048 Mbit/s, $2 \times 2,048$ Mbit/s, 8,448 Mbit/s, $2 \times 8,448$ Mbit/s, 34,368 Mbit/s, $2 \times 34,368$ Mbit/s, 51,840 Mbit/s (STM-0), $2 \times 51,840$ Mbit/s ($2 \times$ STM-0), 155,520 Mbit/s (STM-1), $N \times 155,520$ Mbit/s ($N \times$ STM-1), STM-N. Only systems in annex A, due to the smaller channel separation provided, are (exceptionally) labelled with typical capacity rate without specific reference to PDH/SDH rates. In the following text these capacities will be simply referred to as 2 Mbit/s, 2×2 Mbit/s, 8 Mbit/s, 2×8 Mbit/s, 34 Mbit/s, 2×34 Mbit/s, STM-0, $2 \times$ STM-0, STM-1, $N \times$ STM-1 and STM-N.

For each system the bit rates related to each class and their relevant channel separation are detailed in the second table of each annex A through E (i.e. tables A.2 through E.2) of EN 302 217-2-2 [16].

Provided that they meet all requirements of the relevant annex, equivalent or higher PDH or SDH transport rates may be used where appropriate. Such equivalence transport rates may be:

- $N \times 2$ Mbit/s or other mixture of PDH rates, even if multiplexed into proprietary frames, in place of higher order PDH rates;
- 140 Mbit/s (including the above $N \times 2$ Mbit/s or other mixture of PDH rates) in place of STM-1;
- any PDH mapping into STM-0 or STM-1 frames, as defined in the basic multiplexing schemes;
- $N \times 2$ Mbit/s mapped into SDH VC12 or VC2 transport bit rates (sub-STM-0 defined, as sSTM-1k or sSTM-2n capacities, by ITU-T Recommendation G.708 [26]) in place of a PDH rate (e.g. $4 \times$ VC12/sSTM14 or $1 \times$ VC2/sSTM21 in place of 8 Mbit/s) (note).

NOTE: In addition to this general principle, annex D (system D.2) presents specific characteristics for sub-STM-0 systems in the 18 GHz band.

- Any other signal (e.g. IP frames or ATM cells, even possibly mixed with PDH capacities) mapping into PDH or SDH frames, according present or future basic ITU-T or ETSI multiplexing schemes.

The present document is also applicable to other base band interfaces (e.g. packet data interfaces or mixed interfaces) even if multiplexed (including compression algorithms if any) into proprietary frames; for such cases annex F gives the basic rules for applying the conventional PDH/SDH set of parameters to those equipment assessment.

5 Main requirements

This clause summarizes requirements related to the "essential requirements" under article 3.2 of the R&TTE Directive [1] that are further detailed in EN 302 217-2-2 [16]. However, for some requirements, besides the relevant essential limits set out in EN 302 217-2-2 [16] for the purpose of their separate publishing in the Official Journal of the European Communities (OJEC) under the R&TTE Directive [1], additional, non-essential, more stringent limits are here set out in response to specific compatibility requirements by network operators when deploying new systems on the same routes with existing systems from other suppliers.

The specified transmitter and receiver characteristics shall be met with the appropriate baseband signals applied at reference point X' and received from reference point X of figure 1 of EN 302 217-1 [15].

Table 1: Baseband test signals

Type of baseband signal interface at X/X'	Test signal to be applied according to...
PDH	PRBS ITU-T Recommendation O.151 [27]
SDH	ITU-T Recommendation O.181 [28]
ATM	ITU-T Recommendation O.191 [29]
Ethernet interface (packet data)	IEEE 802.3 [23], IEEE 1802.3 [24]
Other than the above	Relevant standards which the interface refers to

5.0 Environmental profile

The required environmental profile for operation of the equipment shall be declared by the supplier. The equipment shall comply with all the technical requirements of the present document at all times when operating within the boundary limits of the required operational environmental profile.

Preferably, the selected environmental profiles should be one of more ETSI profiles in EN 300 019 series (see [4] through [13]), standardized for various operating, transport and storage situations.

5.1 Transmitter characteristics

5.1.1 Transmitter power

The only essential requirement is the Maximum Output Power which is an essential requirement under article 3.2 of R&TTE Directive [1] and is specified in EN 302 217-2-2 [16].

For guidance, in addition to the absolute maximum transmitter power, typical values of transmitter highest power for real equipment, of feeder loss and length, and of antenna diameter and gain are provided in TR 102 243-1 [i.3] in order to support inter- and intra- compatibility and sharing analysis.

In some frequency bands, or parts of frequency bands, ITU-R Recommendations define specific limits in terms of output power and/or EIRP (or output power and/or EIRP density) in order to improve the compatibility with other Radio Services sharing these frequency bands with the FS.

An additional capability for output power level adjustment may be required, for regulatory purposes, in the interface regulations according to article 4.1 of the R&TTE Directive [1], in which case the range of adjustment, either by fixed or automatic attenuators, should be in increments of 5 dB or less.

In particular, for the band 18 GHz, the FS shall, where practical, implement the appropriate mitigation techniques as required in ERC/DEC/(00)07 [3]. See annex H.

5.1.2 Transmitter power and frequency control

5.1.2.1 Transmitter power control (ATPC and RTPC)

5.1.2.1.1 Automatic Transmitter Power Control (ATPC)

This functionality is relevant to essential requirements under article 3.2 of R&TTE Directive [1] and is specified in EN 302 217-2-2 [16].

Besides those essential requirements specified in EN 302 217-2-2 [16], ATPC may be requested as mandatory functionality in the licensing conditions for the following purposes:

- to enhance network density (see note 1);
- as a mitigation factor for sharing with other Services due to CEPT Decisions (see notes 2 and 3).

Administrations should explicitly state whether ATPC is used as a regulatory measure for either frequency coordination or as a mitigation technique to protect other services in its radio regulation interface for notification according to article 4.1 of the R&TTE Directive [1].

NOTE 1: In this particular case, as an additional, but non-essential to article 3.2, requirement, it may be specified that transmitter output power meet the spectrum mask limits set out in clause 4.2 of EN 302 217-2-2 [16] throughout the ATPC range.

NOTE 2: The first example is in the 18 GHz band, where since there is sharing between FS and FSS, ATPC will become a mandatory feature for all new equipment to be deployed after the date referred by ERC/DEC/(00)07 [3], however, the actual usage of ATPC will be required only where practical and depending on local sharing conditions with satellite services and local deployment conditions in existing networks. The ATPC range is not subject to standardization.

NOTE 3: When used as mitigation factor ATPC should not be, in principle, used to enhance network density.

5.1.2.1.2 Remote Transmitter Power Control (RTPC)

This parameter is relevant to essential requirements under article 3.2 of R&TTE Directive [1] and is specified in EN 302 217-2-2 [16].

5.1.2.2 Remote Frequency Control (RFC)

This parameter is relevant to essential requirements under article 3.2 of R&TTE Directive [1] and is specified in EN 302 217-2-2 [16].

5.1.3 Transmitter output power tolerance

The only essential requirement is the power tolerance around the nominal output power together with the associated temperature range, declared by the supplier, which is considered essential under article 3.2 of R&TTE Directive [1]. For relevant limits see EN 302 217-2-2 [16].

An additional ETSI voluntary requirement may be required where more stringent limits apply according to the specific environmental condition for which the equipment is designed. In this case, when specified, the tolerance of the nominal output power shall be within the limits specified for:

- Systems operating within classes of weather protected locations defined in EN 300 019-1-0 [4] and EN 300 019-1-3 [7];

nominal output power, when specified, within $\pm A$ dB; the value for A is system dependent and is given in the relevant annex(es).

- Systems operating within non-weather protected locations classes 4.1 and 4.1E, defined in EN 300 019-1-0 [4] and EN 300 019-1-4 [8], and within classes 3.3, 3.4 and 3.5 weather protected locations defined in EN 300 019-1-0 [4], EN 300 019-1-3 [7];

nominal output power within $\pm B$ dB; the value for B is system dependent and is given in the relevant annex(es).

In any case, the less stringent tolerance ($\pm B$ dB or the single value, when a single tolerance exists), when applied to the operational environmental profile declared by the supplier (i.e. not necessarily an ETSI standardized one), is considered essential to article 3.2 and contained in EN 302 217-2-2 [16]. Only voluntary and more stringent tolerances are specified in the present document.

5.1.4 Radio Frequency (RF) spectrum mask

The radio frequency spectrum density mask is relevant to essential requirements under article 3.2 of R&TTE Directive [1], the limits for the essential portion of RF spectrum density masks are found in EN 302 217-2-2 [16].

Additional non-essential requirements for spectrum density masks may have to be met in cases where there is a requirement for internal system dependent reasons only. Where more stringent RF spectrum masks are required, they may be found in the relevant annex(es) of the present document.

The 0 dB level shown on the spectrum masks relates to the spectral power density at the carrier centre frequency, disregarding the residual of the carrier (due to modulation imperfection).

NOTE: The masks do not include frequency tolerance. Systems specified in annex A are an exception to this general rule; in this case "fo" identifies the nominal carrier frequency and the spectrum mask includes an allowance for frequency tolerance.

The spectrum analyser settings for measuring the RF spectrum mask are shown in table 6 of clause 5.2.4 of EN 302 217-2-2 [16]. They are reproduced in table 2 in the present document for the reader's convenience.

Table 2: Spectrum analyser settings for RF power spectrum measurement

Channel separation (CS) (MHz)	$0,003 < CS \leq 0,03$	$0,03 < CS \leq 0,3$	$0,3 < CS \leq 0,9$	$0,9 < CS \leq 12$	$12 < CS \leq 36$	$36 < CS$
Centre frequency	fo	Fo	fo	fo	fo	Fo
Sweep width (MHz)	$> 5 \times CS$	$> 5 \times CS$	$> 5 \times CS$	$> 5 \times CS$	$> 5 \times CS$	$> 5 \times CS$
Scan time	auto	Auto	auto	auto	auto	Auto
IF bandwidth (kHz)	1	3	10	30	100	300
Video bandwidth (kHz)	0,03	0,1	0,1	0,3	0,3	0,3

5.1.5 Discrete CW components exceeding the spectrum mask limit

5.1.5.1 Discrete CW components at the symbol rate

This parameter is relevant to essential requirements under article 3.2 of R&TTE Directive [1] and is specified in EN 302 217-2-2 [16].

NOTE: In some previous ENs more stringent limits were required, due to the possibility of interference on the analogue baseband channels of analogue systems deployed on the same route with digital systems. However these deployments are no longer practical and such requirements are therefore no longer considered appropriate (for new equipment).

5.1.5.2 Other discrete CW components exceeding the spectrum mask limit

This parameter is relevant to essential requirements under article 3.2 of R&TTE Directive [1] and is specified in EN 302 217-2-2 [16].

5.1.6 Spurious emissions - external

"External" limit for spurious emissions from transmitters are necessary in order to limit interference into other systems operating wholly externally to the system under consideration (external emissions).

This parameter is relevant to essential requirements under article 3.2 of R&TTE Directive [1] and is specified in EN 302 217-2-2 [16].

5.1.7 Radio frequency tolerance

This parameter is relevant to essential requirements under article 3.2 of R&TTE Directive [1] and is specified in EN 302 217-2-2 [16].

For the purpose of the present document the frequency tolerance is as defined in Art 1.151 of the Radio Regulations [25] as "*The maximum permissible departure by the centre frequency of the frequency band occupied by an emission from the assigned frequency*".

In some cases, as an additional ETSI voluntary requirement, more stringent limits apply according to the specific environmental condition for which the equipment is designed. In this case, when specified, maximum radio frequency tolerance shall not exceed:

- $\pm Y$ ppm or $\pm YY$ kHz, whichever is the more stringent, for operation in weather protected environmental classes 3.1 and 3.2 defined in EN 300 019-1-3 [7];
- $\pm X$ ppm or $\pm XX$ kHz, whichever is the more stringent, for operation in other more severe environmental classes defined in EN 300 019-1-0 [4] to EN 300 019-1-4 [8].

The values of either X or XX and either Y or YY are system dependent and are given in the relevant annex(es).

In any case, the less stringent tolerance ($\pm X$ ppm or $\pm XX$ kHz, the only one when a single tolerance exists), when applied to the operational environmental profile declared by the supplier (i.e. not necessarily an ETSI standardized one), is considered to be essential with respect to article 3.2 of R&TTE Directive [1] and is specified in EN 302 217-2-2 [16]. Only voluntary and more stringent tolerances are specified in the present document.

The values are system dependent and are given in the relevant annexes A to E. The supplier shall declare the values of the nominal carrier frequencies.

For conformity test purpose the supplier shall state the guaranteed short-term part and the expected ageing part.

5.2 Receiver characteristics

5.2.1 Spurious emissions-external

This parameter is relevant to essential requirements under article 3.2 of R&TTE Directive [1] and is specified in EN 302 217-2-2 [16].

5.3 System performance without diversity

5.3.1 BER as a function of receiver signal level

This parameter is relevant to essential requirements under article 3.2 of R&TTE Directive [1] and is specified in EN 302 217-2-2 [16].

5.3.2 Interference sensitivity

5.3.2.1 Co-channel "external" interference sensitivity

"External" co-channel interference is considered to be that interference from a system fully independent from the one under test (i.e. a system deployed by another operator in the same geographical area).

This parameter is relevant to essential requirements under article 3.2 of R&TTE Directive [1] and is specified in EN 302 217-2-2 [16].

5.3.2.2 Adjacent channel interference sensitivity

This parameter is relevant to essential requirements under article 3.2 of R&TTE Directive [1] and is specified in EN 302 217-2-2 [16].

In addition, for ACCP/CCDP applications of class 4 and class 5B systems in frequency bands below 15 GHz with $CS \geq 14$ MHz, to cope with differential fading effects on the longer hops in systems operating on adjacent channels on the same route but using different antennas, C/I values up to about 10 dB tighter than those reported in EN 302 217-2-2 [16] may be necessary. However, this actually depends on the hop fading occurrence factor and the ATPC range implemented on all adjacent systems (i.e. the higher is the ATPC common range, the lower is the C/I sensitivity need). The relationship of these parameters on hop performance prediction is not identified; therefore specific requirement cannot be defined.

5.3.2.3 CW spurious interference

This parameter is relevant to essential requirements under article 3.2 of R&TTE Directive [1] and is specified in EN 302 217-2-2 [16].

6 Complementary requirements

This clause considers requirements that are not related to essential requirements under article 3.2 of the R&TTE Directive [1]. Nevertheless, all or some of these requirements are considered useful for proper system operation and deployment when specific deployment conditions or compatibility requirements, as defined in clause 4.2, are present. Compliance to all or some of these requirements is on a voluntary basis.

6.1 Branching/feeder requirements

6.1.1 Waveguide flanges (or other connectors)

When flanges (or coaxial types) are required at reference point(s) B, B', C, C', the following types shall be used:

- UBR/PBR/CBR-XXX flanges according to IEC 60154-2 [18] shall be used for the bands specified in table 3. When the same band appears covered by two different options, both are admitted, provided that adaptors are available.
- Coaxial connectors can be used, as an option, for all frequency bands (see note). The impedance of the coaxial ports shall be nominally 50 Ω .

NOTE: For coaxial connectors a number of popular standards exist; attention is drawn to a range of coaxial connectors referred to in parts 1 and 2 of IEC 60339 [20], IEC 60169-1 [19], EN 122150 [2]. However, it should be noted that these standards are not exhaustive.

Table 3: Waveguide flanges of UBR/PBR/CBR types (according to IEC 60154-2 [18])

Frequency band(s)	WG "R" designation (and its frequency range in GHz) according to IEC 60153-2 [17]
1,4 GHz and 2,5 GHz bands 2,1 GHz to 2,5 GHz band	None (Only coaxial connections are commonly used)
3,5 GHz band	Either R 32 (2,6 to 3,95) or R 40 (3,3 to 4,9)
4 GHz band	R 40 (3,3 to 4,9)
5 GHz band	R 48 (3,95 to 5,85)
L6/U6 GHz band	R 70 (5,85 to 8,2)
7 GHz band(s)	Either R 70 (5,85 to 8,2) or R 84 (7,05 to 10)
8 GHz band	R 84 (7,05 to 10)
10,5 GHz band 11 GHz band	Either R 100 (8,2 to 12,4) or R 120 (10 to 15)
13 GHz band	Either R 120 (10 to 15) or R 140 (12,4 to 18)
15 GHz band	R 140 (12,4 to 18)
18 GHz band	either R 180 (15 to 22) or R 220 (18 to 26)
23 GHz band	R 220 (18 to 26)
26 GHz band	Either R 220 (18 to 26) or R 260 (22 to 33)
28 GHz band	Either R 260 (22 to 33) or R 320 (26,5 to 40)
31 GHz and 32 GHz bands	R 320 (26,5 to 40)
38 GHz band	R 320 (26,5 to 40)
48,5 GHz to 50,2 GHz band	R 500 (40 to 60)
52 GHz band	Either R 500 (40 to 60) Or R 620 (50 to 75)
55 GHz band	Either R 500 (40 to 60) Or R 620 (50 to 75)

6.1.2 Return loss at equipment antenna port (C/C' reference point)

It is frequent practice that equipment without integral antennas are connected to feeder/antenna systems from other supplier.

For equipment according to the present document, that uses outdoor radio frequency units, which are likely to have integral antennas or similar technical solutions, without long feeder connections, the impact of return loss at the antenna port on system performance is negligible and does not require (see also note to table 4) standardized limits.

For fully indoor systems, which are generally deployed with longer feeder connections to an external antenna, and may be required to operate with respect to compatibility requirements specified in clause 4.2 list items a and b, the minimum return loss depends on the signal bandwidth and modulation complexity.

The required values, at point C and C' of figure 1 of EN 302 217-1 [15], over the required RF channels and measured back in the direction to the equipment shall meet the values specified in table 4.

Table 4: Return loss at the C and C' port towards equipment for fully indoor system

Channel separation (CS) (MHz)	Spectral efficiency class		
	1 and 2	3 and 4	5 and 6
CS ≥ 27,5	14 dB	18 dB	20 dB (64 QAM based) 22 dB (128 QAM based) 24 dB (256 QAM based) 26 dB (512 QAM based)
27,5 > CS ≥ 13,75	Not required	12 dB	16 dB
13,75 > CS ≥ 7	Not required	Not required	10 dB
7 > CS	Not required	Not required	Not required
NOTE:	Not required means that return loss is not an issue for performance but only for potential power loss due to reflection. Even if there might be special cases where RF units designed for outdoor operation are also used in fully indoor conditions, this should be resolved on a case by case basis.		

For feeder/antenna return loss requirements see EN 302 217-4-1 [i.4].

6.2 Intermodulation products

Where multi-channel branching system is concerned and where the system is intended to comply with compatibility requirement in clause 4.2, each odd order intermodulation product, caused by different transmitters linked to the same branching system, shall be less than -110 dBm referenced to reference point B of figure 1 of EN 302 217-1 [15] with an output power per transmitter limited to the maximum power stated by the supplier for the equipment.

The reference power shall be the maximum power stated by the supplier for the equipment. This clause is not intended for use with conformance tests, but only, if required, for type tests agreed between user and supplier. The measurement, if any, will be carried out with un-modulated signals of the same power of the average level of the digital signals.

6.3 Transmitter characteristics

6.3.1 Spurious emissions - internal

This category covers emissions that, for system compatibility with other systems only, may be required to be more stringent than the "external" emissions detailed in clause 5.1.6. Requirements for internal spurious emissions are necessary only for systems that are required to comply with compatibility requirements under clause 4.2 list items a, b and c.

The levels of the spurious emissions from the transmitter, referenced to reference point B' of figure 1 of EN 302 217-1 [15] are specified in table 5.

The level of spurious emission will be the total average level integrated over the bandwidth of the channel under consideration.

Table 5: Internal levels for the transmitter spurious emissions

Controlling factor for requirement application	Spurious emission frequency relative to channel assigned frequency	Specification limit
Within transmit half band, digital interference to analogue systems on the same route, for digital systems with compatibility requirements as in clause 4.2 list item c.	Discrete (CW) spurious emissions within the same transmit half band	≤ -60 dBm
Within receive half band, digital into digital interference on the same local multi-channel branching/antenna system, for digital systems with compatibility requirements as specified in clause list item a.	All spurious signals within	≤ -90 dBm
Within receive half band, digital into digital interference for digital systems without branching network (i.e. single transceivers with duplexer), for digital systems with compatibility requirements as specified in clause 4.2 list item b.	The receive half band	≤ -70 dBm

6.4 Receiver characteristics

6.4.1 Input level range

The input Receiver Signal Level (RSL) range, under flat fading condition, where the BER is kept lower than a specified level (typically 10^{-6} for availability purpose and, for higher modulation formats, 10^{-10} for errored seconds performance) depends on various parameters such as, but not limited to, frequency band, hop length and spectrum efficiency class.

In principle, the highest is the range, the more flexible is the use of the equipment; however, high capacity systems with complex modulations (e.g. classes 5 and 6) suffer from one side of relatively higher RSL/BER thresholds and from the other side from more sensitivity to non-linear distortion caused by RX chain saturations. A unique standardized approach is not therefore advisable, nevertheless the necessary fade-margin shall be accommodated; the following "design objectives" are given for guidance only.

The lower limit for the RSL threshold for a Bit Error Ratio (BER) $\leq 10^{-6}$ is specified in the relevant annex of EN 302 217-2-2 [16]. The upper limit for the RSL, where the same BER of 10^{-6} , due to non-linear distortions, is not exceeded is assumed to be XX dB above.

In the same fashion, the upper limit for the RSL where a lower BER of 10^{-y} (typically 10^{-8} or 10^{-10}) is not exceeded is assumed to be YY dB above the relevant RSL threshold for that BER also specified in the relevant annex of EN 302 217-2-2 [16].

Indicative values for XX dB and YY dB are given in table 6.

Table 6: Indicative design objectives for input level range

Frequency Range ↓	XX RSL range (dB) for :			YY RSL range (dB) for :					
	BER $\leq 10^{-6}$			BER $\leq 10^{-8}$			BER $\leq 10^{-10}$		
	Spectral efficiency class			Spectral efficiency class			Spectral efficiency class		
	1 to 4	5	6	1 to 4	5	6	1 to 4	5	6
1,5 GHz to 3 GHz	47	-	-	-	-	-	-	-	-
3 GHz to 11 GHz	50 (see note 1)	47 (see note 2)	Systems C.x: See annex C Other systems: 44 (see note 3)	-	-	-	-	38/41 (see note 7)	Systems C.x: See annex C Other systems: 35
13 GHz to 18 GHz	50 (see note 1)	47 (see note 2)	44 (see note 3)	48	34 (see note 5)	-	-	38/41 (see notes 6 and 7)	35
23 GHz to 38 GHz	44 (see note 3)	44 (see note 3)	41 (see note 3)	41 (see note 4)	41 (see note 4)	38 (see note 4)	-	-	-
40 GHz to 55 GHz	44 (see note 3)	-	-	41 (see note 4)	-	-	-	-	-

NOTE 1: RSL higher than -20 dBm is not required.
NOTE 2: RSL higher than -22 dBm is not required.
NOTE 3: RSL higher than -23 dBm is not required.
NOTE 4: RSL higher than -24 dBm is not required.
NOTE 5: For channel spacing > 28 MHz only.
NOTE 6: For channel spacing \leq 28 MHz only.
NOTE 7: Higher value for systems with compatibility requirements under clause 4.2.
NOTE 8: In case of two-carriers systems (D.8 and E.4 systems referred in annexes D and E, respectively), when carrying STM-4 or when carrying 4 x STM-1, with each STM-1 mixed on both carriers, the test shall be made changing the RSL of both carrier simultaneously. For more details see clause G.3 in EN 302 217-2-2 [16].

These limits apply without interference and are referenced to point B (points B and C may coincide when simple duplexer is used) of figure 1 of EN 302 217-1 [15].

For equipment designed to operate only with ATPC as a fixed permanent feature the above maximum input levels are reduced by an amount up to the ATPC range.

6.4.2 Spurious emissions - internal

For systems without the compatibility requirements of clause 4.2 there is no requirement.

When equipment is required to share the same antenna with other equipment, the spurious emissions limits, referenced to point B, are specified in table 7.

The required level will be the total average level integrated over the bandwidth of the channel under consideration.

Table 7: Limits of spurious emissions-internal

Controlling factor	Specification limit
Spurious falling in the same receive half-band for systems with compatibility requirements of clause 4.2 list item a.	≤ -110 dBm
Spurious falling in the same receive half-band for systems with compatibility requirements of clause 4.2 list item b.	≤ -70 dBm

NOTE: In addition, when compatibility with FDM systems on the same branching/antenna system is required, more stringent limits for CW lines (e.g. L.O. residual emission) might be necessary, ranging from ≤ -85 dBm to ≤ -125 dBm, according to the actual interfered baseband frequency of the analogue system and the possible additional decoupling due to local IPI of the antenna (conventionally assumed to be 40 dB).

6.4.3 Image rejection

The receiver image(s) rejection shall be as listed in table 8.

Table 8: Receiver image rejection

Controlling factor	Image rejection
a) For any image frequency falling within the receive half band while using branching on different polarizations as defined under the compatibility requirements in clause 4.2 list item b.	≥ 90 dB
b) For systems not intended to fulfil any compatibility requirements in clause 4.2 list item a and/or 4.2 list item b.	Not Applicable
c) For any image frequency falling within the receive half band while using branching on same polarization, as defined in clause 4.2 list item a, or in the transmit half band on different polarization, as defined by the compatibility requirements in clause 4.2 list item b.	≥ 100 dB
d) For any image(s) frequency falling within transmit half band and using branching on same polarization, as defined by the compatibility requirements in clause 4.2 list item a.	≥ 120 dB

Additional requirements, if any, may be found in the relevant annexes A through to E of the present document.

6.4.4 Innermost channel selectivity

For systems, which are intended to comply with compatibility requirement under clause 4.2 list items a and b, to guarantee innermost TX/RX channel compatibility, the inner side of the innermost receiver shall be within the mask which is system and channel arrangement dependent and given in annex(es) to the present document.

Since it is not considered feasible to make a practical measurement of this characteristic, the supplier shall give the design data of all filters implemented on this receiver.

6.5 System performance without diversity

6.5.1 Equipment Residual BER (RBER)

The RBER level under simulated operating conditions without interference shall be guaranteed with a signal level at reference point B (or C) of the system block diagram of figure 1 of EN 302 217-1 [15], which is between 10 dB and 35 dB above the threshold level which gives $BER \leq 10^{-6}$ (as specified in clause 5.3.1); however an upper limit above -30 dBm is not required (see note 1).

NOTE 1: Only for the 52 GHz and 55 GHz bands the value could be relaxed to -32 dBm.

The requirement is intended between base-band ports at reference points X' and X shown in figure 1 of EN 302 217-1 [15]. As the measurement is made on the tributaries, the clause relative to one rate is also applicable to systems for $n \times$ the same rate (e.g. requirement for 2 Mbit/s is applicable to $n \times 2$ Mbit/s).

To guarantee a higher degree of service, see clause G.1, the network operator may require equipment to meet a RBER limit with the first adjacent channel interferer. In this case the RBER level under simulated operating conditions shall still be guaranteed with a signal level as specified above with an adjacent interference level set to represent a Carrier to Interference ratio (C/I) of:

- -4 dB for all system classes 1 to 4.
- +7 dB for class 5A systems (this figure assumes a minimum cross polar discrimination of 10 dB for these systems).
- -3 dB or -4 dB for class 5B systems (see note 2).
- According to the supplier's declaration for class 6 systems.

NOTE 2: Class 5B systems are basically sensitive to interference (e.g. 128 states with a roll off of approximately 20 %); they are standardized for network applications that include adjacent channels on a parallel route, sometimes with terminal co-located stations shared by different network operators. In such cases, even if nominal power (or EIRP) is kept equal through common spectrum management practice, the power tolerance may endanger proper error performance with particular regard to Errored Seconds (ES) objectives unless a tighter specification for adjacent channel sensitivity is offered. Therefore it is required that either the transmitter output power tolerance is reduced or the adjacent channel sensitivity is enhanced as shown in table 9.

Table 9 (to note 2): C/I vs. output power tolerance for RBER of class 5B systems

	Output power tolerance	1st adjacent channel C/I
Option 1	+2 dB / -1 dB	-3 dB (see note)
Option 2	± 2 dB	-4 dB (see note)
NOTE: Measurement of RBER under first adjacent interference conditions for 1 dB RSL degradation is thus: for option 1 the level of interference shall be at 3 dB above the signal level (C/I = -3 dB); for option 2 the level of interference shall be at 4 dB above the signal level (C/I = -4 dB).		

In the above conditions the RBER shall be:

- For systems capacity between 64 kbit/s and 192 kbit/s: RBER < 10^{-9} .
- For systems capacity above 192 kbit/s and less than 34 Mbit/s: RBER < 10^{-10} .
- For systems capacity equal 34 Mbit/s and less than 140 Mbit/s: RBER < 10^{-11} .
- For system capacity equal to STM-0 in frequency bands at or below 18 GHz: RBER < 3×10^{-12} .
- For systems capacity at 140 Mbit/s and up to STM-4 Mbit/s (see note 3): RBER < 10^{-12} .

NOTE 3: For STM-4 capacity on multi-channel trunk systems at or below 11 GHz (for long radio connections) a RBER < 10^{-13} may be required by the network.

This requirement is intended for the payload bit rates defined in clause 5 or equivalent payload rates as defined in annex F.

Systems designed for CCDP operation, shall guarantee RBER with its own cross-polar corresponding equipment active and set at a RSL difference, with respect to that under test, of less than 5 dB.

In case of two-carriers systems (D.8 and E.4 systems referred in annexes D and E, respectively), when carrying STM-4 or when carrying $4 \times$ STM-1, with each STM-1 mixed on both carriers, the test shall be made changing the RSL of both carrier simultaneously. For more details see clause G.3 in EN 302 217-2-2 [16].

EN 301 126-1 [14] recognizes that this requirement is subject to a supplier declaration only. However, in clause G.1 some background information relating to the actual test methods and test confidence is given.

Annex G also provides the format for the minimum recording time and the maximum numbers of errors not to be exceeded.

6.5.2 Interference sensitivity for CCDP with XPIC operation

The level and impact of Cross Polar Co-channel Interference depends on the frequency band, class of equipment, climatic conditions, antenna discrimination and hop length. When these factors are favourable, CCDP can be achieved without the use of an XPIC.

Whenever XPIC is implemented for class 5 and 6 systems, with channel separations from 27,5 MHz to 56 MHz, and for class 6 systems, with channel separations of 40 MHz, the following applies; the "internal interference" is hereby considered to be that given by the twin systems sharing the same XPIC system.

6.5.2.1 Co-channel "internal" interference sensitivity in flat fading conditions

For the frequency bands given under clause 4.1 the limits of the co-channel interference sensitivity for the system are given in table 10.

Table 10: Degradation versus C/I (co-channel "internal" interference)

Reference BER →	10 ⁻⁶	10 ⁻⁶
RSL Degradation →	1 dB	3 dB
C/I (dB) for class 5 equipment	17	13
C/I (dB) for class 6 equipment	24	20

Referring to the measurement test bench in annex G, note that measurements must be made adding the same values of noise and interference to both the paths, and varying the phase shifter of the interfering path in order to find the worst condition for this characteristic.

6.5.2.2 Co-channel "internal" interference sensitivity under dispersive fading conditions

This requirement is standardized for systems at 18 GHz and below.

To evaluate the performance during multipath propagation, dispersive cross-polarized main signals and non dispersive cross-polarization interferences are used in the test bench set up shown in clause G.2.

The system performance is evaluated by means of a signature degraded by an injected cross polar interference signal under the defined measurement conditions. The notch frequencies and notch depths are kept equal on both the wanted and simulated dispersed signal paths. The limits for BER = 10⁻⁶ are specified in table 11.

Table 11: Degraded signature versus C/I (co-channel "internal" interference)

Class / CS ↓	C/I	Signature width	Signature depth
Class 5 / 28 MHz to 40 MHz	15 dB	±23 MHz	10 dB
Class 5 / 55 MHz or 56 MHz	15 dB	±36 MHz	5 dB
Class 6	According to supplier declaration	According to supplier declaration	According to supplier declaration

6.5.3 Distortion sensitivity

If applicable, depending on the frequency band and/or the system baud-rate and distortion sensitivity:

- For a delay of 6,3 ns and a BER of 10⁻⁶ the width of the signature shall not exceed ±XX MHz relative to the channel assigned frequency and the depth shall not be less than YY dB.

- These limits are valid for both minimum and non-minimum phase cases and shall also be verified by the loss of synchronization and re-acquisition signatures (see IEC 60835-2-4 [21] and IEC 60835-2-8 [22]).

The values of the width and of the depth of the signature are system dependent and are given in the annex(es).

NOTE: It should be noted that, in some previous ENs for PP systems, signatures for $BER = 10^{-3}$ were also standardized. However, according to the present network requirements for high quality data transport, this BER is no longer representative for a unique performance and availability assessment. An intermediate limit for signatures, generally set between 10^{-6} and 10^{-3} , may be appropriate for link performance prediction and may be defined by the supplier according to the kind of traffic and quality of service to be provided.

6.6 System characteristics with diversity

Space, angle and frequency diversity techniques are applicable. In this clause, only combining techniques are considered.

6.6.1 Differential delay compensation

It shall be possible to compensate for differential absolute delays due to antennas, feeders and cable connections on the two diversity paths. The limit shall be at least 75 ns of differential absolute delay.

6.6.2 BER performance

When both receiver inputs (main and diversity, reference point B and BD) are fed with the same signal level with an arbitrary phase difference, the input level limits for the specified BER values defined under clause 5.3.1, shall be lower than those given under clause 5.3 for the case without diversity:

- More than 2,5 dB for IF or baseband combining systems.
- More than 1,5 dB for RF combining systems.
- No improvement for baseband switch systems.

Annex A (normative): Frequency bands from 1,4 GHz to 2,7 GHz

A.0 Introduction

The following fixed point-to-point digital relay systems are covered in this annex:

- A.1: Low capacity point-to-point digital radio systems operating in the 1,4 GHz frequency band.
- A.2: Low and medium capacity point-to-point digital radio systems operating in the frequency range 2,1 GHz to 2,6 GHz.

Besides those characteristics set out in the main body of the present document or in EN 302 217-2-2 [16], table A.1 summarizes requirements that are specific for the above systems.

Table A.1: Additional specific requirements for family A systems

Characteristics and requirements	System A1	System A2
Special compatibility requirements between systems (clause 4.2) →	No special compatibility under bullets a) through c) of clause 4.2 is required	
Transmitter power tolerance	B = +2 dB/-1 dB	
Radio frequency tolerance	No specific value is requested, however, Radio frequency tolerances shall be included in the spectrum masks	
Receiver image rejection	<p>The definition of a receiver image rejection is not applicable to receivers with direct demodulation</p> <p>Due to particular conditions of frequency allocations in bands below 3 GHz, independently from requirements due to special compatibility situations set in clause 6.4.3, the receiver image(s) rejection shall be:</p> <ul style="list-style-type: none"> - Classes 1 and 2 75 dB minimum; - Class 3: 85 dB minimum. 	

Annex B (normative): Frequency bands from 3 GHz to 11 GHz (channel separation up to 30 MHz and 56 / 60 MHz)

B.0 Introduction

The following fixed point-to-point digital relay systems are covered in this annex:

- B.1 Low and medium capacity and STM-0 digital radio system.
- B.2 High capacity digital radio systems carrying $1 \times$ STM-1 signals and operating in frequency bands with about 30 MHz channel spacing and alternated arrangements (ACAP).
- B.3 High capacity digital radio systems carrying SDH signals (up to $2 \times$ STM-1) in frequency bands with about 30 MHz channel spacing and using Co-polar arrangements (ACCP) or Co-Channel Dual Polarized (CCDP) operation.
- B.4 High capacity digital radio systems carrying $4 \times$ STM-0 or 5×34 Mbit/s signals in frequency bands with about 30 MHz channel separation and using ACAP operation.
- B.5 High capacity digital radio systems carrying $8 \times$ STM-0 or 10×34 signals in frequency bands with about 60 MHz channel separation and using ACAP operation.
- B.6 High capacity digital radio systems carrying $2 \times$ STM1 SDH signals (ACCP) or STM-4/4 \times STM1 (CCDP) in frequency bands with about 60 MHz channel separation.

Besides those characteristics set out in the main body of the present document or in EN 302 217-2-2 [16], table B.1 summarizes requirements that are specific for the above systems.

Table B.1: Additional specific requirements for family B systems

Characteristics and requirements	System B.1	System B.2	System B.3	System B.4	System B.5	System B.6
Special compatibility requirements between systems (clause 4.2)	List items b of clause 4.2 may be applicable	All list items a through to c of clause 4.2 may be applicable	List items a through to c of clause 4.2 may be applicable	None (see note)	None (see note)	None (see note)
Transmitter output power tolerance (clause 5.1.3)	$\pm A = \pm 1$ dB $\pm B = \pm 2$ dB					
Transmitter Radio Frequency (RF) spectrum mask (clause 5.1.4)	None	Clause B.2.1	Clause B.3.1	None (see note)		
Transmitter radio frequency tolerance (clause 5.1.7)	$\pm X = \pm 15$ ppm for equipment operating with channel spacing lower than 14 MHz; and, $\pm X = \pm 30$ ppm for equipment operating with channel spacing greater than or equal to 14 MHz	$\pm Y = \pm 30$ ppm $\pm X = \pm 50$ ppm or $\pm XX = \pm 400$ kHz (whichever is more stringent)				

Characteristics and requirements	System B.1	System B.2	System B.3	System B.4	System B.5	System B.6
Receiver Innermost channel selectivity (clause 6.4.4)	None	Clause B.2.2	Clause B.3.2	None (see note)		
Distortion sensitivity (clause 6.5.3)	Clause B.1.1	$\pm XX = \pm 20$ MHz YY = 11 dB	$\pm XX = \pm 19$ MHz YY = 13 dB and clause B.3.3 for dynamic behaviour	$\pm XX = \pm 22$ MHz YY = 12 dB	$\pm XX = \pm 44$ MHz YY = 6 dB	$\pm XX = \pm 36$ MHz YY = 8 dB
NOTE: Even if the major application for these systems would be for single or 1:1 protected channel of very high capacity links, also these systems might need, in some cases, to share the same branching/antenna systems with other B.4 systems or other designed for similar applications (e.g. system B.2). In such cases, list items a through to c of clause 4.2 may still be applicable. No specific improved TX or innermost RX masks are here standardized; however, it is expected that such problematic would be solved on case by case adopting similar measures.						

B.1 System B.1 (2 - 2 × 34 Mbit/s; STM-0 - 2 × STM-0 / 3 GHz to 11 GHz / 1,75 MHz to 29,65 MHz)

B.1.1 Distortion sensitivity

The parameters for distortion sensitivity signatures are given in table B.2 only for medium capacity systems (i.e. 34 Mbit/s, 2 × 34 Mbit/s STM-0 and 2 × STM-0).

For a delay of 6,3 ns and BER of 10^{-6} the signature width ($\pm XX$) and depth (YY) should not exceed the values in table B.2.

Table B.2: Signature width and depth

Spectrum efficiency class	Nominal bit rate (Mbit/s)	Channel spacing (MHz)	Signature for BER = 10^{-6}	
			Width (MHz)	Depth (dB)
Class 2	34	28/29/29,65/30	± 17	11
Class 3	STM-0	28/29/29,65/30	± 13	14
Class 4	34	14/14,5/15	± 11	14
	2 × 34	28/29/29,65/30	± 20	14
	STM-0	20 to 2 × 11,662	± 13	14
	STM-0	14/14,5/15	± 11	15
	2 × STM-0	28/29/30	± 22	15
Class 5B	2 × 34	14/14,5/15 (ACCP)	± 9	17
NOTE: All signature widths are relative to the assigned channel centre frequency.				

B.2 System B.2 (STM-1 / 3 GHz to 10,5 GHz / about 30 MHz ACAP)

B.2.1 Radio Frequency (RF) spectrum mask

Clause 4.2 provides compatibility requirements. The compatibility requirements provide options for single-channel and multi-channel RF branching systems. When considering the compatibility requirements in clause 4.2 list item a and/or list item b, the RF spectrum mask shall take into consideration the effects of system interoperability when selecting normal channels or the innermost channel (see below).

Limits of masks in figures B.1 to B.3 are for normal and innermost channels of systems which are intended to comply with compatibility requirement under clause 4.2 list item a and/or list item b. The limits marked (a) in figures B.1 to B.3 shall be verified directly by measurement. Since it is not possible to measure attenuation values up to 105 dB directly, values of the relative power spectral density below -65 dB in figures B.1 to B.3 (curve b) should be subject to a supplier declaration.

NOTE: These values may be evaluated by adding a measured filter characteristic to the spectrum measured at reference point A' of figures B.1 to B.3. Due to the limitations of some spectrum analysers, difficulties may be experienced when testing high capacity/wideband systems. In this event, the following options are to be considered: measurement using high performance spectrum analyser, use of notch filters and the two step measurement technique. Where difficulties are experienced, the plots of one test conducted at ambient and environmental extremes may be produced as evidence to conformance to the spectrum mask.

Figure B.1 shows limits for any channel.

For the lower 6 GHz (L6) band, where the centre gap (44,49 MHz) is particularly small, for guaranteeing compatibility between the innermost channels, a mask is specified for the innermost edges of the centre gap channels 8 and 1', the mask is given in figure B.2.

For the 7 GHz band, when the centre gap is 56 MHz, for guaranteeing compatibility between co-polarized signals innermost channels, a mask is specified for the innermost edges of the centre gap channels, the mask is given in figure B.3.

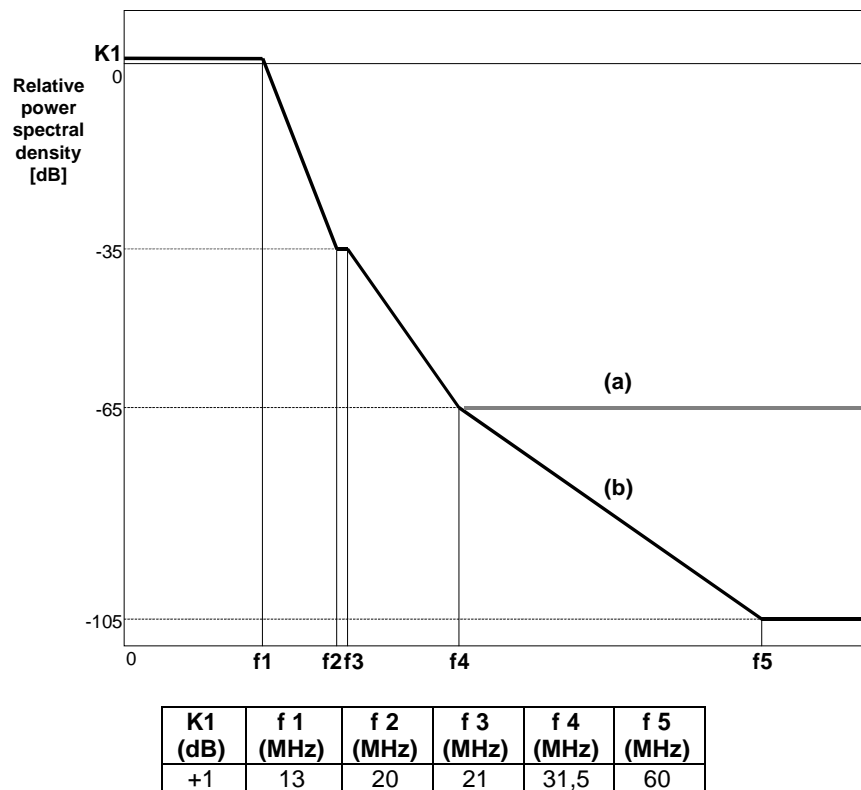

Figure B.1: Limits of power spectral density for normal channels (class 5A) (reference point B')

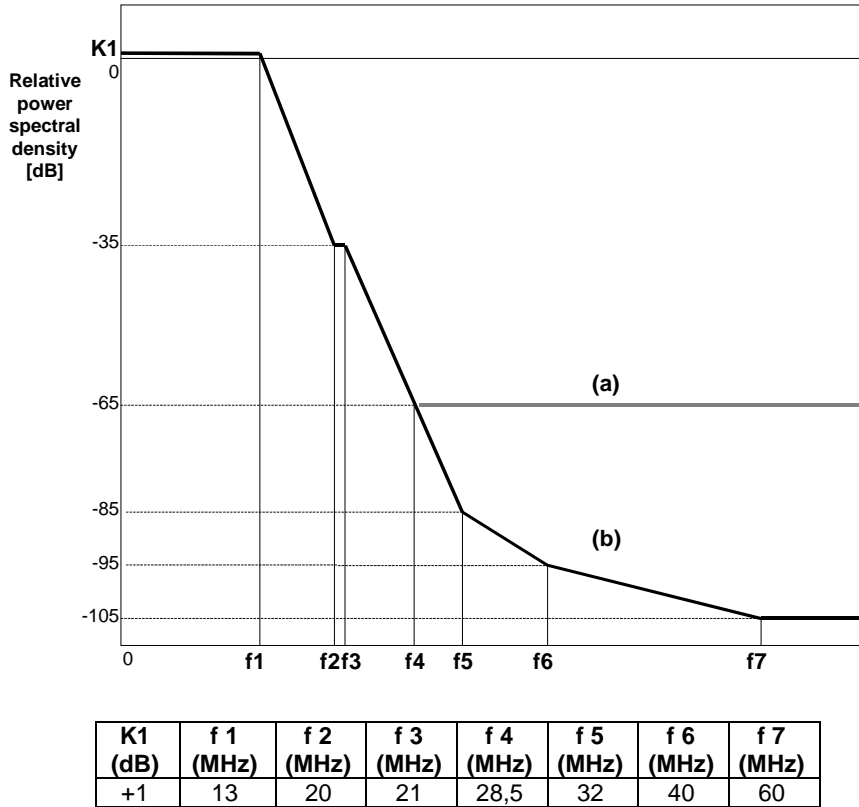

Figure B.2: Limits of power spectral density for the innermost channels (class 5A), L6 GHz band (reference point B')

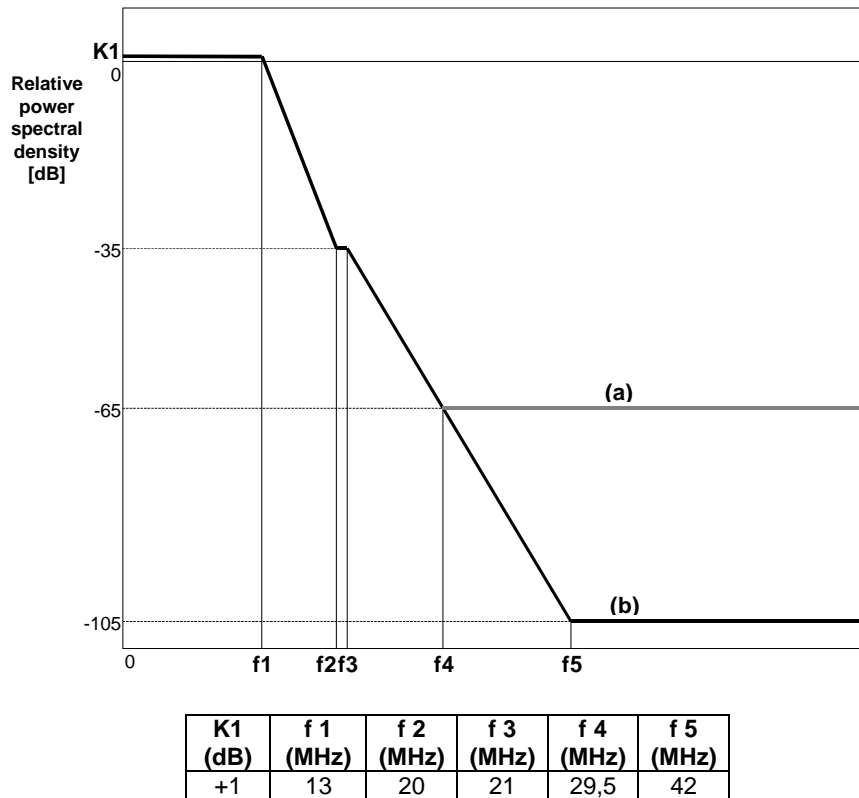

Figure B.3: Limits of power spectral density for the inner edges of innermost channels (class 5A) in the 7 GHz band with 56 MHz co-polar centre gap (reference point B')

B.2.2 Receiver innermost channel selectivity

For systems which are intended to comply with compatibility requirements under clause 4.2 list item a and/or list item b, to guarantee innermost TX/RX channel compatibility in L6 GHz band, the inner side of the innermost receiver shall be within the mask given in figure B.4.

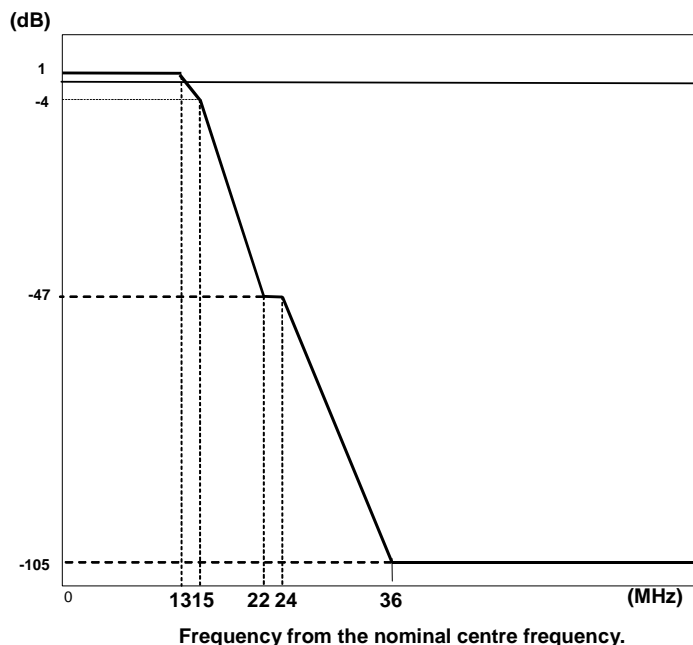

Figure B.4: Overall minimum receiver selectivity of the inner side of innermost receiver for L6 GHz band (class 5A)

Since it is not considered feasible to make a practical measurement of this characteristic, the supplier shall give the design data of the filters implemented on this receiver.

B.3 System B.3 (2 × STM-1 / 3 GHz to 11 GHz / about 30 MHz CCDP)

B.3.1 Radio Frequency (RF) spectrum mask

Spectrum masks in figures B.5 and B.6 (see note 1) are applicable to multiple channel systems (typically in fully indoor trunk applications) where all channels in both polarization are exploited under the same branching/antenna system and systems from different suppliers may be required to operate under the same branching system according to clause 4.2 list item a (see note 2).

As far as innermost channels are concerned, the masks are relevant only to cross-polar connected channels, typical for operation with two transmitting antennas. For single antenna operation, the required decoupling of the even and odd channels, the (possible) summing hybrid, circulators and relevant spectrum masks are under study.

Due to the more stringent requirements than that of systems operating with adjacent cross-polarized channels, the given masks are absolute maximum limits. Actual systems shall provide a Net Filter Discrimination (NFD) of adequate value to fulfil the adjacent channel interference limits set out in clause 5.3.2.2. These values may be derived from direct computation or measurement of the actual emitted spectrum and receiver RF, IF and BB selectivity.

Less stringent compatibility, according to 4.2 b), may be applicable when frequency reuse is not implemented (i.e. the second polarization, in ACAP operation, is still used by or reserved for equipment from another supplier). Even if used on different antenna systems, channels of B.3 systems, adjacent to B.2 systems, shall be used, on the same route, cross-polarized and without frequency reuse.

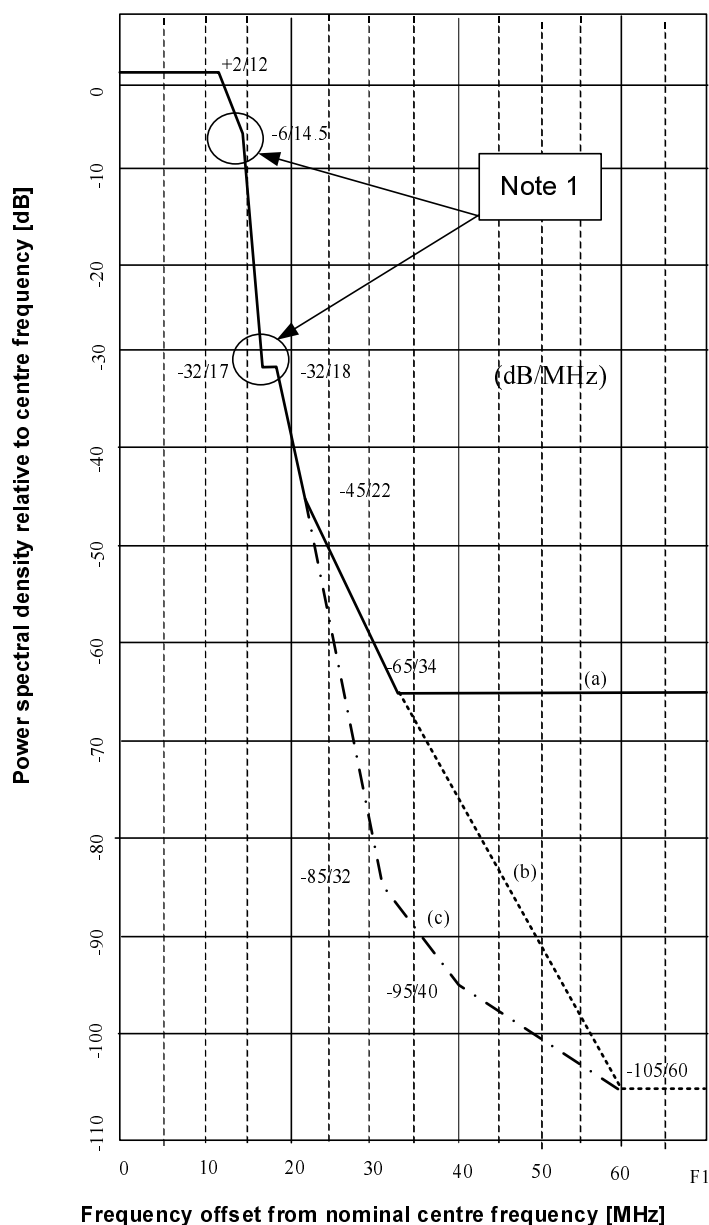

F1 = 72,5 MHz (for channel separation 29 MHz);
 74,125 MHz (for channel separation 29,65 MHz);
 75 MHz (for channel separation 30 MHz).

NOTE 1: The mask, in the indicated zones, is slightly less stringent than the one corresponding to same systems B.3 considered relevant for article 3.2 of R&TTED [1] and developed at later stage for inclusion in harmonized EN 302 217-2-2 [16]. It has not been aligned in the present document for historical reasons only; however, it is assumed that equipment, conforming to the present document, shall meet to the more stringent envelope of the two masks.

NOTE 2: (a) limit for direct measurement;
 (b) normal channels;
 (c) inner edges of innermost channels for L6 GHz band.

NOTE 3: In U6 GHz band, the ECC recommended 30 MHz channel arrangement provides a center gap of 40 MHz; however, innermost channels are not usually intended for being combined to a common antenna. Therefore, no requirement is here proposed.

Figure B.5: Spectrum mask for frequency bands with 29 MHz, 29,65 MHz and 30 MHz channel (reference point B')

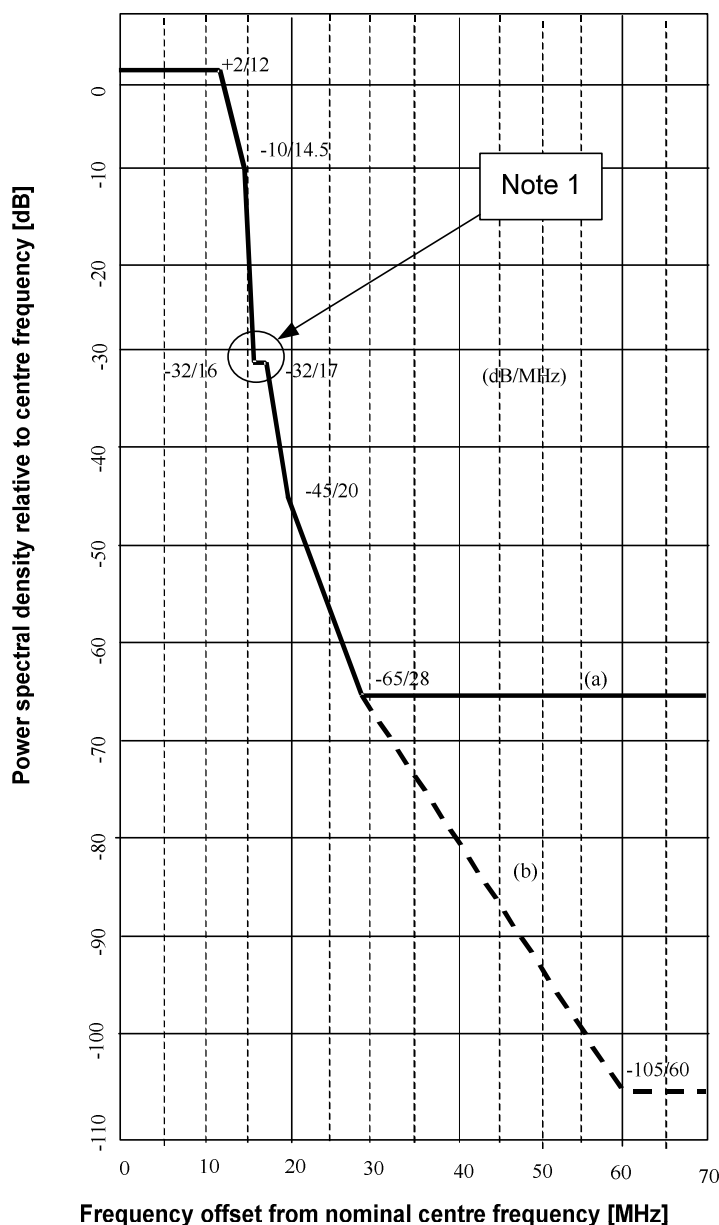

NOTE 1: The mask, in the indicated zone, is slightly less stringent than the one corresponding to same systems B.3 considered relevant for article 3.2 of R&TTED [1] and developed at later stage for inclusion in harmonized EN 302 217-2-2 [16]. It has not been aligned in the present document for historical reasons only; however, it is assumed that equipment, conforming to the present document, shall meet to the more stringent envelope of the two masks.

NOTE 2: (a) limit for direct measurement;
 (b) normal channels (valid also for the innermost channels with 56 MHz centre gap).

Figure B.6: Spectrum mask for frequency bands with 28 MHz channel separation (reference point B')

B.3.2 Innermost channel selectivity

For systems which are intended to comply with compatibility requirements under clause 4.2 list item a and/or list item b, in order to guarantee innermost TX/RX channel compatibility, the inner side of the innermost receiver shall be within the limits of the mask shown in figure B.7.

Figure B.7 shows a mask for the overall relative receiver sensitivity for the inner edges of the innermost channels of the L6 GHz band and for frequency bands with 28 MHz channel spacing and a 56 MHz centre gap. The receiver selectivity may be evaluated by calculating the effect of the receiver filter response on the received signal.

In figure B.7 the mask (a) is for systems that offers compatibility requirements according to clause 4.2 list item a, where different supplier equipment may share the same branching system; the mask (b) is for systems that do not offer compatibility requirements according to clause 4.2 list item a, but different supplier equipment may still share the same site on different antennas.

NOTE: In U6 GHz band, the ECC recommended 30 MHz channel arrangement provides a center gap of 40 MHz; however, innermost channels are not usually intended for being combined to a common antenna. Therefore, no requirement is here proposed.

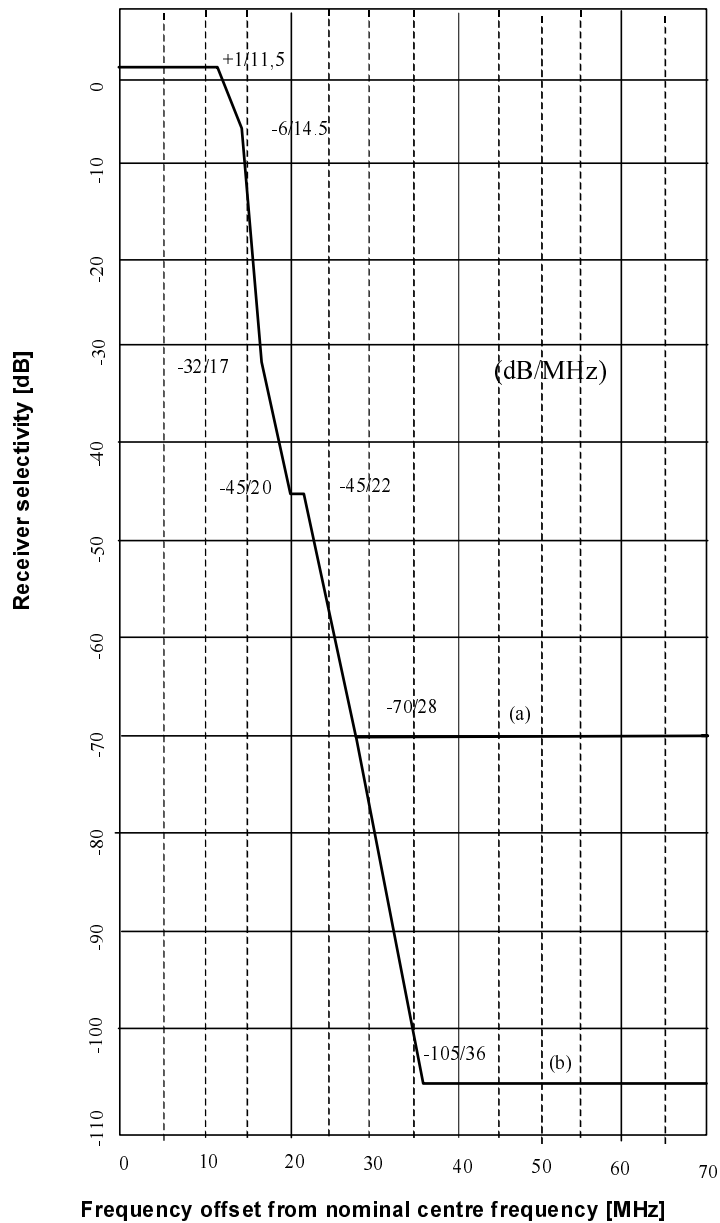

NOTE: (a) Systems sharing the same branching).
(b) Systems sharing the same site on different antennas.

Figure B.7: Limits for the receiver selectivity for the inner edges of the innermost channels in the L6 GHz band (reference point B')

B.3.3 Distortion sensitivity - dynamic behaviour

In addition to static signature requirement, given in table B.1, the sensitivity to dynamic fading is verified with the following parameters:

- For a notch speed up to 100 MHz/s and a BER = 10^{-6} the notch depth shall not fall below a value of 12 dB (sweeping in \pm half channel spacing).

B.4 System B.4 (4 × STM-0 / 5 × 34 / 3 GHz to 10,5 GHz / about 30 MHz ACAP)

See table B.1.

B.5 System B.5 (8 × STM-0 / 10 × 34 / 3 GHz to 10,5 GHz / about 60 MHz ACAP)

See table B.1.

B.6 System B.6 (2 × STM1 (ACCP) or STM-4 / 4× STM1 (CCDP) / 3 GHz to 10,5 GHz / about 60 MHz)

See table B.1.

Annex C (normative): Frequency bands from 3 GHz to 11 GHz (channel separation 40 MHz)

C.0 Introduction

The following fixed point-to-point digital relay systems are covered in this annex:

- C.1 High capacity fixed radio systems carrying SDH signals (up to $2 \times \text{STM-1}$) in frequency bands with 40 MHz channel spacing and using Co-Polar arrangements (ACCP) or Co-channel Dual Polarized (CCDP) operation.
- C.2 High capacity digital radio systems carrying STM-4 in two 40 MHz channels or $2 \times \text{STM-1}$ in a 40 MHz channel with alternate (ACAP) channel arrangement.
- C.3 High capacity digital radio systems transmitting STM-4 or $4 \times \text{STM-1}$ in a 40 MHz radio frequency channel using Co-Channel Dual Polarized (CCDP) operation.

Besides characteristic set out in the main body of the present document or in EN 302 217-2-2 [16], table C.1 summarizes requirements that are specific to the above systems.

Table C.1: Additional specific requirements for family C systems

Characteristics and requirements	System C.1	System C.2	System C.3
Special compatibility requirements between systems	Item list a of clause 4.2 may be applicable	Items b through c of clause 4.2 may be applicable	Items b and c of clause 4.2 may be applicable
Transmitter output power tolerance (clause 5.1.3)	$\pm A = \pm 1$ dB $\pm B = \pm 2$ dB	$B = \pm 1$ dB	$B = \pm 1$ dB
Transmitter Radio Frequency (RF) spectrum mask	Clause C.1.1	Clause C.2.1	Clause C.3.1
Transmitter radio frequency tolerance	$\pm Y = \pm 30$ ppm $\pm X = \pm 50$ ppm or $\pm XX = \pm 400$ kHz (whichever is more stringent)	$\pm XX = \pm 30$ ppm	$\pm XX = \pm 20$ ppm
Receiver input level range	Clause 6.4.1	Clause C.2.2	Clause C.3.2
Distortion sensitivity	Clause C.1.2	$\pm XX = \pm 22$ MHz $YY = 16$ dB	$\pm XX = \pm 27$ MHz $YY = 14$ dB and clause C.3.3 for dynamic behaviour and measurement conditions in both static and dynamic cases

C.1 System C.1 ($2 \times \text{STM-1}$ / 3 GHz to 11 GHz / 40 MHz - CCDP)

System C.1 includes two different sets of parameters, both intended for ACCP or CCDP operation (class 5B) but with sensible difference in some requirements. They are here formally identified as type 1 and 2:

- Type 1 is based on 30 MHz-like system technology (i.e. based on 128 states modulation).
- Type 2 is based on 40 MHz-like system technology (i.e. based on 64 states modulation).

C.1.1 Radio Frequency (RF) spectrum mask

Spectrum mask in figure C.1 are applicable to multiple-channel systems (systems typically in fully indoor trunk applications) where all channels in both polarization are exploited under the same branching/antenna system and systems from different suppliers may be required to operate under the same branching system according to clause 4.2 list item a.

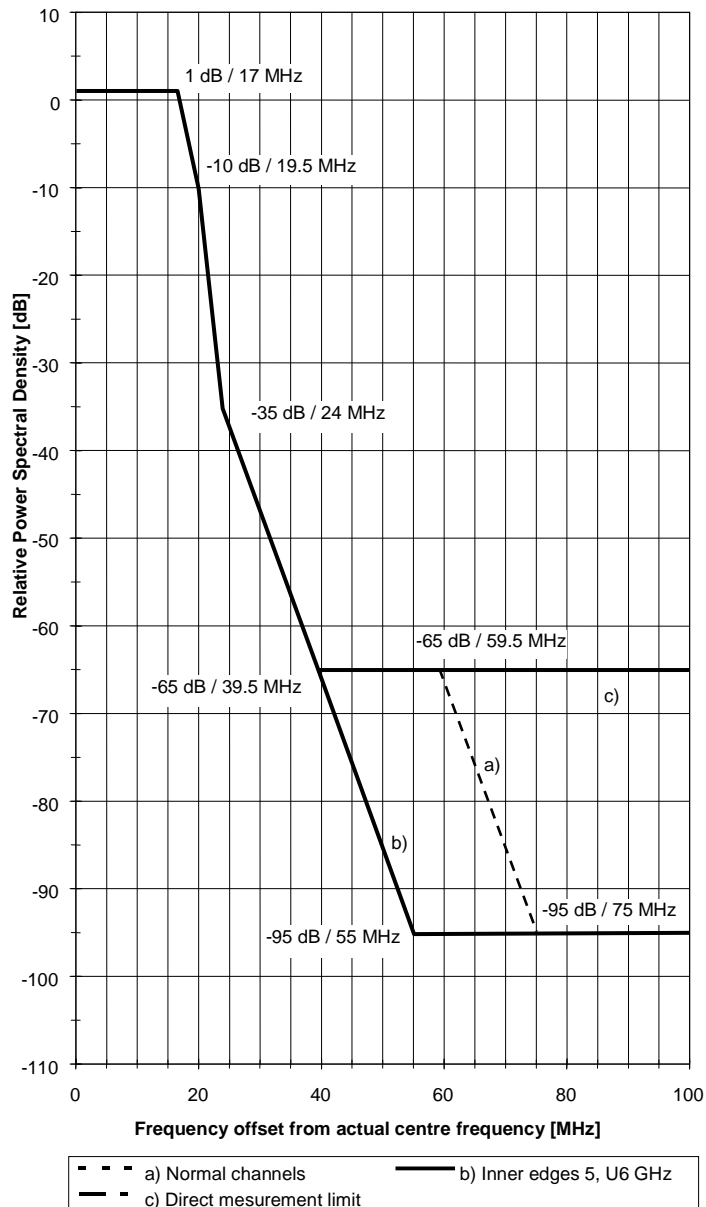

Figure C.1: Limits of power spectral density (reference point B')

C.1.2 Distortion sensitivity

For the different equipment types the requirements in table C.2 apply.

Table C.2: Signature width and depth

Spectrum efficiency class	Nominal bit rate (Mbit/s)	Channel spacing (MHz)	Signature for BER = 10^{-6}	
			Width ($\pm XX$)	Depth (YY)
Class 5B type 1	STM-1	40	± 19 MHz	12 dB
Class 5B type 2	STM-1	40	± 19 MHz	16 dB

NOTE: All signature widths are relative to the assigned channel centre frequency.

The sensitivity to dynamic fading is not the subject of standardization, however it may be evaluated with the following parameters:

- For a notch speed up to 100 MHz/s (sweeping activated in \pm half channel spacing), with a notch depth 1 dB less stringent than the above figures for BER = 10^{-6} , the BER should not be higher than 10^{-6} .

C.2 System C.2 (2 \times STM-1 / 3 GHz to 11 GHz / 40 MHz - ACAP)

C.2.1 Radio Frequency (RF) spectrum mask

Clause 4.2 provides compatibility requirements. The compatibility requirements provide options for single-channel and multi-channel RF branching systems. When considering the compatibility requirements in clause 4.2 list item b, the RF spectrum mask shall take into consideration the effects of system interoperability when selecting normal channels or the innermost channel (see below).

The spectrum mask given in figure C.2, is applicable to all frequency bands, it guarantees suitable performance for systems operating on the same route and innermost channel operation.

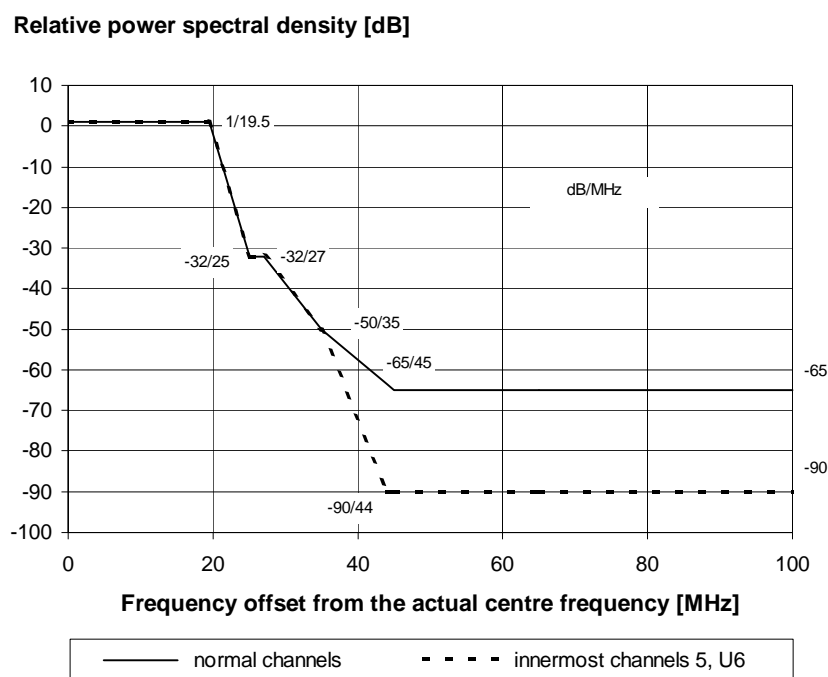

Figure C.2: Limits of spectral power density (reference point B')

C.2.2 Receiver input level range

The lower limit for the receiver input level is defined by the threshold level for Bit Error Ratio (BER) = 10^{-6} . The upper limit for the receiver input level, where a BER of 10^{-10} may only be exceeded shall be for levels greater than -27 dBm.

These limits apply without interference and are referenced to point B.

C.3 System C.3 (4 × STM-1 / 3 GHz to 11 GHz / 40 MHz - CCDP)

C.3.1 Transmitter Radio Frequency (RF) spectrum mask

Clause 4.2 provides compatibility requirements. The compatibility requirements provide options for single-channel and multi-channel RF branching systems. When considering the compatibility requirements in clause 4.2 list item a, the RF spectrum mask shall take into consideration the effects of system interoperability when selecting normal channels or the innermost channel (see below).

Limits of masks in figures C.3 and C.4 (for single and multi-carrier systems, respectively) are for normal and for the innermost side of the innermost channels of systems which are intended to comply with compatibility requirement under clause 4.2 List item a. The limits marked (a) in figures C.1 and C.2 shall be verified directly by measurement. Since it is not possible to measure attenuation values up to 110 dB directly, values of the relative power spectral density below -65 dB in figures C.3 and C.4 (curve b) should be subject to a supplier declaration.

NOTE: These values may be evaluated by adding a measured filter characteristic to the spectrum measured at reference point A' of figures C.3 and C.4. Due to limitations of some spectrum analysers, difficulties may be experienced when testing high capacity/wideband systems. In this event, the following options are to be considered: measurement using high performance spectrum analyser, use of notch filters and two step measurement technique. Where difficulties are experienced, the plots of one test conducted at ambient and environmental extremes may be produced as evidence to conformance to the spectrum mask.

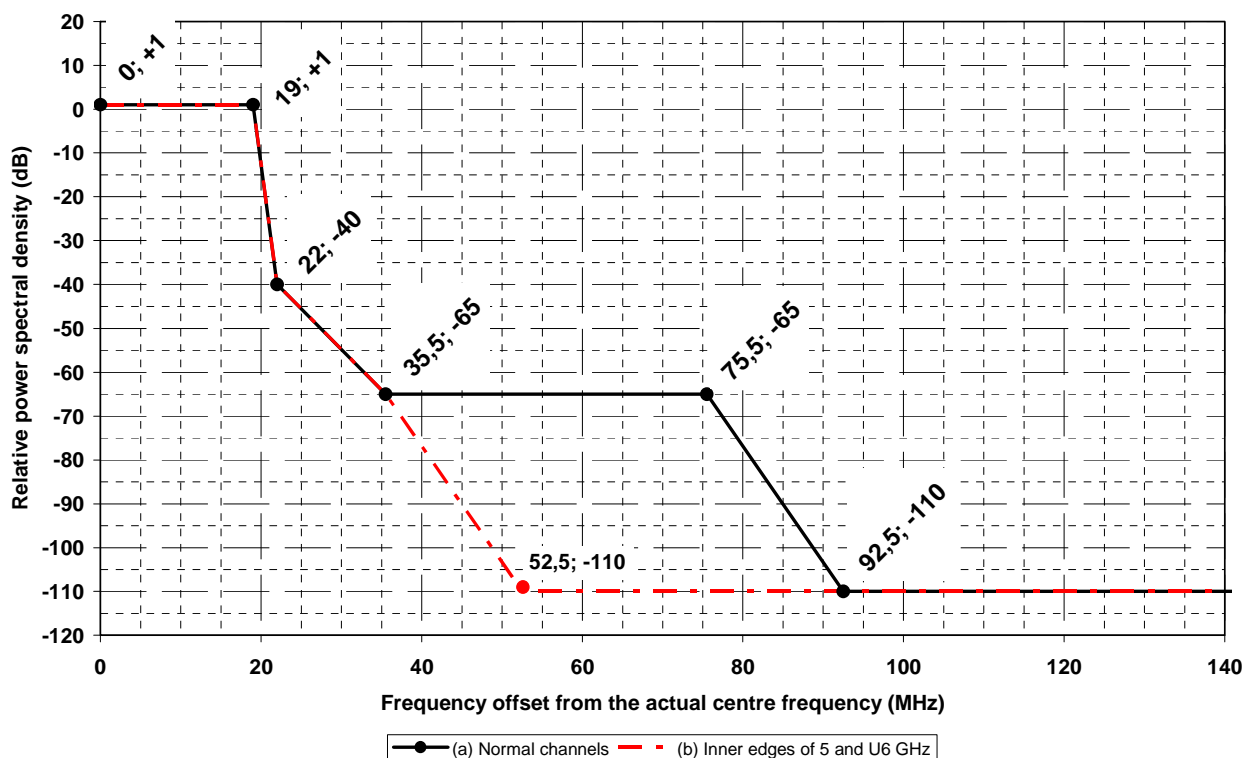

Figure C.3: Limits for single carrier systems (reference point B')

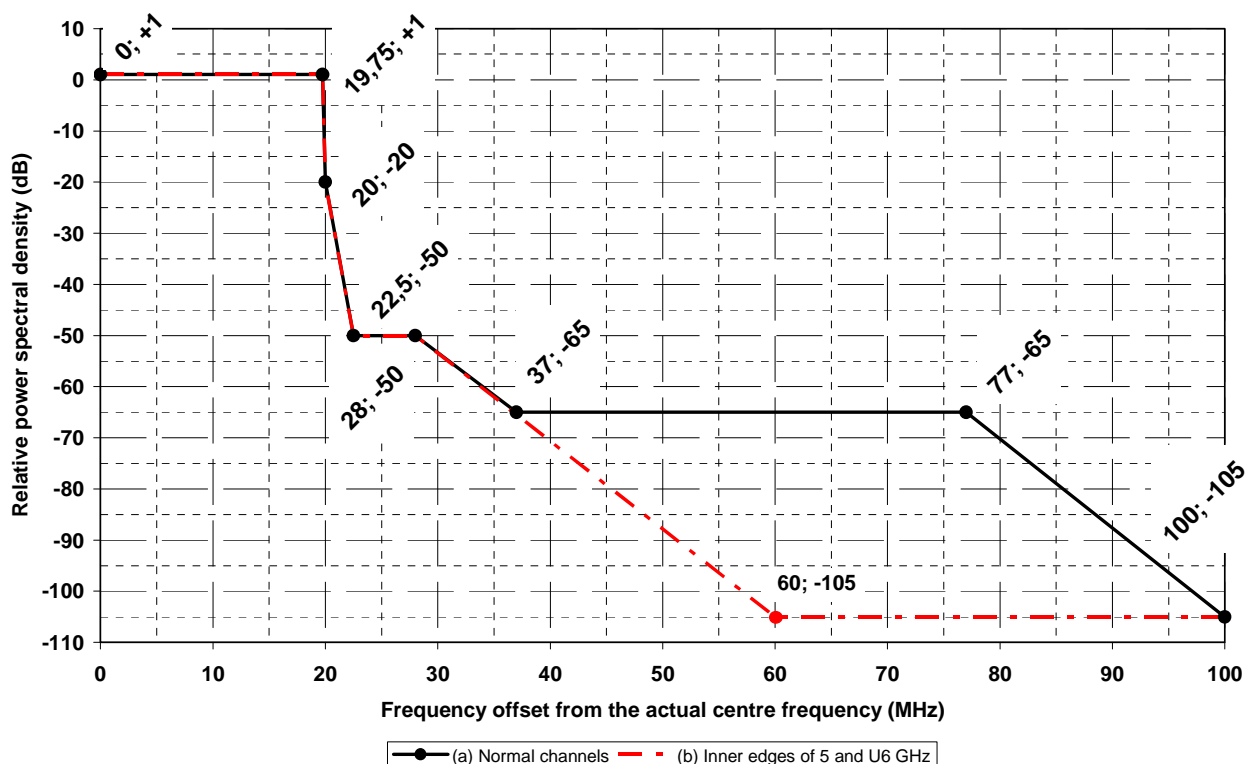

Figure C.4: Limits for multi-carrier systems (reference point B')

C.3.2 Receiver input level range

The lower limit for the receiver input level shall be given by the threshold level for $BER = 10^{-6}$. The upper limit for the receiver input level, where a BER of 10^{-10} may be exceeded shall be greater than -16 dBm. When ATPC is used the maximum input level for $BER < 10^{-10}$ may be relaxed to -31 dBm.

These limits should apply without interference and are referenced to point B.

C.3.3 Distortion sensitivity

Distortion shall be introduced in one polarization at a time and the error rate shall be measured for the total STM-4 or $4 \times STM-1$ signal.

In addition to static signature requirement, the sensitivity to dynamic fading is verified with the following parameters:

- Distortion shall be introduced in one polarization at a time and the error rate measured for the total STM-4 or $4 \times STM-1$ signal.
- A notch (6,3 ns delay) with a depth of 13 dB swept across the whole band (± 20 MHz) with a speed not less than 150 MHz/s shall not cause a BER greater than 10^{-6} .
- A notch (6,3 ns delay) swept down between 4 dB and 13 dB with a speed not less than 100 dB/s shall not cause a BER greater than 10^{-6} . The measurement shall be performed for constant notch frequencies within the whole band (± 20 MHz).

Annex D (normative): Frequency bands 13 GHz, 15 GHz and 18 GHz

D.0 Introduction

The following fixed point-to-point digital relay systems are covered in this annex:

- D.1 Low and medium capacity Plesiochronous Digital Hierarchy (PDH) radio systems operating in the 13 GHz, 15 GHz and 18 GHz frequency bands.
- D.2 Radio systems for the transmission of Sub-STM-0 digital signals operating in the 18 GHz frequency band.
- D.3 STM-0 digital radio systems operating in the 13 GHz, 15 GHz and 18 GHz frequency bands with about 28 MHz co-polar (ACCP) and 14 MHz cross-polar (ACAP) channel separation.
- D.4 STM-0 or 2 x STM-0 digital radio systems operating in the 13 GHz, 15 GHz and 18 GHz frequency bands with about 14 MHz or about 28 MHz co-polar (ACCP) channel separation.
- D.5 High capacity digital radio systems carrying 1 x STM-1 signals and operating in frequency bands with about 30 MHz channel separation and alternated arrangements (ACAP) operating in the 13 GHz, 15 GHz and 18 GHz frequency bands.
- D.6 High capacity digital radio systems carrying SDH signals (up to 2 x STM-1) in frequency bands with about 30 MHz channel separation and using Adjacent Channel Co-polar (ACCP) arrangements or Co-Channel Dual Polarized (CCDP) operation operating in the 13 GHz, 15 GHz and 18 GHz frequency bands.
- D.7 Radio systems for the transmission of STM-1 digital signals operating in the 15 GHz and 18 GHz frequency bands with channel separation of 55 MHz or 56 MHz.
- D.8 High capacity digital radio systems carrying STM-4, 4 x STM-1 or 2 x STM-1 signals in bands with 55 MHz or 56 MHz channel separation operating in the 13 GHz, 15 GHz and 18 GHz frequency bands.
- D.9 High capacity digital radio systems carrying 4 x STM-0/5 x 34 Mbit/s signals in bands with 27,5 MHz/28 MHz channel separation and alternated arrangements (ACAP) operating in the 13 GHz, 15 GHz and 18 GHz bands.
- D.10 High capacity digital radio systems carrying 8 x STM-0/10 x 34 Mbit/sec signals in bands with 55/56 MHz channel separation and alternated arrangements (ACAP) operating in the 13 GHz, 15 GHz and 18 GHz bands.

Besides characteristic set out in the main body of the present document or in EN 302 217-2-2 [16], table D.1 summarizes requirements that are specific for the above systems.

Table D.1: Additional specific requirements for family D systems

Characteristics and requirements	System D.1	System D.2	System D.3	System D.4	System D.5	System D.6	System D.7	System D.8	System D.9	System D.10
Special compatibility requirements between systems	Item b of clause 4.2 may apply				List items a and b of clause 4.2 may apply	List item a of clause 4.2 may apply	List items a and b of clause 4.2 may apply	None of the list items a through c of clause 4.2 may apply		
Transmitter output power tolerance (see note 1)	$\pm B = \pm 2$ dB $\pm A = \pm 1$ dB									
Transmitter Radio Frequency (RF) spectrum mask	None				Clause B.2.1	13 GHz and 15 GHz: Clause B.3.1 18 GHz: Clause D.6	Clause D.7 (18 GHz only)	None		
Transmitter radio frequency tolerance	$\pm X = \pm 10$ ppm		$\pm X = \pm 30$ ppm	$\pm X = \pm 15$ ppm	$\pm Y = \pm 30$ ppm $\pm X = \pm 50$ ppm or $\pm XX = \pm 400$ kHz (whichever is the more stringent)		$\pm X = \pm 15$ ppm			
Distortion sensitivity	Clause D.1.1	None	$\pm XX = \pm 13$ MHz $YY = 20$ dB (see note 2)	Clause D.4.1	$\pm XX = \pm 20$ MHz $YY = 11$ dB	13 GHz and 15 GHz: $\pm XX = \pm 19$ MHz $YY = 13$ dB and clause B.3.3 for dynamic behaviour 18 GHz: $\pm XX = \pm 22$ MHz $YY = 12$ dB	$\pm XX = \pm 27$ MHz $YY = 8$ dB	$\pm XX = \pm 36$ MHz $YY = 8$ dB	$\pm XX = \pm 22$ MHz $YY = 12$ dB	$\pm XX = \pm 44$ MHz $YY = 6$ dB
NOTE 1: For class 5B equipment see also note 2 of clause 6.5.1.										
NOTE 2: Because rainfall in 18 GHz band is the main propagation factor limiting performance, in this band the above limits are not mandatory.										

D.1 System D.1 (2 / 2 x 34 Mbit/s / 13 GHz, 15 GHz and 18 GHz / 1,75 MHz / 28 MHz)

D.1.1 Distortion sensitivity

For the frequency bands considered and for this system, rainfall may be considered as the main propagation factor limiting performance. Powerful equalizers to compensate propagation distortion are not considered for class 2 systems and frequency bands above the 13 GHz band, nor for class 3, 4 and 5 systems operating at bit rates lower than 34 Mbit/s.

No specific requirement is recommended, however, equipment with equalizers will be subject to a supplier's declaration of signature parameters for a two path propagation with a delay of 6,3 ns and a BER of 10^{-6} .

D.2 System D.2 (sub STM-0 / 18 GHz / 3,5 MHz)

See table D.1.

D.3 System D.3 (STM-0 / 13 GHz, 15 GHz and 18 GHz / 28 MHz ACCP-14 MHz ACAP)

See table D.1.

D.4 System D.4 (STM-0 or $2 \times$ STM-0 / 13 GHz, 15 GHz and 18 GHz / 14 MHz or 28 MHz ACCP)

D.4.1 Distortion sensitivity

Even if rainfall may be the main propagation factor limiting performance and availability in the frequency bands envisaged, contribution of multipath phenomena should also be taken into account in a number of links. Table D.2 gives the requirements.

Table D.2: Signature width and depth

Spectrum efficiency class	Nominal bit rate (Mbit/s)	Channel separation (MHz)	Signature for BER = 10^{-6}	
			Width ($\pm XX$)	Depth (YY)
Class 4	STM-0	13,75/14	± 11 MHz	15 dB
	$2 \times$ STM-0	27,5/28	± 22 MHz	15 dB

NOTE: All signature widths are relative to the assigned channel centre frequency.

D.5 System D.5 (STM-1 / 13 GHz, 15 GHz and 18 GHz / about 30 MHz ACAP)

See table D.1.

D.6 System D.6 ($2 \times$ STM-1 / 13 GHz, 15 GHz and 18 GHz / about 30 MHz CCDP)

D.6.1 RF spectrum mask

In 18 GHz band, for class 5B systems, EN 302 217-2-2 [16] does not require attenuation greater than 50 dB for the spectrum mask floor relevant to R&TTE Directive [1] compliance. However, for guaranteeing RBER performance in the presence of multiple (i.e. 2nd, 3rd, etc.) adjacent channels regardless of the FEC algorithm implemented, a mask floor at 55 dB might be required (see note). The corresponding frequency corner may be derived extending the sixth segment of the mask (provided in annex D of EN 302 217-2-2 [16]) beyond point f6 down to intercept the -55 dB ordinate.

NOTE: Actual requirement depend on the interference-limited efficiency of the error correction algorithm and from the actual number of adjacent channels foreseen, therefore this requirement may be substituted by a supplier declarations of the interference-limited RBER capability of the equipment.

D.7 System D.7 (STM-1 / 15 GHz and 18 GHz / 55/56 MHz)

D.7.1 RF spectrum mask

The compatibility requirements provide options for single-channel and multi-channel RF branching systems for class 4 systems. When considering the compatibility requirements in clause 4.2 list items a and b, the RF Spectrum Mask shall take into consideration the effects of system interoperability when selecting normal channels or the innermost channel (see below). The spectrum masks are defined in figure D.1 for the following applications as per clause 4.2:

- Limits of masks "4A" to "4C" are for innermost and normal channels, respectively, of systems which are intended to comply with compatibility requirements under clause 4.2 list item b and used for single-channel RF branching systems.
- Limits of masks "4B" and "4D" are for innermost and normal channels, respectively, of systems which are intended to comply with compatibility requirements clause 4.2 list item a and used for multi-channel RF branching systems.

The masks "4A" to "4D", given in figure D.1, fix lower limits of 88 dB and 105 dB in order to control local interference between transmitters and receivers of different suppliers connected to the same antenna.

Since it is not possible to measure attenuation values up to 105 dB directly, values above 50 dB in figure D.1 should be subject to a supplier declaration.

NOTE: These values may be evaluated by adding a measured filter characteristic to the measured spectrum at reference point A' of figure 1 of EN 302 217-1 [15].

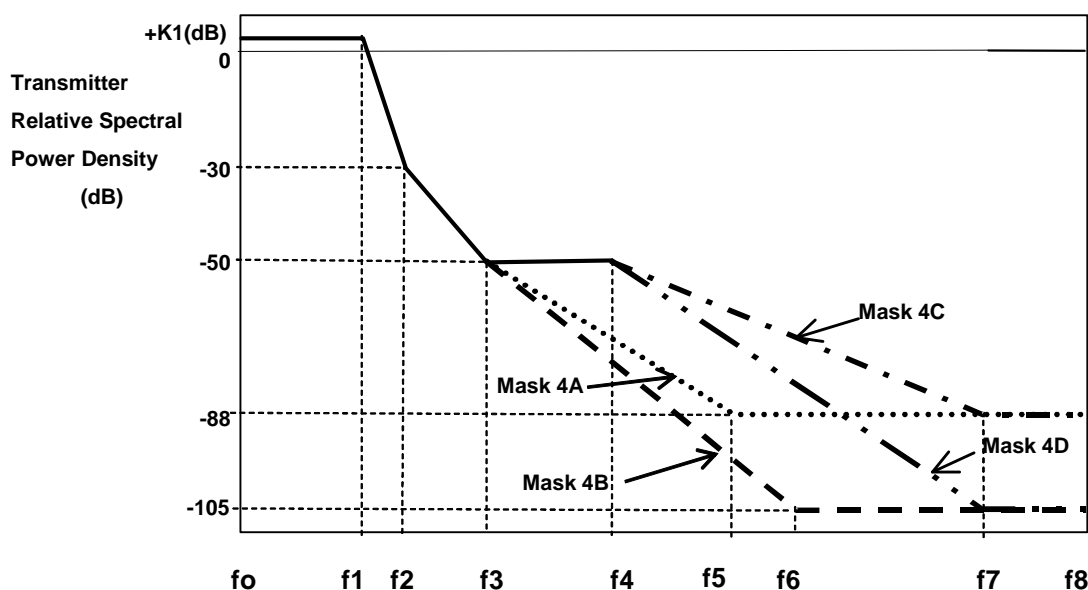

NOTE: Frequency expressed from actual transmitter centre frequency (MHz).
 Mask 4A: Innermost channel, compatibility requirement clause 4.2 list item b.
 Mask 4B: Innermost channel, compatibility requirement clause 4.2 list item a.
 Mask 4C: Normal channel, compatibility requirement clause 4.2 list item b.
 Mask 4D: Normal channel, compatibility requirement clause 4.2 list item a.

Figure D.1: Limits of spectral power density for class 4 systems (reference corner in table D.3) (at reference point B')

Table D.3: Spectrum mask frequency limits for class 4 systems

Mask Ref.	Bit rate (Mbit/s)	Channel spacing (MHz)	K1 (dB)	f 1 (MHz)	f 2 (MHz)	f 3 (MHz)	f 4 (MHz)	f 5 (MHz)	f 6 (MHz)	f 7 (MHz)	f 8 (MHz)
4A	155	55	+1	22,5	33	70	n.a.	105	n.a.	n.a.	180
4B	155	55	+1	22,5	33	70	n.a.	n.a.	115	n.a.	180
4C	155	55	+1	22,5	33	70	85	n.a.	n.a.	160	180
4D	155	55	+1	22,5	33	70	85	n.a.	n.a.	160	180

D.8 System D.8 (2 × STM-1 (ACAP or ACCP) and STM-4 (CCDP) / 13 GHz, 15 GHz and 18 GHz / 55 MHz and 56 MHz)

See table D.1.

D.9 System B.4 (4 × STM-0 / 5 × 34 / 13 GHz, 15 GHz and 18 GHz / 27,5 MHz and 28 MHz ACAP)

See table D.1.

D.10 System B.5 (8 × STM-0 / 10 × 34 / 13 GHz, 15 GHz and 18 GHz / 55 MHz and 56 MHz ACAP)

See table D.1.

Annex E (normative): Frequency bands from 23 GHz to 55 GHz

E.0 Introduction

The following fixed point-to-point digital relay systems are covered in this annex:

- E.1 Radio systems for the transmission of digital signals operating in the 23 GHz frequency band.
- E.2 Radio system for the transmission of digital signals operating in the frequency range 24,5 GHz to 29,5 GHz.
- E.3 Radio systems for the transmission of digital signals operating in the 31 GHz, 32 GHz and 38 GHz frequency bands.
- E.4 High capacity digital radio relay systems carrying STM-4, 4 × STM-1 or 2 × STM-1 signals in bands with 55 MHz or 56 MHz channel separation operating in the frequency range 23 GHz to 38 GHz.
- E.5 Low and medium capacity digital radio systems operating in the 50 GHz frequency band.
- E.6 Radio systems for the transmission of digital signals operating in the 52 GHz frequency band.
- E.7 Radio systems for the transmission of digital signals operating in the 55 GHz frequency band.

Besides characteristic set out in the main body of the present document or in EN 302 217-2-2 [16], table E.1 summarizes requirements that are specific to the above systems.

Table E.1: Additional specific requirements for family E systems

Characteristics and requirements	System E.1	System E.2	System E.3	System E.4	System E.5	System E.6	System E.7
Special compatibility requirements between systems	List item b of clause 4.2 may apply		None of the list items a through to c of clause 4.2 is applicable				
Transmitter output power tolerance (see note 1)	$\pm B = \pm 2$ dB	$\pm B = \pm 2$ dB	$\pm A = \pm 2$ dB $\pm B = \pm 3$ dB	$\pm A = \pm 1$ dB $\pm B = \pm 3$ dB (31, 32 and 38 GHz bands) $\pm B = \pm 2$ dB (23 to 28 GHz bands)	$\pm A = \pm 2$ dB $\pm B = \pm 3$ dB	$\pm B = \pm 3$ dB	$\pm B = \pm 3$ dB
Transmitter Radio Frequency (RF) spectrum mask	Clause E.1 (see note 2)			None			
Radio frequency tolerance	$\pm X = \pm 15$ ppm	$\pm X = \pm 20$ ppm	$\pm X = \pm 15$ ppm	$\pm X = \pm 15$ ppm	$\pm X = \pm 20$ ppm (class 1 equipment) $\pm X = \pm 10$ ppm (class 2 equipment)	$\pm X = \pm 15$ ppm	$\pm X = \pm 15$ ppm
Distortion sensitivity	None			$\pm XX = \pm 36$ MHz YY = 8 dB	None		
NOTE 1: For class 5B equipment see also note 2 of clause 6.5.1.							
NOTE 2: For class 5B equipment only.							

E.1 Systems E.1, E.2 and E.3: Transmitter spectrum mask for class 5B equipment

For E.1, E.2 and E.3 systems of class 5B, in EN 302 217-2-2 [16], attenuation greater than 50 dB is not required for the spectrum mask floor relevant to R&TTE Directive [1] essential requirements; however, for guaranteeing RBER performance in the presence of multiple (i.e. 2nd, 3rd, etc.) adjacent channels regardless of the FEC algorithm implemented, a mask floor at 55 dB might be required (see note). The corresponding frequency corner may be derived extending the sixth segment of the mask (provided in annex E of EN 302 217-2-2 [16]) beyond point f6 (for systems E1 and E2) or beyond point f5 (for system E3) down to intercept the -55 dB ordinate.

NOTE: Actual requirement depend on the interference-limited efficiency of the error correction algorithm and from the actual number of adjacent channels foreseen, therefore this requirement may be substituted by a supplier declarations of the interference-limited RBER capability of the equipment.

Annex F (normative): Transmission of packet data and combinations of other signals in bands from 3 GHz to 55 GHz

F.1 Introduction

This annex provides the conditions under which the existing PDH/SDH specifications can be used for systems with traffic interface combinations other than those mentioned in the PDH/SDH specifications when mapped into proprietary transport modules (i.e. not mapped into conventional standardized PDH or SDH transport modules).

F.2 General characteristics

F.2.1 Frequency characteristics and channel arrangements

The equipment shall operate on frequency bands and channels arrangements in accordance with information provided in the relevant annex from A through to E (of the present document and of EN 302 217-2-2 [16]) selected from table F.1 of EN 302 217-2-2 [16].

F.2.2 Transmission capacities and equipment assessment

For assessing such equipment against requirements set in this EN 302 217 series, it is necessary to select the set of equipment characteristics relevant to the channel spacing and the equipment classes of an equivalent PDH/SDH rate for the same frequency band from the referenced annexes A to E of the present document and EN 302 217-2-2 [16]. For maintaining a suitable spectral efficiency, the selection shall be made comparing the minimum required Radio Interface Capacities (RIC) with those conventional PDH/SDH rates as defined in table F.1 of EN 302 217-2-2 [16].

In the event that no PDH/SDH interface is available at base band level (reference points X, X' of figure 1 of EN 302 217-1 [15]), and no other means (even proprietary ones) are possible for a true bit-to-bit error count at reference point X, clause F.3.3 of EN 302 217-2-2 [16] describes how to translate the BER requirements from the PDH/SDH specification to verify compliance of the radio system when such a combination of interfaces includes at least an Ethernet interface.

Additional information on the derivation of BER/FER relationship and testing examples may be found in clause G.4 of the present document.

Clause G.1 provides requirements related to equipment Residual FER (RFER).

In the event that an Ethernet interface is not offered, but other standardized interfaces are used, the supplier shall declare an equivalent conversion table supported by technical evidence of its appropriateness.

Annex G (informative): Additional information

G.1 Residual Bit Error Ratio (RBER) and Frame Error Ratio (RFER)

In particular applications, where there is a high density of radio links in a specific area, e.g. nodal site, closely located radios may use adjacent channels. Therefore to guarantee the grade of service the equipment will need to meet RBER criteria in the presence of adjacent channel interference.

The RBER is standardized in order to match the ESR (or the BER) performance required by ITU-R transmission performance recommendations.

To have sufficient confidence in the measurement, where the BER is relatively low compared to the actual payload, the test time is very long. To have sufficient confidence in measuring RBER where it is relatively low compared to the actual payload bit rate, the testing period becomes significantly long. The actual background to this measurement and the BER figures are detailed in TR 101 036-1 [i.1].

When error correction feature is implemented it may be possible to reduce the measurement time by estimating the RBER, from the value tested without error correction, using the relevant BER improvement formula declared by the supplier.

The equipment maximum allowed number of errors level under simulated operating conditions is measured with a signal level at reference point B (or C) which is 10 dB above the RSL which gives $BER \leq 10^{-6}$ (as specified in clause 5.3.1 and in EN 302 217-2-2 [16]). All measurements will be made at the payload bit rate defined in clause 4.3.

Based on TR 101 036-1 [i.1] for a $\approx 50\%$ confidence results, the measurement period and maximum number of errors allowed are given in table G.1.

Table G.1: Maximum permitted number of bit errors

Bit rate (Network interface)	RBER objective	Minimum recording time (hours)	Maximum allowed number of bit Errors
2 Mbit/s	10^{-10}	16	12
8 Mbit/s	10^{-10}	4	12
34 Mbit/s	10^{-11}	10	12
STM-0 (systems above 18 GHz)	10^{-11}	15	12
STM-0 (systems up to 18 GHz)	3×10^{-12}	24	10
140 Mbit/s/STM-1	10^{-12}	24	10
STM-4	10^{-12}	6	10
STM-4	10^{-13}	60	10

Another more practical, but with less confidence, option is to ensure that no errors occur during the minimum recording time shown in table G.1a for PDH and SDH signals and table G.1b for packet data signals; for other rates (possibly used under the provision of annex F) values may be extrapolated from the closest ones.

Table G.1a: PDH and SDH rates - Zero errors recording times

Bit rate (Network interface) (Mbit/s)	RBBER objective	Minimum recording time (minutes)	Errors
2	10^{-10}	82	0
8	10^{-10}	21	0
34	10^{-11}	50	0
STM-0 (systems above 18 GHz)	10^{-11}	34	0
STM-0 (systems up to 18 GHz)	3×10^{-12}	113	0
140/STM-1	10^{-12}	108	0
STM-4	10^{-12}	27	0
STM-4	10^{-13}	270	0

Table G.1b: Packet data rates - Zero errors recording times

Bit rate under test (see note) (Mbit/s)	RBBER objective	Minimum recording time (full loading) (see note) (minutes)	Errors
10	10^{-10}	17	0
100	10^{-11}	17	0
100	3×10^{-12}	57	0
1 000	10^{-12}	17	0

NOTE: In case the actual System Capacity (SC) does not allow Full Load Capacity (FLC) the recording time will be increased by a factor FLC/SC (e.g. for a 10baseT load transported on a 8 Mbit/s system rate the recording time will become $17 \times 10/8 \approx 21$ minutes).

G.2 Measurement test set for XPI characteristics

In figure G.1, a measurement set-up is defined that allows simulating wanted signals affected by flat and/or dispersive fading conditions in the presence of XPI (Cross Polar Interference) where level and phase can be varied.

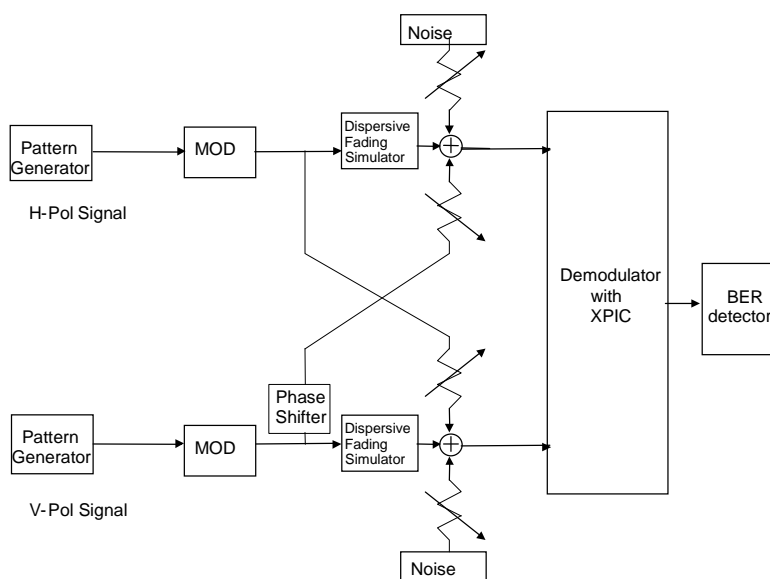

Figure G.1: IF measurement test set

When only not-dispersive tests are considered, an alternative, full RF, test set-up, that allows to simulate wanted signals affected by flat fading conditions in presence of cross polar interference, which level and phase can also be varied, may be used as shown in figure G.2.

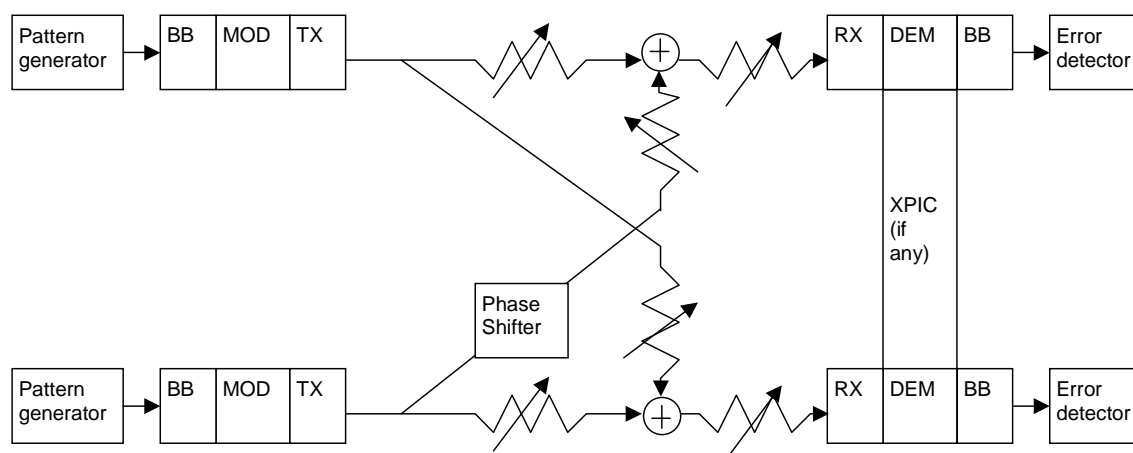

Figure G.2: RF measurement test set

G.3 Differential delay compensation range

When frequency diversity function is integrated within the radio equipment it is desirable to provide the means to compensate for differential absolute delays due to antennas, feeders, cable connections, and relative velocities on different RF channels.

The range of adjustment of differential absolute delay in the order of about 600 ns with a minimum step size equivalent to the symbol period is considered adequate for most applications.

G.4 FER/BER equivalence and FER performance measurement equipment settings (example)

G.4.1 FER/BER equivalence

FER and BER can be translated as described herein. Ethernet frames can range from 64 octets up to 1 522 octets. We use 64 octet frames for this proposal. An Ethernet frame is considered errored if at least one bit in the frame is errored. Assuming a uniform distribution, the probability of having exactly one errored bit in a 64 octet frame is:

$$P = p \times (1 - p)^{64 \times 8 - 1} \times (64 \times 8) \quad \text{where } p = \text{BER}$$

The probability that a frame contains exactly two errors is:

$$P = p^2 \times (1 - p)^{64 \times 8 - 2} \times (64 \times 8)(64 \times 8 - 1)/2$$

From these formulas we can determine the following probabilities and FER.

Table G.2: FER/BER equivalence

Channel BER	Probability of 1 bit error per frame	Probability of 2 bit errors per frame	FER
1×10^{-6}	5×10^{-4}	1×10^{-7}	5×10^{-4}
1×10^{-8}	5×10^{-6}	1×10^{-11}	5×10^{-6}
1×10^{-10}	5×10^{-8}	1×10^{-15}	5×10^{-8}
1×10^{-12}	5×10^{-10}	1×10^{-19}	5×10^{-10}

G.4.2 FER equipment settings and measurement techniques (example)

Equipment used: IEEE 802.3 [23] compliant Ethernet frame test equipment.

The transmitting Ethernet port of the test equipment should be configured to the following settings:

- Mode: Single burst.
- Count: 10 000 000 frames.
- Length: Fixed, 64 bytes.
- Interspaced Gap: 0,96 μ s for 100 Mbit/s, 9,6 μ s for 10 Mbit/s.

FER can be calculated by the following formula after using the above measurements:

- $FER = 1 - (\text{number of non-errored frames received}) / (\text{number of frames transmitted})$.

For example if 50 frames are lost or errored then the number of non-errored frames indicated by the test equipment will be 9 999 950. The resulting $FER = 1 - 9\,999\,950 / 10\,000\,000 = 5 \times 10^{-6}$.

G.5 Automatic Transmitter Power Control (ATPC)

Automatic Transmitter Power Control (ATPC) may be useful in some circumstances, e.g.:

- To reduce interference between neighbouring systems or adjacent channels of the same system.
- To improve compatibility with analogue and digital systems at nodal stations.
- As a mitigation factor for improving sharing with other services.
- To improve residual BER or BBER performance.
- To reduce up-fading problems.
- To reduce transmitter power consumption.
- To reduce digital to digital and digital to analogue distant interference between hops which re-use the same frequency.
- To increase system gain as a countermeasure against rainfall attenuation.
- In frequency bands where multipath is the dominant propagation factor, to improve adjacent channel protection to differential fading conditions caused by operation of adjacent channels on different antennas on parallel routes (e.g. operated by different operators).

According to the definitions of ATPC power conditions in clause 3.1 of EN 302 217-1 [15], ATPC, as an optional feature, is aimed at driving the TX power amplifier output level from a proper "minimum power" which facilitates the radio network planning requirements and which is used under normal propagation conditions up to a "maximum nominal power" value which fulfils all the specifications defined in the present document.

ATPC may also be used to increase the output power above the "maximum nominal power" up to a "maximum available power" specified by the supplier, with the agreement of administrations and operators, during fading conditions. Therefore, when ATPC is disabled, the nominal output power for stable operation is lower than the maximum in dynamic operation with ATPC enabled; this can be useful because in frequency ranges above 13 GHz the main limiting factors are given by non selective fading events.

In some systems ATPC may be employed as a fixed feature (i.e. the ATPC may not be disabled) in order to reach a higher nominal system gain (i.e. defined by the "maximum available power").

For planning considerations in a nodal environment a system equipped with ATPC can be considered to operate at "minimum power".

Care should be taken of the fact that the use of ATPC increases the percentage of time in which the system operates at low receiver signal level; it may be preferable that the threshold of ATPC intervention is designed to be in a RSL region where the BBER is still met, so that, even if the system would remain at constant RSL for higher percentage of time, an increase of Errored Blocks (EB), Background Block Error Ratio (BBER) or Residual BER (RBER) objectives is avoided with respect to a system without ATPC function enabled; additional information may be found in TR 101 036-1 [i.1].

Annex H (informative): Mitigation techniques referred in ERC/DEC/(00)07 (18 GHz band)

In accordance to the ERC/DEC/(00)07 [3] the FS should, where practical, implement the following mitigation techniques:

- a) Automatic Transmitter Power Control: to be applied in the whole band, to all new equipment installed after the 1st January 2003 (see note).
- b) EIRP limited to the minimum necessary to fulfil the performance objectives of the fixed link.
- c) Antennas: Use of high performance (low sidelobe) antennas in areas of dense FS deployment.

NOTE: This date is subject to review in light of market development of FS and FSS in this band.

Equipment suppliers should consult national regulatory authorities to know which mitigation techniques may need to be implemented (which in some cases are presented also in ERO web site: <http://www.ero.dk>).

History

Document history		
V1.1.3	December 2004	Publication
V1.2.1	June 2007	Publication
V1.3.1	September 2009	One-step Approval Procedure OAP 20100117: 2009-09-19 to 2010-01-18
V1.3.1	January 2010	Publication