

ETSI EN 301 277 V1.2.1 (2001-02)

European Standard (Telecommunications series)

**Fixed Radio Systems;
Point-to-point equipment;
High capacity digital radio systems transmitting STM-4
or 4 x STM-1 in a 40 MHz radio frequency channel using
Co-Channel Dual Polarized (CCDP) operation**



Reference

REN/TM-04111-01

Keywordsdigital, DRRS, radio, SDH, STM, transmission,
point-to-point**ETSI**

650 Route des Lucioles
F-06921 Sophia Antipolis Cedex - FRANCE

Tel.: +33 4 92 94 42 00 Fax: +33 4 93 65 47 16

Siret N° 348 623 562 00017 - NAF 742 C
Association à but non lucratif enregistrée à la
Sous-Préfecture de Grasse (06) N° 7803/88

Important notice

Individual copies of the present document can be downloaded from:

<http://www.etsi.org>

The present document may be made available in more than one electronic version or in print. In any case of existing or perceived difference in contents between such versions, the reference version is the Portable Document Format (PDF). In case of dispute, the reference shall be the printing on ETSI printers of the PDF version kept on a specific network drive within ETSI Secretariat.

Users of the present document should be aware that the document may be subject to revision or change of status. Information on the current status of this and other ETSI documents is available at <http://www.etsi.org/tb/status/>

If you find errors in the present document, send your comment to:
editor@etsi.fr

Copyright Notification

No part may be reproduced except as authorized by written permission.
The copyright and the foregoing restriction extend to reproduction in all media.

© European Telecommunications Standards Institute 2001.
All rights reserved.

Contents

Intellectual Property Rights	5
Foreword.....	5
1 Scope.....	6
2 References.....	6
3 Symbols and abbreviations.....	8
3.1 Symbols.....	8
3.2 Abbreviations.....	9
4 General characteristics	9
4.1 Frequency bands and channel arrangements.....	9
4.2 Modes of operation.....	10
4.3 Compatibility requirements.....	10
4.4 Performance and availability requirements.....	10
4.5 Environmental conditions	10
4.5.1 Equipment within weather protected locations (indoor locations).....	10
4.5.2 Equipment for non-weather protected locations (outdoor locations).....	10
4.6 Mechanical dimensions	10
4.7 Power supply.....	11
4.8 Electromagnetic Compatibility (EMC).....	11
4.9 TMN interfaces	11
4.10 Block diagram.....	11
4.11 Branching / feeder / antenna requirements.....	12
4.11.1 Antenna radiation pattern	12
4.11.2 Antenna cross-polar discrimination	12
5 SDH baseband characteristics	12
6 Transmitter characteristics	12
6.1 Output power	12
6.2 Automatic Transmit Power control (ATPC).....	13
6.3 Remote Transmit Power Control (RTPC).....	13
6.4 RF spectrum masks	14
6.5 Discrete CW lines exceeding the spectrum mask limit.....	16
6.5.1 Spectral lines at the symbol rate	16
6.5.2 Other spectral lines	16
6.6 Spurious emissions.....	17
6.6.1 Spurious emissions-External	17
6.6.2 Spurious emissions-Internal.....	17
6.7 Radio frequency tolerance	17
6.8 Return loss	18
6.9 Intermodulation products.....	18
7 Receiver characteristics.....	18
7.1 Local oscillator frequency tolerance.....	18
7.2 Receiver image rejection	18
7.3 Spurious emissions.....	18
7.3.1 Spurious emissions-External	18
7.3.2 Spurious emissions-Internal.....	18
7.4 Input level range.....	18
7.5 Return loss	19
8 System performance without diversity	19
8.1 Equipment background BER.....	19
8.2 BER as a function of receive input level (dBm).....	19
8.3 Interference sensitivity	20
8.3.1 Co-channel "external" interference sensitivity.....	20

8.3.2	Adjacent channel interference sensitivity	21
8.4	Distortion sensitivity	21
8.5	Sensitivity to dynamic fading.....	21
9	System characteristics with diversity	22
9.1	Differential delay compensation	22
9.2	BER performance.....	22
9.3	Interference sensitivity	22
9.4	Distortion sensitivity	22
10	Cross polar interference sensitivity.....	23
10.1	Co-channel "internal" interference sensitivity in flat fading conditions	23
10.2	Co-channel "internal" interference sensitivity in dispersive fading conditions	23
Annex A (informative): Additional information		24
A.1	ATPC	24
A.2	Branching, feeder and antenna	24
A.2.1	Antenna radiation pattern envelopes	24
A.2.2	Cross-polar discrimination (XPD).....	24
A.2.3	Interport isolation	24
A.2.4	Feeder / antenna return loss	24
A.3	Compatibility.....	25
A.4	Mechanical requirements	25
Annex B (informative): Bibliography.....		26
History		27

Intellectual Property Rights

IPRs essential or potentially essential to the present document may have been declared to ETSI. The information pertaining to these essential IPRs, if any, is publicly available for **ETSI members and non-members**, and can be found in ETSI SR 000 314: "*Intellectual Property Rights (IPRs); Essential, or potentially Essential, IPRs notified to ETSI in respect of ETSI standards*", which is available from the ETSI Secretariat. Latest updates are available on the ETSI Web server (<http://www.etsi.org/ipr>).

Pursuant to the ETSI IPR Policy, no investigation, including IPR searches, has been carried out by ETSI. No guarantee can be given as to the existence of other IPRs not referenced in ETSI SR 000 314 (or the updates on the ETSI Web server) which are, or may be, or may become, essential to the present document.

Foreword

This European Standard (Telecommunications series) has been produced by ETSI Technical Committee Transmission and Multiplexing (TM).

The former title of the present document was: "Transmission and Multiplexing (TM); Digital Radio Relay Systems (DRRS); High capacity DRRS transmitting STM-4 or 4 x STM-1 in a 40 MHz radio frequency channel using Co-Channel Dual Polarized (CCDP) operation".

National transposition dates	
Date of adoption of this EN:	9 February 2001
Date of latest announcement of this EN (doa):	31 May 2001
Date of latest publication of new National Standard or endorsement of this EN (dop/e):	30 November 2001
Date of withdrawal of any conflicting National Standard (dow):	30 November 2001

1 Scope

The present document defines technical parameters for a high capacity Digital Radio Relay System (DRRS) operating in frequency bands with 40 MHz channel spacing e.g. the 4 GHz, 5 GHz, U 6 GHz and 11 GHz bands. The capacity should be STM-4 or $4 \times$ STM-1 per 40 MHz RF-channel by using both polarizations in the co-channel dual polarized (CCDP) mode of operation.

The area of application of these DRRS is foreseen to be in regional and trunk networks forming part of a SDH-network including STM-4 rings.

Systems considered in the present document should be able to respect ITU-R high grade performance objectives.

The systems considered should operate in these networks having regard for existing hop length, which are considered to be normally up to about 30 km to 40 km for regional and about 60 km for trunk networks, respectively. Hop lengths greater than this latter length are used in special applications.

For information about compatibility with other systems see clause A.3.

The parameters specified fall into two categories:

- a) Those that are required to provide compatibility between channels from different sources of equipment on the same route connected to separate antennas.

NOTE: Equipment supplied by different manufacturers on the same path or existing radio-relay systems operate on different frequencies.

- b) Parameters defining the transmission quality of the proposed system.

The standardization deals with baseband and RF characteristics relevant to SDH. Antenna/feeder system requirements are also considered.

Baseband interfaces have to be considered for STM-1 signals and STM-4 signals in accordance with ITU-T Recommendations G.707 [6] and G.957 [21] respectively.

2 References

The following documents contain provisions, which, through reference in this text, constitute provisions of the present document.

- References are either specific (identified by date of publication, edition number, version number, etc.) or non-specific.
- For a specific reference, subsequent revisions do not apply.
- For a non-specific reference, subsequent revisions do apply.

- [1] ITU-R Recommendation F.384-6 (1995): "Radio-frequency channel arrangements for medium and high capacity analogue or digital radio-relay systems operating in the upper 6 GHz band".
- [2] ITU-R Recommendation F.387-7 (1995): "Radio-frequency channel arrangements for radio-relay systems operating in the 11 GHz band".
- [3] ITU-R Recommendation F.635-4 (1997): "Radio-frequency channel arrangements based on a homogeneous pattern for radio-relay systems operating in the 4 GHz band".
- [4] ITU-R Recommendation F.750-3 (1997): "Architectures and functional aspects of radio-relay systems for SDH-based networks".
- [5] ITU-R Recommendation F.1099-2 (1997): "Radio-frequency channel arrangements for high-capacity digital radio-relay systems in the 5 GHz (4 400 MHz to 5 000 MHz) band".

- [6] ITU-T Recommendation G.707 (1996): "Network node interface for the synchronous digital hierarchy (SDH)".
- [7] ITU-R Recommendation SM.329-7 (1997): "Spurious Emissions".
- [8] ITU-T Recommendation G.773 (1993): "Protocol suites for Q-interfaces for management of transmission systems".
- [9] ITU-T Recommendation G.784 (1999): "Synchronous digital hierarchy (SDH) management".
- [10] ETSI ETS 300 019 (all parts): "Equipment engineering (EE); Environmental conditions and environmental tests for telecommunications equipment".
- [11] ETSI ETS 300 119 (all parts): "Equipment engineering (EE); European telecommunication standard for equipment practice".
- [12] ETSI EN 300 385: "Electromagnetic compatibility and Radio spectrum Matters (ERM); ElectroMagnetic Compatibility (EMC) standard for fixed radio links and ancillary equipment".
- [13] ETSI ETS 300 132 (all parts): "Equipment Engineering (EE); Power supply interface at the input to telecommunications equipment".
- [14] ETSI ETS 300 635: "Transmission and Multiplexing (TM); Synchronous Digital Hierarchy (SDH); Radio specific functional blocks for transmission of M x STM-N".
- [15] ETSI EN 300 833: "Fixed Radio Systems; Point to Point Antennas; Antennas for point-to-point fixed radio systems operating in the frequency band 3 GHz to 60 GHz".
- [16] ITU-T Recommendation G.703 (1991): "Physical/electrical characteristics of hierarchical digital interfaces".
- [17] ITU-R Recommendation F.1191-1 (1997): "Bandwidths and unwanted emissions of digital radio-relay systems".
- [18] ITU-T Recommendation O.151 (1992): "Error performance measuring equipment operating at the primary rate and above".
- [19] ITU-T Recommendation O.181 (1996): "Equipment to assess error performance on STM-N interfaces".
- [20] ITU-T Recommendation G.783 (1997): "Characteristics of synchronous digital hierarchy (SDH) equipment functional blocks".
- [21] ITU-T Recommendation G.957 (1995): "Optical interfaces for equipments and systems relating to the synchronous digital hierarchy".
- [22] ETSI TR 101 035: "Transmission and Multiplexing (TM); Synchronous Digital Hierarchy (SDH) aspects regarding Digital Radio Relay Systems (DRRS)".
- [23] ITU-R Recommendation F.695 (1990): "Availability objectives for real digital radio-relay links forming part of a high-grade circuit within an integrated services digital network".
- [24] ITU-R Recommendation F.1092-1 (1997): "Error performance objectives for constant bit rate digital path at or above the primary rate carried by digital radio-relay systems which may form part of the international portion of a 27 500 km hypothetical reference path".
- [25] ITU-R Recommendation F.1189-1 (1997): "Error performance objectives for constant bit rate digital paths at or above the primary rate carried by digital radio-relay systems which may form part or all of the national portion of a 27 500 km hypothetical reference path".
- [26] ITU-R Recommendation F.557-4 (1997): "Availability objective for radio-relay systems over a hypothetical reference circuit and a hypothetical reference digital path".
- [27] ITU-T Recommendation G.826 (1996): "Error performance parameters and objectives for international, constant bit rate digital paths at or above the primary rate".

- [28] ITU-T Recommendation G.827 (1996): "Availability parameters and objectives for path elements of international constant bit-rate digital paths at or above the primary rate".
- [29] ITU-R Recommendation F.752-1 (1994): "Diversity techniques for radio-relay systems".
- [30] ITU-R Recommendation F.1093-1 (1997): "Effects of multipath propagation on the design and operation of line-of-sight digital radio-relay systems".
- [31] ITU-R Recommendation F.1101 (1994): "Characteristics of digital radio-relay systems below about 17 GHz".
- [32] ETSI EN 301 127: "Fixed Radio Systems; Point-to-point equipment; High capacity digital radio systems carrying SDH signals (2 x STM-1) in frequency bands with about 30 MHz channel spacing and using Co-Channel Dual Polarized (CCDP) operation".
- [33] CEPT/ERC Recommendation 12-08: "Harmonized radio frequency channel arrangements and block allocations for low, medium and high capacity systems in the band 3 600 MHz to 4 200 MHz".
- [34] CEPT/ERC Recommendation 14-02: "Radio-frequency channel arrangements for medium and high capacity analogue or high capacity digital radio-relay systems operating in the band 6 425 MHz to 7 125 MHz".
- [35] CEPT/ERC Recommendation 12-06: "Harmonized radio frequency channel arrangements for digital terrestrial fixed systems operating in the band 10,7 GHz to 11,7 GHz".
- [36] ETSI ETR 019: "Transmission and Multiplexing (TM); Specification of new generation high-capacity digital radio systems carrying 2 x STM-1 Synchronous Digital Hierarchy (SDH) signals in frequency bands with 40 MHz channel spacing".
- [37] ETSI TR 101 127: "Transmission and Multiplexing (TM); Digital Radio Relay Systems (DRRS); Synchronous Digital Hierarchy (SDH); High capacity DRRS carrying SDH signals (1 x STM-1) in frequency bands with about 30 MHz channel spacing and using Co-Channel Dual Polarized (CCDP) operation".
- [38] CEPT/ERC Recommendation 74-01: "Spurious emissions".

3 Symbols and abbreviations

3.1 Symbols

For the purposes of the present document, the following symbols apply:

dB	decibel
dBm	decibel relative to 1 mW
GHz	GigaHertz
km	kilometre
Mbit/s	Mega-bit per second
MHz	MegaHertz
m/s	metres per second
ppm	parts per million
ns	nanosecond
W/m ²	Watts per square metre

3.2 Abbreviations

For the purposes of the present document, the following abbreviations apply:

ATPC	Automatic Transmit Power Control
BER	Bit Error Rate
C/I	Carrier to Interference ratio
CCDP	Co-Channel Dual Polarized
CSmin	minimum practical Channel Separation (for a given radio-frequency channel arrangement)
IF	Intermediate Frequency
NFD	Net Filter Discrimination
PDH	Plesiochronous Digital Hierarchy
QAM	Quadrature Amplitude Modulation
RCSOH	Radio Complementary Sectra OverHeat
RF	Radio Frequency
RFCOH	Radio Frame Complementary OverHeat
RX	Receiver
SDH	Synchronous Digital Hierarchy
SOH	Section OverHead
STM-1	Synchronous Transport Module Level 1 (155,52 Mbit/s)
STM-4	Synchronous Transport Module Level 4 (622 Mbit/s)
TMN	Telecommunication Management Network
TX	Transmitter
U6	Upper 6 (GHz frequency band)
XIF	Cross polarization improvement factor due to XPIC operation
XPD	Cross Polar Discrimination
XPI	Cross Polar Interference
XPIC	Cross Polar Interference Canceller

4 General characteristics

4.1 Frequency bands and channel arrangements

The system shall be required to operate in the following frequency bands, according to the specified CEPT and ITU-R Recommendations on the quoted channel spacings.

4 GHz

CEPT/ERC Recommendation 12-08 [33], annex A, Part 1 with 40 MHz channel spacing ITU-T Recommendation G.826 [27] and ITU-R Recommendation F.635-4 [3] with 40 MHz channel spacing. The centre gap between transmitters and receivers in ITU-R Recommendation F.635-4 [3] is 80 MHz.

5 GHz

ITU-R Recommendation F.1099-2 [5] with 40 MHz channel spacing. The centre gap between transmitters and receivers in ITU-R Recommendation F.1099-2 [5] is 60 MHz.

U 6 GHz

CEPT/ERC Recommendation 14-02 [34] and ITU-R Recommendation F.384-6 [1] with 40 MHz channel spacing. The centre gap between transmitters and receivers in ITU-R Recommendation F.384-6 [1] is 60 MHz.

11 GHz

CEPT/ERC Recommendation 12-06 [35] and ITU-R Recommendation F.387-7 [2] with 40 MHz channel spacing. The centre gap between transmitters and receivers in ITU-R Recommendation F.387-7 [2] is 130 MHz.

4.2 Modes of operation

The mode of operation should be Co-Channel Dual Polarized (CCDP) for all frequency bands up to and including 11 GHz.

In defining system characteristics of CCDP systems, the additional losses introduced by branching networks shall be taken into account. Depending on the implementation (split branching for even and odd channels followed by a 3 dB loss hybrid put at reference point C and/or C', narrow band RF filters concept or others) additional losses ranging from 3 dB to 6 dB shall be considered in evaluating the available net system gain.

When narrow-band RF filters are used losses affect directly receiver thresholds at reference point B. As a consequence this shall be taken into account in specifying receiver threshold limits.

4.3 Compatibility requirements

There shall be no requirement to operate transmitting equipment from one manufacturer with receiving equipment from another.

4.4 Performance and availability requirements

Equipment shall be designed in order to meet network performance and availability requirements foreseen by ITU-R Recommendations F.695 [23], F.1092-1 [24], F.1189-1 [25] and F.557-4 [26] following the criteria defined in ITU-T Recommendations G.826 [27] and G.827 [28] for the international or national portion of the digital path.

The implication of the link design on the performance is recognized and the general design criteria reported in ITU-R Recommendations F.752-1 [29], F.1093-1 [30], F.1101 [31], F.1092-1 [24] and F.1189-1 [25] are to be applied.

4.5 Environmental conditions

The equipment shall be required to meet the environmental conditions set out in ETS 300 019 [10] which defines weather protected and non-weather protected locations, classes and test severity.

The manufacturer shall state which class the equipment is designed to withstand.

4.5.1 Equipment within weather protected locations (indoor locations)

The equipment intended for operation within temperature controlled locations or partially temperature controlled locations shall meet the requirements of ETS 300 019 [10] subclasses 3.1 and 3.2 respectively.

Optionally, the more stringent requirements of ETS 300 019 [10] subclasses 3.3 (non-temperature controlled locations), 3.4 (sites with heat trap) and 3.5 (sheltered locations) may be applied.

4.5.2 Equipment for non-weather protected locations (outdoor locations)

Equipment intended for operation within non-weather protected locations shall meet the requirements of ETS 300 019 [10] class 4.1 or 4.1E.

Class 4.1 applies to many European countries and class 4.1E applies to all European countries.

For systems supplied within a specific radio cabinet which gives full protection against precipitation, wind, etc. the ETS 300 019 [10] subclasses 3.3, 3.4 and 3.5 may be applied also for equipment intended for operation in non-weather protected locations.

4.6 Mechanical dimensions

See clause A.4.

4.7 Power supply

The power supply interface shall be in accordance with the characteristics of one or more of the secondary voltages foreseen in ETS 300 132 [13].

4.8 Electromagnetic Compatibility (EMC)

Fixed Services equipment with capacity of about 2 Mbit/s and above shall operate under the conditions specified in EN 300 385 [12].

4.9 TMN interfaces

TMN interface, if any, should be in accordance with ITU-T Recommendation G.773 [8].

NOTE: The standardization of TMN interface functionalities is under responsibility and development in ETSI TC/TMN, and will be applicable to the radio relay systems considered in the present document.

4.10 Block diagram

The reference points are shown in figure 1. These points are reference points only and not necessarily measurement points.

The receiver diversity path shown in the block diagram refers only to combining techniques.

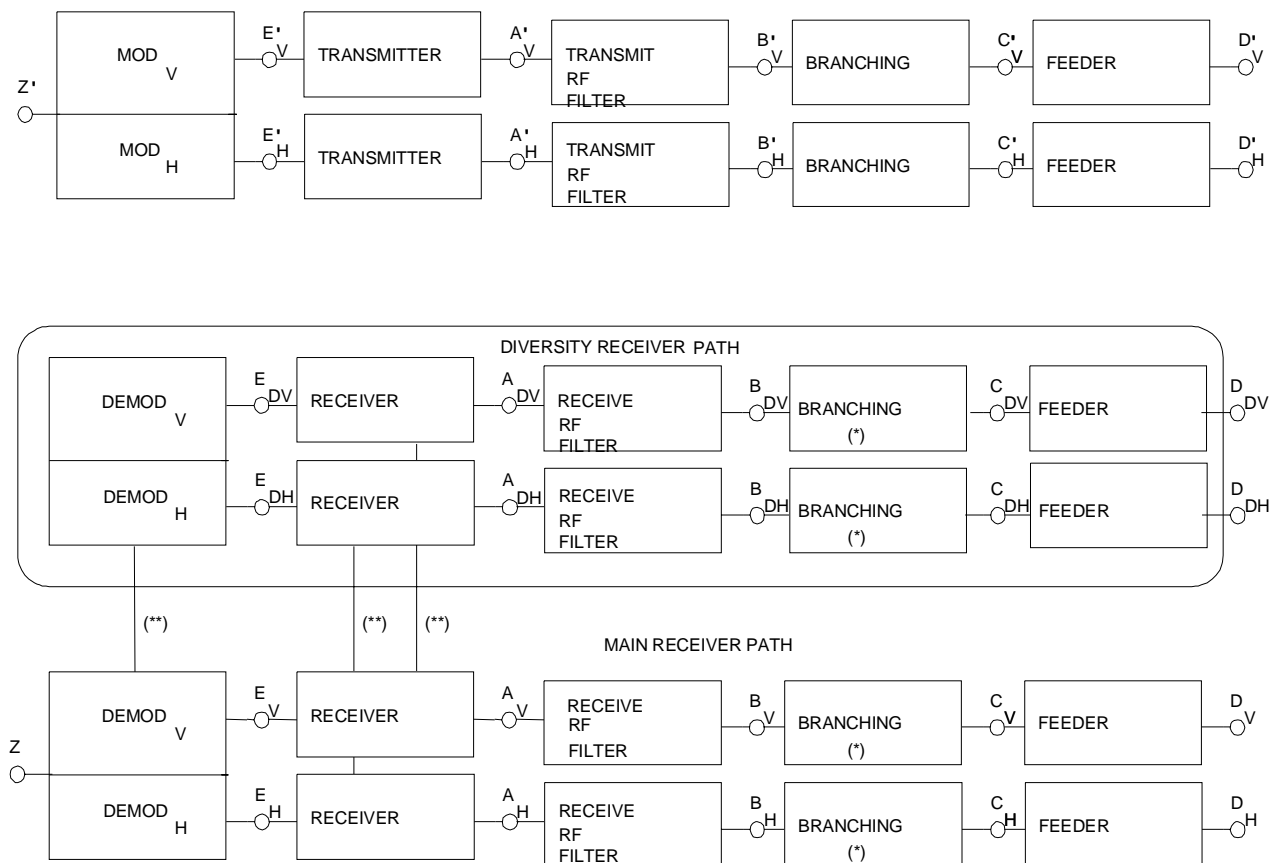

NOTE: A STM-4 or 4 x STM-1 interface is used at Z and Z'.
 (*) No filter included.
 (**) Connection at RF, if or baseband.

Figure 1: Block Diagram

4.11 Branching / feeder / antenna requirements

Antennas required system specified in the present document shall comply with EN 300 833 [15].

The class of antennas considered as prerequisite for this system are stated in annex A.

4.11.1 Antenna radiation pattern

See annex A.

4.11.2 Antenna cross-polar discrimination

See annex A.

5 SDH baseband characteristics

The SDH baseband interface shall be in accordance with ITU-T Recommendations G.703 [16], G.707 [6], G.783 [20], G.784 [9], G.957 [21] and ETS 300 635 [14].

One or more of the following baseband interfaces shall be implemented:

- STM-4 optical interface (ITU-T Recommendation G.957 [21]);
- 4 × STM-1 optical interface (ITU-T Recommendation G.957 [21]);
- 4 × STM-1 CMI electrical interface (ITU-T Recommendation G.703 [16]).

The use of reserved bytes contained in the SOH, and their termination shall be in accordance with ITU-R Recommendation F.750-3 [4]. Further details on the possible use of the SOH bytes including additional RFCOH or RCSOH are given in TR 101 035 [22].

6 Transmitter characteristics

The specified transmitter characteristics shall be met with the appropriate baseband signals applied at point Z' of figure 1. For the PDH interface this shall be in accordance with ITU-T Recommendation O.151 [18] and for SDH interfaces in accordance with ITU-T Recommendation O.181 [19].

6.1 Output power

The value of the nominal output power referred to point B' shall be in one of the ranges shown in table 1 not including the ATPC.

Table 1: Nominal Output power ranges

class A	+26 dBm	+31 dBm
class B	+31 dBm	+36 dBm
class C	+36 dBm	+41 dBm

The tolerance for the nominal value shall be equal or less than ± 1 dB.

The maximum nominal value shall be declared by the manufacturer.

6.2 Automatic Transmit Power control (ATPC)

ATPC is an optional feature. Equipment with ATPC will be subject to manufacturer declaration of the ATPC ranges and related tolerances. Testing shall be carried out with output power level corresponding to:

- ATPC set manually to a fixed value for System performance;
- ATPC set at maximum provided output power for Tx performance.

6.3 Remote Transmit Power Control (RTPC)

RTPC is an optional feature. Equipment with RTPC will be subject to manufacturer declaration of the RTPC ranges and related tolerances. Testing shall be carried out with output power level corresponding to:

- RTPC set manually to the maximum and to the minimum values for System performance;
- RTPC set at maximum provided output power for Tx performance;
- RF spectrum mask shall be verified at three points (lower, medium, and upper part of the frequency band envisaged), if applicable. Tx power control shall be set to the maximum value.

6.4 RF spectrum masks

The three main factors considered in recommending a mask are as follows:

- control of interference into analogue channels operating on the adjacent channel allocation;
- control of interference into digital channels between systems of different manufacturers operating on the adjacent channel allocation;
- different transmitter characteristics.

The RF emitted spectrum masks, for the various frequency bands are shown in figures 2A and 2B.

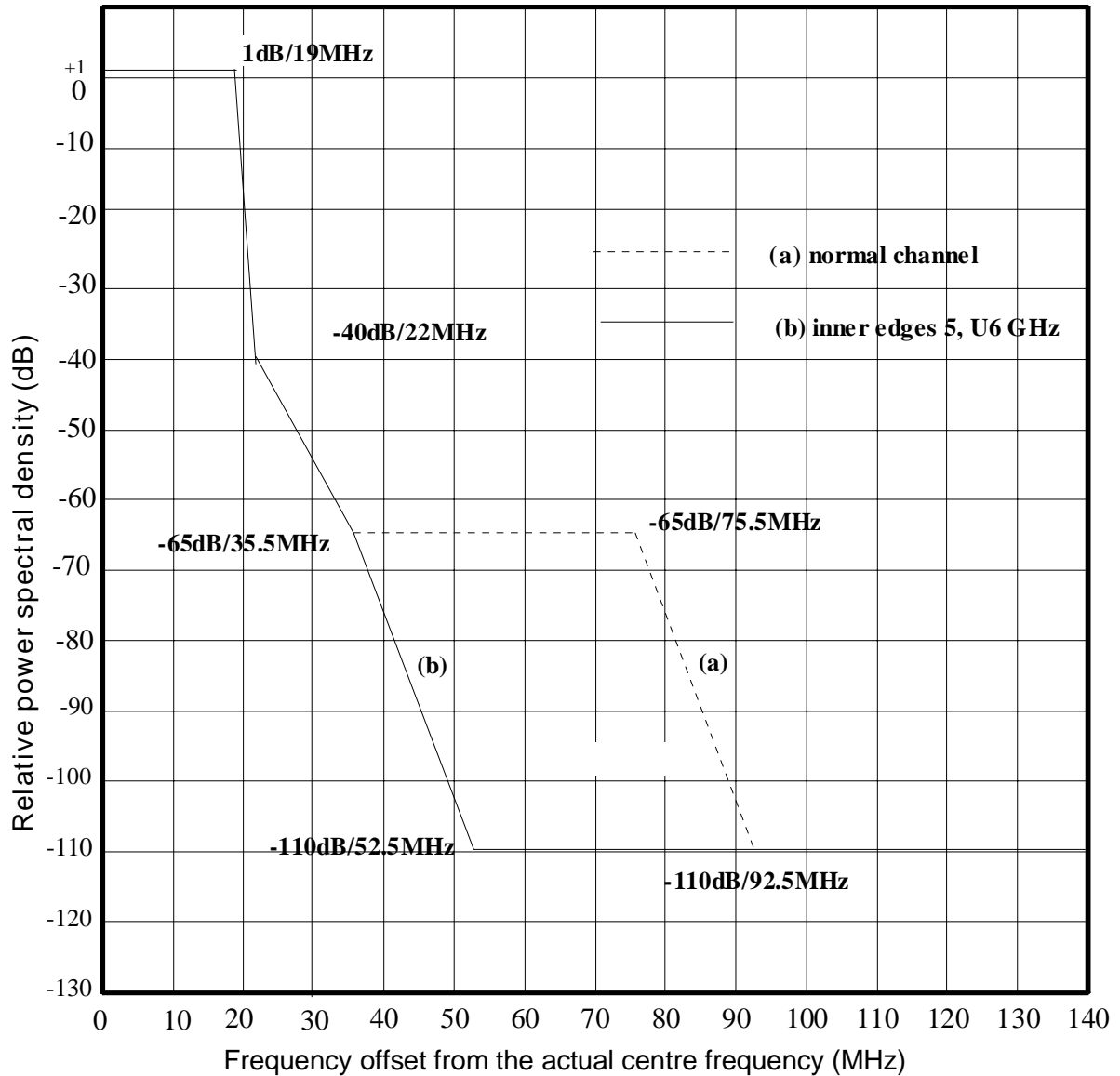

NOTE: Frequency tolerance not included in the mask.

Figure 2A: Limits of power spectral density for all channels referred to point B'

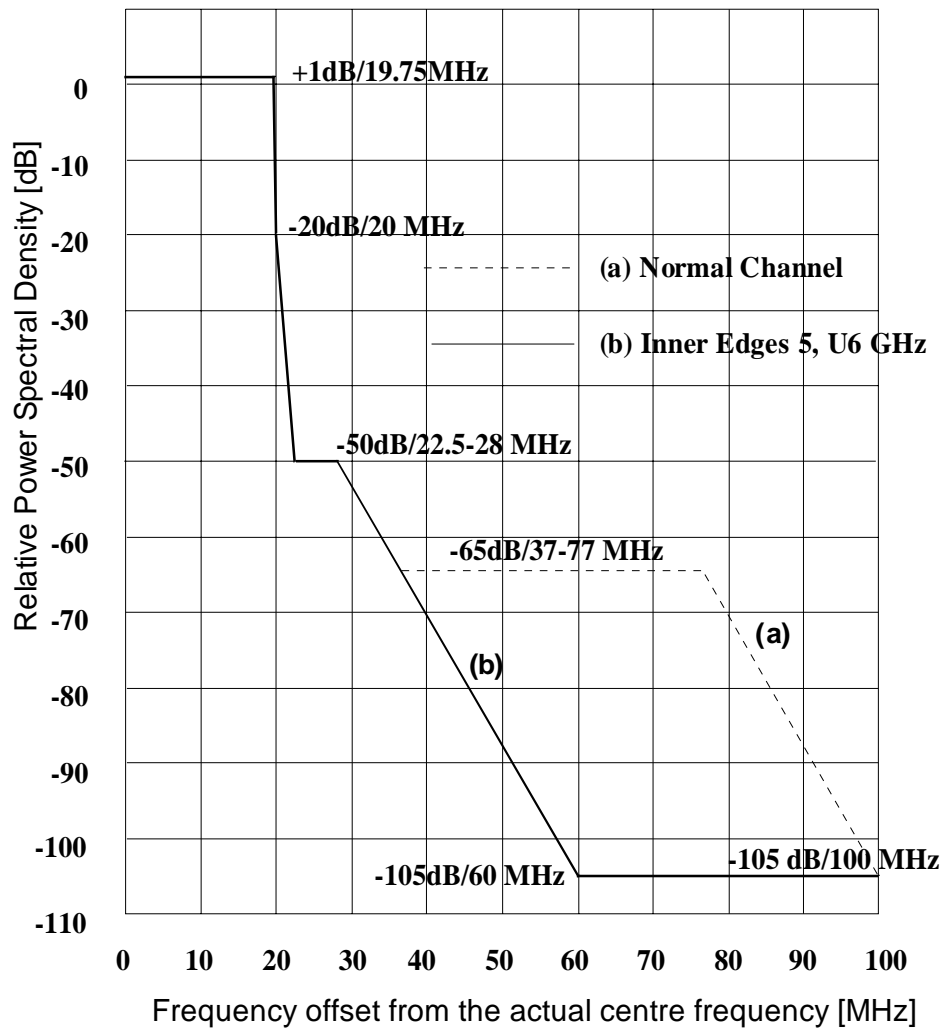

NOTE: Frequency tolerance not included in the mask.

Figure 2B: Limits of power spectral density for all channels referred to point B'

The mask depicted in figure 2A shall apply to a "single-carrier system" transmitting two STM-1 signals per carrier and polarization.

The mask depicted in figure 2B shall apply to a "multi-carrier system" splitting the bitrate for transmission via two or more carriers per polarization.

The spectrum masks in figures 2A and 2B shall be verified directly by measurement (referenced to point B') up to 65 dB. Since it is not possible to measure attenuation values up to 110 dB directly, values above 65 dB should be verified by adding a measured filter characteristic to the spectrum measured at reference point A'.

The masks should be measured for a fully loaded system loaded with STM-4 or $4 \times$ STM-1 at the baseband interface and the output power set to its nominal value. The masks shall apply for either polarization.

NOTE: Actual systems should provide a NFD of 48 dB that could be derived from direct computation or measurement on the actual emitted spectrum.

The Spectrum Analyser settings for application to the RF spectrum mask are defined as follows:

- IF Bandwidth 100 kHz;
- Total Sweep Width 100 MHz;
- Total Scan Time 50 seconds;
- Video Filter Bandwidth 0,1 kHz.

6.5 Discrete CW lines exceeding the spectrum mask limit

6.5.1 Spectral lines at the symbol rate

The power level (reference point B') of spectral lines at a distance from the channel centre frequency equal to the symbol rate shall not be more than -37 dBm.

6.5.2 Other spectral lines

In case some CW components exceed the spectrum mask, an additional allowance is given.

Those lines shall not:

- exceed the mask by a factor more than $\{10 \log (CS_{\min}/IF_{bw}) - 10\}$ dB
- be spaced each other in frequency by less than CS_{\min}

Where:

$CS_{\min} = 10\ 000$ kHz for 4 GHz, 5 GHz, U6 GHz and 11 GHz bands.

IF_{bw} is the recommended resolution IF bandwidth, expressed in kHz, reported in clause 6.4.

Figure 2C shows a typical example of this requirement.

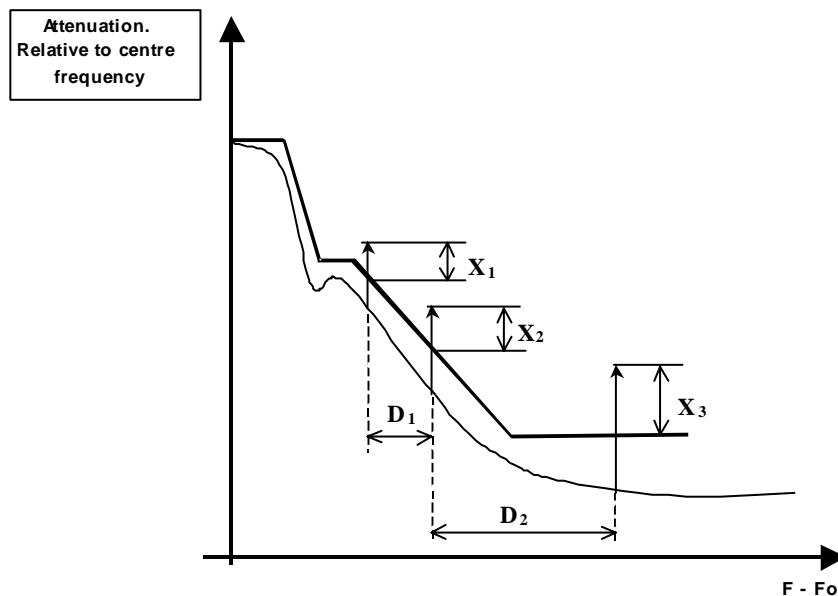

$$X_1, X_2, X_3 \text{ [dB]} \leq 10 \log (CS_{\min} / IF_{bw}) - 10$$

$$D_1, D_2 \geq CS_{\min}$$

Figure 2C: CW lines exceeding the spectrum mask (typical example)

6.6 Spurious emissions

It is necessary to define spurious emissions from transmitters for two reasons:

- a) to limit interference into systems operating wholly externally to the system (external emissions) which limits are referred by CEPT/ERC Recommendation 74-01 [38] based on ITU-R Recommendations SM.329-7 [7] and F.1191-1 [17];
- b) to limit local interference within the system where transmitters and receivers are directly connected via the filter and branching systems (internal emissions).

This leads to two sets of spurious emission limits where the specific limits given for "internal" interference are required to be no greater than the "external" level limits at reference point C'.

6.6.1 Spurious emissions-External

According to CEPT/ERC Recommendation 74-01 [38] the external spurious emissions are defined as emissions at frequencies which are removed from the nominal carrier frequency more than ± 250 % of the relevant channel separation.

Outside the band of ± 250 % of the relevant channel separation, the Fixed Service radio systems spurious emission limits, defined by CEPT/ERC Recommendation 74-01 [38] together with the frequency range to consider for conformance measurement, shall apply.

Within ± 250 % of the relevant channel spacing the emission includes only fundamental and out of band emissions which shall be in accordance with the spectrum mask and the limits required by clauses 6.4 and 6.5.

The limit values are at reference point C'.

6.6.2 Spurious emissions-Internal

The levels of the spurious emissions from the transmitter, referenced to point B' are specified in table 2.

Table 2

Spurious emission frequency relative to channel assigned frequency	Specification limit	Controlling factor for requirement application
$\pm 1F$ (local oscillator frequency)	< -60 dBm	Within half band digital to analogue
$\pm 2 \times IF$ (unwanted sideband)	< -90 dBm	Other half band digital into digital
$\pm 1F, \pm 3 \times IF$ (unwanted sideband at 2nd IF harmonic)	< -90 dBm	Other half band digital into digital
The level of all other spurious signals should be:		
	< -90 dBm	if spurious signal frequency falls within receiver half band
	< -60 dBm	if spurious signal frequency falls within transmitter half band

For digital systems without branching network (i.e. with duplexer) the -90 dBm limits for the spurious signals as given above shall be relaxed to -70 dBm.

6.7 Radio frequency tolerance

Radio frequency tolerance shall not exceed ± 20 ppm. This limit includes both short-term factors and long-term ageing effects. For the purpose of type testing the manufacturer shall state the guaranteed short-term part and the expected ageing part.

6.8 Return loss

For indoor systems, the minimum return loss shall be at least 26 dB within a frequency band of $\pm 0,5$ times the symbol rate of the system referred to the nominal centre frequency of the RF channel in use, measured at point C' in the direction to the system.

6.9 Intermodulation products

Each intermodulation product caused by different transmitters linked to the same antenna should be less than -110 dBm referenced to point C with an output power relevant to the classes A to C (see table 1) per transmitter.

7 Receiver characteristics

In specifying receiver characteristics, it is intended that the receiver under test shall operate as a part of the complete receiving system comprising all components, including the XPIC, which are necessary to receive STM-4 or $4 \times$ STM-1 transmitted via a 40 MHz channel by use of both polarizations.

No cross-polar interference shall be introduced before the receiver.

For receiver operation under XPI conditions see clause 10.

7.1 Local oscillator frequency tolerance

Radio frequency tolerance shall not exceed ± 20 ppm. This limit includes both short-term factors and long-term ageing effects. For the purpose of type testing the manufacturer shall state the guaranteed short-term part and the expected ageing part.

7.2 Receiver image rejection

If applicable, the receiver image rejection shall be > 100 dB.

7.3 Spurious emissions

7.3.1 Spurious emissions-External

At reference point C, the limit values of CEPT/ERC Recommendation 74-01 [38] shall apply.

7.3.2 Spurious emissions-Internal

Spurious emissions which fall within receivers half band shall be ≤ -110 dBm (referenced to point B).

7.4 Input level range

The lower limit for the receiver input level shall be given by the threshold level for $BER = 10^{-3}$. The upper limit for the receiver input level, where a BER of 10^{-3} may not be exceeded shall be -12 dBm, a BER of 10^{-10} may be exceeded for levels greater than -16 dBm. When ATPC is used the maximum input level for $BER < 10^{-3}$ and $BER < 10^{-10}$ may be relaxed to -27 dBm and -31 dBm respectively.

These limits should apply without interference and are referenced to point B.

7.5 Return loss

For indoor systems, the minimum return loss shall be at least 26 dB within a frequency band of $\pm 0,5$ times the symbol rate of the system referred to the nominal centre frequency of the Rf channel in use, measured at point C' in the direction to the system.

8 System performance without diversity

Specifications given in this clause shall be measured for a fully loaded system loaded with STM-4 or $4 \times$ STM-1 at the baseband interface. The BER shall be measured on the total STM-4 signal or anyone of the STM-1 signals.

No cross-polar interference shall be introduced during the test except where it is explicitly stated.

8.1 Equipment background BER

Equipment background BER is measured under simulated conditions over an artificial hop without interference, and with a signal level at point B which is between 15 dB and 40 dB above the lower level which gives $BER = 10^{-3}$ and with less than 5 dB difference between the polarizations. In a measurement period of 24 hours the number of bit errors shall be less than 10 per STM-1 signal transmitted and per hop ($BER \leq 10^{-12}$) or 40 per STM-4.

8.2 BER as a function of receive input level (dBm)

The reference point for the definition of the BER curve as a function of receiver input level is point B.

In table 3 the BER values given may be exceeded at signal levels lower than those specified. (In the present document these levels can therefore be considered as the minimum acceptable performance standard or, the maximum receiver threshold levels). The values of table 3 shall be measured with the same input level on both polarizations and with a fully loaded system, loaded with STM-4 or $4 \times$ STM-1 at the baseband interface.

Table 3: Receiver input level for various frequency bands

	Frequency band	
	4, 5, U6 GHz	11 GHz
BER = 10^{-3}	-63 dBm	-62 dBm
BER = 10^{-6}	-59 dBm	-58 dBm
BER = 10^{-10}	-54 dBm	-53 dBm
NOTE: These limits are required when the connection to the same antenna port of even and odd channels, spaced 40 MHz on the same polarization, is made with a 3 dB hybrid coupler placed at reference point C. When alternatively, for the above purpose, narrow-band branching filters solution is used, these limits may be 1,5 dB higher.		

8.3 Interference sensitivity

8.3.1 Co-channel "external" interference sensitivity

The following specification applies to "external" interferers from similar systems but from a different route (nodal interferer).

For the frequency bands given in clause 4.1 the limits of the co-channel interference sensitivity shall be as given in figure 3.

NOTE: Receiver input level degradation given in figure 3 is referred to the receiver input levels given in table 3.

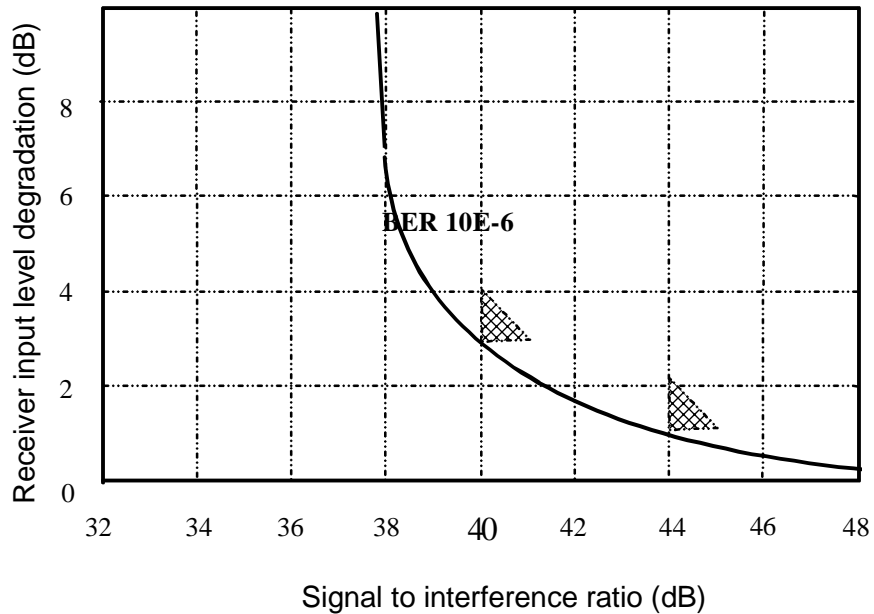

Figure 3: Co-channel "external" digital interference sensitivity limits referred to point B'

8.3.2 Adjacent channel interference sensitivity

For the frequency bands given in clause 4.1 the limits of the adjacent-channel interference sensitivity shall be as given in figure 4.

NOTE: Receiver input level degradation given in figure 4 is referred to the receiver input levels given in table 3.

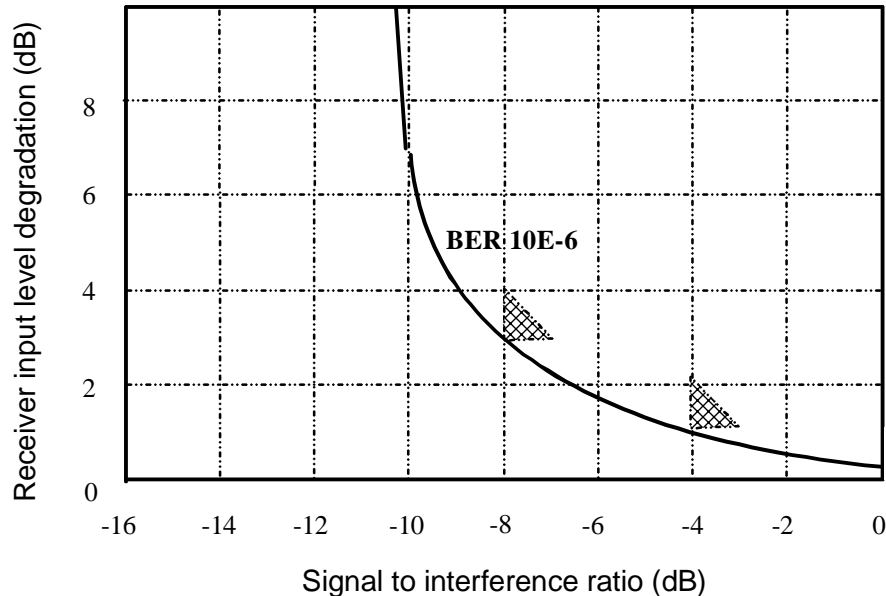

Figure 4: Adjacent channel digital interference sensitivity limits referred to point B'

8.4 Distortion sensitivity

Distortion shall be introduced in one polarization at the time and the error rate shall be measured for the total STM-4 or $4 \times$ STM-1 signal.

For a delay of 6,3 ns and a BER of 10^{-3} the width of the signature shall not exceed ± 25 MHz relative to the channel assigned frequency and the depth shall not be less than 16 dB.

For a delay of 6,3 ns and a BER of 10^{-6} the width of the signature shall not exceed ± 27 MHz relative to the channel assigned frequency and the depth shall not be less than 14 dB.

These limits are valid for both minimum and non-minimum phase conditions.

The limits specified for BER = 10^{-3} shall also be verified by the loss-of-synchronization and re-acquisition signatures.

8.5 Sensitivity to dynamic fading

Distortion shall be introduced in one polarization at the time and the error rate measured for the total STM-4 or $4 \times$ STM-1 signal.

A notch (6,3 ns delay) with a depth of 13 dB swept in the whole band (± 20 MHz) with a speed not less than 150 MHz/s shall not cause a BER greater than 10^{-6} .

A notch (6,3 ns delay) swept between 4 dB and 13 dB with a speed not less than 100 dB/s shall not cause a BER greater than 10^{-6} . The measurement shall be performed for constant notch frequencies within the whole band (± 20 MHz).

9 System characteristics with diversity

Space, angle and frequency diversity techniques are applicable. In this clause only combining techniques are considered.

9.1 Differential delay compensation

It shall be possible to compensate for differential absolute delays due to antennas, feeders and cable connections on the two diversity paths. The range of adjustment shall be at least 75 ns of differential absolute delay.

9.2 BER performance

When both receiver inputs (main and diversity, points B and B_D) are fed with input signals of the same signal level at an arbitrary phase difference, input level limits for specified BER values should be:

- 2,5 dB below for IF or baseband combining systems;
- 1,5 dB below for RF combining systems.

Those given in clause 8.2 for the case without diversity.

9.3 Interference sensitivity

Interference sensitivity shall not be worse than for systems without diversity.

9.4 Distortion sensitivity

Under study.

10 Cross polar interference sensitivity

This clause covers specific aspects of the performance of the system in presence of cross polarization interference not covered in the previous clauses.

10.1 Co-channel "internal" interference sensitivity in flat fading conditions

For frequency bands given in clause 4.1, the limits of the co-channel "internal" interference sensitivity shall be as in figure 5.

NOTE: Figure 3 shows co-channel digital interference sensitivity with respect to an external signal where there is no improvement by XPIC operation.

Figure 5 shows co-channel digital interference sensitivity with respect to an internal signal where there is full improvement by XPIC operation.

The XPIC improvement factor XIF is defined as the difference in crosspolar isolation in dB measured at sufficient large C/N (typically 35 dB) at a specific BER for systems with and without XPIC.

Hence by comparing the abscissa values of figures 3 and 5 an XIF of 20 dB is derived valid in flat fading conditions. Such XIF has to be a worst case that should be verified in all conditions, with particular references to the relative phase between the useful and interfering signal.

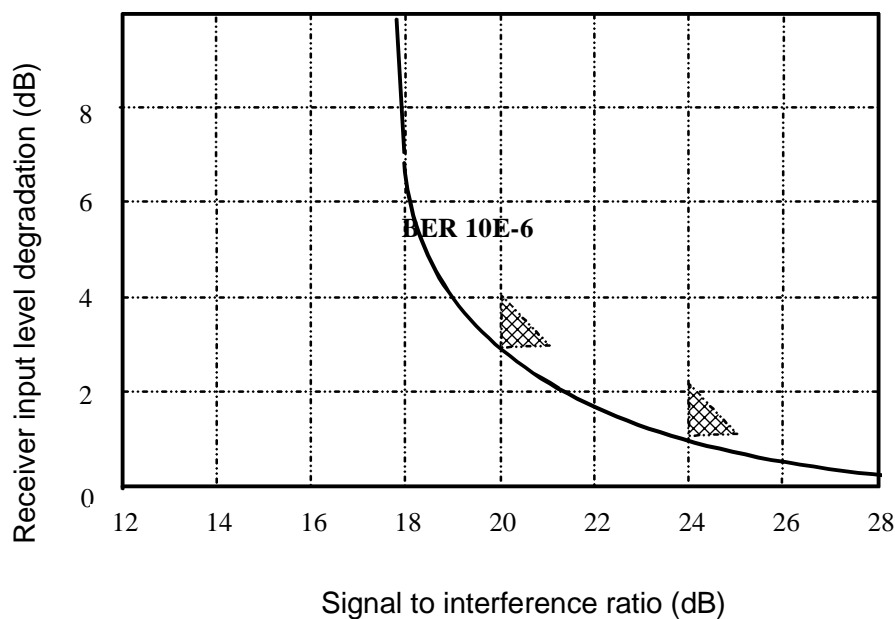

Figure 5: Co-channel "internal" digital interference sensitivity limits referred to point B'

10.2 Co-channel "internal" interference sensitivity in dispersive fading conditions

Information on this topic can be found in ETR 019 [36] and TR 101 127 [37].

This issue is also under study in EN 301 127 [32]. However the relevant information is still not mature to be used as a standard.

Annex A (informative): Additional information

A.1 ATPC

ATPC can be useful in many circumstances, especially:

- to improve analogue / digital compatibility in the case of antennas with poor Cross Polarization Discrimination performance or in the case of high nominal output power for the DRRS;
- to reduce digital-to-digital distant interference between hops which re-use the same frequency;
- to improve compatibility with both digital and analogue systems at nodal stations;
- to reduce the effects of up-fading propagation conditions on the system.

ATPC is an optional feature which is aimed at driving the TX power amplifier output level from a proper minimum in case of normal propagation up to a maximum value which is defined by the relative class of output power and the complete fulfilment of all the specifications defined in the present document.

The ATPC range is the power interval from the nominal output power level to the lowest power amplifier output level (at point B') with ATPC. The minimum ATPC output power level should be specified, to facilitate analogue to digital compatibility.

Use of ATPC with CCDP systems requires further investigation to ensure that co-channel and adjacent channel C/I ratios and residual BER performance characteristics remain acceptable under all conditions of the ATPC range.

A.2 Branching, feeder and antenna

A.2.1 Antenna radiation pattern envelopes

Antennas required for systems specified in the present document should comply with EN 300 833 [15].

The classes of antennas to be recommended for this system should be chosen from EN 300 833 [15] clauses 1 to 4 in accordance with the operator's network interference potential.

A.2.2 Cross-polar discrimination (XPD)

The XPD category 2 of antennas specified in EN 300 833 [15] is considered as sufficient for systems specified in the normative part above.

The measured effective XPD over a typical hop (50 km) under non-fading conditions should not be less than 35 dB.

NOTE: Some critical hops could require greater values of XPD.

A.2.3 Interport isolation

Interport isolation should not be less than 40 dB.

A.2.4 Feeder / antenna return loss

For indoor systems, the minimum return loss should be better than 24 dB within a frequency band of \pm the symbol rate of the system referred to the nominal centre frequency of the RF channel in use, measured at point C' in the direction to the antenna.

A.3 Compatibility

The systems considered in the present document are intended to allow operation with respect to existing PDH systems using 16QAM modulation and transmitting 140 Mbit/s and to existing SDH systems using 64QAM modulation and transmitting one STM-1 applying a channel spacing of 80 MHz.

Compatibility with respect to non-standardized 64QAM transmitting 1 STM-1 with 40 MHz channel spacing will probably exist but has to be confirmed individually considering both polarizations.

Compatibility with respect to other systems should be investigated individually and with respect to both polarizations.

A.4 Mechanical requirements

For indoor installation the equipment should conform to ETS 300 119 [11]. Other mechanical arrangements which can be made compatible with ETS 300 119 [11] should also be considered.

Annex B (informative): Bibliography

ITU-R Recommendation F.382-7 (1997): "Radio-frequency channel arrangements for radio-relay systems operating in the 2 and 4 GHz bands".

ITU-R Recommendation F.746-4 (1997): "Radio-frequency channel arrangements for radio-relay systems".

ITU-R Recommendation F.751-2 (1997): "Transmission characteristics and performance requirements of radio-relay systems for SDH-based networks".

ITU-T Recommendation G.774 (1992): "Synchronous Digital Hierarchy (SDH) management information model for the network element view".

ETSI TR 101 036-1: "Fixed Radio Systems; Point-to-point equipment; Generic wordings for standards on digital radio systems characteristics; Part 1: General aspects and point-to-point equipment parameters".

History

Document history		
V1.1.1	February 2000	Publication
V1.2.1	October 2000	One-step Approval Procedure OAP 20010209: 2000-10-11 to 2001-02-09
V1.2.1	February 2001	Publication