

ETSI EN 301 216 V1.2.1 (2001-07)

European Standard (Telecommunications series)

**Fixed Radio Systems;
Point-to-point equipment;
Plesiochronous Digital Hierarchy (PDH);
Low and medium capacity and STM-0 digital
radio system operating in the frequency bands
in the range 3 GHz to 11 GHz**



Reference

REN/TM-04111-02

KeywordsDRRS, PDH, SDH, STM, point-to-point,
transmission**ETSI**

650 Route des Lucioles
F-06921 Sophia Antipolis Cedex - FRANCE

Tel.: +33 4 92 94 42 00 Fax: +33 4 93 65 47 16

Siret N° 348 623 562 00017 - NAF 742 C
Association à but non lucratif enregistrée à la
Sous-Préfecture de Grasse (06) N° 7803/88

Important notice

Individual copies of the present document can be downloaded from:

<http://www.etsi.org>

The present document may be made available in more than one electronic version or in print. In any case of existing or perceived difference in contents between such versions, the reference version is the Portable Document Format (PDF). In case of dispute, the reference shall be the printing on ETSI printers of the PDF version kept on a specific network drive within ETSI Secretariat.

Users of the present document should be aware that the document may be subject to revision or change of status. Information on the current status of this and other ETSI documents is available at <http://www.etsi.org/tb/status/>

If you find errors in the present document, send your comment to:

editor@etsi.fr

Copyright Notification

No part may be reproduced except as authorized by written permission.
The copyright and the foregoing restriction extend to reproduction in all media.

© European Telecommunications Standards Institute 2001.
All rights reserved.

Contents

Intellectual Property Rights	5
Foreword.....	5
1 Scope.....	6
2 References.....	7
3 Symbols and abbreviations.....	9
3.1 Symbols.....	9
3.2 Abbreviations.....	9
4 General Characteristics	10
4.1 Frequency bands and channel arrangements.....	10
4.1.1 Channel plan.....	10
4.1.2 Channel Spacing for systems operating on the same route.....	13
4.2 Compatibility requirements between systems	13
4.3 Performance and availability requirements.....	14
4.4 Environmental conditions	14
4.4.1 Equipment within weather protected locations (indoor locations).....	14
4.4.2 Equipment for non-weather protected locations (outdoor locations).....	14
4.5 Power supply.....	14
4.6 ElectroMagnetic compatibility.....	15
4.7 System block diagram	15
4.8 TMN interface.....	15
4.9 Mechanical requirements.....	15
4.10 Feeder and antenna requirements.....	15
4.10.1 Antenna radiation pattern	15
4.10.2 Antenna cross-polar discrimination	15
4.10.3 Waveguide flanges.....	16
4.10.4 Return Loss (RL)	16
5 Parameters for digital systems.....	16
5.1 Transmission capacity	16
5.2 Baseband parameters	17
5.2.1 Plesiochronous interfaces	17
5.2.2 ISDN interface (primary rate).....	17
5.2.3 SDH baseband interface.....	17
5.3 Transmitter characteristics	17
5.3.1 Transmitter power range	17
5.3.2 Automatic Transmit Power Control	17
5.3.3 Transmitter output power tolerance	18
5.3.4 Tx local oscillator frequency arrangements.....	18
5.3.5 RF spectrum mask.....	18
5.3.6 Discrete CW components exceeding the spectrum mask limit	24
5.3.6.1 Spectral lines at the symbol rate	24
5.3.6.2 Other spectral lines	25
5.3.7 Spurious emissions.....	26
5.3.7.1 Spurious emissions - external.....	26
5.3.7.2 Spurious emissions - internal	26
5.3.8 Radio frequency tolerance.....	26
5.4 Receiver characteristics	26
5.4.1 Input level range	26
5.4.2 Rx local oscillator frequency arrangements.....	27
5.4.3 Spurious emissions.....	27
5.4.3.1 Spurious emissions - external.....	27
5.4.3.2 Spurious emissions - internal	27
5.4.4 Receiver image rejection	27
5.5 System Performance without diversity.....	28

5.5.1	BER as a function of receiver input signal level RSL	28
5.5.2	Equipment maximum allowed number of errors.....	28
5.5.3	Interference sensitivity	29
5.5.3.1	Co-channel external interference sensitivity	29
5.5.3.2	Adjacent Channel interference sensitivity.....	30
5.5.3.3	CW interference	31
5.5.3.4	Front-end non-linearity requirements (Two-tone CW Spurious interference).....	31
5.5.4	Distortion sensitivity	31
5.6	System characteristics with diversity.....	32
5.6.1	Differential delay compensation	32
5.6.2	BER performance	32
5.6.3	Interference sensitivity	32
5.6.4	Distortion sensitivity	32
Annex A (informative): Additional information		33
A.1	Antenna requirements	33
A.1.1	Antenna radiation patterns	33
A.1.2	Antenna cross-polar discrimination (XPD).....	33
A.1.3	Feeder/antenna return loss	33
A.2	Automatic Transmit Power Control.....	33
A.3	Spectrum masks.....	34
A.4	Lightning protection	34
A.5	Mechanical requirements	34
History	35

Intellectual Property Rights

IPRs essential or potentially essential to the present document may have been declared to ETSI. The information pertaining to these essential IPRs, if any, is publicly available for **ETSI members and non-members**, and can be found in ETSI SR 000 314: "*Intellectual Property Rights (IPRs); Essential, or potentially Essential, IPRs notified to ETSI in respect of ETSI standards*", which is available from the ETSI Secretariat. Latest updates are available on the ETSI Web server (<http://www.etsi.org/ipr>).

Pursuant to the ETSI IPR Policy, no investigation, including IPR searches, has been carried out by ETSI. No guarantee can be given as to the existence of other IPRs not referenced in ETSI SR 000 314 (or the updates on the ETSI Web server) which are, or may be, or may become, essential to the present document.

Foreword

This European Standard (Telecommunications series) has been produced by ETSI Technical Committee Transmission and Multiplexing (TM).

The former title of the present document was: "Transmission and Multiplexing (TM); Digital Radio Relay Systems (DRRS); Plesiochronous Digital Hierarchy (PDH); Low and medium capacity and STM-0 DRRS operating in the frequency bands in the range 3 GHz to 11 GHz".

National transposition dates	
Date of adoption of this EN:	6 July 2001
Date of latest announcement of this EN (doa):	31 October 2001
Date of latest publication of new National Standard or endorsement of this EN (dop/e):	30 April 2002
Date of withdrawal of any conflicting National Standard (dow):	30 April 2002

1 Scope

The present document specifies the minimum performance parameters for low and medium capacity terrestrial fixed service digital radiocommunications equipment operating in the frequency bands between around 3 GHz and 11 GHz but nevertheless such systems should provide the efficient use of the spectrum under any conditions.

The present document covers equipment intended to be used at nominal data rates for PDH systems between 2 Mbit/s and 2×34 Mbit/s and for SDH systems transmitting STM-0 signals with a VC3 payload capacity.

Consideration has to be given to special requirements of the local and access network especially different network structures with high density nodes.

The systems considered are envisaged to operate in these networks having regard for existing hop lengths which mainly depend on the intended frequency band, the performance objectives set by relevant ITU-R Recommendations or national network operators requirements and existing propagation characteristics. The hop lengths are considered to be up to about 100 km in the frequency band 3 GHz and 60 km in the frequency band 11 GHz taking into account diversity techniques.

Typical applications include:

- a) point-to-point links in local, regional and national networks;
- b) mobile base station connections;
- c) business networks connections;
- d) customer access links.

The parameters to be specified fall into two categories:

- a) Those that are required to provide compatibility between RF channels from different sources of equipment on the same route, connected either to:
 - separate antennas; or to
 - separate polarization of the same antenna.
- b) Parameters defining the transmission quality of the proposed system.

The standardization deals with RF and baseband characteristics relevant to low and medium capacity PDH and STM-0 SDH transmission. Spurious emissions requirements are also included in the present document. EMC requirements are covered in EN 300 385 [23] and EN 301 489-4 [43]. Antenna/feeder system requirements are covered in ETS 300 833 [1].

As the maximum transmission rate in a given bandwidth depends on systems spectral efficiency, different Classes are defined:

- | | |
|----------|---|
| Class 1: | Equipment based on performances of a typical 4-states modulation scheme. |
| Class 2: | Equipment based on performances of a typical 16-states modulation scheme. |
| Class 3: | Equipment based on performances of a typical 32 or 64-states modulation scheme. |

Safety is not considered in the present document.

2 References

The following documents contain provisions which, through reference in this text, constitute provisions of the present document.

- References are either specific (identified by date of publication, edition number, version number, etc.) or non-specific.
- For a specific reference, subsequent revisions do not apply.
- For a non-specific reference, subsequent revisions do apply.

- [1] ETSI ETS 300 833: "Fixed Radio Systems; Point to Point Antennas; Antennas for point-to-point fixed radio systems operating in the frequency band 3 GHz to 60 GHz".
- [2] CEPT/ERC/Recommendation 14-03: "Harmonised radio frequency channel arrangements for low and medium capacity systems in the band 3400 MHz to 3600 MHz".
- [3] CEPT/ERC/Recommendation 12-08: "Harmonised radio frequency channel arrangements and block allocations for medium and high capacity systems in the band 3600 MHz to 4200 MHz".
- [4] ITU-R Recommendation F.383-6: "Radio-frequency channel arrangements for high capacity radio-relay systems operating in the lower 6 GHz band".
- [5] ITU-R Recommendation F.384-7: "Radio-frequency channel arrangements for medium and high capacity analogue or digital radio-relay systems operating in the upper 6 GHz band".
- [6] ITU-R Recommendation F.385-6: "Radio-frequency channel arrangements for radio-relay systems operating in the 7 GHz band".
- [7] ITU-R Recommendation F.386-6: "Radio-frequency channel arrangements for medium and high capacity analogue or digital radio-relay systems operating in the 8 GHz band".
- [8] ITU-R Recommendation F.746-4: "Radio-frequency channel arrangements for radio-relay systems".
- [9] ITU-R Recommendation F.747: "Radio-frequency channel arrangements for radio-relay systems operating in the 10 GHz band".
- [10] CEPT/ERC/Recommendation 12-05: "Harmonised radio frequency channel arrangements for digital terrestrial fixed systems operating in the band 10.0 - 10.68 GHz".
- [11] ITU-R Recommendation F.635-5: "Radio-frequency channel arrangements based on a homogeneous pattern for radio-relay systems operating in the 4 GHz band".
- [12] ITU-R Recommendation F.382-7: "Radio-frequency channel arrangements for radio-relay systems operating in the 2 and 4 GHz bands".
- [13] ITU-R Recommendation F.1092-1: "Error performance objectives for constant bit rate digital path at or above the primary rate carried by digital radio-relay systems which may form part of the international portion of a 27 500 km hypothetical reference path".
- [14] ITU-R Recommendation F.1189-1: "Error performance objectives for constant bit rate digital paths at or above the primary rate carried by digital radio-relay systems which may form part or all of the national portion of a 27 500 km hypothetical reference path".
- [15] ITU-R Recommendation F.557-4: "Availability objective for radio-relay systems over a hypothetical reference circuit and a hypothetical reference digital path".
- [16] ITU-T Recommendation G.826: "Error performance parameters and objectives for international, constant bit rate digital paths at or above the primary rate".
- [17] ITU-T Recommendation G.827: "Availability parameters and objectives for path elements of international constant bit-rate digital paths at or above the primary rate".

- [18] ITU-R Recommendation F.752-1: "Diversity techniques for radio-relay systems".
- [19] ITU-R Recommendation F.1093-1: "Effects of multipath propagation on the design and operation of line-of-sight digital radio-relay systems".
- [20] ITU-R Recommendation F.1101: "Characteristics of digital radio-relay systems below about 17 GHz".
- [21] ETSI ETS 300 019 (Parts 1 and 2): "Equipment Engineering (EE); Environmental conditions and environmental tests for telecommunications equipment; Part 1: Classification of environmental conditions; Part 2: Specification of environmental tests".
- [22] ETSI ETS 300 132 (Parts 1 and 2): "Equipment Engineering (EE); Power supply interface at the input to telecommunications equipment; Part 1: Operated by alternating current (ac) derived from direct current (dc) sources; Part 2: Operated by direct current (dc)".
- [23] ETSI EN 300 385: "Electromagnetic compatibility and Radio spectrum Matters (ERM); ElectroMagnetic Compatibility (EMC) standard for fixed radio links and ancillary equipment".
- [24] ITU-T Recommendation G.773: "Protocol suites for Q-interfaces for management of transmission systems".
- [25] IEC 60154 (all parts): "Flanges for waveguides".
- [26] ITU-T Recommendation G.703: "Physical/electrical characteristics of hierarchical digital interfaces".
- [27] ITU-T Recommendation G.704: "Synchronous frame structures used at 1544, 6312, 2048, 8488 and 44 736 kbit/s hierarchical levels".
- [28] ITU-T Recommendation I.412: "ISDN user-network interfaces - Interface structures and access capabilities".
- [29] ETSI ETS 300 233: "Integrated Services Digital Network (ISDN); Access digital section for ISDN primary rate".
- [30] ITU-T Recommendation G.707: "Network node interface for the synchronous digital hierarchy (SDH)".
- [31] Void.: "Empty".
- [32] Void.: "Empty".
- [33] ITU-T Recommendation G.783: "Characteristics of synchronous digital hierarchy (SDH) equipment functional blocks".
- [34] ITU-T Recommendation G.784: "Synchronous digital hierarchy (SDH) management".
- [35] ITU-T Recommendation G.957: "Optical interfaces for equipments and systems relating to the synchronous digital hierarchy".
- [36] ITU-R Recommendation F.750-3: "Architectures and functional aspects of radio-relay systems for synchronous digital hierarchy (SDH)-based networks."
- [37] Void.: "Empty".
- [38] ITU-R Recommendation F.1191-1: "Bandwidths and unwanted emissions of digital radio-relay systems"
- [39] ETSI ETS 300 119: "Equipment Engineering (EE); European telecommunication standard for equipment practice".
- [40] ETSI TR 101 035: "Transmission and Multiplexing (TM); Synchronous Digital Hierarchy (SDH) aspects regarding Digital Radio Relay Systems (DRRS)".

- [41] ETSI TR 101 036-1: "Fixed Radio Systems; Point-to-point equipment; Generic wordings for standards on digital radio systems characteristics; Part 1: General aspects and point-to-point equipment parameters".
- [42] CEPT/ERC Recommendation 74-01: "Spurious emissions".
- [43] ETSI EN 301 489-4: "Electromagnetic compatibility and Radio spectrum Matters (ERM); ElectroMagnetic Compatibility (EMC) standard for radio equipment and services; Part 4: Specific conditions for fixed radio links and ancillary equipment and services".

3 Symbols and abbreviations

3.1 Symbols

For the purposes of the present document, the following symbols apply:

dB	decibel
dBm	decibel relative to 1 mW
Hz	hertz
id	idem
GHz	gigahertz
kbit/s	kilobits per second
kHz	kilohertz
km	kilometre
Mbit/s	megabits per second
MHz	megahertz
ns	nanosecond
ppm	part per million

3.2 Abbreviations

For the purposes of the present document, the following abbreviations apply:

ACDP	Adjacent Channel Dual Polarized
ATPC	Automatic Transmit Power Control
BBER	Background Bit Error Rate
BER	Bit Error Ratio
C/I	Carrier to Interference ratio
CMI	Coded Marked Inverted
CS	Channel Spacing
CSmin	minimum practical Channel Separation (for a given radio-frequency channel arrangement)
CW	Continuous Wave
EMC	ElectroMagnetic Compatibility
ERC	European Radio Committee
F _c	Cut-off Frequency
F _s	Symbol Rate
IF	Intermediate Frequency
ISDN	Integrated Services Digital Network
LO	Local Oscillator
NFD	Net Filter Discrimination
PDH	Plesiochronous Digital Hierarchy
PSD	Power Spectral Density
PSTN	Public Switched Telecommunication Network
RF	Radio Frequency
RSL	Receive Signal Level
Rx	Receiver
SDH	Synchronous Digital Hierarchy
SOH	Section OverHead
STM	Synchronous Transfer Module

TMN	Telecommunications Management Network
Tx	Transmitter
VC	Virtual Container
W/U	Wanted to Unwanted ratio
XPD	Cross Polar Discrimination

4 General Characteristics

4.1 Frequency bands and channel arrangements

4.1.1 Channel plan

The equipment should operate on one or more of the frequency ranges defined below.

The frequency ranges are:

- 3,410 GHz to 3,600 GHz;
- 3,600 GHz to 4,200 GHz;
- 5,925 GHz to 6,425 GHz;
- 6,425 GHz to 7,100 GHz;
- 7,110 GHz to 7,900 GHz;
- 7,725 GHz to 8,500 GHz;
- 10,000 GHz to 10,680 GHz.

The channel plan should be in accordance with the CEPT ERC or ITU-R Recommendations listed in table 1.

Table 1: Relevant CEPT ERC and ITU-R Recommendations

CEPT ERC or ITU-R Recommendation	Band	Frequency range
CEPT/ERC/Recommendation 14-03 [2]	3,5 GHz	3,410 GHz to 3,600 GHz
CEPT/ERC/Recommendation 12-08 [3] Annex A	4 GHz	3,600 GHz to 4,200 GHz
CEPT/ERC/Recommendation 12-08 [3] Annex B Part 2	id	3,600 GHz to 3,800 GHz
CEPT/ERC/Recommendation 12-08 [3] Annex B Part 1	id	3,800 GHz to 4,200 GHz
ITU-R Recommendation F.383-6 [4]	L6 GHz	5,925 GHz to 6,425 GHz
ITU-R Recommendation F.384-7 [5]	U6 GHz	6,425 GHz to 7,100 GHz
ITU-R Recommendation F.385-6 [6]	7 GHz	7,125 GHz to 7,425 GHz
id	id	7,425 GHz to 7,725 GHz
id	id	7,250 GHz to 7,550 GHz
id	id	7,550 GHz to 7,850 GHz
ITU-R Recommendation F.385-6 [6] Annex 1	id	7,425 GHz to 7,725 GHz
ITU-R Recommendation F.385-6 [6] Annex 3	id	7,110 GHz to 7,750 GHz
ITU-R Recommendation F.385-6 [6] Annex 4	id	7,425 GHz to 7,900 GHz
ITU-R Recommendation F.386-6 [7]	8 GHz	8,200 GHz to 8,500 GHz
ITU-R Recommendation F.386-6 [7] Annex 1	id	7,725 GHz to 8,275 GHz
ITU-R Recommendation F.386-6 [7] Annex 3	id	8,275 GHz to 8,500 GHz
ITU-R Recommendation F.386-6 [7] Annex 4 (see note)	id	7,900 GHz to 8,400 GHz
ITU-R Recommendation F.746-4 [8] Annex 4	10 GHz	10,300 GHz to 10,680 GHz
ITU-R Recommendation F.747 [9]	10 GHz	10,500 GHz to 10,680 GHz
CEPT/ERC/Recommendation 12-05 [10]	10 GHz	10,150 GHz to 10,300 GHz paired with 10,500 GHz to 10,650 GHz

Description of relevant characteristics is provided by tables 2a and 2b.

Table 2a: Channel plans characteristics/PDH applications

Frequency band	Band limits	Channel spacing	Transmit/ receive spacing
CEPT/ERC/Recommendation 14-03 [2]	3,410 GHz to 3,600 GHz	1,75/3,5/7/14 MHz	100 MHz or 50 MHz
CEPT/ERC/Recommendation 12-08 [3]			
Annex A Part 1	3,6 GHz to 4,2 GHz based on ITU-R Recommendation F.635-5 [11]	20 MHz	320 MHz
Annex A Part 2	3,6 GHz to 4,2 GHz based on ITU-R Recommendation F.635-5 [11]	15/30 MHz	320 MHz
Annex B Part 1	3,8 GHz to 4,2 GHz based on ITU-R Recommendation F.382-7 [12]	14,5/29 MHz	213 MHz
Annex B Part 2	3,6 GHz to 3,8 GHz divided into 0,25 MHz slots	1,75/3,5/7/14 MHz (basic raster 0,25 MHz)	100 or 50 MHz
ITU-R Recommendation F.383-6 [4]	5,925 GHz to 6,425 GHz	29,65 MHz	252,04 MHz
7 GHz ITU-R Recommendation F.385-6 [6]	7,425 GHz to 7,725 GHz 7,125 GHz to 7,425 GHz 7,250 GHz to 7,550 GHz 7,550 GHz to 7,850 GHz	7/14/28 MHz	161 MHz
ITU-R Recommendation F.385-6 [6] Annex 1	7,425 GHz to 7,725 GHz	28 MHz	154 MHz
ITU-R Recommendation F.385-6 [6] Annex 3	7,110 GHz to 7,750 MHz	28 MHz	196 MHz
ITU-R Recommendation F.385-6 [6] Annex 4	7,425 GHz to 7,900 GHz	7/14/28 MHz	245 MHz
ITU-R Recommendation F.386-6 [7]	8,200 GHz to 8,500 GHz	11,662 MHz	151,614 MHz
ITU-R Recommendation F.386-6 [7] Annex 1	7,725 GHz to 8,275 GHz	29,65 GHz	311,32 MHz
ITU-R Recommendation F.386-6 [7] Annex 3	8,275 GHz to 8,500 GHz	14/28 MHz	119 MHz
	id	7/14/28 MHz	126 MHz
ITU-R Recommendation F.386-6 [7] Annex 4	7,900 GHz to 8,400 GHz	7/14/28 MHz	266 MHz
ITU-R Recommendation F.747 [9] ITU-R Recommendation F.747 [9] Annex 1	10,5 GHz to 10,68 GHz	3,5/7/14 MHz (homogeneous pattern 3,5 MHz)	91 MHz
CEPT/ERC/Recommendation 12-05 [10]	10,15 GHz to 10,30 GHz paired with 10,5 GHz to 10,65 GHz	3,5/7/14/28 MHz (basic raster 0,5 MHz)	350 MHz

Table 2b: Channel plans characteristics/STM-0 applications

Frequency band	Band limits	Channel spacing	Transmit/ receive spacing
CEPT/ERC/Recommendation 14-03 [4]	3,410 GHz to 3,600 GHz	14 MHz	100 MHz or 50 MHz
CEPT/ERC/Recommendation 12-08 [3]	3,6 GHz to 4,2 GHz		
Annex A Part 1	3,6 GHz to 4,2 GHz based on ITU-R Recommendation F.635-5 [11]	20 MHz	320 MHz
Annex A Part 2	3,6 GHz to 4,2 GHz based on ITU-R Recommendation F.635-5 [11]	15/30 MHz	320 MHz
Annex B Part 1	3,8 GHz to 4,2 GHz based on ITU-R Recommendation F.382-7 [12]	14,5/29 MHz	213 MHz
Annex B Part 2	3,6 GHz to 3,8 GHz divided into 0,25 MHz slots	14 MHz (basic raster 0,25 MHz)	100 MHz or 50 MHz
L6 GHz ITU-R Recommendation F.383-6 [4]	5,925 GHz to 6,425 GHz	29,65 MHz	252,04 MHz
U6 GHz ITU-R Recommendation F.384-7 [5]	6,425 GHz to 7,100 GHz	20 MHz	340 MHz
7 GHz ITU-R Recommendation F.385-6 [6]	7,125 GHz to 7,425 GHz 7,425 GHz to 7,725 GHz 7,250 GHz to 7,550 GHz 7,550 GHz to 7,850 GHz	14 MHz, 21 MHz, 28 MHz	161 MHz
7 GHz ITU-R Recommendation F.385-6 [6] Annex 1	7,425 GHz to 7,725 GHz	28 MHz	154 MHz
7 GHz ITU-R Recommendation F.385-6 [6] Annex 3	7,110 GHz to 7,780 MHz	28 MHz	196 MHz
7 GHz ITU-R Recommendation F.385-6 [6] Annex 4	7,425 GHz to 7,900 GHz	14/28 MHz	245 MHz
8 GHz ITU-R Recommendation F.386-6 [7]	8,200 GHz to 8,500 GHz	2 × 11,662 MHz	151,614 MHz
8 GHz ITU-R Recommendation F.386-6 [7] Annex 1	7,725 GHz to 8,275 GHz	29,65 MHz	311,32 MHz
8 GHz ITU-R Recommendation F.386-6 [7] Annex 3	8,275 GHz to 8,500 GHz	14/28 MHz 14/21/28 MHz	119 MHz 126 MHz
8 GHz ITU-R Recommendation F.386-6 [7] Annex 4	7,900 GHz to 8,400 GHz	14/28 MHz	266 MHz
10 GHz CEPT/ERC/Recommendation 12-05 [10]	10,15 GHz to 10,30 GHz paired with 10,5 GHz to 10,65 GHz	14/28 MHz (basic raster 0,5 MHz)	350 MHz
10 GHz ITU-R Recommendation F.746-4 [8] Annex 4	10,300 GHz to 10,680 GHz	20 MHz	

4.1.2 Channel Spacing for systems operating on the same route

Multiple channel operation via branching networks is a system consideration and is outside the scope of the present document.

The systems in the present document are designed to operate on the same route using the combinations of co-polar or cross-polar channel spacings and nominal system bit rate given in tables 3a and 3b (for the precise payload bit rates, see clause 5.1). In practice, when common antenna operation is envisaged, adjacent channels may be connected to a different polarization of the same antenna.

Table 3a: Channel spacing for particular PDH bit rates

		Co-polar spacing						Cross-polar spacing	
		Nominal Payload Bit Rate Mbit/s	2 Mbit/s	2 × 2 Mbit/s	8 Mbit/s	2 × 8 Mbit/s	34 Mbit/s	2 × 34 Mbit/s	2 × 34 Mbit/s
Channel Spacing	Class 1	1,75 MHz	3,5 MHz	7 MHz/ 11,662 MHz	14 MHz/ 14,5 MHz/ 15 MHz	28 MHz/ 29 MHz/ 29,65 MHz/ 30 MHz	---	---	
	Class 2	----	1,75 MHz	3,5 MHz	7 MHz	14 MHz/ 14,5 MHz/ 15 MHz	28 MHz/ 29 MHz/ 29,65 MHz/ 30 MHz	---	
	Class 3	----	---	---	---	---	14 MHz/ 14,5 MHz/ 15 MHz	14 MHz/ 14,5 MHz/ 15 MHz (note)	

NOTE: Variations of Class 3 equipment exist designed to operate cross-polarization in adjacent channels (ACDP systems). In this case the co-polar CS would become 28 MHz, 29 MHz or 30 MHz.

Table 3b: Channel spacing for STM-0 bit rate

		Nominal Payload bit rate (Mbit/s)	51 Mbit/s			
Channel	Class 2	---	20 MHz	21 MHz	2 × 11,662 MHz	28 MHz/ 29 MHz/ 29,65 MHz/ 30 MHz
Spacing	Class 3	14 MHz/ 14,5 MHz/ 15 MHz	---	---	---	---

4.2 Compatibility requirements between systems

There should be no requirement to operate transmitting equipment from one manufacturer with receiving equipment from another.

Different manufacturer equipment may be used on different polarization of the same antenna but there should be no requirement to multiplex different manufacturer equipment on the same polarization of the same antenna.

4.3 Performance and availability requirements

Equipment should be designed in order to meet network performance and availability requirements foreseen by ITU-R Recommendations F.1092-1 [13], F.1189-1 [14] and F.557-4 [15] following the criteria defined in ITU-T Recommendations G.826 [16] and G.827 [17] for international or national portion of the digital path.

The implication of the link design on the performance is recognized and the general design criteria reported in ITU-R Recommendations F.752-1 [18], F.1093-1 [19], F.1101 [20], F.1092-1 [13] and F.1189-1 [14] are to be applied.

4.4 Environmental conditions

Both indoor and partially outdoor installations are considered.

The equipment should be required to meet the environmental conditions set out in ETS 300 019 [21] which defines weather protected and non-weather protected locations, classes and test severity.

The manufacturer should state which class the equipment is designed to withstand.

4.4.1 Equipment within weather protected locations (indoor locations)

Equipment intended for operation within temperature controlled locations or partially temperature controlled locations should meet the requirements of ETS 300 019 [21] classes 3.1 and 3.2 respectively.

Optionally, the more stringent requirements of ETS 300 019 [21] classes 3.3 (non-temperature controlled locations), 3.4 (sites with heat trap) and 3.5 (sheltered locations) may be applied.

4.4.2 Equipment for non-weather protected locations (outdoor locations)

Equipment intended for operation within non-weather protected locations should meet the requirements of ETS 300 019 [21], class 4.1 or 4.1E.

Class 4.1 applies to many European countries and class 4.1E applies to all European countries.

4.5 Power supply

The power supply interface should be in accordance with the characteristics of one or more of the secondary voltages foreseen in Parts 1 and 2 of ETS 300 132 [22].

NOTE: Some applications may require secondary voltages that are not covered by ETS 300 132 [22].

For DC systems, the positive pole of the voltage supply should be earthed at the source.

4.6 ElectroMagnetic compatibility

Equipment should operate under the conditions specified in EN 300 385 [23] or EN 301 489-4 [43].

4.7 System block diagram

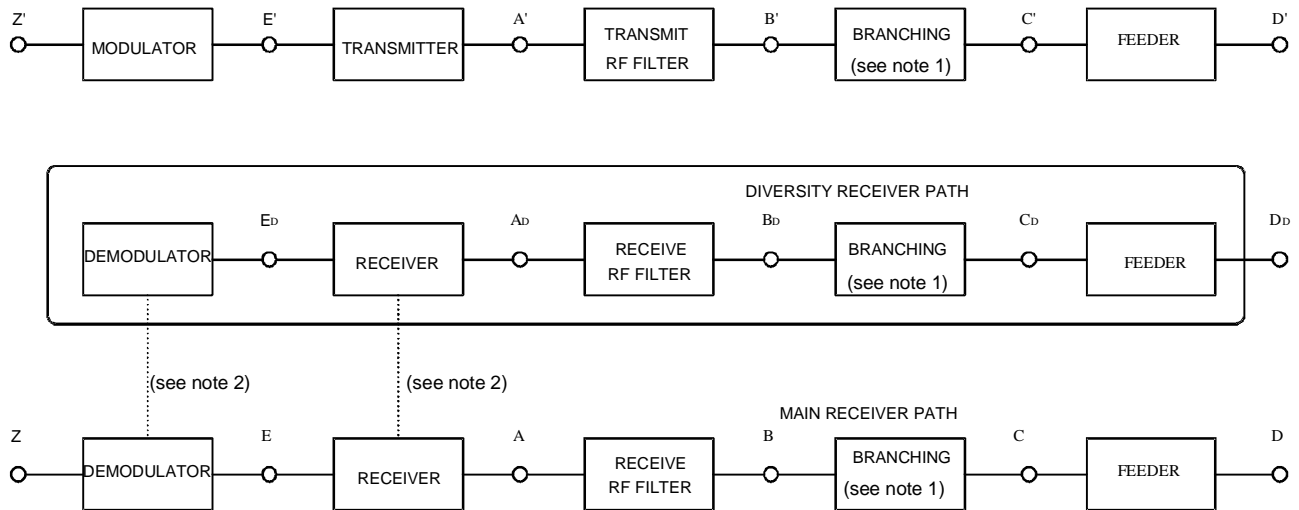

NOTE 1: NO FILTERING INCLUDED.

NOTE 2: ALTERNATIVE CONNECTION AT RF, IF OR BASEBAND.

NOTE 3: For the purpose of defining the measurement points, the branching network does not include a hybrid.

NOTE 4: The points shown above are reference points only; points C and C', D and D' in general coincide.

NOTE 5: Points B and C, B' and C' may coincide when simple duplexer is used.

NOTE 6: Diversity is an optional feature.

Figure 1: System Block Diagram

4.8 TMN interface

TMN interface, if any, should be in accordance with ITU-T Recommendation G.773 [24].

NOTE: The standardization of TMN interface functionalities is under responsibility and development in ETSI TC TMN (formerly in TM2), and will be applicable to the radio relay systems considered in the present document.

4.9 Mechanical requirements

See clause A.5.

4.10 Feeder and antenna requirements

4.10.1 Antenna radiation pattern

See clause A.1.

4.10.2 Antenna cross-polar discrimination

See clause A.1.

4.10.3 Waveguide flanges

If a waveguide flange is used at point C/C', the following types should all be used in accordance with IEC 60154 [25].

Table 4: RF Waveguide Interfaces

Frequency band	Waveguide flange
3,5 GHz	UDR/UBR/PBR/CBR 32
4 GHz	UDR/UBR/PBR/CBR 40
U6 GHz	UDR/UBR/PBR/CBR 70
7 GHz	UDR/PDR/CDR 70 or 84 UBR/PBR/CBR 70 or 84
8 GHz	UDR/PDR/CDR 84 UBR/PBR/CBR 84
10,5 GHz	UDR/PDR/CDR 100 or 120 UBR/PBR/CBR 100 or 120

4.10.4 Return Loss (RL)

The minimum return loss of the branching system should be 20 dB for Class 3 systems, 15 dB for Class 2 systems and 12 dB for Class 1 systems. The measurement should be referred to point C/C' towards the radio equipment and across a frequency band greater than or equal to 0,7 times the maximum aggregate symbol rate.

Equipment according to the present document may also have system configuration with integral antennas or very similar technical solutions, without long feeder connections; return loss is not considered as an essential requirement.

When antenna is an integral part of the system there shall be no requirement.

NOTE: For indoor systems, a feeder + antenna return loss equal or better than 20 dB is assumed. If this performance is not achieved, values better than the above return loss figures may be required.

For feeder/antenna RL information, see clause A.1.

5 Parameters for digital systems

5.1 Transmission capacity

For sake of simplicity in the present document the considered nominal capacities will be simply referred to as 2 Mbit/s, 2×2 Mbit/s, 8 Mbit/s, 2×8 Mbit/s, 34 Mbit/s, 2×34 Mbit/s and 51 Mbit/s (STM-0), these capacities will appear in tables 3a, 3b, 8, 10a, 10b, 11 and in the titles of figures 2a to 2e.

However, the actual payload Bit Rate(s) considered should be 2,048 Mbit/s, 8,448 Mbit/s, 34,368 Mbit/s and STM-0 or any combinations of $n \times 2,048$ Mbit/s (e.g. with n in the range 1 to 32) and $n \times 8,448$ Mbit/s (e.g. with n in the range 1 to 8).

Moreover medium capacity systems sometimes offer the option for one additional 2,048 Mbit/s way-side traffic built in the radio frame complementary overhead; if this additional capacity will have the same transmission quality and equivalent TMN functionality of the standard payload rate, it should be considered among payload (e.g. resulting, in 34 Mbit/s and STM-0 systems, in a transmission capacity of $17 \times 2,048$ Mbit/s or $22 \times 2,048$ Mbit/s respectively).

For example the relevant requirements, for the following $n \times 2,048$ Mbit/s, can be found:

- for 4×2 Mbit/s in the rows related to 8 Mbit/s;
- for 8×2 Mbit/s (9×2 Mbit/s if applicable) in the rows related to 2×8 Mbit/s;
- for 16×2 Mbit/s (17×2 Mbit/s if applicable) in the rows related to 34 Mbit/s;
- for 21×2 Mbit/s (22×2 Mbit/s if applicable) in the rows related to 51 Mbit/s.

5.2 Baseband parameters

5.2.1 Plesiochronous interfaces

Plesiochronous interfaces at 2 Mbit/s, 8 Mbit/s and 34 Mbit/s should comply with ITU-T Recommendation G.703 [26]. Parameters for service channels and wayside traffic channels are outside the scope of the present document.

5.2.2 ISDN interface (primary rate)

The transmission of 2 Mbit/s signals using the structure and functions of ISDN primary multiplex signals is to be in accordance with ITU-T Recommendations G.703 [26], G.704 [27], I.412 [28] and ETS 300 233 [29].

5.2.3 SDH baseband interface

The SDH baseband interfaces are in accordance with ITU-T Recommendations G.703 [26], G.707 [30], G.783 [33], G.784 [34] and G.957 [35] (with possible simplifications under study in ETSI TM3 and TM4) and ITU-R Recommendation F.750-3 [36].

Two STM-1 interfaces should be possible:

- CMI electrical (ITU-T Recommendation G.703 [26]);
- Optical (ITU-T Recommendation G.957 [35]).

The use of reserved bytes contained in the SOH, and their termination should be in accordance with ITU-R Recommendation F.750-3 [36]. Further details on the possible use of the SOH bytes reserved for future international standardization are given in TR 101 035 [40].

5.3 Transmitter characteristics

The specified transmitter characteristics should be met with the appropriate baseband signals applied at reference point Z' of figure 1.

5.3.1 Transmitter power range

The maximum value of output power at reference point B' (for equipment with multichannel branching system) or C' (for equipment with simple duplexer) of the system block diagram (figure 1) should not exceed +40 dBm under any conditions. If for proper operation of the system, a lower transmitter output power is required, then an internal or external means of adjustment should be provided.

The maximum nominal value should be declared by the manufacturer.

5.3.2 Automatic Transmit Power Control

ATPC is an optional feature.

If implemented, the ATPC range should not be less than 10 dB.

NOTE: For hop lengths of more than about 35 km an ATPC device with a range of more than 20 dB may be required for use on the same polarization on different antennas on the same route.

Equipment with ATPC will be subject to Manufacturer declaration of ATPC range and related tolerances.

Testing should be carried out with output power level corresponding to:

- ATPC set manually to a fixed value for system performance (see clauses 5.5 and 5.6);
- ATPC set at maximum provided power for Tx performance (see clause 5.3).

Further information on ATPC is given in clause A.2.

5.3.3 Transmitter output power tolerance

The tolerance of the nominal output power should be within:

- nominal output power ± 2 dB for systems operating within non-weather protected locations;
- nominal output power ± 1 dB for systems operating within weather protected locations.

5.3.4 Tx local oscillator frequency arrangements

There should be no requirement on transmitter LO frequency arrangement.

5.3.5 RF spectrum mask

The spectrum masks are shown in figures 2a to 2e.

The 0 dB level shown on the spectrum masks relates to the spectral power density of the actual centre frequency disregarding residual carrier.

The masks do not include frequency tolerance.

In some particular circumstances as mentioned in the clause A.3, tighter requirements are required.

The spectrum analyser settings for measuring the RF spectrum mask detailed in figures 2a to 2e are shown in table 5.

Table 5 shows the recommended spectrum analyser settings for measurement on a band ≤ 10 Fs across centre frequency, for wider band measurement an IF bandwidth of 1 MHz and a Video bandwidth of 10 kHz may be used.

Table 5: Spectrum analyser settings for RF power spectrum measurement

Parameter	Setting				
Channel Spacing	1,75 MHz	3,5 MHz	7 MHz 11,662 MHz	14 MHz 14,5 MHz 15 MHz	≥ 20 MHz
RF Centre Frequency	Spectrum Centre				
Amplitude Scale	10 dB/div	10 dB/div	10 dB/div	10 dB/div	10 dB/div
IF Bandwidth	30 kHz	30 kHz	30 kHz	100 kHz	100 kHz
Sweep Width	10 MHz	20 MHz	50 MHz	100 MHz	200 MHz
Scan Time	Automatic				
Video Bandwidth Filter	300 Hz	300 Hz	300 Hz	300 Hz	300 Hz

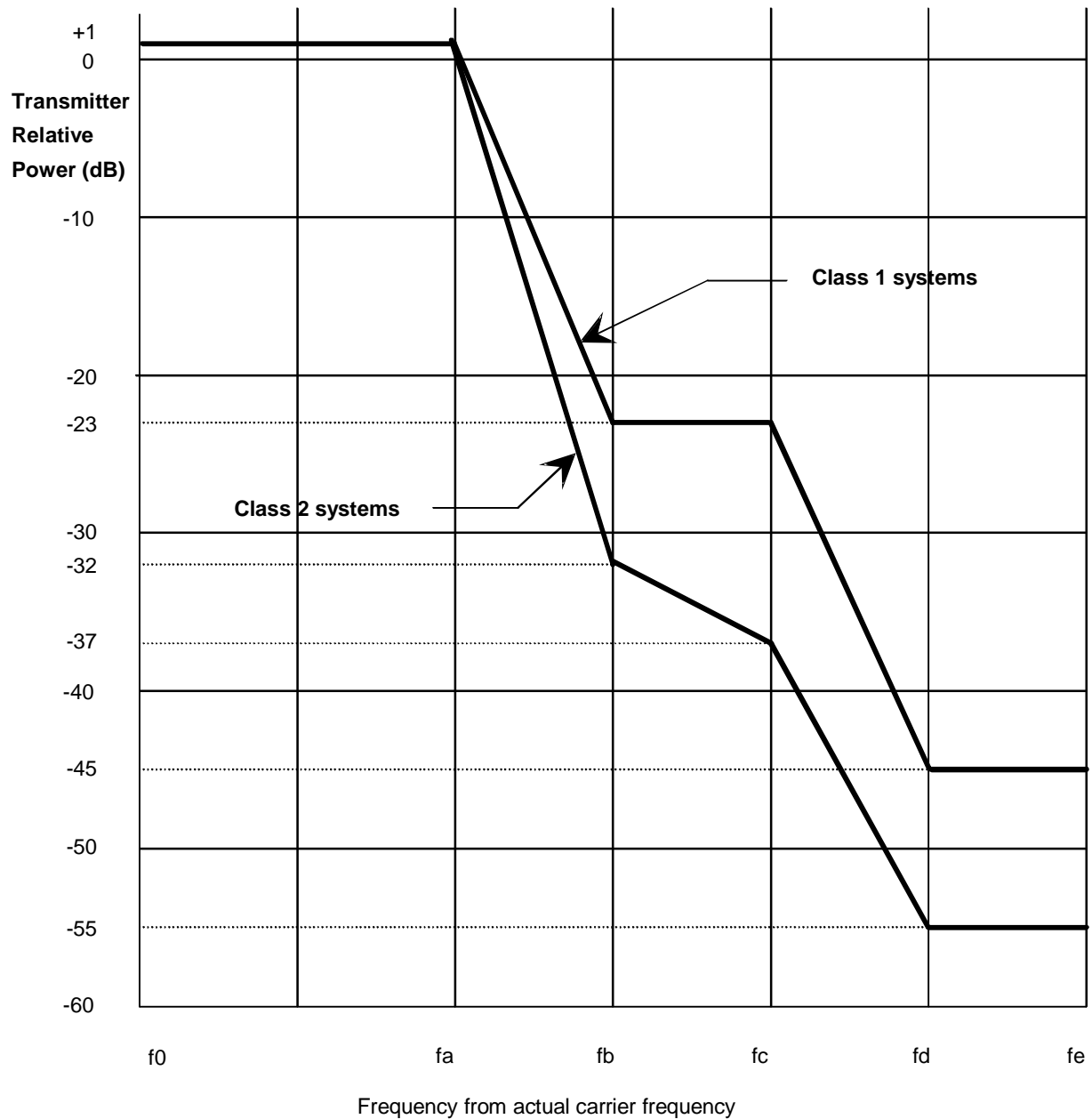

f_0 = Actual Transmitter Carrier Frequency.

NOTE: These masks refer to actual centre frequency and do not include an allowance for frequency stability including ageing.

Figure 2a: Limits of power spectral density for 2 to 34 Mbit/s Class 1 or 2×2 to 2×34 Mbit/s Class 2 system

Reference frequencies f_a to f_e are reported in table 6 for the considered channel spacing.

Table 6: Reference frequencies

Nominal Bit rate (Mbit/s)	Channel spacing	f_a	f_b	f_c	f_d	f_e
Class 1 systems						
2	1,75 MHz	0,7 MHz	1,4 MHz	1,75 MHz	3,5 MHz	4,375 MHz
2×2	3,5 MHz	1,4 MHz	2,8 MHz	3,5 MHz	7,0 MHz	8,75 MHz
8	7/11,662 MHz	2,7 MHz	5,6 MHz	6,5 MHz	13 MHz	17,5 MHz
2×8	14/14,5/15 MHz	5,4 MHz	11,2 MHz	13 MHz	26 MHz	35 MHz
34	28/29/29,65/30 MHz	11,0 MHz	19 MHz	25 MHz	45,0 MHz	70 MHz
Class 2 systems						
2×2	1,75 MHz	0,7 MHz	1,4 MHz	1,75 MHz	3,5 MHz	4,375 MHz
8	3,5 MHz	1,4 MHz	2,8 MHz	3,5 MHz	7,0 MHz	8,75 MHz
2×8	7/11,662 MHz	2,8 MHz	5,6 MHz	7 MHz	14,0 MHz	17,5 MHz
34	14/14,5/15 MHz	5,6 MHz	11,2 MHz	14 MHz	28,0 MHz	35 MHz
2×34	28/29/29,65/30 MHz	11,2 MHz	22,4 MHz	28 MHz	56 MHz	70 MHz

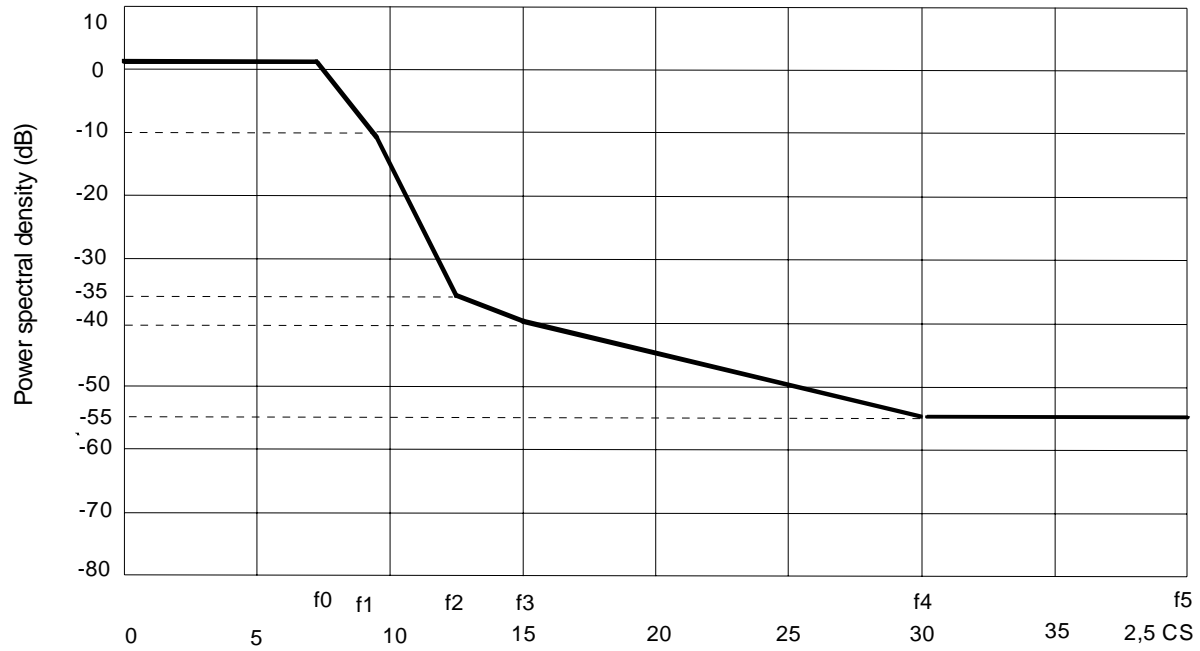

NOTE 1: Frequency offset from the actual centre frequency (MHz).

Table of corner points

Frequency (MHz)		Relative PSD (dB)
f0	7,5 MHz	+1
f1	9,5 MHz	-10
f2	12,5 MHz	-35
f3	15 MHz	-40
f4	30 MHz	-55
f5	2,5 × CS	-55

NOTE 2: The masks refer to actual centre frequency and do not include an allowance for frequency stability including ageing.

**Figure 2b: Limits of power spectral density for 51 Mbit/s Class 2 systems
(with Channel Spacing $20/21/2 \times 11,662$ MHz)**

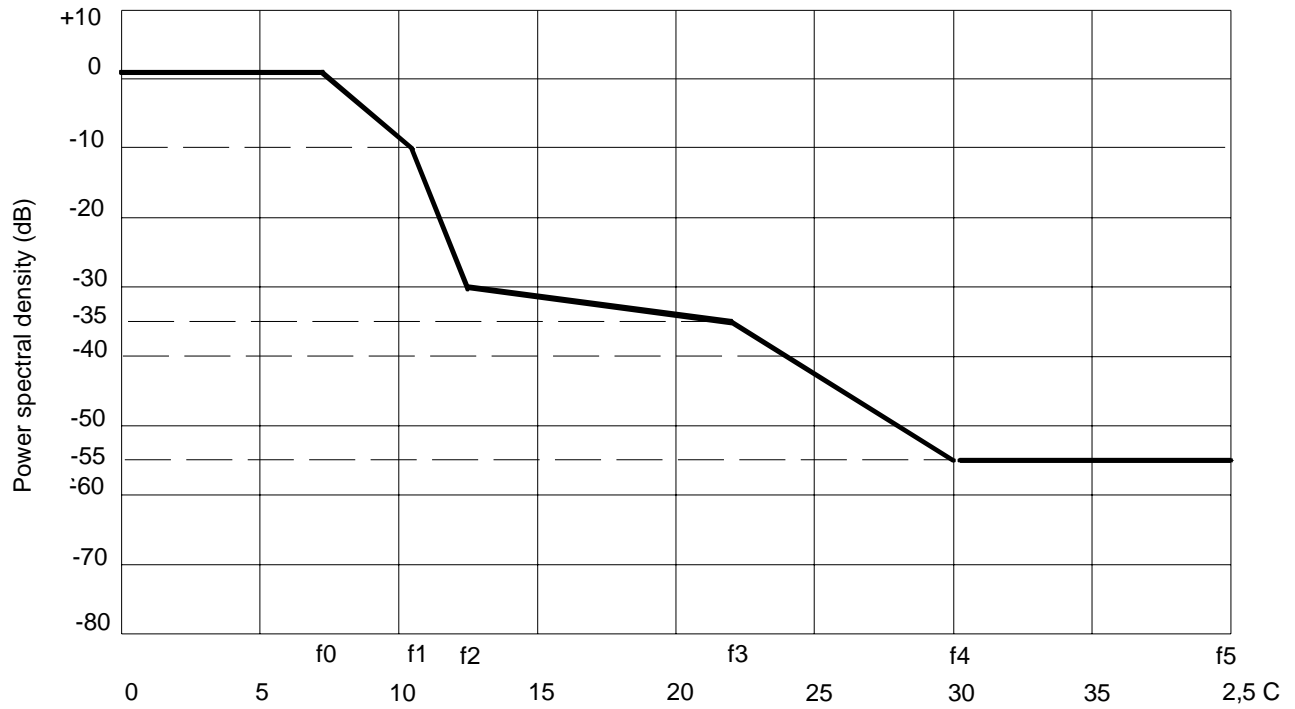

NOTE: Frequency offset from the actual centre frequency (MHz).

Table of corner points

Frequency (MHz)	Relative PSD (dB)	
f0	7,5 MHz	+1
f1	10,5 MHz	-10
f2	12,5 MHz	-30
f3	22 MHz	-35
f4	30 MHz	-55
f5	2,5 × CS	-55

Figure 2c: Limits of power spectral density for 51 Mbit/s Class 2 systems (with CS 28/29,65/30 MHz)

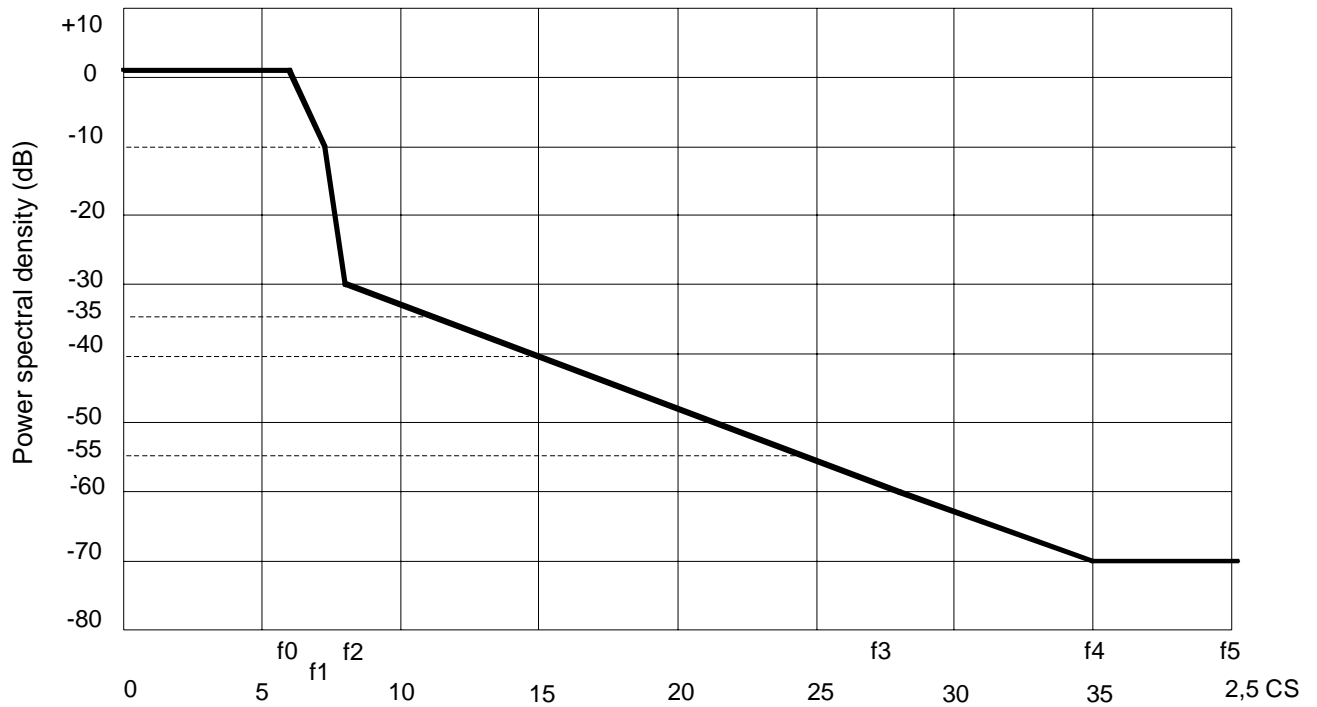

NOTE: Frequency offset from the actual centre frequency (MHz).

Table of corner points

Frequency (MHz)		Relative PSD (dB)
f ₀	6 MHz	+1
f ₁	7 MHz	-10
f ₂	8 MHz	-30
f ₃	28 MHz	-60
f ₄	35 MHz	-70
f ₅	2,5 × CS	-70

Figure 2d: Limits of power spectral density for 2 × 34 Mbit/s Class 3 systems (with Co-polar Channel Spacing 14/14,5/15 MHz) or 2 × 34 Mbit/s Class 3 ACDP systems (with Cross-polar Channel Spacing 14 /14,5/15 MHz and Co-polar Channel Spacing 28/29/30 MHz)

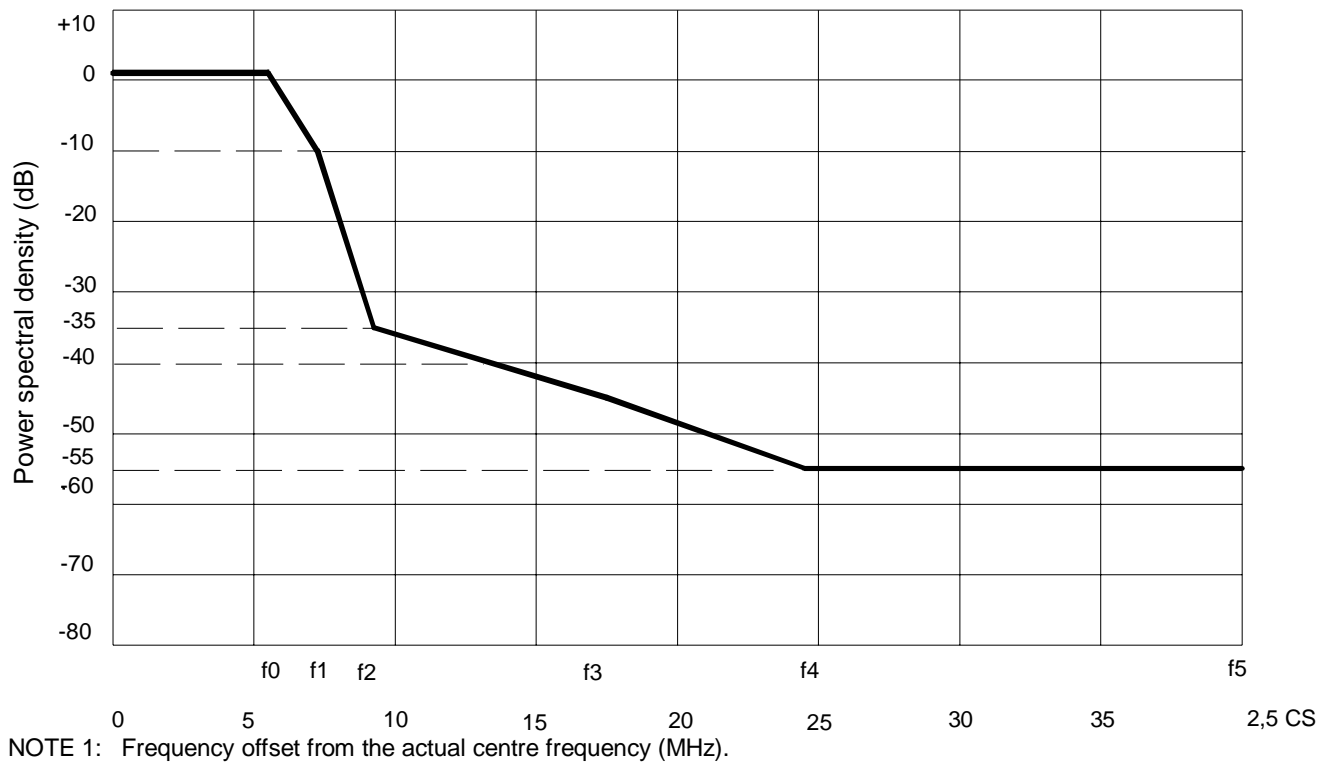

Table of corner points

Frequency (MHz)	Relative PSD (dB)	
f0	6,0 MHz	+1
f1	7,5 MHz	-10
f2	8,5 MHz	-35
f3	17,5 MHz	-45
f4	24 MHz	-55
f5	2,5×CS	-55

NOTE 2: The masks refer to actual centre frequency and do not include an allowance for frequency stability including ageing.

Figure 2e: Limits of power spectral density for 51 Mbit/s Class 3 system (with CS 14/14,5/15 MHz)

5.3.6 Discrete CW components exceeding the spectrum mask limit

5.3.6.1 Spectral lines at the symbol rate

The power level (Reference point B') of spectral lines at a distance from the channel frequency equal to the symbol rate should not be more than -30 dBm or should fall within the relevant RF Spectrum mask defined in clause 5.3.5, whichever is less stringent requirement.

5.3.6.2 Other spectral lines

In case some CW components exceed the spectrum mask, an additional allowance is given.

Those lines shall not:

- exceed the mask by a factor more than $\{10 \log (CS_{min}/IFbw) - 10\}$ dB (note)
- be spaced each other in frequency by less than CS_{min}

Where:

$CS_{min} = 500$ kHz for the band 3.41-3.8 GHz and systems for CS up to 14 MHz

$CS_{min} = 10\ 000$ kHz for the band 3,41-4,2 and systems for CS > 14 MHz

$CS_{min} = 14\ 825$ kHz for the band L6 GHz

$CS_{min} = 10\ 000$ kHz for the band U6 GHz

$CS_{min} = 7\ 000$ kHz for the bands 7 GHz and 8 GHz

$CS_{min} = 1\ 500$ kHz for the band 10 GHz

IFbw is the recommended resolution bandwidth, expressed in kHz, reported in table 5.

NOTE: In case the calculation of the allowance factor will result in a negative value, no additional allowance is then permitted.

Figure 3 shows a typical example of this requirement.

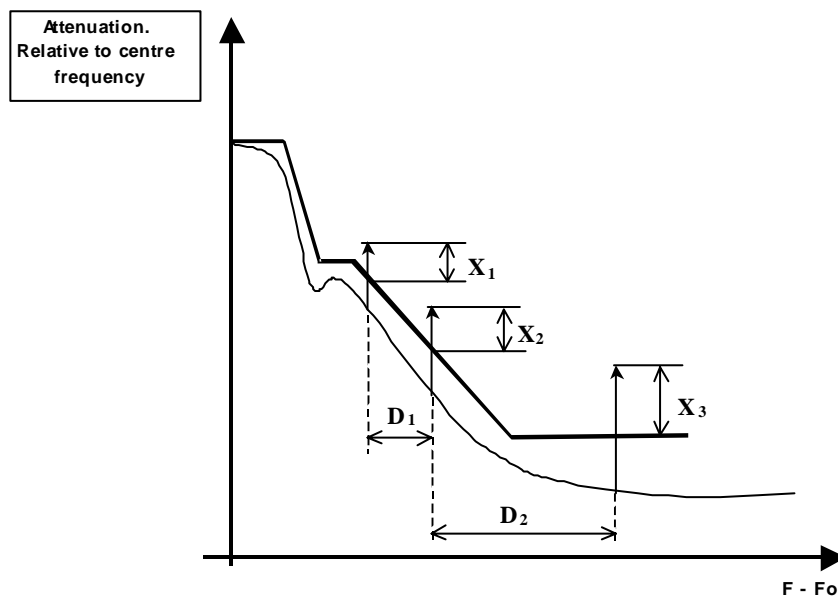

$$X_1, X_2, X_3 \text{ [dB]} \leq 10 \log (CS_{min}/ IFbw) - 10$$

$$D_1, D_2 \geq CS_{min}$$

Figure 3: CW lines exceeding the spectrum mask (typical example)

5.3.7 Spurious emissions

It is necessary to define spurious emissions from transmitters for two reasons:

- a) to limit interference into systems operating wholly externally to the system (external emissions);
- b) to limit local interference within the system where transmitters and receivers are directly connected via the filter and branching systems (internal emissions).

This leads to two sets of spurious emission limits where the specific limits given for "internal" interference are required to be no greater than the "external" level limits at reference point B' for indoor systems and C' for outdoor systems (when a common Tx/Rx duplexer is used).

5.3.7.1 Spurious emissions - external

According to ITU-R Recommendation F.1191-1 [38] and CEPT/ERC Recommendation 74-01 [42], the external spurious emissions are defined as emissions at frequencies which are outside the nominal carrier frequency $\pm 250\%$ of the relevant channel separation. The limit of these emissions shall conform to CEPT/ERC Recommendation 74-01 [42].

5.3.7.2 Spurious emissions - internal

Being the requirement to multiplex equipment from different manufacturers on different polarization of the same antenna, the levels of the spurious emissions from the transmitter, referenced to reference point C' are specified in table 7.

The required level will be the total average level integrated over the bandwidth of the emission under consideration.

Table 7: Internal levels for the transmitter spurious consideration

Spurious Emission Frequency Relative to Channel Assigned Frequency	Specification Limit	Controlling Factor for requirement application
The average level of all spurious signals both discrete CW and noise-like (including LO, \pm IF, $\pm 2 \times$ IF), evaluated as total signal level	≤ -70 dBm	If spurious signal's frequency falls within receiver half band, for digital systems without branching network (i.e. with duplexer)
	≤ -50 dBm	If spurious signal's frequency falls within transmitter half band
Other spurious evaluated as in clause 5.3.7.1	As required by clause 5.3.7.1	

5.3.8 Radio frequency tolerance

Maximum radio frequency tolerance should not exceed ± 15 ppm for equipment operating with channel spacing lower than 14 MHz and ± 30 ppm for equipment operating with channel spacing greater than or equal to 14 MHz. These limits include both short-term factors (environmental effects) and long-term ageing effects.

In the type test the manufacturer should state the guaranteed short-term part and the expected ageing part.

5.4 Receiver characteristics

5.4.1 Input level range

The input level range for a BER $< 10^{-3}$ should extend from the upper limit of -20 dBm to the limit specified for BER = 10^{-3} in clause 5.5.1.

When ATPC is used, the maximum input level for BER @ 10^{-3} may be relaxed to -26 dBm.

These limits apply without interference and are referenced to point B of figure 1.

5.4.2 Rx local oscillator frequency arrangements

There should be no requirement on receiver LO frequency arrangement.

5.4.3 Spurious emissions

The frequency range in which the spurious emission specifications apply is 9 kHz to 110 GHz, however for conformance test measurement will be limited to the second harmonic frequency.

NOTE: When waveguide is used between ref. point A and C, which length is higher than twice the free space wavelength of F_c , the lower limit of measurement will be increased to $0,7 F_c$ and to $0,9 F_c$ when the length is higher than four times the same wavelength.

5.4.3.1 Spurious emissions - external

CEPT/ERC/Recommendation 74-01 [42] shall apply.

5.4.3.2 Spurious emissions - internal

Spurious emissions which fall within receivers half band should be < -90 dBm, referenced to reference point C, for digital systems without branching networks (i.e. with duplexer).

The required level will be the total average level integrated over the bandwidth of the emission under consideration.

5.4.4 Receiver image rejection

If applicable, the receiver image(s) rejection should be as listed in table 8.

Table 8: Receiver image rejection

Class of equipment	Class 1	Class 2	Class 3
a) If image frequency falls within receiver half band	> 75 dB	> 80 dB	> 90 dB
b) If image frequency falls within transmitter half band	> 85 dB	> 85 dB	> 85 dB

5.5 System Performance without diversity

All parameters are referred to reference point B or C of figure 1.

5.5.1 BER as a function of receiver input signal level RSL

Receiver BER thresholds (dBm) referred to reference point C (for systems with simple duplexer) or B (for system with multi-channel branching system) of the System Block Diagram (figure 1) for BER of 10^{-3} , 10^{-6} and 10^{-8} should be equal to or lower than those stated in table 9 (these levels do not include any hybrid loss).

Table 9: BER performance thresholds for 3 GHz to 7,5 GHz systems

		RSL@BER→	RSL@ 10^{-3} (dBm)	RSL@ 10^{-6} (dBm)	RSL@ 10^{-8} (dBm)
Class of equipment ↓	Nominal Bit-rate (Mbit/s) ↓	Channel spacing (MHz) ↓			
Class 1	2	1,75	-90	-87	
	2 × 2	3,5	-87	-84	
	8	7/11,662	-85	-82	
	2 × 8	14/14,5/15	-82	-79	
	34	28/29/29,65/30	-79	-76	
Class 2	2 × 2	1,75	-87	-84	-82
	8	3,5	-84	-81	-79
	2 × 8	7/11,662	-81	-78	-76
	34	14/14,5/15	-78	-75	-73
	51	20 to 30	-78	-75	-73
	2 × 34	28/29/29,65/30	-75	-72	-70
Class 3	2 × 34	14/14,5/15 (note 2)	-72,5	-69,5	-67,5
	51	14/14,5/15	-76	-73	-71

NOTE 1: For 8 GHz to 11 GHz systems allowance for relaxation of the figures by 1 dB.
NOTE 2: Variations of Class 3 equipment exist designed to operate cross polarization in adjacent channels (ACDP systems). In this case the co-polar channel spacing would become 28 MHz, 29 MHz or 30 MHz.

5.5.2 Equipment maximum allowed number of errors

The equipment maximum allowed number of errors level under simulated operating conditions without interference is measured with a signal level at reference point B (or C) which is 10 dB above the level which gives BER = 10^{-6} (as specified in clause 5.5.1). All measurements will be made at the payload bit rate defined in clause 4.1.

Measurement period and maximum number of errors allowed are given in table 10.

Table 10: Maximum allowed number of bit errors

Bit-rate	Minimum Recording Time	Maximum allowed Number of Bit Errors
2 Mbit/s	16 hours	12
8 Mbit/s	4 hours	12
34 Mbit/s	10 hours	12
51 Mbit/s	24 hours	10

NOTE: As the measurement is made on the tributaries, the clause relative to the 2 Mbit/s is also applicable to $n \times 2$ Mbit/s systems, the clause relative to the 8 Mbit/s to the $n \times 8$ Mbit/s systems, and the clause relative to the 34 Mbit/s to the 2×34 Mbit/s systems.

5.5.3 Interference sensitivity

All receive signal levels and C/I measurements are referred to reference point B (for system with multi-channel branching system) or C (for systems with simple duplexer) of the RF Block Diagram (figure 1).

5.5.3.1 Co-channel external interference sensitivity

The limits of the co-channel interference sensitivity should be as given in table 11a, giving maximum C/I values for 1 dB and 3 dB degradation of the 10^{-6} BER limit specified in clause 5.5.1.

Table 11a: Co-channel external interference sensitivity

Spectrum Efficiency Class ↓	Nominal Bit Rate (Mbit/s) ↓	RSL @ BER degradation Channel spacing (MHz) ↓	RSL @ 10^6	
			1 dB Maximum C/I value (dB)	3 dB Maximum C/I value (dB)
Class 1	2	1,75	23	19
	2 × 2	3,5	23	19
	8	7/11,662	23	19
	2 × 8	14/14,5/15	23	19
	34	28/29/29,65/30	23	19
Class 2	2 × 2	1,75	30	26,5
	8	3,5	30	26,5
	2 × 8	7/11,662	30	26,5
	34	14/14,5/15	30	26,5
	51	20 to 30	30	26,5
	2 × 34	28/29/29,65/30	30	26,5
Class 3	2 × 34	14/14,5/15 (note)	33	29
	51	14/14,5/15	33	29

NOTE: Variations of Class 3 equipment exist designed to operate cross polarization in adjacent channels (ACDP systems). In this case the co-polar channel spacing would become 28 MHz, 29 MHz or 30 MHz.

5.5.3.2 Adjacent Channel interference sensitivity

The limits of the adjacent channel interference sensitivity should be as given in tables 11b. and 11c. below for like modulated signals spaced of 1 channel spacing, giving maximum C/I values for 1 dB and 3 dB degradation of the 10^{-6} BER limits specified in clause 5.5.1.

Table 11b: 1st Adjacent channel interference sensitivity

Spectrum Efficiency Class ↓	Nominal Bit Rate (Mbit/s) ↓	RSL@BER degradation Channel spacing (MHz) ↓	RSL @ 10^6	
			1 dB Maximum C/I value (dB)	3 dB Maximum C/I value (dB)
Class 1	2	1,75	0	-4
	2 × 2	3,5	0	-4
	8	7	0	-4
	8	11,662	-10	-14
	2 × 8	14/14,5/15	0	-4
	34	28/29/29,65/30	0	-4
Class 2	2 × 2	1,75	-3	-7
	8	3,5	-3	-7
	2 × 8	7	-3	-7
	2 × 8	11,662	-10	-14
	34	14/14,5/15	-3	-7
	51	20 to 30	-8	-12
	2 × 34	28/29/29,65/30	-3	-7
Class 3	2 × 34 (note)	14/14,5/15	-2	-6
	51	14/14,5/15	-5	-9

NOTE: For the capacity 2×34 Mbit/s ACDP systems may be implemented, in which case the co-polar channel spacing would be effectively 28, 29 or 30 MHz. In this case the requirement for adjacent channel interference sensitivity would be given in table 11c.

Table 11c: Adjacent channel interference sensitivity (2×34 Mbit/s ACDP systems)

Spectrum efficiency class	Nominal Bit rate (Mbit/s)	RSL@BER degradation Channel Spacing (MHz)	RSL @ 10^6	
			1 dB Maximum C/I value (dB)	3 dB Maximum C/I value (dB)
Class 3	2 × 34 Mbit/s	28/29/30	-27	-31
		14/14,5/15	18	14

5.5.3.3 CW interference

For a receiver operating at the 10^{-6} BER threshold given in table 8, the introduction of a CW interferer at a certain level specified below, with respect to the wanted signal and at any frequency in the range 9 kHz to the 3rd harmonic of the receiver operating frequency, excluding frequencies either side of the wanted centre frequency of the RF channel by up to 250 % the channel spacing, should not result in a BER greater than 10^{-5} .

The level of the CW interferer should be:

- for a channel spacing lower than or equal to 14 MHz:
 - +20 dB at any frequency either side of the wanted centre frequency of the RF channel from twice up to 500 % the channel spacing;
 - +30 dB outside 500 % the channel spacing.
- for a channel spacing greater than 14 MHz:
 - +30 dB.

NOTE: When waveguide is used between reference point A and C, which length is higher than twice the free space wavelength of the F_c , the lower limit of measurement will be increased to $0,7 F_c$ and to $0,9 F_c$ when the length is higher than 4 times the same wavelength.

This test is designed to identify specific frequencies at which the receiver may have a spurious response, e.g. image frequency, harmonics of the receive filter, etc. The actual test range should be adjusted accordingly. The test is not intended to imply a relaxed specification at all out of band frequencies elsewhere specified in the present document.

5.5.3.4 Front-end non-linearity requirements (Two-tone CW Spurious interference)

For a receiver operating at the RSL specified in clause 5.5.1 for 10^{-6} BER threshold, the introduction of two equal CW interferers each with a level of +19 dB, with respect to the wanted signal and located at the 2nd and 4th adjacent channels in the receive halfband, should not result in a BER greater than 10^{-5} .

NOTE: The requirement is consistent with the foreseen NFD at far distance.

5.5.4 Distortion sensitivity

The parameters for distortion sensitivity signatures are given in table 12 for medium capacity (i.e. 34 Mbit/s, 2×34 Mbit/s and 51 Mbit/s) systems.

For a delay of 6,3 ns and BER of 10^{-3} and 10^{-6} the width and the depth in signature should not exceed the values of table 11.

These limits are valid for both minimum and non-minimum phase cases.

The limits specified for BER = 10^{-3} should also be verified by the loss of synchronization and re-acquisition signatures.

Table 12: Signature width and depth

Spectrum efficiency class	Nominal Bit rate (Mbit/s)	Channel spacing (MHz)	BER@10 ⁻³		BER@10 ⁻⁶	
			Signature width	Signature depth	Signature width	Signature depth
Class 1	34 Mbit/s	28/29/29,65/30 MHz	±15 MHz	14 dB	±17 MHz	11 dB
Class 2	34 Mbit/s	14 14,5/15 MHz	±9 MHz	17 dB	±11 MHz	14 dB
	51 Mbit/s	20 to 30 MHz	±11 MHz	17 dB	±13 MHz	14 dB
	2 × 34 Mbit/s	28/29/29,65/30 MHz	±18 MHz	17 dB	±20 MHz	14 dB
Class 3	2 × 34 Mbit/s	14/14,5/15MHz (co-polar or cross-polar (see note 2))	±8 MHz	20 dB	±9 MHz	17 dB
	51 Mbit/s	14/14,5/15 MHz	±9 MHz	17 dB	±11 MHz	15 dB

NOTE 1: All signature widths are relative to the assigned channel centre frequency.
NOTE 2: Variations of Class 3 equipment exist designed to operate cross polarization in adjacent channels (ACDP systems). In this case the co-polar channel spacing would become 28 MHz, 29 MHz or 30 MHz.

5.6 System characteristics with diversity

5.6.1 Differential delay compensation

For further study.

5.6.2 BER performance

For further study.

5.6.3 Interference sensitivity

For further study.

5.6.4 Distortion sensitivity

For further study.

Annex A (informative): Additional information

A.1 Antenna requirements

NOTE: The assumptions in this annex refer to ETS 300 833 [1].

A.1.1 Antenna radiation patterns

For equipment on which the antenna forms an integral part, the radiation pattern should be in accordance with ETS 300 833 [1].

A.1.2 Antenna cross-polar discrimination (XPD)

For equipment on which the antenna forms an integral part, the radiation pattern should be in accordance with ETS 300 833 [1].

A.1.3 Feeder/antenna return loss

The minimum return loss of the feeder/antenna system connected to indoor systems should be considered not less than 20 dB. The measurement should be referred to reference point C/C' towards the antenna.

For partially outdoor systems the antenna return loss should be considered not less than 20 dB. The measurement should be referred to reference point C/C' towards the antenna.

A.2 Automatic Transmit Power Control

Automatic Transmit Power Control (ATPC) may be useful in some circumstances, e.g.:

- to reduce interference between neighbouring systems or adjacent channels of the same system;
- to improve compatibility with analogue and digital systems at nodal stations;
- to improve residual BER or BBER performance;
- to reduce upfading problems;
- to reduce transmitter power consumption;
- to reduce digital to digital and digital to analogue distant interference between hops which re-use the same frequency;
- to increase system gain during flat fading attenuation conditions.

ATPC as an optional feature is aimed at driving the Tx Power Amplifier output level from a proper minimum which facilitates the radio network planning requirements and which is used under normal propagation conditions up to a maximum value which fulfils all the specifications defined in the present document.

For planning conditions in a nodal environment a system equipped with ATPC can be considered to operate with its minimum transmitter power.

A.3 Spectrum masks

The spectrum masks given in figures 2a to 2e are consistent with NFD figures between adjacent channels of about 24 dB for Class 1, about 28 dB for Class 2 (PDH bit rates) and about 32 dB for Class 3. For hop lengths of more than about 35 km, higher ATPC range in connection with NFD of more than 32 dB for Class 1, 38 dB for Class 2, and 44 dB for Class 3, or the use of the alternate polarization may be required for systems operating on the same route and using adjacent channels and separate antennas.

NFD can be taken as the difference between the co-channel interference (stated in clause 5.5.3.1, table 11a: Co-channel external interference sensitivity) and the measured value of the adjacent channel interference sensitivity C/I referred to the same bit error ratio and the same modulation scheme each. This procedure is stated in the Generic Standard TR 101 036-1 [41].

A.4 Lightning protection

Lightning discharge protection may be applied at the relevant points of the indoor and outdoor equipment to safeguard against damage. Detailed requirements for lightning protection are under study.

A.5 Mechanical requirements

For outdoor installation, the outdoor unit may be separable from the antenna.

For indoor installation the equipment should conform to ETS 300 119 [39]. Other mechanical arrangement which can be made compatible with ETS 300 119 [39] should be also considered.

For maintenance purposes, the replaceable units of the equipment may be so designed that they can be easily handled by one person.

History

Document history		
V1.1.1	December 1999	Publication
V1.2.1	March 2001	One-step Approval Procedure OAP 20010706: 2001-03-07 to 2001-07-06
V1.2.1	July 2001	Publication