

ETSI EN 300 197 V1.6.1 (2002-07)

European Standard (Telecommunications series)

**Fixed Radio Systems;
Point-to-point equipment;
Parameters for radio systems for the transmission of
digital signals operating at 32 GHz and 38 GHz**



Reference

REN/TM-04149-1

Keywords

architecture, digital, DRRS, point-to-point, radio,
transmission

ETSI

650 Route des Lucioles
F-06921 Sophia Antipolis Cedex - FRANCE

Tel.: +33 4 92 94 42 00 Fax: +33 4 93 65 47 16

Siret N° 348 623 562 00017 - NAF 742 C
Association à but non lucratif enregistrée à la
Sous-Préfecture de Grasse (06) N° 7803/88

Important notice

Individual copies of the present document can be downloaded from:

<http://www.etsi.org>

The present document may be made available in more than one electronic version or in print. In any case of existing or perceived difference in contents between such versions, the reference version is the Portable Document Format (PDF). In case of dispute, the reference shall be the printing on ETSI printers of the PDF version kept on a specific network drive within ETSI Secretariat.

Users of the present document should be aware that the document may be subject to revision or change of status. Information on the current status of this and other ETSI documents is available at

<http://portal.etsi.org/tb/status/status.asp>

If you find errors in the present document, send your comment to:

editor@etsi.fr

Copyright Notification

No part may be reproduced except as authorized by written permission.
The copyright and the foregoing restriction extend to reproduction in all media.

© European Telecommunications Standards Institute 2002.
All rights reserved.

DECTTM, **PLUGTESTS**TM and **UMTS**TM are Trade Marks of ETSI registered for the benefit of its Members.
TIPHONTM and the **TIPHON logo** are Trade Marks currently being registered by ETSI for the benefit of its Members.
3GPPTM is a Trade Mark of ETSI registered for the benefit of its Members and of the 3GPP Organizational Partners.

Contents

Intellectual Property Rights	5
Foreword.....	5
1 Scope	6
2 References	7
3 Definitions, symbols and abbreviations	9
3.1 Definitions	9
3.2 Symbols.....	9
3.3 Abbreviations	9
4 General characteristics	10
4.1 Frequency bands and channel arrangements	10
4.1.1 Channel arrangements.....	10
4.1.1.1 Frequency arrangement for 32 GHz.....	10
4.1.1.2 Frequency arrangement for 38 GHz.....	10
4.2 Channel spacing for systems operating on the same route	10
4.3 Compatibility requirements between systems	11
4.4 Performance and availability requirements	11
4.5 Environmental conditions.....	11
4.5.1 Equipment within weather protected locations (indoor locations).....	11
4.5.2 Equipment for non-weather protected locations (outdoor locations).....	11
4.6 Power supply	12
4.7 Electromagnetic compatibility.....	12
4.8 System block diagram	12
4.9 Telecommunications Management Network (TMN) interface.....	12
4.10 Branching/feeder/antenna characteristics	12
4.10.1 Antenna radiation patterns	12
4.10.2 Antenna cross-Polar Discrimination (XPD)	12
4.10.3 Antenna Inter-Port Isolation (IPI).....	13
4.10.4 Waveguide flanges (or other connectors)	13
4.10.5 Return loss	13
5 System Parameters	13
5.1 Transmission capacity	13
5.2 Baseband parameters	13
5.2.1 Plesiochronous interfaces	13
5.2.2 SDH baseband interface.....	14
5.3 Transmitter characteristics.....	14
5.3.1 Transmitter power range	14
5.3.2 Transmit power and frequency control	14
5.3.2.1 Automatic Transmit Power Control (ATPC)	14
5.3.2.2 Remote Transmit Power Control (RTPC).....	15
5.3.2.3 Remote Frequency Control (RFC)	15
5.3.3 Transmitter output power tolerance	15
5.3.4 Transmit Local Oscillator (LO) frequency arrangements	15
5.3.5 RF spectrum mask	15
5.3.6 Discrete CW lines exceeding the spectrum mask limit.....	19
5.3.6.1 Spectral lines at the symbol rate.....	19
5.3.6.2 Other spectral lines.....	19
5.3.7 Spurious emissions	20
5.3.7.1 Spurious emissions-external.....	20
5.3.7.2 Spurious emissions-internal	20
5.3.8 Radio frequency tolerance	20
5.4 Receiver characteristics	20
5.4.1 Input level range	20
5.4.2 Receiver Local Oscillator (LO) frequency arrangements	20

5.4.3	Spurious emissions	20
5.4.3.1	Spurious emissions-external.....	20
5.4.3.2	Spurious emissions-internal	21
5.5	System performance without diversity	21
5.5.1	BER as a function of Receiver input Signal Level (RSL).....	21
5.5.2	Equipment Residual BER	22
5.5.3	Interference sensitivity.....	22
5.5.3.1	Co-channel interference sensitivity.....	23
5.5.3.2	Adjacent channel interference.....	23
5.5.3.3	Continuous Wave (CW) spurious interference.....	24
5.5.3.4	Front-end non-linearity requirements (two-tone CW spurious interference)	24
5.5.4	Distortion sensitivity.....	25
5.6	System characteristics with diversity	25
Annex A (informative): Additional information.....		26
A.1	Radio frequency channel arrangement	26
A.1.1	Radio frequency channel arrangement for 32 GHz band	26
A.1.2	Radio frequency channel arrangement for 38 GHz band	27
A.2	Feeder/antenna return loss.....	27
A.3	Automatic Transmit Power Control (ATPC)	27
A.4	Residual Bit Error Rate (RBER)	28
A.5	Co-channel and adjacent channel interference	28
Annex B (normative): System type codes for regulatory procedures.....		33
Annex C (normative): Output Power Tolerance and RBER.....		34
History		35

Intellectual Property Rights

IPRs essential or potentially essential to the present document may have been declared to ETSI. The information pertaining to these essential IPRs, if any, is publicly available for **ETSI members and non-members**, and can be found in ETSI SR 000 314: "*Intellectual Property Rights (IPRs); Essential, or potentially Essential, IPRs notified to ETSI in respect of ETSI standards*", which is available from the ETSI Secretariat. Latest updates are available on the ETSI Web server (<http://webapp.etsi.org/IPR/home.asp>).

Pursuant to the ETSI IPR Policy, no investigation, including IPR searches, has been carried out by ETSI. No guarantee can be given as to the existence of other IPRs not referenced in ETSI SR 000 314 (or the updates on the ETSI Web server) which are, or may be, or may become, essential to the present document.

Foreword

This European Standard (Telecommunications series) has been produced by ETSI Technical Committee Transmission and Multiplexing (TM).

The present document specifies the minimum performance parameters for radio equipment operating in the frequency ranges as detailed in clause 4.1.1.

This new version modifies only class 5b spectrum mask giving more allowance for practical implementations, without modifying any other requirement, and propose design objectives for class 5a BER versus RSL.

Proposed national transposition dates	
Date of adoption of this EN:	12 July 2002
Date of latest announcement of this EN (doa):	31 October 2002
Date of latest publication of new National Standard or endorsement of this EN (dop/e):	30 April 2003
Date of withdrawal of any conflicting National Standard (dow):	30 April 2003

1 Scope

The present document specifies the minimum performance parameters for terrestrial digital fixed service radio communications equipment operating in the 32 GHz and 38 GHz frequency.

For spectrum efficiency class 5 for STM-1 capacity for 28 MHz Adjacent Channel Alternate-Polarization (ACAP as class 5a) and Adjacent Channel Co-Polarization (ACCP as class 5b), see examples of the spectrum usage in figures 1.1a and 1.1b:

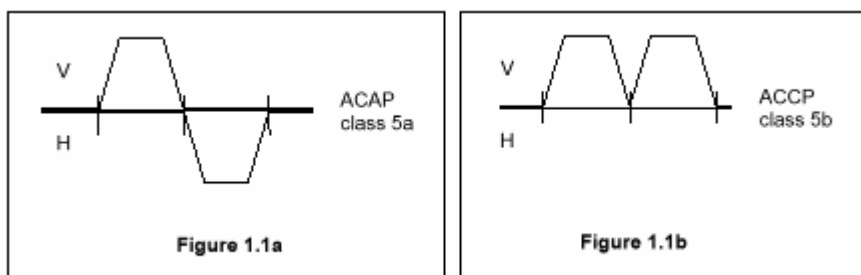

Figure 1

NOTE: In EN 300 197 (V1.2.2) [35] there was provision for:

- parameters for wideband analogue systems;
- further options for digital radio systems (there referred as Grade A systems);
- specific antenna radiation patterns (now superseded by EN 300 833 [3]).

These options are not reprinted in this version as they are considered to be no longer of interest for ETSI members. However, for regulatory purposes, they may still be referenced from EN 300 197 (V1.2.2) [35].

Digital systems are intended to be used for point-to-point connections in local and regional networks at data rates between 2 Mbit/s and Synchronous Transport Module, level 1 (STM-1).

The parameters to be specified fall into two categories:

- a) those that are required to provide compatibility between channels from different sources of equipment on the same route, connected to separate antennas;
- b) parameters defining the transmission quality of the proposed system.

The present document deals with Radio Frequency (RF) and baseband characteristics relevant to low, medium and high capacity Plesiochronous Digital Hierarchy (PDH) transmission systems, STM-0 and STM-1 Synchronous Digital Hierarchy (SDH) transmission systems. Antenna/feeder system requirements are covered in EN 300 833 [3].

The present document does not contain aspects related to test procedures and test conditions however they are to be found in EN 301 126-1 [2].

As the maximum transmission rate in a given bandwidth depends on system spectral efficiency, different equipment classes are defined:

- Class 2: equipment spectral efficiency based on typically 4-states modulation scheme (e.g. 4-FSK, 4-QAM, or equivalent);
- Class 3: equipment spectral efficiency based on typically 8-states modulation scheme (e.g. 8-PSK, or equivalent);
- Class 4: equipment spectral efficiency based on typically 16 or 32-states modulation scheme (e.g. 16-QAM, 32-QAM, or equivalent);
- Class 5: equipment spectral efficiency based on typically 64 or 128-states modulation scheme (e.g. 64-QAM, 128-QAM, or equivalent).

The above classes are indicative only and do not imply any constraint to the actual modulation format, provided that all the requirements in the present document are met.

Safety aspects will not be considered in the present document. However compliance to EN 60950 [30] will be required to comply with Directive 99/5/EC [31] (R&TTE Directive).

Technical background for most of the parameters and requirements referred in the present document may be found in TR 101 036-1 [26].

2 References

The following documents contain provisions which, through reference in this text, constitute provisions of the present document.

- References are either specific (identified by date of publication and/or edition number or version number) or non-specific.
 - For a specific reference, subsequent revisions do not apply.
 - For a non-specific reference, the latest version applies.
- [1] CEPT Recommendation T/R 12-01: "Harmonized radio frequency channel arrangements for analogue and digital terrestrial fixed systems operating in the band 37-39,5 GHz".
 - [2] ETSI EN 301 126-1: "Fixed Radio Systems; Conformance testing; Part 1: Point-to-point equipment - Definitions, general requirements and test procedures".
 - [3] ETSI EN 300 833: "Fixed Radio Systems; Point-to-point Antennas; Antennas for point-to-point fixed radio systems operating in the frequency band 3 GHz to 60 GHz".
 - [4] ETSI EN 300 645: "Telecommunications Management Network (TMN); Synchronous Digital Hierarchy (SDH) radio relay equipment; Information model for use on Q interfaces".
 - [5] ETSI ETS 300 019 (all parts): "Equipment Engineering (EE); Environmental conditions and environmental tests for telecommunications equipment".
 - [6] ETSI ETS 300 132-1: "Equipment Engineering (EE); Power supply interface at the input to telecommunications equipment; Part 1: Operated by alternating current (ac) derived from direct current (dc) sources".
 - [7] ETSI EN 300 132-2: "Environmental Engineering (EE); Power supply interface at the input to telecommunications equipment; Part 2: Operated by direct current (dc)".
 - [8] ETSI EN 300 385: "Electromagnetic compatibility and Radio spectrum Matters (ERM); ElectroMagnetic Compatibility (EMC) standard for fixed radio links and ancillary equipment".
 - [9] ETSI ETS 300 635: "Transmission and Multiplexing (TM); Synchronous Digital Hierarchy (SDH); Radio specific functional blocks for transmission of M x STM-N".
 - [10] ETSI ETS 300 785: "Transmission and Multiplexing (TM); Synchronous Digital Hierarchy (SDH); Radio specific functional blocks for transmission of M x sub-STM-1".
 - [11] ITU-R Recommendation F.750: "Architectures and functional aspects of radio-relay systems for synchronous digital hierarchy (SDH)-based network".
 - [12] ITU-R Recommendation F.751: "Transmission characteristics and performance requirements of radio-relay systems for SDH-based networks".
 - [13] ITU-R Recommendation F.1491: "Error performance objectives for real digital radio links used in the national portion of a 27 500 km hypothetical reference path at or above the primary rate".
 - [14] ITU-T Recommendation G.703: "Physical/electrical characteristics of hierarchical digital interfaces".
 - [15] ITU-T Recommendation G.707: "Network node interface for the synchronous digital hierarchy (SDH)".

- [16] ITU-T Recommendation G.773: "Protocol suites for Q-interfaces for management of transmission systems".
- [17] ITU-T Recommendation G.708: "Sub STM-0 network node interface for the synchronous digital hierarchy (SDH)".
- [18] IEC 60154-2: "Flanges for waveguides. Part 2: Relevant specifications for flanges for ordinary rectangular waveguides".
- [19] ITU-T Recommendation G.783 (1994): "Characteristics of synchronous digital hierarchy (SDH) equipment functional blocks".
- [20] ITU-T Recommendation G.784: "Synchronous digital hierarchy (SDH) management".
- [21] ITU-R Recommendation F.1397: "Error performance objectives for real digital radio links used in the international portion of a 27 500 km hypothetical reference path at or above the primary rate".
- [22] ITU-T Recommendation G.861: "Principles and guidelines for the integration of satellite and radio systems in SDH transport networks".
- [23] ITU-T Recommendation G.957: "Optical interfaces for equipments and systems relating to the synchronous digital hierarchy".
- [24] ITU-T Recommendation O.151: "Error performance measuring equipment operating at the primary rate and above".
- [25] ITU-T Recommendation O.181: "Equipment to assess error performance on STM-N interfaces".
- [26] ETSI TR 101 036-1: "Fixed Radio Systems; Point-to-point equipment; Generic wordings for standards on digital radio systems characteristics; Part 1: General aspects and point-to-point equipment parameters".
- [27] CEPT/ERC/REC 74-01: "Spurious emissions".
- [28] ETSI TR 101 035: "Transmission and Multiplexing (TM); Synchronous Digital Hierarchy (SDH) aspects regarding Digital Radio Relay Systems (DRRS)".
- [29] ITU-R Recommendation F.1191: "Bandwidths and unwanted emissions of digital fixed service systems".
- [30] EN 60950: "Safety of information technology equipment".
- [31] Directive 1999/5/EC of the European Parliament and of the Council of 9 March 1999 on radio equipment and telecommunications terminal equipment and the mutual recognition of their conformity.
- [32] CEPT/ERC/REC 01-02: "Preferred channel arrangement for digital fixed service systems operating in the frequency band 31,8 - 33,4 GHz".
- [33] ITU-R Recommendation F.1492: "Availability objectives for real digital radio-relay links forming part of international portion constant bit rate digital path at or above the primary rate".
- [34] ITU-R Recommendation F.1493: "Availability objectives for real digital radio-relay links forming part of national portion constant bit rate digital path at or above the primary rate".
- [35] ETSI EN 300 197 (V1.2.2): "Transmission and Multiplexing (TM); Digital Radio Relay Systems (DRRS); Parameters for DRRS for the transmission of digital signals and analogue video signals operating at 38 GHz".
- [36] ETSI EN 301 489-1: "Electromagnetic compatibility and Radio spectrum Matters (ERM); ElectroMagnetic Compatibility (EMC) standard for radio equipment and services; Part 1: Common technical requirements".
- [37] ETSI EN 301 489-4: "Electromagnetic compatibility and Radio spectrum Matters (ERM); ElectroMagnetic Compatibility (EMC) standard for radio equipment and services; Part 4: Specific conditions for fixed radio links and ancillary equipment and services".

- [38] ERC Report 25: "The European table of frequency allocations and utilisations covering the frequency range 9 kHz to 275 GHz".
- [39] ITU Radio Regulations.

3 Definitions, symbols and abbreviations

3.1 Definitions

For the purposes of the present document, the following terms and definitions apply:

STM-0: medium capacity SDH radio transport module (51,840 Mbit/s AU-3 equivalent, also referred as STM-0 by ITU-T Recommendation G.861)

sub-STM-0: low capacity SDH radio transport module (n times VC-12 or VC2 equivalent)

3.2 Symbols

For the purposes of the present document, the following symbols apply:

Ω	Ohm
CSmin	minimum practical Channel Separation (for a given radio-frequency channel arrangement)
dBi	decibel relative to isotropic radiator
dB	decibel
dBm	decibel relative to 1 mW
dBu	decibel relative to 1microVolt
dBW	decibel relative to 1 W
GHz	GigaHertz
kHz	kiloHertz
Mbit/s	Megabits per second
MHz	MegaHertz
mW	milliWatt
ppm	parts per million

3.3 Abbreviations

For the purposes of the present document, the following abbreviations apply:

ac	alternating current
ACAP	Adjacent Channel Alternate Polarization
ACCP	Adjacent Channel Co-Polarization
ATPC	Automatic Transmit Power Control
AU	Administrative Unit
BER	Bit Error Rate
C/I	Carrier to Interference ratio
CEPT	Conférence des Administrations Européennes des Postes et Télécommunications
CMI	Coded Mark Inversion
CW	Continuous Wave
dc	direct current
DRRS	Digital Radio Relay Systems
EIRP	Equivalent Isotropically Radiated Power
EMC	ElectroMagnetic Compatibility
ESR	Errored Second Ratio
FSK	Frequency-Shift Keying (modulation)
IF	Intermediate Frequency
IPI	Inter-Port Isolation
LO	Local Oscillator
n.a.	not attributed

PDH	Plesiochronous Digital Hierarchy
PRBS	Pseudo Random Binary Sequence
QAM	Quadrature Amplitude Modulation
RBER	Residual Bit Error Rate
RF	Radio Frequency
RFC	Remote Frequency Control
RSL	Receive Signal Level
RTPC	Remote Transmit Power Control
SDH	Synchronous Digital Hierarchy
SOH	Section OverHead
STM-N	Synchronous Transport Module, level N
TMN	Telecommunications Management Network
VC	Virtual Container
XPD	cross-Polar Discrimination

4 General characteristics

4.1 Frequency bands and channel arrangements

4.1.1 Channel arrangements

4.1.1.1 Frequency arrangement for 32 GHz

The frequency range shall be 31,8 GHz to 33,4 GHz or 31 GHz to 31,3 GHz/31,5 GHz to 31,8 GHz if applicable.

The channel arrangements in the band 31,8 GHz to 33,4 GHz shall be in accordance with CEPT/ERC/REC 01-02 [32] or ITU-R Recommendation F.1492 [33]. For reader convenience, the basic parameters of the CEPT Recommendation are shown in clause A.1.1.1. In addition to this channel plan an interleaved channel plan is allowed by this ERC Recommendation.

The 31,0 GHz to 31,3 GHz band is available in some countries and included in the CEPT Report 25 [38]. Moreover the band 31,5 GHz to 31,8 GHz may be used on a national basis (see footnote S5.5461 of the ITU Radio Regulations [39]). The present document therefore also covers the bands 31,0 GHz to 31,3 GHz and 31,5 GHz to 31,8 GHz provided that the channel arrangement is based on the channel separation as stated in the CEPT/ERC/REC 01-02 [32] for the band 31,8 GHz to 33,4 GHz.

4.1.1.2 Frequency arrangement for 38 GHz

The frequency range shall be 37 GHz to 39,5 GHz. The channel arrangements shall be in accordance with CEPT Recommendation T/R 12-01 [1]. For reader convenience, the basic parameters of the CEPT Recommendation are shown in clause A.1.2.

4.2 Channel spacing for systems operating on the same route

System bit rates and their relevant channel spacing in the present document are reported in table 1 (for the precise payload bit rates, see clause 5.1).

NOTE: According to systems characteristics the equipment can be connected either to separate antennas or on a separate polarization to the same antenna.

Table 1: Digital systems channel spacings for various bit rates

	Payload Bit Rate [Mbit/s]⇒	2	2 × 2	8	2 × 8	34	51	140 and 155
Channel Spacings [MHz]	Class 2 equipments	3,5	3,5	7	14	28	56	
	Class 4 equipment			3,5	7	14	14/28	56
	Class 5 equipment							28

NOTE:

- $n \times 2$ Mbit/s and $n \times 34$ Mbit/s bit rates may be used where appropriate.
- $n \times 2$ Mbit/s mapped into SDH VC12 transport bit rates (sub-STM-0 defined by ITU-T Recommendation G.708 [17]) may be used where appropriate (e.g. three or four times VC12 into an 8 Mbit/s channel spacing).
- The class 2 (2 Mbit/s) in 3,5 MHz and the class 4 in 28 MHz reflects equipment more typical to a class 1 (2Mbit/s) and class 3 (STM-0) system and as a result the adjacent channel interference parameters are more stringent.

For regulatory purposes in national procedures for licensing radio equipment according to the present document, the above system types shall be identified by the "system type codes" reported in annex B.

4.3 Compatibility requirements between systems

The compatibility requirements between systems are as follows:

- there shall be no requirement to operate transmitting equipment from one manufacturer with receiving equipment from another;
- there shall not be a requirement to multiplex different manufacturers equipment on the same or on different polarization of the same antenna;
- depending on the application, it shall be possible to operate the system in vertical and/or horizontal polarization, if required by the channel arrangement.

4.4 Performance and availability requirements

Digital equipment shall be designed in order to meet network performance and availability requirements defined in ITU-R Recommendations F.1397 [21], F.1491 [13], F.1492 [33] and F.1493 [34] for the national portion of the digital connection.

4.5 Environmental conditions

The equipment shall be required to meet the environmental conditions set out in ETS 300 019 [5] which defines weather protected and non-weather protected locations, classes and test severity. The manufacturer shall state which class the equipment is designed to withstand.

4.5.1 Equipment within weather protected locations (indoor locations)

Equipment intended for operation within temperature controlled locations or partially temperature controlled locations shall meet the requirements of ETS 300 019 [5] classes 3.1 and 3.2 respectively.

Optionally, the more stringent requirements of ETS 300 019 [5] classes 3.3 (non-temperature controlled locations), 3.4 (sites with heat trap) and 3.5 (sheltered locations) may be applied.

4.5.2 Equipment for non-weather protected locations (outdoor locations)

Equipment intended for operation within non-weather-protected locations shall meet the requirements of ETS 300 019 [5], class 4.1 or 4.1E.

Class 4.1 applies to many European countries and class 4.1E applies to all European countries.

4.6 Power supply

The power supply interface shall be in accordance with the characteristics of one or more of the secondary voltages foreseen in ETS 300 132-1 [6] and EN 300 132-2 [7].

NOTE: Some applications may require secondary voltages that are not covered by ETS 300 132-1 [6] or EN 300 132-2 [7].

4.7 Electromagnetic compatibility

Equipment shall operate under the conditions specified in EN 300 385 [8], EN 301 489-1 [36] and EN 301 489-4 [37].

4.8 System block diagram

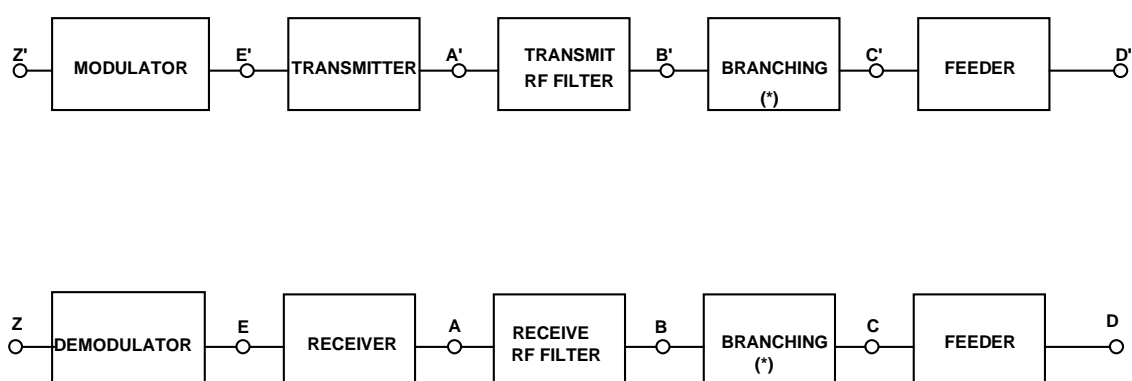

(*) NO FILTERING INCLUDED

NOTE 1: For the purpose of defining the measurement points, the branching network does not include a hybrid.

NOTE 2: The points shown above are reference points only; points C and C', D and D' in general coincide.

NOTE 3: Points B and C, B' and C' may coincide when simple duplexer is used.

Figure 2: System block diagram

4.9 Telecommunications Management Network (TMN) interface

For SDH equipment ITU-T Recommendations G.784 [20] and G.773 [16] and ITU-R Recommendations F.750 [11] and F.751 [12] give the general requirements for TMN interface and functionality. ETS 300 635 [9], ETS 300 785 [10] and EN 300 645 [4] give the radio specific functional block description and the related radio fragment information model respectively.

NOTE: The standardization of TMN interface functionality is under study in ETSI TMN, and will be applicable to the radio relay systems considered in the present document.

4.10 Branching/feeder/antenna characteristics

4.10.1 Antenna radiation patterns

See EN 300 833 [3].

4.10.2 Antenna cross-Polar Discrimination (XPD)

See EN 300 833 [3].

4.10.3 Antenna Inter-Port Isolation (IPI)

See EN 300 833 [3].

4.10.4 Waveguide flanges (or other connectors)

When flanges are required at reference point C, C', the following shall be used according to IEC 60154-2 [18]:

- UBR/PBR-320, for the complete frequency range.

4.10.5 Return loss

Equipment according to the present document is likely to have integral antennas or very similar technical solutions, without long feeder connections; return loss is not considered an essential requirement. When an antenna is an integral part of the equipment there shall be no requirement.

For feeder/antenna return loss requirement see annex A.

5 System Parameters

5.1 Transmission capacity

Payload bit rates considered in the present document are:

- 2,048 Mbit/s;
- $2 \times 2,048$ Mbit/s;
- 8,448 Mbit/s;
- $2 \times 8,448$ Mbit/s;
- 34,368 Mbit/s;
- 51,840 Mbit/s (STM-0);
- 139,264 Mbit/s; and
- 155,520 Mbit/s (STM-1).

System rates configured as n-times 2 Mbit/s or n-times 34 Mbit/s or n-times 2 Mbit/s mapped into SDH VC-12 (sub-STM-0) are also considered.

In the following clauses, these capacities will be simply referred as 2 Mbit/s, 2×2 Mbit/s, 8 Mbit/s, 2×8 Mbit/s, 34 Mbit/s, 51 Mbit/s (STM-0), 140 Mbit/s, and 155 Mbit/s (STM-1) respectively.

5.2 Baseband parameters

All the following specified baseband parameters refer to point Z and Z' of figure 2. Parameters for service channels and wayside traffic channels are outside the scope of the present document.

5.2.1 Plesiochronous interfaces

Plesiochronous interfaces at 2 Mbit/s, 8 Mbit/s, 34 Mbit/s and 140 Mbit/s shall comply with ITU-T Recommendation G.703 [14].

5.2.2 SDH baseband interface

The SDH baseband interface shall be in accordance with ITU-T Recommendations G.703 [14], G.707 [15], G.783 [19], G.784 [20], G.957 [23] and F.751 [12]. For sub-STM-0 rates ITU-T Recommendation G.861 [22] mapping applies.

Two STM-1 interfaces shall be possible:

- Coded Mark Inversion (CMI) electrical (ITU-T Recommendation G.703 [14]); and
- Optical (ITU-T Recommendation G.957 [23]).

The use of reserved bytes contained in the Section Overhead (SOH), and their termination shall be in accordance with ITU-R Recommendations F.750 [11], F.751 [12] and for sub-STM-0 with ITU-T Recommendation G.861 [22].

NOTE: Further details on the possible use of the SOH bytes reserved for future international standardization are given in TR 101 035 [28].

5.3 Transmitter characteristics

The specified transmitter characteristics shall be met with the appropriate baseband signals applied at reference point Z' of figure 2. For PDH interface this shall be a Pseudo Random Binary Sequence (PRBS) according to ITU-T Recommendation O.151 [24] while for SDH interface ITU-T Recommendation O.181 [25] test signal applies.

5.3.1 Transmitter power range

According to CEPT Recommendation T/R 12-01 [1] maximum Equivalent Isotropically Radiated Power (EIRP) shall be less than +80 dBm. Transmitter maximum mean output power at reference point C' of the system block diagram (see figure 2) shall not exceed +30 dBm (including tolerance and, if applicable, ATPC/RTPC influence).

Regulatory administrations may define nominal sub-ranges below this maximum limit.

NOTE: The technological evolution may result in equipment falling outside of the range(s) foreseen in this clause. In this case the equipments of different output power sub-ranges are not considered to require individual type approval, however their use is subject to individual national agreements.

A capability for output power level adjustment may be required for regulatory purposes, in which case the range of adjustment, either by fixed or automatic attenuators, should be in steps of 5 dB or less.

5.3.2 Transmit power and frequency control

5.3.2.1 Automatic Transmit Power Control (ATPC)

ATPC is an optional feature. Equipment with ATPC will be subject to manufacturer declaration of ATPC ranges and related tolerances. The manufacturer shall declare if the equipment is designed with ATPC as a fixed permanent feature. Testing shall be carried out with output power level corresponding to:

- ATPC set manually to a fixed value for system performance (see clauses 5.5 and 5.6);
- ATPC set at maximum available power for transmit performance (see clause 5.3).

It shall be verified that the emitted RF spectrum is within the absolute RF spectrum mask evaluated for the maximum available output power of the equipment, including the attenuation introduced by RTPC, if any.

NOTE: Where the use of ATPC is considered compulsory for regulatory purposes the transmitter output power should meet the spectrum mask limits throughout the ATPC range.

5.3.2.2 Remote Transmit Power Control (RTPC)

RTPC is an optional feature. Equipment with RTPC will be subject to manufacturer declaration of RTPC ranges and related tolerances. Testing shall be carried out with output power level corresponding to:

- RTPC set to the maximum nominal power for transmit performance (see clause 5.3) and for system performance (see clauses 5.5 and 5.6).
- The RF spectrum mask shall be verified in three points (low, medium, and high) of the RTPC power excursion and with ATPC set to maximum available power (if any). When these spectrum measurements are made difficulties may be experienced. Actual measurement methods shall be addressed in further investigations and will be defined in the conformance testing standard, i.e. EN 301 126-1 [2].
- RTPC range should be restricted, taking into account the wideband noise generated by the transmitter chain, to ensure the spectrum mask requirements are met throughout the transmitter output power range.

NOTE: Where the use of ATPC is considered compulsory for regulatory purposes the transmitter output power should meet the spectrum mask limits throughout the ATPC range.

5.3.2.3 Remote Frequency Control (RFC)

RFC is an optional feature. Equipment with RFC will be subject to manufacturer declaration of RFC ranges and related change frequency procedure. Testing shall be carried out including:

- RFC setting procedure at least for three frequencies (lower, centre and higher of the covered range);
- RFC setting procedure shall not produce emissions outside the previous and final frequency spectrum mask.

5.3.3 Transmitter output power tolerance

The nominal output power shall be declared by the supplier.

The tolerance of the nominal output power shall be within:

- nominal output power ± 3 dB: for systems operating within non-weather-protected locations and within classes 3.3, 3.4 and 3.5 weather protected locations;
- nominal output power ± 2 dB: for systems operating within other classes of weather protected locations.

Equipment supplier may choose to limit the transmitter output power tolerance to ± 2 dB for all environmental classes. In this case specific declaration shall be made to fulfil any conformance procedure.

For Class 5b systems refer to annex C for further details.

5.3.4 Transmit Local Oscillator (LO) frequency arrangements

There shall be no requirement on transmit LO frequency arrangement.

5.3.5 RF spectrum mask

The spectrum masks are shown in figures 3a to 3d.

The 0 dB level shown on the spectrum masks relates to the spectral power density of the nominal centre frequency disregarding residual carrier.

Masks shall be measured with a modulating base-band signal given by a PRBS signal given in ITU-T Recommendation O.151 [24] in the case of PDH signal or ITU-T Recommendation O.181 [25] in the case of STM-1 signal.

The masks do not include frequency tolerance.

The recommended spectrum analyser settings for measuring the RF spectrum mask detailed in figures 3a to 3d are shown in table 2.

Table 2: Spectrum analyser settings for RF power spectrum measurement

Channel Spacing [MHz]	3,5	7	14	28	56
Centre Frequency	Actual	Actual	Actual	Actual	Actual
Sweep width [MHz]	20	40	80	160	320
Scan time	Auto	Auto	Auto	Auto	Auto
IF bandwidth [kHz]	30	30	30	100	100
Video bandwidth [kHz]	0,1	0,3	0,3	0,3	0,3

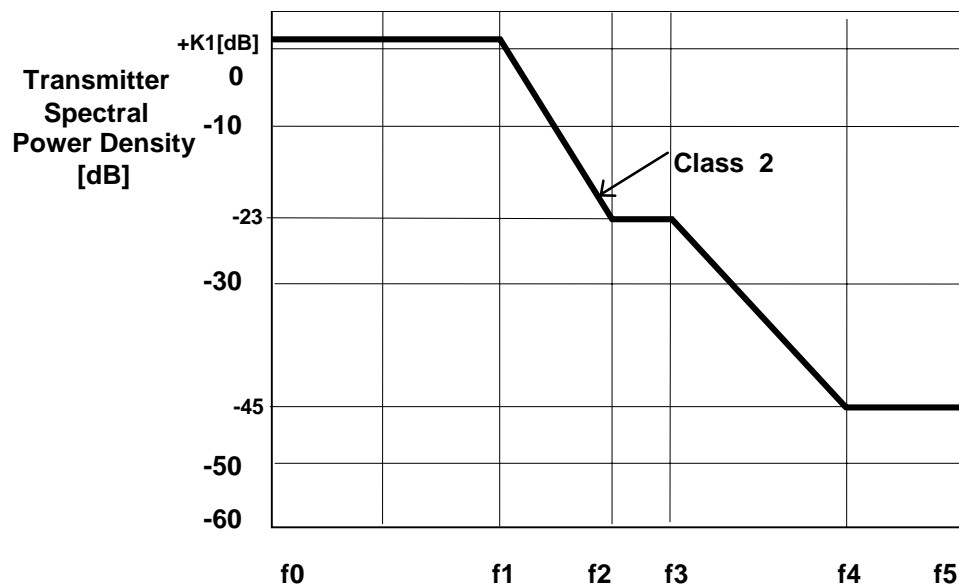

NOTE: Frequency expressed from actual transmitter centre frequency [MHz].

Figure 3a: Limits of spectral power density for class 2 systems

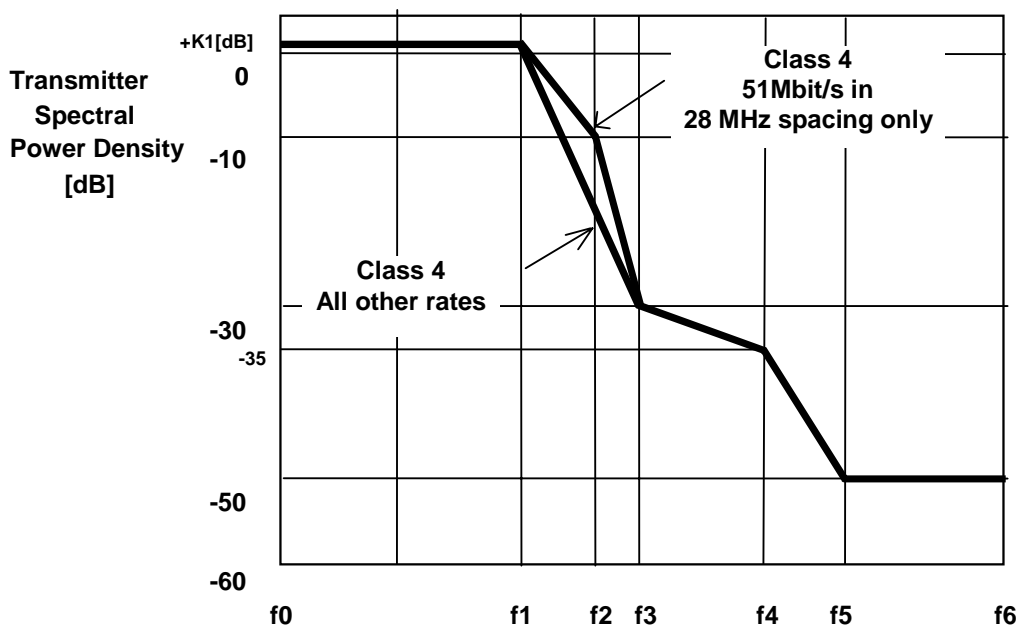

NOTE: Frequency expressed from nominal transmitter centre frequency [MHz].

Figure 3b: Limits of spectral power density for class 4 systems

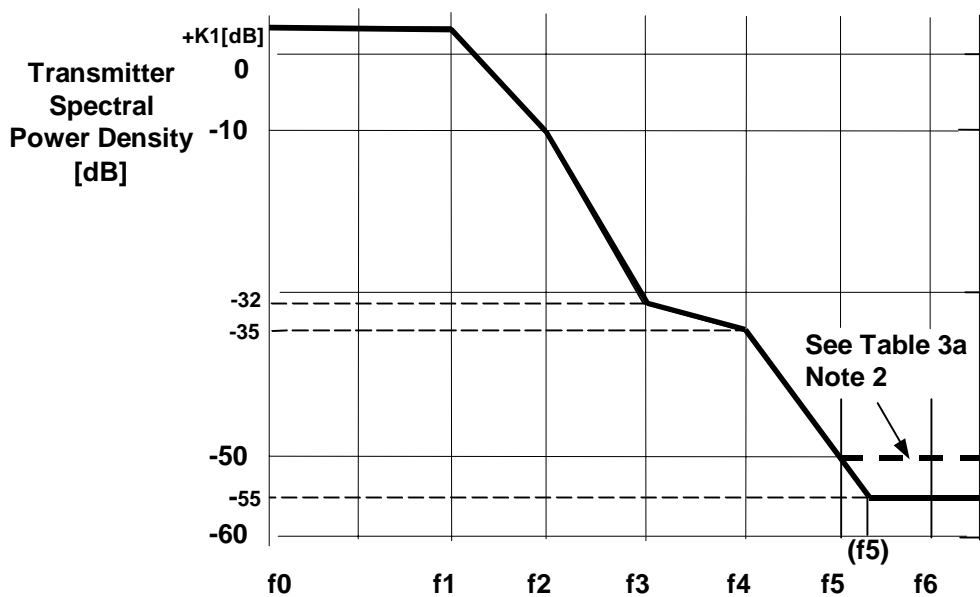

NOTE: Frequency expressed from actual transmitter centre frequency [MHz].

Figure 3c: Limits of spectral power density for Class 5a systems

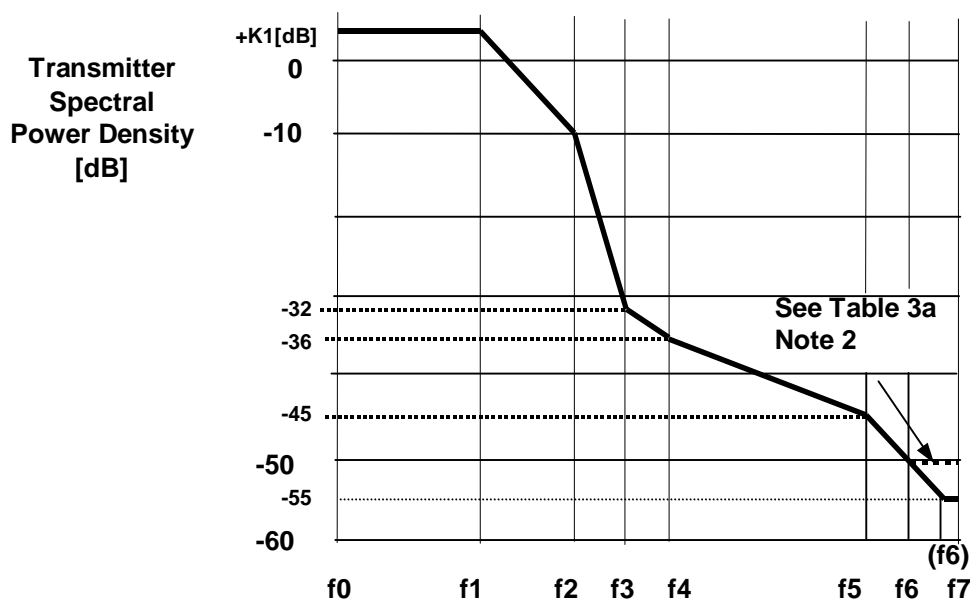

NOTE: Frequency expressed from actual transmitter centre frequency [MHz].

Figure 3d: Limits of spectral power density for Class 5b systems

Due to limitations of some spectrum analysers, difficulties may be experienced when testing high capacity/wideband systems. In this event, the following options are to be considered: measurement using high performance spectrum analyser, use of notch filters and two-step measurement technique. Where difficulties are experienced, the plots of one test conducted at ambient and environmental extremes may be produced as evidence to conformance to the spectrum mask.

Reference frequencies f_1 to f_7 and relative attenuation K_1 [dB] are reported in table 3a for the bit rate and channel spacing foreseen.

Table 3a: Spectrum mask frequency limits

Spectrum efficiency class	Bit-rate [Mbit/s]	Channel spacing [MHz]	Figure	K_1 [dB]	f_1 [MHz]	f_2 [MHz]	f_3 [MHz]	f_4 [MHz]	f_5 [MHz]	f_6 [MHz]	f_7 [MHz]
2	2	3,5	3a	+1	1,3	2	2,3	4,3	8,75	n.a.	n.a.
	2 x 2	3,5		+1	1,4	2,8	3,5	7	8,75	n.a.	n.a.
	8	7		+1	2,8	5,6	7	14	17,5	n.a.	n.a.
	2 x 8	14		+1	5,6	11,2	14	28	35	n.a.	n.a.
	34	28		+1	11	19	25	45	70	n.a.	n.a.
	51	56		+1	18	32	40	70	140	n.a.	n.a.
4	8	3,5	3b	+1	1,4	n.a.	2,8	3,5	6,15	8,75	n.a.
	2 x 8	7		+1	2,8	n.a.	5,6	7	12,25	17,5	n.a.
	34	14		+1	5,6	n.a.	11,2	14	24,5	35	n.a.
	51	14		+1	7	n.a.	9,5	14	24,5	35	n.a.
	51	28		+1	7,5	10,5	12,5	22	30	70	n.a.
	140 or 155	56		+1	22,5	n.a.	33	65	74	140	n.a.
5a	140 or 150	28	3c	+2	12,5	15	17	20	60	70	n.a.
5b	140 or 150	28	3d	+2	12	14,5	15,5	17	40	50	70

NOTE 1: n.a.: not applicable.

NOTE 2: The mask floor at 55 dB is required for guaranteeing RBER performance in the presence of multiple adjacent channels regardless of the FEC algorithm implemented, however for regulatory purposes attenuation greater than 50 dB is not required. The corresponding f_1 to f_7 values for a mask floor of 50 dB are reported in table 3b.

Table 3b: Spectrum mask frequency limits for mask floor of 50 dB

Spectrum efficiency class	Bit-rate [Mbit/s]	Channel spacing [MHz]	Figure	K1 [dB]	f 1 [MHz]	f 2 [MHz]	f 3 [MHz]	f 4 [MHz]	f 5 [MHz]	f 6 [MHz]	f 7 [MHz]
5a	140 or 150	28	3c	+2	12,5	15	17	20	50	70	n.a.
5b	140 or 150	28	3d	+2	12	14,5	15,5	17	40	47	70

5.3.6 Discrete CW lines exceeding the spectrum mask limit

5.3.6.1 Spectral lines at the symbol rate

The power level (reference point B') of spectral lines at a distance from the channel centre frequency equal to the symbol rate shall be more than 23 dB below the average power level of the carrier for class 2, 37 dB for class 4 and 5a and 43 dB for class 5b.

5.3.6.2 Other spectral lines

In case some CW components exceed the spectrum mask, an additional allowance is given.

Those lines shall not:

- exceed the mask by a factor more than $\{10 \log (CS_{\min}/IF_{bw}) - 10\}$ dB;
- be spaced each other in frequency by less than CS_{\min} .

Where:

$$CS_{\min} = 1\,750 \text{ kHz}$$

IF_{bw} is the recommended resolution bandwidth, expressed in kHz, reported in table 2.

Figure 4 shows a typical example of this requirement.

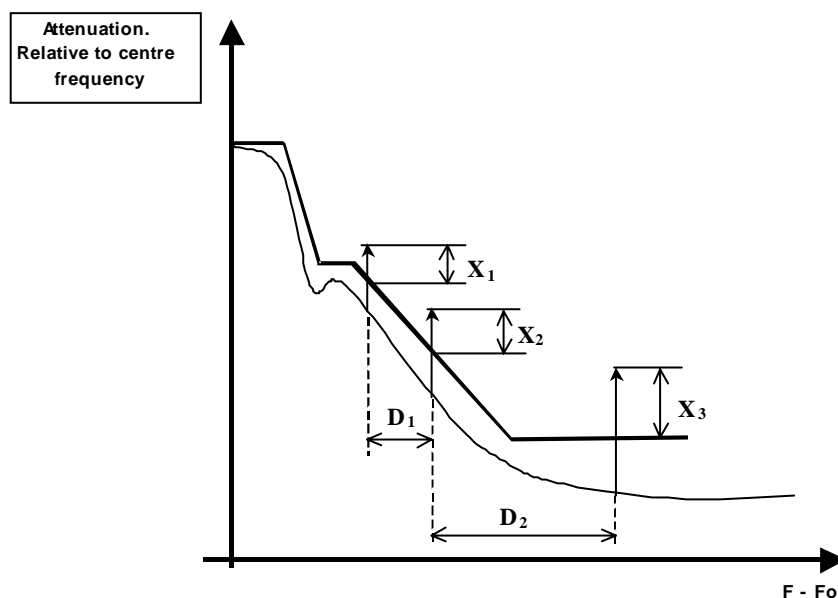

$$X_1, X_2, X_3 \text{ [dB]} \leq 10 \log (CS_{\min}/IF_{bw}) - 10$$

$$D_1, D_2 \geq CS_{\min}$$

Figure 4: CW lines exceeding the spectrum mask (typical example)

5.3.7 Spurious emissions

It is necessary to define spurious emissions from transmitters for two reasons:

- a) to limit interference into systems operating wholly externally to the system channel plan (external emissions);
- b) to limit local interference within the system where transmitters and receivers are directly connected via the filter and branching systems (internal emissions).

This leads to two sets of spurious emission limits where the specific limits given for "internal" interference are required to be no greater than the "external" level limits at reference point B' for indoor systems and C' for outdoor systems (where a common Tx/Rx duplexer is used).

5.3.7.1 Spurious emissions-external

According to ITU-R Recommendation F.1191 [29], and CEPT/ERC/REC 74-01 [27], the external spurious emissions are defined as emissions at frequencies which are outside the nominal carrier frequency $\pm 250\%$ of the relevant channel separation.

The limits of these emissions shall conform to CEPT/ERC/REC 74-01 [27].

5.3.7.2 Spurious emissions-internal

Given that there is no requirement to multiplex equipment of different supplier on the same antenna, there is no requirement for internal spurious emissions.

5.3.8 Radio frequency tolerance

Maximum radio frequency tolerance shall not exceed ± 15 ppm. This limit includes both short-term factors (environmental effects) and long-term ageing effects.

In the type test the manufacturer shall state the guaranteed short-term part and the expected ageing part.

5.4 Receiver characteristics

5.4.1 Input level range

The input level range for a BER $< 10^{-3}$ shall extend for a minimum of 50 dB above the threshold limit specified for BER = 10^{-3} in clause 5.5.1 referenced to point C.

The input level range for a BER $< 10^{-8}$ shall extend for a minimum of 41 dB above the threshold limit specified for BER = 10^{-8} in clause 5.5.1 referenced to point C.

However an upper limit above -20 dBm is not required for BER = 10^{-3} and -24 dBm for BER = 10^{-8} .

For equipment designed to operate only with ATPC as a fixed permanent feature, the above maximum input levels are reduced by an amount up to the ATPC range.

5.4.2 Receiver Local Oscillator (LO) frequency arrangements

There shall be no requirement on receiver LO frequency arrangement.

5.4.3 Spurious emissions

The limits of these emissions shall conform to CEPT/ERC/REC 74-01 [27].

5.4.3.1 Spurious emissions-external

The limits of these emissions shall conform to CEPT/ERC/REC 74-01 [27].

5.4.3.2 Spurious emissions-internal

Given that there is no requirement to multiplex equipment of different supplier on the same antenna, there is no requirement for internal spurious emissions.

5.5 System performance without diversity

All parameters are referred to reference point C of figure 2. Losses in RF couplers used for protected systems are not taken into account in the limits specified below.

All measurements shall be carried out with the test signals defined in clause 5.3.

5.5.1 BER as a function of Receiver input Signal Level (RSL)

32 GHz receiver BER thresholds (dBm) referred to reference point C of the system block diagram (see figure 2) for a BER of 10^{-3} , 10^{-6} and 10^{-8} shall be equal to or lower than those stated in table 4a.

Table 4a: BER performance thresholds for 32 GHz band

Spectrum efficiency class ↓	Bit-rate [Mbit/s] ↓	Channel spacing [MHz] ↓	RSL @ 10^{-3}	RSL @ 10^{-6}	RSL @ 10^{-8}
			[dBm]	[dBm]	[dBm]
2	2	3,5	-88	-84	-81
	2 x 2	3,5	-85	-81	-78
	8	7	-82	-78	-75
	2 x 8	14	-79	-75	-72
	34	28	-76	-72	-69
4	51	56	-75	-71	-68
	8	3,5	-78	-75	-72
	2 x 8	7	-75	-72	-69
	34	14	-72	-69	-66
	51	14	-71	-68	-65
5a	140 or 155	51	-73	-70	-67
		140 or 155	56	-68	-65
5b	140 or 155	28	-62	-59	-57
			-64	-61	-59

NOTE: Besides the adjacent channel interference behaviour, the design criteria for both class 5a and 5b systems are likely to be similar. Therefore, in order to offer the market with more coherent options, the design objective for RSL of new design for class 5a equipment should be better based on the class 5b performance.

38 GHz receiver BER thresholds (dBm) referred to reference point C of the system block diagram (see figure 2) for a BER of 10^{-3} , 10^{-6} and 10^{-8} shall be equal to or lower than those stated in table 4b.

Table 4b: BER performance thresholds for 38 GHz band

Spectrum efficiency class ↓	Bit-rate [Mbit/s] ↓	Channel spacing [MHz] ↓	RSL @ 10 ⁻³	RSL @ 10 ⁻⁶	RSL @ 10 ⁻⁸
			[dBm]	[dBm]	[dBm]
2	2	3,5	-86	-82,5	-80
	2 x 2	3,5	-83	-79,5	-77
	8	7	-80	-76,5	-74
	2 x 8	14	-77	-73,5	-71
	34	28	-74	-70,5	-68
4	51	56	-73	-69,5	-67
	8	3,5	-76	-72,5	-70
	2 x 8	7	-73	-69,5	-67
	34	14	-70	-66,5	-64
	51	14	-69	-65,5	-63
5a	51	28	-71	-67,5	-65
	140 or 155	56	-66	-62,5	-60
5b	140 or 155	28	-61	-58	-56
5b	140 or 155	28	-63	-60	-58

NOTE: Besides the adjacent channel interference behaviour, the design criteria for both class 5a and 5b systems are likely to be similar. Therefore, in order to offer the market with more coherent options, the design objective for RSL of new design for class 5a equipment should be better based on the class 5b performance

5.5.2 Equipment Residual BER

The RBER level under simulated operating conditions without interference shall be guaranteed with a signal level at reference point C which is between 10 dB and 35 dB above the level which gives BER = 10⁻⁶ (as specified in clause 5.5.1). However an upper limit above -28 dBm is not required.

To guarantee a higher degree of service, see clause A.4, the network operator may require equipment to meet a RBER limit with the first adjacent channel interferer. In this case the RBER level under simulated operating conditions with interference shall be guaranteed with a signal level at reference point C which is between 15 dB and 35 dB above the level which gives BER = 10⁻⁶ (as specified in clause 5.5.1). The interferer level shall be set to represent a Carrier to Interference ratio (C/I) of +4dB for class 5a systems (this figure includes a 10 dB offset to account for the minimum cross polar discrimination of these systems), -3 or -4 dB for class 5b systems (refer to annex C) for all other system classes the C/I shall be set to -6 dB or, in case the supplier has declared the tighter TX output power tolerance according clause 5.3.3, to -4 dB.

The RBER shall be:

- for systems capacity less than 34 Mbit/s: RBER < 10⁻¹⁰;
- for systems capacity above 34 Mbit/s: RBER < 10⁻¹¹;
- for systems capacity at 140/155 Mbit/s: RBER < 10⁻¹².

This requirement is intended for the payload bit rates defined in clause 5.1.

EN 301 126-1 [2] recognizes that this requirement is subject to a supplier declaration only. However, in clause A.4 some background information relating to the actual test methods and test confidence is given.

5.5.3 Interference sensitivity

All receive signal levels and Carrier to Interference ratio (C/I) measurements are referred to reference point C of the RF system block diagram (see figure 2).

5.5.3.1 Co-channel interference sensitivity

The limits of Carrier to Interference ratio (C/I) in case of Co-channel Interference (C/I) shall be as in table 5, giving maximum C/I values for 1 dB and 3 dB degradation of the 10^{-6} BER limits specified in clause 5.5.1.

The indicative behaviour for these and other values of degradation may be found in figures A.5.1a and A.5.1b.

Table 5: Co-channel interference sensitivity

Co-channel interference		degradation →	C/I at BER @ 10^{-6} RSL degradation	
			1 dB	3 dB
Spectrum efficiency class ↓	Bit rate [Mbit/s] ↓	Channel spacing [MHz] ↓		
2	2	3,5	23	19
	2 x 2	3,5	23	19
	8	7	23	19
	2 x 8	14	23	19
	34	28	23	19
	51	56	23	19
4	8	3,5	30	26
	2 x 8	7	30	26
	34	14	30	26
	51	14	30	26
	51	28	30	26
	140 or 155	56	30	26
5a and 5b	140 or 155	28	37	33

5.5.3.2 Adjacent channel interference

The limits of adjacent channel interference shall be as given in table 6 for like modulated signals of 1 channel spacing, giving maximum C/I values for 1 dB and 3 dB degradation of the 10^{-6} BER limits specified in clause 5.5.1.

The Indicative behaviour for these and other values of degradation may be found in figures A.5.2a and A.5.2b.

Table 6: First adjacent channel interference sensitivity

First adjacent channel interference			C/I at BER @ 10^{-6} RSL degradation	
		degradation →	1 dB (see note 1)	3 dB
Spectrum efficiency class ↓	Bit rate [Mbit/s] ↓	Channel spacing [MHz] ↓		
2	2	3,5	-3	-7
	2 × 2	3,5	0	-4
	8	7	0	-4
	2 × 8	14	0	-4
	34	28	0	-4
4	51	56	0	-4
	8	3,5	-1	-5
	2 × 8	7	-1	-5
	34	14	-1	-5
	51	14	-1	-5
5a	51	28	-10	-13,5
	140 or 155	56	-1	-5
5b	140 or 155	28	(see note 2)	(see note 2)

NOTE 1: For class 2, regulatory administrations may wish to vary the value of C/I for 1 dB degradation for adjacent channel interference. Values of C/I are typically in the range 0 dB to -3 dB.

NOTE 2: Refer to annex C.

5.5.3.3 Continuous Wave (CW) spurious interference

For a receiver operating at the 10^{-6} BER threshold given in table 4, the introduction of a CW interferer at a certain level specified below, with respect to the wanted signal and at any frequency in the range 30 MHz to the second harmonic of the upper frequency of the band excluding frequencies either side of the wanted centre frequency of the RF channel by up to 250 % the channel spacing, shall not result in a BER greater than 10^{-5} .

The level of the CW interferer shall be:

- for a channel spacing lower than or equal to 14 MHz:
 - +20 dB at any frequency either side of the wanted centre frequency of the RF channel from 250 % up to 500 % the channel spacing;
 - +30 dB outside 500 % the channel spacing.
- for a channel spacing greater than 14 MHz:
 - +30 dB.

NOTE: When waveguide is used between reference point A and C, which length is higher than twice the free space wavelength of the cut-off frequency (F_c), the lower limit of measurement shall be increased to $0,7 F_c$ and to $0,9 F_c$ when the length is higher than 4 times the same wavelength.

This test is designed to identify specific frequencies at which the receiver may have a spurious response, e.g. image frequency, harmonics of the receive filter, etc. The actual test range should be adjusted accordingly. The test is not intended to imply a relaxed specification at all out of band frequencies elsewhere specified in the present document.

5.5.3.4 Front-end non-linearity requirements (two-tone CW spurious interference)

For a receiver operating at the RSL specified in clause 5.5.1 for 10^{-6} BER threshold, the introduction of two equal CW interferes each with a level of +19 dB, with respect to the wanted signal and located at the second and fourth adjacent channel in the receive half-band, shall not result in a BER greater than 10^{-5} .

5.5.4 Distortion sensitivity

Outage from multi-path phenomena is not considered relevant for the systems subject to the present document.

5.6 System characteristics with diversity

Space diversity receive is not relevant for the systems subject to the present document.

Annex A (informative): Additional information

A.1 Radio frequency channel arrangement

A.1.1 Radio frequency channel arrangement for 32 GHz band

The relevant radio frequency channel arrangement is provided by CEPT/ERC/REC 01-02 [32]; however, for the readers' convenience, figure A.1.1 gives its general overview.

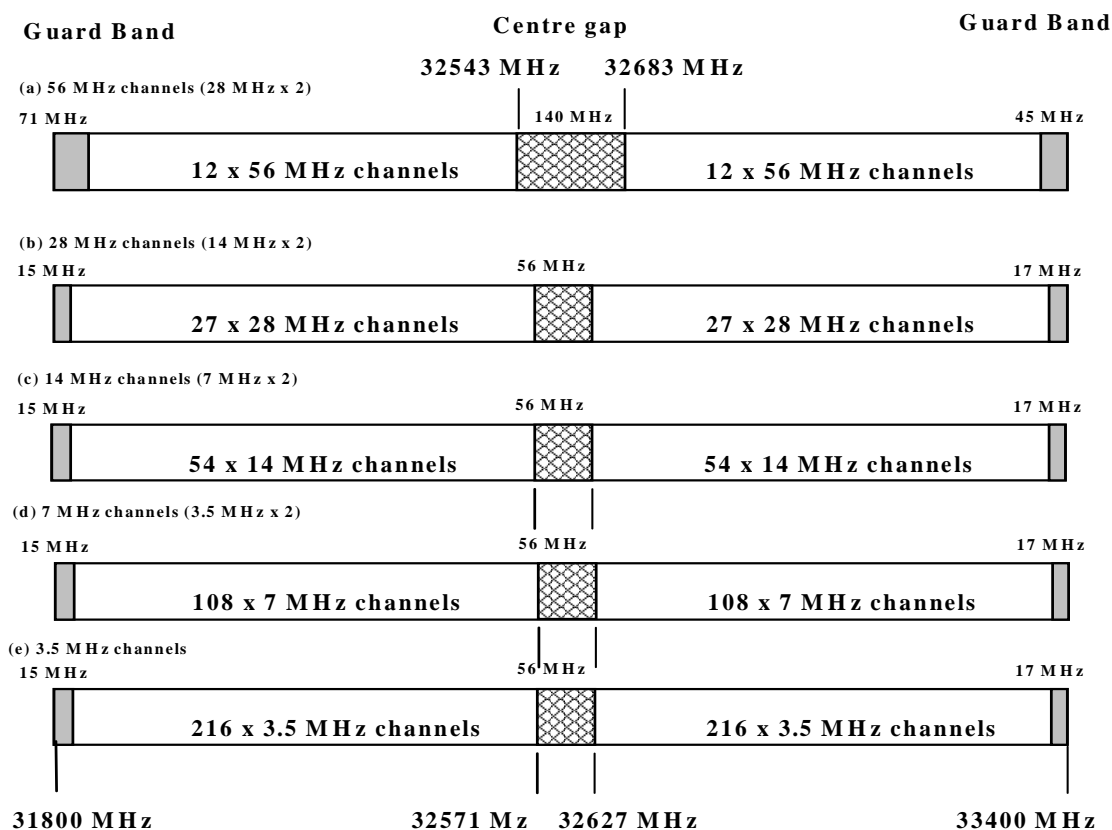

Figure A.1.1: Radio frequency channel arrangement for 32 GHz band

A.1.2 Radio frequency channel arrangement for 38 GHz band

The relevant radio frequency channel arrangement is provided by CEPT Recommendation T/R 12-01 [1]; however, for the readers' convenience, figure A.1.2 gives its general overview.

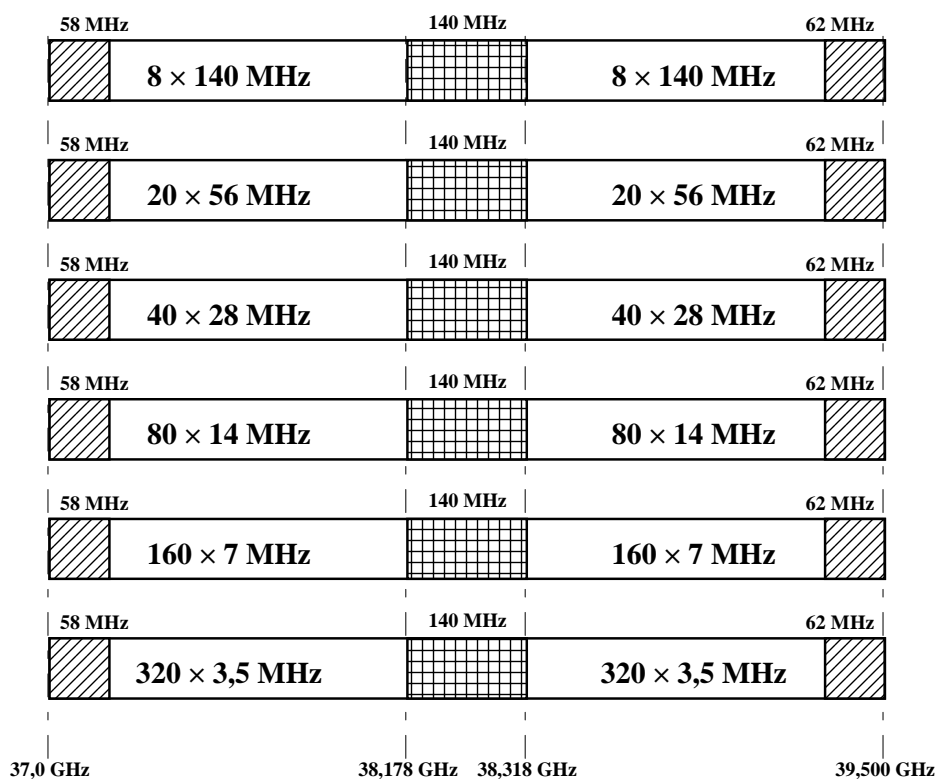

Figure A.1.2: Radio frequency channel arrangement for 38 GHz band

A.2 Feeder/antenna return loss

When separated antenna and radio equipment are concerned the antenna/feeder system return loss should be considered not less than 20 dB for class 2 systems, 23 dB for class 4 systems and 26 dB for class 5 systems. The measurement should be referred to reference point D/D' of figure 2 towards the antenna.

A.3 Automatic Transmit Power Control (ATPC)

ATPC may be useful in some circumstances, e.g.:

- to reduce interference between neighbouring systems or adjacent channels of the same system;
- to improve compatibility with analogue and digital systems at nodal stations;
- to improve residual BER or RBER performance;
- to reduce upfading problems;
- to reduce transmitter power consumption;
- to reduce digital to digital and digital to analogue distant interference between hops which re-use the same frequency;
- to increase system gain as a countermeasure against rainfall attenuation.

ATPC as an optional feature is aimed at driving the Transmit power amplifier output level from a proper minimum which facilitates the radio network planning requirements and which is used under normal propagation conditions up to a maximum value which fulfils all the specifications defined in the present document.

ATPC may also be used to increase the output power above the nominal level up to the maximum level specified by the manufacturer, with the agreement of administrations and operators, during fading conditions. This can be useful because in frequency ranges above 13 GHz the main limiting factors are given by non-selective fading events.

For planning considerations in a nodal environment a system equipped with ATPC can be considered to operate with its minimum transmitter power.

When ATPC is a fixed feature, the ATPC range is defined as the power interval from the maximum (including tolerances) output power level to the lowest transmitter output power level (at reference point B') with ATPC; when it is optional two ranges may be defined, a "down-range" from the nominal level to the minimum (including tolerances) and an "up-range" from the nominal level to the maximum (including tolerances).

A.4 Residual Bit Error Rate (RBER)

In particular applications, where there is a high density of radio links in a specific area, e.g. nodal site, closely located radios may use adjacent channels. Therefore to guarantee the grade of service the equipment will need to meet RBER criteria in the presence of an adjacent channel interferer.

The RBER is standardized in order to match the ESR (or the BER) performance required by ITU-R transmission performance recommendations.

To have sufficient confidence in the measurement, where the BER is relatively low compared to the actual payload, the test time is very long. The actual background to this measurement and the BER figures are detailed in TR 101 036-1 [26].

When error correction is a fitted feature it may be possible to reduce the measurement time by estimating the RBER using the relevant formula declared by the supplier.

Another option is to ensure that no errors occur during the minimum recording time shown in table A.4.1.

Table A.4.1: Zero errors recording times

Bit-rate under test [Mbit/s]	Minimum recording time [minutes]	Errors
2	82	0
8	21	0
34	50	0
51	34	0
140/155	108	0

A.5 Co-channel and adjacent channel interference

The performances for co-channel and adjacent channel spaced by one channel spacing C/I are reported in clauses 5.5.3.1 and 5.5.3.2 for 1 dB and 3 dB degradation only. Figures A.5.1 and A.5.2 give the indicative behaviour for other values of degradation. The values represented should not be used for frequency co-ordination purposes.

**Receiver Input Level at Reference Point C
relative to BER 10^{-6} threshold**

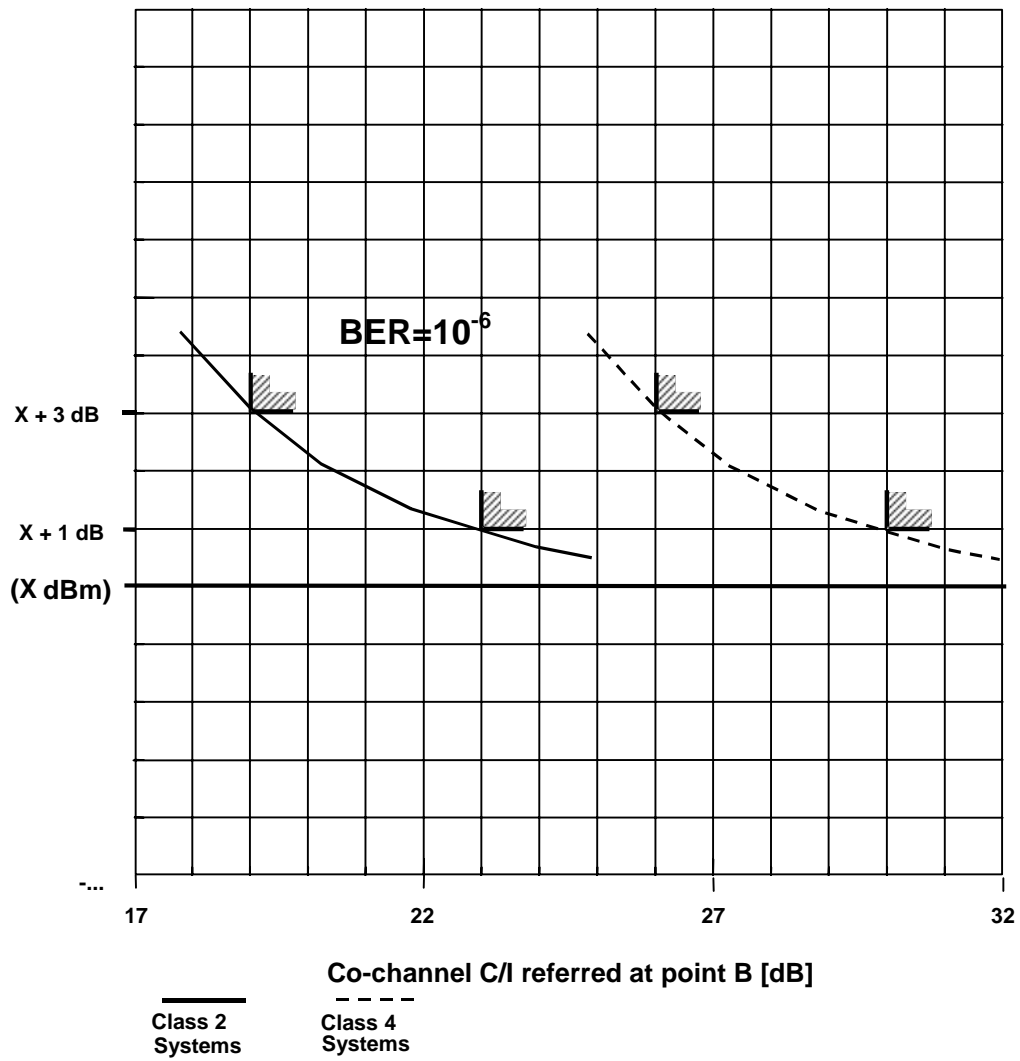

NOTE: X dBm = 10^{-6} BER threshold provided by clause 5.5.1.

Figure A.5.1a: Co-channel interference threshold degradation

Receiver Input Level at Reference Point C
relative to BER 10^{-6} threshold

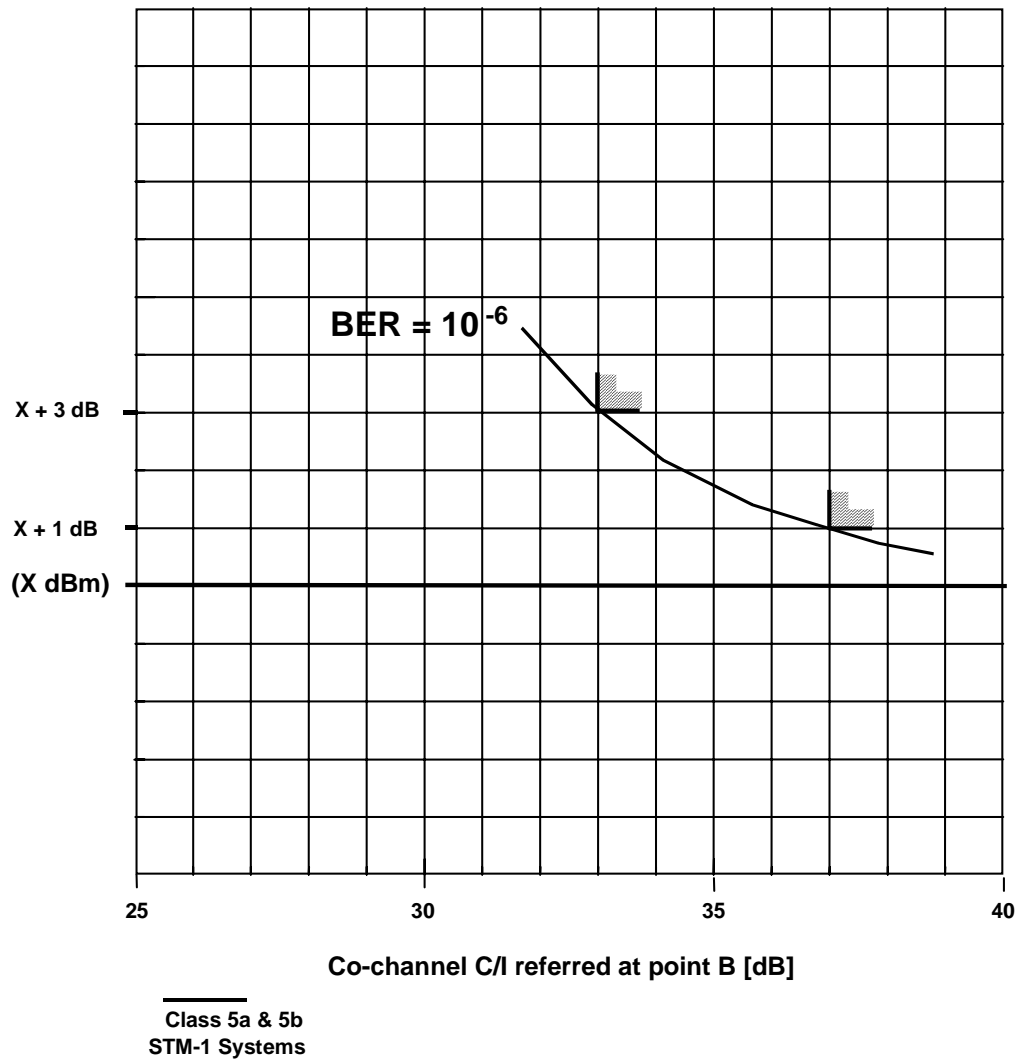

NOTE: X dBm = 10^{-6} BER threshold provided by clause 5.5.1.

Figure A.5.1b: Co-channel interference threshold degradation

Receiver Input Level at Reference Point C
relative to BER⁻⁶ threshold

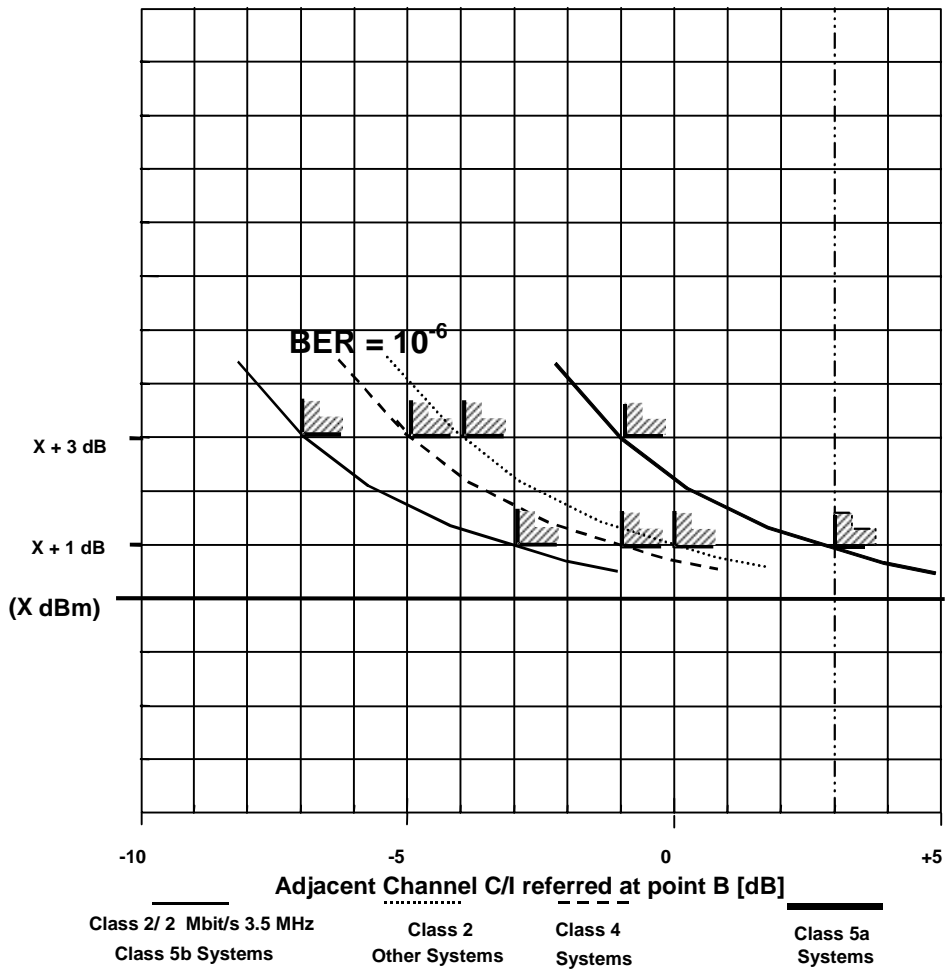

NOTE: X dBm = 10⁻⁶ BER threshold provided by clause 5.5.1.

Figure A.5.2a: First adjacent channel interference threshold degradation

Receiver Input Level at Reference Point C
relative to BER⁻⁶ threshold

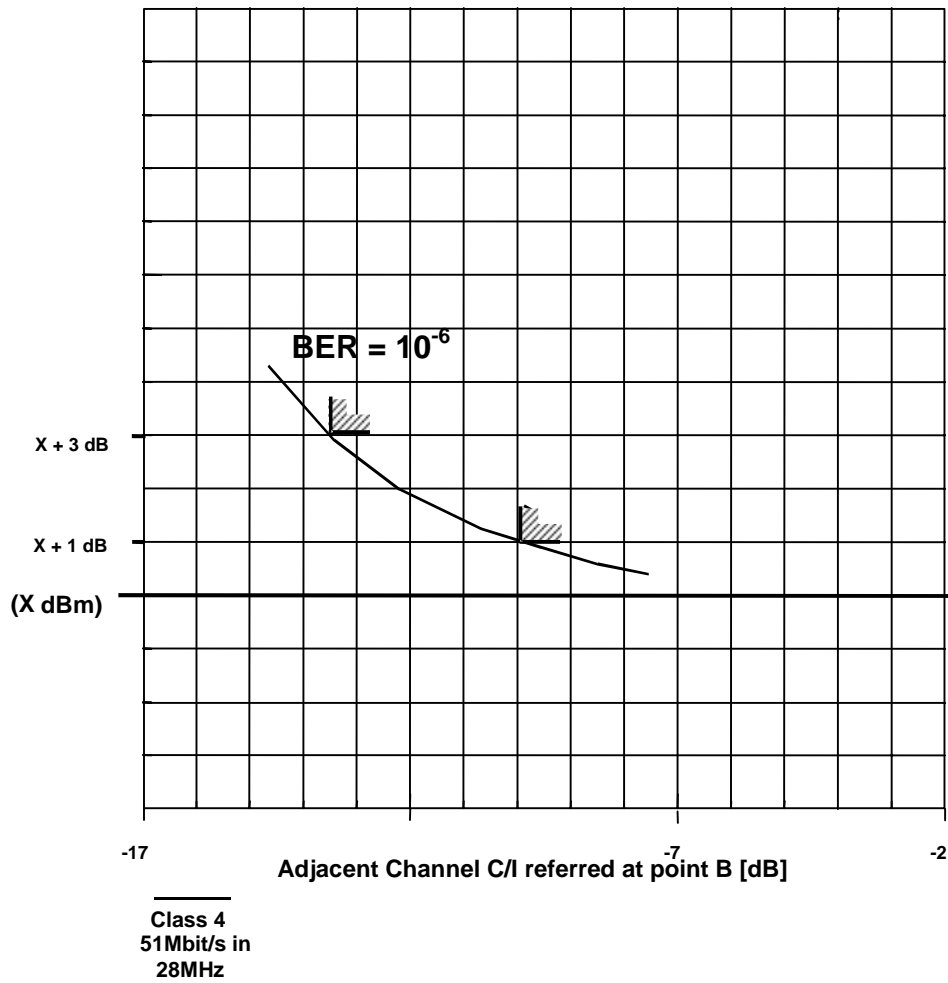

NOTE: X dBm = 10⁻⁶ BER threshold provided by clause 5.5.1.

Figure A.5.2b: First adjacent channel interference threshold degradation

Annex B (normative): System type codes for regulatory procedures

System types reported in the present document, shall be identified with the codes reported in tables B.1 and B.2 respectively.

Table B.1: System type codes for radio equipment operating at 32 GHz reported in the present document relevant to regulatory procedures for national licensing

Spectrum efficiency class ↓	System grade ↓	Channel spacing [MHz] ↓	Bit-rate [Mbit/s] ↓	System type codes ↓
2	B	3,5	2	31
		3,5	2 x 2	32
		7	8	33
		14	2 x 8	34
		28	34	35
4	n.a.	56	51	36
		28	51	37
		3,5	8	38
		7	2 x 8	39
		14	34	40
5a	n.a.	14	51	41
		56	140 or 155	42
5b	n.a.	28	140 or 155	43
5b	n.a.	28	140 or 155	44
NOTE: n.a.: not attributed.				

Table B.2: System type codes for radio equipment operating at 38 GHz reported in the present document relevant to regulatory procedures for national licensing

Spectrum efficiency class ↓	System grade ↓	Channel spacing [MHz] ↓	Bit-rate [Mbit/s] ↓	System type codes ↓
2	B	3,5	2	09
		3,5	2 x 2	10
		7	8	11
		14	2 x 8	12
		28	34	13
4	n.a.	56	51	14
		28	51	16
		3,5	8	25
		7	2 x 8	26
		14	34	27
5a	n.a.	14	51	28
		56	140 or 155	17
5b	n.a.	28	140 or 155	29
5b	n.a.	28	140 or 155	30
NOTE: n.a.: not attributed.				

Annex C (normative): Output Power Tolerance and RBER

Class 5b systems are basically sensitive systems (e.g. 128 state with a roll off of approximately 20 %) standardized for network applications that include adjacent channels on a parallel route, sometimes with terminal co-located stations shared by different network operators. In such cases, even if nominal power (or EIRP) is kept equal through common spectrum management practice, the power tolerance may endanger proper error performance with particular regard to Errored Seconds objectives unless a tighter specification for adjacent channel sensitivity is offered. Therefore it is required that either the transmitter output power tolerance is reduced or the adjacent channel sensitivity is enhanced as shown in table C.1.

Table C.1

	Output Power Tolerance	1st Adjacent Channel Interference Sensitivity	
		1 dB	3 dB
Option 1	+2 dB/-1 dB	-3	-7
Option 2	±2 dB	-4	-8

The RBER measurement with first adjacent channel interference is performed, in case of adoption of Option 1, with the first adjacent channel interference 3 dB above the signal level and, in case of adoption of option 2, with the first adjacent channel interference 4 dB above the signal level.

History

Document history		
Edition 1	April 1994	Publication as ETS 300 197
Amendment 1	April 1995	Amendment 1 to 1 st Edition of ETS 300 197
Amendment 2	March 1997	Amendment 2 to 1 st Edition of ETS 300 197
V1.2.1	February 1998	Publication
V1.2.2	November 1998	Publication
V1.3.1	November 2000	Publication
V1.4.1	February 2001	Publication
V1.5.1	October 2001	Publication
V1.6.1	March 2002	One-step Approval Procedure OAP 20020712: 2002-03-13 to 2002-07-12
V1.6.1	July 2002	Publication