

**Services and Protocols for Advanced Networks (SPAN);  
Service Provider Access;  
Service Provider Access Requirements  
in a Fixed and Mobile Environment**

---



---

Reference

REG/SPAN-141608

---

Keywords

access, internet, management, mobility, NNI,  
protocol, roaming, UMTS, UNI, UPT

**ETSI**

650 Route des Lucioles  
F-06921 Sophia Antipolis Cedex - FRANCE

Tel.: +33 4 92 94 42 00 Fax: +33 4 93 65 47 16

Siret N° 348 623 562 00017 - NAF 742 C  
Association à but non lucratif enregistrée à la  
Sous-Préfecture de Grasse (06) N° 7803/88

---

**Important notice**

Individual copies of the present document can be downloaded from:

<http://www.etsi.org>

The present document may be made available in more than one electronic version or in print. In any case of existing or perceived difference in contents between such versions, the reference version is the Portable Document Format (PDF). In case of dispute, the reference shall be the printing on ETSI printers of the PDF version kept on a specific network drive within ETSI Secretariat.

users of the present document should be aware that the document may be subject to revision or change of status. Information on the current status of this and other ETSI documents is available at

<http://portal.etsi.org/tb/status/status.asp>

If you find errors in the present document, send your comment to:

[editor@etsi.fr](mailto:editor@etsi.fr)

---

**Copyright Notification**

No part may be reproduced except as authorized by written permission.  
The copyright and the foregoing restriction extend to reproduction in all media.

© European Telecommunications Standards Institute 2002.  
All rights reserved.

**DECT™**, **PLUGTESTS™** and **UMTS™** are Trade Marks of ETSI registered for the benefit of its Members.  
**TIPHON™** and the **TIPHON logo** are Trade Marks currently being registered by ETSI for the benefit of its Members.  
**3GPP™** is a Trade Mark of ETSI registered for the benefit of its Members and of the 3GPP Organizational Partners.

# Contents

Intellectual Property Rights .....	8
Foreword.....	8
1 Scope .....	9
2 References .....	9
3 Definitions and abbreviations.....	10
3.1 Definitions .....	10
3.2 Abbreviations .....	11
4 Introduction .....	12
4.1 Current situation .....	12
4.2 Regulatory aspects.....	12
4.3 Security aspects .....	13
4.4 Service interaction aspects .....	14
4.5 Charging aspects .....	14
4.6 Guidelines for the Service Provider Access Requirements .....	15
5 Functional requirements for the Service Provider Access.....	16
5.1 Location determination.....	17
5.1.1 Network location determination .....	17
5.1.2 Geographic location determination.....	17
5.2 Management of terminal capabilities .....	17
5.2.1 Determination of the terminal capabilities of the SP's service user .....	17
5.2.2 Modification of the terminal capabilities of the SP's service user .....	17
5.2.3 Modification of the personality device/module of the SP's service user.....	17
5.2.4 SP retrieval of profile from user terminal .....	17
5.2.5 SP modification of its service user's profile.....	17
5.2.6 Terminal retrieval of profile from its user's service provider.....	18
5.2.7 Terminal modification of SP's service user's profile.....	18
5.3 Management of the profile of the SP's service subscriber .....	18
5.3.1 Alteration of the profile of the SP's service subscriber .....	18
5.3.2 SP retrieval of profile from the PTN.....	18
5.4 Event and call management.....	18
5.4.1 Indication of the disconnection of a call .....	18
5.4.2 Join operation of individual legs of a call .....	18
5.4.3 Split operation of individual legs of a call .....	18
5.4.4 Delivery of information to the SP's service user prior to alerting.....	18
5.4.5 Supervision of a dropped-back call.....	19
5.4.6 Avoidance of the cyclical routing of signalling or user messages .....	19
5.4.7 Multimedia multiparty call control .....	19
5.4.8 user interaction for text delivery .....	19
5.4.9 user-plane resource negotiation and selection.....	19
5.4.10 user request for confidential communication .....	19
5.4.11 Service Provider request for confidential communication .....	19
5.4.12 PTN request for confidential communication .....	19
5.4.13 Communication priority.....	19
5.5 Network management.....	20
5.5.1 Reporting of network events for measuring the Quality of Service.....	20
5.5.2 Reporting of network events for the purpose of fault diagnostics .....	20
5.5.3 Request for event monitoring and subsequent reporting.....	20
5.5.4 Electronic ordering of network management functions .....	20
5.5.5 SP request for authentication .....	20
5.5.6 PTN request for SP's service user authentication.....	20
5.5.7 Terminal authentication performed by the PTN .....	20
5.6 Provision of accounting information .....	20
5.6.1 Provision of call charging information in real time .....	20

5.6.2	Exchange of charge detail record information in real time .....	21
5.7	Service Presence, Discovery and Binding .....	21
5.7.1	Context request to SP with specified service capabilities from the service user and SP .....	21
5.7.2	Discovery of PTN service capabilities by SP .....	21
5.7.3	Binding to PTN with specified service capabilities between the service user and SP .....	21
5.7.4	SP request for presence and availability on a PTN with specified service capabilities .....	21
6	Functional requirements .....	21
6.1	Location determination.....	21
6.1.1	Network location determination .....	21
6.1.1.1	Priority .....	21
6.1.1.2	Example of usage .....	22
6.1.1.3	Technical aspects .....	22
6.1.1.4	Information flow chart .....	22
6.1.2	Geographic location determination.....	22
6.1.2.1	Priority .....	22
6.1.2.2	Example of usage .....	22
6.1.2.3	Technical aspects .....	23
6.1.2.4	Information flow chart .....	23
6.2	Management of terminal capabilities .....	24
6.2.1	Determination of the terminal capabilities of the SP's service user .....	24
6.2.1.1	Priority .....	24
6.2.1.2	Example of usage .....	24
6.2.1.3	Technical aspects .....	24
6.2.1.4	Information flow chart .....	24
6.2.2	Modification of the terminal capabilities of the SP's service user .....	26
6.2.2.1	Priority .....	26
6.2.2.2	Example of usage .....	26
6.2.2.3	Technical aspects .....	26
6.2.2.4	Information flow chart .....	27
6.2.3	Modification of the personality device/module of the SP's service user.....	27
6.2.3.1	Priority .....	27
6.2.3.2	Example of usage .....	27
6.2.3.3	Technical aspects .....	27
6.2.3.4	Information flow chart .....	28
6.2.4	SP retrieval of profile from user terminal .....	28
6.2.4.1	Priority .....	28
6.2.4.2	Example of usage .....	28
6.2.4.3	Technical aspects .....	28
6.2.4.4	Information flow chart .....	29
6.2.5	SP modification of its service user's profile.....	29
6.2.5.1	Priority .....	29
6.2.5.2	Example of usage .....	29
6.2.5.3	Technical aspects .....	29
6.2.5.4	Information flow chart .....	30
6.2.6	Terminal retrieval of profile from its user's service provider.....	30
6.2.6.1	Priority .....	30
6.2.6.2	Example of usage .....	30
6.2.6.3	Technical aspects .....	30
6.2.6.4	Information flow chart .....	31
6.2.7	Terminal modification of SP's service user's profile.....	31
6.2.7.1	Priority .....	31
6.2.7.2	Example of usage .....	31
6.2.7.3	Technical aspects .....	31
6.2.7.4	Information flow chart .....	32
6.3	Management of the profile of the SP's service subscriber .....	32
6.3.1	Alteration of the profile of the SP's service subscriber .....	32
6.3.1.1	Priority .....	32
6.3.1.2	Example of usage .....	32
6.3.1.3	Technical aspects .....	32
6.3.1.4	Information flow chart .....	33
6.3.2	SP retrieval of profile from the PTN.....	33

6.3.2.1	Priority .....	33
6.3.2.2	Example of usage .....	33
6.3.2.3	Technical aspects .....	33
6.3.2.4	Information flow chart .....	34
6.4	Event and call management .....	34
6.4.1	Indication of the disconnection of a call .....	34
6.4.1.1	Priority .....	34
6.4.1.2	Example of usage .....	34
6.4.1.3	Technical aspects .....	34
6.4.1.4	Information flow chart .....	35
6.4.2	Join operation of individual legs of a call .....	35
6.4.2.1	Priority .....	35
6.4.2.2	Example of usage .....	35
6.4.2.3	Technical aspects .....	35
6.4.2.4	Information flow chart .....	36
6.4.3	Split operation of individual legs of a call .....	36
6.4.3.1	Priority .....	36
6.4.3.2	Example of usage .....	36
6.4.3.3	Technical aspects .....	36
6.4.3.4	Information flow chart .....	37
6.4.4	Delivery of information to the SP's service user prior to alerting .....	37
6.4.4.1	Priority .....	37
6.4.4.2	Example of usage .....	37
6.4.4.3	Technical aspects .....	37
6.4.4.4	Information flow chart .....	38
6.4.5	Supervision of a dropped-back call .....	38
6.4.5.1	Priority .....	38
6.4.5.2	Example of usage .....	38
6.4.5.3	Technical aspects .....	38
6.4.5.4	Information flow chart .....	39
6.4.6	Avoidance of the cyclical routeing of signalling or user messages .....	39
6.4.6.1	Priority .....	39
6.4.6.2	Example of usage .....	39
6.4.6.3	Technical aspects .....	39
6.4.6.4	Information flows .....	39
6.4.7	Multimedia multiparty call control .....	40
6.4.7.1	Priority .....	40
6.4.7.2	Example of usage .....	40
6.4.7.3	Technical aspects .....	40
6.4.7.4	Information flow chart .....	41
6.4.8	User Interaction for text delivery .....	41
6.4.8.1	Priority .....	41
6.4.8.2	Example of usage .....	41
6.4.8.3	Technical aspects .....	41
6.4.8.4	Information flow chart .....	42
6.4.9	User-Plane resource negotiation and selection .....	42
6.4.9.1	Priority .....	42
6.4.9.2	Example of usage .....	42
6.4.9.3	Technical aspects .....	42
6.4.9.4	Information flow chart .....	43
6.4.10	User request for confidential communication .....	43
6.4.10.1	Priority .....	43
6.4.10.2	Example of usage .....	43
6.4.10.3	Technical aspects .....	43
6.4.10.4	Information flow chart .....	44
6.4.11	Service Provider request for confidential communication .....	44
6.4.11.1	Priority .....	44
6.4.11.2	Example of usage .....	44
6.4.11.3	Technical aspects .....	44
6.4.11.4	Information flow chart .....	45
6.4.12	PTN request for confidential communication .....	45
6.4.12.1	Priority .....	45

6.4.12.2	Example of usage .....	45
6.4.12.3	Technical aspects .....	45
6.4.12.4	Information flow chart .....	46
6.4.13	Communication priority.....	47
6.4.13.1	Priority .....	47
6.4.13.2	Example of usage .....	47
6.4.13.3	Technical aspects .....	47
6.5	Network management events .....	47
6.5.1	Reporting of network events for measuring the Quality of Service.....	47
6.5.1.1	Priority .....	47
6.5.1.2	Example of usage .....	47
6.5.1.3	Technical aspects .....	47
6.5.1.4	Information flow chart .....	48
6.5.2	Reporting of network events for the purpose of fault diagnostics .....	48
6.5.2.1	Priority .....	48
6.5.2.2	Example of usage .....	48
6.5.2.3	Technical aspects .....	48
6.5.2.4	Information flow chart .....	49
6.5.3	Request for event monitoring and subsequent reporting.....	49
6.5.3.1	Priority .....	49
6.5.3.2	Example of usage .....	49
6.5.3.3	Technical aspects .....	49
6.5.3.4	Information flow chart .....	50
6.5.4	Electronic ordering of network management functions .....	50
6.5.4.1	Priority .....	50
6.5.4.2	Example of usage .....	50
6.5.4.3	Technical aspects .....	50
6.5.4.4	Information flow chart .....	51
6.5.5	SP request for Authentication .....	51
6.5.5.1	Priority .....	51
6.5.5.2	Example of usage .....	51
6.5.5.3	Technical aspects .....	51
6.5.5.4	Information flow chart .....	52
6.5.6	PTN request for SP's service user authentication.....	52
6.5.6.1	Priority .....	52
6.5.6.2	Example of usage .....	52
6.5.6.3	Technical aspects .....	52
6.5.6.4	Information flow chart .....	53
6.5.7	Terminal Authentication performed by the PTN .....	53
6.5.7.1	Priority .....	53
6.5.7.2	Example of usage .....	54
6.5.7.3	Technical aspects .....	54
6.5.7.4	Information flow chart .....	54
6.6	Provision of call charging information.....	54
6.6.1	Provision of call charging information in real time .....	54
6.6.1.1	Priority .....	54
6.6.1.2	Example of usage .....	54
6.6.1.3	Technical aspect.....	54
6.6.1.4	Information flow chart .....	55
6.6.2	Exchange of charge detail record information in real time .....	55
6.6.2.1	Priority .....	55
6.6.2.2	Example of usage .....	55
6.6.2.3	Technical aspect.....	55
6.6.2.4	Information flow chart .....	56
6.7	Service presence, discovery and binding.....	56
6.7.1	Context request to Service Provider with specified service capabilities from the service user and SP .....	56
6.7.1.1	Priority .....	56
6.7.1.2	Example of usage .....	56
6.7.1.3	Technical aspects .....	56
6.7.1.4	Information flow chart .....	57
6.7.2	Discovery of PTN service capabilities by SP .....	57
6.7.2.1	Priority .....	57

6.7.2.2	Example of usage .....	57
6.7.2.3	Technical aspects .....	57
6.7.2.4	Information flow chart .....	58
6.7.3	Binding to PTN with specified service capabilities between the service user and SP .....	58
6.7.3.1	Priority .....	58
6.7.3.2	Example of usage .....	58
6.7.3.3	Technical aspects .....	58
6.7.3.4	Information flow chart .....	59
6.7.4	SP request for presence and availability on a PTN with specified service capabilities .....	59
6.7.4.1	Priority .....	59
6.7.4.2	Example of usage .....	59
6.7.4.3	Technical aspects .....	59
6.7.4.4	Information flow chart .....	60
7	Architectural view of the Service Provider Access .....	60
<b>Annex A (informative): Bibliography .....</b>		<b>61</b>
History .....		62

---

## Intellectual Property Rights

IPRs essential or potentially essential to the present document may have been declared to ETSI. The information pertaining to these essential IPRs, if any, is publicly available for **ETSI members and non-members**, and can be found in ETSI SR 000 314: *"Intellectual Property Rights (IPRs); Essential, or potentially Essential, IPRs notified to ETSI in respect of ETSI standards"*, which is available from the ETSI Secretariat. Latest updates are available on the ETSI Web server (<http://webapp.etsi.org/IPR/home.asp>).

Pursuant to the ETSI IPR Policy, no investigation, including IPR searches, has been carried out by ETSI. No guarantee can be given as to the existence of other IPRs not referenced in ETSI SR 000 314 (or the updates on the ETSI Web server) which are, or may be, or may become, essential to the present document.

---

## Foreword

This ETSI Guide (EG) has been produced by ETSI Technical Committee Services and Protocols for Advanced Networks (SPAN), and is now submitted for the ETSI standards Membership Approval Procedure.



---

# 1 Scope

The present document lists the second set of network access requirements that Service Providers (SP) have in delivering telecommunication services including, but not limited to, second and third generation mobile, cordless and fixed services, over one or more operator's networks. As used here, telecommunication services include: voice telephony, multimedia and data, to name a few areas. The network requirements also include mobility-, Internet- and broadband-related aspects that were not yet covered by the preceding EG 201 722 [3] which address the first set of access requirements that Service Providers (SPs) have in delivering services over one or more Public Telecommunications Networks (PTNs), primarily fixed PTNs. A companion document, EG 201 807 [4] addresses network operators' requirements for the delivery of service provider access.

The scope of the present document is to describe generic functional requirements regarding the service provider access (SPA). The priority of each requirement is based on the need perceived from the service provider's viewpoint. To fulfil these requirements, appropriate protocols may have to be enhanced or developed based on information flows and taking into account network integrity considerations expressed in the present document.

Clause 4 contains introductory text describing the background and motivations of the second set of requirements of a SPA. Clause 5 contains a summary of requirements regarding the Service Provider Access Interface (SPAI) and a framework that helps the reader to get an overview. Clause 6 contains a description of the requirements involving Circuit-Related (CR) and Non-Circuit Related (NCR) aspects of the SPAI.

The present document relates to the role of the SP and the role of the Public Network Operator (PNO), with the realization that market players may act in multiple roles. This is in alignment with the current EC directives.

Service interaction aspects are outside the scope of the present document.

---

# 2 References

The following documents contain provisions which, through reference in this text, constitute provisions of the present document.

- References are either specific (identified by date of publication and/or edition number or version number) or non-specific.
- For a specific reference, subsequent revisions do not apply.
- For a non-specific reference, the latest version applies.

- [1] Directive 98/10/EC of the European Parliament and of the Council of 26 February 1998 on the application of open network provision (ONP) to voice telephony and on universal service for telecommunications in a competitive environment.
- [2] Directive 97/33/EC of the European Parliament and of the Council of 30 June 1997 on interconnection in Telecommunications with regard to ensuring universal service and interoperability through application of the principles of Open Network Provisions (ONP).
- [3] ETSI EG 201 722: "Intelligent Network (IN); Service provider access requirements; Enhanced telephony services".
- [4] ETSI EG 201 807: "Network Aspects (NA); Intelligent Network (IN); Network operators' requirements for the delivery of service provider access".
- [5] ETSI EG 201 899: "Services and Protocols for Advanced Networks (SPAN); Service Provider Access; Modelling service provider access requirements using an API approach".
- [6] ETSI ETS 300 374-1: "Intelligent Network (IN); Intelligent Network Capability Set 1 (CS1); Core Intelligent Network Application Protocol (INAP); Part 1: Protocol specification".
- [7] ETSI EN 301 140-1: "Intelligent Network (IN); Intelligent Network Application Protocol (INAP); Capability Set 2 (CS2); Part 1: Protocol specification".

- [8] Directive 97/66/EC of the European Parliament and of the Council of 15 December 1997 concerning the processing of personal data and the protection of privacy in the telecommunications sector.
- [9] ETSI ES 201 158: "Telecommunications Security; Lawful Interception (LI); Requirements for network functions".
- [10] ETSI EG 201 781: "Intelligent Network (IN); Lawful interception".
- [11] ETSI ES 201 915 (all parts): "Open Service Access; Application Programming Interface".
- [12] ETSI EG 201 916: "Services and Protocols for Advanced Networks (SPAN); Service Provider Access; Development of standards to support open inter-network interfaces and service provider access".
- [13] ETSI ETR 339: "Intelligent Network (IN); IN interconnect business requirements".
- [14] ETSI TR 101 664: "Intelligent Network (IN); IN interconnect security features".
- [15] ETSI TR 101 365: "Intelligent Network (IN); IN interconnect threat analysis".
- [16] ETSI EN 301 152-1: "Intelligent Network (IN); Intelligent Network Capability Set 1 (CS1) extension; Intelligent Network Application Protocol (INAP); Customized Applications for Mobile network Enhanced Logic (CAMEL); Part 1: Protocol specification".
- [17] ECTRA/REC(00)03: "The implementation and use of CLI (Calling Line Identification) within CEPT countries".
- [18] ITU-T Recommendation E.106: "Description of an international emergency preference scheme (IEPS)".

## 3 Definitions and abbreviations

### 3.1 Definitions

For the purposes of the present document, the following terms and definitions apply:

**Calling Line Identity (CLI):** number that uniquely identifies a subscriber line that is used for a call

**Circuit-Related (CR) interface:** signalling connection between a public telecommunications network operator and a service provider, with the extension of the call connection from the public telecommunications network to the service provider's equipment

**end user:** See "service user" definition.

**Network-to-Network Interface (NNI):** interface at a network node which is used to interconnect a network node with another network

NOTE: This interface is used for Inter-connection of two or more networks.

**non-call-related:** call-unrelated

**non-circuit-related interface:** control connection between a public telecommunications network operator and a service provider, without the extension of the call connection from the public telecommunications network to the service provider's equipment

**Public Telecommunications Network Operator (PTNO):** entity which is responsible for the development, provisioning and maintenance of telecommunications services to the general public and for operating the corresponding networks

**Public Telecommunications Network (PTN):** telecommunications network which provides telecommunications services to the general public

**Public Telecommunications Network originating (PTNorig):** PTN to which either the originating line is directly connected or in which an incoming call initiates a service

**Public Telecommunications Network terminating (PTNterm):** PTN to which either the terminating line is directly connected or in which the terminating line's user profile is stored

**Service Provider Access Requirement (SPAR):** requirement for access by a service provider to specific functionality of a public telecommunication network

**service:** that which is offered by an administration or recognized private operating agency (i.e. a public or private service provider) to its customers in order to satisfy a telecommunication requirement

**Service Provider (SP):** entity which provides services to its service subscribers on a contractual basis and who is responsible for the services offered

NOTE: The same organization may act as a public telecommunications network operator and a service provider.

**Service Provider Access (SPA):** access facility that enables a service provider to access specific functionality of a public telecommunications network

**Service Provider Access Interface (SPAI):** interface between a public telecommunications network and a service provider's equipment for enabling the service provider to access specific functionality of a public telecommunications network

**Service Provider originating (SPorig):** service provider that provides either services relating to the originating line (or to the originating profile), or services acting on the information coming from the originating or incoming call

**Service Provider terminating (SPterm):** service provider that provides either services relating to the terminating line (or to the terminating profile), or services acting on the call-related information coming from the terminating party's line

**service subscriber:** entity that contracts for services offered by service providers

**service user:** entity external to the network that uses its services

**user-Network Interface (UNI):** interface between the terminal equipment and a network termination point at which the access protocols apply

## 3.2 Abbreviations

For the purposes of the present document, the following abbreviations apply:

API	Application Programming Interface
ATM	Asynchronous Transfer Mode
CAMEL	Customized Applications for Mobile network Enhanced Logic
CdPy	Called Party
CgPy	Calling Party
CLI	Calling Line Identity
CR	Circuit-Related
CS2	IN Capability Set #2
EC	European Commission
GPS	Global Positioning System
IMSI	International Mobile Subscriber Identity
IN	Intelligent Network
INAP	Intelligent Network Application Protocol
ITU-T	International Telecommunications Union -Telecom sector
NCR	Non-Circuit-Related
NNI	Network-to-Network Interface
NRA	National Regulatory Authority
PNO	Public Network Operator
PTN	Public Telecommunications Network
PTNO	Public Telecommunications Network Operator
PTNorig	Public Telecommunications Network originating
PTNterm	Public Telecommunications Network terminating
PTNv	Public Telecommunications Network visited

QoS	Quality of Service
SMS	Short Message Service
SP	Service Provider
SPA	Service Provider Access
SPAI	Service Provider Access Interface
SPAR	Service Provider Access Requirements
SPorig	Service Provider originating
SPterm	Service Provider terminating
SSL	Secure Socket Layer
SVC	Switched Virtual Circuit
UNI	user-Network Interface
USIM	user Services Identity Module
USSD	Unstructured Supplementary Service Data
OSA	Open Service Access

---

## 4 Introduction

### 4.1 Current situation

Different types of network control (or signalling) interfaces exist within a Public Telecommunications Network (PTN), between PTNs and for those accessing the PTNs.

There are provisions in two of the open network provisions directives of the European Commission [1] and [2] that provide a regulatory framework for organizations delivering publicly available telecommunications services. These provisions request non-discriminatory access to the networks of those Public Telecommunications Network Operators (PTNOs) which have been determined as having "Significant Market Power" (SMP).

Therefore, in order to enable Service Providers (SPs) to deliver services by utilizing the network functionality of one or more PTNs, a specific Service Provider Access Interface (SPAI) may become necessary.

Document EG 201 722 [3] defines the first set of service providers' access requirements leading to enhancements of the existing Network-to-Network Interfaces (NNI) and user-to-Network Interfaces (UNI) to have the necessary functionality to meet the SPA requirements. A companion document, EG 201 807 [4] addresses network operators' requirements for the delivery of service provider access. EG 201 899 [5] on modelling service provider requirements using an API approach is next in a sequence leading to API definitions in ES 201 915 [11].

The present document defines an enhanced set of service providers' access requirements for mobile, Internet and broadband networks and includes issues deferred from EG 201 722 [3].

The existing IN interfaces defined within the ETSI and ITU-T as part of INAP CS1 [6] were designed primarily for intra-network use with IN CS2 [7] offering an initial inter-network IN control relationship, neither were specifically designed to meet the requirements of an "open" access interface or to incorporate features that ensure network access integrity and security.

It is seen, therefore, as desirable to develop standardized interfaces to meet the SPA requirements that include features to ensure network integrity and security. There may also be a need to consider service feature interaction. These standardized interfaces are referred to, in the present document, as Service Provider Access Interface (SPAI).

### 4.2 Regulatory aspects

The EC directives that address Access and Interconnect matters are the Voice Telephony Directive (98/10 [1]) and the Interconnect Directive (97/33 [2]). The former is limited to fixed telephony networks and services, whilst the latter includes both mobile and fixed networks and services.

The Interconnect Directive [2] requires that certain organizations meet all reasonable requests for access at points other than the network termination points offered to the majority of end users. It will be a matter for the National Regulatory Authorities (NRA) in respective countries to interpret and implement this clause into their national regulations or authorization policies.

The current regulatory regime in the EC is now under review and the Commission are intending in the near future to restructure and rationalize the existing telecommunication legislation and ultimately to create a new regulatory framework. The new framework is likely to focus on a number of specific directives - licensing, access and interconnection, universal service, and data protection, and therefore the regulatory issues concerned with access may be revised.

All the functional requirements in the present document that are related to the usage and delivery of the Calling Line Identity (CLI) must be in accordance with the legal and regulatory provisions in each country, as well as the general provision of the European directive of privacy and data protection [8]. A CEPT recommendation outlines guidelines on the use of CLI information [17].

National privacy laws may require a service subscriber to make users of his subscribed services aware of any potential privacy infringements, arising from the subscribed service of the subscriber's contract with the service provider.

Also the technical requirements of legal interception [9] and [10] will need to accord with the specific national regulations on security and interception that are in the force in the respective countries.

Those service providers wishing to operate in one or more countries will need to comply with the specific regulatory requirements of the different NRAs. This may entail some kind of authorization or other rules which are applicable in various countries. Such rules may for instance include the procedures by which the service providers are allocated numbers for their specific services.

The emerging ETSI technical specifications or standards relating to the service provider access interfaces that will be based on the functional requirements specified in the present document may be used in all commercial negotiations between an SP seeking access and a PNO offering access. As already stated, any regulatory requirements relevant to the provision of access will be a matter for NRAs in respective countries.

## 4.3 Security aspects

End users, SPs and PTNOs have a range of different business objectives and requirements regarding the provision of telecommunication services over PTNs. A number of those objectives have been identified [13]. In order to meet them, security aspects need to be carefully considered in a new environment with a multitude of interconnections and access configurations for service providers.

From the viewpoint of the end users, the key requirements are:

- availability of the services;
- correct billing;
- fraud protection;
- confidentiality; and
- privacy.

From the viewpoint of the SPs and PTNOs, the key requirements are:

- availability of the network, services, and maintenance;
- correct charging;
- capability of tracing individual calls;
- protection of subscriber-related data against intruders; and
- elimination of fraudulent use of the equipment of the PTNOs and SPs.

Security violations may have a significant negative business impact for both SPs and NOs, e.g. loss of income, reputation and market share.

In particular, network integrity is a key issue when inter-network relationships are established between PTNOs and SPs. In the connection of the SPA, a basic set of facilities may be needed to secure the interfaces between the PTNOs and SPs [14] and [15]. A threat analysis of IN-based interconnections is presented in TR 101 365 [15], and some guidelines on the relevant security measures are given in TR 101 664 [14].

Screening and mapping functions are used to control and secure bilateral agreements on the interfaces between the PTNs. Today, the PTNOs have screening and mapping facilities on some of the inter-connecting NNIs, such as the ISUP connections. These facilities and functions need to be gradually extended to cover all of the interfaces between the PTNOs and SPs.

Further security aspects associated with mobile, Internet and broad-band networks include transfer of terminal/personal identity information (e.g. IMSI, Electronic Signature, etc.) between the user Environment and the service provider, or the support of secure end-end transmission between the user terminal and the service provider application (e.g. Secure Socket Layer (SSL) and ciphering technologies).

## 4.4 Service interaction aspects

In an environment where an end user subscribes to a range of services from more than one provider, adverse interactions may occur between services and service features. This implies the need for additional functionality to manage the interaction aspects to enable integrated and coherent service delivery.

Further study is needed for service interaction aspects, including the adverse interactions that may occur between the PTNO's and SP's equipment, when more than one of the parties involved in the call handling requires to be able to control the call.

An example of such service interaction issues is provided by the combination of number portability and service providers access requirements. For instance, several requirements state that an SP-related action may be triggered on the basis of a call with the calling party's CLI in a specific numbering range. Due to the service portability mechanisms, the detection of such numbering range is not a guarantee that the call will have to be processed by the service provider to which the numbering range was initially allocated.

Another example of service interaction is call waiting alerting during an Internet telephony session. To meet the new traffic patterns of Internet telephony, alternative methods for realization of the CW supplementary service have to be devised.

## 4.5 Charging aspects

The standard charging mechanisms allow the charging of a successful call, i.e. between the called party's answer and the release of the call. Some requirements from the service providers imply the usage of the PTNO's network outside this standard case, and the implementation of a related charging mechanism between the PTNO and the SP is therefore necessary, in order to cover such a usage. This is true e.g. in the case of the following requirements of the service providers:

- requesting the PTN to open a backward in-band message path to the calling party immediately upon the arrival of a confirmation of the call set-up, without returning an "answer" signal;
- conveying the indication of an unsuccessful call from the terminating PTN, i.e. either when an indication other than "ringing" is returned to the calling party, or when a "no reply" situation occurs;
- providing call destination and routing information for controlling the destination and routing of the call;
- interacting with the service user before any service charging begins;
- sending data to and receiving data from the service provider's NTP without an alerting signal, such as "ringing";
- call charging and billing aspects, as seen from the PTNO's perspective, are considered in EG 201 807 [4].

In the case where end user charging is suspended, delayed, altered or in other ways different from standard call charging mechanisms, the appropriate events has to be created for possible logging e.g. thus providing the necessary data for appropriate accounting between the SP and PTNO.

For example, demand is emerging in the market place for:

- subscription-based billing for Internet access;
- included minutes in pre-pay subscription for fixed and mobile service; and
- pay-per-use without having a subscription.

All these cases require real-time accounting (hot billing) over a secure data interface.

## 4.6 Guidelines for the Service Provider Access Requirements

In the specification of the Service Provider Access Requirements (SPAR), the following aspects need to be taken into consideration:

- the definition of the SPAR needs to be based upon service capability requirements from the viewpoint of the SPs and the related requirements of PTNOs, e.g. on service interoperability, network integrity and security;
- the SP shall not have the ability to override PTN restrictions, barrings and priorities which are due either to national regulations or EC directives;
- the SPA is not required to guarantee that service requests or responses can be passed across the boundaries of different PTNs, especially between different countries.

## 5 Functional requirements for the Service Provider Access

Service Providers have requirements for accessing functionality of a PTN. Access to this functionality is necessary to meet specific service requirements that are not supported by the existing access interfaces. A variety of different services are expected to be offered by SPs to end-users. Some of the services will be available to the service subscribers of the SPs only.

In this clause, high-level descriptions of both CR and NCR requirements of the SPA are given. A list of the requirements is presented in table 1. The priority and applicability of each requirement for the CR and NCR case is indicated in the two columns of the table. In clause 6, these requirements are described in more detail.

**Table 1: The priorities and application scope of the requirements from the SP's viewpoint**

	Requirement	Priority CR	Priority NCR
	<b>Location determination</b>		
5.1.1	Network location determination	High	High
5.1.2	Geographic location determination	High	High
	<b>Management of terminal capabilities</b>		
5.2.1	Determination of the terminal capabilities of the SP's service user	High	High
5.2.2	Modification of the terminal capabilities of the SP's service user	High	High
5.2.3	Modification of the Personality Device/Module of the SP's service user	High	High
5.2.4	SP retrieval of profile from user terminal	Void	High
5.2.5	SP modification of its service user's profile	Void	High
5.2.6	Terminal retrieval of profile from its user's Service Provider	Void	High
5.2.7	Terminal modification of SP's service user's profile	Void	High
	<b>Management of the profile of the SP's service subscriber</b>		
5.3.1	Alteration of the profile of the SP's service subscriber	High	High
5.3.2	SP retrieval of profile from the PTN	Void	High
	<b>Event and call management</b>		
5.4.1	Indication of the disconnection of a call	High	High
5.4.2	Join operation of individual legs of a call	High	High
5.4.3	Split operation of individual legs of a call	High	High
5.4.4	Delivery of information to the SP's service user prior to alerting	Medium	Medium
5.4.5	Supervision of a dropped-back call	Void	Medium
5.4.6	Avoidance of the cyclical routeing of signalling or user messages	High	High
5.4.7	Multimedia Multiparty call control	High	High
5.4.8	user Interaction for Text Delivery	High	High
5.4.9	user-Plane resource negotiation and selection	High	High
5.4.10	user request for confidential communication	Void	High
5.4.11	Service Provider request for confidential communication	Void	High
5.4.12	PTN request for confidential communications	Void	High
5.4.13	Communication priority	High	High
	<b>Network Management</b>		
5.5.1	Reporting of network events for measuring the Quality of Service	Medium	Medium
5.5.2	Reporting of network events for the purpose of fault diagnostics	High	High
5.5.3	Request for event monitoring and subsequent reporting	High	High
5.5.4	Electronic ordering of network management functions	Medium	Medium
5.5.5	SP request for Authentication	Void	High
5.5.6	PTN request for SP's service user authentication	Void	High
5.5.7	Terminal Authentication performed by the PTN	Void	High
	<b>Provision of call charging information</b>		
5.6.1	Provision of call charging information in real time	High	High
5.6.2	Exchange of charge detail record information in real time	High	High
	<b>Provision of call charging information</b>		
5.7.1	Context request to Service Provider with specified service capabilities from the service user and SP	Void	High
5.7.2	Discovery of PTN service capabilities by SP	Void	High
5.7.3	Binding to PTN with specified service capabilities between the service user and SP	Void	High
5.7.4	SP request for presence and availability on a PTN with specified service capabilities	Void	High



## 5.1 Location determination

### 5.1.1 Network location determination

The SP needs the ability to determine the network location of the SP's service user, on the basis of information passed over the SPAI. This is to be applicable in both fixed and mobile networks, including service users with either geographic or non-geographic numbers taking into account variations in national numbering plans.

This is a CR and NCR requirement.

### 5.1.2 Geographic location determination

The SP needs the ability to determine the geographic location of the SP's service user at the time of a service request, e.g. an originating call or a mobility-generated event, on the basis of information passed over the SPAI. This is to be applicable in both fixed and mobile networks, including service users with either geographic or non-geographic fixed numbers taking into account variations in national numbering plans.

This is a CR and NCR requirement.

## 5.2 Management of terminal capabilities

### 5.2.1 Determination of the terminal capabilities of the SP's service user

The SP needs the ability to find out the terminal capabilities of the SP's service user in the case of an originating or terminating call, or service request, on the basis of information passed over the SPAI at the time of the event. This is to be applicable in both fixed and mobile networks, including service users with geographic and non-geographic numbers taking into account the national numbering plan. This requirement is applicable either when the SP's service user originates a call or is a recipient of a terminating call.

This is a CR and NCR requirement.

### 5.2.2 Modification of the terminal capabilities of the SP's service user

The SP needs the ability to modify the terminal capabilities of the SP's service user at any time. This requirement is applicable either when the SP's service user originates a call or when the service user is a recipient of a terminating call.

This is a CR and NCR requirement.

### 5.2.3 Modification of the personality device/module of the SP's service user

The SP needs the ability to modify the data contents of the personality device/module e.g. User Services Identity Module (USIM) of the SP's service user.

This is a CR and NCR requirement.

### 5.2.4 SP retrieval of profile from user terminal

The SP needs the ability to retrieve their service user's communication configuration from their user's terminal.

This is an NCR requirement.

### 5.2.5 SP modification of its service user's profile

The SP needs the ability to modify the communication configuration of their service user based on instructions received from the network.

This is an NCR requirement.

## 5.2.6 Terminal retrieval of profile from its user's service provider

The SP's service user needs the ability to retrieve, for storage in their terminal, their communication configuration held by their Service Provider.

This is an NCR requirement.

## 5.2.7 Terminal modification of SP's service user's profile

Service Provider's service user's terminals need to be able to modify their communication configuration held by their Service Provider.

## 5.3 Management of the profile of the SP's service subscriber

### 5.3.1 Alteration of the profile of the SP's service subscriber

The SP needs the ability to alter, through the SPAI, the carrier selection conditions or any other pre-selected routing conditions set up on the profile of the SP's service subscriber. This only applies to services subscribed to by the service subscriber from the particular SP.

This is a CR and NCR requirement.

### 5.3.2 SP retrieval of profile from the PTN

The SP needs the ability to retrieve, through the SPAI, their service user's communication configuration from the PTN.

This is an NCR requirement.

## 5.4 Event and call management

### 5.4.1 Indication of the disconnection of a call

The SP needs the indication of the disconnection of a call from the SP's service user.

This is a CR and NCR requirement.

### 5.4.2 Join operation of individual legs of a call

The SP needs the ability to request the PTNO to join specified individual legs to a call.

This is a CR and NCR requirement.

### 5.4.3 Split operation of individual legs of a call

The SP needs the ability to request the PTNO to split specified individual legs of a call.

This is a CR and NCR requirement.

### 5.4.4 Delivery of information to the SP's service user prior to alerting

The SP needs the ability to deliver information to the recipient of the call who is the SP's service user, prior to alerting.

This is a CR and NCR requirement.

### 5.4.5 Supervision of a dropped-back call

The SP needs the ability to retain the control of a dropped-back call.

This is an NCR requirement.

### 5.4.6 Avoidance of the cyclical routing of signalling or user messages

The SP needs the ability to detect and stop cyclical routing of signalling or user messages between the PTN and the SP's equipment.

This is a CR and NCR requirement.

### 5.4.7 Multimedia multiparty call control

The SP needs the ability set-up, control and terminate multimedia multiparty calls.

This is a CR and NCR requirement.

### 5.4.8 user interaction for text delivery

The SP needs the ability to exchange text based information to and from an end user.

This is a CR and NCR requirement.

NOTE: user interaction management for voice is covered in EG 201 722 [3].

### 5.4.9 user-plane resource negotiation and selection

The SP needs the ability to negotiate and select user-Plane resources for calls or sessions.

This is a CR and NCR requirement.

### 5.4.10 user request for confidential communication

Service Provider's service users need to be able to request when to start and stop the making of subsequent communications confidential, e.g. ciphering, to some or all of their communications.

This is an NCR requirement.

### 5.4.11 Service Provider request for confidential communication

Service Providers need to be able to request when to start and stop the making of subsequent communications confidential, e.g. ciphering, to some or all of their service user's communications.

This is an NCR requirement.

### 5.4.12 PTN request for confidential communication

The PTN needs to be able to request when to start and stop making subsequent communications confidential, e.g. ciphering, to some or all of the service user's communications.

### 5.4.13 Communication priority

This is a CR and NCR requirement.

Service Provider's service users need to be able to assign a priority to their communication e.g. urgent, non-urgent).

## 5.5 Network management

### 5.5.1 Reporting of network events for measuring the Quality of Service

The SP needs the ability to receive notifications of specific network events that are in the concern of the SP's service users, e.g. alarms and Quality of Service (QoS) degradation indicators, in order to gather statistics of the Quality of Service.

This is a CR and NCR requirement.

### 5.5.2 Reporting of network events for the purpose of fault diagnostics

The SP needs the ability to receive notifications of specific network events for the purpose of fault diagnostics.

This is a CR and NCR requirement.

### 5.5.3 Request for event monitoring and subsequent reporting

The SP needs the ability, within its contractual arrangement, to request for the monitoring of particular events in the PTN and the related reporting of such events by the PTN to the SP.

This is a CR and NCR requirement.

### 5.5.4 Electronic ordering of network management functions

The SP needs to be offered by the PTN a suitably secure and open interface to order electronically all of the related management functions.

This is a CR and NCR requirement.

### 5.5.5 SP request for authentication

The Service Provider needs to be able to request when authentication is applicable (e.g. user, terminal or service).

This is an NCR requirement.

### 5.5.6 PTN request for SP's service user authentication

The PTN needs to be able to request for authentication of the SP's service user.

This is an NCR requirement.

### 5.5.7 Terminal authentication performed by the PTN

The PTN needs to be able to perform terminal authentication of a SP's service user.

This is an NCR requirement.

## 5.6 Provision of accounting information

### 5.6.1 Provision of call charging information in real time

The SP needs the ability to request and receive notifications of the initial and accumulated charging of an originating or terminating call involving the SP's service user.

This is a CR and NCR requirement.

## 5.6.2 Exchange of charge detail record information in real time

The SP needs the ability to exchange with the PTN charge detail records at the end of a call and at configured intermediate stages of a call/session e.g. for long calls, involving the SP's service user.

This is a CR and NCR requirement.

## 5.7 Service Presence, Discovery and Binding

### 5.7.1 Context request to SP with specified service capabilities from the service user and SP

Terminals need to be able to request the Service Provider for a context with specified service capabilities to be set-up in the PTN.

This is an NCR requirement.

### 5.7.2 Discovery of PTN service capabilities by SP

SPs need to be able to request the discovery operation during their service user's service registration in the PTN.

This is an NCR requirement.

### 5.7.3 Binding to PTN with specified service capabilities between the service user and SP

Service Provider's service users need to be able to retrieve their service bindings established during a previous service registration procedure.

This is an NCR requirement.

### 5.7.4 SP request for presence and availability on a PTN with specified service capabilities

The SP needs to be able to request the presence and availability operation for their service users registered in the PTN.

This is an NCR requirement.

---

## 6 Functional requirements

This clause contains descriptions of the service provider access requirements that form the driver for use of the non-circuit-related SP access.

### 6.1 Location determination

#### 6.1.1 Network location determination

The SP needs the ability to determine the network location of the SP's service user, on the basis of information passed over the SPAI. This is to be applicable in both fixed and mobile networks, including service users with either geographic or non-geographic numbers taking into account variations in national numbering plans.

##### 6.1.1.1 Priority

The priority of this requirement is high.

### 6.1.1.2 Example of usage

To enable the SP to offer follow-me and personal number services, the service user's network location must be provided by the PTN.

### 6.1.1.3 Technical aspects

One solution is that the SP is given an access to real-time location data of user terminals (fixed or mobile). In this case, the SPAI should allow access to the appropriate information either upon a service request or at the time of establishing a terminating call to the SP's service user.

### 6.1.1.4 Information flow chart

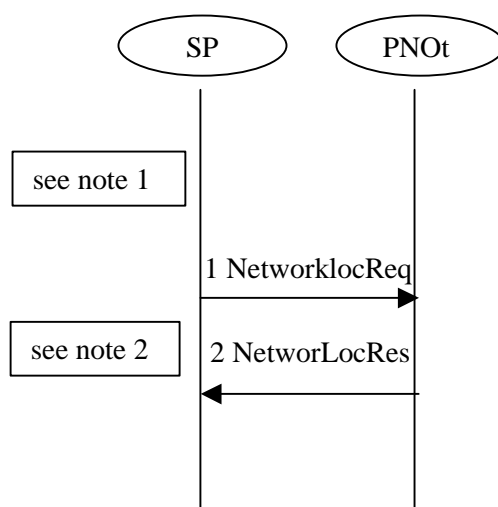

NOTE 1: The service provider's service user switches on a mobile terminal or makes an outgoing call from a fixed-line terminal.

NOTE 2: SP polls the PNO for the network location of the service provider's service user. The PNO returns location data with the time stamp of the latest update.

- 1 Network Location request by SP for SP's Service user from PNOterm.
- 2 Network Location result for SP's Service user provided by PNOterm.

**Figure 1: Information flow chart for network location determination**

## 6.1.2 Geographic location determination

The SP needs the ability to determine the geographic location of the SP's service user at the time of a service request, e.g. an originating call or a mobility-generated event, on the basis of information passed over the SPAI. This is to be applicable in both fixed and mobile networks, including service users with either geographic or non-geographic fixed numbers taking into account variations in national numbering plans.

### 6.1.2.1 Priority

The priority of this requirement is high.

### 6.1.2.2 Example of usage

To enable the SP to offer location-based services, such as the location information of the nearest gasoline station, the calling party's geographic location must be provided by the PTN.

### 6.1.2.3 Technical aspects

One solution is that the SP is given an access to real-time geographic location data of user terminals (fixed, mobile or internet). In this case, the SPAI should allow access to the appropriate information at any time.

The following protocol interactions are needed to support the request for and transfer of location information between the visited network roamed into by the SP's Service user and the SP:

- Location Information exchange messages:
  - user Location Interrogation - Interactive Request;
  - user Location Report - Indication.
- Management of location interrogation:
  - user Location Interrogation - Batch Request;
  - user Location Interrogation - Batch Retrieval Request;
  - user Location Reporting - Cancel Request;
  - user Location Interrogation - Triggering Event Request;
  - user Location Interrogation - Triggering Event Report;
  - user Location Reporting - Cancel Request of Triggering Reports.

### 6.1.2.4 Information flow chart

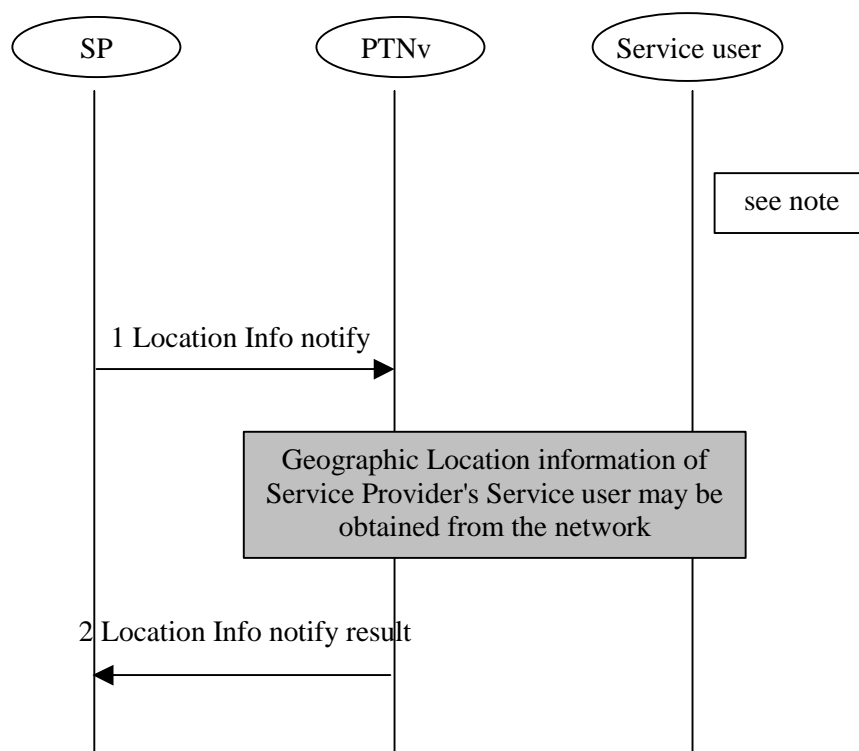

NOTE: SP's Service user switches on a mobile terminal or makes an outgoing call from a fixed-line terminal.

- 1 SP requests the PTNv for the geographic location of the SP's Service user.
- 2 The PTNv returns the geographic location information.

**Figure 2: Information flow chart for geographic location determination**

## 6.2 Management of terminal capabilities

### 6.2.1 Determination of the terminal capabilities of the SP's service user

The SP needs the ability to find out the terminal capabilities of the SP's service user in the case of an originating or terminating call, or service request, on the basis of information passed over the SPAI at the time of the event. This is to be applicable in both fixed and mobile networks, including service users with geographic and non-geographic fixed numbers taking into account the national numbering plan. This requirement is applicable either when the SP's service user originates a call or when the service user is a recipient of a terminating call.

#### 6.2.1.1 Priority

The priority of this requirement is high.

#### 6.2.1.2 Example of usage

In the case of location-based services, the Global Positioning System (GPS) capability of the service user's terminal can be indicated to the SP. A high-speed data or video call can be considered as another example, in which the maximum data rate of the terminal of the called party must be known or negotiated.

#### 6.2.1.3 Technical aspects

Some terminals may be able to supply details of their own capabilities. However, simple terminals may not be able to provide information on their own capabilities, therefore these will need to be deduced by the PNO to which they are connected.

#### 6.2.1.4 Information flow chart

**Scenario 1: SP proactively requests a determination of the terminal capabilities of the calling party.**

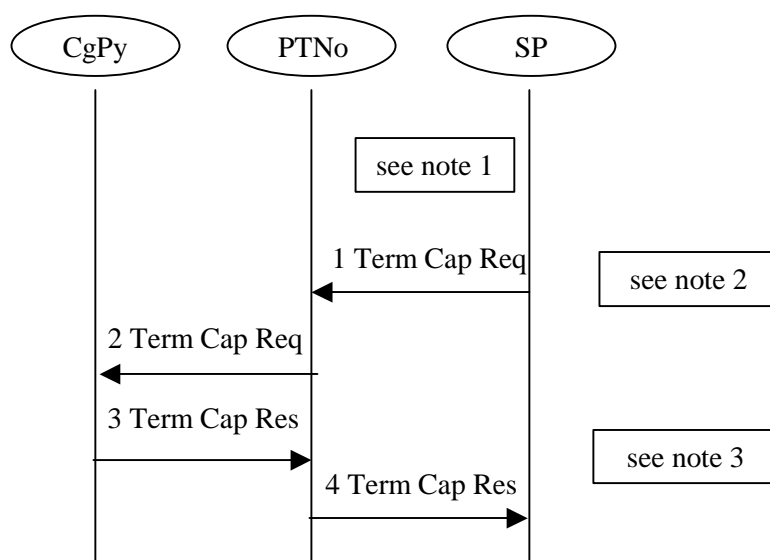

NOTE 1: Service Provider's Service user initiates a call.

NOTE 2: SP requests the terminal capabilities of the CgPy, e.g. by using in-band negotiation.

NOTE 3: CgPy declares the terminal capabilities.

- 1 SP requests the PTN for the service user's terminal capabilities.
- 2 The PTN requests the service user's terminal for its capabilities.
- 3 The terminal responds to the request with its requested capabilities.
- 4 The PNO returns the requested information to the SP.

**Figure 3: Information flow chart for Scenario 1**



**Scenario 2: Calling party automatically declares the terminal capabilities.**

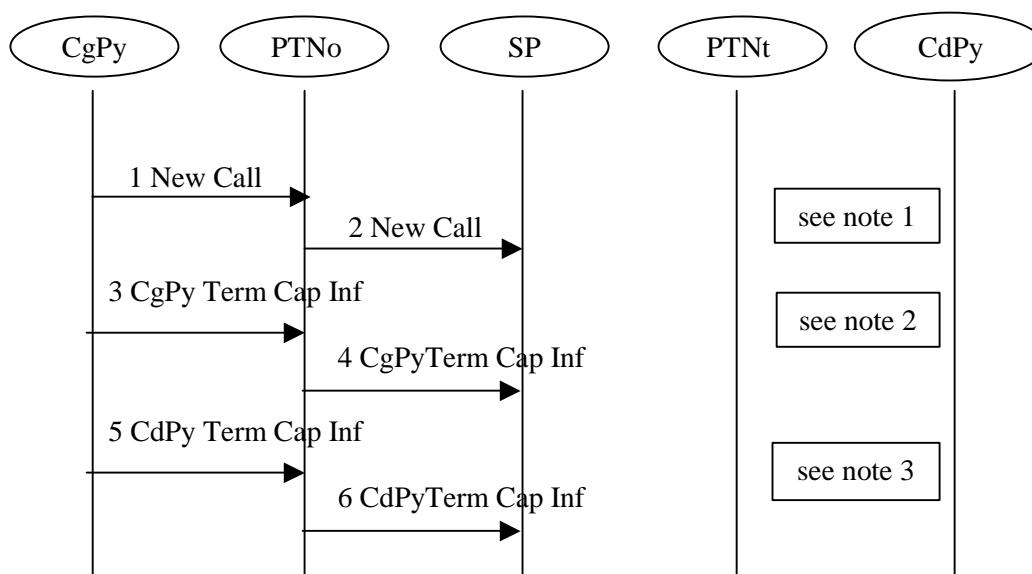

NOTE 1: The SP's service user initiates a call, e.g. by dialling a service number.

NOTE 2: The SP's service user declares the terminal capabilities.

NOTE 3: The SP's service user specifies the capabilities required from the CdPy.

- 1 The SP's service user's initiates a new call.
- 2 The PTN relays the request to the SP.
- 3 The terminal provides its capabilities to the PTN.
- 4 The PTN relays the capability information to the SP.
- 5 The terminal requests CdPy capabilities.
- 6 The PTN relays the CdPy capability information request to the SP.

**Figure 4: Information flow chart for Scenario 2**

**Scenario 3: SP proactively requests the terminal capabilities of the called party.**

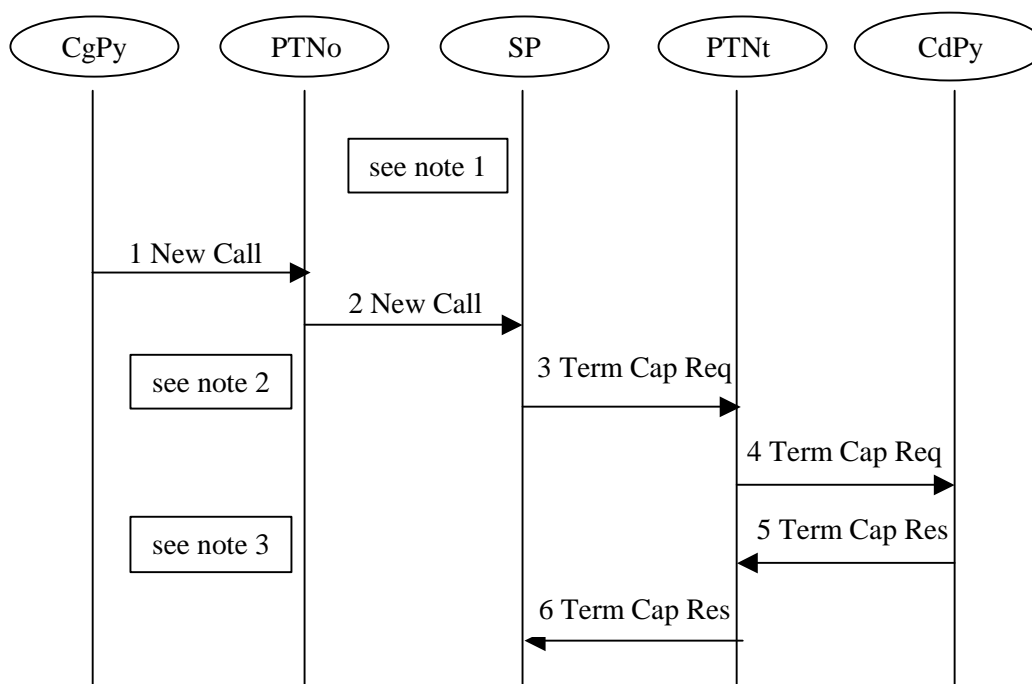

NOTE 1: CgPy initiates a call to the Service Provider's Service user.

NOTE 2: The Service Provider requests the terminal capabilities of the Service Provider's Service user, e.g. by making a call to the CdPy and using in-band negotiation.

NOTE 3: The Service Provider's Service user declares the terminal capabilities.

- 1 The SP service user initiates a new call request to the PTN.
- 2 The PTN relays the service user's new call request to the SP.
- 3 The SP requests the PTN for the terminal capabilities of the CdPy.
- 4 The PTN relays the request for the terminal capabilities of the CdPy.
- 5 The CdPy returns the terminal capabilities to the PTN.
- 6 The PTN relays the terminal capabilities to the SP.

**Figure 5: Information flow chart for Scenario 3**

## 6.2.2 Modification of the terminal capabilities of the SP's service user

The SP needs the ability to modify the terminal capabilities of the SP's service user at any time.

### 6.2.2.1 Priority

The priority of this requirement is high.

### 6.2.2.2 Example of usage

Modifying the assignment of softkeys in the terminal of the SP's service user is an example. Another example is the downloading of a virus cleaner.

### 6.2.2.3 Technical aspects

Some terminals may be able to modify by request, or download of new facilities, details of their own capabilities.

### 6.2.2.4 Information flow chart

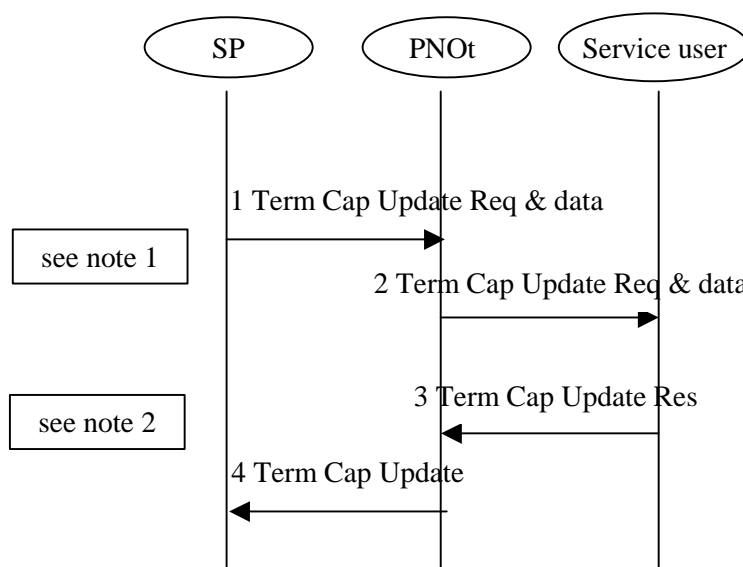

NOTE 1: The Service Provider sends data to the Service Provider's Service user's terminal.

NOTE 2: The Service Provider's Service user's terminal acknowledges receipt of the data sent by the Service Provider.

**Figure 6: Information flow chart for modification of Terminal Capabilities**

### 6.2.3 Modification of the personality device/module of the SP's service user

The SP needs the ability to modify the data contents of the personality device/module of the SP's service user.

#### 6.2.3.1 Priority

The priority of this requirement is high.

#### 6.2.3.2 Example of usage

The downloading of a service profile for interactive personalization by the user is an example.

#### 6.2.3.3 Technical aspects

Some terminals may be able to modify by request, or download of new facilities, details of their personality device/module capabilities e.g. User Services Identity Module (USIM).

### 6.2.3.4 Information flow chart

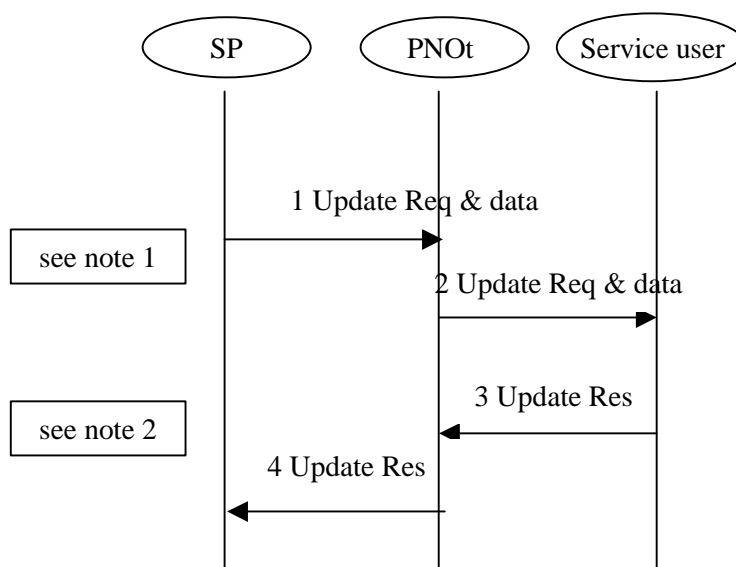

NOTE 1: The Service Provider sends data to the Service Provider's Service user's terminal Personality Device/Module.

NOTE 2: The Service Provider's Service user's terminal acknowledges receipt of the data sent by the Service Provider.

- 1 The SP sends with the necessary data, a request to the PTN to update the SP's service user's terminal.
- 2 The PTN sends with the necessary data, a request to the SP's service user's terminal.
- 3 The SP's service user's terminal responds to the update request.
- 4 The PTN relays the update response to the SP.

**Figure 7: Information flow chart for modification of personality device/module capabilities**

## 6.2.4 SP retrieval of profile from user terminal

Service Providers need to be able to retrieve their service user's communication configuration from the user's terminal.

### 6.2.4.1 Priority

The priority of this requirement is high.

### 6.2.4.2 Example of usage

This requirement enables the SP to retrieve his service user's user profile from the user's terminal to synchronize a network based version of a phone book with a terminal based one.

### 6.2.4.3 Technical aspects

The Service Provider is given an access to real-time profile data of his service user. Access must be controlled by the necessary authority mechanisms between the SP and the PTN to ensure security and confidentiality of user data.

#### 6.2.4.4 Information flow chart

The following flow chart illustrates how a Service Provider's service user may request.

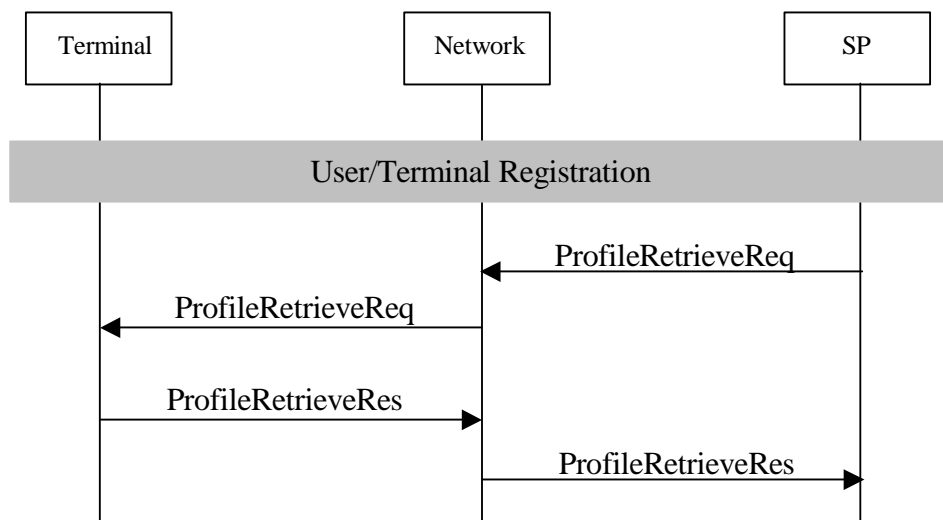

**Figure 8: Information flow for SP retrieval of profile from their service user's terminal**

#### 6.2.5 SP modification of its service user's profile

Service Providers need to be able to modify their communication configuration of their service user based on instructions received from the network.

##### 6.2.5.1 Priority

The priority of this requirement is high.

##### 6.2.5.2 Example of usage

This requirement triggers the SP to update their service user's user profile based on information provided by the network (e.g. presence and discovery).

##### 6.2.5.3 Technical aspects

The Service Provider is given information relating to the real-time profile data of the SP's service user and modifies the user profile accordingly. Access must be controlled by the necessary authority mechanisms to ensure security and confidentiality of user data.

### 6.2.5.4 Information flow chart

The following flow chart illustrates how a Service Provider's service user may update the user profile.

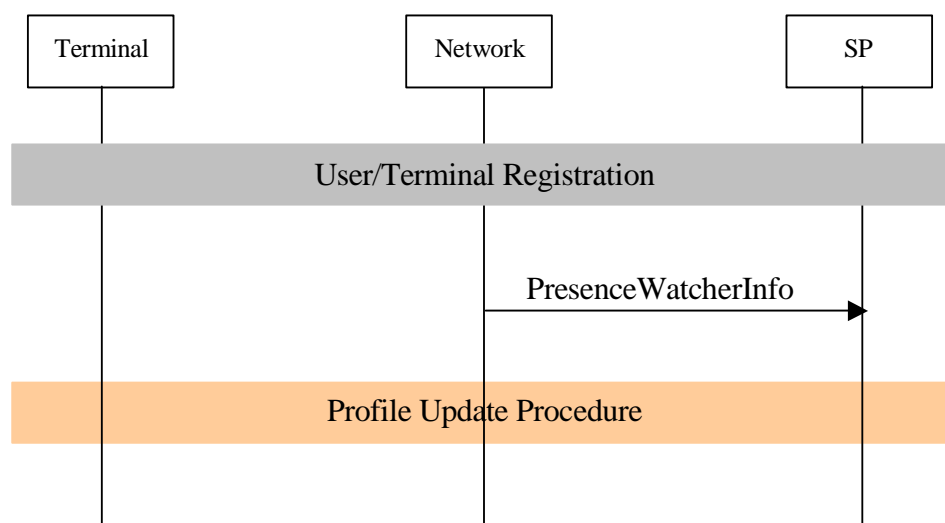

**Figure 9: Information flow to trigger the update of profile based on discovery/presence operation**

### 6.2.6 Terminal retrieval of profile from its user's service provider

The SP's service user needs the ability to retrieve, for storage in their terminal, their communication configuration held by their Service Provider.

#### 6.2.6.1 Priority

The priority of this requirement is high.

#### 6.2.6.2 Example of usage

An example of this requirement enables the SP's service user's terminal to retrieve data from his user's profile, stored by the SP, to produce a synchronized local copy of his telephone book.

#### 6.2.6.3 Technical aspects

The SP's service user is given an access to real-time profile data via the user's terminal. Access must be controlled by the necessary authority mechanisms to ensure security and confidentiality of user data.

### 6.2.6.4 Information flow chart

The following flow chart illustrates how a Service Provider's service user may request.

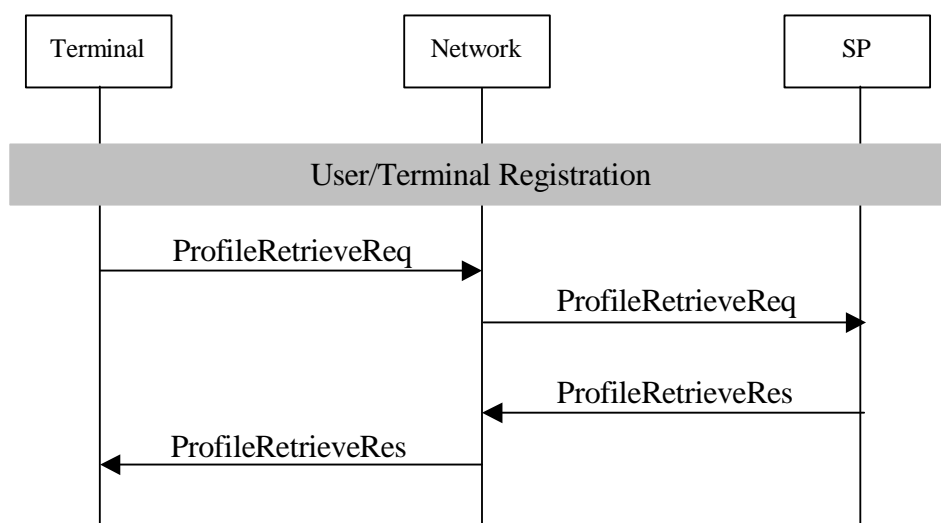

**Figure 10: Information flow for user retrieval of profile from their Service Provider**

## 6.2.7 Terminal modification of SP's service user's profile

Service Provider's service user's terminals need to be able to modify their communication configuration held by their Service Provider.

### 6.2.7.1 Priority

The priority of this requirement is high.

### 6.2.7.2 Example of usage

To enable the SP's service user to update his user Profile held by the SP (e.g. synchronize a time planner) or to modify the value of optional parameters.

### 6.2.7.3 Technical aspects

The SP's service user' is given an access to modify the real-time profile data via the user's terminal. Access must be controlled by the necessary authority mechanisms to ensure security and confidentiality of user data.

### 6.2.7.4 Information flow chart

The following flow chart illustrates how a Service Provider's service user's terminal may update the user profile held by the SP.

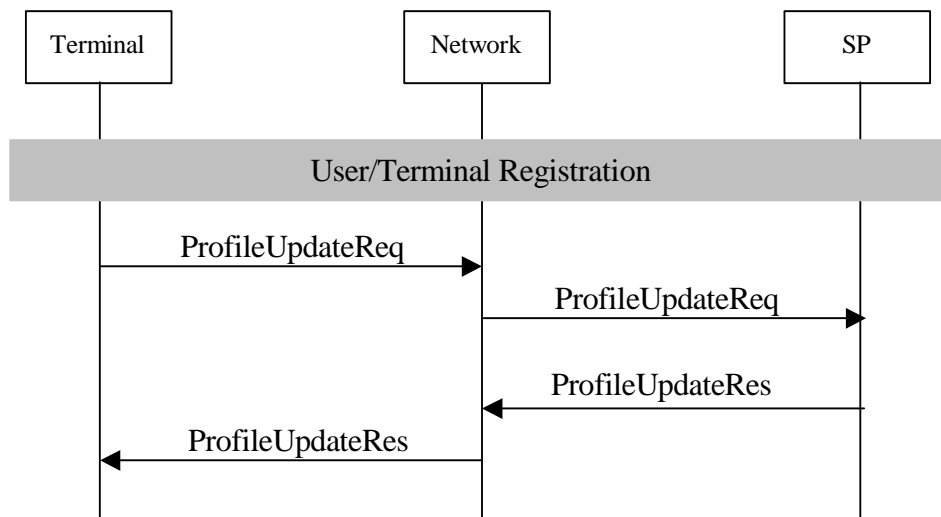

**Figure 11: Information flow for user update of profile held by their Service Provider**

## 6.3 Management of the profile of the SP's service subscriber

### 6.3.1 Alteration of the profile of the SP's service subscriber

The SP needs the ability to alter, through the SPAI, the carrier selection conditions or any other pre-selected routing conditions set up on the profile of the SP's service subscriber. This only applies to services subscribed to by the service subscriber from the particular SP.

#### 6.3.1.1 Priority

The priority of this requirement is high.

#### 6.3.1.2 Example of usage

The SP may want to change the criteria and routing data that are applied for routing a terminating call of its customer to a voice messaging service, although the voice messaging platform itself may be provided by another SP.

#### 6.3.1.3 Technical aspects

The SP requires the ability to make alterations of the pre-selected routing conditions of its subscriber without establishing a circuit-switched call. Note that the criteria and data for the re-routing of terminating calls is not assumed to be located in the terminal or personality device/module e.g. USIM of the SP's subscriber.

Any changed routing criteria remain active until they are overridden by a further authorized change.

There must be a means of informing other SPs about the particular SP that has control over the subscriber's service profile. To avoid misuse, it should be possible to mark a service profile as inaccessible, by merely providing a notification instead of the actual data.



### 6.3.1.4 Information flow chart

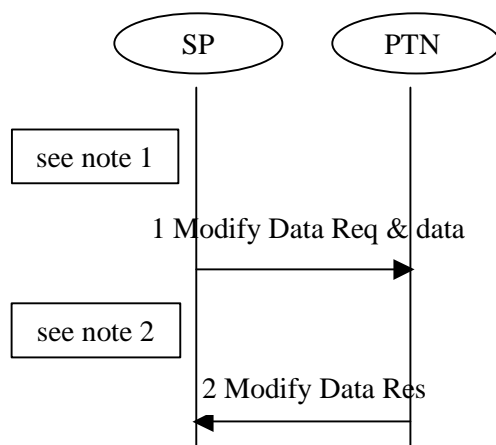

NOTE 1: SP sets up an NCR connection to a network management centre of the PTN.

NOTE 2: Network management centre of the PTN validates the SP's request, and issues instructions to alter the customer's service profile data in the related local exchange or in the subscriber database of the network.

1 SP issues instructions for a change to its service subscriber's 'service profile' data.

2 Network management centre sets up an NCR connection to the SP to return an acknowledgement.

**Figure 12: Alteration of the profile of the SP's service subscriber**

## 6.3.2 SP retrieval of profile from the PTN

Service Providers need to be able to retrieve their service user's communication configuration from the PTN.

### 6.3.2.1 Priority

The priority of this requirement is high.

### 6.3.2.2 Example of usage

This requirement enables the Service Provider to retrieve his service user's network configuration settings (e.g. user Profile) from the PTN. This could be used to reflect changes to the network version of the profile with the centrally stored version managed by the SP.

### 6.3.2.3 Technical aspects

The Service Provider is given an access to real-time profile data of his service user. Access must be controlled by the necessary authority mechanisms between the SP and the PTN to ensure security and confidentiality of user data.

### 6.3.2.4 Information flow chart

The following flow chart illustrates how a Service Provider's service user may request retrieval of profile from the PTN.

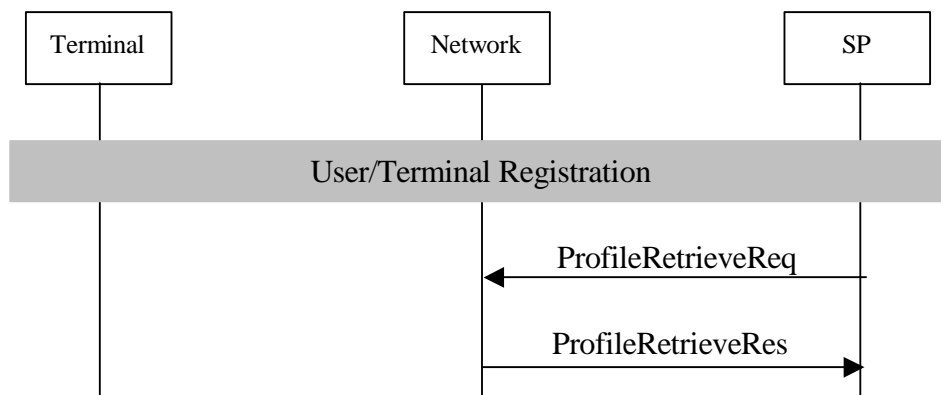

**Figure 13: Information flow for SP retrieval of profile from the PTN**

## 6.4 Event and call management

### 6.4.1 Indication of the disconnection of a call

The SP needs the indication of the disconnection of a call from the SP's service user.

#### 6.4.1.1 Priority

The priority of this requirement is high.

#### 6.4.1.2 Example of usage

In the case of several services, the SP needs the indication of a disconnection in order to release some service-related resources.

Another example is a need to close the charging data record for an ongoing service precisely at the time of the disconnection.

#### 6.4.1.3 Technical aspects

This requires the ability to relay a "disconnect" message to the SP when the call/session is disconnected or aborted by either party involved in the call/session. A time of release is provided, and a release cause may be provided.

#### 6.4.1.4 Information flow chart

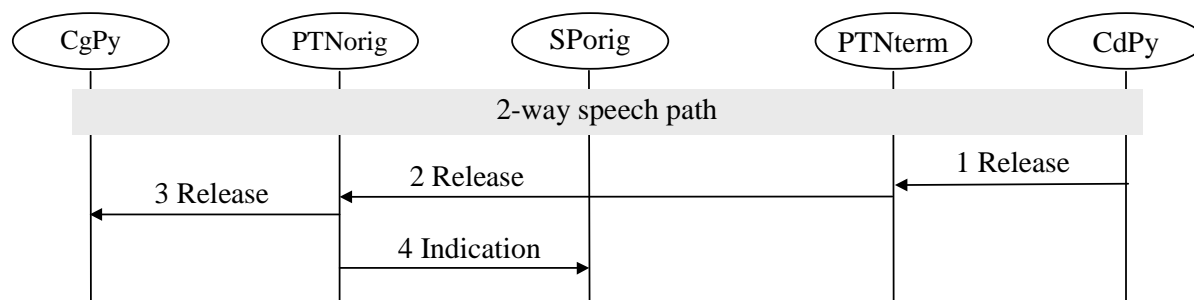

- 1 CdPy issues release request to the PTNterm to disconnect the call.
- 2 PTNterm extends this release request to the PTNorig.
- 3 PTNorig releases the CgPy.
- 4 PTNorig sends an indication of the disconnection of the call to the SP.

**Figure 14a: Scenario where SPorig is notified about the CdPy disconnecting the call**

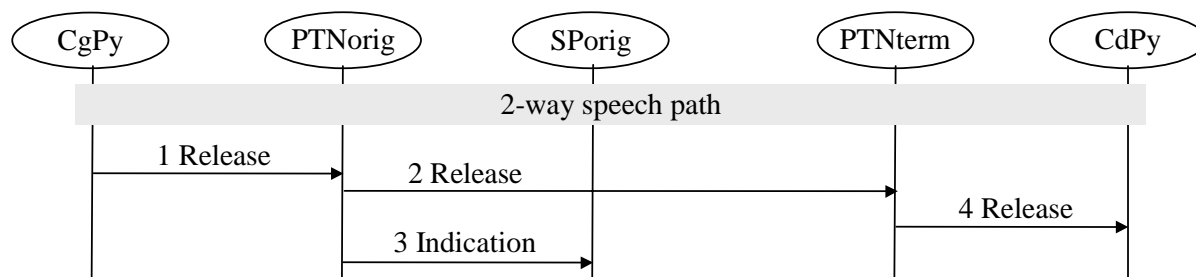

- 1 CgPy issues release request to the PTNorig to disconnect the call.
- 2 PTNorig extends this release request to the PTNterm.
- 3 PTNorig sends an indication of the disconnection of the call to the SP.
- 4 PTNterm releases the CdPy.

**Figure 14b: Scenario where SPorig is notified about the CgPy disconnecting the call**

### 6.4.2 Join operation of individual legs of a call

The SP needs the ability to request the PTNO to join specified individual legs to a call.

#### 6.4.2.1 Priority

The priority of this requirement is high.

#### 6.4.2.2 Example of usage

To provide a conference call service, the SP needs a capability to dynamically add call connection legs of individual participants to the configuration of the conference call.

Another example is a service, where an individual speaker or teacher who wants to establish a multicast call to all the end users who have registered themselves to the SP as students of the given lecture or course.

#### 6.4.2.3 Technical aspects

To achieve this call control service must have the possibility to handle and associate more than two legs in an already existing call.

#### 6.4.2.4 Information flow chart

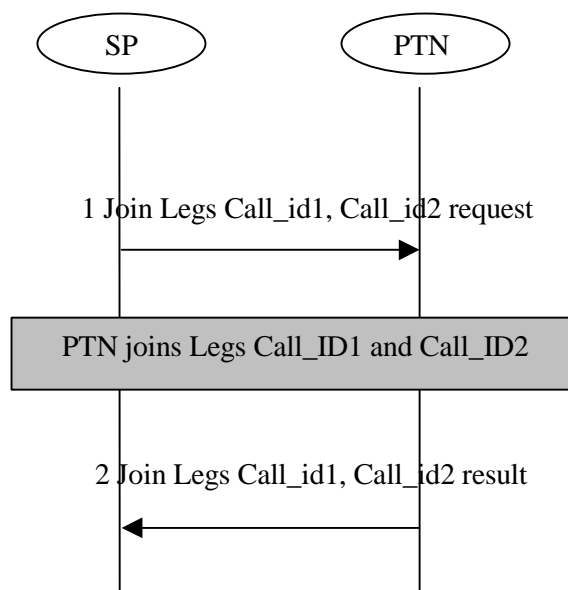

- 1 The SP sends a request to the PTNO to join legs with call references Call\_ID1 and Call\_ID2.
- 2 The PTN performs the join and sends a response to the SP confirming the joining of the legs with call references Call\_ID1 and Call\_ID2.

**Figure 15: Join operation of individual legs of a call**

### 6.4.3 Split operation of individual legs of a call

The SP needs the ability to request the PTNO to split specified individual legs of a call.

#### 6.4.3.1 Priority

The priority of this requirement is high.

#### 6.4.3.2 Example of usage

To provide the ability to manage a conference call service, the SP needs a capability to dynamically remove the call connection legs of individual participants during the conference.

#### 6.4.3.3 Technical aspects

To achieve this requirement, the call control service must have the possibility to handle and disassociate more than two legs from an already existing call.

#### 6.4.3.4 Information flow chart

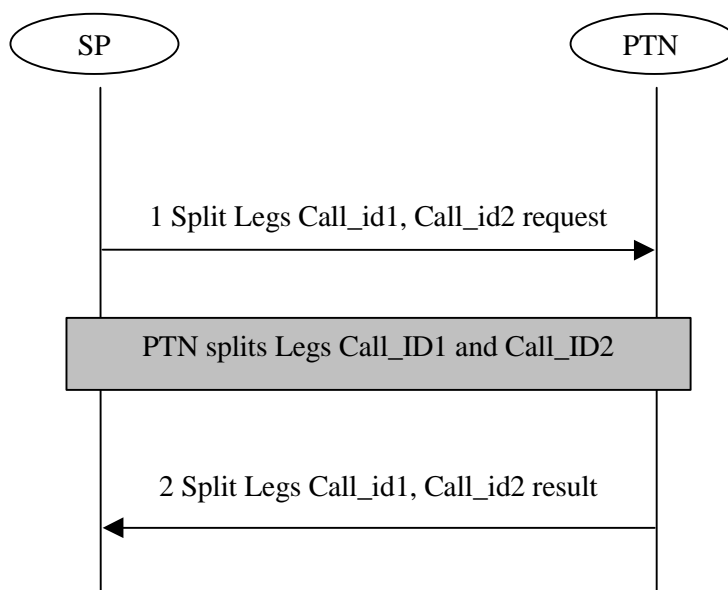

- 1 The SP sends a request to the PTNO to split legs with call references Call\_ID1 and Call\_ID2.
- 2 The PTN performs the split and sends a response to the SP confirming the splitting of the legs with call references Call\_ID1 and Call\_ID2.

**Figure 16: Split operation of individual legs of a call**

#### 6.4.4 Delivery of information to the SP's service user prior to alerting

The SP needs the ability to deliver information to the recipient of the call who is the SP's service user, prior to alerting.

##### 6.4.4.1 Priority

The priority of this requirement is medium.

##### 6.4.4.2 Example of usage

To avoid prompting the calling party more than once for the same information, the SP may prefer to send the called party all the relevant data that the SP has interactively received from the calling party. E.g. after the SP has prompted the calling party for an account code or personal identification number, the received data may also be needed by the called party, e.g. in the case of a bank computer.

In the case of a calling name service, the SP translates the received CLI into the name of the calling party, for sending this name to the called party prior to the alerting.

##### 6.4.4.3 Technical aspects

Alphanumeric information may have to be delivered to the called party, e.g. after the SP prompts the calling party and uses a speech recognition method, or after the SP provides other type of alphanumeric data. The related PTN needs to be able to relay the alphanumeric data to the called party. The information needs to be conveyed before the called party is alerted, if alerting is required. The call must be redirected toward the SP based on a precondition as described in EG 201 722 [3].

#### 6.4.4.4 Information flow chart

Message flows for the scenario where the SPterm translates the CLI of CgPy into a name and conveys that name to CdPy are presented.

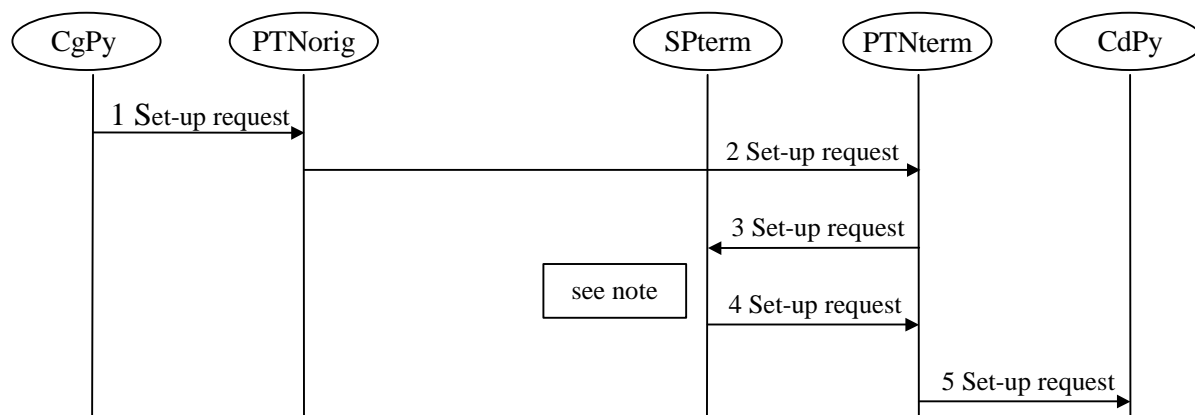

NOTE: The SP provides the name of the calling party who is a SP service user.

- 1 The CgPy initiates a set-up request in the originating PTN.
- 2 The originating PTN forwards the set-up request to the terminating PTN.
- 3 The terminating PTN forwards the set-up request to the terminating SP.
- 4 The terminating SP adds the CgPy name and forwards the set-up request to the terminating PTN.
- 5 The terminating PTN forwards the set-up request to the CdPy.

**Figure 17: Conveying alphanumeric information to the called party during the call set-up phase**

#### 6.4.5 Supervision of a dropped-back call

The SP needs the ability to retain the control of a dropped-back call.

##### 6.4.5.1 Priority

The priority of this requirement is medium.

##### 6.4.5.2 Example of usage

The supervision of a dropped-back call may be needed by the SP that provides terminating-call-related services to its customer in a mobile network, e.g. in the case of call forwarding.

##### 6.4.5.3 Technical aspects

A dropped-back call may fall into a network, which has no direct CR connection with the SP. Supervision of a dropped-back call may be impossible across a boundary of PTNs.

This involves drop back of the bearer connection whilst maintaining the associated signalling path connection between the PTN and the SP.

#### 6.4.5.4 Information flow chart

Information flows are presented for a scenario where the SPorig drops the bearer connection of a call back to PTNorig whilst maintaining the signalling connection. The corresponding scenario is similar, when the SPterm receives the setup request from the terminating PTN.

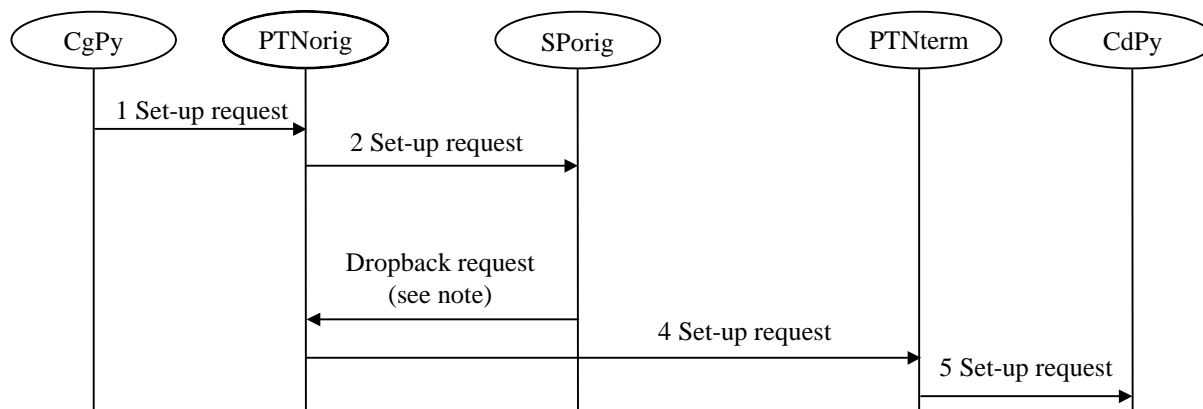

NOTE: Drop back of the bearer channel whilst keeping the signalling.

- 1 The CgPy initiates a set-up request in the originating PTN.
- 2 The originating PTN forwards the set-up request to the originating SP.
- 3 The originating SP sends a dropback set-up request to the originating PTN.
- 4 The originating PTN sends a set-up request to the terminating PTN.
- 5 The terminating PTN forwards the set-up request to the CdPy.

**Figure 18: Supervision of a call that is dropped back from the SPorig to the originating PTN**

#### 6.4.6 Avoidance of the cyclical routing of signalling or user messages

The SP needs the ability to detect and stop cyclical routing of signalling or user messages between the PTN and the SP's equipment.

##### 6.4.6.1 Priority

The priority of this requirement is high.

##### 6.4.6.2 Example of usage

During the interaction phases of any single call or session between an SP's equipment and a PTN's equipment, API messages, signalling messages or user messages have the potential to be invoked cyclically, incorporating for example multiple number translations, or error messages. In other situations, repeated message forwarding may cause undesirable cyclical routing of both the call and the signalling messages. This requirement should prevent these situations occurring.

##### 6.4.6.3 Technical aspects

To avoid undesirable cyclical routing, one alternative is that sufficient data is associated with the call (e.g. a 'hop' counter or correlation identities of the operations performed).

##### 6.4.6.4 Information flows

This clause is void since this is a protocol parameter matter.

## 6.4.7 Multimedia multiparty call control

The SP needs the ability set-up, control and terminate multimedia multiparty calls.

### 6.4.7.1 Priority

The priority of this requirement is high.

### 6.4.7.2 Example of usage

Multi-media conference calls are a special case of multi-media calls where multiparties are involved, with additional methods for control of the conference by its chairman and related video selection. The client application must be able to specify the behaviour in a conference. The policy can specify the behaviour per medium (e.g. voice, video, data). For example, for voice the policy can be to mix the streams while for video the policy can be voice-activated or chairman controlled video distribution. The application must be able to reserve resources in advance or to free previously reserved resources for a conference.

### 6.4.7.3 Technical aspects

The following list of operations is required to implement a multiparty multimedia conference service:

- Reserve conference resources - Request;
- Free conference resources - Request;
- Check conference resources - Request;
- Create Multi-media Conference - Request;
- Change conference policy - Request;
- Party join event notification - Request;
- Party join event notification - Indication;
- Party join monitor - Indication;
- Party leave monitor - Request;
- Party leave monitor - Indication;
- Chair Selection - Request;
- Chair Request - Indication;
- Floor Request - Indication;
- Appoint speaker - Request;
- Inspect Video (by Chair) - Request;
- Inspect Video Cancel - Request.



#### 6.4.7.4 Information flow chart

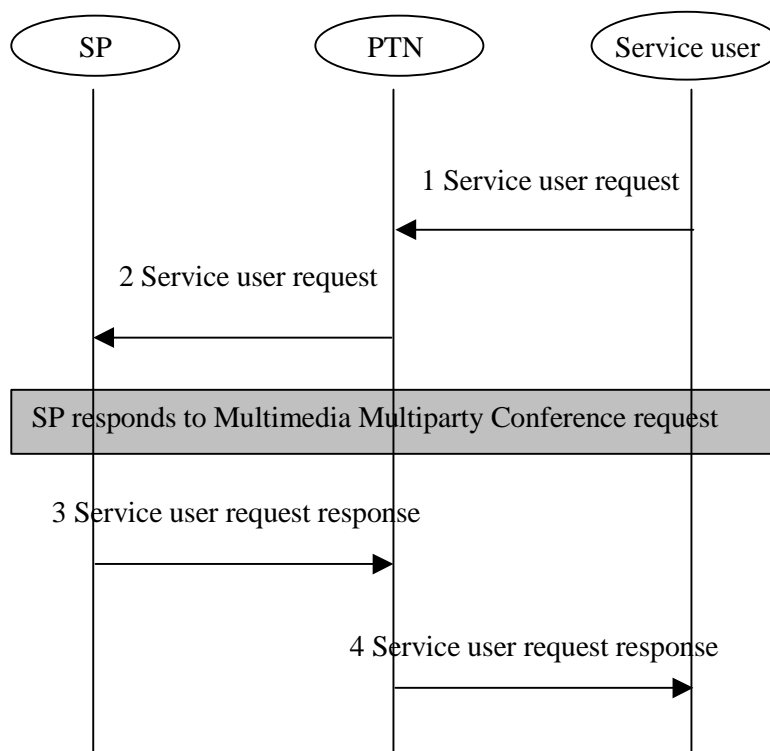

NOTE: A service user request may be any of the operations listed above.

- 1 The service user initiates a service user request to the PTN.
- 2 The PTN forwards the service user request to the SP.
- 3 The SP responds to the service user request and returns a service user request response to the PTN.
- 4 The PTN relays the service user request to the CdPy.

**Figure 19: Information flow chart for user request**

### 6.4.8 User Interaction for text delivery

The SP needs the ability to exchange text based information to and from an end user.

#### 6.4.8.1 Priority

The priority of this requirement is high.

#### 6.4.8.2 Example of usage

Where used, this Service allows the sending of application generated text to a terminal.

#### 6.4.8.3 Technical aspects

The generation of a text-to-terminal-request could result in the sending of SMS or USSD messages.

#### 6.4.8.4 Information flow chart

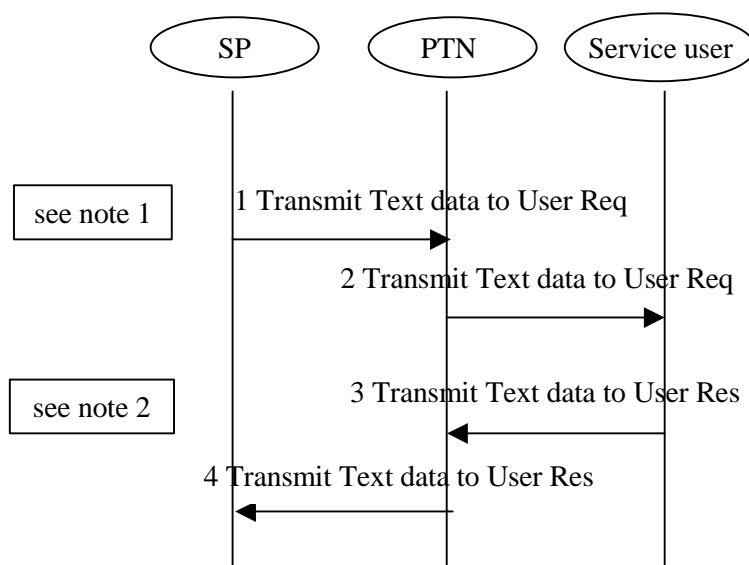

NOTE 1: The application has generated text for transmission to the user/terminal and the SP requests the PTN to transfer this data.

NOTE 2: The user/terminal acknowledges to the SP via the PTN of the correct receipt of the data.

- 1 The SP initiates a transmit text data to user request to the PTN.
- 2 The PTN forwards the transmit text data to user request to the service user.
- 3 The service user responds to the transmit text data to user request back to the PTN.
- 4 The PTN relays the transmit text data to user response to the SP.

**Figure 20: Information flow chart for text delivery**

#### 6.4.9 User-Plane resource negotiation and selection

The SP needs the ability to negotiate and select user-Plane resources for calls or sessions.

##### 6.4.9.1 Priority

The priority of this requirement is high.

##### 6.4.9.2 Example of usage

Examples of requests from the SP to the PTN may include "Set up a call leg from point A to point B using the following parameters for the user-plane".

##### 6.4.9.3 Technical aspects

The SP needs to be able to request and reserve user-Plane resources based on the following parameters:

- transport type e.g. 64 kbit/s circuit-switched, packet, ATM SVC;
- bandwidth;
- error ratio;
- throughput delay.

These user-plane parameters ensure that the SP delivers services to its service user in accordance with its contracted Quality of Service.

#### 6.4.9.4 Information flow chart

Information flows are presented.

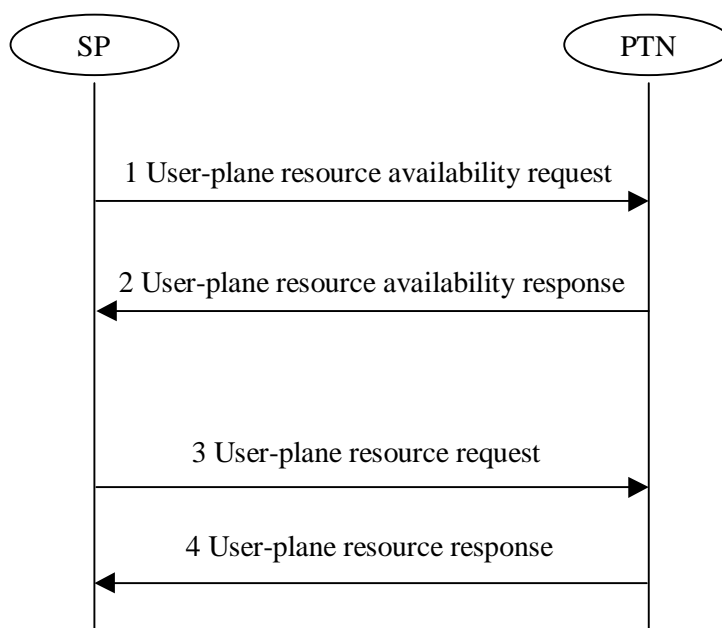

- 1 The SP requests availability of specific user-plane resource request needed for the call/session.
- 2 The PTN responds with information on available resources in response to the SP's request.
- 3 The SP requests the reservation of specific user-plane resources needed for the set-up of a call/session.
- 4 The PTN allocates appropriate resources and responds to the SP's request.

**Figure 21: user-Plane resource negotiation and selection**

#### 6.4.10 User request for confidential communication

Service Provider's service users need to be able to request when to start and stop the making of subsequent communications confidential, e.g. ciphering, to some or all of their communications.

##### 6.4.10.1 Priority

The priority of this requirement is high.

##### 6.4.10.2 Example of usage

To enable the SP's service user to request to start or stop ciphering. For UCI communication, the user profile is retained by the PUA.

##### 6.4.10.3 Technical aspects

The SP's service user is given an access to request to start or stop ciphering of transmitted data. Access must be controlled by the necessary authority mechanisms to ensure security and confidentiality of user data.

#### 6.4.10.4 Information flow chart

Figure 22 illustrates how a Service Provider's service user may request the start of ciphering.

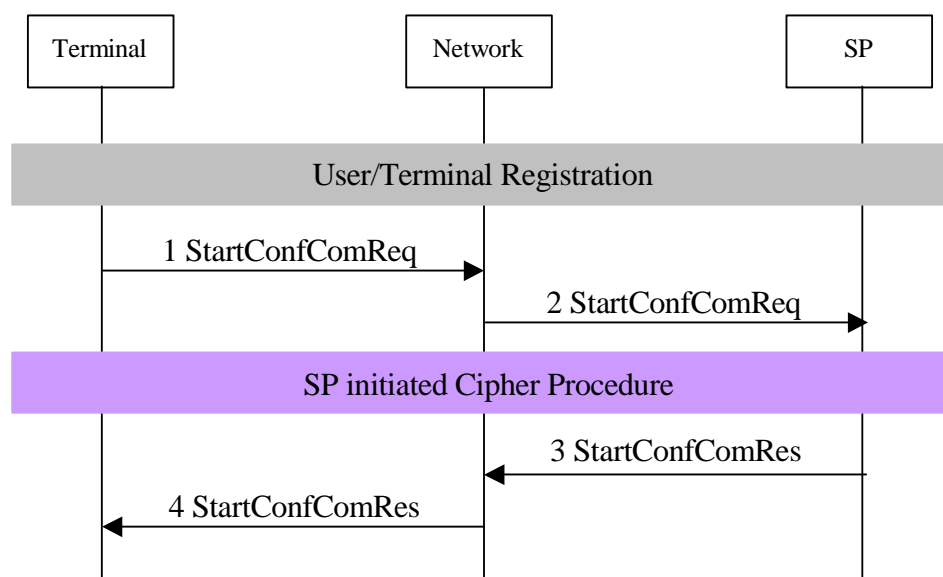

- 1 The terminal requests the start of confidential communication from the network.
- 2 The network relays the request for the start of confidential communication to the SP.
- 3 The SP initiates the start of confidential communication and sends an acknowledgement to the network.
- 4 The PTN relays this acknowledgement to the terminal that originated the request.

**Figure 22: Information flow for user request the start of ciphering**

#### 6.4.11 Service Provider request for confidential communication

Service Providers need to be able to request when to start and stop the making of subsequent communications confidential, e.g. ciphering, to some or all of their service user's communications.

##### 6.4.11.1 Priority

The priority of this requirement is high.

##### 6.4.11.2 Example of usage

To enable the Service provider to request the start confidential communications e.g. ciphering.

##### 6.4.11.3 Technical aspects

The Service Provider requests the start of confidential communications of user data exchanged with the user's terminal. Access must be controlled by the necessary authority mechanisms to ensure security and confidentiality of user data.

#### 6.4.11.4 Information flow chart

Figure 23 illustrates how a Service Provider may request requesting the start confidential communications.

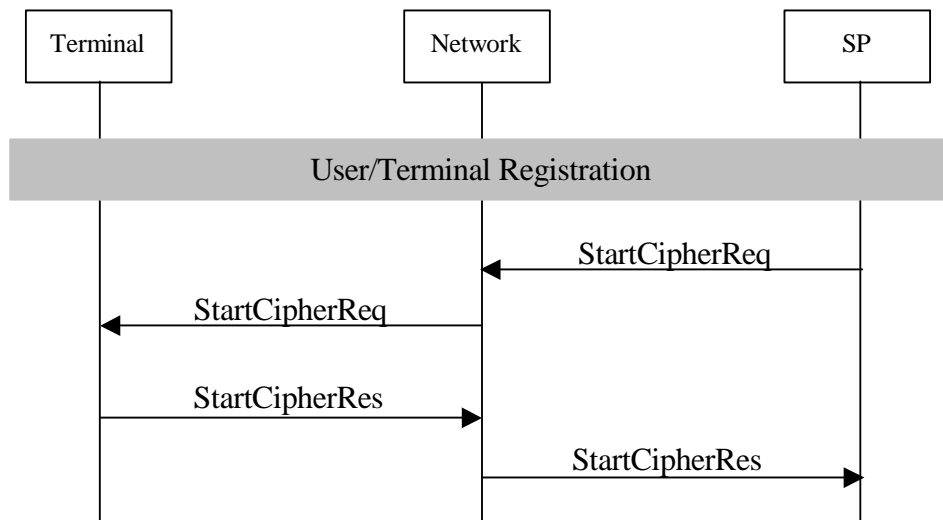

**Figure 23: Information flow for SP requesting the start confidential communications**

#### 6.4.12 PTN request for confidential communication

PTNs need to be able to request when to start and stop the making of subsequent communications confidential, e.g. ciphering, to some or all of, the service user's communications

##### 6.4.12.1 Priority

The priority of this requirement is high.

##### 6.4.12.2 Example of usage

To enable the PTN, acting on the Service Provider's behalf, to retrieve ciphering parameters and to request the terminal to start ciphering.

##### 6.4.12.3 Technical aspects

The PTN is given an access to request the ciphering of real-time data exchanges with the user's terminal. Access must be controlled by the necessary authority mechanisms to ensure security and confidentiality of user data.

#### 6.4.12.4 Information flow chart

Figure 24 illustrates how a Service Provider's service user may update the user profile.

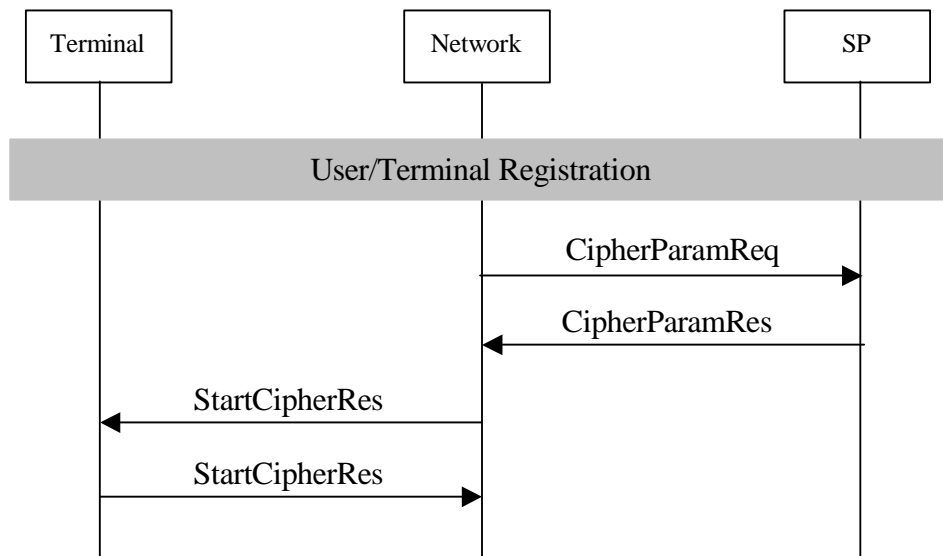

**Figure 24: Information flow for network initiated confidential communication mode**

Figure 25 illustrates how a Service Provider's service user may update the user profile.

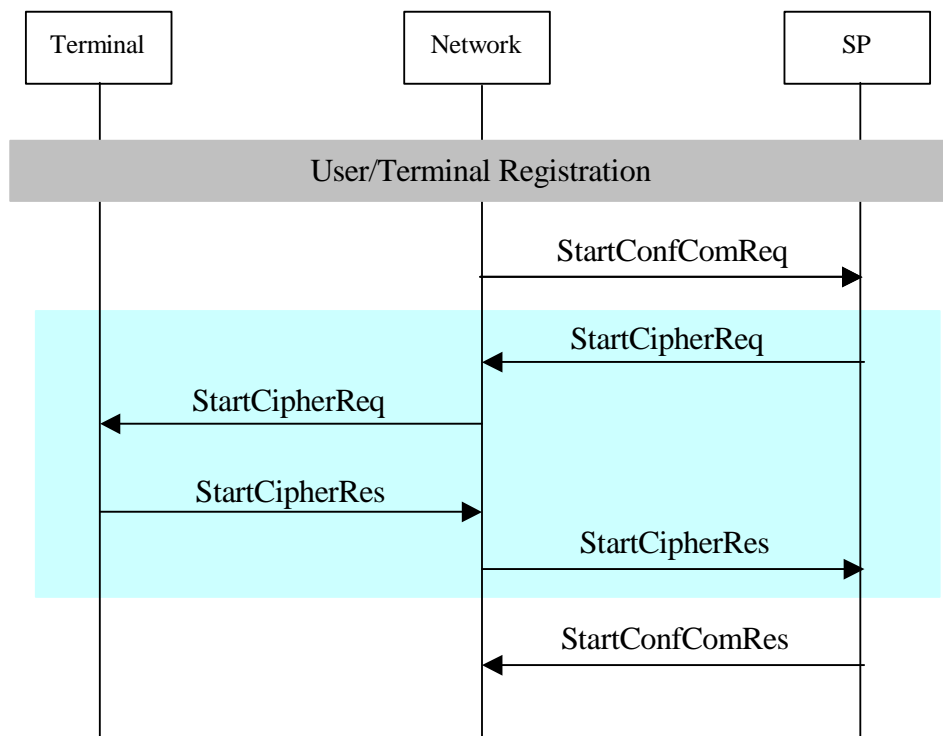

**Figure 25: Information flow for user update of profile held by their Service Provider**

## 6.4.13 Communication priority

Service Provider's service users need to be able to assign a priority to their communication e.g. urgent, non-urgent).

### 6.4.13.1 Priority

The priority of this requirement is high.

### 6.4.13.2 Example of usage

To enable the SP's service user to assign a priority to their communication as described by ITU-T Recommendation E.106 [18].

### 6.4.13.3 Technical aspects

The SP's service user is able to assign a priority to their communication, pass the priority in an appropriate parameter. Access must be controlled by the necessary authority mechanisms to ensure security and confidentiality of user data.

## 6.5 Network management events

### 6.5.1 Reporting of network events for measuring the Quality of Service

The SP needs the ability to receive notifications of specific network events that are in the concern of the SP's service users, e.g. alarms and Quality of Service degradation indicators, in order to gather statistics of the Quality of Service.

#### 6.5.1.1 Priority

The priority of this requirement is medium.

#### 6.5.1.2 Example of usage

If the service provider is involved in the routing of calls to different destinations, it is important that the SP obtains overall statistically collated information of the percentage of successful call connections.

#### 6.5.1.3 Technical aspects

The reason for unsuccessfully routed calls may be, for instance, congestion in a network, resulting in limited availability of resources to ensure the required Quality of Service.

Since this is not a real-time requirement, statistics may be downloaded in batches at pre-arranged intervals, or on-demand.

### 6.5.1.4 Information flow chart

Figure 26 illustrates how statistics of network events for measuring the Quality of Service may be requested by the SP and delivered by the PNO.

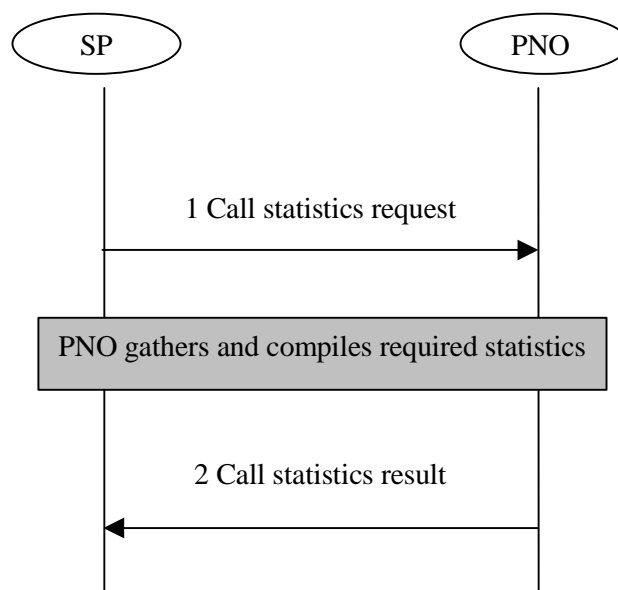

NOTE: This flow is not required for batch delivery of statistical data.

**Figure 26: Flow chart to obtain statistics of network events for measuring the Quality of Service**

## 6.5.2 Reporting of network events for the purpose of fault diagnostics

The SP needs the ability to receive notifications of specific network events for the purpose of fault diagnostics.

### 6.5.2.1 Priority

The priority of this requirement is high.

### 6.5.2.2 Example of usage

If the service provider is involved in the routing of calls to different destinations, it is important that the SP is able to monitor specific events, e.g. the occurrence of unsuccessful calls that are either originated by a specific user terminal or routed to a specific destination.

### 6.5.2.3 Technical aspects

Real-time, or near real-time, reporting is required for each reportable network event, but filtering is essential to prevent multiple reporting of alarms, etc., caused by a single network event. This filtering must be configurable.



### 6.5.2.4 Information flow chart

Figure 27 illustrates how network events for the purpose of fault reporting may be requested by the SP and delivered by the PNO.

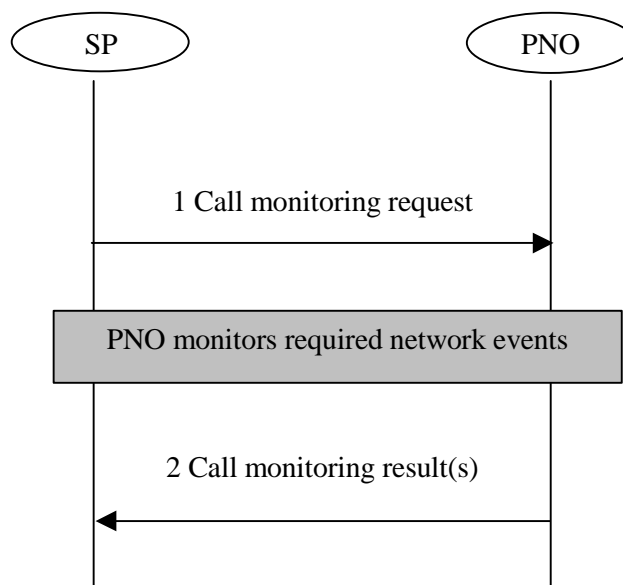

NOTE: Flow 1 is a management activity related to the configuration of the events reported.

**Figure 27: Flow chart to obtain network event data for fault diagnostics**

## 6.5.3 Request for event monitoring and subsequent reporting

The SP needs the ability, within its contractual arrangement, to request for the monitoring of particular events in the PTN and the related reporting of such events by the PTN to the SP.

### 6.5.3.1 Priority

The priority of this requirement is high.

### 6.5.3.2 Example of usage

The SP needs to have the ability to request the PTN to set in real time appropriate triggers. When monitored events occur, the PTN will inform the SP in real time of the occurrence.

### 6.5.3.3 Technical aspects

This requirement requires the ability of the PTN to configure/register the required events in response to the request.

The range of events to be monitored includes:

- CAMEL triggers [16];
- IN service triggers e.g. INAP CS2 [7];
- Open Service Access (OSA) APIs.

### 6.5.3.4 Information flow chart

Information flows are presented in figure 28.

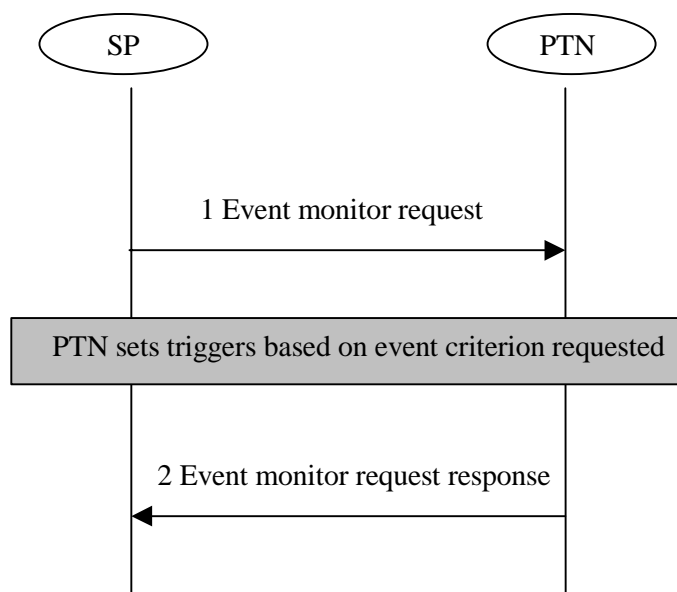

**Figure 28: Request for event monitoring and subsequent reporting**

## 6.5.4 Electronic ordering of network management functions

The SP needs to be offered by the PTN a suitably secure and open interface to order electronically all of the related management functions.

### 6.5.4.1 Priority

The priority of this requirement is medium.

### 6.5.4.2 Example of usage

The SP needs to be able to request electronically event monitoring and subsequent reporting for the purposes of fault diagnostics and Quality of Service monitoring.

### 6.5.4.3 Technical aspects

The technical characteristics of the interface between the SP and the PTN for electronic ordering needs to support secure real-time data transfers.

#### 6.5.4.4 Information flow chart

Information flows are presented in figure 29.

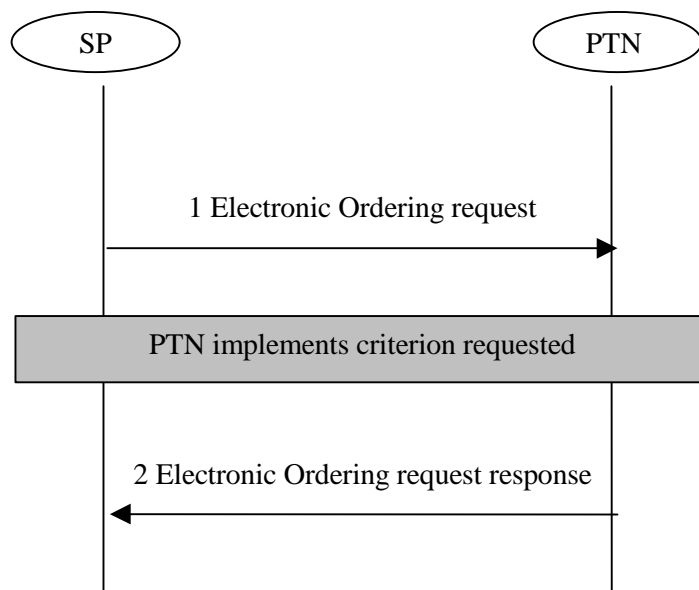

**Figure 29: Electronic ordering of network management functions**

#### 6.5.5 SP request for Authentication

The Service Provider needs to be able to request when authentication is applicable (e.g. user, terminal or service).

##### 6.5.5.1 Priority

The priority of this requirement is high.

##### 6.5.5.2 Example of usage

To enable the Service Provider to request authentication of his service user.

##### 6.5.5.3 Technical aspects

The Service Provider is given an access to request authentication of his service user. Access must be controlled by the necessary authority mechanisms to ensure security and confidentiality of user data.

#### 6.5.5.4 Information flow chart

The following flow chart illustrates how a Service Provider may request authentication.

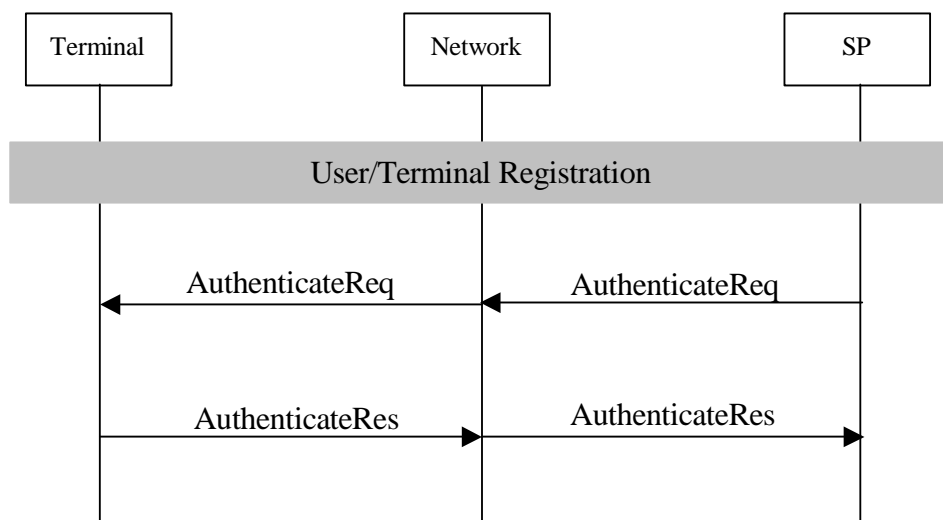

**Figure 30: Information flow for Service Provider request for user authentication**

#### 6.5.6 PTN request for SP's service user authentication

The PTN needs to be able to request for authentication of the SP's service user.

##### 6.5.6.1 Priority

The priority of this requirement is high.

##### 6.5.6.2 Example of usage

To enable the PTN to request the SP for authentication of the SP's service user.

##### 6.5.6.3 Technical aspects

The PTN requests the Service Provider to authenticate his service user. Access must be controlled by the necessary authority mechanisms to ensure security and confidentiality of user data.

### 6.5.6.4 Information flow chart

Figure 31 illustrates how a PTN may request authentication.

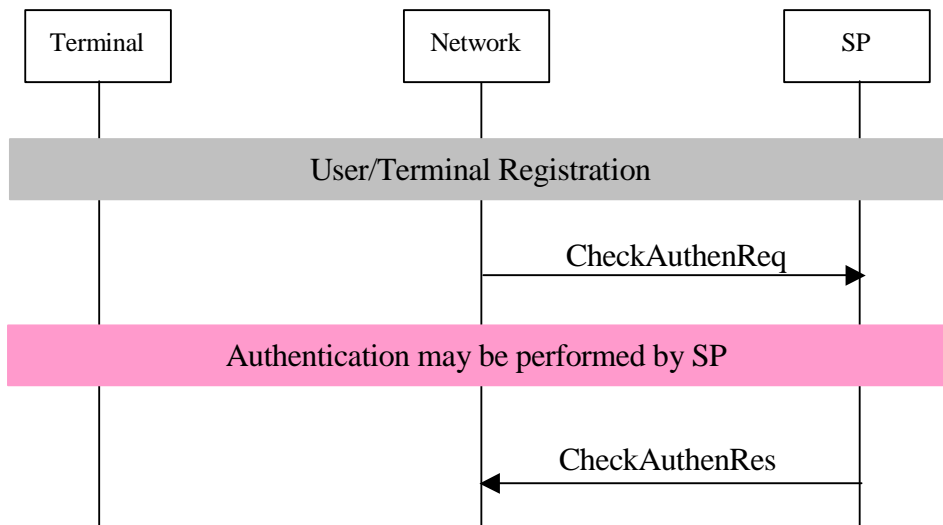

**Figure 31: Information flow for the PTN request for authentication of the SP served user**

Figure 32 illustrates how a network may request and perform authentication.

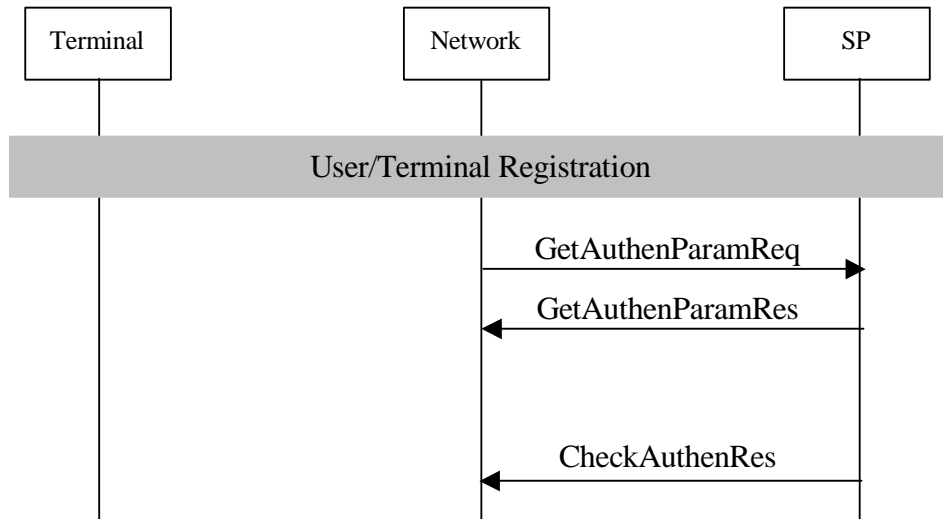

**Figure 32: Information flow for the PTN request for authentication of the SP served user**

## 6.5.7 Terminal Authentication performed by the PTN

The PTN needs to be able to perform terminal authentication.

### 6.5.7.1 Priority

The priority of this requirement is high.

### 6.5.7.2 Example of usage

To enable the PTN to perform authentication of the SP's service user's terminal.

### 6.5.7.3 Technical aspects

The PTN needs to check authentication of attached SP service user's terminal. Access must be controlled by the necessary authority mechanisms to ensure security and confidentiality of user data.

### 6.5.7.4 Information flow chart

Figure 33 illustrates how a PTN may perform terminal authentication.

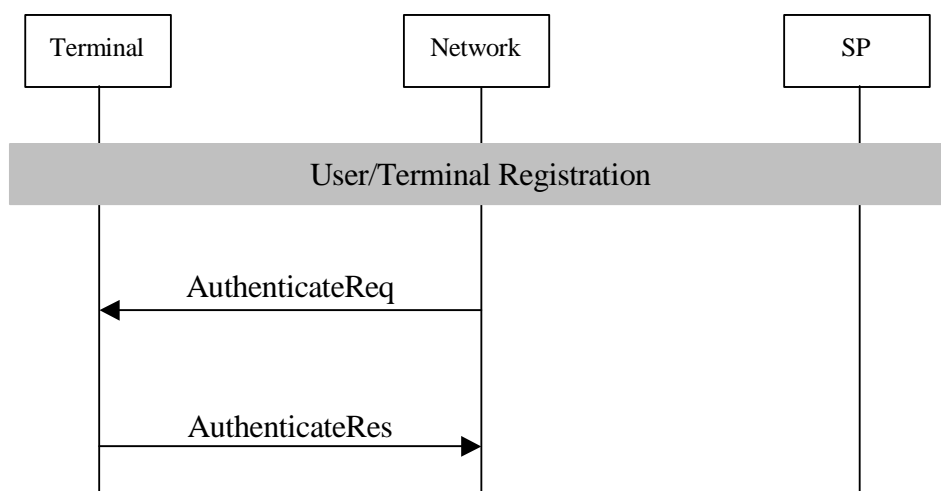

**Figure 33: Information flow for the PTN performing terminal authentication**

## 6.6 Provision of call charging information

### 6.6.1 Provision of call charging information in real time

The SP needs the ability to request and receive notifications of the initial and accumulated charging of an originating or terminating call involving the SP's service user.

#### 6.6.1.1 Priority

The priority of this requirement is high.

#### 6.6.1.2 Example of usage

Information on charging by the PTNO is sent to the SP at call set-up or on completion of the call.

#### 6.6.1.3 Technical aspect

The charging information is to be used for accruing charges to the service subscriber of the SP. Real-time handling of charging notifications may cause significant load on the signalling network and the SP's equipment, if a large number of charging reports are requested per call.

#### 6.6.1.4 Information flow chart

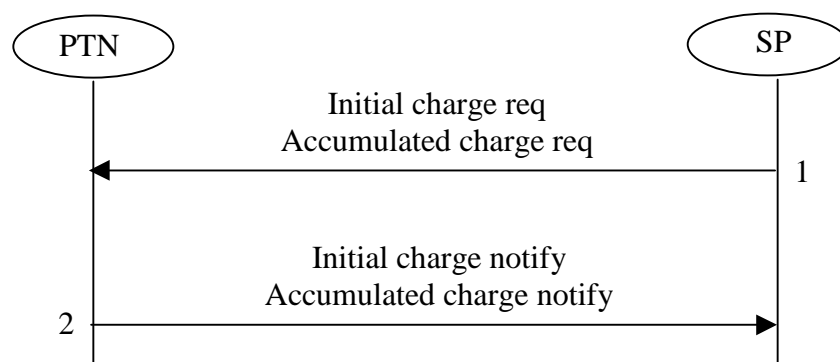

- 1 The SP requests notification of the initial and accumulated charge applicable to an originating or terminating call/session involving the SP's service user.
- 2 The PNO provides notifications of the initial and accumulated charge applicable to an originating or terminating call/session involving the SP's service user.

**Figure 34: Provision of call charging information in real time**

### 6.6.2 Exchange of charge detail record information in real time

The SP needs the ability to exchange with the PTN charge detail records at the end of a call and at configured intermediate stages of a call/session e.g. for long calls, involving the SP's service user.

#### 6.6.2.1 Priority

The priority of this requirement is high.

#### 6.6.2.2 Example of usage

A pre-paid service requires real-time monitoring of the accumulated charges incurred on a call.

#### 6.6.2.3 Technical aspect

The charging information is to be used for accruing charges to the service subscriber of the SP. Real-time handling of charging notifications may cause significant load on the signalling network and the SP's equipment, if a large number of charging reports are requested per call.

### 6.6.2.4 Information flow chart

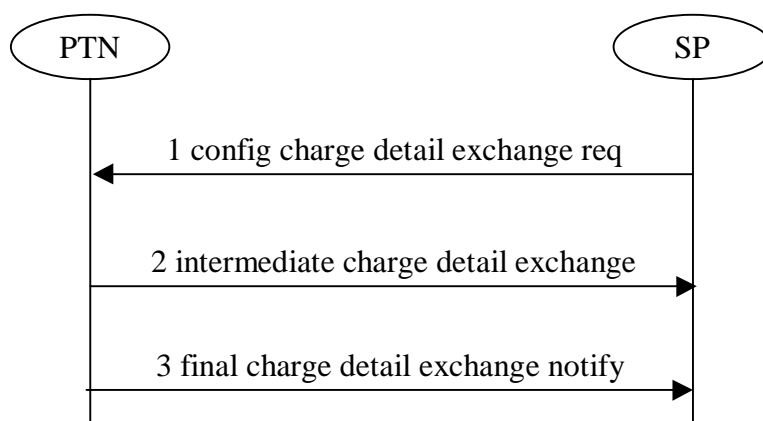

- 1 The SP requests the configuration of times (e.g. initial interval, intermediate interval) when the PNO will provide notifications of intermediate and final charge(s) applicable to originating or terminating call/sessions involving the SP's service user(s).
- 2 The PNO provides, in real time, notifications of the intermediate charge(s) applicable to an originating or terminating call/session involving the SP's service user.
- 3 The PNO provides notification of the final charge applicable to an originating or terminating call/session involving the SP's service user.

**Figure 35: Exchange of call detail record information in real time**

## 6.7 Service presence, discovery and binding

### 6.7.1 Context request to Service Provider with specified service capabilities from the service user and SP

Terminals need to be able to request the Service Provider for a context with specified service capabilities to be set-up in the PTN.

#### 6.7.1.1 Priority

The priority of this requirement is high.

#### 6.7.1.2 Example of usage

To enable the user/Terminal to invoke applications e.g. voice or data calls, supported by the PTN.

#### 6.7.1.3 Technical aspects

The user's terminal requests the Service Provider for a context with specified service capabilities to be set-up in the PTN. Access must be controlled by the necessary authority mechanisms between the SP and the PTN to ensure security and confidentiality of user data.



### 6.7.1.4 Information flow chart

Figure 36 illustrates how a terminal may request the Service Provider for a context with specified service capabilities to be set-up in the PTN.

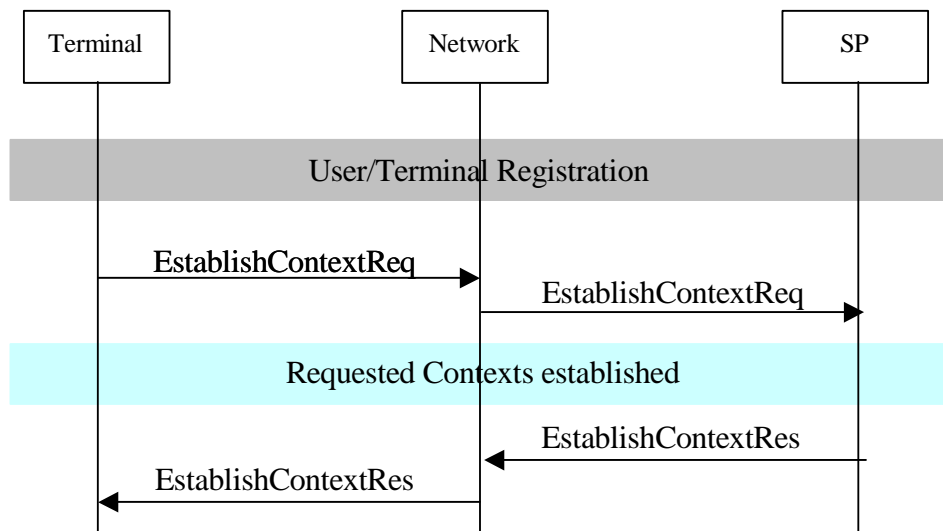

**Figure 36: Information flow for Service Provider request the discovery operation**

## 6.7.2 Discovery of PTN service capabilities by SP

Service Providers need to be able to request the discovery operation during their service user's service registration in the PTN.

### 6.7.2.1 Priority

The priority of this requirement is high.

### 6.7.2.2 Example of usage

To enable the SP to retrieve information on service capabilities offered by the PTN.

### 6.7.2.3 Technical aspects

The Service Provider requests the discovery operation for their service user's registered in the PTN. Access must be controlled by the necessary authority mechanisms between the SP and the PTN to ensure security and confidentiality of user data.

### 6.7.2.4 Information flow chart

Figure 38 illustrates how a Service Provider may request the discovery operation.

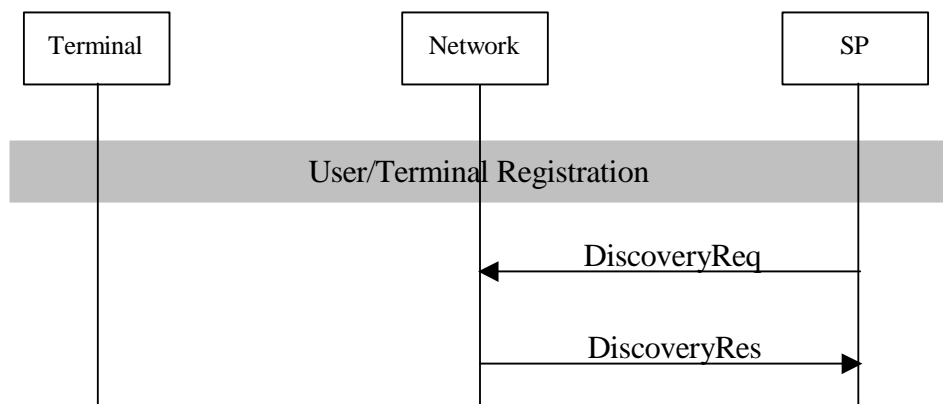

**Figure 37: Information flow for Service Provider request the discovery operation**

### 6.7.3 Binding to PTN with specified service capabilities between the service user and SP

Service Provider's service users need to be able to retrieve their service bindings.

#### 6.7.3.1 Priority

The priority of this requirement is high.

#### 6.7.3.2 Example of usage

To enable the SP's service user to request information on his current service bindings such as PDP contexts in GPRS.

#### 6.7.3.3 Technical aspects

The SP's service user is given an access to request information on his current service bindings. Access must be controlled by the necessary authority mechanisms, e.g. certificates, to ensure security and confidentiality of user data.

### 6.7.3.4 Information flow chart

Figure 38 illustrates how a Service Provider's service user may request information on his service bindings.

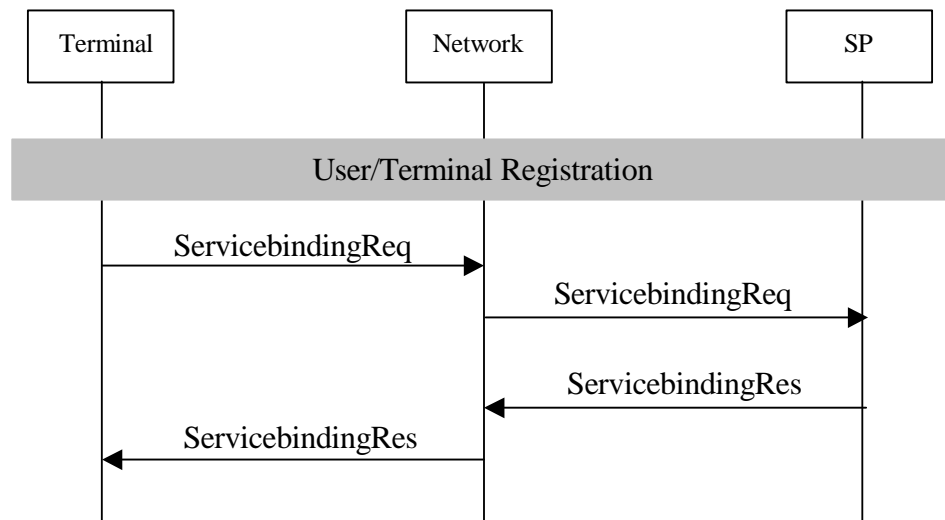

**Figure 38: Information flow for user request of information on his service bindings**

### 6.7.4 SP request for presence and availability on a PTN with specified service capabilities

Service Providers need to be able to request the presence and availability operation for their service user's registered in the PTN.

#### 6.7.4.1 Priority

The priority of this requirement is high.

#### 6.7.4.2 Example of usage

To enable the SP to request the presence operation for their service user's registered in the PTN.

#### 6.7.4.3 Technical aspects

The Service Provider requests the presence operation for their service user's registered in the PTN. Access must be controlled by the necessary authority mechanisms between the SP and the PTN to ensure security and confidentiality of user data.

#### 6.7.4.4 Information flow chart

Figure 39 illustrates how a Service Provider may request the presence operation.

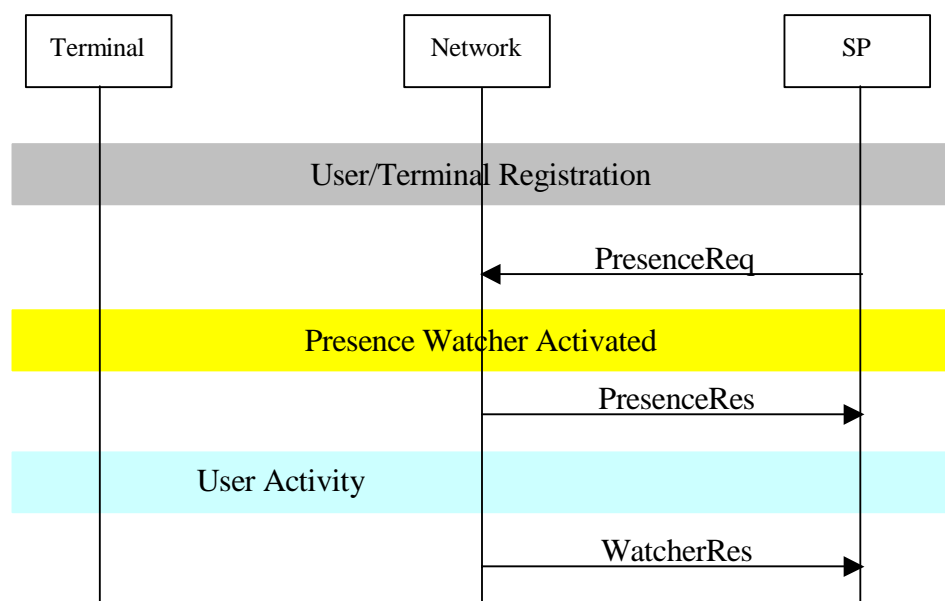

**Figure 39: Information flow for Service Provider request the presence operation**

---

## 7 Architectural view of the Service Provider Access

Potential SPAR architectures from the viewpoint of both the PTNO and SP are under study in EG 201 916 [12]. It is proposed that a technology independent approach should be adopted to avoid linking the SPA implicitly to any specific network architecture. All of these SPA architectures must support the SPA requirements.

---

## Annex A (informative): Bibliography

- ETSI ETR 322: "Intelligent Network (IN); Vocabulary of terms and abbreviations for CS-1 and CS-2".
- ECTRA/REC(98)01: "Set of Guidelines on Responsibilities for ensuring maintenance of Network Integrity (NI) in an interconnected environment".

---

## History

<b>Document history</b>		
V1.1.1	May 2001	Publication
V1.2.1	March 2002	Membership Approval Procedure    MV 20020524: 2002-03-26 to 2002-05-24